

---

**User's  
Manual**

**UT100 Series  
Communication Functions**



**Models UT130, UT150/UT152/UT155  
Temperature Controllers  
Model UP150  
Program Temperature Controller**

IM 05C01E12-10E



# Introduction

---

This user's manual describes the communication functions of the UT100 Series controller and contains information on how to create communication programs.

Read the manual carefully to understand the communication functions of the UT100 Series.

**The UT100 Series controller has the following communication protocols.**

- 1) PC link communication protocol
- 2) Ladder communication protocol
- 3) MODBUS communication protocol

Note that the UT100 Series controller cannot communicate with a host device with a communication protocol other than these.

## ■ Intended Readers

This manual is intended for people familiar with the functions of the UT100 Series Controller and control engineers and personnel in charge of maintaining instrumentation and control equipment.

You are required to understand as a background knowledge the communication specifications of host devices, in regard to their communication hardware, language used for creating communication programs, and so on.

## ■ Related Documents

The following user's manuals all relate to the communication functions.

Read them as necessary. The codes enclosed in parentheses are the document numbers.

- *Model UT130 Temperature Controller* (IM 05C01E02-01E)  
Explains the basic operation of the UT130 controller.  
Supplied with the UT130 Temperature Controller.
- *Models UT150, UT152, UT155 Temperature Controller* (IM 05C01E12-01E)  
Explains the basic operation of the UT150/UT152/UT155 controller.  
Supplied with the UT150/UT152/UT155 Temperature Controller.
- *Model UP150 Program Temperature Controller* (IM 05C01F12-01E)  
Explains the basic operation of the UP150 Program Temperature controller.  
Supplied with the UP150 Program Temperature Controller.

# Documentation Conventions

---

## ■ Symbols

The following symbols are used in this manual.

### ● Symbols Used in the Main Text



### **NOTE**

Draws attention to information that is essential for understanding the operation and/or features of the product.



### **See Also**

Gives reference locations for further information on the topic.

## ■ Description of Displays

- (1) Some of the representations of product displays shown in this manual may be exaggerated, simplified, or partially omitted for reasons of convenience when explaining them.
- (2) Figures and illustrations representing the controller's displays may differ from the real displays in regard to the position and/or indicated characters (upper-case or lower-case, for example), to the extent that they do not impair a correct understanding of the functions and the proper operation and monitoring of the system.

# Notices

---

## ■ Regarding This User' Manual

- (1) This manual should be passed on to the end user. Keep at least one extra copy of the manual in a safe place.
- (2) Read this manual carefully to gain a thorough understanding of how to operate this product before you start using it.
- (3) This manual is intended to describe the functions of this product. Yokogawa Electric Corporation (hereinafter simply referred to as Yokogawa) does not guarantee that these functions are suited to the particular purpose of the user.
- (4) Under absolutely no circumstance may the contents of this manual, in part or in whole, be transcribed or copied without permission.
- (5) The contents of this manual are subject to change without prior notice.
- (6) Every effort has been made to ensure accuracy in the preparation of this manual. Should any errors or omissions come to your attention however, please contact your nearest Yokogawa representative or our sales office.

## ■ Regarding Protection, Safety, and Prohibition Against Unauthorized Modification

- (1) In order to protect the product and the system controlled by it against damage and ensure its safe use, make certain that all of the instructions and precautions relating to safety contained in this document are strictly adhered to. Yokogawa does not guarantee safety if products are not handled according to these instructions.
- (2) The following safety symbols are used on the product and/or in this manual.

### ● Symbols Used on the Product and in This Manual



#### **CAUTION**

This symbol on the product indicates that the operator must refer to an explanation in the user's manual in order to avoid the risk of injury or death of personnel or damage to the instrument. The manual describes how the operator should exercise special care to avoid electrical shock or other dangers that may result in injury or loss of life.



#### Protective Grounding Terminal

This symbol indicates that the terminal must be connected to ground prior to operating the equipment.



#### Functional Grounding Terminal

This symbol indicates that the terminal must be connected to ground prior to operating the equipment.

## ■ Force Majeure

- (1) Yokogawa does not make any warranties regarding the product except those mentioned in the WARRANTY that is provided separately.
- (2) Yokogawa assumes no liability to any party for any loss or damage, direct or indirect, caused by the use or any unpredictable defect of the product.
- (3) Be sure to use the spare parts approved by Yokogawa when replacing parts or consumables.
- (4) Modification of the product is strictly prohibited.
- (5) Use this software with one specified computer only. You must purchase another copy of the software for use on each additional computer.
- (6) Copying this software for purposes other than backup is strictly prohibited.
- (7) Store the floppy disk(s) (original medium or media) containing this software in a secure place.
- (8) Reverse engineering such as the disassembly or decompilation of software is strictly prohibited.
- (9) No portion of the software supplied by Yokogawa may be transferred, exchanged, leased or sublet for use by any third party without the prior permission of Yokogawa.

# Contents

---

<b>Introduction</b> .....	<b>i</b>
<b>Documentation Conventions</b> .....	<b>ii</b>
<b>Notices</b> .....	<b>iii</b>
<b>Chapter 1. Setup</b> .....	<b>1-1</b>
1.1 Setup Procedure .....	1-1
1.2 Notes on Setting Parameters .....	1-2
<b>Chapter 2. Communication Specifications</b> .....	<b>2-1</b>
2.1 RS-485 Communication Specifications .....	2-1
<b>Chapter 3. PC Link Communication</b> .....	<b>3-1</b>
3.1 Overview .....	3-1
3.1.1 Configuration of Command .....	3-2
3.1.2 Configuration of Response .....	3-3
3.2 Communication with Host Device .....	3-4
3.2.1 List of Commands .....	3-5
3.2.2 Specifying Broadcast .....	3-6
3.2.3 Commands .....	3-7
3.2.4 Response Error Codes .....	3-20
3.3 Example of BASIC Program for Send and Receive .....	3-21
<b>Chapter 4. Ladder Communication</b> .....	<b>4-1</b>
4.1 Overview .....	4-1
4.2 Commands/Responses at the PLC .....	4-3
4.2.1 Command/Response Component Elements .....	4-3
4.2.2 Reading Parameters .....	4-4
4.2.3 Writing Parameters .....	4-5
4.2.4 Response Error Codes .....	4-6
4.3 Example of Ladder Communication Programs .....	4-7
4.3.1 Data Reading and Writing .....	4-8
4.3.2 Wiring .....	4-9
4.3.3 Configuring the Computer Link Unit .....	4-10
4.3.4 List of Devices Used .....	4-12
<b>Chapter 5. MODBUS Communication</b> .....	<b>5-1</b>
5.1 Overview .....	5-1
5.1.1 Configuration of Message .....	5-2
5.2 Communication with Host Device .....	5-3
5.2.1 List of Function Codes .....	5-3
5.2.2 Specifying Broadcast .....	5-4
5.2.3 Function Codes .....	5-5
5.2.4 Response Error Codes .....	5-9

<b>Chapter 6. Functions and Usage of D Registers (UT130, UT150/UT152/UT155) ...</b>	<b>6-1</b>
6.1 Overview of D Registers .....	6-1
6.2 Interpretation of Lists of D Registers (D Register Map Tables) .....	6-1
6.3 Classification of D Registers .....	6-2
6.4 Register Map Table .....	6-3
6.4.1 D Register Contents .....	6-4
<b>Chapter 7. Functions and Usage of I Relays (UT130, UT150/UT152/UT155) .....</b>	<b>7-1</b>
7.1 Status I Relays .....	7-1
<b>Chapter 8. Functions and Usage of D Registers (UP150) .....</b>	<b>6-1</b>
8.1 Overview of D Registers .....	6-1
8.2 Interpretation of Lists of D Registers (D Register Map Tables) .....	6-1
8.3 Classification of D Registers .....	6-2
8.4 Register Map Table .....	6-3
8.4.1 D Register Contents .....	6-5
<b>Chapter 9. Functions and Usage of I Relays (UP150) .....</b>	<b>7-1</b>
9.1 Status I Relays .....	7-1
<b>Appendix Table of ASCII Codes (Alphanumeric Codes) .....</b>	<b>App. 1</b>
<b>Revision Record .....</b>	<b>i</b>



# 1. Setup

This chapter describes the setup procedure required to be able to use the communication functions (PC link, Ladder and MODBUS) and the communication parameters of the UT100 Series.

## 1.1 Setup Procedure

Set up the communication functions on the UT100 Series as follows:

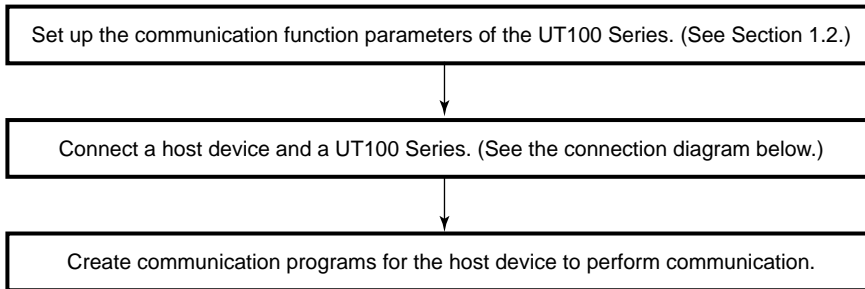

\* Communication programs should be created referring to the documentation of each host device.

### ● For UT130/UT150, UP150 connection

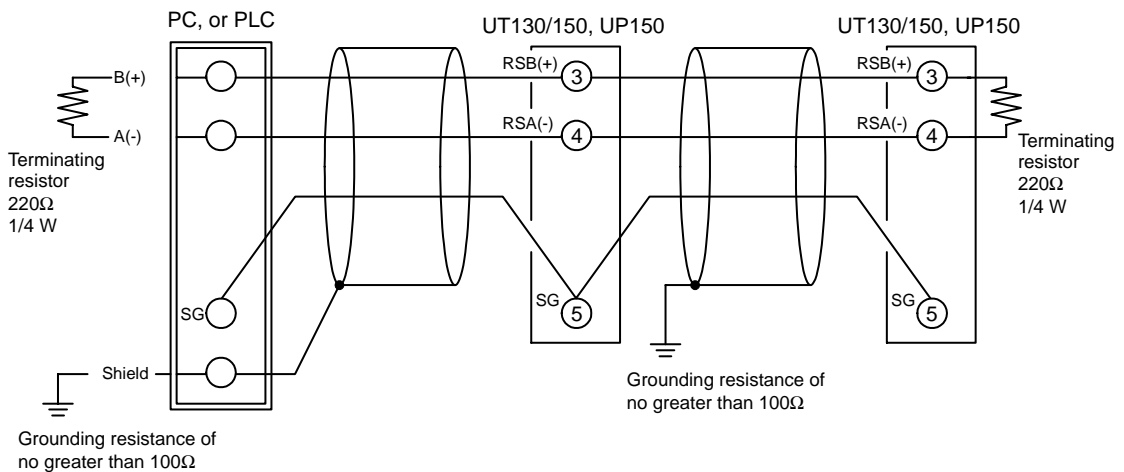

### ● For UT152/UT155 connection

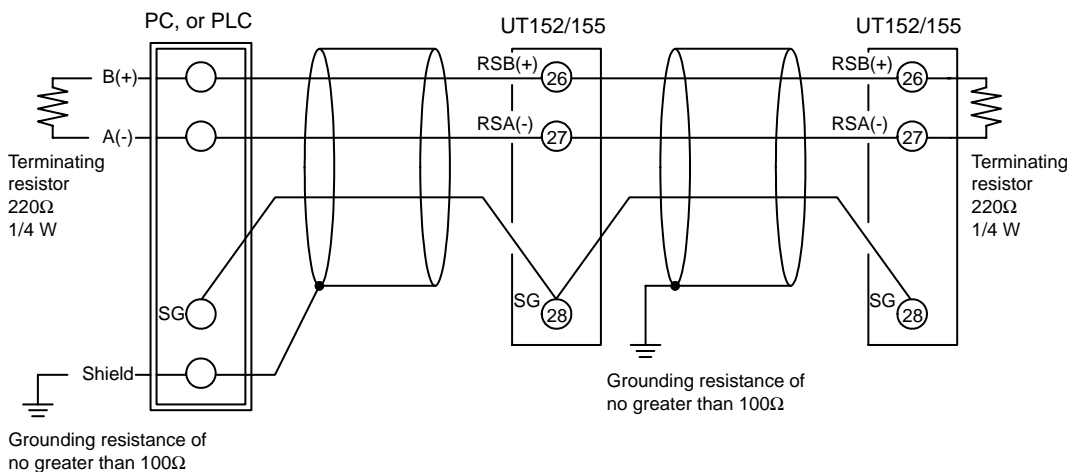

## 1.2 Notes on Setting Parameters

This section describes the setting parameters for using the communication functions and their setting ranges.



### NOTE

The details of UT100 Series communication functions need to be the same as those of the communication functions of the host devices to be connected. Check the communication parameters of the host device first, then set up those of the UT100 Series.

**Table 1-1 Parameters to be Set for Communication Functions**

Parameter Name	Symbol	Setting Range		Default
Protocol selection	PSL	PC link communication	0: without sum check 1: with sum check	0
		Ladder communication	2: Ladder	
		MODBUS communication	3: ASCII mode 4: RTU mode	
Address	ADR	1 to 99		1
Baud rate	BPS	0: 2400, 1: 4800, 2: 9600		2: 9600
Parity	PRI	0: NONE, 1: EVEN, 2: ODD		1: EVN
Stop bit	STP	1, 2		1
Data length	DLN	7, 8 (Note 1)		8

Note 1: When “2: Ladder” is selected, it is fixed to “8”.

When “3: ASCII mode” is selected for MODBUS communication in protocol selection, the data length is fixed to “7.”

When “4: RTU mode” is selected, it is fixed to “8.”

### ● Protocol-by-Protocol Default Parameter Settings

Communication Protocol	Parameter	PSL	BPS	PRI	STP	DLN
PC-link communication without sum check		0	9600	EVN	1	8
PC-link communication with sum check		1	9600	EVN	1	8
Ladder communication		2	9600	EVN	1	⑧
MODBUS communication (ASCII mode)		3	9600	EVN	1	⑦
MODBUS communication (RTU mode)		4	9600	EVN	1	⑧

Note: Circled numbers denote fixed values.

### ● Protocol selection (PSL)

Set the same communication protocol as that of the host device to be connected. The UT100 Series has PC link communication, Ladder communication and MODBUS communication functions.

- **Address number (ADR)**

Set the address number of the UT100 Series itself. An address number of 1 to 99 may be assigned in any order. There is however one limitation — the number of UT100 Series to be connected to a single communication port is limited to 31.

Example of connecting four UT100 Series to a host device by setting address numbers of 1, 50, 10, and 20

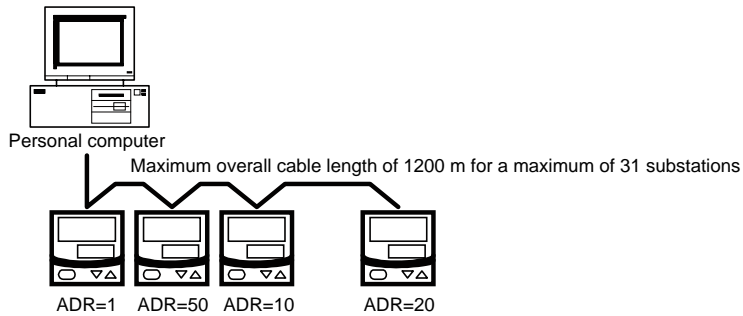

- **Baud rate (BPS)**

Set the same communication rate as that of the host device to be connected. (Otherwise, proper communication cannot be achieved.) The unit of the communication rate is bps (bits per second).

- **Parity (PRI)**

Set the handling of parity to be carried out when data is sent or received. Set the same parity state as that of the host device to be connected.

- **Stop bit (STP)**

Set the same stop bit as that of the host device to be connected.

- **Data length (DLN)**

Set the same data length as that of the host device to be connected. (When Ladder(PSL:2) and MODBUS communication (PSL: 3 or 4) is chosen in protocol selection, the data length is fixed.)



## 2. Communication Specifications

The RS-485 communication interface has the PC link communication, the Ladder communication and the MODBUS communication.

**Table 2-1 UT100 Series Communication Protocol**

Communication Hardware	2-wire RS-485 communication system
Terminal	Terminal numbers: 3 to 5 (UT130/UT150, UP150), 26 to 28 (UT152/UT155)
Communication Protocol Specifications	PC link communication without sum check PC link communication with sum check Ladder communication MODBUS communication (ASCII mode) MODBUS communication (RTU mode)
Maximum Baud Rate	9600 bps

**Table 2-2 Types of Devices to be Connected**

Device to be Connected	Communication Protocol	Example of Connected Devices
PC	PC link communication	General-purpose PCs
	MODBUS communication	General-purpose PCs
PLCs (sequencers)	Ladder communication	General-purpose PLCs (sequencers)

### 2.1 RS-485 Communication Specifications

**Table 2-3 RS-485 Communication Interface**

Item	Specifications
Standard	EIA RS-485 compliant
Maximum number of devices to be connected	31
Communication system	2-wire, half duplex
Synchronization	Start-stop synchronization
Communication protocol	Non-procedural
Maximum communication distance	1200 m
Baud rate	2400, 4800, 9600



## 3. PC Link Communication

---

### 3.1 Overview

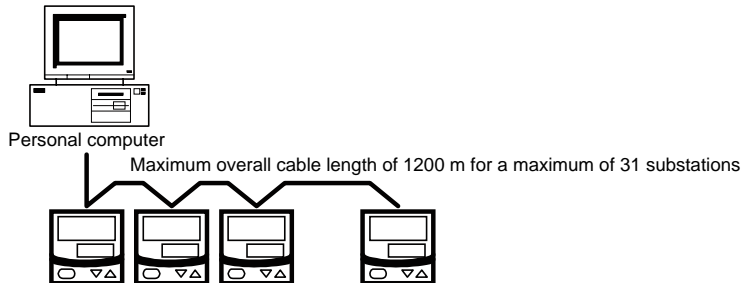

**Figure 3-1 Connection of Slaves in PC Link Communication**

The use of PC link communication enables UT100 Series to communicate with a device such as a PC, easily. In this communication, you can use such device to read/write data from/into D registers or read data from I relays, both of which are internal registers of the UT100 Series.

Hereafter, PCs are generally called “host devices.”



#### **See Also**

Chapters 6 to 9 for information on the D registers and I relays.

In the PC link communication, a host device identifies each UT100 Series with a communication address of 1 to 99. Some of commands to use let you to specify broadcast that requires no address numbers. For more information on broadcast specification, see subsection 3.2.2.

### 3.1.1 Configuration of Command

Commands sent from a host device to UT100 Series, consist of the following elements.

Number of Bytes	1	2	2	1	3	Variable length	2	1	1
Element	STX	Address number (ADR)	CPU number 01	Time to wait for response 0	Command	Data corresponding to command	Checksum	ETX	CR
	(1)	(2)	(3)	(4)	(5)	(6)	(7)	(8)	(9)

#### (1) STX (Start of Text)

This control code indicates the start of a command. The character code is CHR\$(2).

#### (2) Address Number (01 to 99)

Address numbers are used by the host device to identify UT100 Series at the communication destination. (They are identification numbers specific to the UT100 Series.)

#### (3) CPU Number

This number is fixed to 01.

#### (4) Time to Wait for Response

This is fixed to 0.

#### (5) Command (See subsection 3.2.1, List of Commands)

Specify a command to be issued from the host device.

#### (6) Data Corresponding to Command

Specify an internal register (D register or I relay), number of data pieces, UT100 Series parameter value, and others.

#### (7) Checksum

This converts the ASCII codes of texts between the character next to STX and the character immediately before the checksum into hexadecimal values and adds them byte by byte. It then fetches the single lowermost byte of the added results as the checksum.

This column is only required for PC link communication with checksum. PC link communication without checksum does not require this 2-byte space of ASCII code.

#### (8) ETX (End of Text)

This control code indicates the end of a command string. The character code is CHR\$(3).

#### (9) CR (Carriage Return)

This control code indicates the end of a command. The character code is CHR\$(13).



### NOTE

The control codes STX, ETX, and CR are essential for commands when you create a communication program for PC link communication. Omission of any of them or incorrect order of them results in communication failure.



● **Data Form of Commands**

The table below shows the data forms of commands for D registers and I relays.

**Table 3-1 Data Forms of Commands for D Registers and I Relays**

Type of Data	Contents of Data	Specified Form
PV high and low limits, target setpoints, and others	Measuring range (EU) data	Numeric data not including the decimal point
Bias, deviation alarms, and other	Measuring range width (EUS) data	Numeric data not including the decimal point
Proportional bands, upper and lower limits of output, and others	% data (0.0 to 100.0%)	0 to 1000
Various modes, alarm types, and others	Seconds, absolute values, and data without unit	Absolute values not including the decimal point

● **Command Format for Communication**

Example: When setting a target setpoint “50.0” to a UT100 Series, the host device sends the value “500” as command data without the decimal point (this is true for both setting 5.00 or 500).

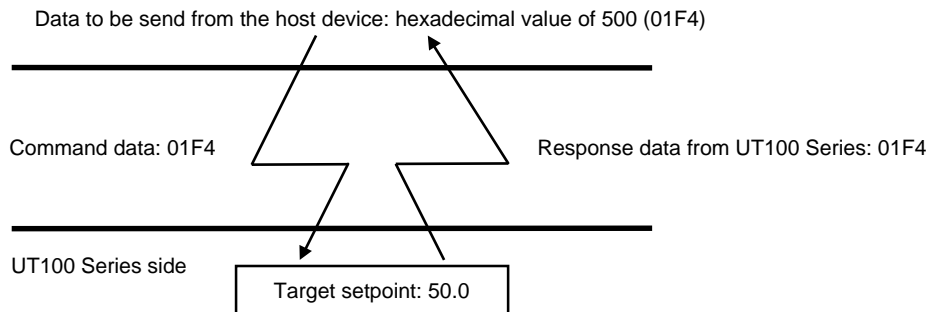

\* The position of the decimal point for “500” is determined by the DP (position of decimal point) parameter of the UT100 Series.

**3.1.2 Configuration of Response**

Responses from UT100 Series with respect to a command sent from the host device consists of the elements shown below, which differ depending on the condition of communication; normal or failure.

**1) Normal Communication**

When communication is complete normally, UT100 Series return a character string “OK” and when the read commands, return read-out data.

Number of Bytes	1	2	2	2	Variable length	2	1	1
Element	STX	Address number (ADR)	CPU number 01	OK	Parameter data	Checksum	ETX	CR

**2) In the Event of Failure**

If communication is complete abnormally, UT100 Series return a character string “ER” and error code (EC1 and EC2). (See subsection 3.2.4, Response Error Codes.)

- No response is made in case of an error in address number specification or CPU number specification.
- If a UT100 Series cannot receive ETX in a command, response may not be made.

\* As a measure against those, provide a timeout process in the communication functions of the host device or in communication programs.

Number of Bytes	1	2	2	2	2	2	3	2	1	1
Element	STX	Address number (ADR)	CPU number 01	ER	EC1	EC2	Command	Checksum	ETX	CR

## 3.2 Communication with Host Device

In PC link communication, when specifying D registers or I relays, the internal registers of UT100 Series, you can use their numbers as is. The specifications of the number of each internal register are:

- D registers: D\*\*\*\* (\*\*\*\*: 4-digit numeric value)
- I relays: I\*\*\*\* (\*\*\*\*: 4-digit numeric value)

Host devices to be connected to UT100 Series are those capable of handling the PC link communication protocol.

As an example of communication program, Section 3.3 shows an example of BASIC program created using Microsoft Quick BASIC.

### 3.2.1 List of Commands

The following shows the lists of commands available in PC link communication. The details of them are explained in the description of each command.

#### (1) Bit-basis Access Commands Dedicated to I Relays

Command	Description	Number of Bits to be Handled
BRD	Bit-basis read	1 to 48 bits
BWR	Bit-basis write	1 to 32 bits
BRR	Bit-basis, random read	1 to 16 bits
BRW	Bit-basis, random write	1 to 16 bits
BRS	Specifies I relays to be monitored on a bit-by-bit basis.	1 to 16 bits
BRM	Bit-basis monitoring	—

#### (2) Word-basis Access Commands

Command	Description	Number of Words to be
WRD	Word-basis read	1 to 32 words
WWR	Word-basis write	1 to 32 words
WRR	Word-basis, random read	1 to 16 words
WRW	Word-basis, random write	1 to 16 words
WRS	Specifies internal registers to be monitored on a word basis	1 to 16 words
WRM	Word-basis monitoring	—

#### (3) Information Command

Command	Description	Number of Devices to be Handled
INF	Reads model, presence/absence of option, and revision.	1

### 3.2.2 Specifying Broadcast

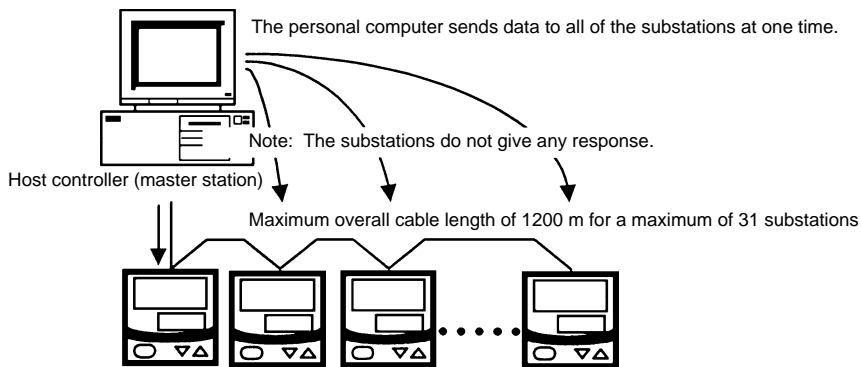

**Figure 3-2 Specifying Broadcast**

The broadcast function enables all of the connected UT100 Series or other devices to receive a command. Specifying an address number in Table 3-2 for the address number column in a command enables the host device to write data from/into the internal registers of all UT100 Series or other devices.

For UT100 Series, internal registers (D registers and I relays) are assigned with numbers for management. (See chapters 6 to 9 for details.) For the internal registers of other models, see the documentation of the relevant model.

**Table 3-2 Address Numbers**

ADR	Applicable Devices
BG	UT100 Series only

### 3.2.3 Commands

#### BRD Reads I relays on a bit-by-bit basis.

##### ● Function

Reads a sequence of contiguous ON/OFF statuses by the specified number of bits starting at a specified I relay number.

- The number of bits to be read at a time is 1 to 48.
- For the format of response in the event of failure, see subsection 3.1.2.
- The command shown below includes the checksum function. When performing communication without checksum, do not include the 2-byte checksum command element in the command.

##### ● Command/Response (for normal operation)

Number of Bytes	1	2	2	1	3	5	1	3	2	1	1
Command element	STX	Address number (ADR)	CPU number 01	0	BRD	I relay number	Comma or space	Number of bits (n)	Checksum	ETX	CR

Number of Bytes	1	2	2	2	1	1	1	...	1	2	1	1
Response element	STX	Address number (ADR)	CPU number 01	OK	d1	d2	d3	...	dn	Checksum	ETX	CR

The response is “0” when the status is OFF or “1” when ON.

$$\left[ \begin{array}{l} \text{dn: read data to the extent of the specified number of bits (n = 1 to 48)} \\ \text{dn = 0 (OFF)} \\ \text{dn = 1 (ON)} \end{array} \right]$$

##### ● Example: Reading the status of alarm 1 of the UT100 Series with address number 01

The following command reads the status of alarm 1 (I0001) at address number 01.

**[Command]** STX\$+ “01010BRDI0001, 00191” +ETX\$+CR\$

The following response is returned with respect to the above command. (Alarm 1 is ON.)

**[Response]** STX\$+ “0101OK18D” +ETX\$+CR\$

↑ Alarm has been ON since 1 was returned.

**BWR**      **Writes data into I relays on a bit-by-bit basis.**

---

● **Function**

Writes ON/OFF data into a sequence of contiguous I relays at intervals of the specified number of bits and starting at a specified I relay number.

- The number of bits to be written at a time is 1 to 32.
- For the format of response in the event of failure, see subsection 3.1.2.
- The command shown below includes a checksum function. When performing communication without checksum, do not include the 2-byte checksum command element in the command.

● **Command/Response (for normal operation)**

Number of Bytes	1	2	2	1	3	5	1	3	1	1	1
Command element	STX	Address number (ADR)	CPU number 01	0	BWR	I relay number	Comma or space	Number of bits (n)	Comma or space	d1	d2

Command (continued)

...	1	2	1	1
...	dn	Checksum	ETX	CR

Write information is “0” when it is OFF or “1” when it is ON.

( dn: write data to the extent of the specified number of bits (n = 1 to 32)  
 dn = 0 (OFF)  
 dn = 1 (ON) )

Number of Bytes	1	2	2	2	2	1	1
Response element	STX	Address number (ADR)	CPU number 01	OK	Checksum	ETX	CR

● **Example:** Setting the user-defined flag of UT100 Series with address number 01 to ON. The following command writes ON into the user-defined flag (I0018) at address number 01.

**[Command]**      **STX\$+ “01010BWRI0018, 001, 1AC” +ETX\$+CR\$**

Note: The user-defined flag is a flag the user can read/write without restraint. For areas available to the user, see Chapter 7 or 9, Functions and Applications of I Relays.

“OK” is returned as the response to the above command.

**[Response]**      **STX\$+ “0101OK5C” +ETX\$+CR\$**

**BRR Reads I relays on a bit-by-bit basis in a random order.**

● **Function**

Reads the ON/OFF statuses of I relays at intervals of the specified number of bits in a random order.

- The number of bits to be read at a time is 1 to 16.
- For the format of response in the event of failure, see subsection 3.1.2.
- The command shown below includes a checksum function. When performing communication without a checksum, do not include the 2-byte checksum command element in the command.

● **Command/Response (for normal operation)**

Number of Bytes	1	2	2	1	3	2	5	1	5	1
Command element	STX	Address number (ADR)	CPU number 01	0	BRR	Number of bits (n)	I relay number 1	Comma or space	I relay number 2	Comma or space

Command (continued)

...	5	2	1	1
...	I relay number n	Checksum	ETX	CR

Number of Bytes	1	2	2	2	1	1	...	1	2	1	1
Response element	STX	Address number (ADR)	CPU number 01	OK	d1	d2	...	dn	Checksum	ETX	CR

The response is “0” when the status is OFF or “1” when ON.

$$\left[ \begin{array}{l} \text{dn: read data to the extent of the specified number of bits (n = 1 to 16)} \\ \text{dn = 0 (OFF)} \\ \text{dn = 1 (ON)} \end{array} \right]$$

● **Example:** Reading the statuses of alarms 1 and 2 of the UT100 Series with address number 05  
 The following command reads the statuses of alarm 1 (I0001) and alarm 2 (I0002) at address number 05.

**[Command] STX\$+ “05010BRR02I0001, I00027F” +ETX\$+CR\$**

With respect to the above command, the ON and OFF responses are returned for alarms 1 and 2 respectively.

**[Response] STX\$+ “0501OK10C1” +ETX\$+CR\$**

↑ Alarm 1 has been ON.

**BRW**      **Writes data into I relays on a bit-by-bit basis in a random order.**

● **Function**

Writes ON/OFF statuses into I relays at intervals of the specified number of bits on a per-I relay basis and in random order.

- The number of bits to be written at a time is 1 to 16.
- For the format of response in the event of failure, see subsection 3.1.2.
- The command shown below includes the checksum function. When performing communication without a checksum, do not include the 2-byte checksum command element in the command.

● **Command/Response (for normal operation)**

Number of Bytes	1	2	2	1	3	2	5	1	1	1	5
Command element	STX	Address number (ADR)	CPU number 01	0	BRW	Number of bits (n)	I relay number 1	Comma or space	d1	Comma or space	I relay number 2

Command (continued)

1	1	1	...	5	1	1	2	1	1
Comma or space	d2	Comma or space	...	I relay number n	Comma or space	dn	Checksum	ETX	CR

Write information is “0” when it is OFF or “1” when it is ON.

( dn: write data to the extent of the specified number of bits (n = 1 to 16)  
 dn = 0 (OFF)  
 dn = 1 (ON) )

Number of Bytes	1	2	2	2	2	1	1
Response element	STX	Address number (ADR)	CPU number 01	OK	Checksum	ETX	CR

● **Example:** Setting four user-defined flags of the UT100 Series with address number 05 to ON, OFF, OFF, and ON.

The following command sets the four user-defined flags (I0021, I0022, I0023, and I0024) at address number 05 to ON, OFF, OFF, and ON respectively.

**[Command]**      **STX\$+ “05010BRW04I0021, 1, I0022, 0, I0023, 0, I0024, 15C” +ETX\$+CR\$**

Note: The user-defined flags (I relays) are flags that the user can freely read/write. For areas available to the user, see Chapter 7 or 9, Functions and Applications of I Relays.

“OK” is returned as the response to the above command.

**[Response]**      **STX\$+ “0501OK60” +ETX\$+CR\$**



**BRS**      Specifies I relays to be monitored on a bit-by-bit basis.

● **Function**

Specifies the numbers of I relays to be monitored on a bit-by-bit basis. Note that this command simply specifies I relays. Actual monitoring is performed by the BRM command after the I relay numbers are specified.

When the volume of data is large and you wish to increase the communication rate, it is effective to use a combination of the BRS and BRM commands rather than the BRD command.

- The number of registers to be specified at a time is 1 to 16.
- For the format of response in the event of failure, see subsection 3.1.2.
- The command shown below includes the checksum function. When performing communication without a checksum, do not include the 2-byte checksum command element in the command.

● **Command/Response (for normal operation)**

Number of Bytes	1	2	2	1	3	2	5	1	5	1
Command element	STX	Address number (ADR)	CPU number 01	0	BRS	Number of bits (n)	I relay number 1	Comma or space	I relay number 2	Comma or space

Command (continued)

...	5	2	1	1
...	I relay number n	Checksum	ETX	CR

Number of Bytes	1	2	2	2	2	1	1
Response element	STX	Address number (ADR)	CPU number 01	OK	Checksum	ETX	CR

● **Example:** Monitoring the PV burnout status of the UT100 Series with address number 05  
 The following command monitors the PV burnout status (I0007) at address number 05.

(This command is used for simply specifying registers.)

**[Command]**      STX\$+ “05010BRS01I0007E” +ETX\$+CR\$

“OK” is returned as the response to the above command.

**[Response]**      STX\$+ “0501OK60” +ETX\$+CR\$

**BRM      Monitors I relays on a bit-by-bit basis.**

---

● **Function**

Reads the ON/OFF statuses of I relays that have been specified in advance by the BRS command.

- Before executing this command, the BRS command must always be executed to specify which I relays are to be monitored. If no relay has been specified, error code 06 is generated. This error also occurs if the power supply is turned off.
- For the format of response in the event of failure, see subsection 3.1.2.
- The command shown below includes the checksum function. When performing communication without the checksum, do not include the 2-byte checksum command element in the command.

● **Command/Response (for normal operation)**

Number of Bytes	1	2	2	1	3	2	1	1
Command element	STX	Address number (ADR)	CPU number 01	0	BRM	Checksum	ETX	CR

Number of Bytes	1	2	2	2	1	1	1	...	1	2	1	1
Response element	STX	Address number (ADR)	CPU number 01	OK	d1	d2	d3	...	dn	Checksum	ETX	CR

The response is “0” when the status is OFF or “1” when ON.

$$\left[ \begin{array}{l} \text{dn: read data to the extent of the number of bits specified by the BRS command (n = 1 to 16)} \\ \text{dn = 0 (OFF)} \\ \text{dn = 1 (ON)} \end{array} \right]$$

● **Example:** Monitoring the PV burnout status of the UT100 Series with address number 05  
 The following command monitors the PV burnout status (I0007) at address number 05.  
 (This command reads the statuses of the I relays specified by the BRS command.)

**[Command]      STX\$+ “05010BRMD7” +ETX\$+CR\$**

The ON/OFF status of the I relay is returned as the response to the above command.

**[Response]      STX\$+ “0501OK191” +ETX\$+CR\$**

↑  
 I relay has been ON.

**WRD Reads D registers and I relays on a word-by-word basis.****● Function**

Reads a sequence of contiguous register information on a word-by-word basis, by the specified number of words, and starting at the specified register number.

- The number of words to be read at a time is 1 to 32.
- For the format of response in the event of failure, see subsection 3.1.2.
- The command shown below includes the checksum function. When performing communication without the checksum, do not include the 2-byte checksum command element in the command.

**● Command/Response (for normal operation)**

Number of Bytes	1	2	2	1	3	5	1	2	2	1	1
Command element	STX	Address number (ADR)	CPU number 01	0	WRD	Register number	Comma or space	Number of words (n)	Checksum	ETX	CR

Number of Bytes	1	2	2	2	4	4	...	4	2	1	1
Response element	STX	Address number (ADR)	CPU number 01	OK	ddd1	ddd2	...	dddn	Checksum	ETX	CR

The response is returned in a 4-digit character string (0000 to FFFF) in a hexadecimal pattern.

( Read data of the specified number of words  
 ddddn = character string in a hexadecimal pattern  
 n = 1 to 32 )

- **Example:** Reading a measured input value of the UT100 Series with address number 03  
 The following command reads the measured input value (D0002) at address number 03.

**[Command]** STX\$+ "03010WRDD0002, 0174" +ETX\$+CR\$

The measured input value 200 (00C8 (HEX)) is returned as the response to the above command.

**[Response]** STX\$+ "0301OK00C839" +ETX\$+CR\$

**WWR**      **Writes data into D registers and I relays on a word-by-word basis.**

---

● **Function**

Writes information into a sequence of contiguous registers on a word-by-word basis, by the specified number of words, and starting at the specified register number.

- The number of words to be written at a time is 1 to 32.
- For the format of response in the event of failure, see subsection 3.1.2.
- The command shown below includes the checksum function. When performing communication without the checksum, do not include the 2-byte checksum command element in the command.

● **Command/Response (for normal operation)**

Number of Bytes	1	2	2	1	3	5	1	2	1	4
Command element	STX	Address number (ADR)	CPU number 01	0	WWR	Register number	Comma or space	Number of words (n)	Comma or space	dddd1

Command (continued)

4	...	4	2	1	1
dddd2	...	dddn	Checksum	ETX	CR

Write information is specified in a 4-digit character string (0000 to FFFF) in a hexadecimal pattern.

( Write data of the specified number of words  
 ddddn = character string in a hexadecimal pattern  
 n = 1 to 32 )

Number of Bytes	1	2	2	2	2	1	1
Response element	STX	Address number (ADR)	CPU number 01	OK	Checksum	ETX	CR

● **Example:** Writing “200” into target setpoint of UT100 Series with address number 03.

The following command writes data 200 (00C8 (HEX)) into the target setpoint 1 (D0120) at address number 03.

**[Command]**      **STX\$+ “03010WWRD0120, 01, 00C88F” +ETX\$+CR\$**

“OK” is returned as the response to the above command.

**[Response]**      **STX\$+ “0301OK5E” +ETX\$+CR\$**

**WRR Reads D registers and I relays on a word-by-word basis in random order.**

● **Function**

Reads the statuses of registers on a word-by-word basis, by the specified number of words and in a random order.

- The number of words to be read at a time is 1 to 16.
- For the format of response in the event of failure, see subsection 3.1.2.
- The command shown below includes the checksum function. When performing communication without the checksum, do not include the 2-byte checksum command element in the command.

● **Command/Response (for normal operation)**

Number of Bytes	1	2	2	1	3	2	5	1	5	1
Command element	STX	Address number (ADR)	CPU number 01	0	WRR	Number of words (n)	Register number 1	Comma or space	Register number 2	Comma or space

Command (continued)

...	5	2	1	1
...	Register number (n)	Checksum	ETX	CR

Number of Bytes	1	2	2	2	4	4	...	4	2	1	1
Response element	STX	Address number (ADR)	CPU number 01	OK	ddd1	ddd2	...	dddn	Checksum	ETX	CR

The response is returned in a 4-digit character string (0000 to FFFF) in a hexadecimal pattern.

( dddn = character string in a hexadecimal pattern (n = 1 to 16) )

● **Example:** Reading the measured input and output values of the UT100 Series with address number 10.

The following command reads the measured input value (D0002) and output value (D0004) at address number 10.

**[Command]** STX\$+ "1001WRR02D0002, D000489" +ETX\$+CR\$

The measured input value 200 (00C8 (HEX)) and output value 50 (0032 (HEX)) are returned as the response to the above command.

**[Response]** STX\$+ "1001OK00C80032FC" +ETX\$+CR\$

**WRW** Writes data into D registers and I relays on a word-by-word basis in random order.

● **Function**

Writes register information specified for each register into registers of the specified number of words in a random order.

- The number of words to be written at a time is 1 to 16.
- For the format of response in the event of failure, see subsection 3.1.2.
- The command shown below includes the checksum function. When performing communication without the checksum, do not include the 2-byte checksum command element in the command.

● **Command/Response (for normal operation)**

Number of Bytes	1	2	2	1	3	2	5	1	4	1
Command element	STX	Address number (ADR)	CPU number 01	0	WRW	Number of words (n)	Register number 1	Comma or space	dddd1	Comma or space

Command (continued)

5	1	4	...	5	1	4	2	1	1
Register number 2	Comma or space	dddd2	...	Register number n	Comma or space	ddddn	Checksum	ETX	CR

Write information is specified in a 4-digit character string (0000 to FFFF) in a hexadecimal pattern.

Repetition of register numbers and write information by the specified number of words  
 ddddn = character string in a hexadecimal pattern  
 n = 1 to 16

Number of Bytes	1	2	2	2	2	1	1
Response element	STX	Address number (ADR)	CPU number 01	OK	Checksum	ETX	CR

- **Example:** Writing “20.0” into target setpoint of UT100 Series with address number 10 and “15.0” into the alarm-1 setpoint.

The following command writes

“20.0” into target setpoint 1 (D0120) and “15.0” into the alarm-1 setpoint (D0101) at address number 10.

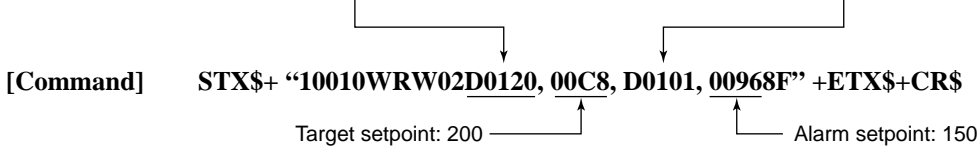

“OK” is returned as the response to the above command.

[Response] STX\$+ “1001OK5C” +ETX\$+CR\$



**WRM Monitors the D register and I relays on a word-by-word basis.**

● **Function**

Reads register information that has been specified in advance by the WRS command.

- Before executing this command, the WRS command must always be executed to specify which registers are to be monitored. If no register has been specified, error code 06 is generated. This error also occurs if the power supply is turned off.
- For the format of response in the event of failure, see subsection 3.1.2.
- The command shown below includes the checksum function. When performing communication without the checksum, do not include the 2-byte checksum command element in the command.

● **Command/Response (for normal operation)**

Number of Bytes	1	2	2	1	3	2	1	1
Command element	STX	Address number (ADR)	CPU number 01	0	WRM	Checksum	ETX	CR

Number of Bytes	1	2	2	2	4	4	...	4	2	1	1
Response element	STX	Address number (ADR)	CPU number 01	OK	dddd1	dddd2	...	ddddn	Checksum	ETX	CR

The response is returned in a 4-digit character string (0000 to FFFF) in a hexadecimal pattern.

( Read data of the number of words specified by the WRS command  
 ddddn = character string in a hexadecimal pattern  
 n = 1 to 16 )

● **Example:** Monitoring the measured input value of UT100 Series with address number 01  
 The following command monitors the measured input value (D0002) at address number 01.

(This command reads the statuses of the registers specified by the WRS command.)

[Command] STX\$+ "01010WRME8"+ETX\$+CR\$  
 ↑  
 CPU number: 01

The measured input value 200 (00C8 (HEX)) is returned as the response to the above command.

[Response] STX\$+ "0101OK00C837"+ETX\$+CR\$  
 ↑  
 Measured input value: 200



**INF Reads the model, presence or absence of options, and revisions.**

● **Function**

Returns the model number of UT100 Series, whether any options are included, and the version number and revision number are read.

- For the format of response in the event of failure, see subsection 3.1.2.

● **Command/Response (for normal operation)**

Number of Bytes	1	2	2	1	3	1	2	1	1
Command element	STX	Address number (ADR)	CPU number 01	0	INF	6	Checksum	ETX	CR

Number of Bytes	1	2	2	2	8	8	4	4
Response element	STX	Address number (ADR)	CPU number 01	OK	U□□□□□□□□ (Note 1)	Version Revision (Note 2)	Readout start register for special device	Number of readout registers for special device

Response (continued)

4	4	2	1	1
Write start register for special device	Number of write registers for special device	Checksum	ETX	CR

Note: Model, control output and option of UT100 Series

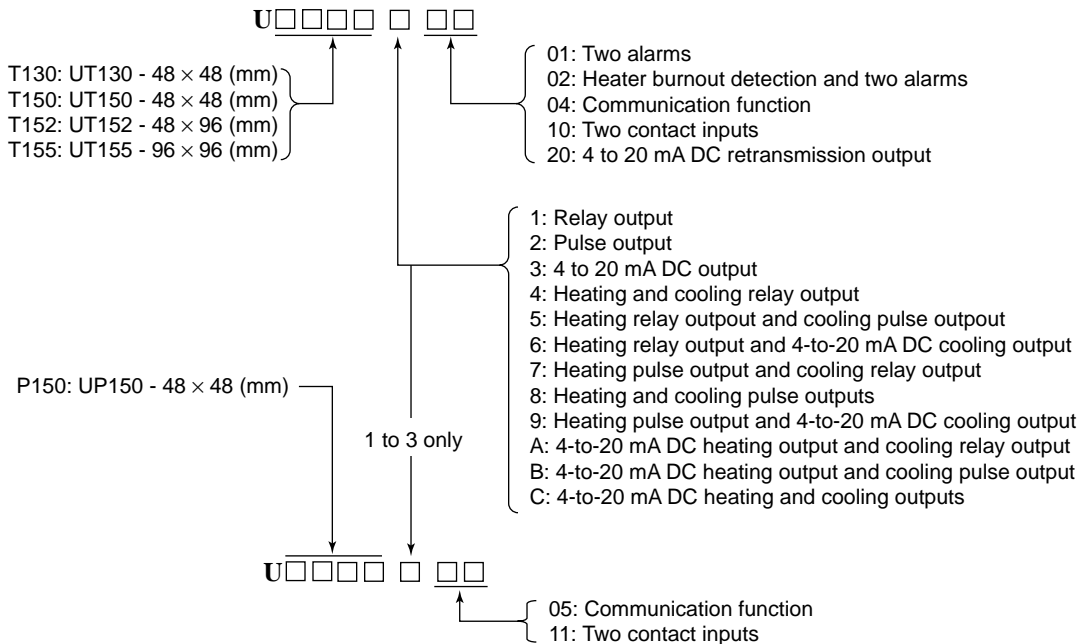

Note: Version number and revision number

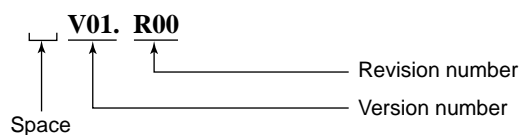

### 3.2.4 Response Error Codes



#### See Also

Subsection 3.1.2, Configuration of Response, for the structure of the response in the event of error.

The error codes (EC1) and detailed error codes (EC2) of response are as follows.

**Table 3-3 List of Error Codes EC1**

Error Code	Meaning	Causes
02	Command error	<ul style="list-style-type: none"> <li>No command exists.</li> <li>Command not executable</li> </ul>
03	Register specification error	<ul style="list-style-type: none"> <li>No register number exists.</li> <li>If a bit register (I relay) is used on a word-by-word basis, its specification is not correct.</li> </ul>
04	Out of setpoint range	<ul style="list-style-type: none"> <li>A character other than 0 or 1 has been used for the bit setting.</li> <li>A value other than 0000 to FFFF has been specified in the word specification.</li> <li>The position of a start for a data load, save, or other command, is out of the address range.</li> </ul>
05	Out of data number range	<ul style="list-style-type: none"> <li>The specification of the number of bits or words is out of the range of use.</li> <li>The number of data specified and the number of parameters for registers, etc. are not consistent.</li> </ul>
06	Monitor error	<ul style="list-style-type: none"> <li>An attempt was made to execute monitoring without specifying the monitor (BRS or WRS).</li> </ul>
08	Parameter error	<ul style="list-style-type: none"> <li>An illegal parameter is set.</li> </ul>
42	Sum error	<ul style="list-style-type: none"> <li>The sum does not match the expected value.</li> </ul>
43	Internal buffer overflow	<ul style="list-style-type: none"> <li>A data value greater than specified is received.</li> </ul>
44	Character reception time-out	<ul style="list-style-type: none"> <li>The end-of-data or end-of-text character is not received.</li> </ul>

**Table 3-4 List of Detailed Error Codes EC2**

Error Code (EC1)	Meaning	Detailed Error Code (EC2)
03	Register specification error	Parameter number where error occurred (HEX)
04	Out of setpoint range	This is the number of a parameter in sequence that first resulted in error when counted from the leading parameter.
05	Out of data number range	<p><b>Example:</b></p> <p style="text-align: center;">Error in register name specification ↓</p> <p><b>STX 01010BRW 05 I0017, 1, I0018, 0, A00502</b></p> <p style="text-align: center;">Parameter numbers 1 2 3 4 5 6</p> <p>In this case, EC1 = 03 and EC2 = 06</p>
08	Parameter error	An illegal parameter is set.

For error codes other than those noted as EC1, there is no EC2 meaning.

#### ■ Checking error on the controller

If the wiring or parameter setting for communication are not correct, the controller displays the error as followings.

Press the SET/ENT key once. The error display goes out.

Display	Error content	Remedy
Flashing period on PV display	Communication failure (only when /RS is specified)	Press any key to stop the flashing

### 3.3 Example of BASIC Program for Send and Receive

This section shows an example of a command sending and response receiving program created with Microsoft Quick BASIC\*<sup>2</sup> for PC/AT\*<sup>1</sup> (or compatible machines).

The communication conditions of the UT100 Series and those of the PC (e.g., communication rate) must agree with each other. Set the communication rate (baud rate) of the PC using the SWITCH command of MS-DOS\*<sup>3</sup>. For how to use the SWITCH command, refer to the User's Reference Manual of MS-DOS. Moreover, set the parity, character bit length, stop bit length, and so on using the OPEN statement.

\*1 PC/AT is a product of IBM Corporation.

\*2 Microsoft Quick BASIC is a registered trademark of Microsoft Corporation.

\*3 MS-DOS is a registered trademark of Microsoft Corporation.

**Example of the Program Created Using Microsoft Quick BASIC Version 7.1  
(Reads the values in three D registers from register 0002.)**

```

1000 ` === Main routine ===
1010 STX$=CHR$(2)           ` Define
1020 ETX$=CHR$(3)         ` Define
1030 CR$=CHR$(13)         ` Define
1040 RCVCHR$= ""          ` Initialize receive character string
1050 fRCVEND=0            ` Initialize flag
1060 fTIMEOUT=0           ` Initialize flag
1070 `
1080 SEND$=STX$+"01010WRDD0002,03"+ETX$ ` Create character string for send
1090 `
1100 OPEN "COM1:9600,N,8,1,ASC" FOR RANDOM AS #1 ` Open a port
1110     ON COM(1) GOSUB receivechr ` Specify interruption processing during
                                     receiving
1120     ON TIME(5) GOSUB timeout ` Specify interruption processing at timeout
1130 `
1140     PRINT #1,SEND$        ` Send
1150     COM(1) ON            ` Permit interruption during receive
1160     TIMER ON            ` Start timer
1170 `
1180     DO                  ` Wait for receive end or timeout
1190     LOOP WHILE fRCVEND=0 AND fTIMEOUT=0 `
1200 `
1210     TIMER OFF          ` Stop timer
1220     COM(1) OFF        ` Prohibit interruption during receiving
1230     CLOSE #1         ` Close the port
1240 `
1250     PRINT ">" +SEND$ ` Display sent character string on screen
1260     PRINT "<" +RCVCHR$ ` Display received character string on
                                     screen
1270     END              ` END
1280 `
1290 ` === Subroutine ===
1300 receivechr:          ` Interruption processing during receiving
1310     CHR1$=INPUT$(1,#1) ` Fetch characters from receive buffer
                                     one by one
1320     IF CHR1$=CR$ THEN ` If received character string is "CR,"
1330     IF RCVCHR$=SEND$ THEN ` If received character string is the same
                                     served command,
1340     RCVCHR$=""        ` Initialize receive character string.(Echo
                                     Back Processing)
1350         fRCVEND=0    ` receiving flag remains initialized at 0.
1360     ELSE              ` If received character string is different
                                     from served command,
1370         fRCVEND=1    ` receiving end flag is set.
1380     END IF          `
1390     ELSE              ` If it is a character other than CR,
1400         fRCVEND=0    ` receiving end flag remains initialized at 0.
1410     RCVCHR$=RCVCHR$+CHR1$ ` Create received character string
1420     END IF
1430     RETURN
1440 `

```

```
1450 timeout:                ' Timeout processing
1460     fTIMEOUT=1          ' Set timeout flag
1470     RCVCHR$="Time out ! (5 sec)" + CR$ ' Character string for display on screen
                                           "Time out! (5 sec)"

1480 RETURN
↑
```

\* The line numbers are not required. (They are simply provided for checking the number of program steps.)



# 4. Ladder Communication

## 4.1 Overview

You can establish a data link between UT100 Series controller and sequencer (PLC) by simply creating a ladder program on PLC.

By specifying the register numbers of the D registers of the instrument as parameters in the ladder program, you can write/read data to and from the registers using BCD codes (0 to 9).

You cannot access I relays when using ladder communication. First, obtain an understanding of the ladder communication protocol, then refer to the examples of ladder communication in Subsection 4.3.

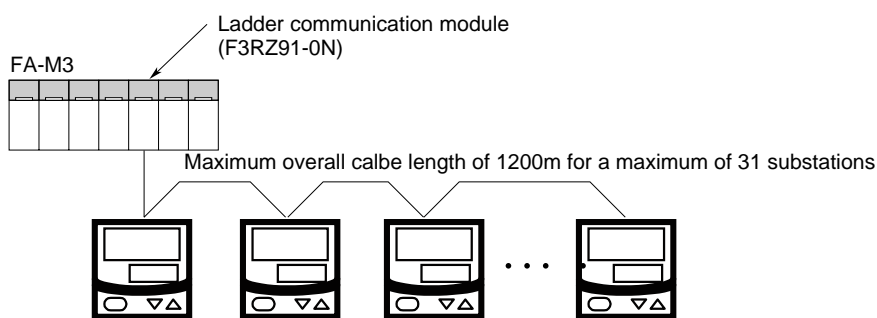

Figure 4-1 Connection Example for Ladder Communication

### ● Connecting the digital indicating controller to a PLC made by Mitsubishi

When the controller is connected to a PLC manufactured by Mitsubishi (MELSEC-A series), you can use the non-procedural mode of the computer link unit. An example of communication program connected with MELSEC-A series PC link units is described in section 4.3.

● **Data Form of Commands**

The table below shows the data forms of commands for D registers.

**Table 4-1 Data Forms of Commands for D Registers**

Type of Data	Contents of Data	Specified Form
PV high and low limits, target setpoints, and others	Measuring range (EU) data	Numeric data not including the decimal point
Bias, deviation alarms, and other	Measuring range span (EUS) data	Numeric data not including the decimal point
Proportional bands, upper and lower limits of output, and others	% data (0.0 to 100.0%)	0 to 1000
Various modes, alarm types, and others	Seconds, absolute values, and data without unit	Absolute values not including the decimal point

● **Command Format for Communication**

Example: When setting a target setpoint “50.0” to UT100 Series, the higher-level device sends the value “500” as command data without the decimal point (this is true for both setting 5.00 or 500).

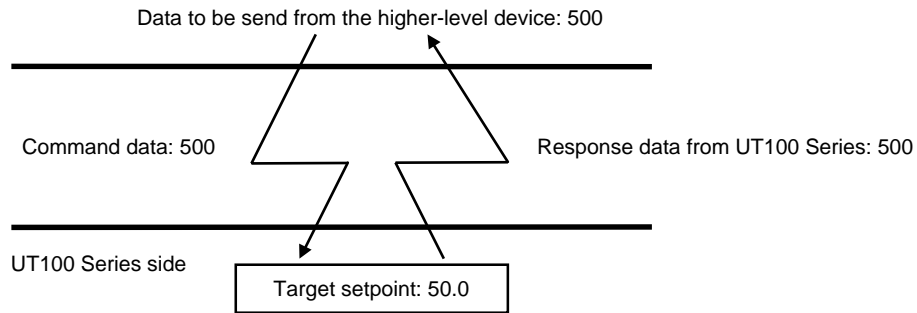

\* The position of the decimal point for “500” is determined by the DP (position of decimal point) parameter of UT100 Series.



## 4.2 Commands/Responses at the PLC

The PLC sends commands, and receives responses to these commands. The commands/responses that can be used are as follows.

### 4.2.1 Command/Response Component Elements

Commands sent from the PLC to the instrument are of the form shown in the table below.

Number of bytes	1	1	2	1		1		2	1	1
Number of BCD digits	2	2	4	1	1	1	1	4	2	2
Command/response element	Address number (ADR)	CPU number (01)	Parameter number	0	0	R/W	+/-	Read/write data	CR (0D)	LF (0A)

Can be changed only during a read operation.  
A maximum of 64 data items

#### 1) Station number (01 to 99)

Number used to enable the PLC to identify UT100 Series with which it communicates (UT100 Series communication address).

#### 2) CPU number

Fixed at 01.

#### 3) Parameter number

Four-digit BCD data of D register number



#### See Also

For details on D registers see chapters 6.

#### 4) 0

This position is fixed at 0.

#### 5) 0

This position is fixed at 0.

#### 6) R/W

0: Read

1: Write

#### 7) +/-

0: Positive data (+)

1: Negative data (-)

#### 8) Read/write data

In the case of a write operation, this is BCD 4-digit set data excluding the decimal point. In the case of a read operation, it is the number of data items that are read.

#### 9) CR, LF

Control code which indicates the termination of a command. The corresponding character codes are CR = CHR\$(13) and LF = CHR\$(10).

## 4.2.2 Reading Parameters

Parameters from the PLC are read to UT100 Series Controller in the following configuration.

Capable of reading data from a maximum of 20.

Number of bytes	1	1	2	1		1		2	1	1
Number of BCD digits	2	2	4	1	1	1	1	4	2	2
Command element	Address number (ADR)	CPU number (01)	Parameter number	0	0	0	0	Number of data items that are read (n)	CR (0D)	LF (0A)

Number of bytes	1	1	2	1		1		2	1		1		2
Number of BCD digits	2	2	4	1	1	1	1	4	1	1	1	1	4
Response element	Address number (ADR)	CPU number (01)	Parameter number	0	0	0	+/-	dddd1	0	0	0	+/-	dddd2

Data of parameter number (a)      Data of parameter number (b)

...	1		1		2	1	1
	1	1	1	1	4	2	2
...	0	0	0	+/-	dddd1	CR (0D)	LF (0A)

Data of parameter number (n)

- Example of reading a measured input value (D register 0002) of UT100 Series with address number 01

[Command] "01010002000000010D0A"

Note: Concerning D registers, refer to Chapter 6 or 8.

The measured input value 200 (BCD code) is returned in response to the above command.

[Response] "01010002000002000D0A"

Refer to the send data creation programs in Section 4.3 for examples of ladder programs of commands. Also, refer to the receive data processing programs in Section 4.3 for examples of ladder programs used in response to commands.

### 4.2.3 Writing Parameters

Parameters from the PLC are written to the instrument in the following configuration.

Number of bytes	1	1	2	1		1		2	1	1
Number of BCD digits	2	2	4	1	1	1	1	4	2	2
Command element	Address number (ADR)	CPU number (01)	Parameter number	0	0	1	+/-	dddd	CR (0D)	LF (0A)

Number of bytes	1	1	2	1		1		2	1	1
Number of BCD digits	2	2	4	1	1	1	1	4	2	2
Response element	Address number (ADR)	CPU number (01)	Parameter number	0	0	1	+/-	dddd	CR (0D)	LF (0A)

- Example of writing 200 into target setpoint (D register 0003) of UT100 Series with address number 01

[Command] "0101000300100**2000**D0A"

Note: Concerning D registers, refer to Chapter 6 or 8.

The measured input value 200 (BCD code) is returned in response to the above command.

[Response] "0101000300100**2000**D0A"

Refer to the send data creation programs in Section 4.3 for examples of ladder programs of commands. Also, refer to the receive data processing programs in Section 4.3 for examples of ladder programs used in response to commands.

## 4.2.4 Response Error Codes

Data that the master station (PLC) may receive on an error occurrence and the descriptions of the corresponding error are shown in the table below.

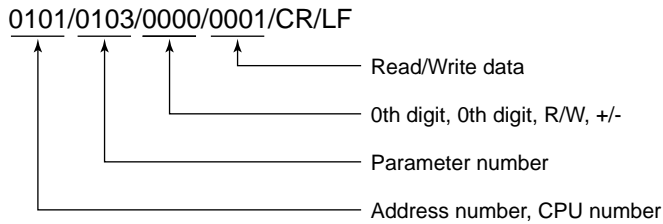

Note: “ / ” in the following send and receive data examples is used for explanatory purposes only, and is not part of the actual data string.

**Table4-2 Error Code List**

Description of error	Example of master controller send data	Master controller receive data
A non-existent parameter was set.	0101/0603/0000/0001/CR/LF	0101/0603/0000/FFFF/CR/LF ↑ FFFF is returned.
Characters other than a BCD code (0 to 9) were used other than in an address. * This excludes LF (0A).	0101/0123/0000/000B/CR/LF 0101/0123/000B/0000/CR/LF 0101/0123/0B00/0000/CR/LF 0101/012B/0000/0000/CR/LF	0101/FFFF/FFFF/FFFF/CR/LF
An LF code (0A) was used other than in an address.	0101/0123/0000/000A/CR/LF 0101/0123/000D/0000/CR/LF 0101/0123/0D00/0000/CR/LF 0101/010D/0000/0000/CR/LF	No response
An address differed from the addresses of the UT100 Series. * In the example at right, none of the addresses exist.	0103/0123/0000/0000/CR/LF 0001/0123/000D/0000/CR/LF 3301/0123/0000/0000/CR/LF	No response
The write data was outside the range. * In the example at right, the current P: Proportional band is 5.0.	0101/0122/0011/9999/CR/LF ↑ Data outside the range	0101/0122/0000/0050/CR/LF ↑ Current P: Proportional band
The command length (length of the send data) is incorrect. * The command length, including CR and LF, must be 10 bytes.	0101/0123/0000/00/CR/LF 0101/0123/0/CR/LF 0101/0/CR/LF	No response
A timeout occurred during communication. * Timeout is 5 seconds.	–	No response
The buffer overflowed. * This error occurs when the buffer overflow exceeds 190 bytes.	–	No response
A framing error or a parity error occurred.	–	No response



### NOTE

If a parameter that is not in the D register table or the I relay table is read, an error does not occur. In this case, 0 will be returned instead.

## 4.3 Example of Ladder Communication Programs

This manual presents examples of how Yokogawa's UT100 series temperature controller is ladder-programmed to communicate with Mitsubishi Electric's MELSEC-A programmable logic controller (PLC). Communication is carried out through a computer link unit (Model A1SJ71C24-R4 or A1SJ71UC24-R4).

- Tasks involved in programming:  
Data are read from and written to three UT100 series controllers connected to the PLC.
- Tasks involved in reading:  
The four data items—PV error information (ERROR), measured input value (PV), current target setpoint (CSP) and control output value (OUT)—are read into the PLC's registers at regular intervals (one second).
- Tasks involved in writing:  
The target setpoints of the three UT100 series controllers having addresses 1, 2 and 3 are changed from the PLC. These changes are made through the PLC's contact inputs.

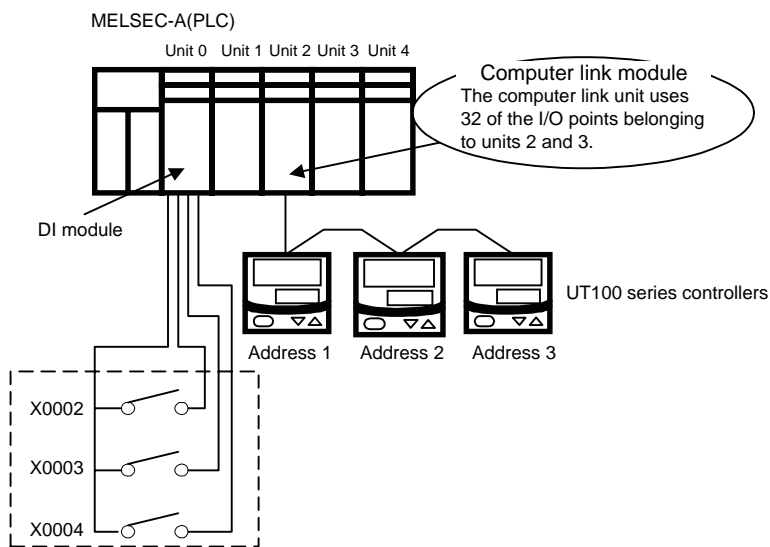

### 4.3.1 Data Reading and Writing

#### ● Locations where PLC Data Are Stored (for reading)

	Address-1 Controller	Address-2 Controller	Address-3 Controller
PV error information	D0104	D0124	D0144
Measured input value	D0106	D0126	D0146
Target setpoint	D0108	D0128	D0148
Control output value	D0110	D0130	D0150

#### ● Switches for Changing the Target Setpoints (writing)

- X0002: On - The value of the PLC's D0021 register is written to the SP parameter of the address-1 controller.  
Off - The value of the PLC's D0022 register is written to the SP parameter of the address-1 controller.
- X0003: On - The value of the PLC's D0023 register is written to the SP parameter of the address-2 controller.  
Off - The value of the PLC's D0024 register is written to the SP parameter of the address-2 controller.
- X0004: On - The value of the PLC's D0025 register is written to the SP parameter of the address-3 controller.  
Off - The value of the PLC's D0026 register is written to the SP parameter of the address-3 controller.

### 4.3.2 Wiring

This section explains how to connect the two-wire computer link unit to two-wire UT100 series controllers.

Short-circuit the SDA(+) and RDA(+) terminals and the SDB(-) and RDB(-) terminals of the computer link unit as the UT100 series controller is designed to operate in a two-wire system. Be sure to attach 220-Ω, 1/2-Watt terminating resistors, as shown in the following figures.

#### ● Wiring to a UT130, UT150 or UP150 Controller

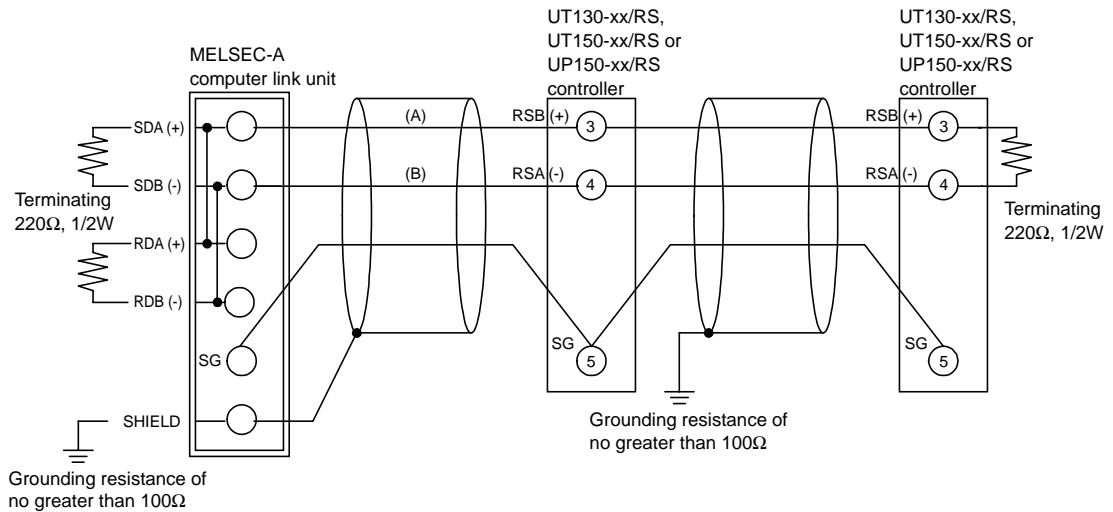

#### ● Wiring to a UT152 or UT155 Controller

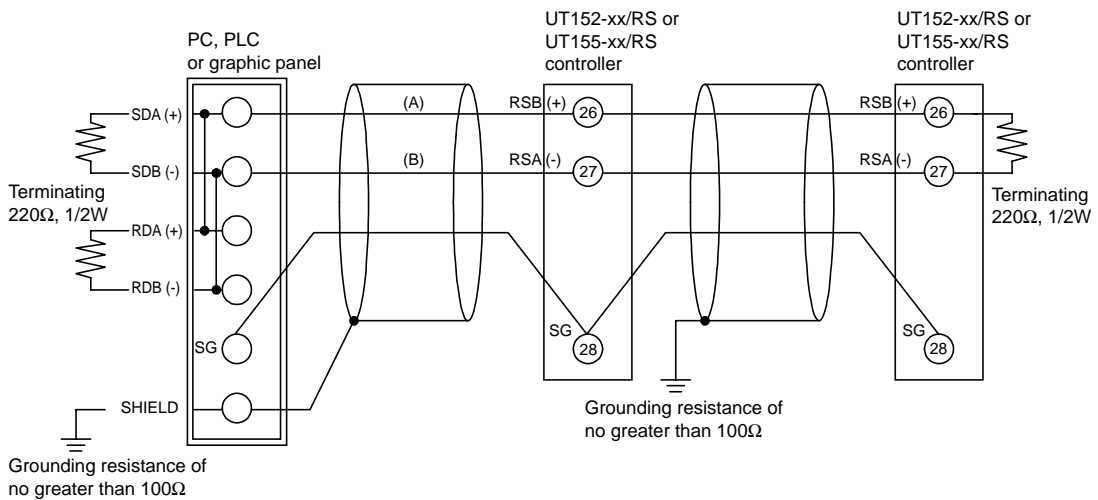

### NOTE

The symbols for the terminal assignments of the computer link unit and UT100 series controllers indicate:

- positive polarity by the letter A for the computer link unit and by the letter B for the UT100 series controller, and
- negative polarity by the letter B for the computer link unit and by the letter A for the UT100 series controller.

### 4.3.3 Configuring the Computer Link Unit

This section explains how to define the specifications of communication carried out between the computer link unit and the UT100 series controllers.

The computer link unit is configured using its front-panel DIP switch, while communication parameters are used to configure the UT100 series controllers.

#### ● Transmission Specifications of Computer Link Unit

Switch Assignment	Setup Parameter	State	
		ON	OFF
01	Unused	—	—
02	Selection between computer link unit and multidrop link	Computer link unit	Multidrop link
03	Unused	—	—
04	Write enable/disable during the RUN mode	Enable	Disable
05	Baud rate	Programmed as shown in Note.	
06			
07			
08	Data bits	8 bits	7 bits
09	Use/non-use of parity bit	Used	Unused
10	Selection of even parity or odd parity	Even	Odd
11	Stop bits	2 bits	1 bit
12	Use/non-use of sum check	Used	Unused

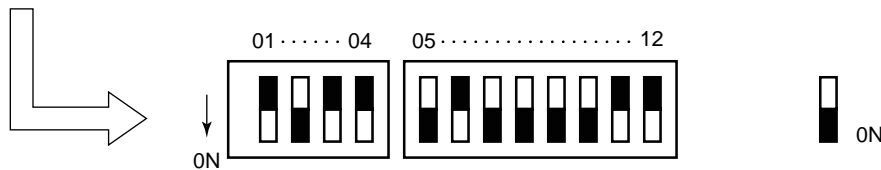

Note: Table of Baud Rates

Baud Rate (bps)	300	600	2400	4800	9600	19200	Undefined
SW05	OFF	ON	OFF	OFF	ON	OFF	ON
SW06	OFF	OFF	ON	OFF	OFF	ON	ON
SW07	OFF	OFF	OFF	ON	ON	ON	ON

Shaded areas are not used for the communication with the UT100 series controllers.

#### ● Communication Specifications of UT100 Series Controller

Para-meter	Description	Setup Range	Example of Setup
PSL	Protocol selection	0: PC link without sum check 1: PC link with sum check 2: Ladder-programmed communication 3: MODBUS (ASCII) 4: MODBUS (RTU)	2
ADR	Address	1 to 99 (maximum of 31 units)	1
BPS	Baud rate (bps)	0: 2400; 1: 4800; 2: 9600	2
PRI	Parity	0: None; 1: Even; 2: Odd	0
STP	Stop bits	1 or 2	1
DLN	Data length	7 or 8	8



● **Station Number Setting Switch on Computer Link Unit**



$0 \times 10$  — Sets the tens' digit.

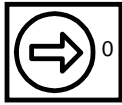

$0 \times 1$  — Sets the ones' digit.

● **Mode Setting Switch on Computer Link Unit**



Mode

Mode	Definition
0	Unused.
1 to 3	Unused.
4	Non-procedural mode
5	Type-1 protocol mode
6	Type-2 protocol mode
7	Type-3 protocol mode
8	Type-4 protocol mode
9 to E	Unused.
F	Testing of separate unit

### 4.3.4 List of Devices Used

The following table lists the devices used in the examples of ladder programming for communication described.

Device Name		Description
Special relays	M9032	One-second clock
	M9036	Always-ON flag
	M9038	Flag for initial processing (ON state for one scan)
	M9039	RUN flag
Internal relays	M1	Selection of transmission 1
	M2	Selection of transmission 2
	M3	Selection of transmission 3
	M305	Read/write flag
	M306	Data comparison flag
	M500	Zero reset
	M501	Initial flag
	M502	Reset flag
	M601	Transmission 1P
	M602	Transmission 2P
	M603	Transmission 3P
Inputs	X0002	Target setpoint setting flag of address-1 controller
	X0003	Target setpoint setting flag of address-2 controller
	X0004	Target setpoint setting flag of address-3 controller
	X0020	End-of-transmission flag (for computer link unit only)
	X0021	Request-to-read-received-data flag (for computer link unit only)
Outputs	Y0030	Request-to-send flag (for computer link unit only)
	Y0031	End-of-reading-of-received-data flag (for computer link unit only)
Data registers	D0	Number of transmitted data items
	D1	CPU address
	D2	First D register number
	D3	Read/write command
	D4	Number of data items
	D5	End of transmission
	D100	Data size received by address-1 controller
	D101 to 104	Data received by address-1 controller
	D120	Data size received by address-2 controller
	D121 to 124	Data received by address-2 controller
	D140	Data size received by address-3 controller
	D141 to 144	Data received by address-3 controller
	D201	Data of address-1 controller for writing
	D202	Data of address-2 controller for writing
	D203	Data of address-3 controller for writing
	D301	Communication buffer for address-1 controller
	D302	Communication buffer for address-2 controller
	D303	Communication buffer for address-3 controller

\*\*\*\* Startup Process \*\*\*\*

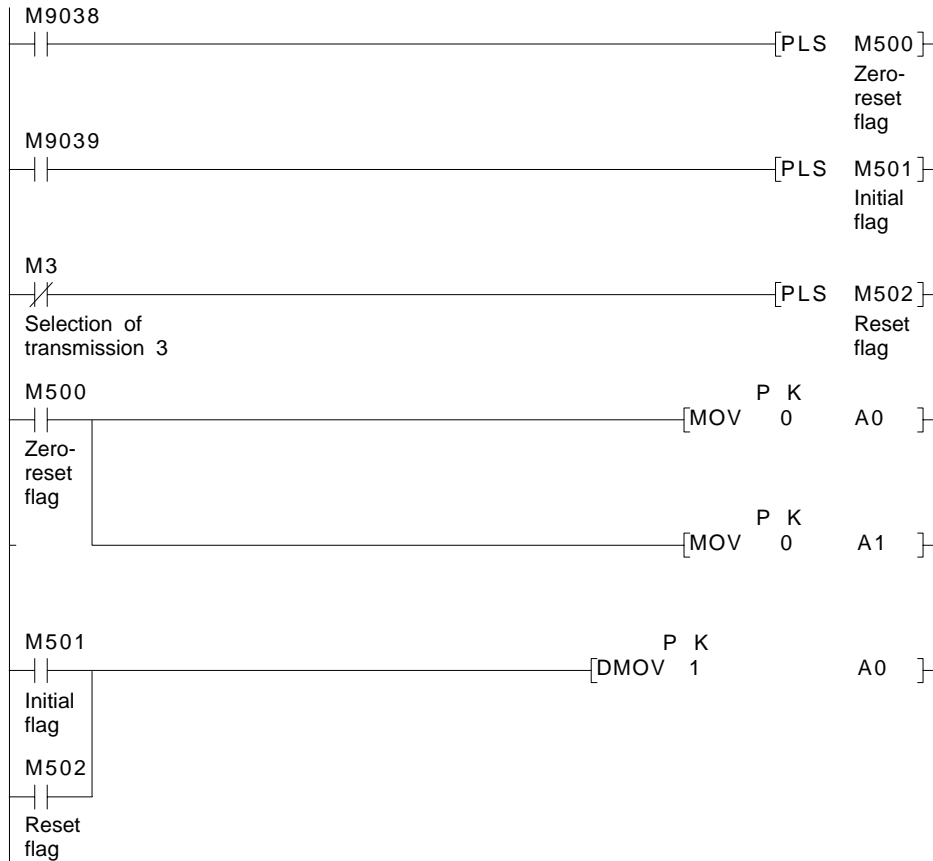

\*\*\*\* Rotation Command \*\*\*\*



\*\*\*\* Substitution of Codes with Flags \*\*\*\*



\*\*\*\* Communication Command Processing \*\*\*\*

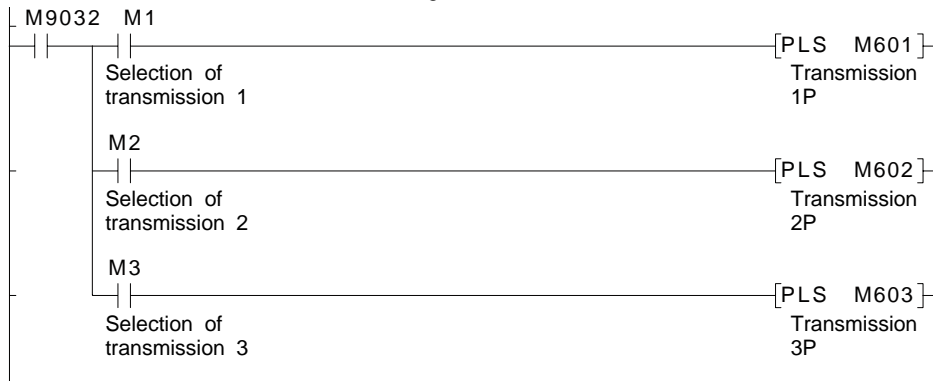

\*\*\*\* SP Data Setting \*\*\*\*

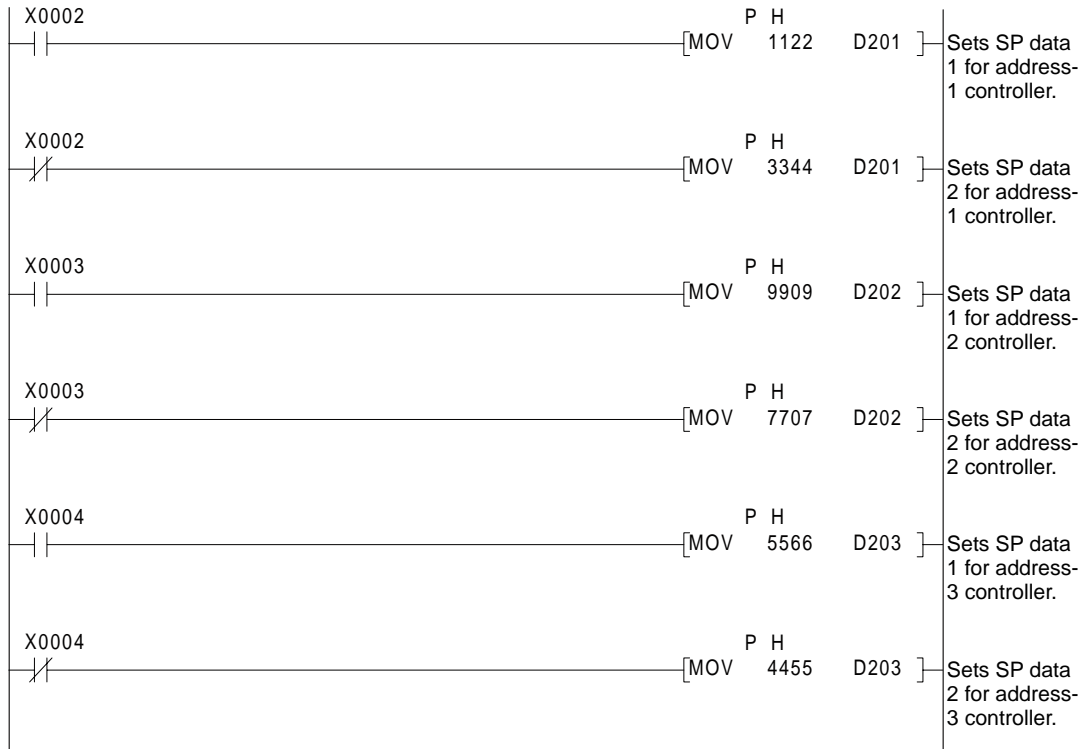

\*\*\*\* Data Comparison \*\*\*\*



\*\*\*\* Process for Accepting Writing \*\*\*\*

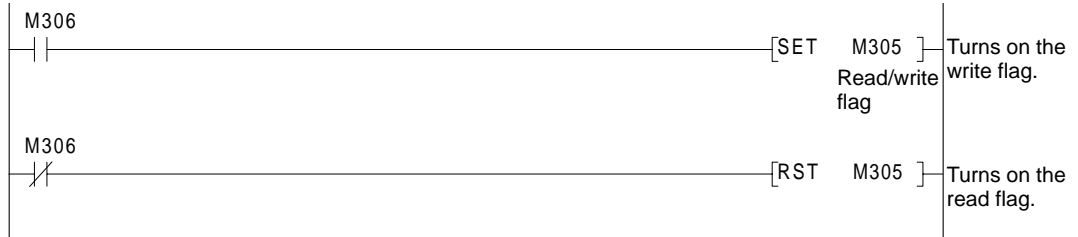

\*\*\*\* Process for Sending Read Command from Address-1 Controller \*\*\*\*

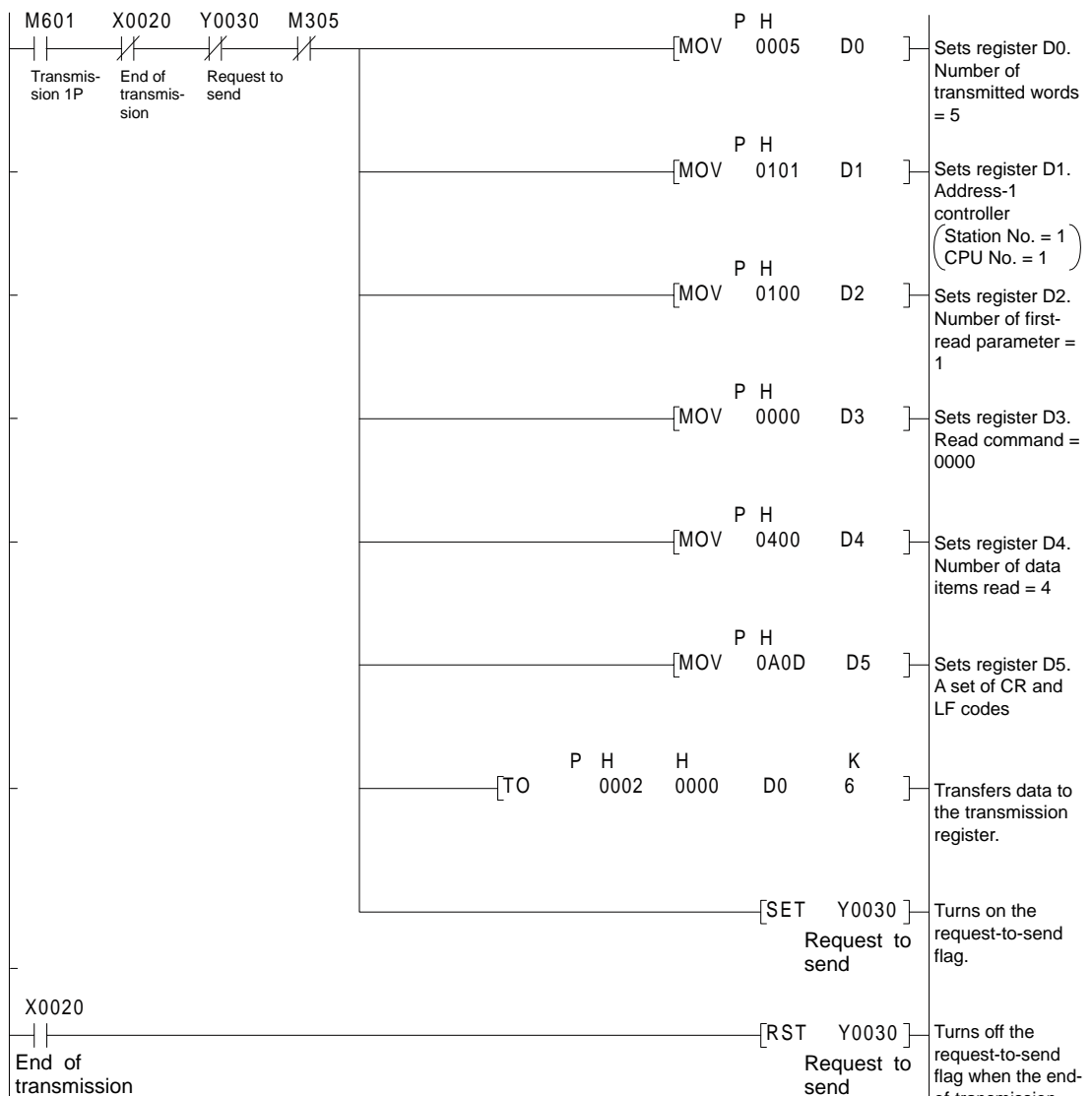

\*\*\*\* Process for Receiving Data from Address-1 Controller \*\*\*\*

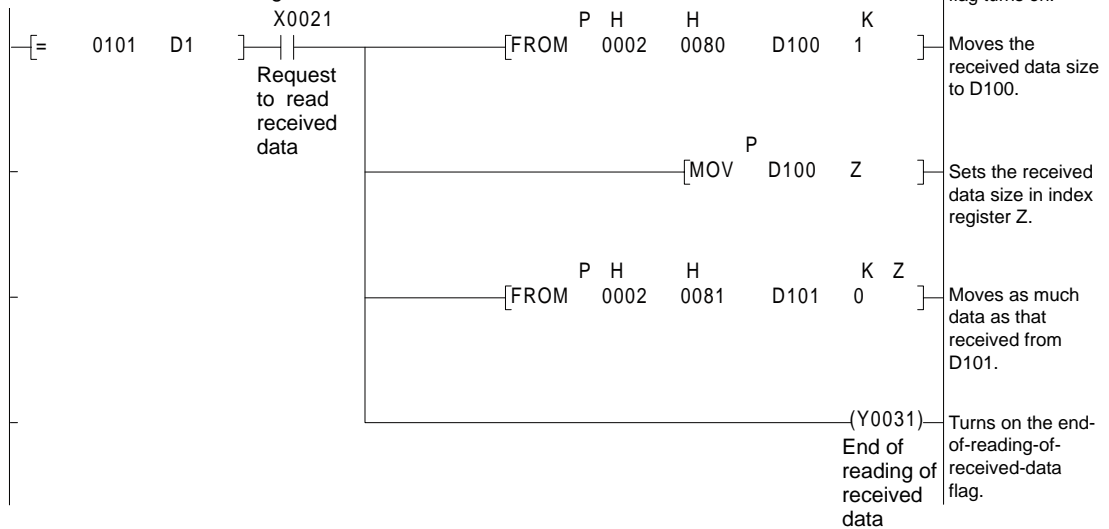

\*\*\*\* Process for Sending Read Command from Address-2 Controller \*\*\*\*

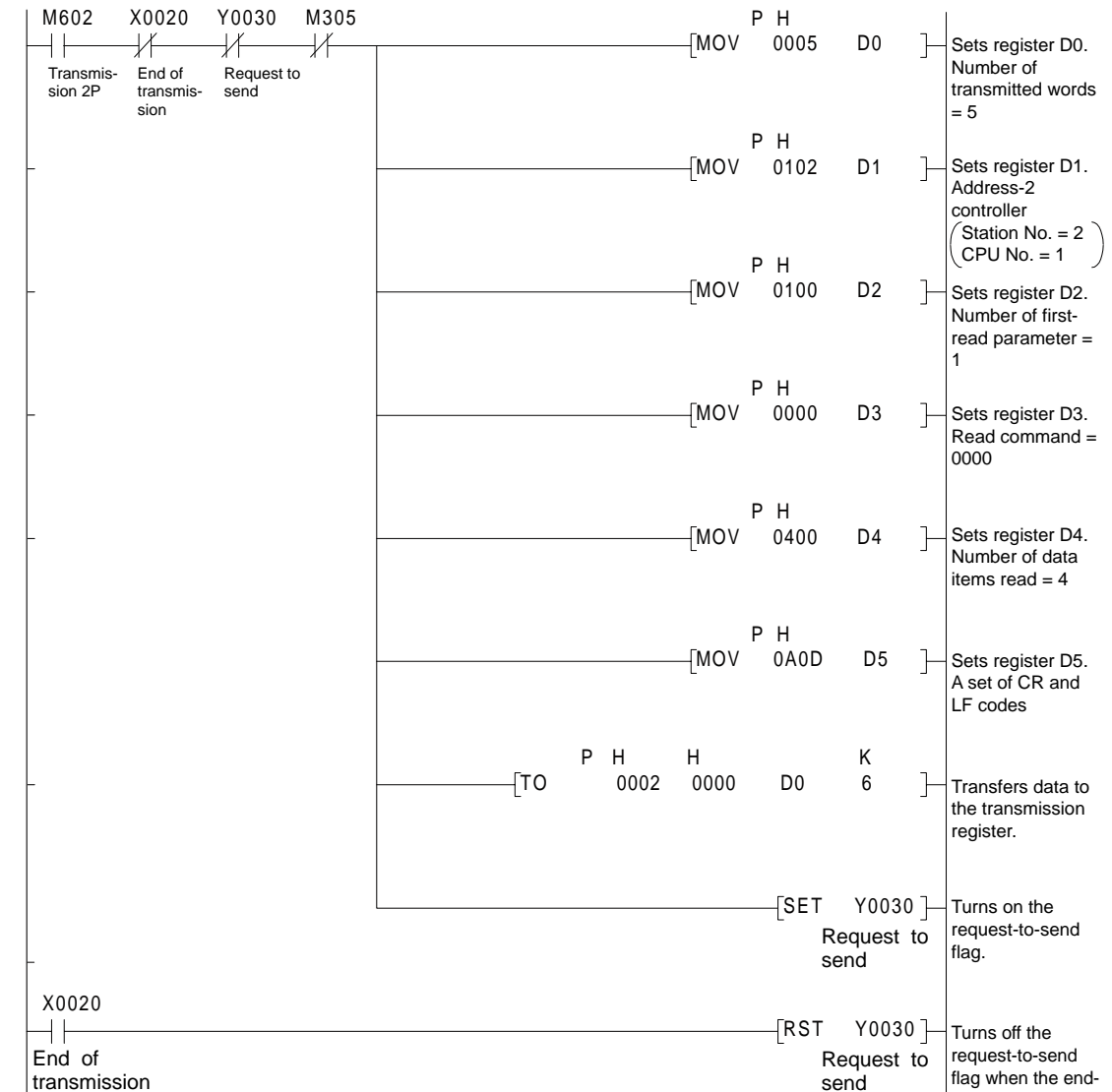

\*\*\*\* Process for Receiving Data from Address-2 Controller \*\*\*\*

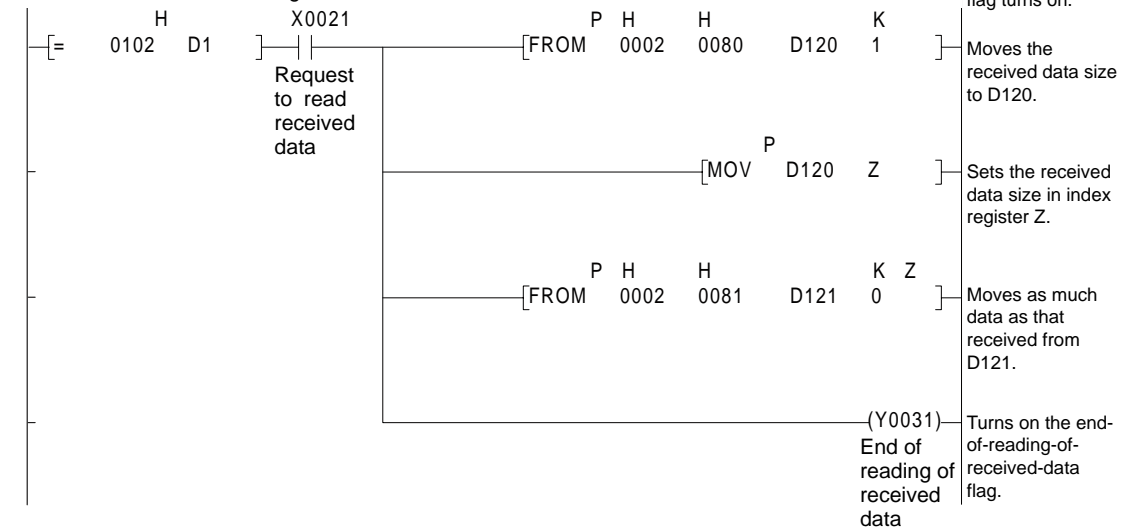

\*\*\*\* Process for Sending Read Command from Address-3 Controller \*\*\*\*

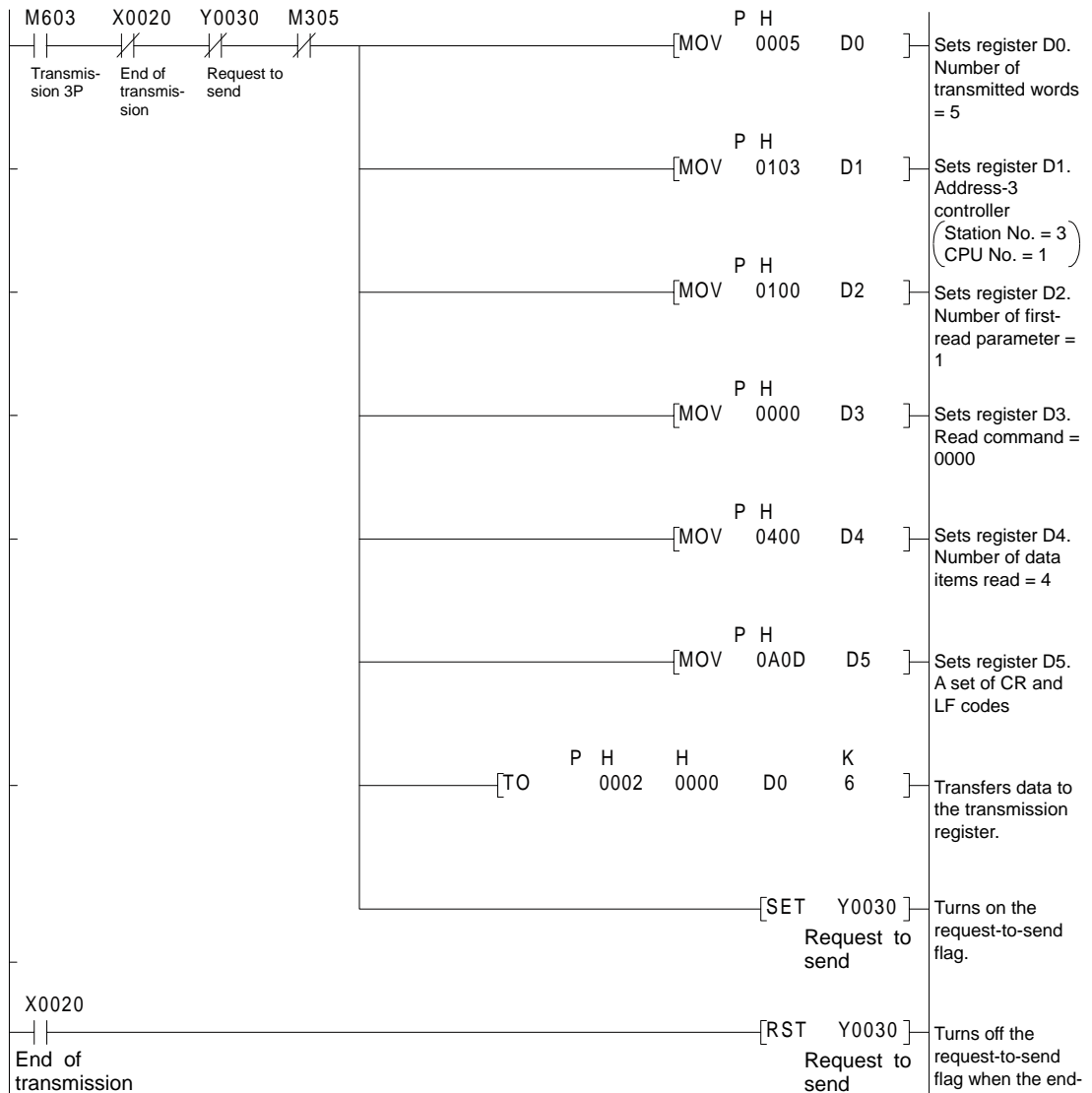

\*\*\*\* Process for Receiving Data from Address-3 Controller \*\*\*\*

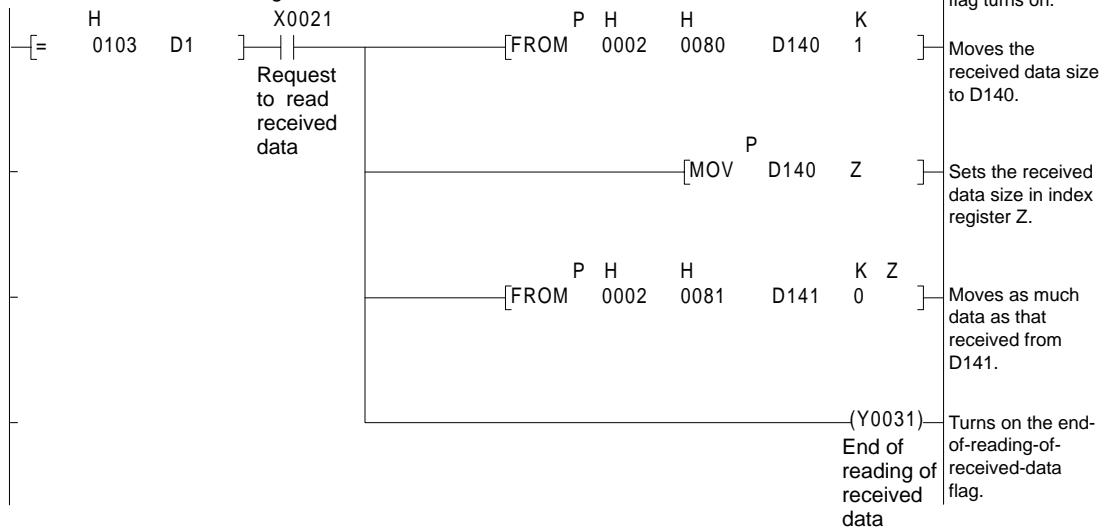

\*\*\*\* Process for Writing to Address-1 Controller \*\*\*\*

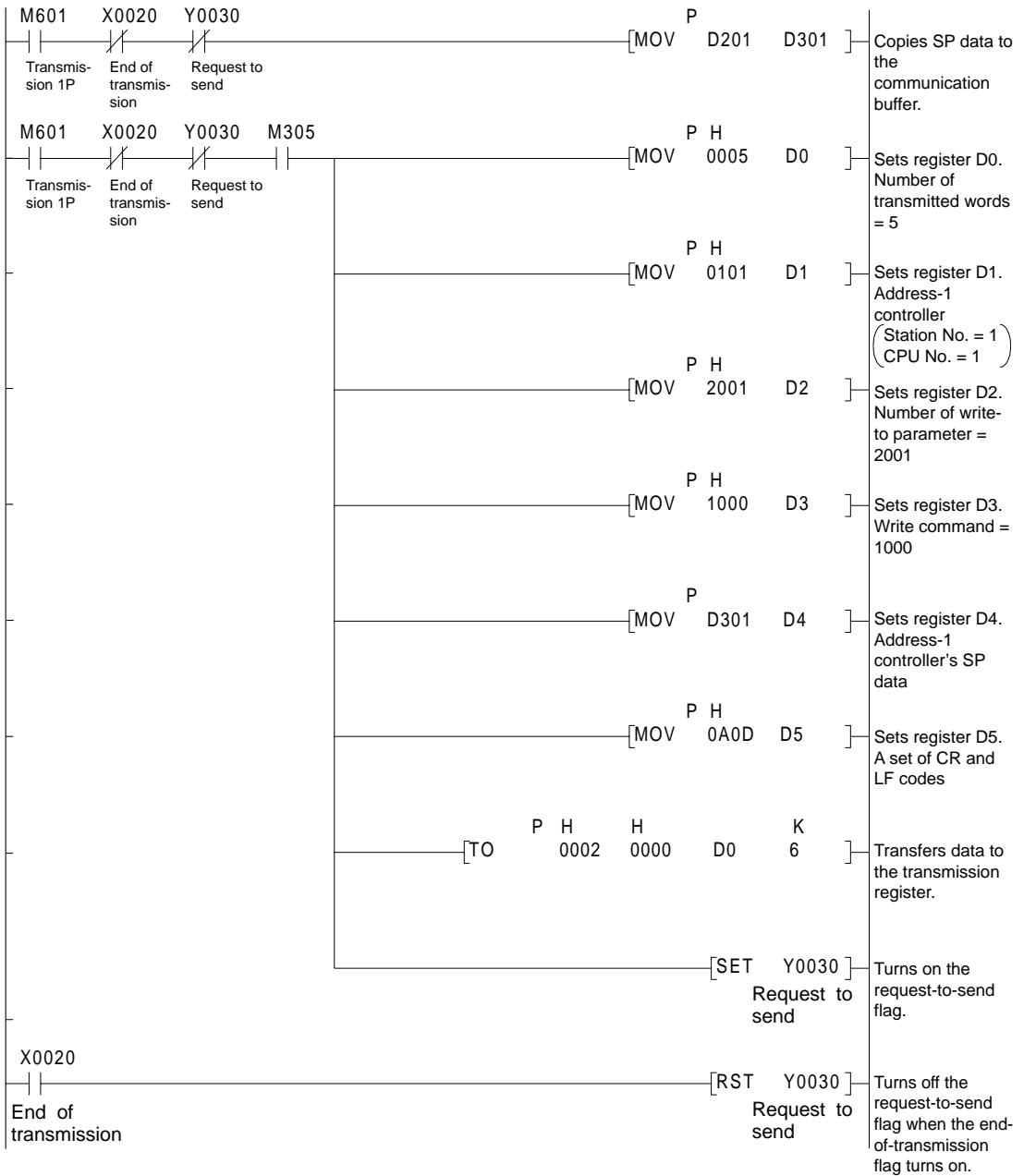



\*\*\*\* Process for Writing to Address-2 Controller \*\*\*\*

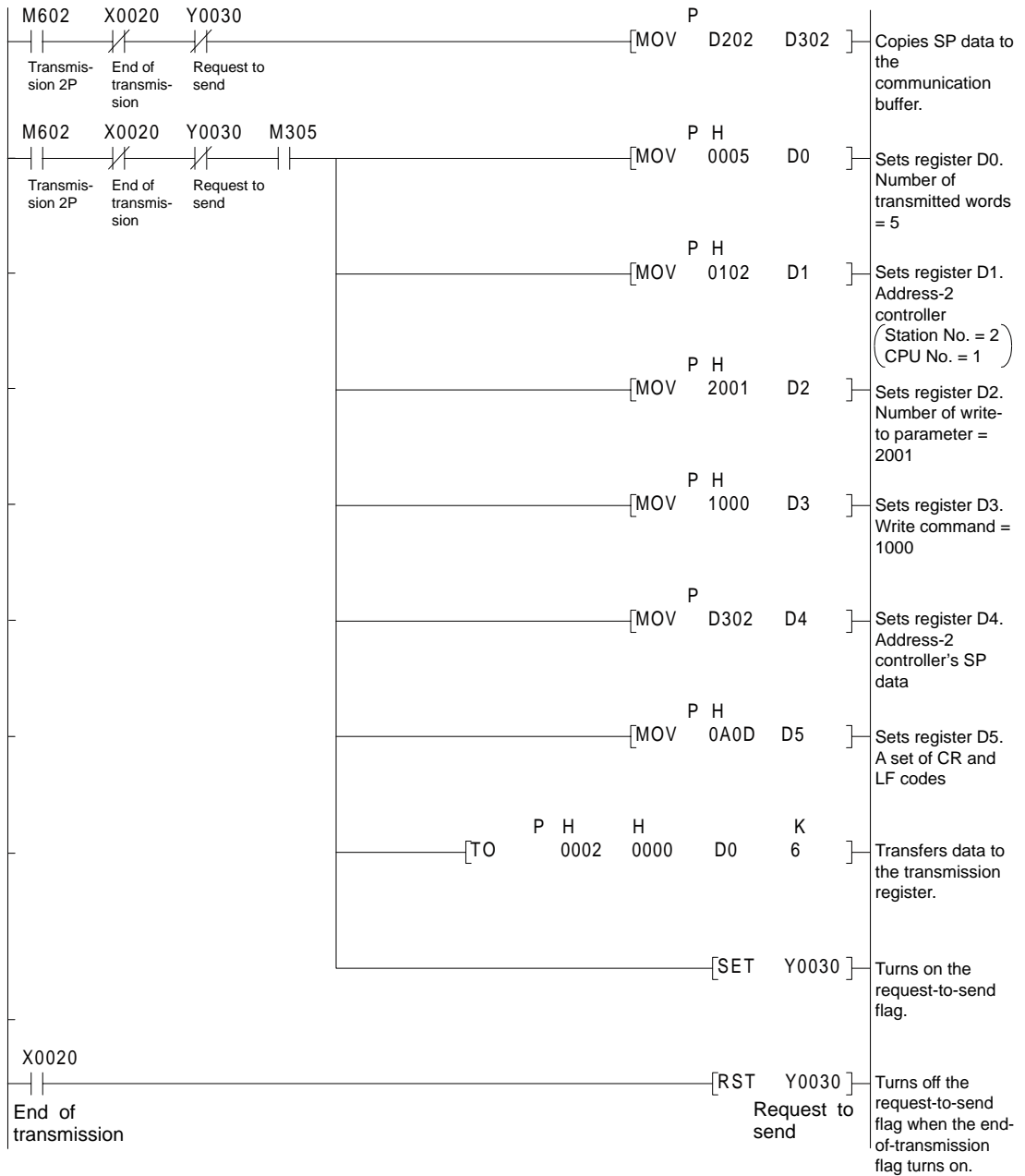

\*\*\*\* Process for Writing to Address-3 Controller \*\*\*\*

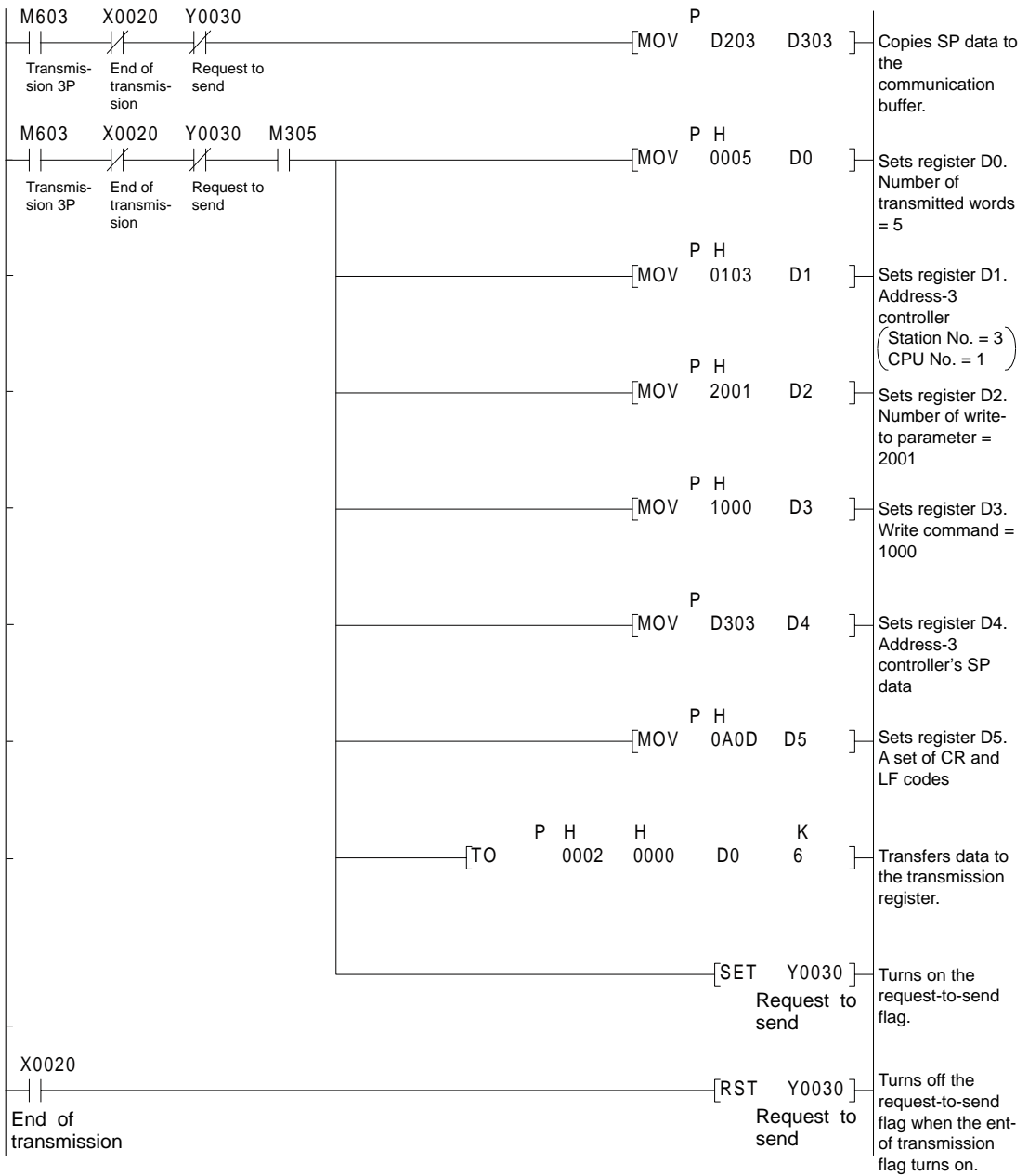

# 5. MODBUS Communication

## 5.1 Overview

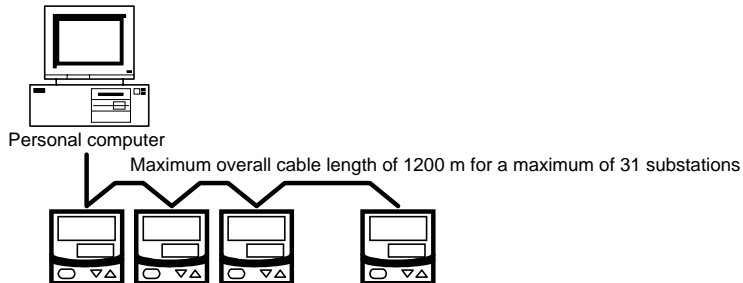

**Figure 5-1 Connection of Slaves in MODBUS Communication**

Use of the MODBUS communication enables UT100 Series to communicate with a wide variety of devices such as PCs. In this communication, you use such device to read/write data from/into D registers, (internal registers) of the UT100 Series.

Hereafter, PCs are generally called “host devices.”



### See Also

Chapter 6 or 8 for information on the D registers.

For the MODBUS communication of the UT100 Series, we provide the ASCII mode (ASCII system) and RTU mode (binary system) for the communication mode.

**Table 5-1 ASCII and RTU Modes**

Item	ASCII Mode	RTU Mode
Number of data bits	7 bits (ASCII)	8 bits (binary)
Message start mark	: (colon)	Not necessary
Message end mark	CR + LF	Not necessary
Length of message (Note 1)	$2N + 1$	N
Data time intervals	1 second or less	24 bit time or less (Note 2)
Error detection	Longitudinal redundancy check: LRC	Cyclic redundancy check: CRC-16

Note 1: When the length of a message in the RTU mode, it is assumed to be “N.”

Note 2: When the communication rate is 9600 bps,  $1 \div 9600 \times 24$  sec or less.

In the MODBUS communication, a host device identifies each UT100 Series with a communication address of 1 to 99. Some of the commands used let you specify broadcast that requires no address numbers. For more information on broadcast specifications, see subsection 5.2.2.

### 5.1.1 Configuration of Message

Messages sent from a host device to UT100 Series, consists of the following elements.

Element	Start of Message Mark	Address Number (ADR)	Function Code	Data	Error Check	End of Message Mark
Number of bytes in RTU mode	None	1	1	2n	2	None
Number of bytes in ASCII mode	1	2	2	4n	2	2
	(1)	(2)	(3)	(4)	(5)	(6)

#### (1) Start of Message Mark

This mark indicates the start of a message. Note that only ASCII mode requires the colon.

#### (2) Address Number (1 to 99)

Address numbers are used by host devices to identify the UT100 Series at the communication destination. (These numbers are identification numbers specific to individual UT100 Series.)

#### (3) Function Code (See subsection 3.2.1, List of Function Codes)

The function code specifies a command (function code) from the host device.

#### (4) Data

This element specifies D register numbers, the number of D registers, parameter values, and so on in accordance with the function code.

#### (5) Error Check

In RTU mode Carried out by the cyclic redundancy check (CRC-16) system.

In ASCII mode Carried out by the longitudinal redundancy check (LRC) system.

#### (6) End of Message Mark

This mark indicates the end of a message.

Note that only ASCII mode requires CR + LF

#### ● Message format for communication

Example: When setting the target setpoint “50.0” to a UT100 Series, the host device sends message data (01F4) into a value of “500” converted into hexadecimal not including the decimal point (thus, this is true for sending both 5.00 or 500).

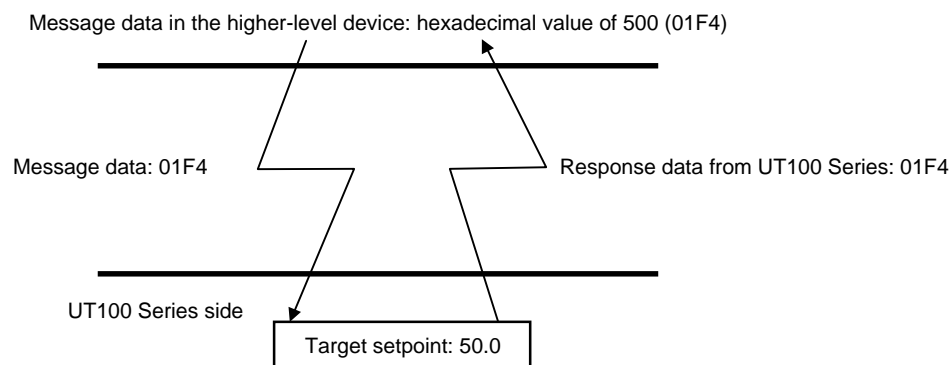

\* The position of the decimal point for “500” is determined by the DP (position of decimal point) parameter of the UT100 Series.

## 5.2 Communication with Host Device

The specification of D registers for a message using commercially available SCADA or the like and specification of D registers for a message in customer-created communication programs are different from simple specification of D register numbers. Thus, care should be taken.

- (1) When using commercially available SCADA or the like, specify the D register numbers by changing them into reference numbers. D register numbers whose “D” leading character is replaced with “4,” are treated as reference numbers. (When using a DDE server or others, specify these reference numbers.)
- (2) For communication programs created by the customer, specify registers using the hexadecimal numbers of values that are obtained by subtracting “40001” from the reference numbers. (Thus, hexadecimal numbers are those to be specified.)

Example: To specify target setpoint “D0120”:

- (1) For a message using commercially available SCADA or the like, specify reference number “40120.”
- (2) For a message in a customer-created communication program, specify the hexadecimal number, or 0077, of a value (0119) obtained by subtracting 40001 from the reference number.

### 5.2.1 List of Function Codes

Function codes are command words used by the host device to obtain the D register information of UT100 Series.

**Table 5-2 List of Function Codes**

Code Number	Function	Description
03	Reads data from multiple D registers.	Capable of reading data from a maximum of 32 successive D registers between D0001 and D0421.
06	Writes data into D register.	Capable of writing data to one D register between D0101 and D0421.
08	Performs loop back test.	See subsection 5.2.3, “Function Codes.”
16	Writes data into multiple D registers.	Capable of writing data into a maximum of 32 successive D registers between D0101 and D0421.

- A write using the function code is not possible for read-only or disabled D registers.
- Broadcast can be specified for function codes 06 and 16 only.

## 5.2.2 Specifying Broadcast

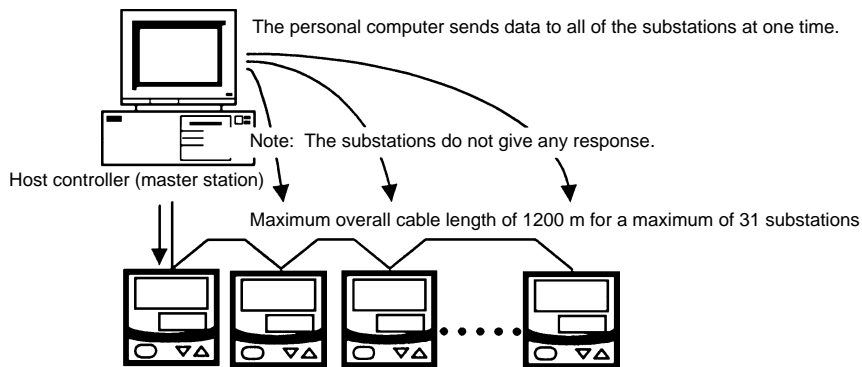

**Figure 5-2 Specifying Broadcast**

Broadcast is a feature in which all connected UT100 Series can receive the command concerned. Specifying the number in Table 5-3 at the location of the address number in a message enables the host device to write data into the D registers of all UT100 Series.

**Table 5-3 Broadcast Specification Number**

Number to be Specified in ADR	Applicable Devices
00	UT 100 Series

### 5.2.3 Function Codes

#### 03 Reads data from multiple D registers.

##### ● Function

This function code reads the contents of successive D registers by the specified number of them starting at a specified D register number.

- The maximum number of D registers to be read at a time is 32.
- For the format of responses in the event of failure, see subsection 5.2.4.

##### ● Message (for normal operation)

Element	Start of Message Mark (:)	Address Number (ADR)	Function Code (03)	D-Register Start Number (Upper Digit)	D-Register Start Number (Lower Digit)
Number of bytes in RTU mode	None	1	1	1	1
Number of bytes in ASCII mode	1	2	2	2	2

Message (continued)

Number of D Registers (Upper Digit)	Number of D Registers (Lower Digit)	Error Check	End of Message Mark (CR + LF)
1	1	2	None
2	2	2	2

##### ● Response (for normal operation)

Element	Start of Message Mark (:)	Address Number (ADR)	Function Code (03)	Byte Count	Contents of D-Register (Upper Digit)	Contents of D-Register (Lower Digit)	...
Number of bytes in RTU mode	None	1	1	1	1	1	...
Number of bytes in ASCII mode	1	2	2	2	2	2	...

Response (continued)

Contents of D Registers (Upper Digit)	Contents of D Registers (Lower Digit)	Error Check	End of Message Mark (CR + LF)
1	1	2	None
2	2	2	2

● **Example:** Reading the statuses of alarms 1 and 2 from the UT100 Series with address number 17. The following message reads four successive D registers starting at alarm 1 (D0101) and address number 17 in the ASCII mode.

[Message] [ : ]11030064000286[CR][LF]

↑  
Start of message mark

“11”: address number 17, “03”: function code 03, “0064”: D register address 0101, “0002”: number of D registers 2, and “86”: error check

\* Numbers in quotation marks are hexadecimal.

The following response is returned with respect to the above message.

[Response] [ : ]110308005A000A84[CR][LF]

↑     ↙  
Setting of alarm1, alarm2

“04”: byte count, “005A”: alarm 1 setpoint 90, “000A”: alarm 2 setpoint 10

## 16 Writes data into D registers.

### ● Function

This function code writes data into successive D registers by the number of specified D registers from a specified D register number.

- The maximum number of D registers into which data is written at a time is 32.
- For the format of response in the event of failure, see subsection 5.2.4.
- Lets you specify broadcast (by setting “00” to the address number).

### ● Message (for normal operation)

Element	Start of Message Mark (:)	Address Number (ADR)	Function Code (10)	D-Register Start Number (Upper Digit)	D-Register Start Number (Lower Digit)
Number of bytes in RTU mode	None	1	1	1	1
Number of bytes in ASCII mode	1	2	2	2	2

Message (continued)

Number of D Registers (Upper Digit)	Number of D Registers (Lower Digit)	Byte Count	Data (Upper Digit)	Data (Lower Digit)	...	Error Check	End of Message Mark (CR + LF)
1	1	1	1	1	...	2	None
2	2	2	2	2	...	2	2

### ● Response (for normal operation)

Element	Start of Message Mark (:)	Address Number (ADR)	Function Code (10)	D-Register Start Number (Upper Digit)	D-Register Start Number (Lower Digit)
Number of bytes in RTU mode	None	1	1	1	1
Number of bytes in ASCII mode	1	2	2	2	2

Response (continued)

Number of D Registers (Upper Digit)	Number of D Registers (Lower Digit)	Error Check	End of Message Mark (CR + LF)
1	1	2	None
2	2	2	2

- **Example:** Setting a proportional band of 200, an integral time of 10, and a derivative time of 3 to UT100 Series with address number 02.

The following message writes values 200, 10, and 3 in this order in the ASCII mode, starting at the proportional band (D0105) of address number 02.

[Message] [ : ]0210006800030600C8000A0003A8[CR][LF]

↑  
Start of message mark

“02”: address number 02, “10”: function code 16, “0068”: starts register address 0105, “0003”: number of D registers 3, “06”: byte count, “00C8”: proportional band’s value 200, “000A”: integral time 10, “0003”: derivative time 3, and “A8”: error check

\* Numbers in quotation marks are hexadecimal.

The following response is returned with respect to the above message.

[Response] [ : ]02100068000383[CR][LF]

↑  
Number of D registers: 3







## 5.2.4 Response Error Codes

### ● Message Format in the Event of Error

If there is any inconsistency other than communication errors in a message, UT100 Series does nothing, but returns the following message.

Element	Address Number (ADR)	Function Code*	Error Code	Error Check
Number of bytes in RTU mode	1	1	1	2
Number of bytes in ASCII mode	2	2	2	2

\* The function code contains a function code (hexadecimal number) + 80 (hexadecimal number).

### ● Error Codes in Response

**Table 5-4 List of Error Codes**

Error Code	Meaning	Description
01	Function code error	No function code exists.
02	D-register address error	Address out of the range has been specified.
03	D-register count error	Number of D registers has been specified, being out of the range.

### ● Even when a message is sent, no response returns if:

- Retransmission error (overrun, framing, parity, LRC, or CRC-16 error) was detected.
- Address in an instructed message is incorrect.
- Interval between data composing a message was 1 second or more.
- Broadcast is specified (address number: 00).

\* As a measure against those, provide a timeout process in the communication functions of a higher-level device or in communication programs.



# 6. Functions and Usage of D Registers (UT130, UT150/UT152/UT155)

## 6.1 Overview of D Registers

This section explains the functions and usage of D registers.

The D registers store the parameter data, flag data and process data that are handled by UT100 Series controller. By connecting UT100 Series controller to host device equipment capable of PC link communication, Ladder communication or MODBUS communication, you can readily use these internal data items by reading from or writing to the D registers.

Using the D registers, you can perform:

- Centralized control using host device
- Data exchange by reading/writing using host device

## 6.2 Interpretation of Lists of D Registers (D Register Map Tables)

This section explains how to read the “D Register Map” tables in this chapter. In the example shown below, the number in the leftmost column denotes (1) D register number. The five-digit number in the column on the immediate right of the leftmost column represents (2) Reference number for MODBUS communication. The number in the column third from left is (3) Register number (hexadecimal) for the MODBUS communication program. Each register code name in the D Register Map tables represents register name of specific process data item, operating parameter, setup parameter or other data items such as flags. For details on the operating and setup parameters, see *UT100 Series Temperature Controller user’s manual* (IM 05C01E02-01E / IM 05C01E12-01E).

Name of D Register Map				
D-Reg No.	Ref No.	H No.	Register name	R/W
D0001	40001	0000	STATUS	* R

(1) D register number

(2) Reference number (for MODBUS communication)

(3) Hex number (for MODBUS communication)

Reading/writing via communication (R: reading; W: writing)

An asterisk (\*) indicates that the number of writing actions is limited to 100,000 times.

## 6.3 Classification of D Registers

### ■ Classification of D Register Map Tables

The table below outlines how the D registers are classified by their numbers in the D Register Map tables.

**Table 6-1 Classification of D Registers**

Register No.	Area and Data Categories		Description	Reference
D0001 to 0010	Process data area (Note 1)	Operating data	PV, SV, MV and other values	Section 6.4
D0401 to 0420	User area (Note 2), represented by shaded section in the table (■)	—	Used for communication with the host device.	Section 6.4
D0011 to 0100 D0121 to 0200 D0216 to 0300 D0313 to 0400	Must not be used.			
D0101 to 0120	Operating parameters area (Note 1)	Operating parameter	P, I, D, etc.	Section 6.4
D0201 to 0215	Setup parameters area (Note 1)	Setup parameter	AL, HY etc.	Section 6.4
D0301 to 0312				

Note 1: Data for process values, operating parameters and setup parameters are stored as the types (EU, EUS, % and ABS without the decimal point) indicated in the "Operating Parameters" and the "Setup Parameters" of the *UT100 Series Temperature Controller* user's manual. The OFF and ON states are represented by 0 and 1, respectively. The D registers D0401 to 0420 are read-only.

Note 2: The user area (register numbers D0401 to 0420) is reserved for 16-bit register data used in other software programs. When working with host device, do not write to or read from this area as usually done.



### NOTE

No data may be written to or read from data storage areas with blank fields in the tables that follow. If you attempt to do so, UT100 Series controller may fail to operate correctly.

## 6.4 Register Map Table

Area for Process Data									
D-Reg No.	Ref No.	H No.	Register Name	R/W	D-Reg No.	Ref No.	H No.	Register Name	R/W
D0001	40001	0000	STATUS	R	D0216 to 0300				
D0002	40002	0001	PV	R	D0301	40301	012C	IN	*R/W
D0003	40003	0002	CSP	R	D0302	40302	012B	DP	*R/W
D0004	40004	0003	OUT	R	D0303	40303	012E	RH	*R/W
D0005	40005	0004	HOUT	R	D0304	40304	012F	RL	*R/W
D0006	40006	0005	COUT	R	D0305	40305	0130	SPH	*R/W
D0007	40007	0006	HC	R	D0306	40306	0131	SPL	*R/W
D0008	40008	0007	T1	R	D0307	40307	0132	TMU	*R/W
D0009	40009	0008	T2	R	D0308	40308	0133	DIS	*R/W
D0010	40010	0009	SPNO	R	D0309	40309	0134	EOT	*R/W
D0011 to 0100					D0310	40310	0135	TTU	*R/W
D0101	40101	0064	A1	*R/W	D0311	40311	0136	RTH	*R/W
D0102	40102	0065	A2	*R/W	D0312	40312	0137	RTL	*R/W
D0103	40103	0066	CTL	*R/W	D0313 to 0400				
D0104	40104	0067	AT	*R/W	D0401	40401	0190		R/W
D0105	40105	0068	P	*R/W	D0402	40402	0191		R/W
D0106	40106	0069	I	*R/W	D0403	40403	0192		R/W
D0107	40107	006A	D	*R/W	D0404	40404	0193		R/W
D0108	40108	006B	MR	*R/W	D0405	40405	0194		R/W
D0109	40109	006C	COL	*R/W	D0406	40406	0195		R/W
D0110	40110	006D	DB	*R/W	D0407	40407	0196		R/W
D0111	40111	006E	HYS	*R/W	D0408	40408	0197		R/W
D0112	40112	006F	CT	*R/W	D0409	40409	0198		R/W
D0113	40113	0070	CTC	*R/W	D0410	40410	0199		R/W
D0114	40114	0071	SP1	*R/W	D0411	40411	019A		R/W
D0115	40115	0072	SP2	*R/W	D0412	40412	019B		R/W
D0116	40116	0073	FL	*R/W	D0413	40413	019C		R/W
D0117	40117	0074	BS	*R/W	D0414	40414	019D		R/W
D0118	40118	0075	LOC	*R/W	D0415	40415	019E		R/W
D0119					D0416	40416	019F		R/W
D0120	40120	0077	CSP1	R/W	D0417	40417	01A0		R/W
D0121 to 0200					D0418	40418	01A1		R/W
D0201	40201	00C8	UPR	*R/W	D0419	40419	01A2		R/W
D0202	40202	00C9	DNR	*R/W	D0420	40420	01A3		R/W
D0203	40203	00CA	AL1	*R/W					
D0204	40204	00CB	AL2	*R/W					
D0205	40205	00CC	HY1	*R/W					
D0206	40206	00CD	HY2	*R/W					
D0207	40207	00CE	SC	*R/W					
D0208	40208	00CF	DR	*R/W					
D0209	40209	00D0	DSP	*R/W					
D0210	40210	00D1	PSL	*R/W					
D0211	40211	00D2	ADR	*R/W					
D0212	40212	00D3	BPS	*R/W					
D0213	40213	00D4	PRI	*R/W					
D0214	40214	00D5	STP	*R/W					
D0215	40215	00D6	DLN	*R/W					

Shaded areas  indicate a user area (D-register numbers D0401 to D0420). These registers are not available if the host device.

An asterisk ( \* ) indicates that the number of writing actions is limited to 100,000 times

## 6.4.1 D Register Contents

D registers are designed to indicate two or more events, such as errors and parameter data, using combinations of bits within them. If any of the events shown in the following tables occurs, the corresponding bit is set to 1. The bit remains set to 0 if the event has not occurred yet. Note that bits in blank fields are not in use.

### ● D0001 Register-Bit Configuration of STATUS (Input Error)

Bit	Code	Event
0	ALM1.st	'1' if alarm 1 is on, or '0' if off
1	ALM2.st	'1' if alarm 2 is on, or '0' if off
2	0	
3	0	
4	PV+over.st	PV above the upper limit of scale
5	PV-over.st	PV below the lower limit of scale
6	BO.st	Burn-out error
7	0	
8	SYSTEM.E.st	Error in system data
9	CALB.E.st	Error in calibrated values
10	PARA.E.st	Error in operating parameters
11	0	
12	ADERR.st	Error in A/D Converter
13	RJCERR.st	RJC error in PV
14	EEP.E.st	Error in EEPROM
15	0	

### ● D0002 Register - PV (Measured input value)

### ● D0003 Register - CSP (Currently used target Setpoint)

### ● D0004 Register - OUT (Control output)

- For PID computations, this register, for example, takes the value “750” if the result of computation is 75%.
- For on-off computations, this register contains a reading of 0 (0.0%) for the OFF state or 1000 (100.0%) for the ON state.

### ● D0005 Register - HOUT (Heating-side control output)

### ● D0006 Register - COUT (Cooling-side control output)

### ● D0007 Register - HC (Heater current measured value)

### ● D0008 and D0009 Registers - T1 and T2 (Remaining Time Display)

These registers give the readings of the amount of time, in units of seconds, remaining until the setpoints in the A1 and A2 registers are reached.

Example: The reading for one hour, 38 minutes and 57 seconds is given as 5,937 seconds. (These registers are only effective if “23” or “24” is selected for the AL1 and AL2 registers.)

### ● D0010 Register - SPNO (Target setpoint number selection)

### ● D0101 and D0102 Registers - A1 and A2 (Alarm or Timer Setpoints)

If either “23” or “24” is set in the AL1 and AL2 registers, the value is used as the setpoint for the timer in units of seconds. If a value other than “23” and “24” is set, it is used as the alarm setpoint.

### ● D0108 Register - MR (Manual Reset)

When using the UT130's heating/cooling type, UT100 controller doesn't show the decimal point for display. But the decimal point is effective via communication.

For example takes the value “0250” if the result is 25%.



● **D0120 Register - CSP1 (Target Setpoint for Writing via Communication Only)**

This target setpoint is for writing via communication only and is effective only if the SP1 register is selected. Use this D register when you want to have access to target setpoints by means of communication. The same value written in this D register is also written in D0114:SP1. This register isn't backup for power failure.



# 7. Functions and Usage of I Relays (UT130, UT150/UT152/UT155)

This chapter explains the functions and usage of the I relays.

The I relays contain information on errors in UT100 Series controller, as well as the controller's alarm statuses. By connecting the UT100 Series controller to host device (via PC communication link), you can read these internal data items from the I relays to use for your own particular purpose. (Note that most of the I relays have the same functions as the D registers.)

## 7.1 Status I Relays

The following table summarizes how the on-off status I relays are classified.

I Relay No.	Data Category	Description	Remarks
1 to 16	On-off statuses	Error information (same as data in the D0001 register)	Information stored in each group of these I relays is represented by the four sets of binary codes, from 0000 (0 in the decimal system) to 1000 (8 in the decimal system), which are formed by each combination of four I relays. The lowest-numbered I relay in each set signifies the LSB of the four bits.
17 to 48	Read/Write	User area (Data can be written to or read from the range of I relays)	



### NOTE

The I relays numbered 1 to 16 store on-off status information. In normal operation, this area can be accessed to read the on-off status.

When specifying an I relay number via communication, begin the number with an upper-case letter I. For example, type I0014 to specify the RJCERR.st relay (I relay numbered 14).

No data may be written to or read from data storage areas with blank fields in the tables that follow. If you attempt to do so, UT100 Series controller may fail to operate correctly.

Area of I Relays									
No.	I Relay Name Code	No.	I Relay Name Code	No.	I Relay Name Code	No.	I Relay Name Code	No.	I Relay Name Code
1	ALM1.st	9	SYSTEM.E.st	17	UR1	25	UR9	33	UR17
2	ALM2.st	10	CALB.E.st	18	UR2	26	UR10	34	UR18
3		11	PARA.E.st	19	UR3	27	UR11	35	UR19
4		12		20	UR4	28	UR12	36	UR20
5	PV+over.st	13	ADERR.st	21	UR5	29	UR13	37	UR21
6	PV-over.st	14	RJCERR.st	22	UR6	30	UR14	38	UR22
7	BO.st	15	EEPE.st	23	UR7	31	UR15	39	UR23
8		16		24	UR8	32	UR16	40	UR24
								41	UR25
								42	UR26
								43	UR27
								44	UR28
								45	UR29
								46	UR30
								47	UR31
								48	UR32



# 8. Functions and Usage of D Registers (UP150)

## 8.1 Overview of D Registers

This section explains the functions and usage of D registers.

The D registers store the parameter data, flag data and process data that are handled by UT100 Series controller. By connecting UP150 controller to host device equipment capable of PC link communication, Ladder communication or MODBUS communication, you can readily use these internal data items by reading from or writing to the D registers.

Using the D registers, you can perform:

- Centralized control using host device
- Data exchange by reading/writing using host device

## 8.2 Interpretation of Lists of D Registers (D Register Map Tables)

This section explains how to read the “D Register Map” tables in this chapter. In the example shown below, the number in the leftmost column denotes (1) D register number. The five-digit number in the column on the immediate right of the leftmost column represents (2) Reference number for MODBUS communication. The number in the column third from left is (3) Register number (hexadecimal) for the MODBUS communication program. Each register code name in the D Register Map tables represents register name of specific process data item, operating parameter, setup parameter or other data items such as flags. For details on the operating and setup parameters, see *Model UP150 Program Temperature Controller* user’s manual (IM 05C01F12-01E).

Name of D Register Map				
D-Reg No.	Ref No.	H No.	Register name	R/W
D0001	40001	0000	STATUS	* R

(1) D register number

(2) Reference number (for MODBUS communication)

(3) Hex number (for MODBUS communication)

Reading/writing via communication (R: reading; W: writing)

An asterisk (\*) indicates that the number of writing actions is limited to 100,000 times.

## 8.3 Classification of D Registers

### ■ Classification of D Register Map Tables

The table below outlines how the D registers are classified by their numbers in the D Register Map tables.

**Table 8-1 Classification of D Registers**

Register No.	Area and Data Categories		Description	Reference
D0001 to 0010	Process data area (Note 1)	Operating data	PV, SV, MV and other values	Section 8.4
D0401 to 0420	User area (Note 2), represented by shaded section in the table (■)	—	Used for communication with the host device.	Section 8.4
D0012 to 0102 D0124 to 0206 D0264 to 0300 D0313 to 0400	Must not be used.			
D0103 to 0123	Operating parameters area (Note 1)	Operating parameter	P, I, D, etc.	Section 8.4
D0207 to 0215 D0301 to 0312	Setup parameters area (Note 1)	Setup parameter	PSL, IN etc.	Section 8.4
D0216 to 0263	Program parameters area (Note 1)	Program parameter	EV, AL etc.	Section 8.4

Note 1: Data for process values, operating parameters, setup parameters and program parameters are stored as the types (EU, EUS, % and ABS without the decimal point) indicated in the "Operating Parameters" and the "Setup Parameters" of the *Model UP150 Program Temperature Controller* user's manual. The OFF and ON states are represented by 0 and 1, respectively. The D registers D0401 to 0420 are read-only.

Note 2: The user area (register numbers D0401 to 0420) is reserved for 16-bit register data used in other software programs. When working with host device, do not write to or read from this area as usually done.



### NOTE

No data may be written to or read from data storage areas with blank fields in the tables that follow. If you attempt to do so, UT100 Series controller may fail to operate correctly.

## 8.4 Register Map Table

Area for Process Data									
D-Reg No.	Ref No.	H No.	Register Name	R/W	D-Reg No.	Ref No.	H No.	Register Name	R/W
D0001	40001	0000	STATUS	R	D0220	40220	00DB	EON1	*R/W
D0002	40002	0001	PV	R	D0221	40221	00DC	EOF1	*R/W
D0003	40003	0002	CSP	R	D0222	40222	00DD	EV2	*R/W
D0004	40004	0003	OUT	R	D0223	40223	00DE	AL2	*R/W
D0005					D0224	40224	00EF	A2	*R/W
D0006					D0225	40225	00E0	HY2	*R/W
D0007					D0226	40226	00E1	EON2	*R/W
D0008	40008	0007	SEGTIME	R	D0227	40227	00E2	EOF2	*R/W
D0009					D0228	40228	00E3	SSP	*R/W
D0010	40010	0009	SEGNO	R	D0229	40229	00E4	SP1	*R/W
D0011	40011	000A	MODE	R	D0230	40230	00E5	TM1	*R/W
D0012 to 0102	Must not be used.				D0231	40231	00E6	SP2	*R/W
D0103	40103	0066	CTL	*R/W	D0232	40232	00E7	TM2	*R/W
D0104	40104	0067	AT	*R/W	D0233	40233	00E8	SP3	*R/W
D0105	40105	0068	P	*R/W	D0234	40234	00E9	TM3	*R/W
D0106	40106	0069	I	*R/W	D0235	40235	00EA	SP4	*R/W
D0107	40107	006A	D	*R/W	D0236	40236	00EB	TM4	*R/W
D0108	40108	006B	MR	*R/W	D0237	40237	00EC	SP5	*R/W
D0109					D0238	40238	00ED	TM5	*R/W
D0110					D0239	40239	00EE	SP6	*R/W
D0111	40111	006E	HYS	*R/W	D0240	40240	00EF	TM6	*R/W
D0112	40112	006F	CT	*R/W	D0241	40241	00F0	SP7	*R/W
D0113					D0242	40242	00F1	TM7	*R/W
D0114					D0243	40243	00F2	SP8	*R/W
D0115					D0244	40244	00F3	TM8	*R/W
D0116	40116	0073	FL	*R/W	D0245	40245	00F4	SP9	*R/W
D0117	40117	0074	BS	*R/W	D0246	40246	00F5	TM9	*R/W
D0118	40118	0075	LOC	*R/W	D0247	40247	00F6	SP10	*R/W
D0119					D0248	40248	00F7	TM10	*R/W
D0120					D0249	40249	00F8	SP11	*R/W
D0121	40121	0078	RUN/RESET	R/W	D0250	40250	00F9	TM11	*R/W
D0122	40122	0079	HOLD	R/W	D0251	40251	00FA	SP12	*R/W
D0123	40123	007A	ADV	R/W	D0252	40252	00FB	TM12	*R/W
D0124 to 0206	Must not be used.				D0253	40253	00FC	SP13	*R/W
D0207	40207	00CE	SC	*R/W	D0254	40254	00FD	TM13	*R/W
D0208	40208	00CF	DR	*R/W	D0255	40255	00FE	SP14	*R/W
D0209					D0256	40256	00FF	TM14	*R/W
D0210	40210	00D1	PSL	*R/W	D0257	40257	0100	SP15	*R/W
D0211	40211	00D2	ADR	*R/W	D0258	40258	0101	TM15	*R/W
D0212	40212	00D3	BPS	*R/W	D0259	40259	0102	SP16	*R/W
D0213	40213	00D4	PRI	*R/W	D0260	40260	0103	TM16	*R/W
D0214	40214	00D5	STP	*R/W	D0261	40261	0104	JC	*R/W
D0215	40215	00D6	DLN	*R/W	D0262	40262	0105	WTZ	*R/W
D0216	40216	00D7	EV1	*R/W	D0263	40263	0106	STC	*R/W
D0217	40217	00D8	AL1	*R/W	D0264 to 0300	Must not be used.			
D0218	40218	00D9	A1	*R/W	D0301	40301	012C	IN	*R/W
D0219	40219	00DA	HY1	*R/W	D0302	40302	012D	DP	*R/W

Shaded areas  indicate a user area (D-register numbers D0401 to D0420). These registers are not available if the host device.

An asterisk ( \* ) indicates that the number of writing actions is limited to 100,000 times

Area for Process Data									
D-Reg No.	Ref No.	H No.	Register Name	R/W	D-Reg No.	Ref No.	H No.	Register Name	R/W
D0303	40303	012E	RH	*R/W	D0401	40401	0190		R/W
D0304	40304	012F	RL	*R/W	D0402	40402	0191		R/W
D0305	40305	0130	SPH	*R/W	D0403	40403	0192		R/W
D0306	40306	0131	SPL	*R/W	D0404	40404	0193		R/W
D0307	40307	0132	TMU	*R/W	D0405	40405	0194		R/W
D0308					D0406	40406	0195		R/W
D0309					D0407	40407	0196		R/W
D0310					D0408	40408	0197		R/W
D0311	40311	0136	RTL	*R/W	D0409	40409	0198		R/W
D0312	40312	0137	RTH	*R/W	D0410	40410	0199		R/W
D0313 to 0400	Must not be used.				D0411	40411	019A		R/W
					D0412	40412	019B		R/W
					D0413	40413	019C		R/W
					D0414	40414	019D		R/W
					D0415	40415	019E		R/W
					D0416	40416	019F		R/W
					D0417	40417	01A0		R/W
					D0418	40418	01A1		R/W
					D0419	40419	01A2		R/W
					D0420	40420	01A3		R/W

Shaded areas  indicate a user area (D-register numbers D0401 to D0420). These registers are not available if the host device.

An asterisk ( \* ) indicates that the number of writing actions is limited to 100,000 times



### 8.4.1 D Register Contents

D registers are designed to indicate two or more events, such as errors and parameter data, using combinations of bits within them. If any of the events shown in the following tables occurs, the corresponding bit is set to 1. The bit remains set to 0 if the event has not occurred yet. Note that bits in blank fields are not in use.

● **D0001 Register-Bit Configuration of STATUS (Input Error)**

Bit	Code	Event
0	EV1.st	'1' if event 1 is on, or '0' if off
1	EV2.st	'1' if event 2 is on, or '0' if off
2	0	
3	0	
4	PV+over.st	PV above the upper limit of scale
5	PV-over.st	PV below the lower limit of scale
6	BO.st	Burn-out error
7	0	
8	SYSTEM.E.st	Error in system data
9	CALB.E.st	Error in calibrated values
10	PARA.E.st	Error in operating parameters
11	0	
12	ADERR.st	Error in A/D Converter
13	RJCERR.st	RJC error in PV
14	EEP.E.st	Error in EEPROM
15	0	

● **D0002 Register - PV (Measured input value)**

● **D0003 Register - CSP (Currently used target Setpoint)**

● **D0004 Register - OUT (Control output)**

- For PID computations, this register, for example, takes the value "750" if the result of computation is 75%.
- For on-off computations, this register contains a reading of 0 (0.0%) for the OFF state or 1000 (100.0%) for the ON state.

● **D0010 Register - SEGNO (Program segment number selection)**

● **D0011 Register-bit Configuration of MODE (Operating mode)**

Bit	Code	Event
0	RUN.st	'1' if program operation is run, or '0' if reset
1	RESET.st	'1' if program operation is reset, or '0' if run
2	0	
3	0	
4	HOLD.st	'1' if hold operation is on, or '0' if off
5	WAIT.st	'1' if wait operation is on, or '0' if off
6 to 15	0	

● **D0230 to 0260 Register - TM1 to TM16 (Segment time)**

● **D0261 Register - JC (Junction code)**

● **D0262 Register - WTZ (Wait zone)**

● **D0263 Register - STC (Start code)**



# 9. Functions and Usage of I Relays (UP150)

This chapter explains the functions and usage of the I relays.

The I relays contain information on errors in UP150 controller, as well as the controller's alarm statuses. By connecting the UP150 controller to host device (via PC communication link), you can read these internal data items from the I relays to use for your own particular purpose. (Note that most of the I relays have the same functions as the D registers.)

## 9.1 Status I Relays

The following table summarizes how the on-off status I relays are classified.

I Relay No.	Data Category	Description	Remarks
1 to 16	On-off statuses	Error information (same as data in the D0001 register)	Information stored in each group of these I relays is represented by the four sets of binary codes, from 0000 (0 in the decimal system) to 1000 (8 in the decimal system), which are formed by each combination of four I relays. The lowest-numbered I relay in each set signifies the LSB of the four bits.
	Read/Write		
49 to 54	On-off statuses	Operation mode (same as D0011)	



### NOTE

The on-off status I relays numbered 1 to 16 store on-off status information. In normal operation, this area can be accessed to read the on-off status.

When specifying an I relay number via communication, begin the number with an upper-case letter I. For example, type I0014 to specify the RJCERR.st relay (I relay numbered 14).

No data may be written to or read from data storage areas with blank fields in the tables that follow. If you attempt to do so, UT100 Series controller may fail to operate correctly.

Area of I Relays											
No.	I Relay Name Code	No.	I Relay Name Code	No.	I Relay Name Code	No.	I Relay Name Code	No.	I Relay Name Code		
1	EV1.st	11	PARA.E.st	21	UR5	31	UR15	41	UR25	51	
2	EV2.st	12		22	UR6	32	UR16	42	UR26	52	
3		13	ADERR.st	23	UR7	33	UR17	43	UR27	53	HOLD
4		14	RJCERR.st	24	UR8	34	UR18	44	UR28	54	WAIT
5	PV+over.st	15	EEPE.st	25	UR9	35	UR19	45	UR29	55	
6	PV-over.st	16		26	UR10	36	UR20	46	UR30	56	
7	BO.st	17	UR1	27	UR11	37	UR21	47	UR31		
8		18	UR2	28	UR12	38	UR22	48	UR32		
9	SYSTEM.E.st	19	UR3	29	UR13	39	UR23	49	RUN		
10	CALB.E.st	20	UR4	30	UR14	40	UR24	50	RESET		



# Appendix

## Table of ASCII Codes (Alphanumeric Codes)

In order to implement PC link communication, create a transmission/receiving program by referring to the following table of ASCII codes.

b8	b7	b6	b5	b4	b3	b2	b1		0	1	2	3	4	5	6	7
				0	0	0	0	<b>0</b>	NUL	DLE	SP	0	@	P	`	p
				0	0	0	1	<b>1</b>	SOH	DC1	!	1	A	Q	a	q
				0	0	1	0	<b>2</b>	STX	DC2	"	2	B	R	b	r
				0	0	1	1	<b>3</b>	ETX	DC3	#	3	C	S	c	s
				0	1	0	0	<b>4</b>	EOT	DC4	\$	4	D	T	d	t
				0	1	0	1	<b>5</b>	ENQ	NAK	%	5	E	U	e	u
				0	1	1	0	<b>6</b>	ACK	SYN	&	6	F	V	f	v
				0	1	1	1	<b>7</b>	BEL	ETB	'	7	G	W	g	w
				1	0	0	0	<b>8</b>	BS	CAN	(	8	H	X	h	x
				1	0	0	1	<b>9</b>	HT	EM	)	9	I	Y	i	y
				1	0	1	0	<b>A</b>	LF	SUB	*	:	J	Z	j	z
				1	0	1	1	<b>B</b>	VT	ESC	+	;	K	[	k	{
				1	1	0	0	<b>C</b>	FF	FS	,	<	L	¥	l	
				1	1	0	1	<b>D</b>	CR	GS	-	=	M	]	m	}
				1	1	1	0	<b>E</b>	SO	RS	.	>	N	•	n	~
				1	1	1	1	<b>F</b>	SI	US	/	?	O	_	o	DEL

Note:  
 SP (\$20): space  
 DEL (\$7F): control code

Control codes                      Character codes



# Revision Record

---

- Manual No. : IM 05C01E12-10E
- Title : UT100 Series Communication Functions

Edition	Date	Revised Item
First	Oct., 2000	Newly published
Second	Feb., 2001	Additional UP150
Third	Sep., 2003	Correct
Foruth	Jun., 2004	Change of the company name.

---

Written by Yokogawa Electric Corporation

Published by Yokogawa Electric Corporation  
2-9-32 Nakacho, Musashino-shi, Tokyo 180-8750, JAPAN

---







# YOKOGAWA

Yokogawa Electric Corporation

---

## YOKOGAWA ELECTRIC CORPORATION

### Network Solutions Business Division

2-9-32, Nakacho, Musashino-shi, Tokyo, 180-8750 JAPAN

Phone: +81-422-52-7179 Facsimile: +81-422-52-6793

### Sales Branch Offices

Tokyo, Nagoya, Osaka, Hiroshima, Fukuoka

---

## YOKOGAWA CORPORATION OF AMERICA

### Headquarters

2 Dart Road, Newnan, GA. 30265-1094 U.S.A.

Phone: +1-770-253-7000 Facsimile: +1-770-251-0928

Sales Branch Offices / Texas, Chicago, Detroit, San Jose

## YOKOGAWA EUROPE B. V.

### Headquarters

Databankweg 20, 3821 AL Amersfoort THE NETHERLANDS

Phone: +31-334-64-1611 Facsimile: +31-334-64-1610

Sales Branch Offices / Houten (The Netherlands), Wien (Austria), Zaventem (Belgium), Ratingen (Germany), Madrid (Spain), Bratislava (Slovakia), Runcorn (United Kingdom), Milano (Italy), Vélizy Villacoublay (France), Johannesburg (Republic of South Africa)

## YOKOGAWA AMERICA DO SUL S.A.

### Headquarters & Plant

Praca Acapulco, 31-Santo Amaro, Sao Paulo/SP, BRAZIL CEP-04675-190

Phone: +55-11-5681-2400 Facsimile: +55-11-5681-4434

## YOKOGAWA ENGINEERING ASIA PTE. LTD.

### Head office

5 Bedok South Road, Singapore 469270 SINGAPORE

Phone: +65-6241-9933 Facsimile: +65-6241-2606

## YOKOGAWA ELECTRIC KOREA CO., LTD.

### Seoul Sales office

395-70, Shindaebang-dong, Dongjak-gu, Seoul, 156-010, KOREA

Phone: +82-2-3284-3000 Facsimile: +82-2-3284-3019

## YOKOGAWA TAIWAN CORPORATION

### Head office

17F, No.39, Sec. 1, Chung Hwa Road Taipei, 100 TAIWAN

Phone: +886-2-2314-9166 Facsimile: +886-2-2314-9918

## YOKOGAWA AUSTRALIA PTY. LTD.

### Head office

Centre Court D1, 25-27 Paul Street North, North Ryde, N. S. W. 2113, AUSTRALIA

Phone: +61-2-9805-0699 Facsimile: +61-2-9888-1844

## YOKOGAWA INDIA LTD.

### Head office

40/4 Lavelle Road, Bangalore, 560 001, INDIA

Phone: +91-80-227-1513 Facsimile: +91-80-227-4270

## LTD. YOKOGAWA ELECTRIC

Grokholskiy per. 13, Build. 2, 4th Floor, 129010, Moscow, RUSSIA FEDERATION

Phone: +7-095-737-7868 Facsimile: +7-095-737-7869

---