

**Models DX2004T/DX2008T/DX2010T/DX2020T/
DX2030T/DX2040T/DX2048T**

**Daqstation DX2000T
Operation Guide**

前言

根据中华人民共和国电子信息产品污染防治管理对本产品进行了说明。

This is an explanation for the product based on "Control of pollution caused by Electronic Information Products" in the People's Republic of China.

中華人民共和國での電子情報製品の污染防治管理に基づき、製品について説明しています。

产品中有毒有害物质或元素的名称及含量

部件名称	有毒有害物质或元素					
	铅 Pb	汞 Hg	镉 Cd	六价铬 (Cr6+)	多溴联苯 PBB	多溴二苯醚 PBDE
LCD 显示器	×	×	×	○	○	○
印刷电路板配件	×	×	×	○	○	○
内部接线的材料	×	×	×	○	○	○
存储媒体驱动	×	×	×	○	○	○
箱体和底座						
塑料	×	×	×	○	○	○
金属	×	×	×	○	○	○
电源	×	×	×	○	○	○
操作键	×	×	×	○	○	○
附件 / 选配件	端子用螺钉	×	×	×	○	○
	电源线	×	×	×	○	○
	远程控制端子 438227	×	×	×	○	○
	安装支架 B9900BX	×	×	×	○	○
	操作面板锁定键 B8706FX	×	×	×	○	○
	CF 卡 772091, 772092, 772093, 772094, 772095	×	×	×	○	○
	CF 卡适配器 772090	×	×	×	○	○
	分流电阻 415920, 415921, 415922, 438920, 438921, 438922	×	×	×	○	○
<p>○：表示该部件的所有均质材料中的有毒有害物质或元素的含量均低于 GB/T 26752 标准所规定的限量要求。 ×：表示该部件中至少有一种均质材料中的有毒有害物质或元素的含量超过 GB/T 26752 标准所规定的限量要求。 本产品的部分部件包含 RoHS 指令中的限用物质，但是其使用方法不受该指令限制。 Some parts of this product include the restricted substances of RoHS Directive, but their applications are under the exemption of the directive. この製品の一部には RoHS 指令の規制物質が含まれていますが、その使用方法は指令の適用除外となっています。</p>						

环保使用期限



该标志为环境保护使用期限，根据 SJ/T11364，适用于在中国（台湾、香港、澳门除外）销售的电子电气产品。

只要您遵守该产品相关的安全及使用注意事项，在自制造日起算的年限内，则不会因产品中有有害物质泄漏或突变变异，而造成对环境的污染或对人体及财产产生恶劣影响

注）该年数为“环保使用期限”，并非产品的质量保证期。零件更换的推荐周期，请参照使用说明书

Heimdal

The password-management function of the following products uses Heimdal source code for AES authentication key generation. In accordance with the Heimdal license agreement, the copyright notice, redistribution conditions, and license are listed below.

以下产品的密码管理功能中的 AES 认证键生成部分使用 Heimdal 的源代码。根据 Heimdal 的授权，用原文（英文）记述了版权、发布条件及授权。

下記の製品のパスワード管理機能における AES 認証キー生成部は、Heimdal のソースコードを使用しています。Heimdal のライセンスにしたがい、コピーライト・配布条件およびライセンスを原文（英文）にて記載します。

DX1002, DX1004, DX1006, DX1012, DX1002N, DX1004N, DX1006N, DX1012N, DX2004, DX2008, DX2010, DX2020, DX2030, DX2040, DX2048, DX1002T, DX1004T, DX1006T, DX1012T, DX2004T, DX2008T, DX2010T, DX2020T, DX2030T, DX2040T, DX2048T, DXA120(DAQSTANDARD)

Copyright (c) 2006 Kungliga Tekniska Högskolan (Royal Institute of Technology, Stockholm, Sweden). All rights reserved.

Redistribution and use in source and binary forms, with or without modification, are permitted provided that the following conditions are met:

1. Redistributions of source code must retain the above copyright notice, this list of conditions and the following disclaimer.
2. Redistributions in binary form must reproduce the above copyright notice, this list of conditions and the following disclaimer in the documentation and/or other materials provided with the distribution.
3. Neither the name of the Institute nor the names of its contributors may be used to endorse or promote products derived from this software without specific prior written permission.

THIS SOFTWARE IS PROVIDED BY THE INSTITUTE AND CONTRIBUTORS "AS IS" AND ANY EXPRESS OR IMPLIED WARRANTIES, INCLUDING, BUT NOT LIMITED TO, THE IMPLIED WARRANTIES OF MERCHANTABILITY AND FITNESS FOR A PARTICULAR PURPOSE ARE DISCLAIMED. IN NO EVENT SHALL THE INSTITUTE OR CONTRIBUTORS BE LIABLE FOR ANY DIRECT, INDIRECT, INCIDENTAL, SPECIAL, EXEMPLARY, OR CONSEQUENTIAL DAMAGES (INCLUDING, BUT NOT LIMITED TO, PROCUREMENT OF SUBSTITUTE GOODS OR SERVICES; LOSS OF USE, DATA, OR PROFITS; OR BUSINESS INTERRUPTION) HOWEVER CAUSED AND ON ANY THEORY OF LIABILITY, WHETHER IN CONTRACT, STRICT LIABILITY, OR TORT (INCLUDING NEGLIGENCE OR OTHERWISE) ARISING IN ANY WAY OUT OF THE USE OF THIS SOFTWARE, EVEN IF ADVISED OF THE POSSIBILITY OF SUCH DAMAGE.

Expat

The report template function of the following products uses Expat source code for report creation. In accordance with the Heimdal license agreement, the copyright notice, redistribution conditions, and license are listed below.

以下产品的报表模板功能中的创建报表部分使用 Expat 的源代码。根据 Expat 的授权，用原文（英文）记述了版权、发布条件及授权。

以下の製品の帳票テンプレート機能における帳票作成部では、Expat のソースコードを使用しています。Expat のライセンスにしたがい、コピーライト・配布条件およびライセンスを原文（英文）にて記載します。

DX1002, DX1004, DX1006, DX1012, DX1002N, DX1004N, DX1006N, DX1012N, DX2004, DX2008, DX2010, DX2020, DX2030, DX2040, DX2048, DX1002G, DX1004G, DX1006G, DX1012G, DX1002T, DX1004T, DX1006T, DX1012T, DX2004T, DX2008T, DX2010T, DX2020T, DX2030T, DX2040T, DX2048T

Copyright (c) 1998, 1999, 2000 Thai Open Source Software Center Ltd

Permission is hereby granted, free of charge, to any person obtaining a copy of this software and associated documentation files (the "Software"), to deal in the Software without restriction, including without limitation the rights to use, copy, modify, merge, publish, distribute, sublicense, and/or sell copies of the Software, and to permit persons to whom the Software is furnished to do so, subject to the following conditions:

The above copyright notice and this permission notice shall be included in all copies or substantial portions of the Software.

THE SOFTWARE IS PROVIDED "AS IS", WITHOUT WARRANTY OF ANY KIND, EXPRESS OR IMPLIED, INCLUDING BUT NOT LIMITED TO THE WARRANTIES OF MERCHANTABILITY, FITNESS FOR A PARTICULAR PURPOSE AND NONINFRINGEMENT. IN NO EVENT SHALL THE AUTHORS OR COPYRIGHT HOLDERS BE LIABLE FOR ANY CLAIM, DAMAGES OR OTHER LIABILITY, WHETHER IN AN ACTION OF CONTRACT, TORT OR OTHERWISE, ARISING FROM, OUT OF OR IN CONNECTION WITH THE SOFTWARE OR THE USE OR OTHER DEALINGS IN THE SOFTWARE.

User Registration

Thank you for purchasing YOKOGAWA products.

We invite you to register your products in order to receive the most up to date product information. To register, visit the following URL.

<http://www.yokogawa.com/ns/reg/>

Contents

Introduction	3
Safety Precautions.....	4
Handling Precautions of the DX.....	5
Handling Precautions of the External Storage Medium (CF Card).....	5
Checking the Contents of the Package	5
Style number, release number, and firmware version number of the DX2000T	6
Protection of Environment	7
Conventions Used in This Manual	7
Revision History	7
Introduction to Functions	8
Measured Items	8
Data Storage Function.....	8
Display Function	8
Other Functions	8
DAQSTANDARD.....	8
DX System Configuration	9
Terminology	9
Names of Parts	10
DX2000T Workflow	12
Turning the Power ON/OFF.....	13
Turning the Power ON	13
Turning the Power OFF	13
Basic Operation	14
Panel Keys.....	14
Display	14
Display on the Status Display Section	15
Run Modes	16
Entering Values and Characters	16
Changing the Date/Time.....	18
Operation Example in the Setting Mode: Changing the Input Range	19
Operation Example in the Basic Setting Mode: Changing the Scan Interval.....	22
⚠ Inserting/Removing a CF Card	24
Saving the Setup Data	26
Loading the Setup Data	27
Setting the Input Range and Alarm.....	28
Setup Example 1: Temperature Measurement Channel.....	28
Setup Example 2: Flow Rate Measurement Channel and Alarm.....	29
Setting the Display	30
Setup Example 3: Assigning Channels to Groups	30
Setup Example 4: Setting the Time Scale	31
Setting the Data Storage.....	32
Setup Example 5: Continuously Record Measured Data and Automatically Save	32
Setup Example 6: Saving Measured Data at the Specified Time	35
Customizing the Operation.....	36
Setup Example 7: Assigning the Screen Image Data Storage Function to the USER key	36

Contents

Setup Example 8: Registering Frequently Used Screens to the Favorite Key	37
Touch Panel Operations	39
Displaying the Operator Menu	40
Starting Memory Sampling	41
Stopping Memory Sampling.....	41
Switching between Operation Screens.....	42
Writing the Message “START”	43
Writing a Free Message.....	45
Displaying Previously Measured Data (Historical trend display)	46
Operating Other Screens.....	51
Calibrating the Touch Panel and Checking the Calibration.....	52
Preventing Touch Panel Operations (Locking the touch panel).....	53
Setting Command	54
Connecting to an Ethernet Network	55
Setup Example 9: Monitoring the DX on a PC Browser	55
Setup Example 10: Automatically Transferring the Measured Data File to an FTP Server	58
Using DAQSTANDARD.....	60
Displaying the Measured Data on DAQSTANDARD	60
DX2000T Settings.....	61
Installation and Wiring	62
Installation Location	62
Installation Procedure	63
△ Input Signal Wiring.....	65
△ Optional Terminal Wiring.....	68
Alarm Output Terminal (/A1, /A2, /A3, /A4, and /A5), FAIL Output Terminal, and Status Output Terminal (/F1 and /F2).....	74
Remote Control Input Terminal (/R1)	74
Pulse Input Terminal (/PM1).....	74
24 VDC Transmitter Power Supply Output Terminal (/TPS4 and /TPS8).....	74
Serial Interface.....	74
△ Connecting to the VGA Connector (/D5).....	75
Connecting to the USB Port (/USB1).....	76
Connecting to the Ethernet Port	76
△ Power Supply Wiring	77
Recommended Replacement Periods for Worn Parts Maintenance	79
Setup Items and Default Values	80
Setup Items in Setting Mode and Their Default Values	82
Setup Items in Basic Setting Mode and Their Default Values.....	96
List of Operator Menu Items.....	109

Daqstation DX2000 User's Manual

Chapter 1	Overview of Functions
Chapter 2	Common Operations
Chapter 3	Measurement Channels and Alarms
Chapter 4	Switching Operation Screens
Chapter 5	Operations for Changing the Displayed Contents
Chapter 6	Saving and Loading Data
Chapter 7	Customizing Actions Using the Event Action and Remote Control Functions (/R1 and /PM1 Options)
Chapter 8	Security Function
Chapter 9	Computation and Report Functions (/M1 and /PM1 Options)
Chapter 10	External Input Channels (/MC1 Option)
Chapter 11	Troubleshooting
Chapter 12	Maintenance
Chapter 13	Specifications

Daqstation DX1000/N/DX2000 Communication Interface User's Manual

Chapter 1	Using the Ethernet Interface
Chapter 2	Using the Serial Interface
Chapter 3	Commands
Chapter 4	Responses
Chapter 5	Status Reports
Chapter 6	Specifications

Introduction

Thank you for purchasing the Daqstation DX2000T (DX). This manual describes the basic operating procedures and installation and wiring procedures of the DX2000T. For details on the functions, see the relevant DX2000 User's Manual. To ensure correct use, please read this manual and the manuals below thoroughly before beginning operation.

For the product specifications, see the general specifications.

Paper Manual

Manual Title	Manual No.*
DX2000T Operation Guide This manual.	IM 04L45B02-02EN
Control of Pollution Caused by the Product Gives a description of pollution control.	IM 04L41B01-91C
About the Usage of Open Source Software	IM 04L41B01-81Z1

DAQSTANDARD

Download the DAQSTANDARD (Application software) from the following URL.

URL: <https://www.yokogawa.com/ns/dxadv/download/>

Electronic Manuals

User's manuals for the DX are available on the following web site:

<http://www.yokogawa.com/ns/dxadv/im/>

You need Adobe Reader 7.0 or later (but the latest version is recommended) installed on the computer in order to open and read the manuals.

Manual Title	Manual No.*
DX2000T Operation Guide	IM 04L45B02-02EN
DX2000 User's Manual Describes how to use the DX2000. The communication and network functions, custom display functions, and some of the options are excluded.	IM 04L42B01-01E
DX1000/DX1000N/DX2000 Multi Batch (/BT2) User's Manual Describes how to use the multi batch function (/BT2 option).	IM 04L41B01-03E
DX1000/DX1000N/DX2000 Custom Display User's Manual Describes how to use the custom display function.	IM 04L41B01-04E
DX1000/DX1000N/DX2000 Advanced Security Function (/AS1) User's Manual Describes how to use the advanced security function (/AS1 option).	IM 04L41B01-05EN
DX1000/DX1000N/DX2000 Communication Interface User's Manual Describes how to use the communication functions using the Ethernet and serial interfaces.	IM 04L41B01-17E
DX1000/DX1000N/DX2000 EtherNet/IP Communication Interface User's Manual Describes how to use communication functions through the EtherNet/IP interface.	IM 04L41B01-18E
DX1000/DX1000N/DX2000 PROFIBUS-DP (/CP1) Communication Interface User's Manual Describes how to use communication functions through the PROFIBUS-DP interface (/CP1 option).	IM 04L41B01-19E

DAQSTANDARD Manuals

Manual Title	Manual No.*
DAQSTANDARD Viewer User's Manual	IM 04L41B01-63EN
DAQSTANDARD Hardware Configurator User's Manual	IM 04L41B01-64EN
DAQSTANDARD DX-P Hardware Configurator User's Manual	IM 04L41B01-65EN
Installing DAQSTANDARD	IM 04L41B01-66EN

General Specifications (GS)

General Specifications Name	General Specifications No.*
Daqstation DX2000T	GS 04L45B02-01EN

* The last characters, "EN" for example, of the manual number and general specifications number indicates the language in which the manual is written.

Differences between the DX2000T and the DX2000

Some of the DX2000T and DX2000 specifications are different. When you view the manuals, note the following differences in the specifications.

- In addition to using keys, you can use the touch panel to control the DX2000T.
- The DX2000T's dust and water protection specification is IEC529-IP32.
- The DX2000T cannot be controlled remotely (with the /KB1 and /KB2 easy text entry options). No remote control is included with the DX2000T.

Notes

- The contents of this manual are subject to change without prior notice as a result of continuing improvements to the instrument's performance and functions.
- Every effort has been made in the preparation of this manual to ensure the accuracy of its contents. However, should you have any questions or find any errors, please contact your nearest YOKOGAWA dealer.
- Copying or reproducing all or any part of the contents of this manual without YOKOGAWA's permission is strictly prohibited.
- The TCP/IP software of this product and the document concerning the TCP/IP software have been developed/created by YOKOGAWA based on the BSD Networking Software, Release 1 that has been licensed from the Regents of the University of California

Authorised Representative in the EEA

The Authorised Representative for this product in the EEA is:

Yokogawa Europe B.V.

Euroweg 2, 3825 HD Amersfoort, The Netherlands

QR Code

The product has a QR Code pasted for efficient plant maintenance work and asset information management.

It enables confirming the specifications of purchased products and user's manuals.

For more details, please refer to the following URL.

<https://www.yokogawa.com/qr-code>

QR Code is a registered trademark of DENSO WAVE INCORPORATED.

Trademarks

- DAQSTATION, Daqstation, and DXAdvanced are registered trademarks of Yokogawa Electric Corporation.
- Microsoft and Windows are registered trademarks or trademarks of Microsoft Corporation in the United States and/or other countries.
- Adobe and Acrobat are registered trademarks or trademarks of Adobe Systems Incorporated.
- Kerberos is a trademark of the Massachusetts Institute of Technology (MIT).
- Company and product names that appear in this manual are registered trademarks or trademarks of their respective holders.
- The company and product names used in this manual are not accompanied by the registered trademark or trademark symbols (® and ™).

Revisions

- 1st Edition: April 2011
- 2nd Edition: October 2011
- 3rd Edition: March 2016
- 4th Edition: October 2016
- 5th Edition: June 2018
- 6th Edition: May 2019

Safety Precautions

- This instrument conforms to IEC safety class I (provided with terminal for protective grounding), Overvoltage Category II or I, and EN61326-1 (EMC standard), Measurement Category II (CAT II)*.
 - * Measurement category II (CAT II) applies to measuring circuits connected to low voltage installation, and electrical instruments supplied with power from fixed equipment such as electric switchboards.
- This instrument is an EN61326-1 (EMC standard) class A instrument (for use in commercial, industrial, or business environments). The influence rate (judgment condition A) in the immunity test environment is within $\pm 10\%$ of the range or ± 10 mV (50V range only, $\pm 20\%$ of the range).
- The general safety precautions described here must be observed during all phases of operation. If the DX is used in a manner not described in this manual, the DX safety features may be impaired. Yokogawa Electric Corporation assumes no liability for the customer's failure to comply with these requirements. The DX is designed for indoor use.

About This Manual

- Please pass this manual to the end user. We also ask you to store this manual in a safe place.
- Read this manual thoroughly and have a clear understanding of the product before operation.
- This manual explains the functions of the product. It does not guarantee that the product will suit a particular purpose of the user.

Precautions Related to the Protection, Safety, and Alteration of the Product

The following safety symbols are used on the product and in this manual.



"Handle with care." To avoid injury and damage to the instrument, the operator must refer to the explanation in the manual.



Protective ground terminal



Functional ground terminal (do not use this terminal as a protective ground terminal.)



Alternating current



Direct current



ON (power)



OFF (power)

- For the protection and safe use of the product and the system in which this product is incorporated, be sure to follow the instructions and precautions on safety that are stated in this manual whenever you handle the product. Take special note that if you handle the product in a manner that violates these instructions, the protection functionality of the product may be damaged or impaired. In such cases, YOKOGAWA does not guarantee the quality, performance, function, and safety of product.
- When installing protection and/or safety circuits such as lightning protection devices and equipment for the product and control system or designing or installing separate protection and/or safety circuits for fool-proof design and fail-safe design of the processes and lines that use the product and the control system, the user should implement these using additional devices and equipment.
- If you are replacing parts or consumable items of the product, make sure to use parts specified by YOKOGAWA.

- This product is not designed or manufactured to be used in critical applications that directly affect or threaten human lives. Such applications include nuclear power equipment, devices using radioactivity, railway facilities, aviation equipment, air navigation facilities, aviation facilities, and medical equipment. If so used, it is the user's responsibility to include in the system additional equipment and devices that ensure personnel safety.
- Do not modify this product.



WARNING

Use the Correct Power Supply

Ensure that the source voltage matches the voltage of the power supply before turning ON the power. In the case of a desktop type, ensure that it is within the maximum rated voltage range of the provided power cord before connecting the power cord.

Use the Correct Power Cord and Plug (Desktop Type)

To prevent electric shock or fire, be sure to use the power cord supplied by YOKOGAWA. The main power plug must be plugged into an outlet with a protective earth terminal. Do not disable this protection by using an extension cord without protective earth grounding.

The power cord is designed for use with this instrument. Do not use the power cord with other instruments.

Connect the Protective Grounding Terminal

Make sure to connect the protective grounding to prevent electric shock before turning ON the power.

The power cord that comes with the desktop type is a three-prong type power cord. Connect the power cord to a properly grounded three-prong outlet.

Do Not Impair the Protective Grounding

Never cut off the internal or external protective grounding wire or disconnect the wiring of the protective grounding terminal. Doing so invalidates the protective functions of the instrument and poses a potential shock hazard.

Do Not Operate with Defective Protective Grounding

Do not operate the instrument if the protective grounding might be defective. Also, make sure to check them before operation.

Do Not Operate in an Explosive Atmosphere

Do not operate the instrument in the presence of flammable liquids or vapors. Operation in such an environment constitutes a safety hazard.

Prolonged use in a highly dense corrosive gas (H_2S , SO_x , etc.) will cause a malfunction.

Do Not Remove Covers

The cover should be removed by YOKOGAWA's qualified personnel only. Opening the cover is dangerous, because some areas inside the instrument have high voltages.

Ground the Instrument before Making External Connections

Connect the protective grounding before connecting to the item under measurement or control unit.

Damage to the Protection

Operating the instrument in a manner not described in this manual may damage the instrument's protection.



CAUTION

This instrument is a Class A product. Operation of this instrument in a residential area may cause radio interference, in which case the user is required to take appropriate measures to correct the interference.

Exemption from Responsibility

- YOKOGAWA makes no warranties regarding the product except those stated in the WARRANTY that is provided separately.
- YOKOGAWA assumes no liability to any party for any loss or damage, direct or indirect, caused by the user or any unpredictable defect of the product.

Handling Precautions of the Software

- YOKOGAWA makes no warranties regarding the software accompanying this product except those stated in the WARRANTY that is provided separately.
- Use the software on a single PC.
- You must purchase another copy of the software, if you are to use the software on another PC.

- Copying the software for any purposes other than backup is strictly prohibited.
- Please store the original media containing the software in a safe place.
- Reverse engineering, such as decompiling of the software, is strictly prohibited.
- No portion of the software supplied by YOKOGAWA may be transferred, exchanged, or sublet or leased for use by any third party without prior permission by YOKOGAWA.

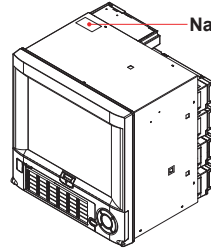

Name plate

MODEL	STYLE
	H S
SUFFIX	
SUPPLY	
FREQUENCY	
NO.	

Handling Precautions of the DX

- Do not push or scrape the display (the touch panel surface) with a sharp blade or pointed object. Doing so may damage the instrument.
- Use care when cleaning this instrument, especially its plastic parts. Use a soft dry cloth. Do not use organic solvents, such as benzene or thinner, or other cleansers. They may cause discoloring and deformation.
- Keep electrically charged objects away from the signal terminals. If you do, the DX may malfunction.
- Do not apply volatile chemicals to the display, panel keys, etc. Do not allow rubber and vinyl products to remain in contact with the DX for long periods of time. If you do, the DX may malfunction.
- When not in use, make sure to turn OFF the power switch.
- If there are any symptoms of trouble such as strange odors or smoke coming from the DX, immediately turn OFF the power switch and the power supply source. Then, contact your nearest YOKOGAWA dealer.

Handling Precautions of the External Storage Medium (CF Card)

- Use caution in the handling of the external storage medium as it is a delicate product.
- Write operation to storage media may fail under high-temperature or low-temperature environments. If you are using the DX in a low-temperature environment (around 10°C or less), use the DX after the warm-up time (at least 30 minutes) has elapsed. If you are using the DX under a high-temperature environment (around 40°C or more), it is recommended that the external storage medium be inserted into the drive when saving the data and be removed after the data storage operation is finished.
- Remove the storage medium from the drive when turning the DX ON/OFF.
- Touching the compact flash section when static electricity is built up on the human body can lead to erroneous operation.
- For the general handling precautions of the external storage medium, see the instruction manual that came with the external storage medium.

CAUTION

- Do not eject the external storage medium while the access indicator is illuminated. This can damage the data.
- Do not access the storage medium in a place with vibrations or shock. The storage medium or drive may malfunction.

NO. (Instrument Number)

When contacting the dealer from which you purchased the instrument, please give them the instrument number.

MODEL and SUFFIX Code

Model	Suffix Code	Optional code	Description
DX2004T			Daqstation DX2000T 4ch, 125 ms (Fast sampling mode 25 ms)
DX2008T			Daqstation DX2000T 8ch, 125 ms (Fast sampling mode 25 ms)
DX2010T			Daqstation DX2000T 10ch, 1 s (Fast sampling mode 125 ms)
DX2020T			Daqstation DX2000T 20ch, 1 s (Fast sampling mode 125 ms)
DX2030T			Daqstation DX2000T 30ch, 1 s (Fast sampling mode 125 ms)
DX2040T			Daqstation DX2000T 40ch, 1 s (Fast sampling mode 125 ms)
DX2048T			Daqstation DX2000T 48ch, 1 s (Fast sampling mode 125 ms)
Internal memory size	-3		Standard memory (400 MB)
External storage media	-4		With CF card
Language		-2	English/German/French, deg F, and DST
Options			
	/A1		Alarm output 2 points ¹⁾
	/A2		Alarm output 4 points ¹⁾⁹⁾
	/A3		Alarm output 6 points ¹⁾
	/A4		Alarm output 12 points ¹⁾⁹⁾⁹⁾
	/A5		Alarm output 24 points ¹⁾²⁾⁷⁾⁹⁾
	/C2		RS-232 interface ³⁾
	/C3		RS-422/485 interface ³⁾
	/D5		VGA output
	/F1		FAIL/status output ²⁾⁴⁾⁸⁾
	/F2		FAIL + alarm output 22 points ¹⁾⁴⁾⁷⁾⁹⁾
	/H2		Clamped input terminal (detachable)
	/H5]		Desktop type 5
	/M1		Mathematical functions (including the report function) ⁹⁾
	/N1		Cu10, Cu25 RTD input/3 leg isolated RTD
	/N2		3 leg isolated RTD ⁶⁾
	/N3		Extended input type (PR40-20, Pt50, etc.)
	/P1		24 VDC/AC power supply ⁵⁾
	/R1		Remote control ⁹⁾
	/TPS4		24-VDC transmitter power supply (4 loops) ⁷⁾
	/TPS8		24-VDC transmitter power supply (8 loops) ⁷⁾⁸⁾⁹⁾
	/USB1		USB interface
	/PM1		Pulse input (including remote control and mathematical function) ⁹⁾
	/CC1		Calibration correction function
	/MC1		External input function ¹⁰⁾
	/BT2		Multi batch function ¹¹⁾
	/CP1		PROFIBUS-DP ³⁾
	/AS1		Advanced security function

¹⁾ /A1, /A2, /A3, /A4, /A5, and /F2 cannot be specified together.

²⁾ /A5 and /F1 cannot be specified together.

³⁾ /C2, /C3, and /CP1 cannot be specified together.

⁴⁾ /F1 and /F2 cannot be specified together.

⁵⁾

/H5]	D:	Power cord UL, CSA st'd
	F:	Power cord VDE st'd
	R:	Power cord SAA st'd
	J:	Power cord BS st'd
	H:	Power cord GB st'd
		Null (/H5): Only for /P1 model (without power cord)

⁶⁾ /N2 can be specified only for DX2010T, DX2020T, DX2030T, DX2040T and DX2048T.

⁷⁾ /TPS4, /TPS8, /A5 and /F2 cannot be specified together.

⁸⁾ If /TPS8 is specified, /A4 and /F1 cannot be specified together.

⁹⁾ If /PM1 is specified, /A5, /F2, /M1, and /R1 cannot be specified together.

The combination of /A2/F1 and the combination of /A4/TPS8 cannot be specified together.

¹⁰⁾ /MC1 can be specified only for the DX2010T, DX2020T, DX2030T, DX2040T, and DX2048T.

¹¹⁾ /BT2 can only be specified for the DX2010T, DX2020T, DX2030T, DX2040T, and DX2048T.

Checking the Contents of the Package

Unpack the box and check the contents before operating the instrument. If some of the contents are not correct or missing or if there is physical damage, contact the dealer from which you purchased them.

DX2000T

A name plate is located on the top panel of the DX (side panel on models with the /H5] option). Check that the model name and suffix code given on the name plate match those on your order.

Standard Accessories

The standard accessories below are supplied with the instrument. Check that all contents are present and undamaged.

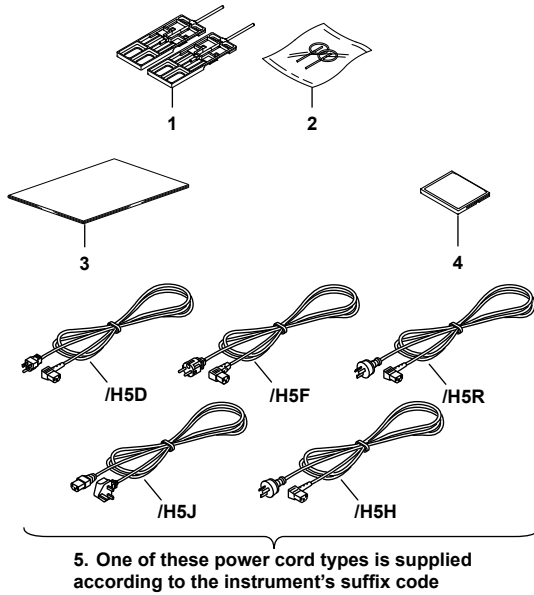

No.	Name	Part Number/ Model	Qty.	Notes
1	Mounting brackets	B9900BX	2	For panel mounting Except for the /H5[] models.
2	Door lock key	B8706FX	2	–
3	DX2000T Operation Guide (this manual)	IM 04L45B02- 02EN	1	A4 size
	Control of Pollution Caused by the Product	IM 04L41B01-91C	1	
	About the Usage of Open Source Software	IM 04L41B01-81Z1	1	
4	CF card	B8706NQ	1	128 MB (The size and model may change.)
5	Power cord	A1006WD	1	Supplied only for models with the /H5D option. Maximum rated voltage: 125 V
		A1009WD	1	Supplied only for models with the /H5F option. Maximum rated voltage: 250 V
		A1024WD	1	Supplied only for models with the /H5R option. Maximum rated voltage: 250 V
		A1054WD	1	Supplied only for models with the /H5J option. Maximum rated voltage: 250 V
		A1064WD	1	Supplied only for models with the /H5H option. Maximum rated voltage: 250 V

Optional Accessories (Sold Separately)

The following optional accessories are available for purchase separately. If you make an order, make sure that all contents are present and undamaged. For information about ordering accessories, contact the dealer from which you purchased the DX.

No.	Name	Model	Minimum Q'ty	Notes
1	CF card	772093	1	512 MB
		772094	1	1 GB
		772095	1	2 GB
2	Shunt resistor (for screw input terminal)	415920	1	250 Ω ± 0.1%
		415921	1	100 Ω ± 0.1%
		415922	1	10 Ω ± 0.1%
3	Shunt resistor (for clamped input terminal)	438920	1	250 Ω ± 0.1%
		438921	1	100 Ω ± 0.1%
		438922	1	10 Ω ± 0.1%
4	Mounting brackets	B9900BX	2	–
5	Door lock key	B8706FX	1	–
6	Remote control terminal	438227	1	Remote controller
7	Validation document	–	1	Electronic file

Style number, release number, and firmware version number of the DX2000T

Style number: This is the DX2000T hardware number that is indicated on the name plate.

Release number: This is the DX2000T firmware number that is indicated on the name plate. The number corresponds to the integer part of the firmware version number.

Example: If the firmware version number is 4.11, the release number is 4.

Firmware version number: This number is displayed on the DX2000T system information screen. For the procedure, see section 2.5, "Viewing the DX Information" in the *DX2000 User's Manual (IM 04L42B01-01E)*.

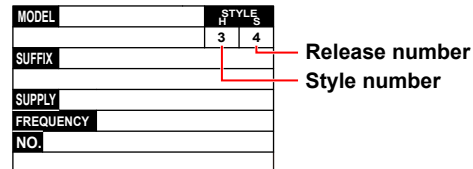

Protection of Environment

Control of Pollution Caused by the Product



For details, see the *Control of Pollution Caused by the Product* (IM04L41B01-91C).

Proper Disposal of This Product

This is an explanation of how to dispose of this product based on Waste Electrical and Electronic Equipment (WEEE), Directive. This directive is only valid in the EU.

- Marking
This product complies with the WEEE Directive marking requirement. This marking indicates that you must not discard this electrical/electronic product in domestic household waste.



- Product Category
With reference to the equipment types in the WEEE directive, this product is classified as a "Small equipment" product. Do not dispose in domestic household waste. When disposing products in the EU, contact your local Yokogawa Europe B.V. office.

How to Replace and/or Dispose the Batteries

This is an explanation about the new EU Battery Directive (DIRECTIVE 2006/66/EC). This directive is only valid in the EU. Batteries are included in this product. Batteries incorporated into this product cannot be removed by yourself. Dispose them together with this product. When you dispose this product in the EU, contact your local Yokogawa Europe B.V. office. Do not dispose them as domestic household waste.

Battery type: Lithium battery



Notice: The symbol (see above) means they shall be sorted out and collected as ordained in ANNEX II in DIRECTIVE 2006/66/EC.

Conventions Used in This Manual

- This manual covers information regarding DX2000Ts that have a suffix code for language "-2" (English).
- For details on how to set the language, see section 2.6, "Changing the Language" in the *DX2000 User's Manual (IM 04L42B01-01E)*.

Unit

K: Denotes 1024. Example: 768 KB (file size)

k: Denotes 1000.

The following markings are used in this manual.



Improper handling or use can lead to injury to the user or damage to the instrument. This symbol appears on the instrument to indicate that the user must refer to the user's manual for special instructions. The same symbol appears in the corresponding place in the user's manual to identify those instructions. In the manual, the symbol is used in conjunction with the word "WARNING" or "CAUTION."

WARNING

Calls attention to actions or conditions that could cause serious or fatal injury to the user, and precautions that can be taken to prevent such occurrences.

CAUTION

Calls attentions to actions or conditions that could cause light injury to the user or damage to the instrument or user's data, and precautions that can be taken to prevent such occurrences.

Note

Calls attention to information that is important for proper operation of the instrument.



Indicates after this mark reference to related procedure or explanation.

Bold characters

Indicates character strings that appear on the screen and the operation keys.

Revision History

Edition	DX	Description
3	Release number 4 (version 4.0x) Style number 4	Additions and improvements to explanations. NLF is supported. User's manuals are supplied by downloading them on the web site. An LCD with LED back light replaced an LCD with CFL back light.
4	Same as edition 3	Merge the manuals (IM 04L41B01-91C, IM 04L41B01-81Z1).
5	Same as edition 4	Changes of "Proper Disposal of This Product"
6	Same as edition 5	Delete the CF card adapter. Changed the battery assembly part number.

Introduction to Functions

Measured Items

You can connect DC voltage, thermocouple, RTD, and ON/OFF input and measure various values such as temperature and flow rate. The DX samples the input signals at the scan interval to obtain the measured values. The fastest scan interval is 25 ms on the DX2004T and DX2008T and 125 ms on the DX2010T, DX2020T, DX2030T, DX2040T, and DX2048T.

Up to four alarm conditions can be set for each measurement channel.

Data Storage Function

There are two methods of recording measured data. One is to record the measured data continuously, and the other is to record only when certain events occur such as alarms. The measured data is recorded to the internal memory at a specified interval. The data in the internal memory can be stored to a CF card automatically or manually. By connecting to a network via the Ethernet interface, the measured data can also be automatically transferred to an FTP server on a network.

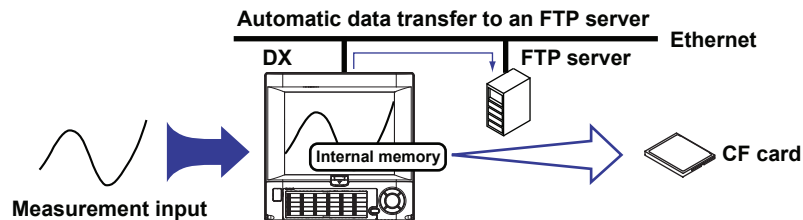

Display Function

Measured data can be displayed as trends, numeric values, and bar graphs for each group. In addition, the overview display can be used to display and monitor all channels on a single screen.

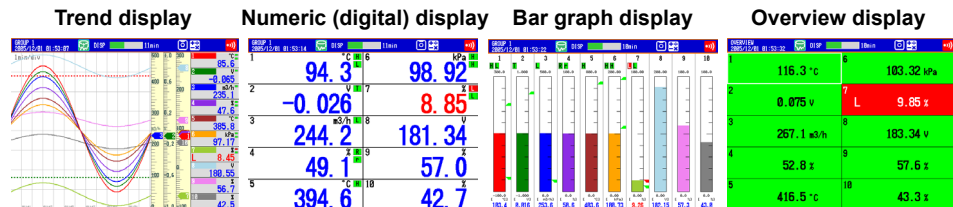

Other Functions

Computation Function (option)	Various types of computation can be performed by assigning equations to computation channels.
FAIL/status output function (option)	Outputs an alarm when the DX fails. The function also monitors the DX status such as the remaining amount of internal memory and outputs alarms.
Remote control function (option)	A specified action is executed when a remote input signal is applied to the terminal on the rear panel.
Security function	Enables only registered users can operate the DX. The function can also be used to prohibit key operation.
Communication function	The Ethernet interface can be used to monitor the DX using a Web browser and transmit e-mail when an event occurs such as an alarm. In addition, data of devices on the network can be loaded and displayed using the Modbus protocol.

DAQSTANDARD

The software program, DAQSTANDARD, can be used to display the measured data, convert the measured data format, and create DX setup data.

DX System Configuration

The DX can be used to configure a system as shown below.

Referenced sections are of the *DX2000 User's Manual*.

Referenced pages are of this manual.

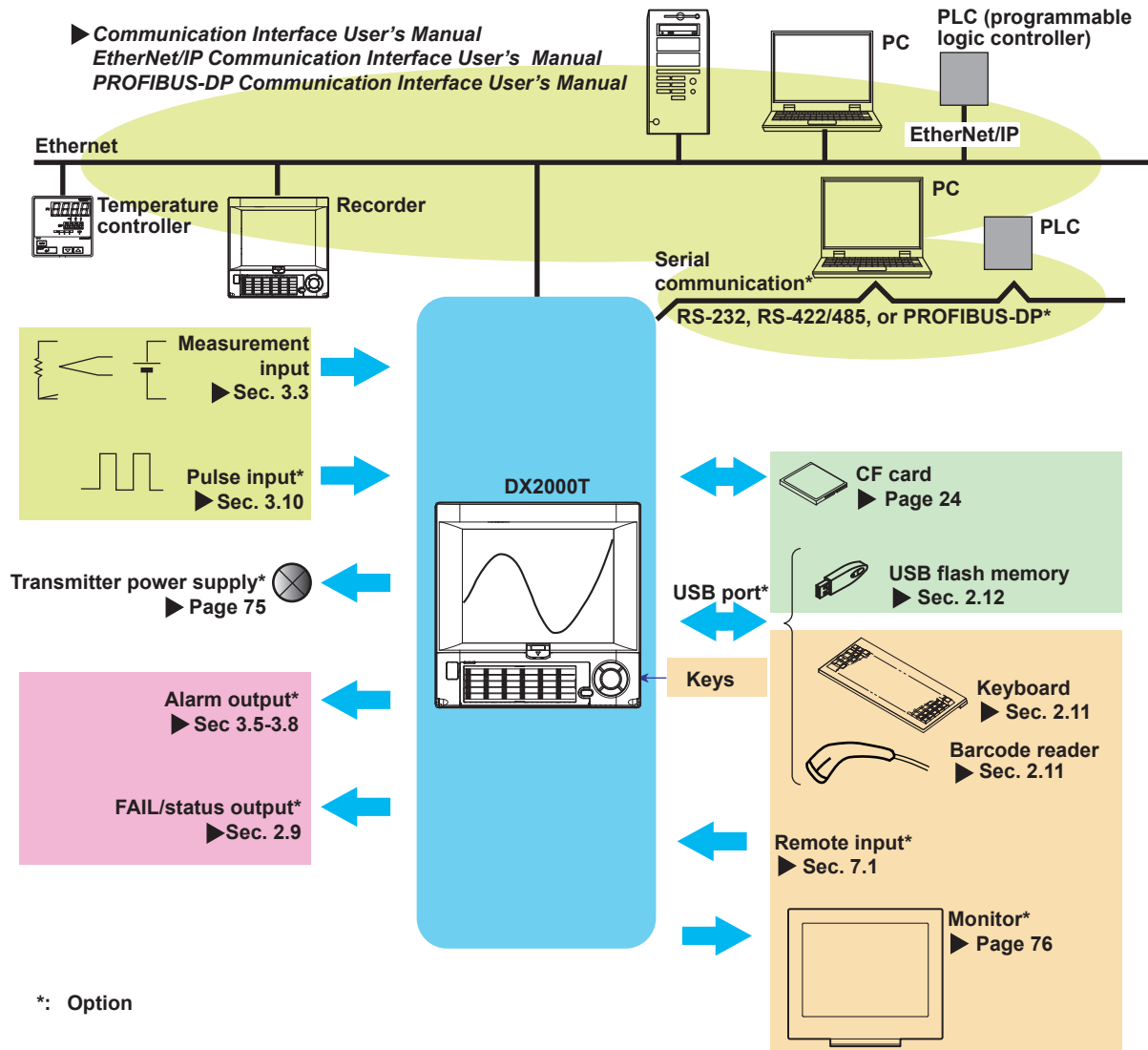

Terminology

- **Memory sample**
The operation of recording measured data.
- **Memory start**
The operation of starting memory sampling.
- **Memory stop**
The operation of stopping memory sampling.
- **Display data**
The waveform data shown on the DX display. The data recorded at the sampling interval for the displayed data.
- **Event data**
Measured data recorded at a sampling interval separate from that of the display data.

Names of Parts

Front View

Key panel opened

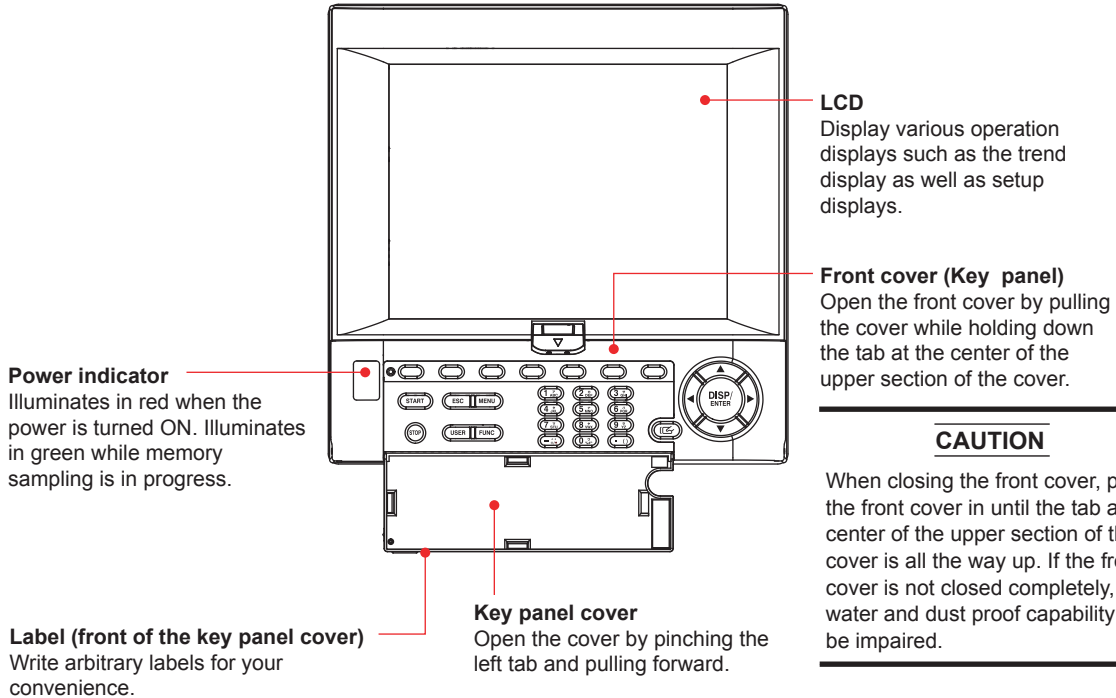

CAUTION

When closing the front cover, press the front cover in until the tab at the center of the upper section of the cover is all the way up. If the front cover is not closed completely, the water and dust proof capability may be impaired.

Front cover opened

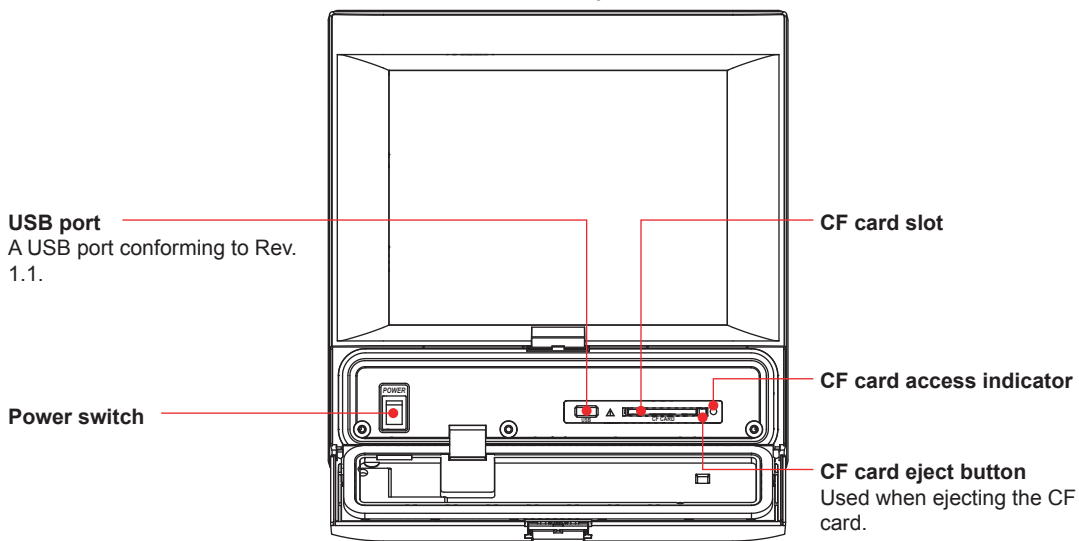

Door lock key (included)

Insert the pin in the left hole to lock.
Insert the pin in the right hole to unlock.

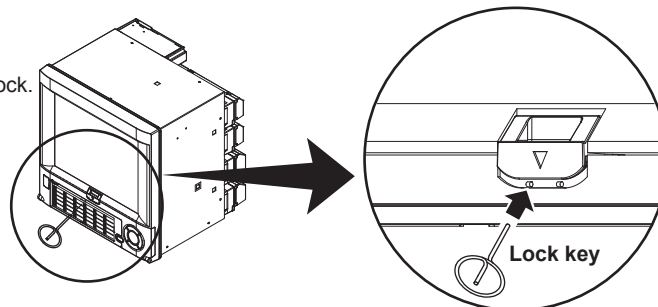

Rear Panel

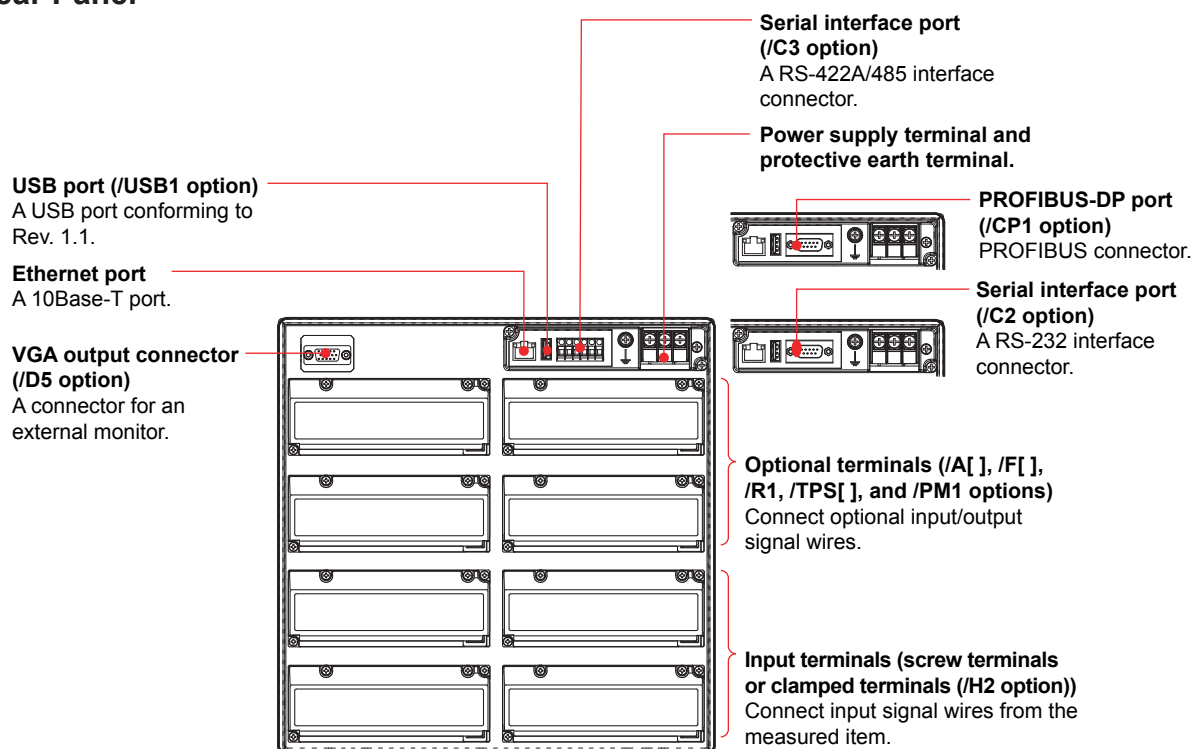

Desktop Type (/H5[] Option)

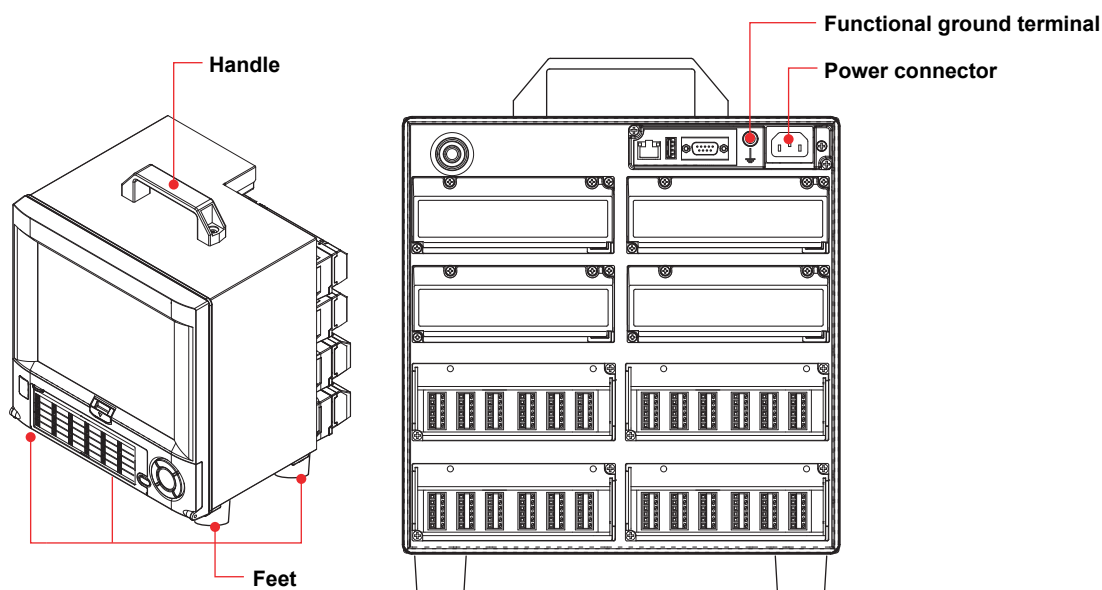

DX2000T Workflow

When using the DX for the first time, carry out the following procedure.

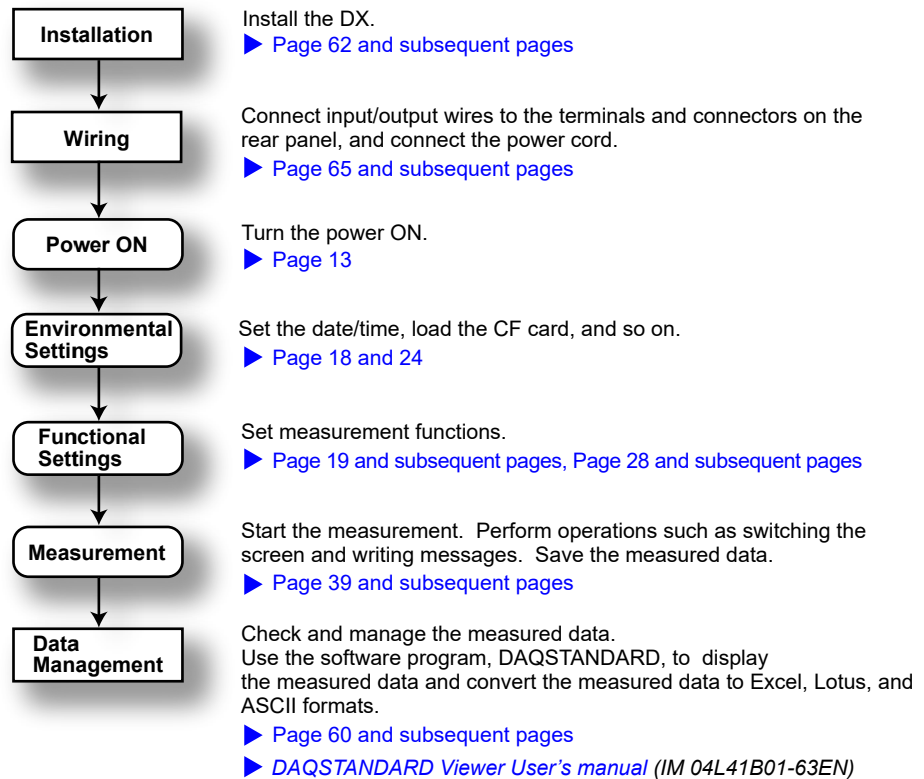

On a DX with advanced security (/AS1 option), carry out the following procedure after turning the DX on.

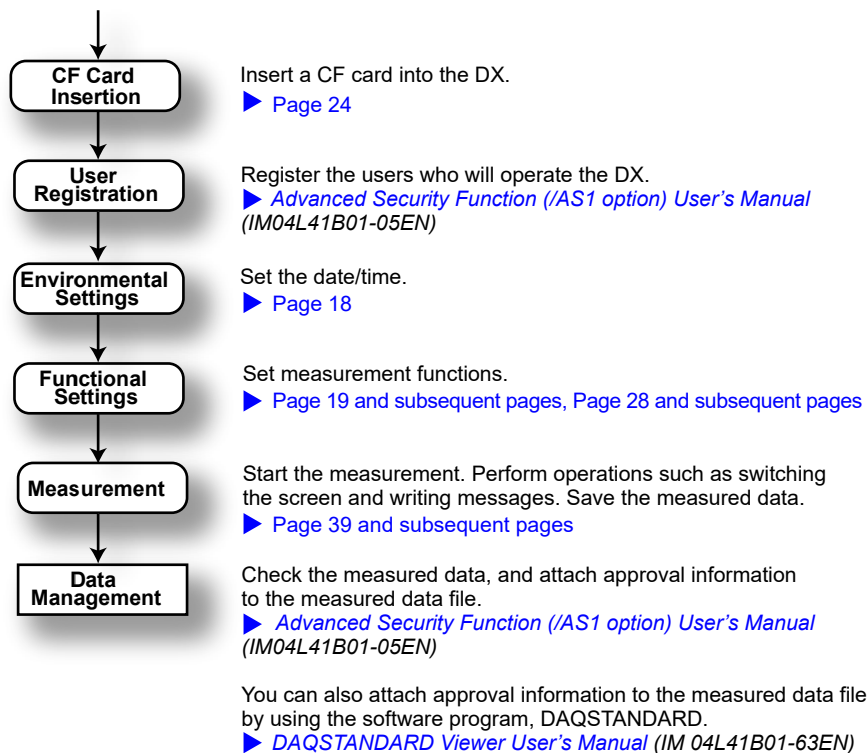

Turning the Power ON/OFF

Turning the Power ON



CAUTION

Before turning ON the power switch, check that

- The power cord/wires are connected correctly to the DX.
- The DX is connected to the correct power supply (see page 78).

If the input wires are connected in parallel with other devices, do not turn ON/OFF the power switch of the DX or another device during operation. This can have adverse effects on the measured values.

1. Open the operation cover.
2. Turn ON the power switch.

After performing a self-test for a few seconds, the operation screen appears.

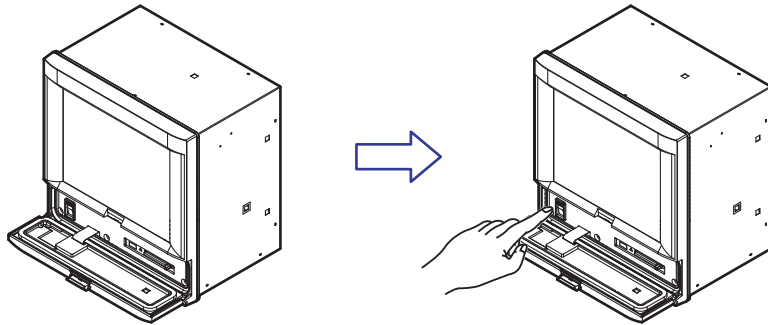

3. Close the operation cover.



CAUTION

- If nothing is displayed when the power switch is turned ON, turn OFF the power switch and check the points listed above one more time. After checking the points, turn ON the power switch again. If the DX still does not work, it is probably a malfunction. Contact your nearest YOKOGAWA dealer for repairs.
- If an error message is displayed on the screen, take measures according to the description in chapter 11, "Troubleshooting" in the *DX2000 User's Manual*.
- Turn ON the power switch, let the DX warm up for at least 30 minutes, and then start the measurements.

Turning the Power OFF



CAUTION

Before turning OFF the power switch, check that the external storage medium is not being accessed.

1. Open the operation cover.
2. Turn OFF the power switch.
3. Close the operation cover.

Basic Operation

Panel Keys

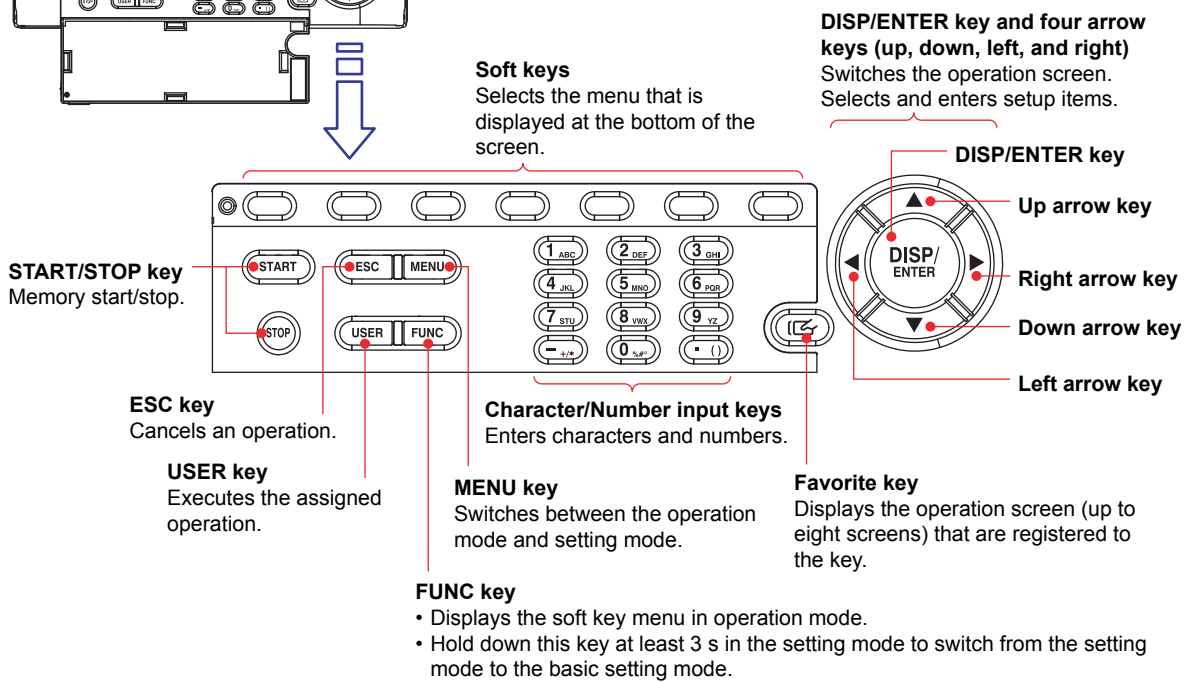
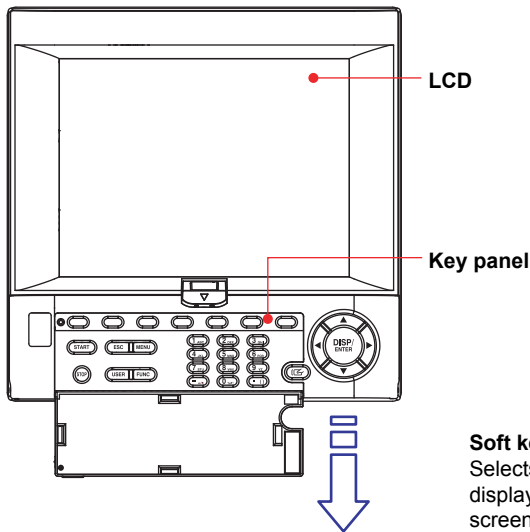

Display

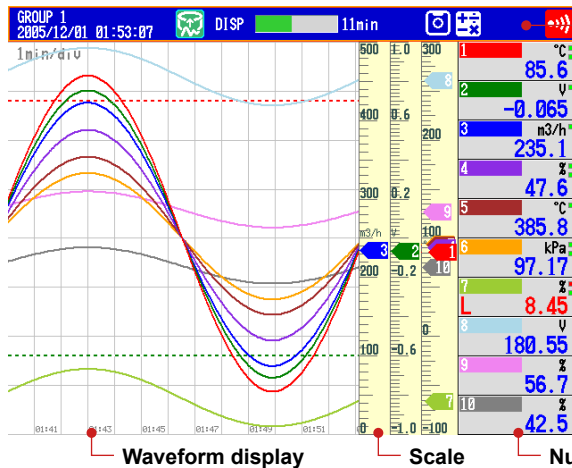

Status display section
Shows the display name, date/time, data recording, alarm icon, etc.

Data display section
Shows the measured data and the functional setup display.
For the waveform display and numeric display, see section 4.2, in the *DX2000 user's Manual (IM 04L42B01-01E)*. For details on how to set the scale, see section 5.7, in the *DX2000 user's Manual (IM 04L42B01-01E)*.

Display on the Status Display Section

The following information is displayed in the status display section.

Memory sampling status

<p>Memory sampling stopped </p> <p>Memory sampling in progress </p> <p>Memory sampling icon </p>	<p>Data type DISP: Display data EVENT: Event data</p> <p>Memory sampling progress Displays the progress using a green bar graph. The frame indicates the file save interval (display data) or the data length (event data). Error in internal memory. Contact your nearest YOKOGAWA dealer for repairs. Displays the remaining memory sampling time for the left bar graph.</p>
---	--

GROUP 1 ALL DISP 46min

Display name or group name
For all channel display on the trend display, "ALL" is displayed.

Date and time
Displayed in yellow while the time is being corrected.

When using the batch function
 Batch name (shown alternately with the display name)
Date and time
If the "batch number-lot number" exceeds 20 characters, the "date and time" position is used to display the "batch number-lot number."

When using the login function
 Name of the user logged in
Display name
Date and time

When using the login and batch functions
 Name of the user logged in
Batch name (shown alternately with the display name)
Date and time

Alarm icon
 Displayed when any alarm is activated. Blinks when there are alarms that are occurring but have not been acknowledged.
 All alarms have been released after they have occurred, but there are alarms that have not been acknowledged.

Status icon
 The status assigned to the status output (/F1 or /F2 option) is occurring.

User Locked Icon (/AS1 option)
 Displayed when the user is locked.
 White icon: Keys are locked.
 Yellow icon: Touch panel is locked.
 Red icon: Keys and touch panel is locked.
 E-mail transmission is enabled.

Computation icon (/M1 or /PM1 option)
 White icon: Computation in progress
 Yellow icon: Computation dropout occurred

CF card icon
 CF card is being accessed.
 Waiting.
 Light blue icon: CF card in the slot is not recognized. Remove and reset it.
 CF card error.
Carry out the procedure below to reset the CF card icon to normal.
• Remove the CF card, and then reinsert it.
• Replace the CF card with a normal one.
• Format the CF card on the DX (the data on the CF card will be erased).

The green level display indicates the amount of CF card used. If Media FIFO* is not enabled and the free space on the CF card falls below 10%, the level indicator changes to red.

* See section 1.4, in the *DX2000/ User's Manual*. Media FIFO is a function available on release number 2 or later.

Run Modes

Mode Transition Diagram

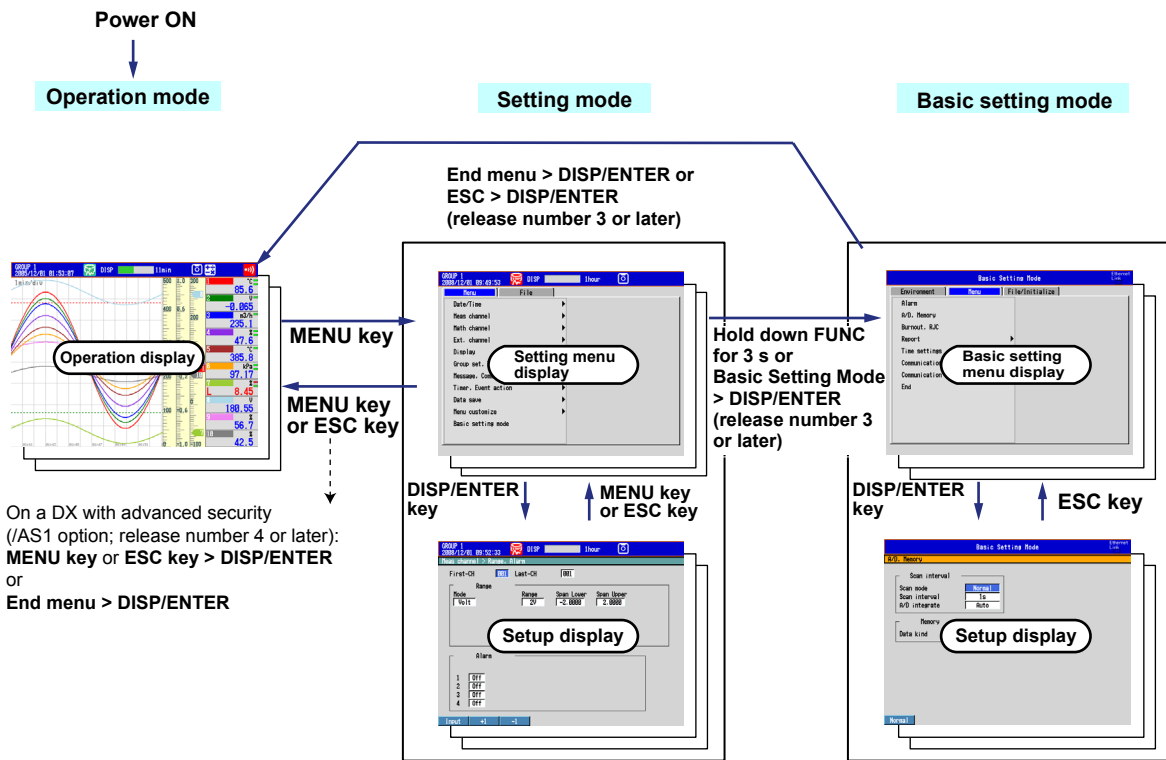

The DX has three modes.

Mode	Description
Operation mode	A mode for performing measurements.
Setting mode	A mode in which input range, measurement method, and so on are configured. Settings can be changed when memory sampling is in progress excluding some items.
Basic setting mode	A mode used to set basic items such as the scan interval and storage format of measured data. On a DX with advanced security (/AS1 option), the login settings can be changed during memory sampling.

* For further details on the basic setting mode and setting mode, see page 81.

Carry out the steps given in the following pages. It will help you to understand the DX operation.

Entering Values and Characters

The character/number input keys and DISP/ENTER key are used to set the date/time, set the display span of the input range, set the tag, set the message string, enter the password, etc.

Character/Number input keys

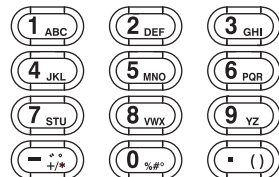

DISP/ENTER key and four arrow keys (up, down, left, and right)

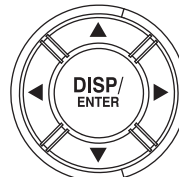

Entering Values

When a window for entering a value appears, enter the value by performing the following key operation.

- **Left and right arrow keys:** Selects the input position.
- **Character/Number input keys:** Enters a value.

The following soft key appears when it can be used.



- **Space soft key:** Enters a space.

Entering Character Strings

When a window for entering a character string appears, enter it by performing the following key operation.

- **Left and right arrow keys:** Selects the input position.
- **Character/Number input keys:** Enters a character string.

The character to be entered is determined by the number of times the A/a/1 soft key and the character/number input key is pressed. The character types that can be entered vary depending on the item being set.

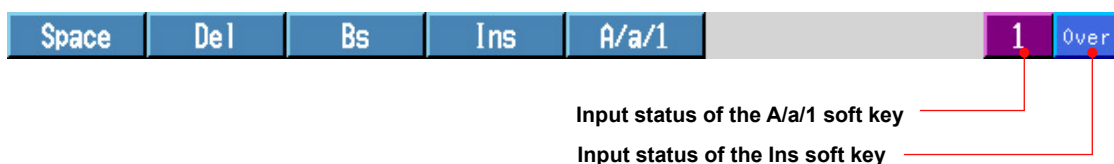

- **Space soft key:** Enters a space.
- **Del soft key:** Deletes the character at the cursor.
- **Bs soft key:** Deletes the character before the cursor.
- **Ins soft key:** Selects insert or overwrite.
Insert and overwrite mode toggles each time the Ins soft key is pressed. The selected mode is shown on the right side of the soft key display section.
- **A/a/1 soft key:** Selects uppercase alphabet (A), lowercase alphabet (a), or value (1).
The character type that you can enter changes each time you press the A/a/1 soft key. The selected character type is shown on the right side of the soft key display section.

The contents of the screens in the operation examples below may change depending on which options are installed and how the settings are configured.

On a DX with advanced security (/AS1 option) you must first insert the CF card into the slot (see page 24).

Changing the Date/Time

In this example, we will change the date to the 14th. After carrying out this step, reset the time to the correct date/time.

1. Display the operation mode screen.

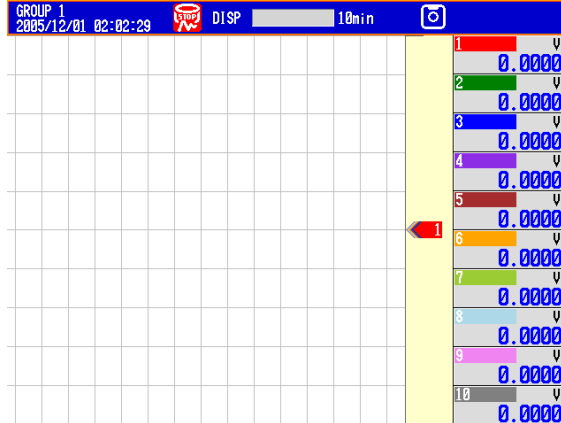

2. Press **MENU** once to display the setting menu.
3. Press the **down arrow key** once. The cursor moves to **Date/Time**.
4. Press the **right arrow key** once.

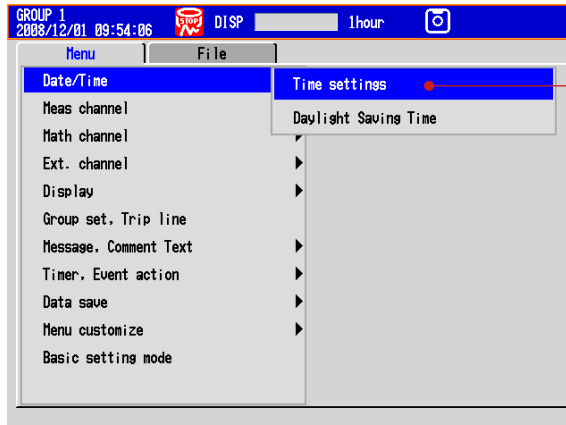

5. Press **DISP/ENTER** once to open the Time set window.

6. Set the date to 14.
 Select the input position: **Left and right arrow keys**
 Change the value: **Character/Number input keys**
 Enter the input: **DISP/ENTER**
 Cancel the setting: Press **ESC** before pressing **DISP/ENTER**.

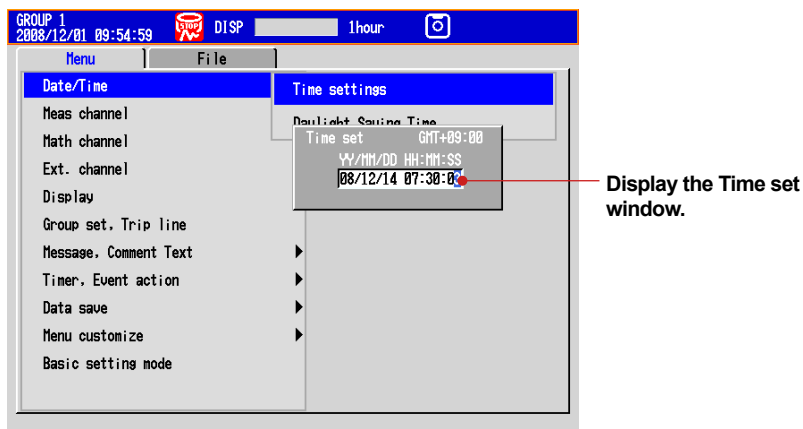

7. Press **ESC** twice or **MENU** once to return to the operation mode screen.
 On a DX with advanced security (/AS1 option):
 Press **ESC** twice or **MENU** once to display a confirmation screen. To return to the operation mode screen, select **Yes**, and press **DISP/ENTER** once.

Operation complete.

Operation Example in the Setting Mode: Changing the Input Range

Set the input range of channel 2 to thermocouple type T and 0.0 to 400.0°C.

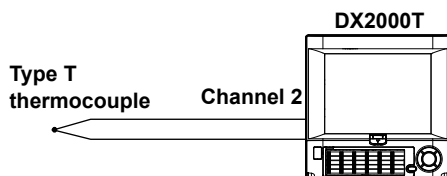

1. Display the operation mode screen.

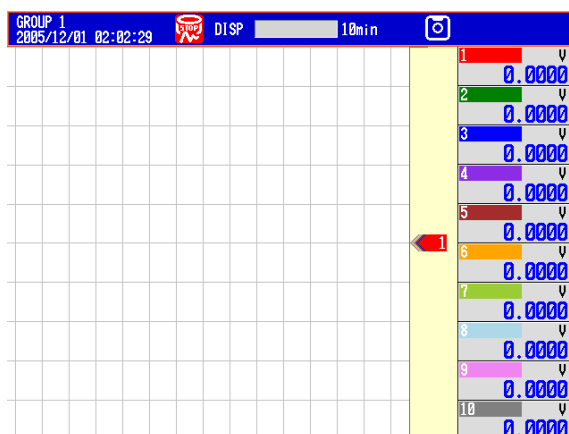

2. Press **MENU** once to display the setting menu.

3. Press the **down arrow key** twice to select **Meas channel**.
4. Press the **right arrow key** once.

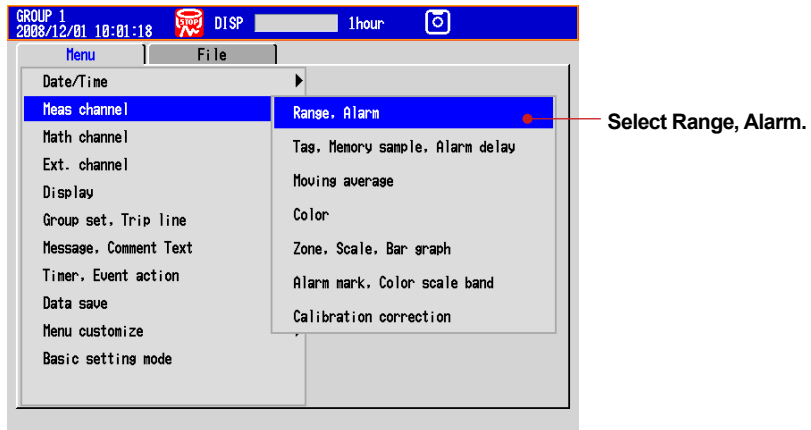

5. Press **DISP/ENTER** once.

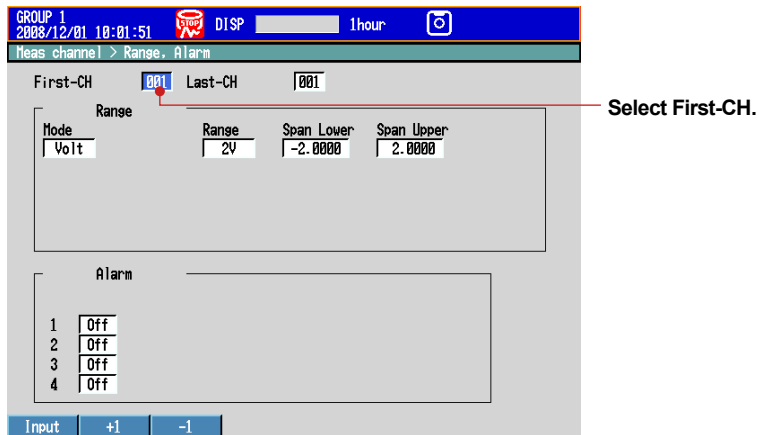

6. Press the **+1** soft key once to set **First-CH** and **Last-CH** to 2.
7. Press the **down arrow key** once to move the cursor to **Mode**.
8. Press the **TC** soft key once. The cursor moves to **Range**, and the changed items are displayed in yellow.

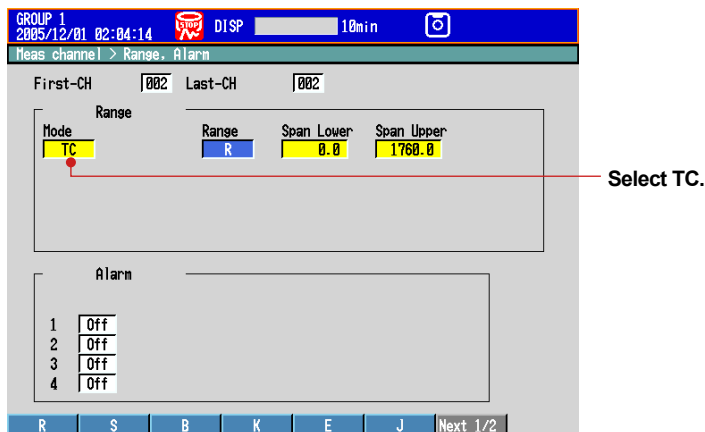

9. Press the **Next** soft key.
10. Press the **T** soft key once. The cursor moves to **Span Lower**.

11. Press the **Input** soft key once.

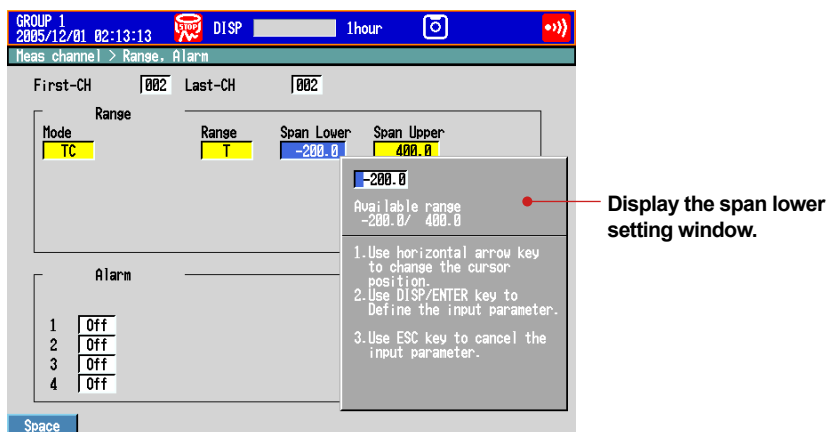

12. Enter 0.0 in the Span Lower box.
 Select the digit: **Left and right arrow keys**
 Change the value: **Character/Number input keys**
 Delete the value: **Space soft key**
 Cancel the setting: Press **ESC** before pressing **DISP/ENTER**.
13. Press **DISP/ENTER** once. The cursor moves to **Span Upper**.
14. Enter 400.0 in the Span Upper box.
 See step 12 for the procedure.
15. Press **DISP/ENTER** once. The changed items are entered, and the cursor returns to First-CH. The changed items change from yellow to white.

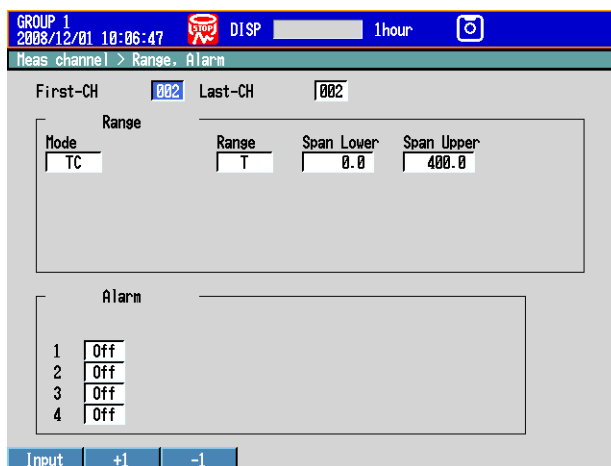

16. Press **ESC** three times or **MENU** twice to return to the operation mode screen.
 On a DX with advanced security (/AS1 option):
 Press **ESC** three times or **MENU** twice to display a confirmation screen. To return to the operation mode screen, select **Yes**, and press **DISP/ENTER** once.
 Operation complete.

Operation Example in the Basic Setting Mode: Changing the Scan Interval

In this example, we will change the scan interval. Here, the scan interval on the DX2010T is changed to 2 s. The selectable scan intervals are different on the DX2004T and DX2008T, but the procedure is the same.

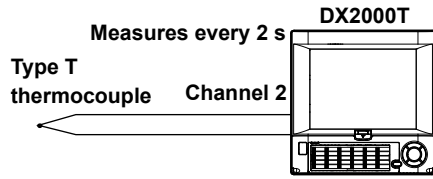

1. Display the operation mode screen.

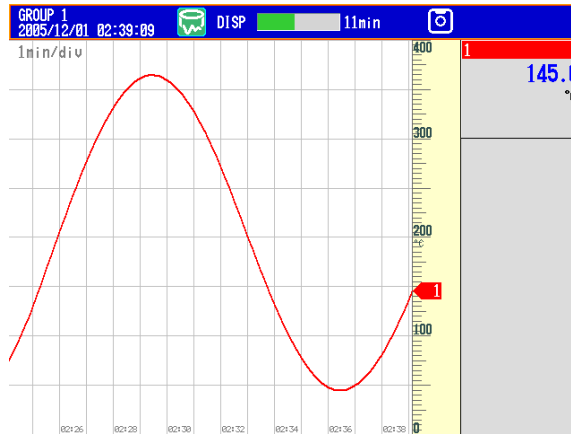

2. Press **MENU** once to display the setting menu.

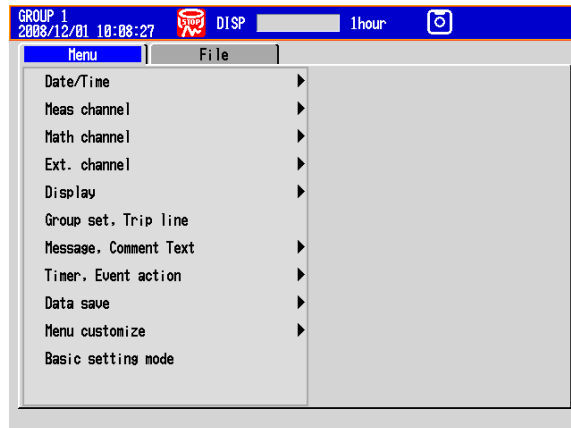

3. Hold down **FUNC** for at least 3 s.

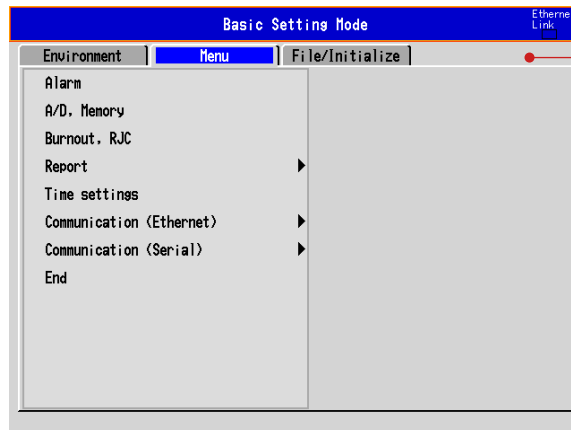

Display the basic setting mode menu
Alternatively, you can execute the following procedure to switch to Basic Setting mode. Use the **up or down arrow key** to select **Basic setting mode** on the **Menu** tab, and press **DISP/ENTER**. A confirmation window will appear. Select **Yes**, and press **DISP/ENTER**.

4. Press the **down arrow key** twice to select **A/D, Memory**.

5. Press **DISP/ENTER** once.



6. Press the **down arrow key** once to move the cursor to **Scan interval**.
7. Press the **2s** soft key once. The cursor moves to **A/D integrate**, and the changed item is displayed in yellow.
- Cancel the setting: Press **ESC** before pressing **DISP/ENTER**.
8. Press **DISP/ENTER** once. The changed items are entered, and the cursor returns to **Scan mode**.

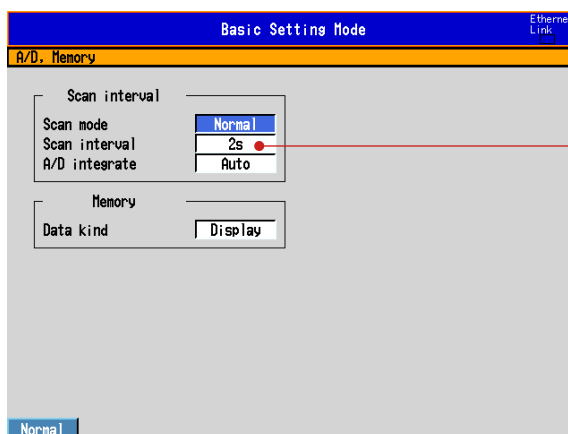

Set the scan interval to 2 s.

9. Press **ESC** once to return to the basic setting mode menu.
10. Press **ESC** once more.

Alternatively, use the **up or down arrow key** to select **End**, and press **DISP/ENTER**.

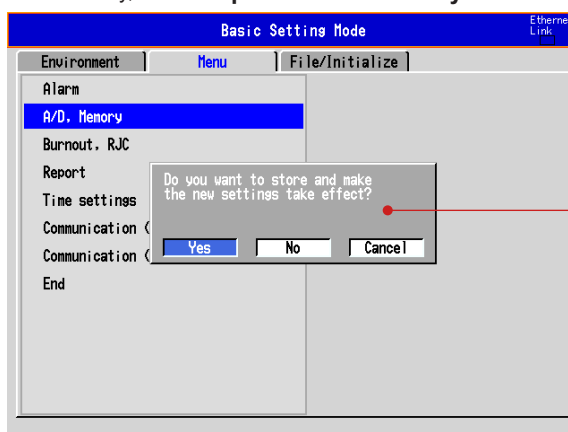

Display the confirmation window.

11. Press **DISP/ENTER** once. The settings are saved, and the DX returns to the operation mode screen.

Discard the changes:

Select **No** and press **DISP/ENTER**.

Do not end the basic setting mode:

Select **Cancel** and press **DISP/ENTER**.

Operation complete.

Inserting/Removing a CF Card

Inserting a CF Card

1. Open the operation cover.

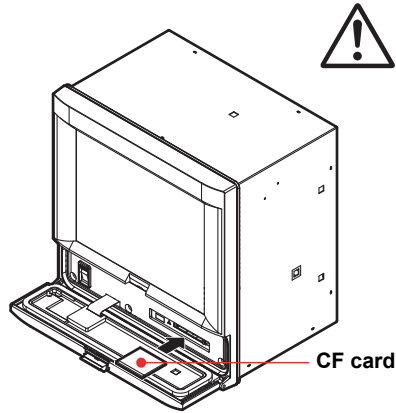

CAUTION

Forcing the CF card into the slot with the upside down may cause damage.

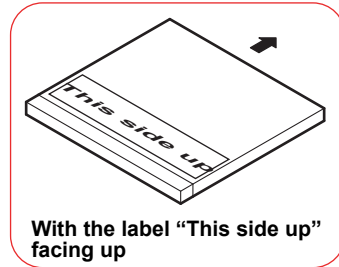

2. Insert the CF card into the slot.

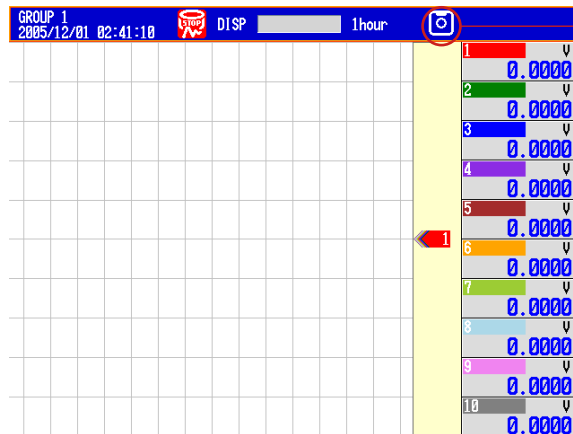

Displays the storage media icon.

3. Close the operation cover.

Operation complete.

Removing a CF Card

<Operations in the Operation Mode>

1. Press **FUNC** once.
2. Press the **Media eject** soft key once.

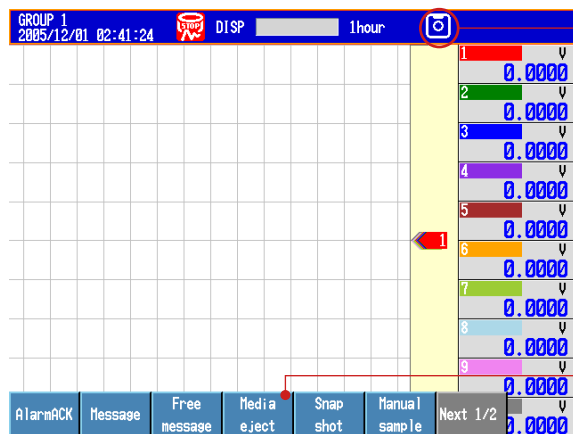

Storage media icon

Media eject

3. Press the **CF** soft key once. The message “Media can be removed safely” appears.
4. Open the operation cover.
5. Press the CF card eject button. When you eject the CF card, the CF card icon disappears.

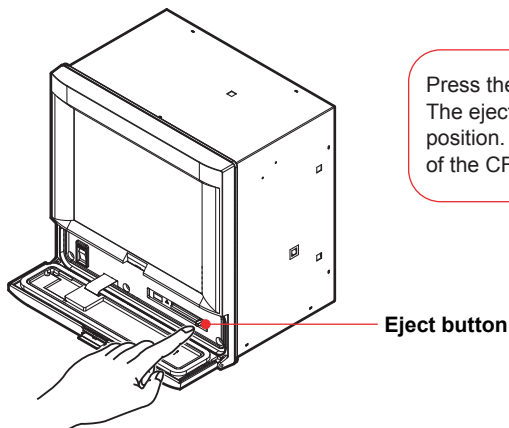

Press the eject button in until it clicks. The eject button stops at depressed position. Pinch the left and right side of the CF card and remove it.

6. Close the operation cover.
- Operation complete.

<Operation in the Basic Setting Mode>

1. Press **MENU** (to switch to setting mode), hold down **FUNC** for 3 s (to switch to basic setting mode), select the **File/Initialize** tab > **Media eject** > **CF** *, and press **DISP/ENTER**.

* Select **CF** if you have a choice between **CF** and **USB**.

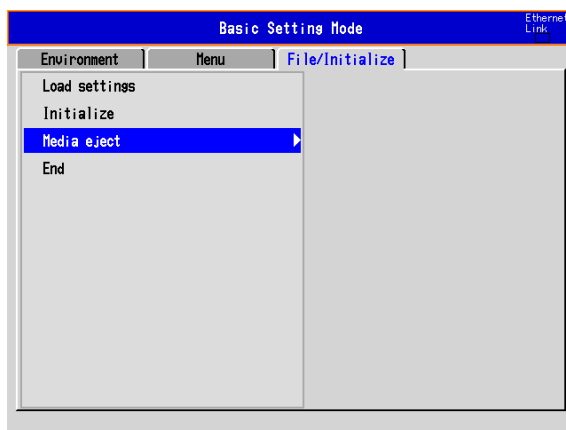

The message “Media can be removed safely” appears.

2. Open the operation cover.
3. Press the CF card eject button. Remove the CF card.
4. Close the operation cover.

Operation complete.

Note

If you remove the CF card without carrying out the media eject procedure, the message “Media was removed compulsorily” appears. Remove the CF card by carrying out the procedure above to prevent damaging the data that is stored.

Saving the Setup Data

In this example, we will save the setup data to a file named "SF2" on the CF card.

1. Display the operation mode screen.

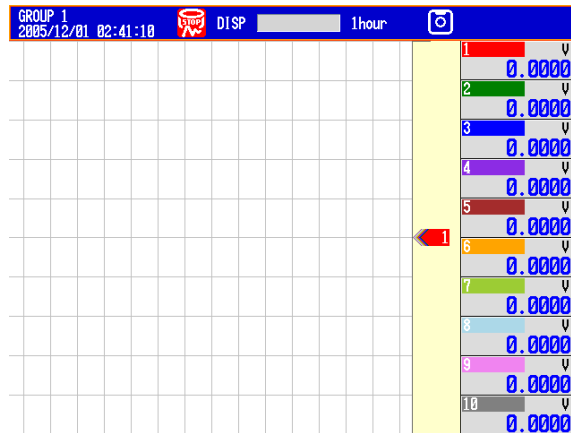

2. Press **MENU** once to display the setting menu.
3. Press the **right arrow key** once to select the **File** tab.
4. Press the **down arrow key** four times.

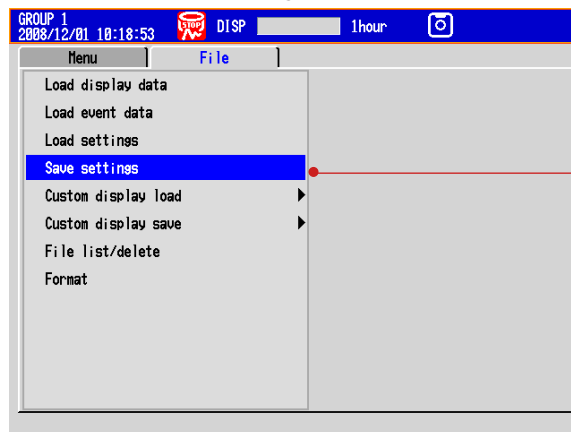

5. Press **DISP/ENTER** once.
6. Enter "SF2" for the file name.
For the input procedure, see "Entering Values and Characters" on page 16.

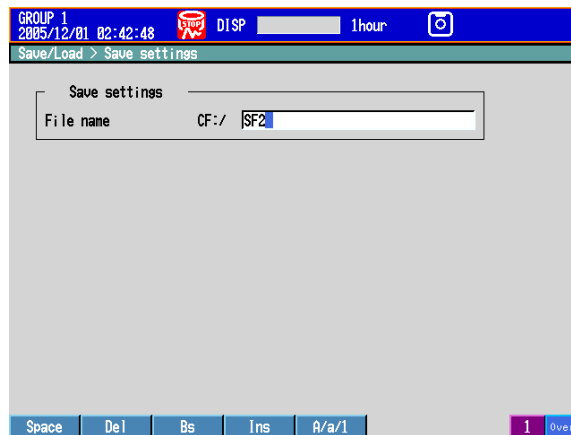

7. Press **DISP/ENTER** once. The message "Data are being saved to media" appears, and the setup data is saved.
8. Press **ESC** or **MENU** twice to return to the operation mode screen.
On a DX with advanced security (/AS1 option):

Press **ESC** or **MENU** twice to display a confirmation screen. To return to the operation mode screen, select **Yes**, and press **DISP/ENTER** once.

Operation complete.

Loading the Setup Data

In this example, we will load the setup data “SF2” from the CF card and update the DX settings.

This procedure only loads the setup data that the DX uses for setting mode. To load the setup data for both setting mode and basic setting mode, press **MENU**, hold down **FUNC** for 3 s, select the **File/Initialize** tab > **Load settings**, and press **DISP/ENTER**.

1. Display the operation mode screen.
2. Press **MENU** once to display the setting menu.
3. Press the **right arrow key** once to select the **File** tab.
4. Press the **down arrow key** three times.

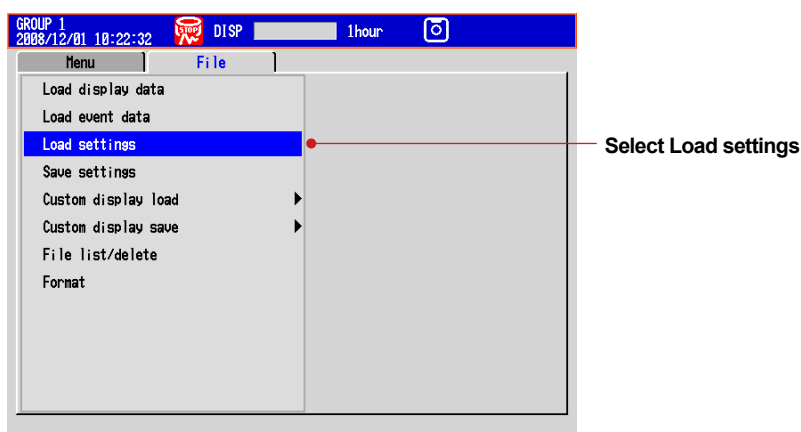

5. Press **DISP/ENTER** once to select the root directory (CF:/).
6. Press **DISP/ENTER** once to display the files in the root directory.
7. Select the file SF2 using the up and down arrow keys.

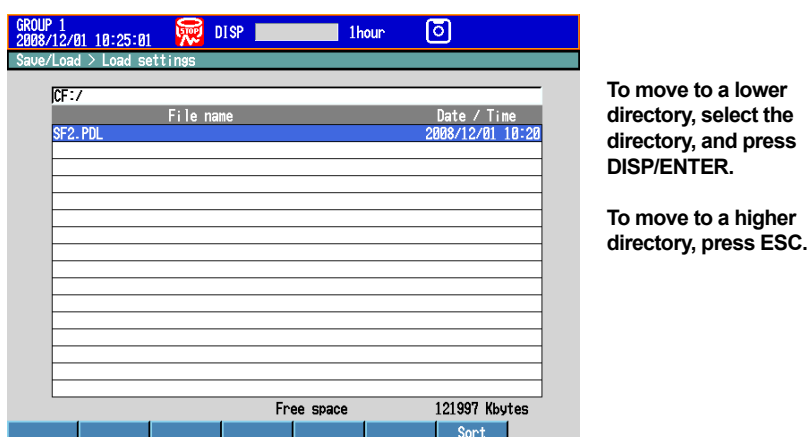

8. Press **DISP/ENTER** once. The message “File is being loaded from media” appears, and the setup data is loaded. The DX automatically returns to the operation mode screen.

Operation complete.

Setting the Input Range and Alarm

Setup Example 1: Temperature Measurement Channel

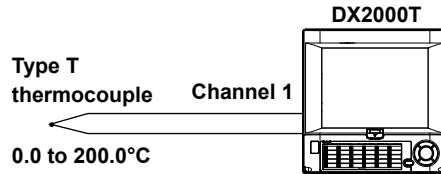

Setup Item	Description	Number in the Figure
Channel	Use channel 1.	1
Tag	TI-001	2
Sensor	Type T thermocouple	3
Input range	0.0 to 200.0°C	4

(1) Input Range

Press **MENU** (to switch to setting mode).

Select the **Menu** tab > **Meas channel** > **Range, Alarm**.

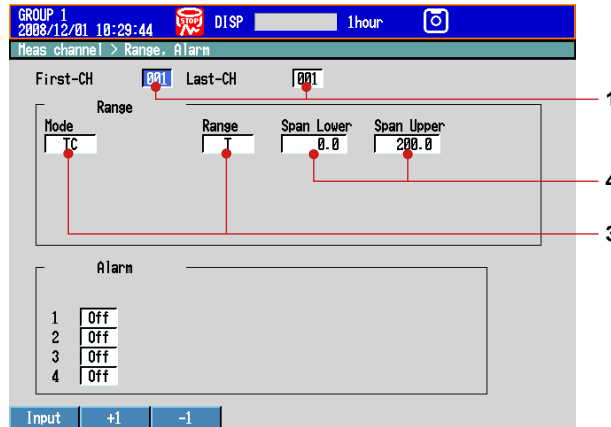

(2) Tag

Select the **Menu** tab > **Meas Channel** > **Tag, Memory sample, Alarm delay**.

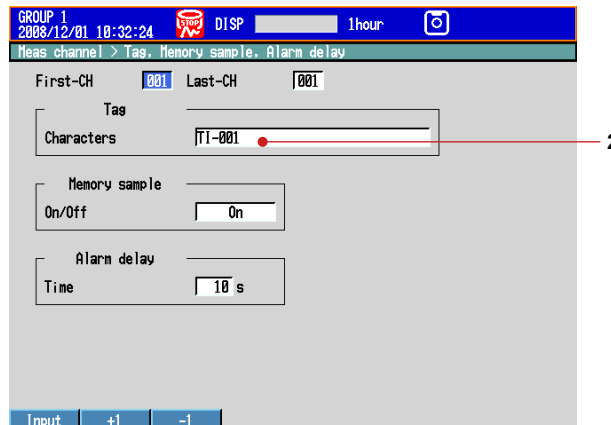

Operation complete.

Setup Example 2: Flow Rate Measurement Channel and Alarm

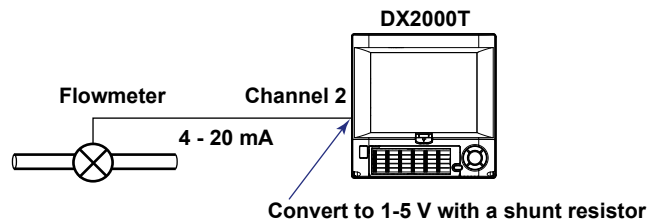

Setup Item	Description	Number in the Figure
Channel	Use channel 2.	1
Tag	FI-002	2
Input signal	1-5V	3
Input range	0.0 to 500.0 L/H	4
Alarm condition	Output an alarm if the measured value is less than or equal to 120.0 L/H. Output destination: Relay contact (I03)	5

(1) Input Range and Alarm

Press **MENU** (to switch to setting mode).

Select the **Menu** tab > **Meas Channel** > **Range, Alarm**.

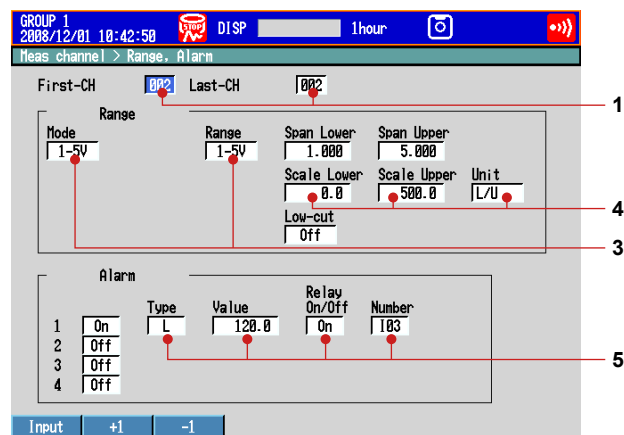

(2) Tag

Select the **Menu** tab > **Meas Channel** > **Tag, Memory sample, Alarm delay**.

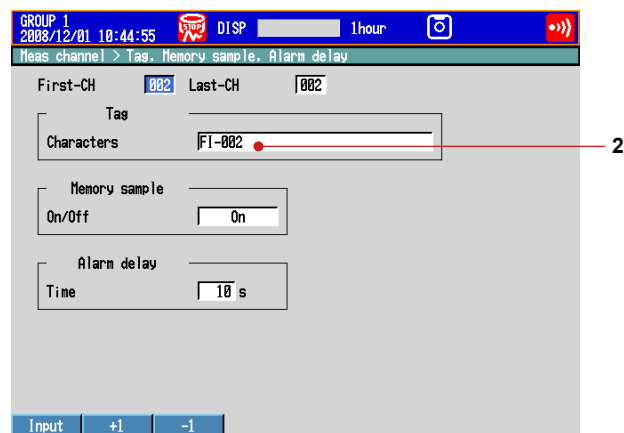

Operation complete.

Setting the Display

Setup Example 3: Assigning Channels to Groups

In this example, we will assign channels 1 and 2 to group 1.

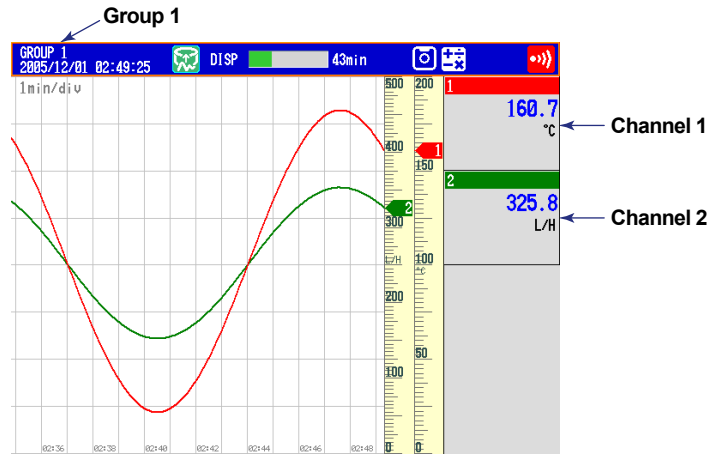

Setup Item	Description	Number in the Figure
Group	Assign channel 1 and 2 to group 1.	1

(1) Group

Press **MENU** (to switch to setting mode), and select the **Menu** tab > **Group set, Trip line**.

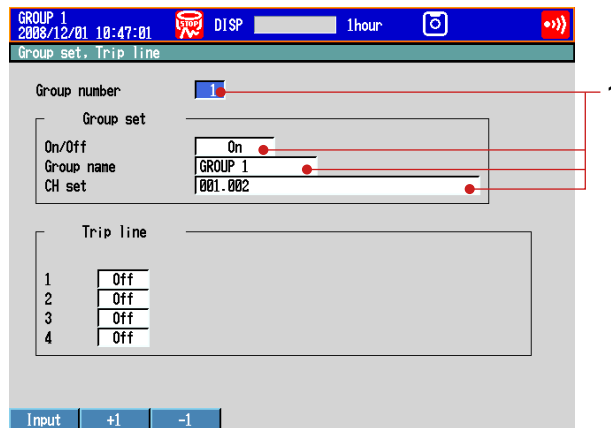

Operation complete.

Setup Example 4: Setting the Time Scale

Set the time per division of the trend waveform to 2 minutes.

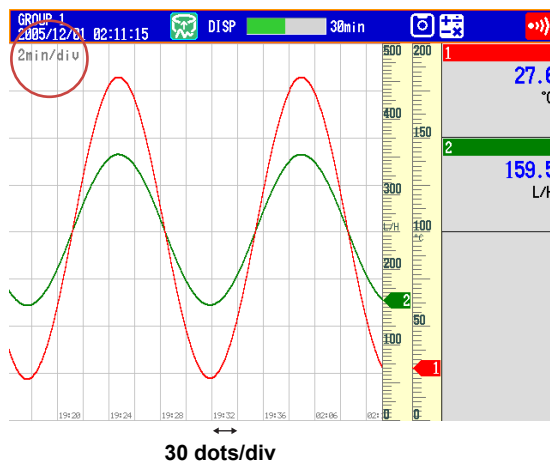

The sampling interval (the time corresponding to 1 dot) is 4 s when the trend interval is 2 min. $30 \text{ dots} \times 4 \text{ s} = 2 \text{ min}$

Setup Item	Description	Number in the Figure
Trend interval	Set the time per division to 2 minutes. The waveform is updated at every 4 s.	1

(1) Trend Interval

Press **MENU** (to switch to setting mode), and select the **Menu** tab > **Display** > **Trend/Save interval**.

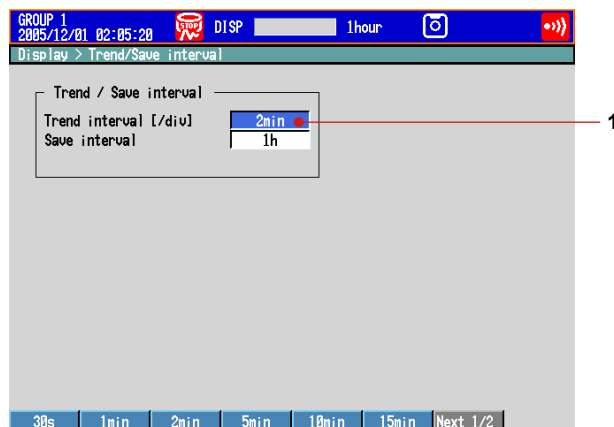

Operation complete.

Setting the Data Storage

Setup Example 5: Continuously Record Measured Data and Automatically Save

In this example, we will continuously record and save the measured data of channel 1 and 2.
 For the procedure to set the channel, see “Setting the Input Range and Alarm” on page 28.
 For the procedure to set groups, see “Setting the Display” on page 30.

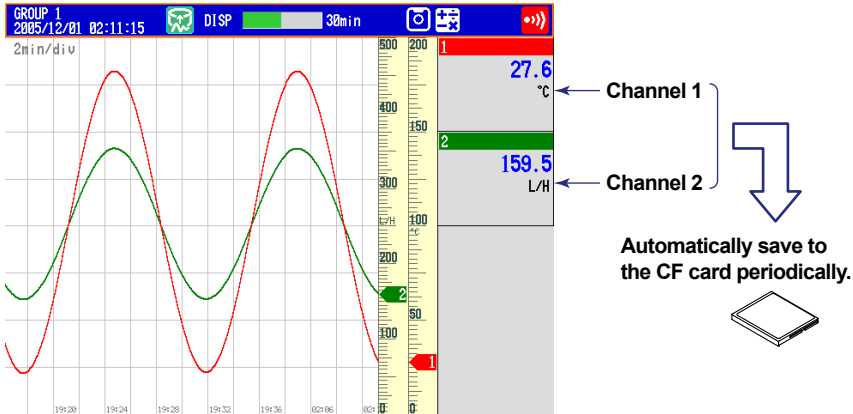

Setup Item	Description	Number in the Figure
Source channels	Channel 1 (TI-001) and channel 2 (FI-002)	1
Data to be recorded	Continuously record the display data from the start of the measurement.	2
Data storage method	Automatically store every 24 hours.	3
Sampling interval	4 seconds. Set using the trend interval. Sampling interval = (trend interval setting)/30 dots* * 40 dots when the trend interval is set to 5 or 10 seconds.	4
Data file name	Add "sample" to the file name. Example: 000123_sampleYYMMDD_HHMMSS.DAD ↑ Sequential number Date/Time of the first recorded data	5
Save Destination Directory	DATA-101	6

(1) Data to be Recorded

Press **MENU** (to switch to setting mode), hold down **FUNC** for 3 s (to switch to basic setting mode).
 Select the **Menu** tab > **A/D, Memory**.

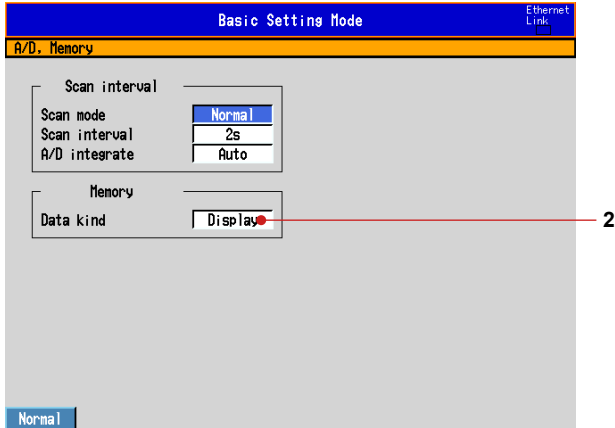

(2) Method of Storing to the CF Card (Auto Save ON/OFF)

Press **MENU** (to switch to setting mode), hold down **FUNC** for 3 s (to switch to basic setting mode).

Select the **Environment** tab > **Security, Media save, Batch**.

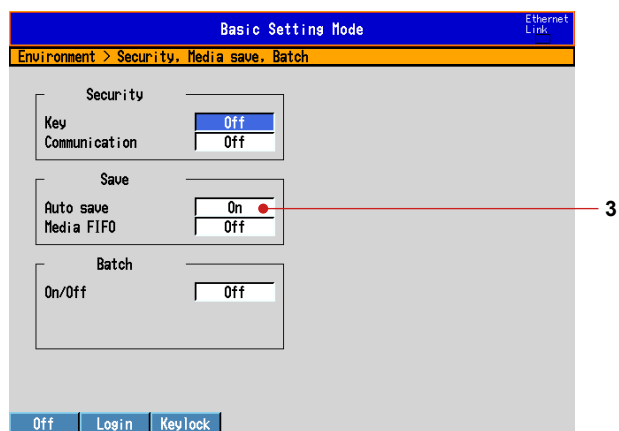
**(3) Save the Settings**

1. Press **ESC** to return to the basic setting menu.
2. Press **ESC** once more.
The window appears for you to confirm the saving of the settings.
3. Select **Yes** and press **DISP/ENTER**.
The DX returns to the operation mode screen.

(4) Channels to Be Recorded

Press **MENU** (to switch to setting mode).

Select the **Menu** tab > **Meas Channel > Tag, Memory sample, Alarm delay**.

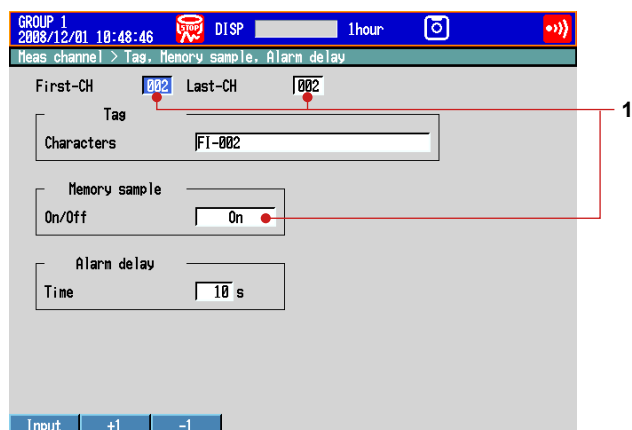

(5) Interval for Saving the Data to the CF Card

Select the Menu tab > Display > Trend/Save interval.

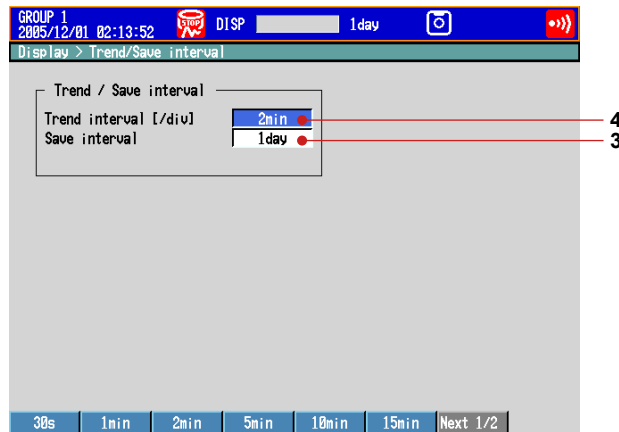

(6) Data File Name

Select the Menu tab > Data save > File header, Data file name.

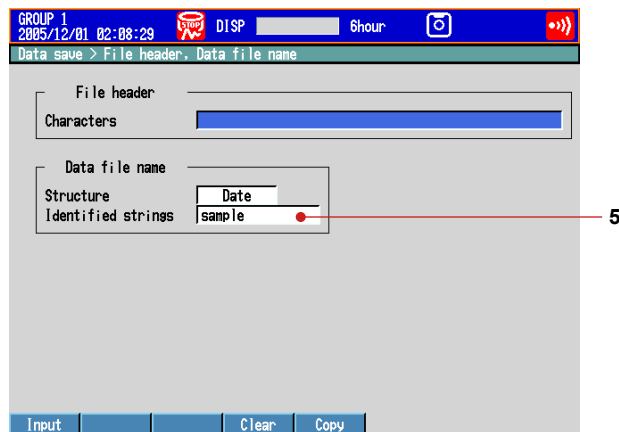

(7) Save Destination Directory (within the CF Card)

Select the Menu tab > Data save > Save directory.

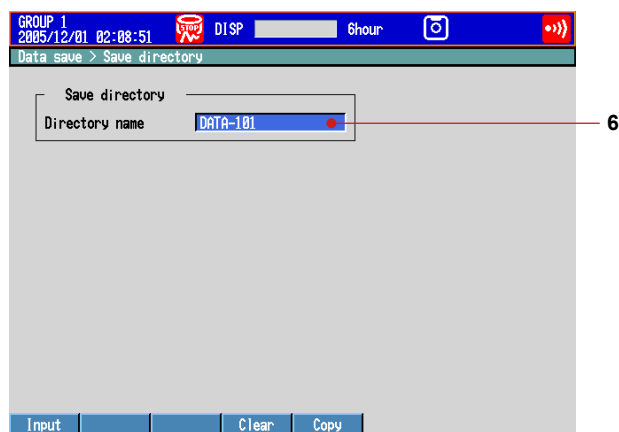

Operation complete.

Setup Example 6: Saving Measured Data at the Specified Time

Using the settings of Setup Example 5, we will save the measured data once at hour 0 every day.



All settings other than those listed below are the same as Setup Example 5.

Setup Item	Description	Number in the Figure
Data storage time	Save the data once at hour 0 every day.	7
Data storage method	Automatically save the measured data at the specified time.	8

(1) Setting the Time

Press **MENU** (to switch to setting mode).

Select the **Menu** tab > **Timer, Event action** > **Match time timer**.

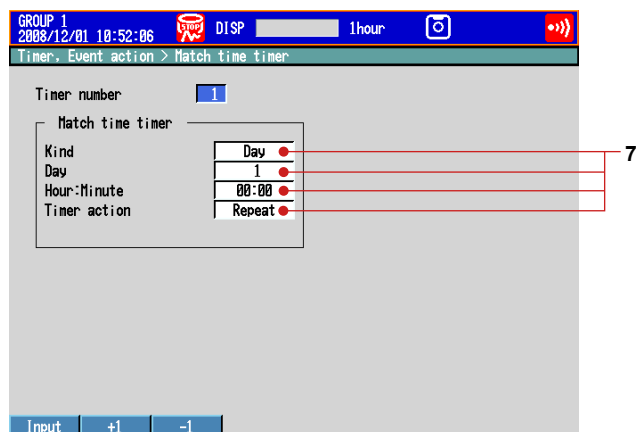

(2) Specifying the Data Storage

Press **MENU** (to switch to setting mode).

Select the **Menu** tab > **Timer, Event action** > **Event action**.

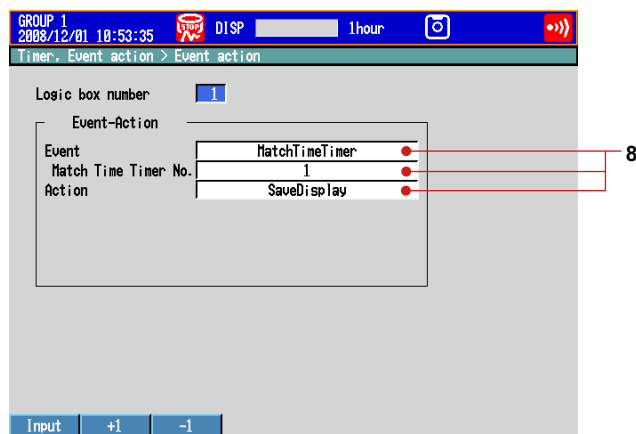

Operation complete.

Customizing the Operation

Setup Example 7: Assigning the Screen Image Data Storage Function to the USER key

In this example, we will set the DX so that the displayed screen image data can be saved to the CF card by pressing the USER key. This function is called *snapshot*. The extension of snapshot data files is .png.

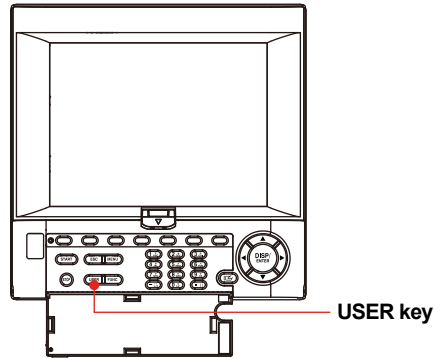

Setup Item	Description	Number in the Figure
Event action	Save the screen image data of the DX using the USER key.	1

(1) Assigning an Action to the USER Key

Press **MENU** (to switch to setting mode), and select the **Menu tab > Timer, Event action > Event action**.

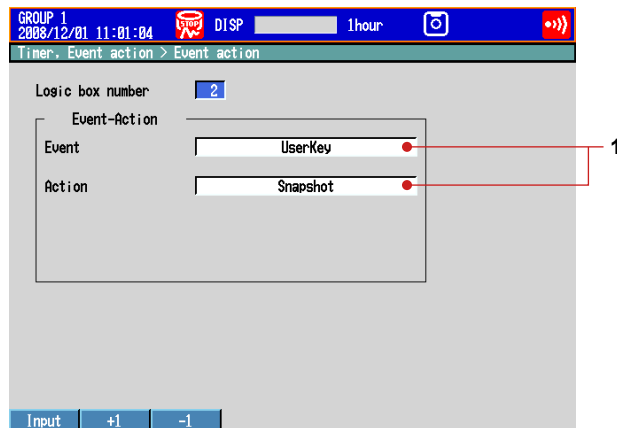

Operation complete.

Setup Example 8: Registering Frequently Used Screens to the Favorite Key

Up to eight operation mode screens that are frequently used can be registered to the Favorite key. This enables you to monitor the operation by using only the Favorite key. This feature is convenient when comparing data such as historical trends.

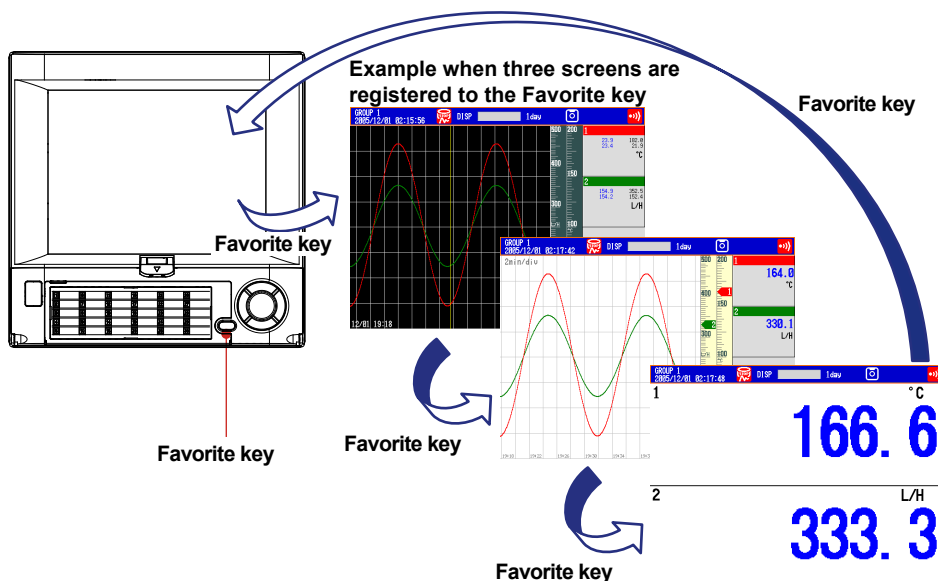

1. Display the screen to be registered.

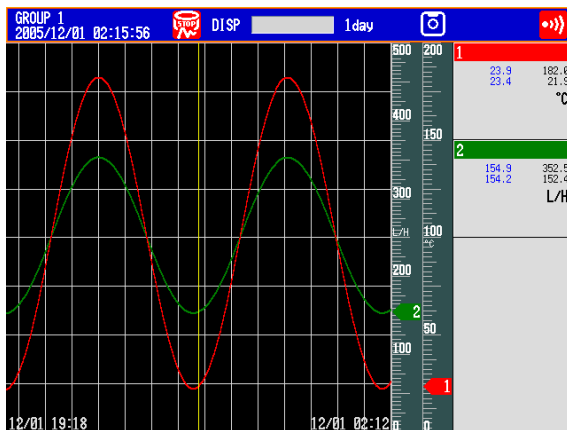

2. Press **FUNC** once to display the FUNC key menu.
3. Press the **Next** soft key to display Favorite regist.
4. Press the **Favorite regist** soft key to display the registration list window.

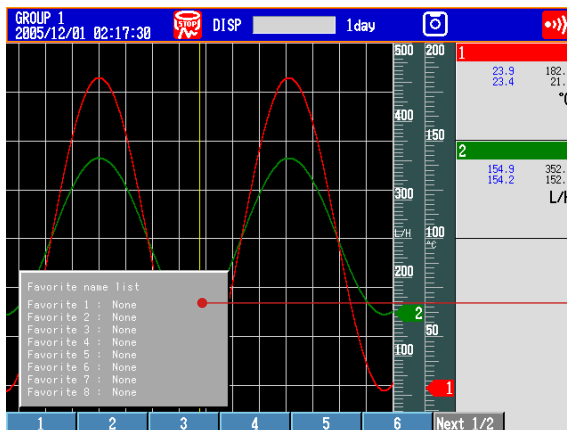

Show the registration list window.

5. Press the favorite number (1 to 8) soft key.
6. Press the **Register** soft key.

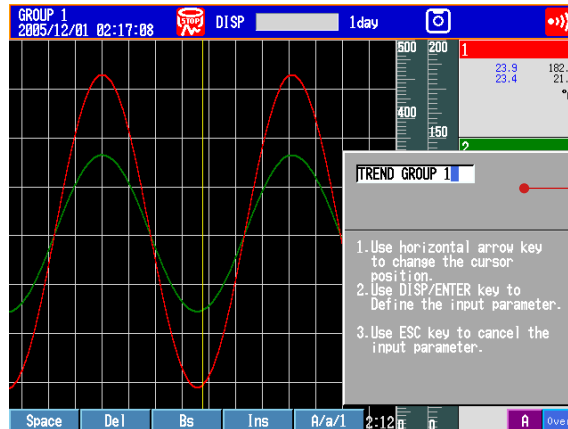

Show the window for entering the display name.

7. Enter the screen name.
Select the digit: **Left and right arrow keys**
Enter characters: **Character/Number input keys**
Delete a character: **Del soft key** or **Bs soft key**
Cancel the setting: Press **ESC** before pressing **DISP/ENTER**.
For the input procedure, see "Entering Values and Characters" on page 16.
 8. Press **DISP/ENTER** once.
 9. Repeat steps 1 to 8 to register up to eight screens.
- Operation complete.

Touch Panel Operations

Note

The touch panel is only enabled in operation mode (on the operation screen).

You can use the touch panel to perform operations such as pressing buttons on the operation screen and selecting menu and window items.

As an example, this section will explain how to use the touch panel to perform basic DX operations.

For details on the screens displayed and on how to configure the settings, see the electronic manuals.

Touch Panel Specifications



Touch Panel Specifications

Item	Description
Method	Analog resistive-membrane type
Service life	100,000 operations or more
Operation force	0.1 to 2.0 N

CAUTION

Do not push or scrape the touch panel surface with a sharp blade or pointed object. Doing so may damage the instrument.

Terminology Used in the Explanation of Touch Panel Operations

	Tap	This refers to the act of lightly pressing your finger against the screen for just a moment.
	Hold your finger down	This refers to the act of lightly pressing your finger against the screen and leaving your finger there.

Screens That You Can Use the Touch Panel to Operate

Operation Screen	Description
Historical trend	Cursor movement, waveform movement, display mode switching, calendar display (not available on the circular display), Sign record initiation, signing
Overview	Channel selection
Alarm summary	Item selection, item scrolling, sort order, sort item switching
Message summary	
Memory summary	Item selection, item scrolling, data classification switching, additional information window display
Text field	Page switching
Network information	
Historical information	
Various logs	Item scrolling, additional information window display (only the operation log)
4-panel	4-panel position selection
Multi batch	Batch selection
Custom display	Value input (communication and Modbus), button operation, switch operation (available only in operation mode; not available on the builder screen)

Displaying the Operator Menu

1. In operation mode, tap anywhere on the screen other than the status area. The Operator menu button appears in the status area.

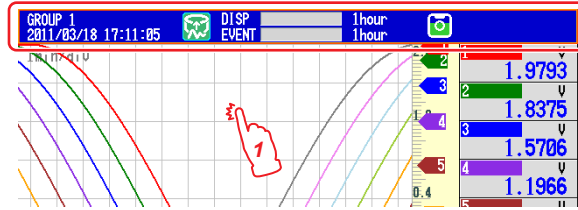

2. Tap the **Operator menu** button. The operator menu appears.

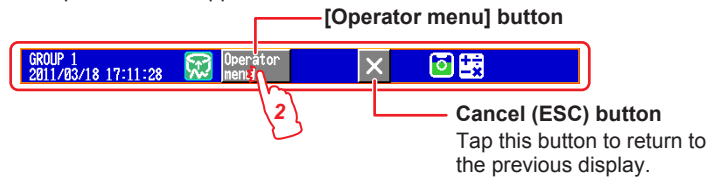

Operation complete.

The following figure shows the operator menu on the trend display.

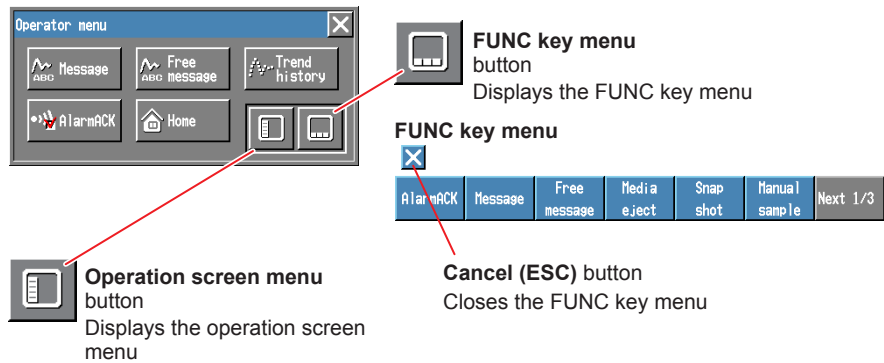

Operation screen menu



Home button



Displays the operation screen that is registered to the button as the Home screen.

Registering the Home.

1. Displays the operation screen to be registered.
2. Tap the **Operator menu** button.
3. Tap the **FUNC key menu** button. The FUNC key menu appears.
4. Tap the **Standard display** button on the FUNC key menu. The display is registered.

The default setting of the Home is the group 1 of the trend display.

► For the List of Operator Menu Items, see page 109

Starting Memory Sampling

1. Press **START** once.

On a DX with advanced security (/AS1 option) display the start recording screen*. With **START** selected, press **DISP/ENTER** once.

Memory sampling starts.

* This is because the Batch function is enabled upon shipment from the factory.

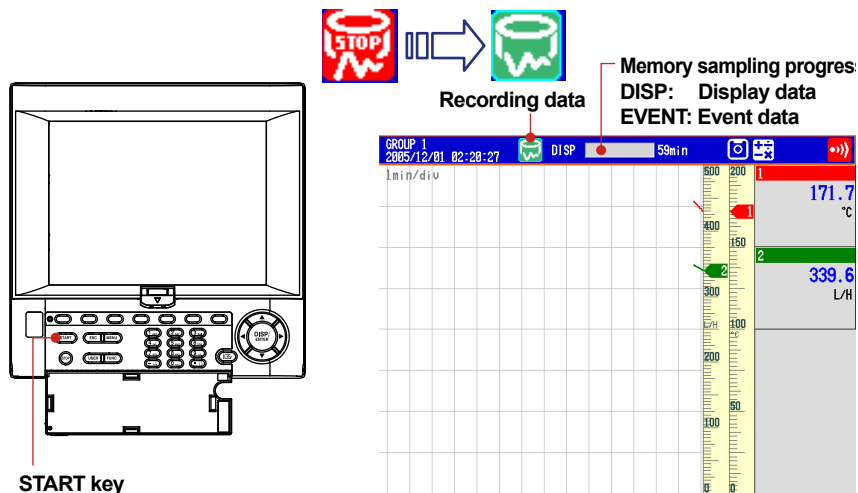

Operation complete.

Stopping Memory Sampling

1. Press **STOP** once.

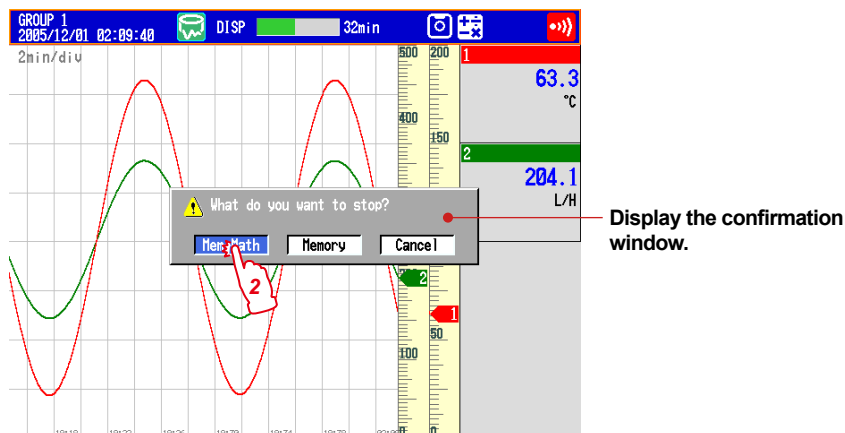

2. Tap **Mem+Math** or **Memory**.

Memory: Stops memory sampling.

Mem+Math: Stops memory sampling and computation (option).

On models without the computation function (option), the confirmation message "Do you want to stop data storage?" appears. Select **Yes**.



Stop memory sampling.

Operation complete.

Switching between Operation Screens

The Favorite key () is useful in switching between operation screens.

► For the procedure to register screens, see “Setup Example 8: Registering Frequently Used Screens to the Favorite Key” on page 37.

The following procedure shows how to use the operator menu to switch between operation screens. This example will show you how to switch from the trend display to the digital display.

1. Tap the **Operator menu** button.



2. Tap the operation screen menu button.

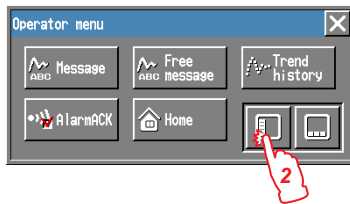

3. Tap **DIGITAL** on the operation screen menu.
4. Tap one of the groups that are displayed on the menu.

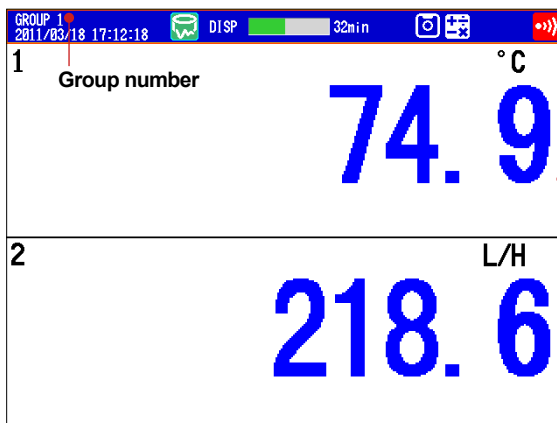
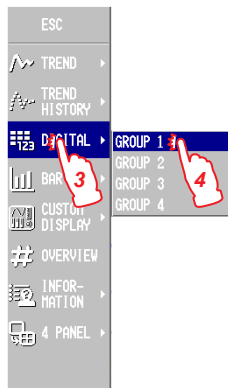

Digital display

Operation complete.

Press the **down arrow key** when the trend, digital, or bar graph is displayed to switch the display in the order trend, digital, bar graph, trend, and so on. Press the **up arrow key** to switch the display in reverse order. Press the **right arrow key** or the **left arrow key** to switch the group.

Writing the Message “START”

Registering the Word “START” in Message Number 1 (Key operation)

On a DX with advanced security (/AS1 option), this operation is only available when memory sampling is stopped.

1. Press **MENU** (to switch to setting mode), and select the **Menu tab > Message, Comment > Message > DISP/ENTER**.
2. Press **1-10** soft key.
The message, “Message numbers 1-10 can also be used for free message” appears. Press **DISP/ENTER**.
3. Press the **down arrow key**. With **message 1** selected, press the **Input** soft key. Enter “START”.

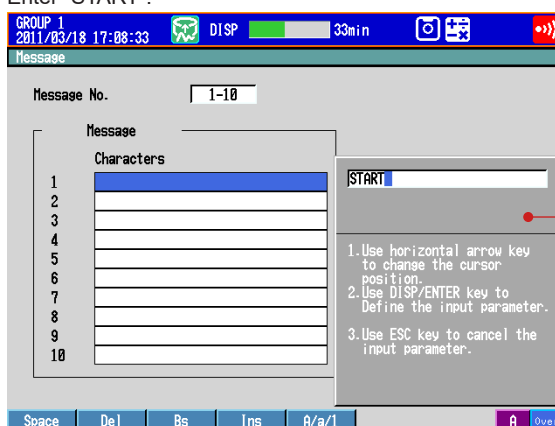

Show the message registration window.

- Select the digit: **Left and right arrow keys**
 Enter characters: **Character/Number input keys**
 Delete a character: **Del soft key or Bs soft key**
 Cancel the setting: Press **ESC** before pressing **DISP/ENTER**.

For the input procedure, see “Entering Values and Characters” on page 16.

4. Press **DISP/ENTER**.

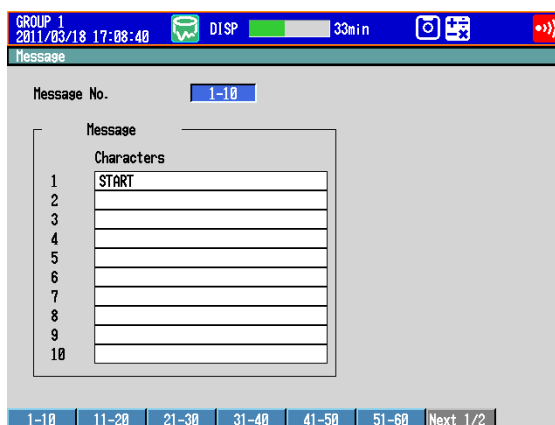

5. Press **ESC** three times or **MENU** twice to return to the operation mode screen.
On a DX with advanced security (/AS1 option):
Press **ESC** three times or **MENU** twice to display a confirmation screen. To return to the operation mode screen, select **Yes**, and press **DISP/ENTER**.

Operation complete.

Writing Message Number 1 “START”

This operation can only be carried out while memory sample is in progress. The message is displayed on the trend display. Show the trend display first.

1. Tap the **Operator menu** button.



2. Tap the **Message** button
The Message list window is displayed.

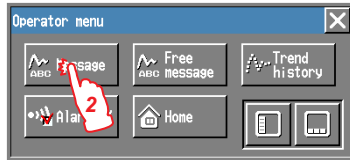

3. Tap the message that you want to write (“START”).
4. Tap the **Write** button.

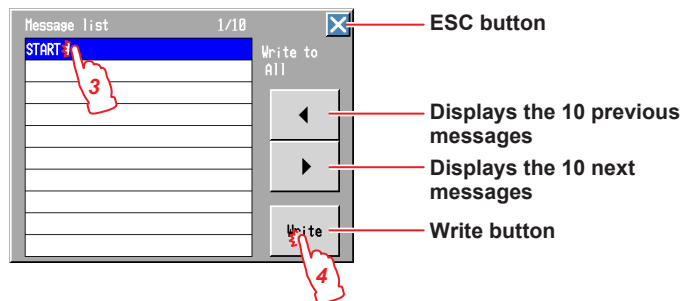

Operation complete.

Writing a Free Message

1. Tap the **Operator menu** button.



2. Tap the **Free message** button.
The Message list window is displayed.

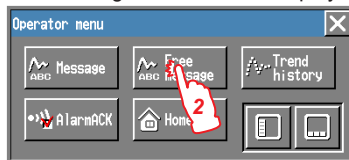

3. Tap the cell in which you want to enter the message.
The message input window is displayed.
ESC button

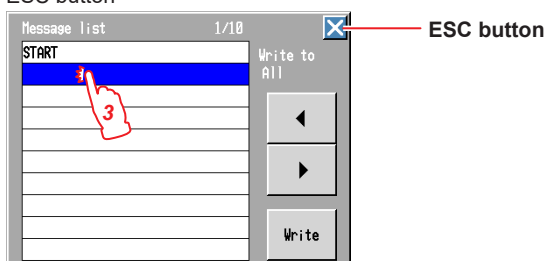

4. Enter the message, and then tap the **ENT** button.
This writes the entered message.

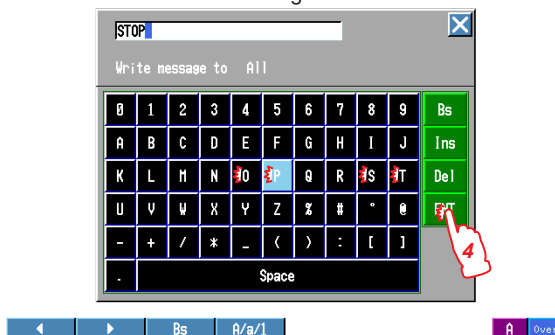

Operation complete.

Displaying Previously Measured Data (Historical trend display)

Displaying the Historical Trend from the Trend Display

1. Tap the **Operator menu** button.



2. Tap the **Trend history** button or the operation screen menu button.
Operator menu on the trend display

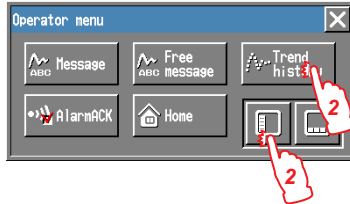

If you have tapped the **Trend history** button, the procedure is finished.
The historical trend is displayed on the trend display group that was displayed in step 1.

3. Tap **Trend history** on the operation screen menu.
4. Tap one of the groups that are displayed on the menu.

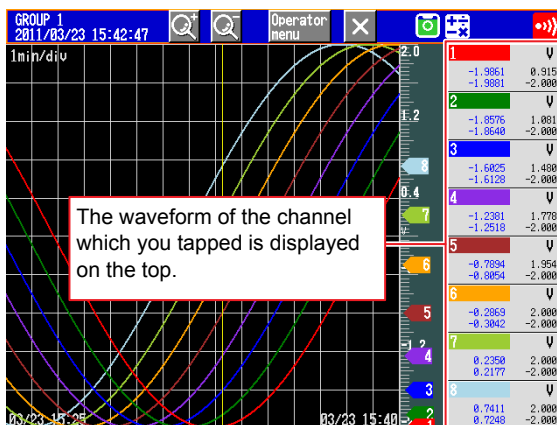

Operation complete.

Returning to the Display That Was Shown before the Historical Trend

1. Tap the **Operator menu** button.



2. Tap the **Exit history** button.

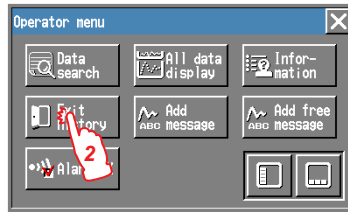

Operation complete.

Expanding and Reducing the Time Axis

Zoom buttons

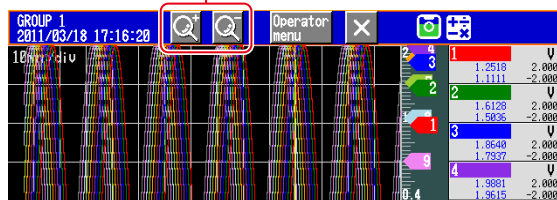

- Tap this button to expand the time axis.
- Tap this button to reduce the time axis.

Moving the Cursor

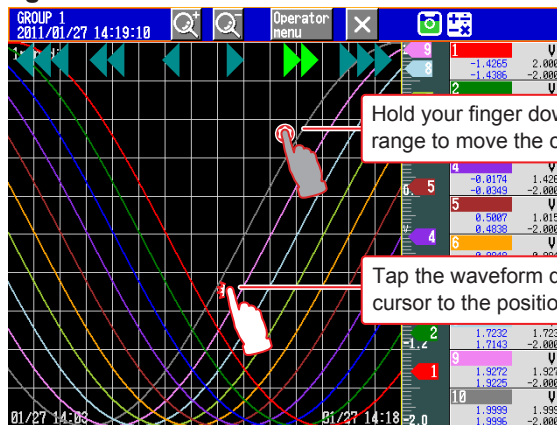

Hold your finger down in the waveform display range to move the cursor.

Tap the waveform display range to move the cursor to the position that you tapped.



Position	Description	Position	Description
1	Moves the cursor to the left (down) by 10 dots	4	Moves the cursor to the right (up) by 10 dots
2	Moves the cursor to the left (down) by 2 divisions	5	Moves the cursor to the right (up) by 2 divisions
3	Moves the cursor to the left (down) by half a page	6	Moves the cursor to the right (up) by half a page

Items in parentheses are for the vertical trend display.

Specifying the Display Range

Items in parentheses are for the vertical trend display.

1. Tap the **Operator menu** button.



2. Tap the **All data display** button.

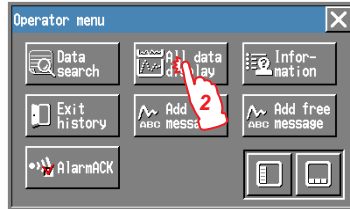

The waveform of the entire data range is displayed at the top (right) section of the historical trend display.

3. On the all data display, tap the area that you want to view.

The frame that indicates the display range moves to the position that you tapped.

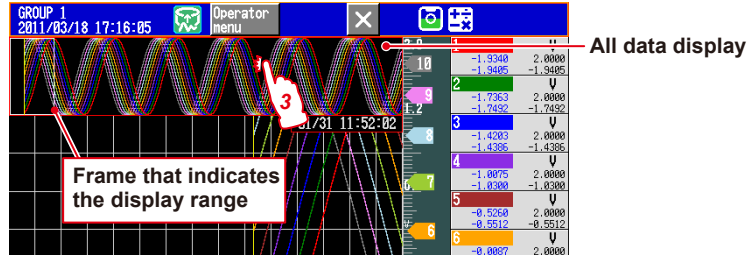

4. Tap somewhere in the waveform display range outside of the all data display.

The specified range is displayed.

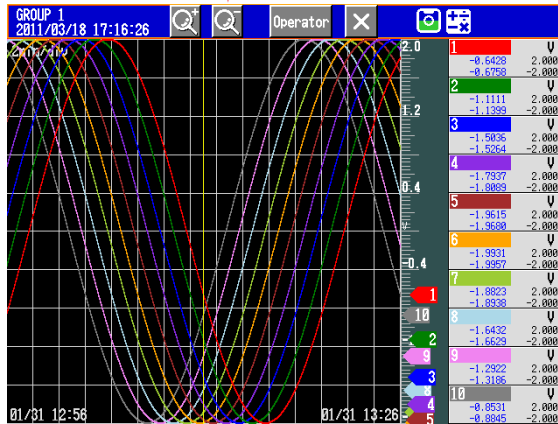
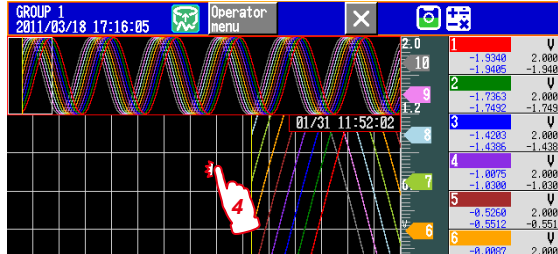

Operation complete.

Displaying the Measured Data from a Specified Date and Time

You can search for measured data at the specified date and time and display the results. You can search the display data or event data in the DX internal memory.

1. Tap the **Operator menu** button.



2. Tap the **Data search** button.
The calendar is displayed.

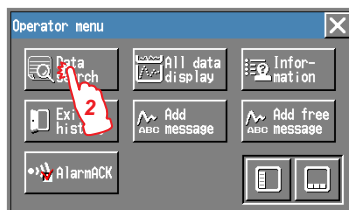

3. Tap the date that you want to display.
If the selected date has display data and event data, the data type selection window is displayed.

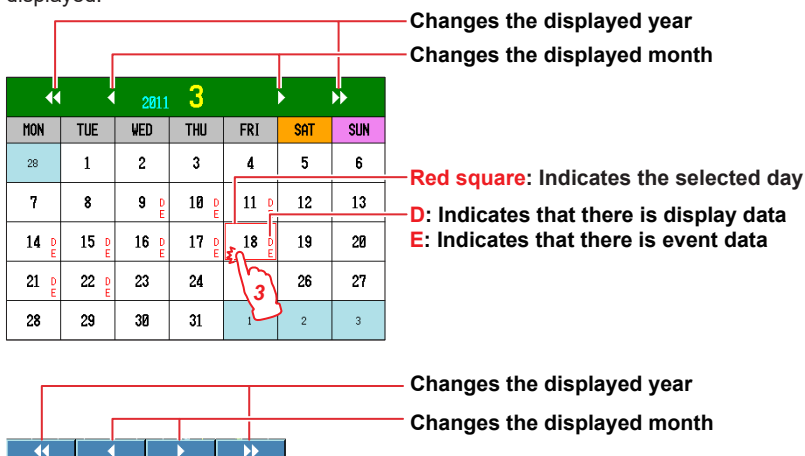

4. Tap **Display** or **Event**.

5. Tap the **OK** button.

The Input Search Time window is displayed.

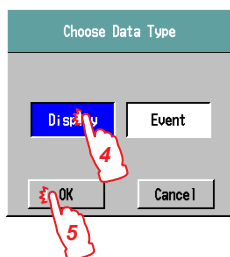

- Tap the number buttons to enter the time, and then tap the **OK** button.
The screen that corresponds to the entered search time is displayed.

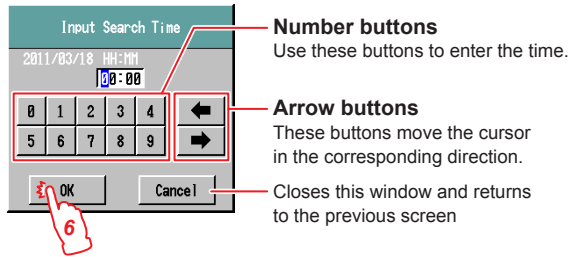

Operation complete.

Writing an Additional Message or an Additional Free Message

- Tap the position where you want to write the message.
The cursor moves to the tapped position.

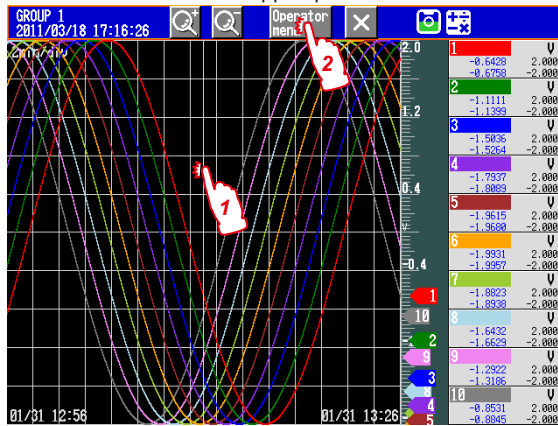

- Tap the **Operator menu** button.
- Tap the **Add message** or **Add free message** button.
The Message list window is displayed.

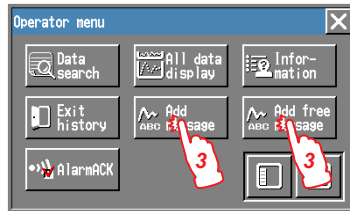

- For the procedure for writing additional messages, see “Writing the Message ‘START’” on page 43.
- For the procedure for writing additional free messages, see “Writing a Free Message” on page 45.

Operation complete.

Operating Other Screens

Overview Screen

- The cursor (the white frame) moves to the position that you tap (for selecting channels).
- When you tap the selected channel, the cursor turns off.

Channel	Value	Channel	Value	Channel	Value	Channel	Value
1	1.9871 V	11	-1.6877 V	21	0.7974 V	31	0.2264 V
2	1.9780 V	12	-1.8608 V	22	1.2450 V	32	-0.2956 V
3	1.8341 V	13	-1.9871 V	23	1.6877 V	33	-0.7974 V
4	1.5652 V	14	-1.9780 V	24	1.8608 V	34	-1.2450 V
5	1.1896 V	15	-1.8341 V	25	1.9871 V	35	-1.6877 V
6	0.7330 V	16	-1.5652 V	26	1.9780 V	36	-1.8608 V
7	0.2264 V	17	-1.1896 V	27	1.8341 V	37	-1.9871 V
8	-0.2956 V	18	-0.7330 V	28	1.5652 V	38	-1.9780 V
9	-0.7974 V	19	-0.2264 V	29	1.1896 V	39	-1.8341 V
10	-1.2450 V	20	0.2956 V	30	0.7330 V	40	-1.5652 V

Alarm Summary, Message Summary, and Memory Summary Screens

Cursor

- Moves the cursor a half page up
- Moves the cursor two lines up
- Moves the cursor two lines down
- Moves the cursor a half page down

Sort symbol

- ▲ Ascending order
- ▼ Descending order

Tap an item in the title area to sort the list by that item.

The cursor moves to the entry that you tap.

Hold your finger down to scroll through the data.

Channel	Time	Alarm
1	2011/03/23 15:07:51	OFF
2	2011/03/23 15:06:51	OFF
3	2011/03/23 15:03:26	ON
4	2011/03/23 15:02:26	ON
5	2011/03/23 15:01:26	ON
6	2011/03/23 15:00:26	ON
7	2011/03/23 14:57:26	OFF
8	2011/03/23 14:56:57	ON
9	2011/03/23 14:55:25	OFF
10	2011/03/23 14:54:57	ON
11	2011/03/23 14:54:26	ON
12	2011/03/23 14:54:25	ON

Tap one of these items to switch the displayed data.

Start	End Time	Data	Factor
2011/03/23 15:32	2011/03/23 15:54:46	128	Stop
2011/03/23 15:40	2011/03/23 15:45:08	525	Stop
2011/03/23 14:27:40	2011/03/23 15:27:38	1800	Auto Save
2011/03/23 13:27:40	2011/03/23 14:27:38	1800	Auto Save

On DXs with the /AS1 advanced security option, if Add. info is displayed in the lower left of the memory summary screen, tap Add. info to display the signature information screen.

Calibrating the Touch Panel and Checking the Calibration

Calibrating the Touch Panel

1. Press **MENU** (to switch to setting mode), hold down **FUNC** for 3 s (to switch to basic setting mode), select the **File/Initialize** tab > **Touch panel calibration** > **Execute**, and press **DISP/ENTER**.
2. Follow the instructions on the screen, and touch the center of the circle that is indicated by an arrow.

When you have performed this operation on five points, the touch panel is calibrated.

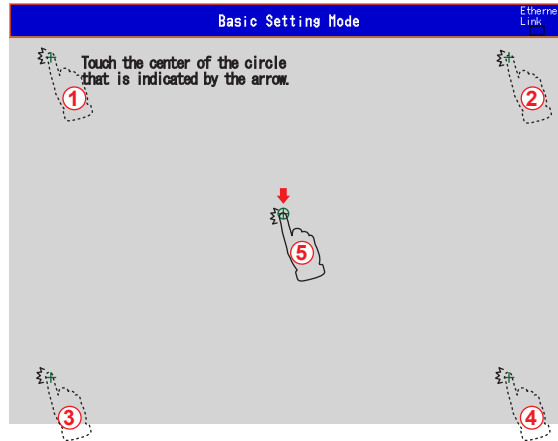

3. Press **ESC** three times.
A confirmation window is displayed.
4. Select **Yes**, and press **DISP/ENTER**.
The DX2000T returns to the operation mode screen.

Checking the Touch Panel Calibration

1. Press **MENU** (to switch to setting mode), hold down **FUNC** for 3 s (to switch to basic setting mode), select the **File/Initialize** tab > **Touch panel calibration** > **Check**, and press **DISP/ENTER**.
2. Touch anywhere on the screen outside of the status area.
If a plus sign is displayed in green at the position that you touched the screen, the touch panel has been calibrated correctly.
If the plus sign is displayed away from the position that you touched the screen, recalibrate the touch panel.

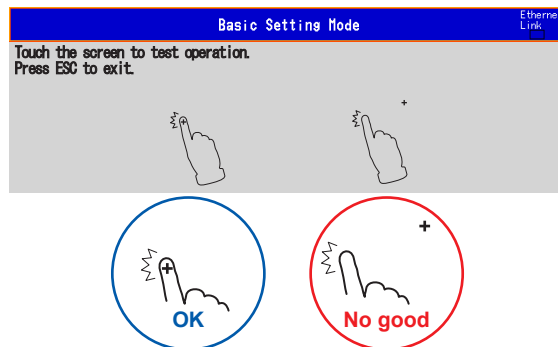

3. Press **ESC** three times.
A confirmation window is displayed.
4. Select **Yes**, and press **DISP/ENTER**.
The DX2000T returns to the operation mode screen.

Preventing Touch Panel Operations (Locking the touch panel)

This section explains the settings and the procedure that are used to prevent touch panel operations.

Locking the Touch Panel

Setup Screen

Press **MENU** (to switch to setting mode), hold down **FUNC** for 3 s (to switch to basic setting mode), and select the **Environment** tab > **Security, Media save**

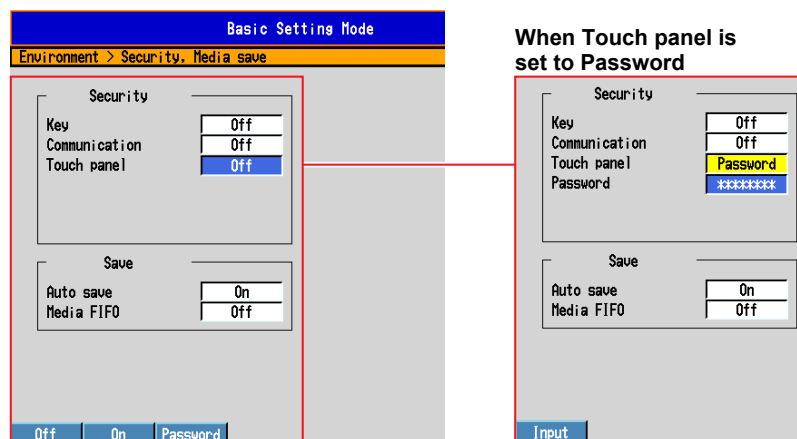

Setup Items

- **Security > Touch panel**

Setting	Description
Off	Touch panel operations are not disabled.
On	Touch panel operations are disabled.
Password	Touch panel operations are disabled. The password is used to unlock the touch panel. (The password is up to eight alphanumeric characters.) The password is displayed as "*****."

Procedure

Locking the Touch Panel

1. Tap the **FUNC** key menu button on the operator menu.
The **FUNC** key menu appears.
2. Tap the **TouchPnl Lock** button on the **FUNC** key menu.
This locks the touch panel operations.

Unlocking the Touch Panel

1. In operation mode, press **FUNC**.
The **FUNC** key menu appears.
2. Press the **TouchPnl Lock** soft key.
If **Security > Touch panel** is set to **On**, these steps are sufficient to unlock the touch panel. If **Security > Touch panel** is set to **Password**, a window for entering the password is displayed. You can use the touch panel to operate this window.
3. Enter the password, and then tap **ENT**.
This unlocks the touch panel.

Setting Command

- ▶ For details on the setting commands, see the DX1000/DX1000N/DX2000 Communication Interface User's Manual, IM 04L41B01-17E.

Setting Command

SM Sets the custom menu

Function menu setting

p1 Type (FUNC)
p2 and up Menu items to display

The selected function is displayed in the specified order on the menu.
Menus that are not specified are not displayed.

TOUCHPANEL_LOCK Locks and unlocks the touch panel

Connecting to an Ethernet Network

Setup Example 9: Monitoring the DX on a PC Browser

In this example, we will connect the PC and the DX via hub in a one-to-one relationship and display and monitor the DX screen on a browser on the PC.

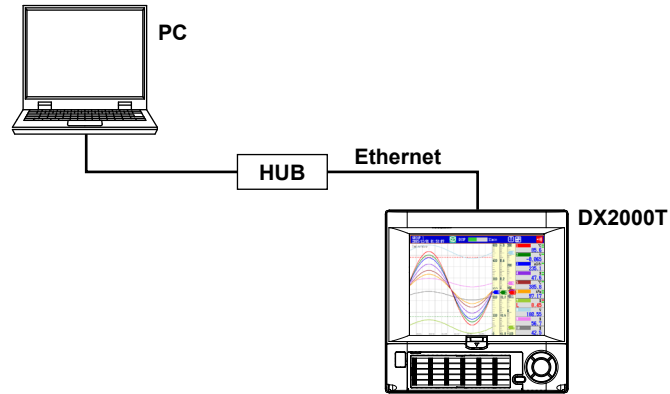

DX

Setup Item	Description	Number in the Figure
IP address	192.168.1.101	1
Subnet mask	255.255.255.0	
Web server function	Monitor from a Web browser on the PC using operator page.	2
Access to the DX	Display the Web page and do not set access privileges.	3

PC

Setup Item	Description	Number in the Figure
IP address	192.168.1.100	4
Subnet mask	255.255.255.0	

(1) IP Address of the DX

Press **MENU** (to switch to setting mode), hold down **FUNC** for 3 s (to switch to basic setting mode).

Select the **Menu** tab > **Communication (Ethernet)** > **IP address, Host settings**.

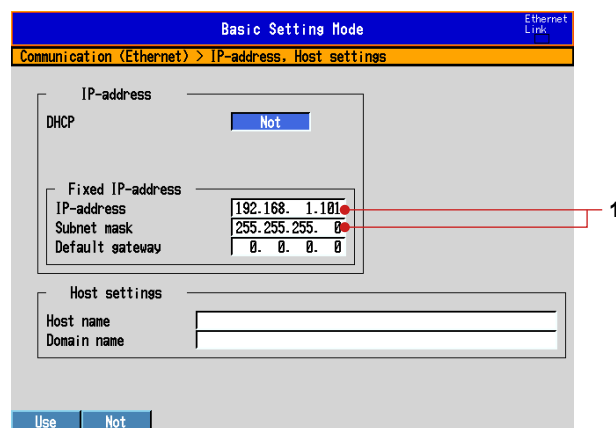

(2) Enabling the Web Server Function on the DX

Select the **Menu** tab > **Communication (Ethernet)** > **Server** > **Server**.

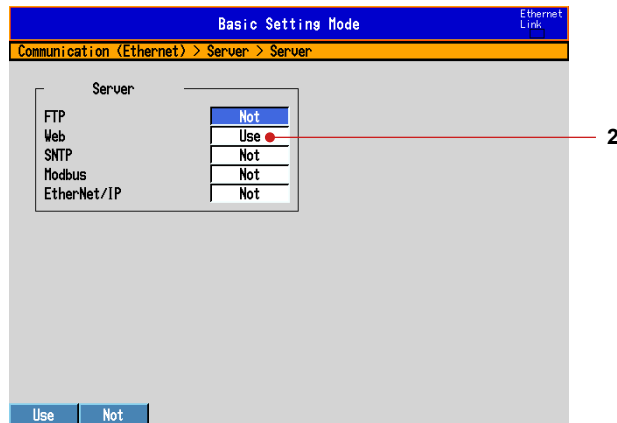

(3) Display the DX Screen on the PC

Select the **Menu** tab > **Communication (Ethernet)** > **Web page**.

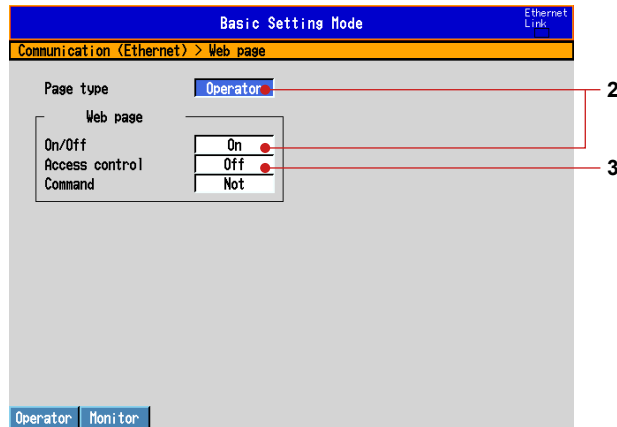

(4) Save the Settings

1. Press **ESC** twice to return to the basic setting menu.
2. Press **ESC** once more.
The window appears for you to confirm the saving of the settings.
3. Select **Yes** and press **DISP/ENTER**.
The DX returns to the operation mode screen.

(5) Setting the PC

Set the IP address and subnet mask on the PC.

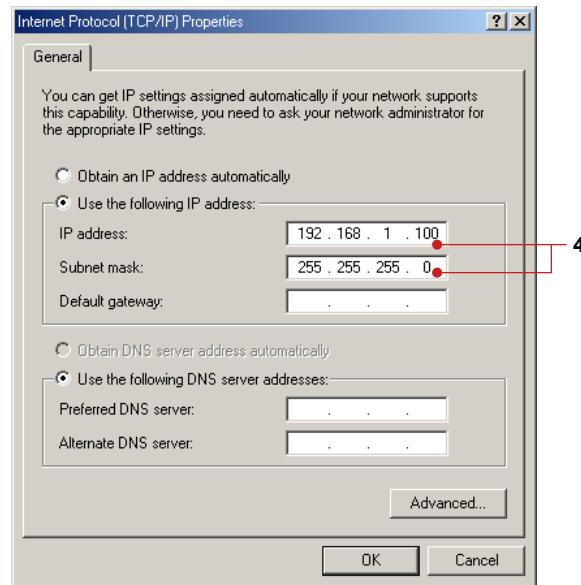
**(6) Checking the Connection**

Send the command below from the PC and check that a correct response is returned.

Send

```
>ping 192.168.1.101
```

Response example

```
>Reply from 192.168.1.101: bytes=32 time<10ms TTL=255
```

(7) Displaying the DX Screen on the Browser

1. Start the browser on the PC.
2. Enter the following URL.
`http://192.168.1.101/operator.htm`
3. Check that the DX screen appears.

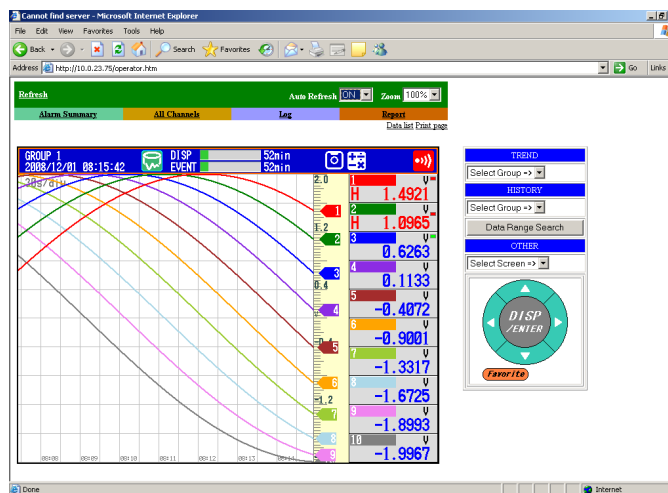

Operation complete.

Setup Example 10: Automatically Transferring the Measured Data File to an FTP Server

In this example, we will configure the DX so that the measured data is automatically transferred to an FTP server on the network when the measured data is automatically saved to the CF card.

This example assumes that the following network environment is used: DHCP enabled, automatically obtain the DNS server information, and automatically register the DX host name to the DNS server. Set the parameters according to your network environment.

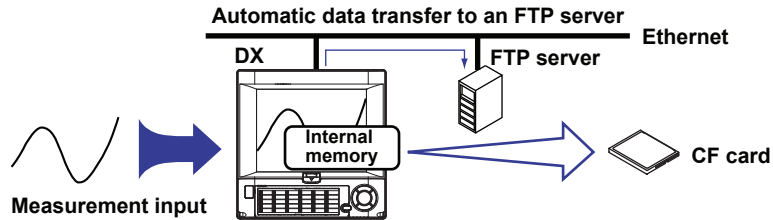

Setup Item	Description	Number in the Figure
Host name	DAQSTATION1	1
Obtain the IP address	Obtain automatically (DHCP)	2
Type of data to be transferred	Acquired measured data	3
FTP server	Server name abcdefg.co.jp	4
	Port number 21	
	Login name FTPUSER1	
	Password a1234	

(1) Host Settings and IP Address of the DX

Press **MENU** (to switch to setting mode), hold down **FUNC** for 3 s (to switch to basic setting mode). and select the **Menu** tab > **Communication (Ethernet)** > **IP address, Host settings**.

2 Automatically obtain the DNS server information.
Automatically register the DX host name to the DNS server.

1

(2) Data to Be Transferred to the FTP Server

Select the **Menu** tab > **Communication (Ethernet)** > **FTP client** > **FTP transfer file**.

3

(3) Connected setting FTP Server

Select the **Menu** tab > **Communication (Ethernet)** > **FTP client** > **FTP connection**.

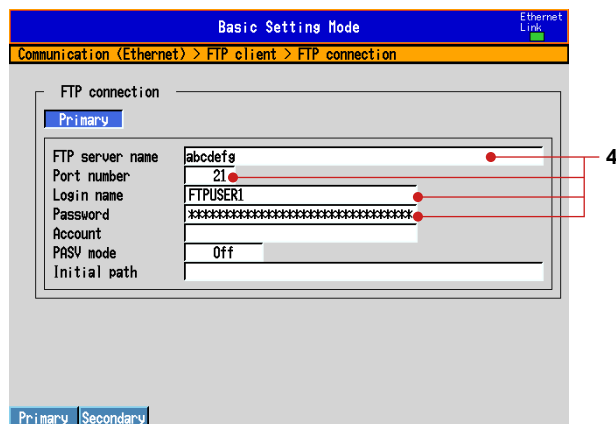

(4) Save the Settings

1. Press **ESC** three times to return to the basic setting menu.
2. Press **ESC** once more.
The window appears for you to confirm the saving of the settings.
3. Select **Yes** and press **DISP/ENTER**.
The DX returns to the operation mode screen.

Operation complete.

Executing a File Transfer Test

1. Press **FUNC** once to display the FUNC key menu.
2. Press the **Next** soft key until FTP test is displayed, and then press the **FTP test** soft key.

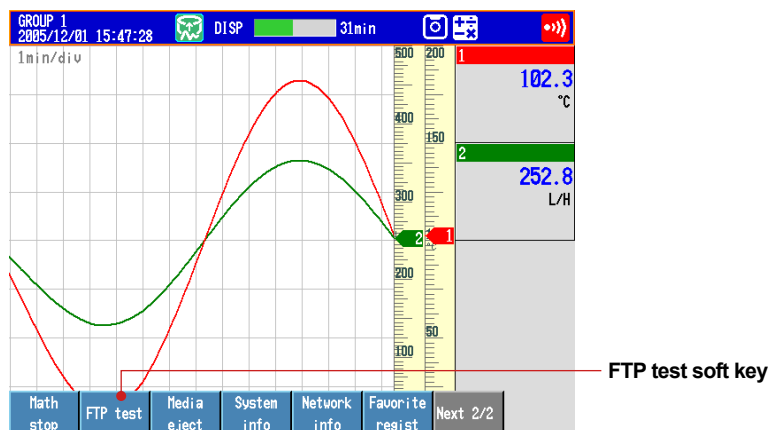

3. Press the **Primary** soft key once. The messages “FTP test is being executed” and “Execution is complete” are displayed. The test file (FTP_TEST.TXT) is sent to the FTP server.

Operation complete.

Transferring the Data Files

When you start memory sampling, the measured data file is transferred to the FTP server when the data is saved to the CF card.

Using DAQSTANDARD

Displaying the Measured Data on DAQSTANDARD

In this example, we will display the measured data using the software program, DAQSTANDARD.

1. Insert the CF card containing the measured data file into the PC that has DAQSTANDARD installed.
2. Start DAQSTANDARD Viewer.

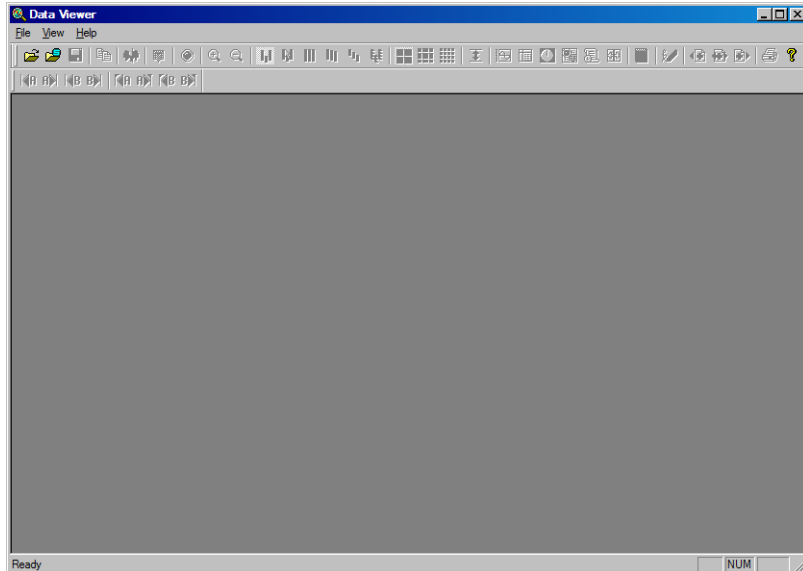

3. From the **File** menu, choose **Open**.
4. In the Open dialog box, select the desired file, and click **Open**.
The data is displayed.

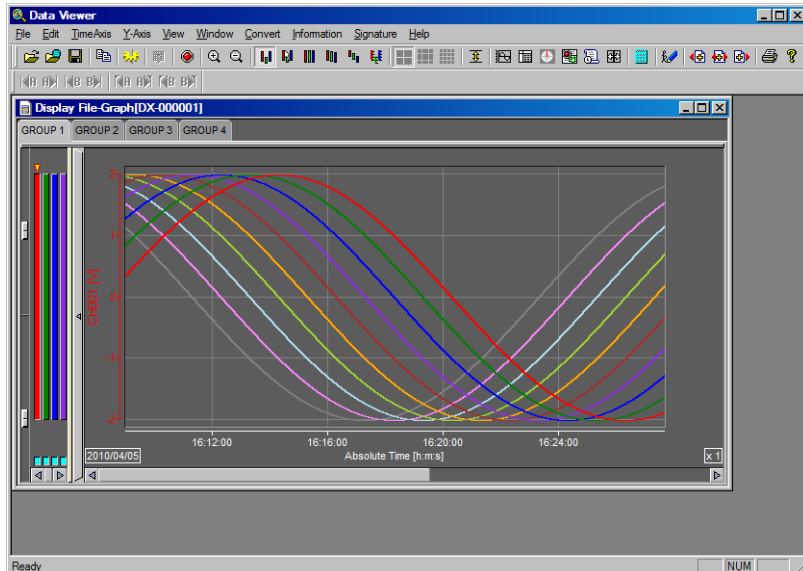

Operation complete.

DX2000T Settings

For an explanation of the settings, see the DXA120 DAQSTANDARD Hardware Setup User's Manual, IM 04L41B01-64EN.

In the above manual, read "DX2000" as "DX2000T." Only the settings that are different from the DX2000 are listed below.

System Configuration Dialog Box

On the DXAdvanced tab, set the model to DX2000T.

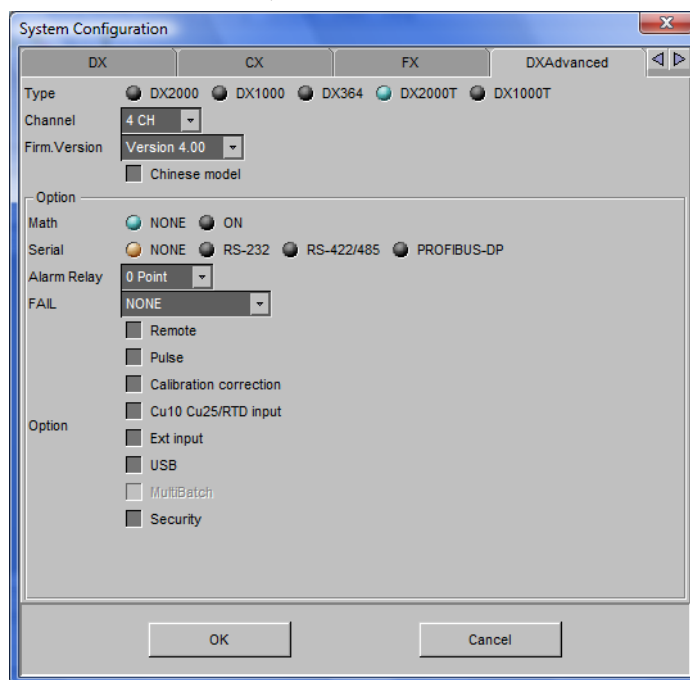

Basic setting mode > Environment tab > Detail Setting

- **Touch panel**

OFF	The touch panel is not locked.
-----	--------------------------------

ON	The touch panel is locked.
----	----------------------------

Password	The touch panel is locked, and a password is required to unlock it.
----------	---

- **Password**

This is the password that is used to unlock the touch panel. The password is displayed as "*****." (The password is up to eight characters.)

When Touch panel is set to Password, this setting is enabled.

General setting > Menu Customize > Function menu

TouchPnl Lock is one of the available selections.

Installation and Wiring

Installation Location

Install the DX indoors in a location that meets the following conditions.

- **Instrumentation Panel**

The DX is designed to be installed in an instrumentation panel except for the desktop type.

- **Well-Ventilated Location**

To prevent overheating, install the DX in a well-ventilated location. For the panel cut dimensions when arranging multiple DXs, see the page 64. Follow the panel cut dimensions providing adequate space between instruments when other instruments are arranged on the panel. For the desktop type, we recommend that a space of at least 50 mm be provided around the left, right, and top panels of the DX.

- **Minimum Mechanical Vibrations**

Choose an installation location with the minimum mechanical vibration. Installing the DX in a location with large mechanical vibration not only causes adverse effects on the mechanism but also may hinder normal recording.

- **Horizontal**

Install the DX horizontally (However, the DX can be inclined up to 30 degrees backwards for panel mounting).

Note

Condensation may occur if the DX is moved to another place where the ambient temperature is higher, or if the temperature changes rapidly. In addition, measurement errors will result when using thermocouples. If this happens, let the DX adjust to the new environment for at least one hour before using it.

Do not install the DX in the following places.

- **Outdoors**

- **In Direct Sunlight or Near Heat Sources**

Install the DX in a place with small temperature fluctuations near room temperature (23°C). Placing the DX in direct sunlight or near heat appliances can cause adverse effects on the internal circuitry.

- **Where an Excessive Amount of Soot, Steam, Moisture, Dust, or Corrosive Gases Are Present**

Soot, steam, moisture, dust, and corrosive gases will adversely affect the DX. Avoid such locations.

- **Near Strong Magnetic Field Sources**

Do not bring magnets or instruments that produce electromagnetic fields close to the DX. Operating the DX in strong magnetic fields can cause errors in the measurements.

- **Where the Viewing of the Display Is Poor**

The DX uses a TFT color LCD for the display. Therefore, viewing of the display from an extreme angle is difficult. Install the DX so that the user can view the display from the front.

Installation Procedure

Installation Procedure (Panel Mount Type)

Use a steel panel of thickness 2 mm to 26 mm.

1. Insert DX from the front of the panel.
2. Mount the DX to the panel using the mounting brackets that come with the package as shown in the figure below.
 - Use two brackets to support the top and bottom or the left and right sides of the case (remove the seal that is covering the holes for the mounting brackets beforehand).
 - The proper torque for tightening the mounting screws is 0.7 to 0.9 N•m.
 - Mount the DX to the rack according to the procedure below.
 - First, attach the two mounting brackets and temporarily fasten the attachment screws.
 - Next, fix the DX in place by tightening the attachment screws with the appropriate torque. When the DX is approximately perpendicular to the panel as you fasten the screws, press the mounting bracket against the case so that they are in contact with each other.



CAUTION

- Tightening the screws too much can deform the case or damage the bracket.
- Be careful not to insert foreign objects or tools through the holes for the mounting brackets in the case.
- Make sure the rubber gasket is affixed so that it does not become entangled between the main unit and the panel. Affixing the gasket incorrectly will result in failure to achieve sufficient dust and water proof performance.

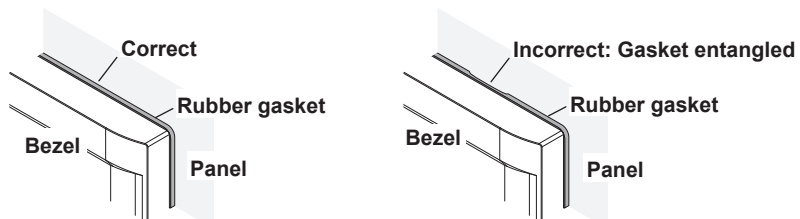

Panel Mounting Diagram

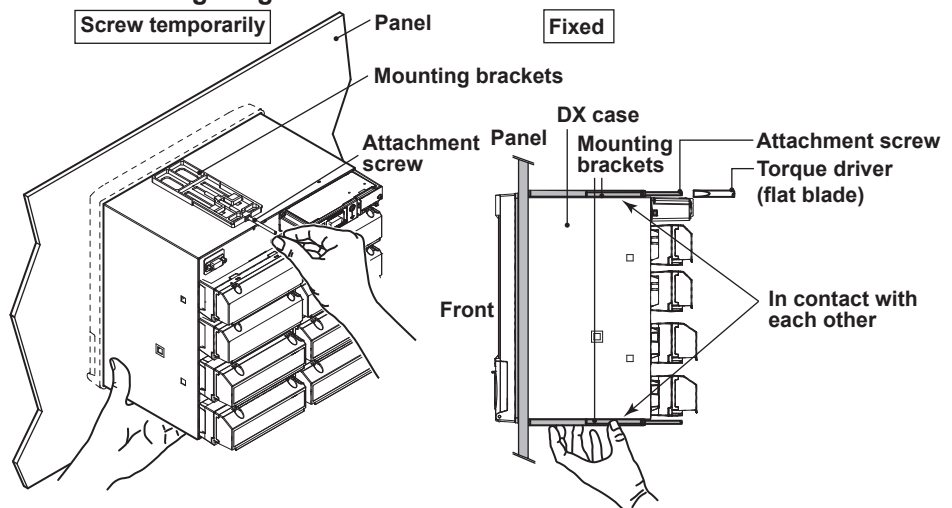

(The figure shows the case when the mounting brackets are used on the top and bottom of the case.)

Note

To achieve sufficient dust and water proof performance, mount the DX in the middle of the panel cut out.

External Dimensions and Panel Cut Dimensions Panel Mount Type

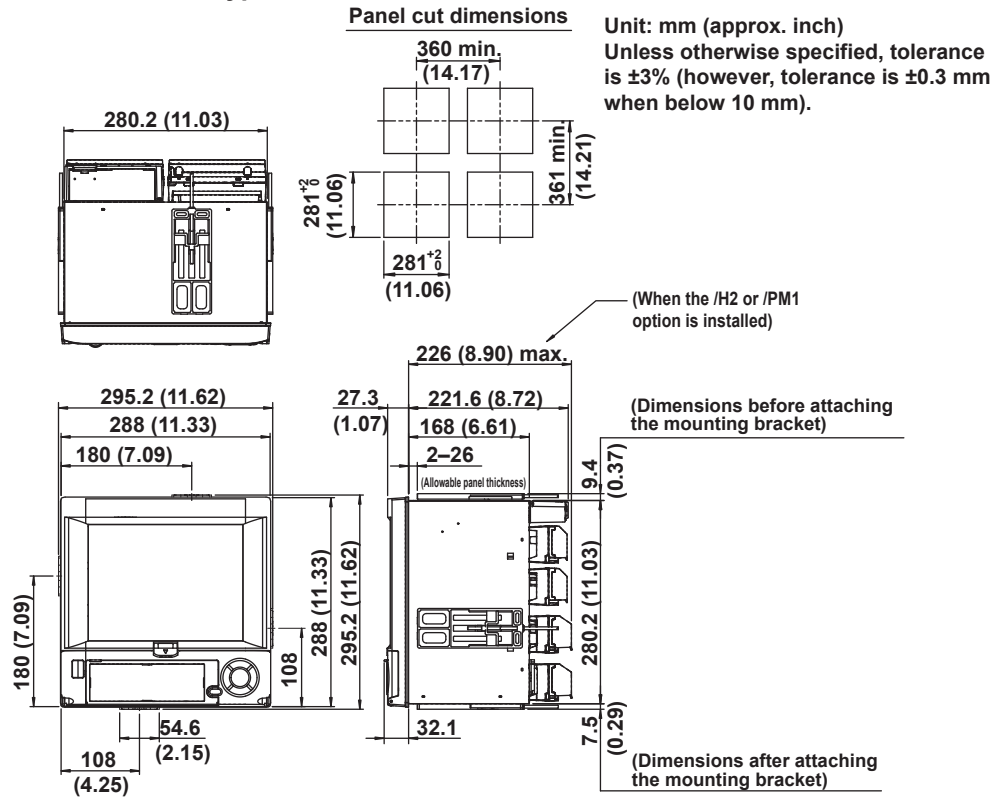

Desktop Type (/H5 [] Option)

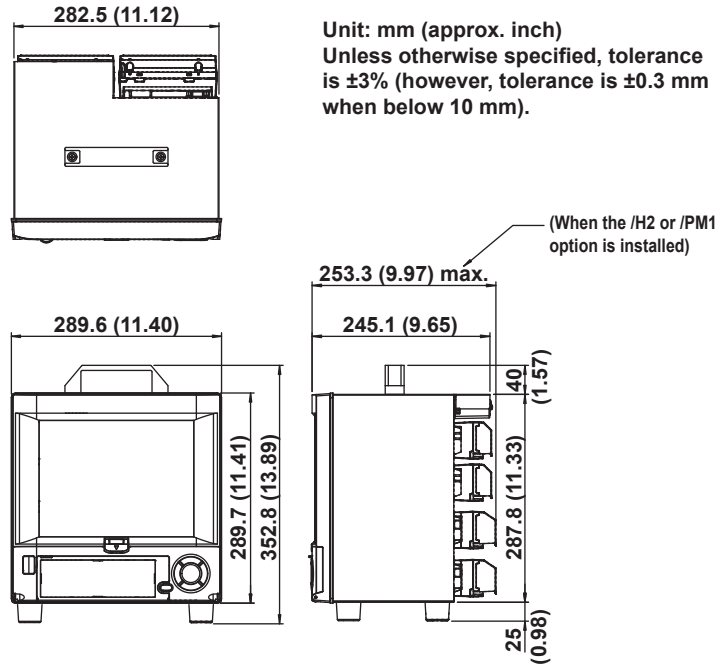

Input Signal Wiring



WARNING

- To prevent electric shock while wiring, ensure that the power supply source is turned OFF.

CAUTION

- If a strong tension is applied to the cable wired to the DX, the terminals of the DX and/or the cable can be damaged. In order to prevent tension from being applied directly on the terminals, fasten all wiring cables to the rear of the mounting panel.
- To prevent fire, use signal wires having a temperature rating of 70°C or more.
- Do not apply a voltage exceeding the following value to the input terminals. Otherwise, damage to the DX may result.
 - Maximum input voltage: ± 60 VDC
 - Maximum common mode voltage: ± 60 VDC (under measurement category II conditions)
- The DX is a product of overvoltage category II or I.

Precautions to Be Taken While Wiring

Take the following precautions when wiring the input signal cables.

When using a screw terminal, we recommend that you use a crimp-on lug with an insulation sleeve (designed for 4-mm screws).



Crimp-on lug with insulation sleeves (for 4 mm screws)

When using a clamp terminal (/H2), we recommend that you use the following kind of cable:

- Conductive cross-sectional area: 0.08 mm² to 1.5 mm² (AWG 28 to 16)
- Length of the stripped section of the wire: Approx. 7 mm

Take measures to prevent noise from entering the measurement circuit.

- Move the measurement circuit away from the power cable (power circuit) and ground circuit.
- It is desirable that the object being measured does not generate noise. However, if this is unavoidable, isolate the measurement circuit from the object. Also, ground the object being measured.
- Shielded wires should be used to minimize noise caused by electrostatic induction. Connect the shield to the ground terminal of the DX as necessary (make sure you are not grounding at two points).
- To minimize noise caused by electromagnetic induction, twist the measurement circuit wires at short, equal intervals.
- Make sure to earth ground the protective ground terminal through minimum resistance (less than 100 Ω).

When using internal reference junction compensation on the thermocouple input, take measures to stabilize the temperature at the input terminal.

- Always use the terminal cover.
- Do not use thick wires which may cause large heat dissipation (cross sectional area of 0.5 mm² or less recommended).
- Make sure that the ambient temperature remains reasonably stable. Large temperature fluctuations can occur if a nearby fan turns ON or OFF.

Connecting the input wires in parallel with other devices can cause signal degradation, affecting all connected devices. If you need to make a parallel connection, then

- Turn the burnout detection function OFF.
- Ground the instruments to the same point.
- Do not turn ON or OFF another instrument during operation. This can have adverse effects on the other instruments.
- RTDs cannot be wired in parallel.

Wiring Procedure

A terminal cover is screwed in place on the measuring input terminal block on the rear panel. A label indicating the terminal arrangement is affixed to the cover.

1. Turn OFF the DX and remove the terminal cover.
2. Connect the signal wires to the terminals.

Recommended torque for tightening the screws	Screw terminals	0.9 to 1.0 N•m
	Clamped terminals	0.22 to 0.25 N•m

3. Replace the terminal cover and fasten it with screws. The proper torque for tightening the screws is 0.6 N•m.

Note

Input signal wires of diameter less than or equal to 0.3 mm may not be secured firmly for clamped terminals (/H2). Fold over the conducting section of the wire, for example, to make sure that the wire is securely connected to the clamped terminal.

Arrangement of the Input Terminals

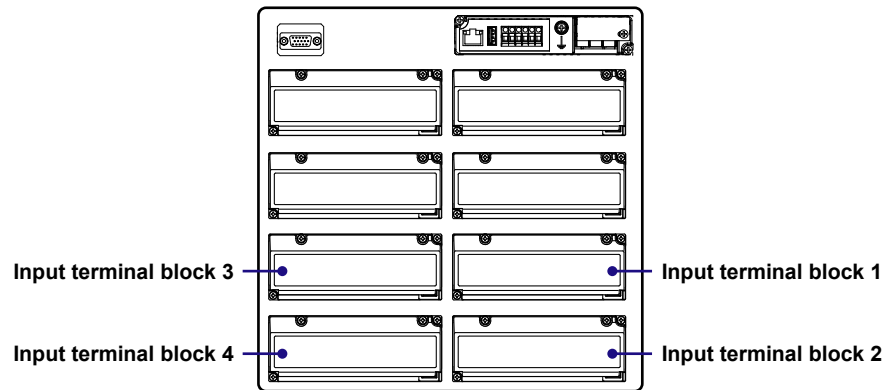

Input terminal block	Channel Assignments by Model						
	DX2004T	DX2008T	DX2010T	DX2020T	DX2030T	DX2040T	DX2048T
1	1-4	1-4	1-10	1-10	1-10	1-10	1-12
2		5-8		11-20	11-20	11-20	13-24
3					21-30	21-30	25-36
4						31-40	37-48

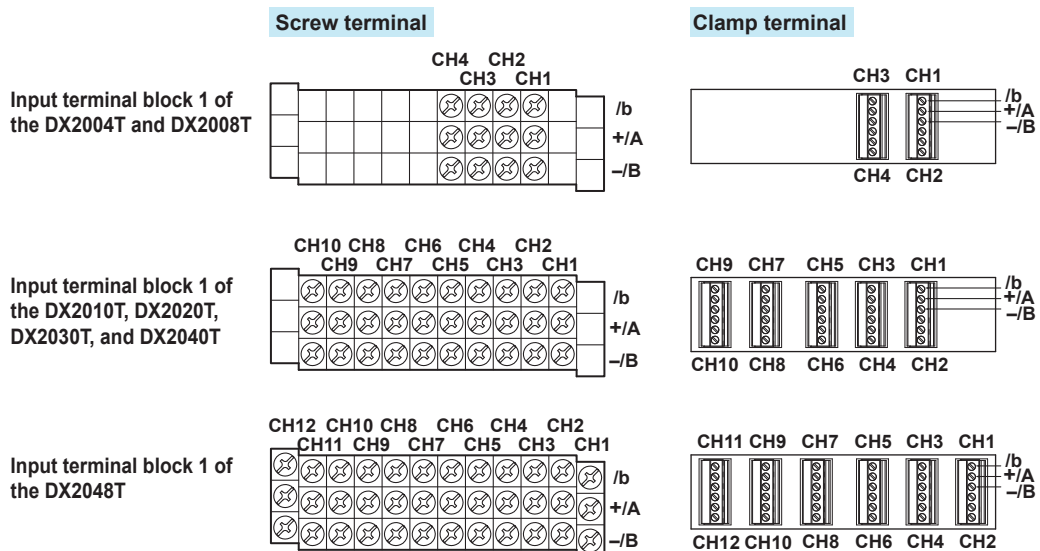

Wiring Screw Terminals

DC voltage input/DI (ON/OFF) input

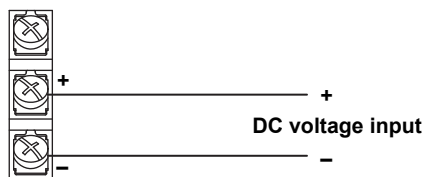

TC input

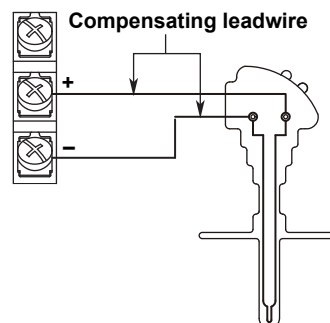

RTD input

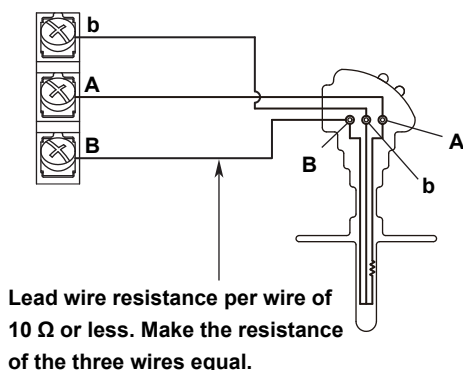

DC current input

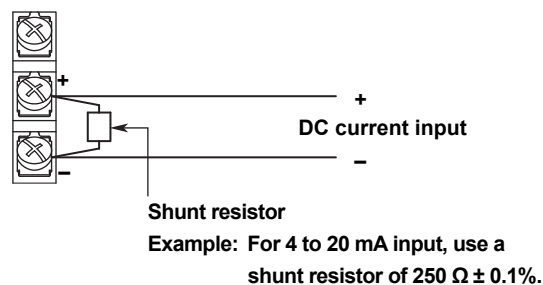

Wiring Clamped Terminals

CAUTION

As of August, 2007, the direction of the terminal blocks for the clamp input terminals (/H2 option) has changed. To use clamp input terminal blocks wired for use with previous YOKOGAWA recorders, rewire them to match the DX.

Remove the terminal block
Hold both ends of the terminal block and pull straight.

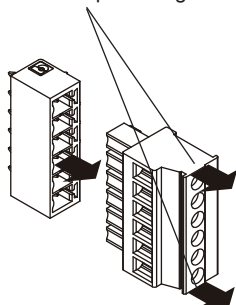

Connect the wires

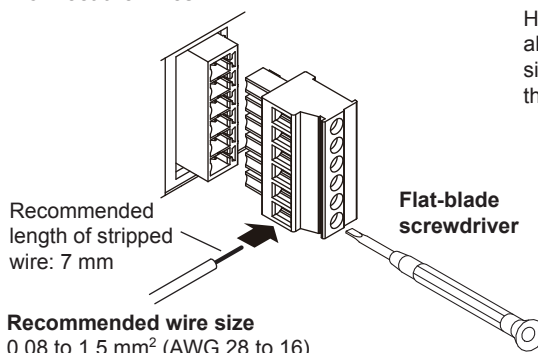

Connect the terminal block
Hold both ends of the terminal block, align with the connector on the DX side, and push the terminal block into the connector.

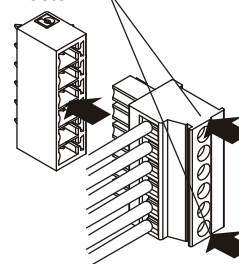

Recommended wire size
0.08 to 1.5 mm² (AWG 28 to 16)

Input signal wire

First, loosen the screw at the front using a flat-blade screwdriver. Insert the input signal wire into the slit on the left side of the terminal block, and fasten the screw at the front.

Note

RTD input terminals A and B are isolated on each channel. Terminal b is shorted internally across all channels. However, terminal b is also isolated on each channel on models with the /N1 option (Cu10, Cu25 RTD input/3 leg isolated RTD) and /N2 option (3 leg isolated RTD).

Optional Terminal Wiring



WARNING

- To prevent electric shock while wiring, ensure that the power supply source is turned OFF.
- If a voltage of more than 30 VAC or 60 VDC is to be applied to the output terminals, use ring-tongue crimp-on lugs with insulation sleeves on all terminals to prevent the wires from slipping out when the screws become loose. Furthermore, use double-insulated wires (dielectric strength of 3000 VAC or more) for the signal wires on which a voltage of more than 30 VAC or 60 VDC is to be applied. For all other wires, use basic insulated wires (dielectric strength of 1500 VAC). To prevent electric shock, attach the terminal cover after wiring and make sure not to touch the terminals.

CAUTION

- Use the following circuit voltage for the connection to the alarm/FAIL/status output terminal.
 - When the connection is to Mains Circuits (primary AC power source circuits):
150 V or less
 - When the connection is to circuits derived from Mains Circuits (secondary circuits):
250 V or less
(Mains Circuits voltage is less than 300 V, and connection must be used by isolation transformer.)
- To prevent fire, use signal wires having a temperature rating of 70°C or more.
- If a strong tension is applied to the cable wired to the DX, the terminals of the DX and/or the cable can be damaged. In order to prevent tension from being applied directly on the terminals, fasten all wiring cables to the rear of the mounting panel.
- Do not short the transmitter power supply output terminal or apply external voltage to it. If you do, the DX may malfunction.
- When using the transmitter power supply output terminal, do not use current that exceeds the maximum output current (25 mADC). If you do, the DX may malfunction.
- Do not short the VIDEO OUT terminal or apply external voltage to it. If you do, the DX may malfunction.

Note

For remote control wiring, use shielded wires to reduce noise. Connect the shield to the functional ground terminal or the ground terminal of the DX.

Precautions to Be Taken While Wiring

It is recommended that crimp-on lug with insulation sleeves (designed for 4-mm screws) be used when connecting wires to the optional input terminals.



Crimp-on lug with insulation sleeves (for 4-mm screws)

Wiring Procedure

As shown in the figure on next page, the optional terminal block is located on the rear panel. The optional terminal block is provided on the DX when an option that requires input/output is installed such as the alarm output relay (/A[] option), FAIL/status output relay (/F1 or /F2 option), and remote control function (/R1 option), etc. A terminal cover is screwed in place on the measuring input terminal block. A label indicating the terminal arrangement is affixed to the cover.

1. Turn OFF the DX and remove the terminal cover.
2. Connect the signal wires to the terminals. The recommended torque for tightening the screws is 0.9 to 1.0 N•m
3. Replace the terminal cover and fasten it with screws. The proper torque for tightening the screws is 0.6 N•m.

Arrangement of the Optional Terminals

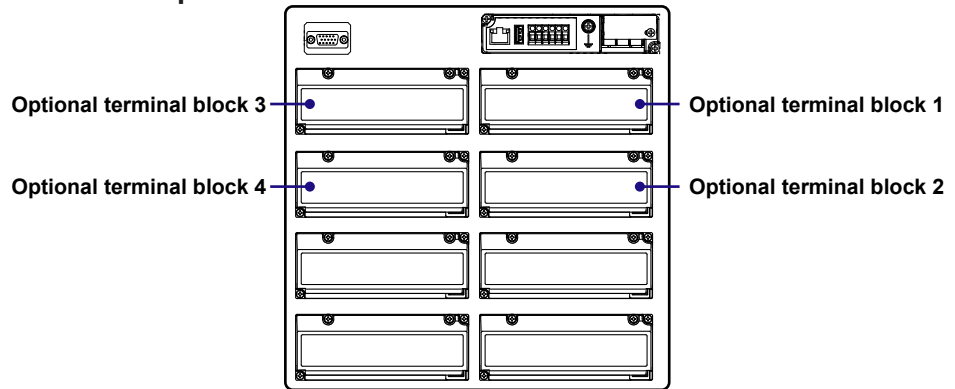

Description of Symbols

NC	Symbols such as "NC": Terminal functions	Remote control input	Pulse input	Transmitter power supply
	Alarm output, FAIL, Status	1 to 8: Terminal number	H and L: See page 74.	+ and -: See page 74.
	NC: Normally closed	C: Common		
	C: Common	See page 74.		
	NO: Normally opened			
	See page 74.			
	A terminal that is not used. (With a screw)			
	A terminal that is not used. (Without screw)			

Options That Use Option Terminal Block 1 Only

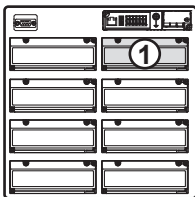

These options can come with /TPS4 or /TPS8.
 In that case, the option terminal block 4, or option terminal blocks 3 and 4 are installed.
 For the terminal arrangement for /TPS4 and /TPS8, see page 74.

/A1													
Alarm output													
		02		01									
				NC	NC								
				C	C								
				NO	NO								
/A2													
Alarm output													
		04		03		02		01					
				NC	NC	NC	NC	NC					
				C	C	C	C	C					
				NO	NO	NO	NO	NO					
/A3													
Alarm output													
		06		05		04		03		02		01	
				NC	NC	NC	NC	NC	NC	NC	NC	NC	
				C	C	C	C	C	C	C	C	C	
				NO	NO	NO	NO	NO	NO	NO	NO	NO	
/A1/R1													
Alarm output					Remote control input								
		02		01									
				NC	NC	6	3	C					
				C	C	7	4	1					
				NO	NO	8	5	2					
/A2/R1													
Alarm output					Remote control input								
		04		03		02		01					
				NC	NC	NC	NC	6	3				
				C	C	C	C	7	4				
				NO	NO	NO	NO	8	5				
/A3/R1													
Alarm output					Remote control input								
		06		05		04		03		02		01	
				NC	NC	NC	NC	NC	NC	6	3	C	
				C	C	C	C	C	C	7	4	1	
				NO	NO	NO	NO	NO	NO	8	5	2	
/R1													
Remote control input													
		6		3									
				6	3	C							
				7	4	1							
				8	5	2							
/A1 /F1													
		Status		Alarm output									
		FAIL		02		01							
				NC	NC	NC	NC	NC					
				C	C	C	C	C					
				NO	NO	NO	NO	NO					
/A2 /F1													
		Status		Alarm output									
		FAIL		04		03		02		01			
				NC	NC	NC	NC	NC	NC				
				C	C	C	C	C	C				
				NO	NO	NO	NO	NO	NO				

(To next page)

(From previous page)

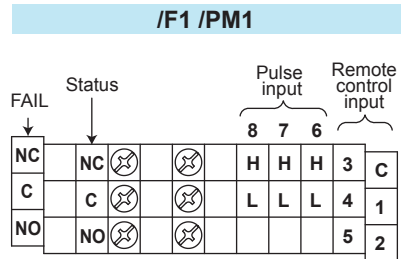
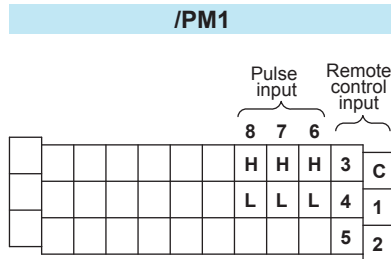
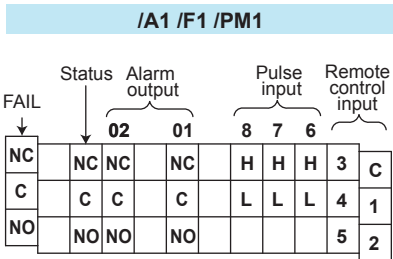
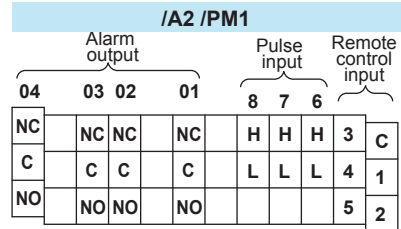
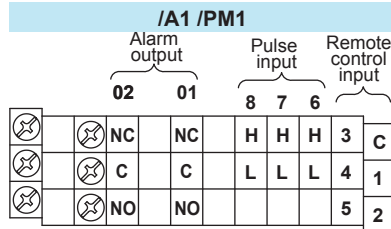
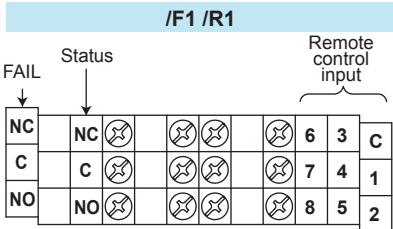
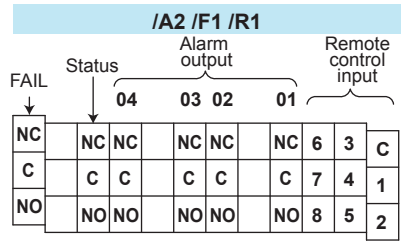
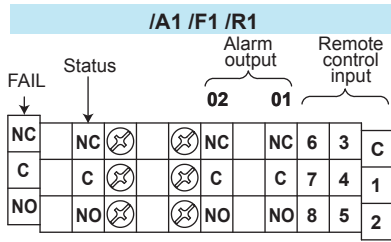
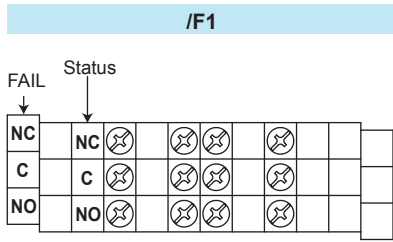

/TPS4

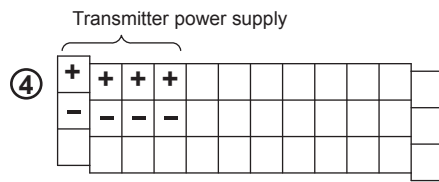
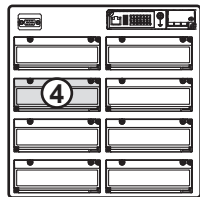

/TPS8

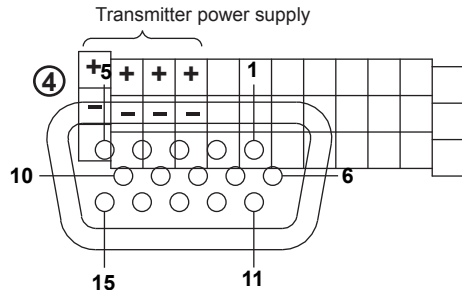
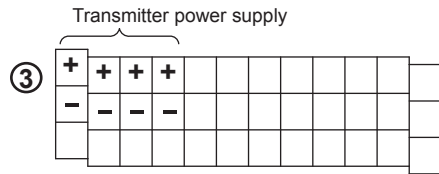
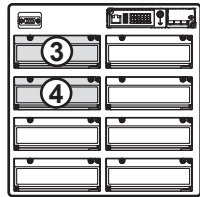

D-Sub 15-pin receptacle

Options That Use Option Terminal Blocks 1 and 2

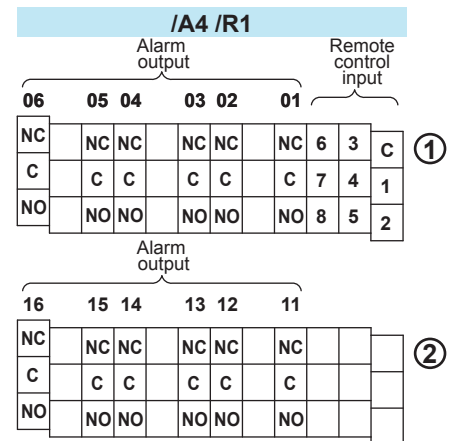
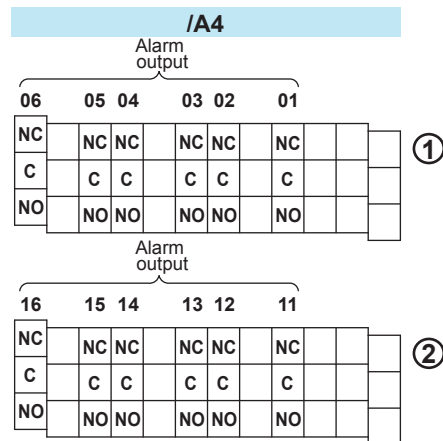
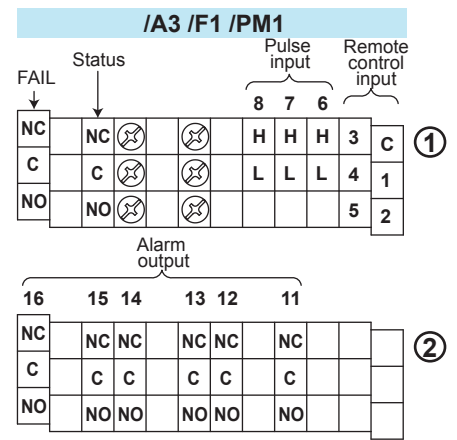
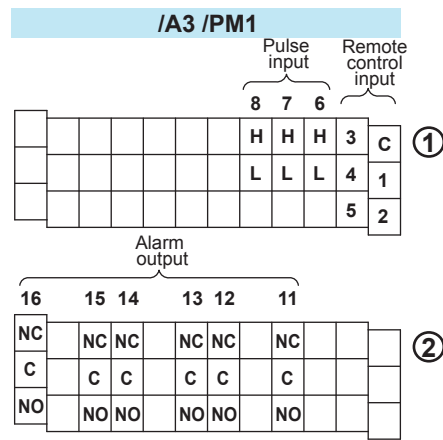
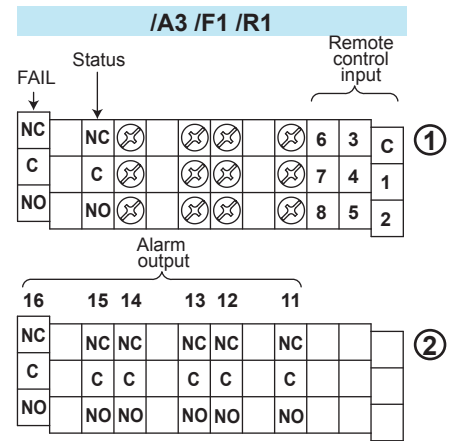
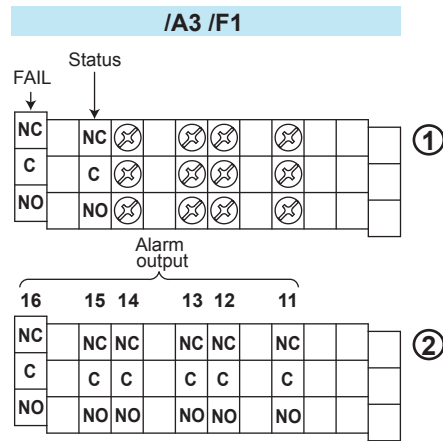
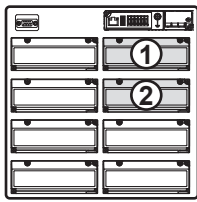

These options can come with /TPS4 or /TPS8. In that case, the option terminal block 4, or option terminal blocks 3 and 4 are installed. For the terminal arrangement for /TPS4 and /TPS8, see page 74.

Options That Use Option Terminal Blocks 1, 2, and 3

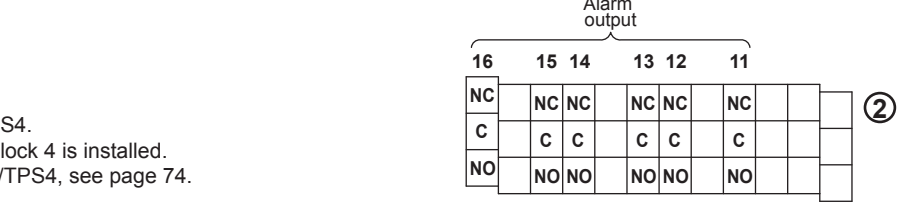
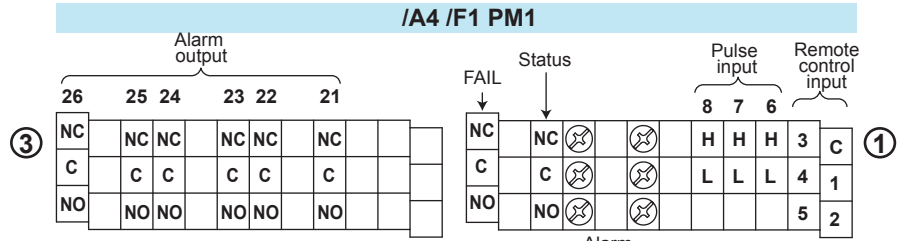
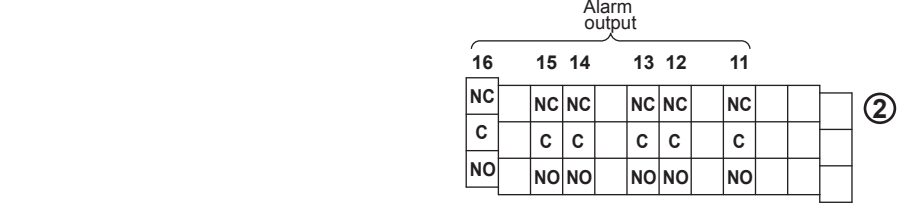
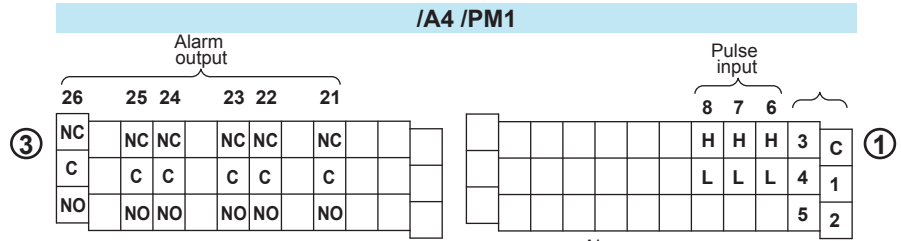
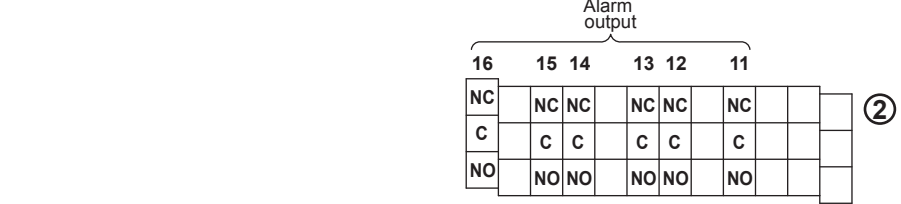
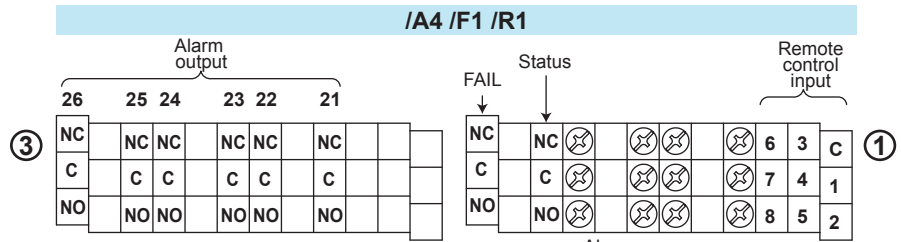
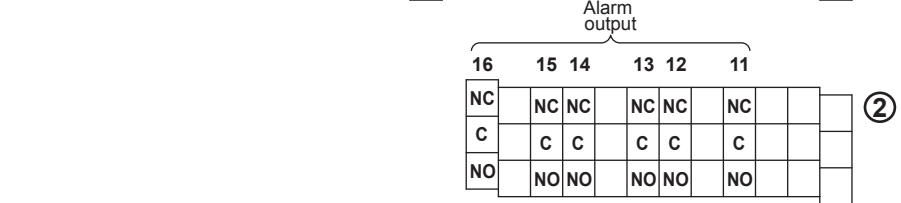
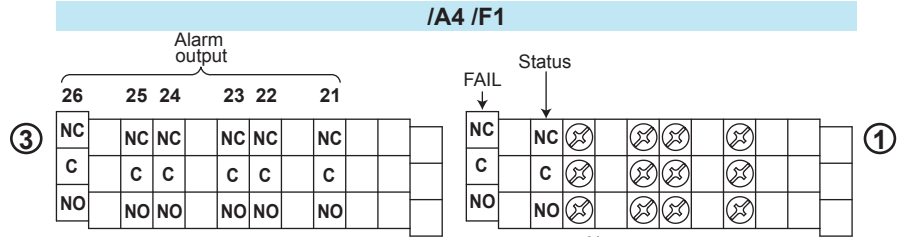
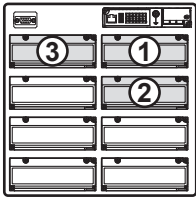

These options can come with /TPS4. In that case, the option terminal block 4 is installed. For the terminal arrangement for /TPS4, see page 74.

Options That Use Option Terminal Blocks 1, 2, 3, and 4

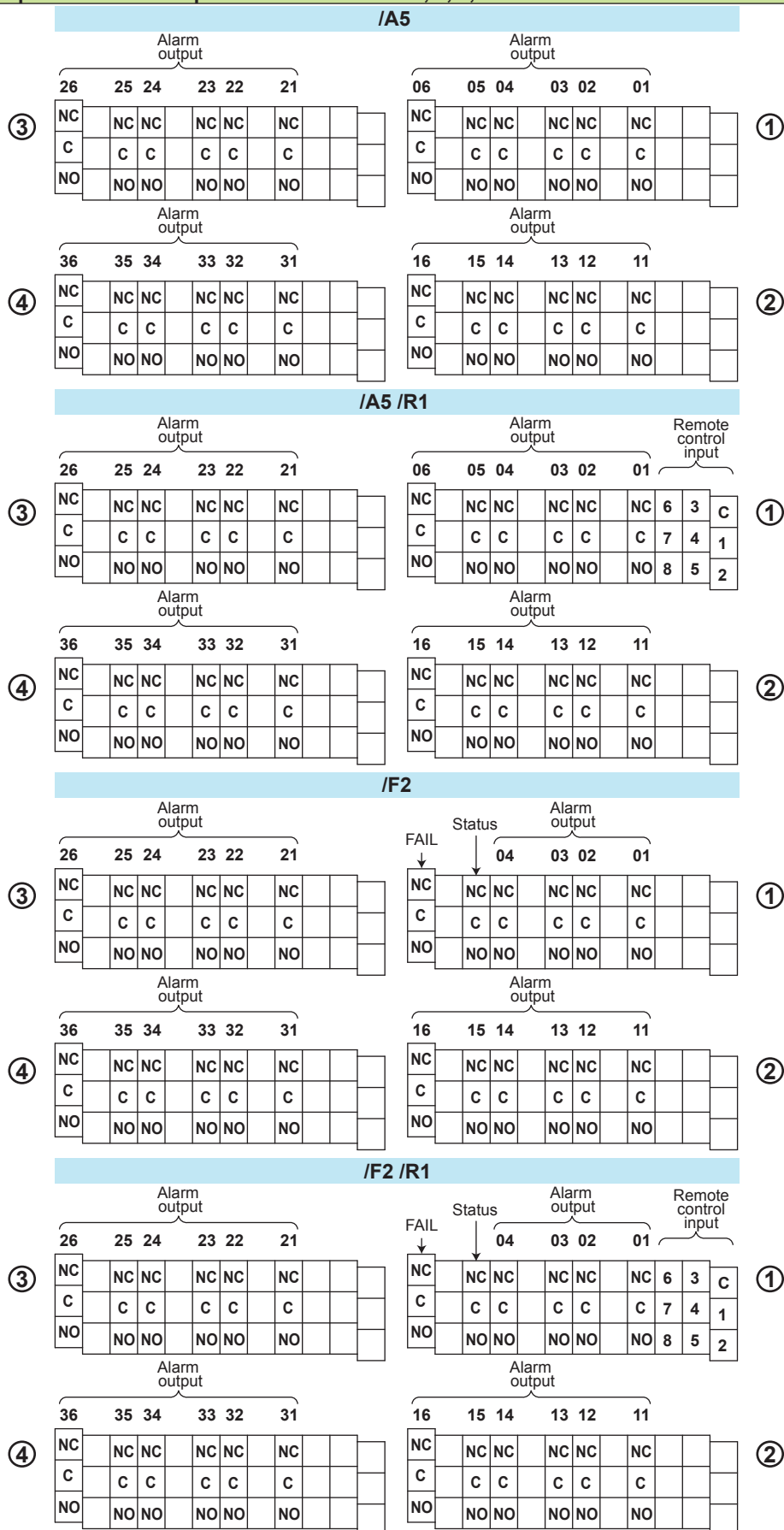
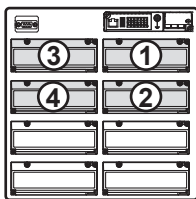

Installation and Wiring

Alarm Output Terminal (/A1, /A2, /A3, /A4, and /A5), FAIL Output Terminal, and Status Output Terminal (/F1 and /F2)

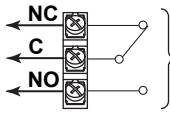

Output format: Relay contact
Contact rating: 250 VAC (50/60 Hz)/3 A, 250 VDC/0.1 A (for resistor load)
Withstand voltage: 1600 VAC at 50/60 Hz for one minute (between output terminals and the ground terminal)

FAIL output (/F1, /F2)	NO C NC During normal operation	NO C NC When a failure occurs	NO C NC When power is turned OFF
	Other output (/F1, /F2)	NO C NC During normal operation	NO C NC When specified status occurs

Remote Control Input Terminal (/R1)

- Relay contact input (voltage-free contact)
Contact closed at 200 Ω or less
Contact open at 100 kΩ or greater
- Transistor input (open collector)
ON voltage: 0.5 V or less (30 mADC)
Leakage current when turned OFF: 0.25 mA or less

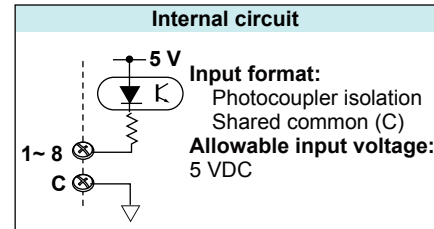
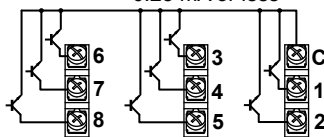
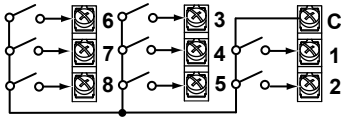

Withstand voltage: 1000 VDC for one minute between input terminals and the ground terminal

Pulse Input Terminal (/PM1)

- Relay contact input (voltage-free contact)
Contact closed at 200 Ω or less
Contact open at 100 kΩ or greater
- Transistor input (open collector)
ON voltage: 0.5 V or less (30 mADC)
Leakage current when turned OFF: 0.25 mA or less

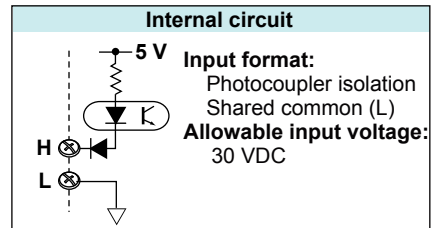
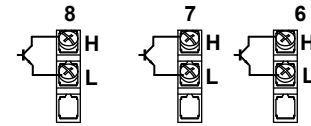
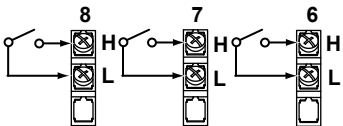

Withstand voltage: 1000 VDC for one minute between input terminals and the ground terminal

24 VDC Transmitter Power Supply Output Terminal (/TPS4 and /TPS8)

Connect the DX to the transmitter as shown below.

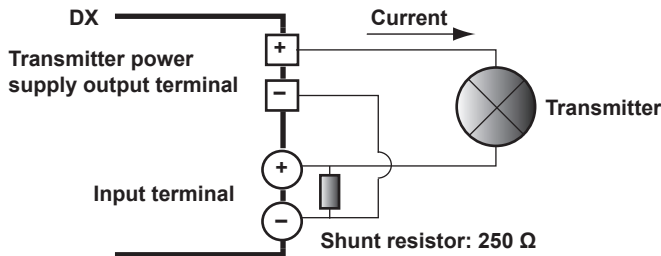

Note

To reduce noise, use a shielded cable for wiring. Connect the shield to the functional ground terminal or the ground terminal of the DX.

Serial Interface

Connecting to the RS-232 Connector (/C2)

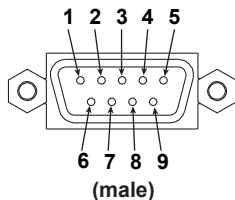

- 2 RD (Received Data): Received data from the PC. Input signal to the DX.
- 3 SD (Send Data): Transmitted data to the PC. Output signal from the DX.
- 5 SG (Signal Ground): Signal ground.
- 7 RS (Request to Send): Handshaking signal when receiving data from the PC. Output signal from the DX.
- 8 CS (Clear to Send): Handshaking signal when transmitting data to the PC. Input signal to the DX.

* Pins 1, 4, 6, and 9 are not used.

Connecting to the PROFIBUS-DP Connector (/CP1)

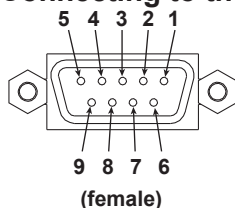

- 3 RxD/TxD-P: Positive data input/output.
- 4 CNTR-P: RTS (needed when using a repeater).
- 5 DGND: Ground.
- 6 VP +5V: +5 V.
- 8 RxD/TxD-N: Negative data input/output.

* Pins 1, 2, 7, and 9 are not used.

** The DX does not have a built-in terminator. If you need to terminate the cable at the DX, use a terminated connector.

Connecting to the RS-422/485 (/C3)

Four-wire system

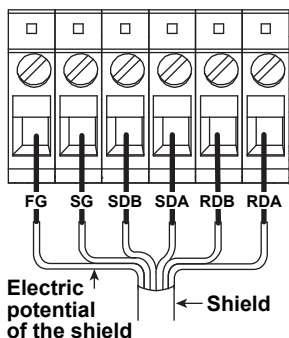

Two-wire system

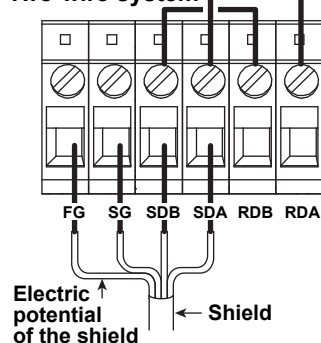

- FG (Frame Ground)** Frame ground of the DX.
- SG (Signal Ground)** Signal ground.
- SDB (Send Data B)** Send data B (+).
- SDA (Send Data A)** Send data A (-).
- RDB (Received Data B)** Receive data B (+).
- RDA (Received Data A)** Receive data A (-).

Recommended length of stripped wire: 9 mm. Recommended tightening torque: 0.4-0.5 N•m.

Cable

There are two types of cables available, the four-wire cable and the two-wire cable (used only for the Modbus protocol). The cable should meet the following specifications.

- Type: Shielded twisted pair cable: 3 pairs 24 AWG or more (four-wire),
2 pair 24 AWG or more (two-wire)
- Characteristic impedance: 100 Ω
- Capacitance: 50 pF/m
- Total cable length: Up to 1.2 km

Connecting to the VGA Connector (/D5)



CAUTION

- Connect the cable after turning OFF the DX and the monitor.
- Do not short the VIDEO OUT terminal or apply external voltage to it. If you do, the DX may malfunction.

VGA Output Terminal

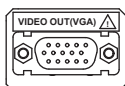

The DX display can be output to a monitor through the RGB output. Connectable monitors are VGA monitors or multi-sync monitors capable of displaying VGA.

Specifications of the VGA Output Terminal

Pin No.	Signal Name	Specifications
1	Red	0.7 Vp-p
2	Green	0.7 Vp-p
3	Blue	0.7 Vp-p
4	—	
5	—	
6	GND	
7	GND	
8	GND	
9	—	
10	GND	
11	—	
12	—	
13	Horizontal sync signal	Approx. 31.5 kHz, TTL negative logic
14	Vertical sync signal	Approx. 60 Hz, TTL negative logic
15	—	

Connecting to the Monitor

1. Turn OFF the DX and the monitor.
2. Connect the DX and the monitor using an analog RGB cable.
3. Turn ON the power to both the DX and the monitor. The DX screen is displayed on the monitor.

Note

- When the DX is turned ON, a VGA signal is always output from the VIDEO OUT terminal.
- The monitor screen may flicker if the DX or another instrument is brought close to the monitor.
- The edge of the screen may drop out depending on the monitor type.

Connecting to the USB Port (/USB1)

The USB port complies with Rev. 1.1.

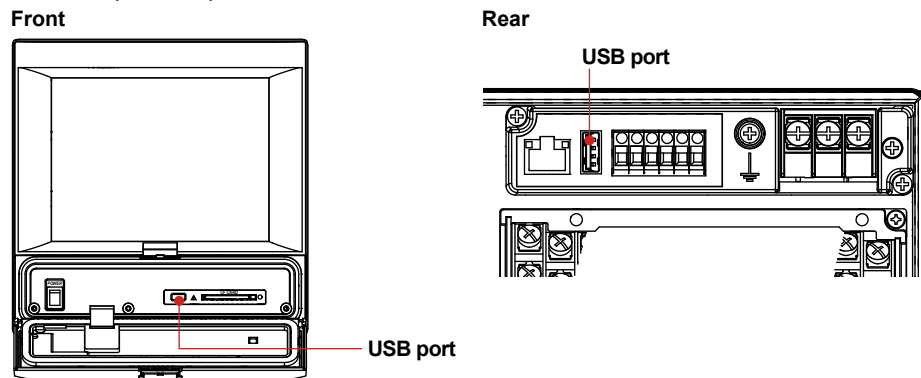

Connecting to the Ethernet Port

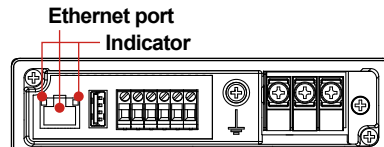

CAUTION

Do not connect an Ethernet cable whose plug does not comply with FCC specifications. If you do, the DX may malfunction.

Checking the Connection/Communication Status

You can check the connection status of the Ethernet interface with the indicators that are located above the Ethernet connector of the DX.

Indicator	Connection Status of the Ethernet Interface
Illuminated (green)	The Ethernet interface is electrically connected.
Blinking (red)	Transmitting data.
Off	The Ethernet interface is not electrically connected.

Checking the Connection on the DX Display

- **Checking the Connection at the status indication section of the DX display**
You can check the connection status of the Ethernet interface on the Ethernet Link indicator located on the right side of the status display section of the basic setting mode display. The basic setting menu appears by pressing **MENU** to display the setting menu followed by **FUNC** for approximately 3 s.
- **Checking the Connection Status in the Display Section in the Upper Right Corner of the Communication Log Display of the DX**
You can check the connection status of the Ethernet interface on the Link indicator on the display section in the upper right corner of the communication log display.

Indicator	Connection Status of the Ethernet Interface
Illuminated (green)	The Ethernet interface is electrically connected.
Off	The Ethernet interface is not electrically connected.

Power Supply Wiring

Panel Mount Type, or Desktop Type with /P1 Option (Models with /H5 and /P1 Options)

Precautions to Be Taken While Wiring the Power Supply

Make sure to follow the warnings below when wiring the power supply. To prevent electric shock and damage to the DX, observe the following warnings.



WARNING

- To prevent electric shock when wiring, ensure the main power supply is turned OFF.
- To prevent the possibility of fire, use 600 V PVC insulated wire (AWG20 to 16) or an equivalent wire for power wiring.
- Make sure to earth ground the protective earth terminal through a grounding resistance less than 100 Ω before turning ON the power.
- Use crimp-on lug with insulation sleeves (for 4-mm screws) for power supply wires and protective grounding wires.
- To prevent electric shock, make sure to close the transparent cover for the power supply wires.
- Make sure to provide a power switch (double-pole type) on the power supply line in order to separate the DX from the main power supply. Put an indication on this switch as the breaker on the power supply line for the DX and indications of ON and OFF.
Switch specifications
Steady-state current rating: 1 A or more (other than /P1), 3 A or more (/P1).
Inrush current rating: 60 A or more (other than /P1), 70 A or more (/P1).
Use a switch complies with IEC60947-1, 3.
- Connect a fuse (between 2 A and 15 A) to the power line. Use a fuse approved by CSA (for the use in North America) or VDE (for the use in Europe).
- Do not add a switch or fuse to the ground line.

Use a power supply that meets the following conditions:

Item	Other than /P1	/P1
Rated supply voltage	100 to 240 VAC	24 VDC/AC
Allowable power supply voltage range	90 to 132, 180 to 264 VAC	21.6V to 26.4 VDC/AC
Rated power supply frequency	50/60 Hz	50/60 Hz (for AC)
Allowable power supply frequency range	50/60 Hz ± 2%	50/60 Hz ± 2% (for AC)
Maximum power consumption	74 VA (100 V)/100 VA (240 V)	45 VA (for DC), 70VA (for AC)

Note

Do not use a supply voltage in the range 132 to 180 VAC, as this may have adverse effects on the measurement accuracy.

Wiring Procedure

1. Turn OFF the power to the DX and open the transparent power terminal cover.
2. Wire the power cord and the protective ground cord to the power supply terminals. Use ring-tongue crimp-on lugs (designed for 4 mm screws). The proper torque for tightening the screw is 1.4 to 1.5 N•m (12.4 to 13.2 inch•lbs).

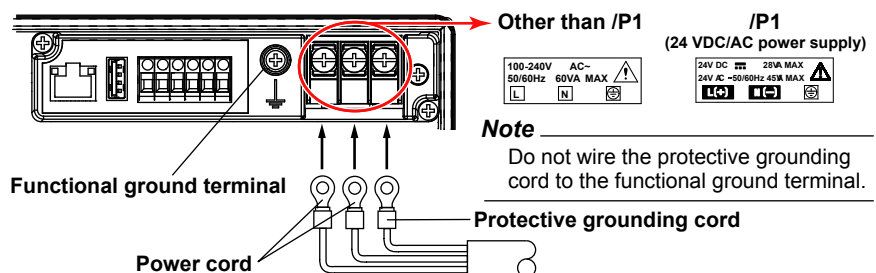

3. Replace the power terminal cover, and fasten it with screws.

Desktop Type (/H5[] Option)

Precautions to Be Taken While Connecting the Power Supply

Make sure to follow the warnings below when connecting the power supply. To prevent electric shock and damage to the DX, observe the following warnings.



WARNING

- Before connecting the power cord, ensure that the source voltage matches the rated supply voltage of the DX and that it is within the maximum rated voltage range of the provided power cord.
- Connect the power cord after checking that the power switch of the DX is turned OFF.
- To prevent electric shock or fire, be sure to use the power cord supplied by YOKOGAWA.
- Make sure to perform protective earth grounding to prevent electric shock. Connect the power cord of the desktop type to a three-prong power outlet with a protective earth terminal.
- Do not use an extension cord without protective earth ground. Otherwise, the protection function will be compromised.

Use a power supply that meets the following conditions:

Item	Condition
Rated supply voltage	100 to 240 VAC
Allowable power supply voltage range	90 to 132, 180 to 264 VAC
Rated power supply frequency	50/60 Hz
Allowable power supply frequency range	50/60 Hz \pm 2%
Maximum power consumption	74 VA (100V) and 100 VA (240 V)

Note

Do not use a supply voltage in the range 132 to 180 VAC, as this may have adverse effects on the measurement accuracy.

Connection Procedure

1. Check that the power switch is OFF.
2. Connect the power cord plug to the power connector on the rear panel. (Use the power cord that comes with the package.)

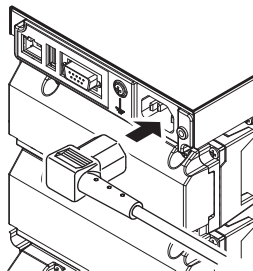

3. Check that the power outlet meets the conditions given in the table above and that the supply voltage is within the maximum rated voltage range of the power cord that comes with the package. Then, connect the other end of the power cord to the power outlet. The AC outlet must be of a three-prong type with a protective earth ground.

Recommended Replacement Periods for Worn Parts Maintenance

To preserve the reliability of the DX and to use the DX in a good condition for an extended time, it is recommended that periodic replacements be made on parts. The replacement parts may change to accommodate preventive maintenance over extended time. Be sure to check with your nearest YOKOGAWA dealer.

The following table shows the recommended replacement period for expendable parts. The replacement period shown here applies when the recorder is used under standard operating conditions. For the actual replacement period, consider the actual conditions of use. Replacement of parts will be carried out by a YOKOGAWA engineer or an engineer certified by YOKOGAWA. Contact your nearest YOKOGAWA dealer when such replacement is necessary.

Item	Replacement period	Name	Part No.	Quantity Used	Notes
LCD	5 years	BEZEL Assembly	B8706LS	1	For DX2000T, Style number H: 4 without /D5 option
			B8706LU	1	For DX2000T, Style number H: 4 with /D5 option
Battery	10 years	Battery Assembly	B8800ZK	1	
Dust and water proof strip	5 years	Packing	B8706FY	1	
	5 years	Key Case Assembly	B8706BM	1	English specifications
	5 years	Key Case Assembly	B8706BY	1	Japanese specifications
Aluminum electrolytic capacitor	5 years*	Power Supply Assembly	–	1	
	5 years*	AD Assembly	Depends on the model		

* Replacement period at the upper limit of the normal operating temperature (50°C)
 The replacement period varies depending on the operating temperature and the specifications of the DX.
 The lower the operating temperature, the longer is the replacement period. For example, if the operating temperature is 30°C, it may be possible to use the parts for more than 10 years.

Note

- The LCD replacement period indicates the half life of the brightness when the brightness is set to the factory default setting. The half life is shortened as the brightness is set higher. The deterioration of brightness varies depending on the condition of use, and its determination is subjective. Consider these facts for determining the actual replacement period.
- The color of the LCD may become yellowish as time elapses. The discoloration tends to progress faster as the brightness is set higher.

Setup Items and Default Values

The setup items and the default values in the setting mode are listed below. Enter the settings that you are using in the Setting column for your convenience.

Setting mode menu

BATCH OVERVIEW 2018/04/05 14:21:30		ALL BATCH
Menu	Multi batch	File Set Calibration
Date/Time		
Meas channel		
Math channel		
Ext. channel		
Display		
Group set. Trip line		
Message. Comment Text		
Timer. Event action		
Data save		
Web Report		
Menu customize		
Basic settings mode		

End: On models with advanced security (/AS1 option)

BATCH OVERVIEW 2018/04/05 14:21:51		ALL BATCH
Menu	Multi batch	File Set Calibration
Group set. Trip line		
File header. Data file name		
Batch text		

BATCH OVERVIEW 2018/04/05 14:22:42		ALL BATCH
Menu	Multi batch	File Set Calibration
Calibration correction		
Finish Calibration		

BATCH OVERVIEW 2018/04/05 14:22:14		ALL BATCH
Menu	Multi batch	File Set Calibration
Load display data		
Load event data		
Load settings		
Save settings		
Custom display load		
Custom display save		
Load template		
Save template		
File list/delete		
Format		

*: Options

Basic setting mode menu

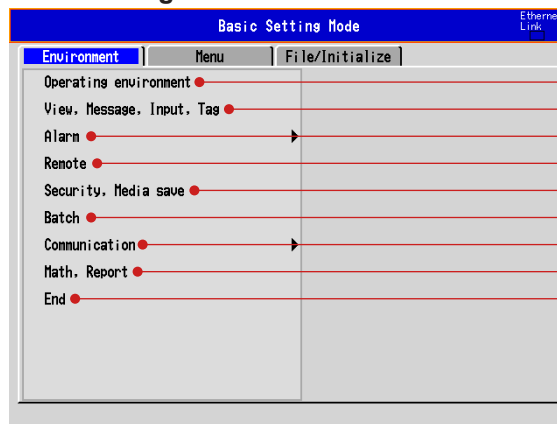

- Page 96
- Page 96
- Page 96
- Page 96
- Page 97
- Page 97
- Page 97
- Page 97
- Page 97
- Page 97

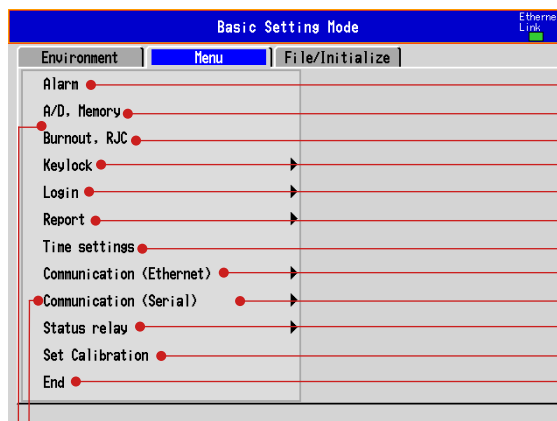

- Page 98
- Page 98
- Page 98
- Page 99
- Page 99 to 100
- Page 101
- Page 101
- Page 102 to 105
- Page 106
- Page 107
- Page 107
- Page 107

- Communication (PROFIBUS-DP):** On models with the PROFIBUS-DP Interface (/CP1 option). Page 106
- Signature:** On models with advanced security (/AS1 option). Page 98

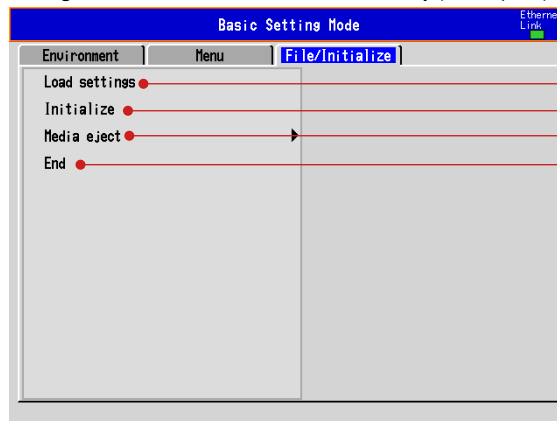

- Page 108
- Page 108
- Page 108
- Page 108

*1: Options

*2: Displayed when the function is enabled in the **Environment** settings.

Setup Items in Setting Mode and Their Default Values

Menu tab

Date/Time > Time settings

Setup Item	Selectable Range or Selections	Default Value	Setting
Time set	–	2011/01/01 00:00:00	

Date/Time > Daylight Saving Time

Setup Item	Selectable Range or Selections	Default Value	Setting
Use/Not	Use/Not	Not	
Start time > Month	JAN/FEB/MAR/APR/MAY/JUN/JUL/AUG/SEP/OCT/NOV/DEC	MAR	
Start time > Day order	1st/2nd/3rd/4th/Last	2nd	
Start time > Day of the week	SUN/MON/TUE/WED/THU/FRI/SAT	SUN	
Start time > Hour of the day	Numerical value	2	
End time > Month	JAN/FEB/MAR/APR/MAY/JUN/JUL/AUG/SEP/OCT/NOV/DEC	NOV	
End time > Day order	1st/2nd/3rd/4th/Last	1st	
End time > Day of the week	SUN/MON/TUE/WED/THU/FRI/SAT	SUN	
End time > Hour of the day	Numerical value	1	

Meas channel > Range, Alarm

Setup Item	Selectable Range or Selections	Default Value	Setting
First-CH, Last-CH	Channel number	001	
Range > Mode	Skip/Volt/TC/RTD/Scale/Delta/DI/1-5V/Sqrt	Volt	
Mode=Volt			
Range	20mV/60mV/200mV/2V/6V/20V/50V	2V	
Span Lower	Depends on the range.	–	
Span Upper	Depends on the range.	–	
Mode=TC			
Range	R/S/B/K/E/J/T/N/W/L/U/WRe	R	
Span Lower	(Options may add additional settings.)	–	
Span Upper	Depends on the range.	–	
Mode=RTD			
Range	Pt/JPt (Options may add additional settings.)	Pt	
Span Lower	Depends on the range.	–	
Span Upper	Depends on the range.	–	
Mode=Scale			
Type	Volt/TC/RTD/DI	Volt	
Range	Depends on the type.	–	
Span Lower	Depends on the range.	–	
Span Upper	Depends on the range.	–	
Scale Lower	–30000 to 30000, decimal position: 0 to 4	0.00	
Scale Upper	–30000 to 30000, decimal position: 0 to 4	200.00	
Unit	6 characters or less	–	
Mode=Delta			
Type	Volt/TC/RTD/DI	Volt	
Range	Depends on the type.	–	
Span Lower	Depends on the range.	–	
Span Upper	Depends on the range.	–	
Ref.CH	Meas channel number	–	

Setup Item	Selectable Range or Selections	Default Value	Setting
Mode=DI			
Range	Level/Cont	Level	
Span Lower	0, 1	0	
Span Upper	0, 1	1	
Mode=1-5V			
Range	1-5V	1-5V	
Span Lower	0.800 to 5.200	1.000	
Span Upper	0.800 to 5.200	5.000	
Scale Lower	-30000 to 30000, decimal position :0 to 4	0.00	
Scale Upper	-30000 to 30000, decimal position :0 to 4	200.00	
Unit	6 characters or less	-	
Low-cut	On/Off	Off	
Mode=.Sqrt			
Range	20mV/60mV/200mV/2V/6V/20V/50V		
Span Lower	Depends on the range.	-	
Span Upper	Depends on the range.	-	
Scale Lower	-30000 to 30000, decimal position: 0 to 4	0.00	
Scale Upper	-30000 to 30000, decimal position: 0 to 4	200.00	
Unit	6 characters or less	-	
Low-cut	On/Off	Off	
Low-cut value	0.0 to 5.0	0.5	
Alarm			
1, 2, 3, 4	On/Off	Off	
Type	H:High/L:Low/h:delta H/l:delta L/R:rate H/r:rate L/T:delayH/t:delayL	H	
Value	Numerical value	-	
Relay	On/Off	Off	
Number	I01/.../I06, I11/.../I16, I21/.../I26, I31/.../I36 (Depends on the option.) S01/S02/S03/.../S29/S30	I01	
Detect	On/Off	On	

Meas channel > Tag, Memory sample, Alarm delay

Setup Item	Selectable Range or Selections	Default Value	Setting
Without /AS1			
First-CH, Last-CH	Channel number	001	
Tag > Comment	32 characters or less	-	
Tag > No.	16 characters or less	-	
Memory sample > On/Off	On/Off	On	
Alarm delay > Time	1 to 3600	10	
With /AS1			
The First-CH, Last-CH, Tag, and Memory sample items are the same as on a DX without the /AS1 option.			
Alarm delay > Time	1 to 3600 when the unit is seconds. 1 to 24 when the unit is hours.	10	
Alarm delay > Unit	Hour/Sec	Sec	

Meas channel > Moving average

Setup Item	Selectable Range or Selections	Default Value	Setting
First-CH, Last-CH	Channel number	001	
Moving average > On/Off	On/Off	Off	
Moving average > Count	2 to 400	2	

Setup Items and Default Values

Meas channel > Color

Setup Item	Selectable Range or Selections	Default Value	Setting
Group of channel	001-010, etc	Depends on the model.	
Color	Red/Green/Blue/B.violet/Brown/Orange/ Y.green/Lightblue/Violet/Graly/Lime/Cyan/ Darkblue/Yellow/Lightgray/Purple/Black/Pink/ L.brown/L.green/Darkgray/Olive/DarkCyan/ S.green (24 colors)	Red to Gray	

Meas channel > Zone, Scale, Bar graph

Setup Item	Selectable Range or Selections	Default Value	Setting
First-CH, Last-CH	Channel number	001	
Zone > Lower	0 to 95	0	
Zone > Upper	5 to 100	100	
Scale > Position	Off/1/2/3/4/5/6/7/8/9/10	1	
Scale > Division	4/5/6/7/8/9/10/11/12/C10	10	
Bar graph > Base position	Normal/Center/Lower ^{*1} /Upper ^{*1}	Normal	
Bar graph > Division	4/5/6/7/8/9/10/11/12	10	

Meas channel > Partial

Setup Item	Selectable Range or Selections	Default Value	Setting
First-CH, Last-CH	Channel number	001	
On/Off	On/Off	Off	
Expand	1 to 99%	50	
Boundary	Span Lower+1digit to Span Upper-1digit	0.0000	

Meas channel > Alarm mark, Color scale band

Setup Item	Selectable Range or Selections	Default Value	Setting
First-CH, Last-CH	Channel number	001	
Alarm mark > Mark kind	Alarm/Fixed	Alarm	
Alarm mark > Indicate on Scale	On/Off	Off	
Alarm mark > Alarm mark color > Alarm 1	Red/Green/.../S.green (24 colors)	Red	
Alarm mark > Alarm mark color > Alarm 2	Same as Alarm 1	Orange	
Alarm mark > Alarm mark color > Alarm 3	Same as Alarm 1	Orange	
Alarm mark > Alarm mark color > Alarm 4	Same as Alarm 1	Red	
Color scale band > Band area	Off/In/Out	Off	
Color scale band > Color	Auto/Red/Green/.../S.green (24 colors)	Lime	
Color scale band > Display position > Lower	Measuring range	0.0000	
Color scale band > Display position > Upper	Measuring range	0.0100	

Meas channel > Calibration correction

Setup Item	Selectable Range or Selections	Default Value	Setting
First-CH, Last-CH	Channel number	001	
Number of set points	Off/2/3/4/5/6/7/8/9/10/11/12/13/14/15/16	Off	
1 to n > MES val	Value in the measuring range/measured value	-	
1 to n > True val	Measuring range	-	

Math channel > Calculation expression, Alarm

Setup Item	Selectable Range or Selections	Default Value	Setting
First-CH, Last-CH	Channel number	101	
Math range > Math On/Off	On/Off	Off	
Math range > Calculation expression	120 characters or less	–	
Math range > Span Lower	–9999999 to 99999999, decimal position: 0 to 4	–200.00	
Math range > Span Upper	–9999999 to 99999999, decimal position: 0 to 4	200.00	
Math range > Unit	6 characters or less	–	
Math alarm			
1, 2, 3, 4	On/Off	Off	
Type	H:High/L:Low/T:delayH/t:delayL	–	
Value	Numerical value	–	
Relay On/Off	On/Off	Off	
Number	I01/.../I06, I11/.../I16, I21/.../I26, I31/.../I36 (Depends on the option.) S01/S02/S03/.../S29/S30	I01	
Detect	On/Off	On	

Math channel > Constant

Setup Item	Selectable Range or Selections	Default Value	Setting
Number of constant	K01 to K60	K01	
Value	–9.9999E+29 to –1.0000E–30, 0, 1.0000E–30 to –9.9999E+29	1	

Math channel > Tag, Memory sample, Alarm delay

Setup Item	Selectable Range or Selections	Default Value	Setting
First-CH, Last-CH	Channel number	101	
Tag > Comment	32 characters or less	–	
Tag > No.	16 characters or less	–	
Memory sample > On/Off	On/Off	On	
Alarm delay > Time	1 to 3600	10	

Math channel > TLOG, Rolling average

Setup Item	Selectable Range or Selections	Default Value	Setting
First-CH, Last-CH	Channel number	101	
TLOG > Timer type	Timer/Match T	Timer	
TLOG > Timer No.	1/2/3/4 1/2/3/.../11/12 (on models with the /BT2 multi batch option)	1	
TLOG > Sum scale	Off, /s, /min, /h	Off	
TLOG > Reset	On/Off	Off	
Rolling average > On/Off	On/Off	Off	
Rolling average > Interval	1s/2s/3s/4s/5s/6s/10s/12s/15s/20s/30s/ 1min/2min/3min/4min/5min/6min/10min/12min/ 15min/20min/30min/1h	10s	
Rolling average > Number of samples	1 to 1500	1	

Math channel > Color

Setup items and values are the same as those for measurement channels, except the channel numbers.

Math channel > Zone, Scale, Bar graph

Setup items and values are the same as those for measurement channels, except the channel numbers.

Math channel > Partial

Setup items and values are the same as those for measurement channels, except the channel numbers.

Math channel > Alarm mark, Color scale band

Setup items and values are the same as those for measurement channels, except the channel numbers.

Setup Items and Default Values

Math channel > Math start action

Setup Item	Selectable Range or Selections	Default Value	Setting
Math start action > Math start	Off/Start/Rst+St	Start	

Ext. channel > Range, Alarm

Setup Item	Selectable Range or Selections	Default Value	Setting
First-CH, Last-CH	Channel number	201	
Ext. range > On/Off	On/Off	Off	
Ext. range > Span Lower	-30000 to 30000, decimal position: 0 to 4	-200.00	
Ext. range > Span Upper	-30000 to 30000, decimal position: 0 to 4	200.00	
Ext. range > Unit	6 characters or less	-	
Ext. alarm			
1, 2, 3, 4	On/Off	Off	
Type	H:High/L:Low/T:delayH/t:delayL	-	
Value	Numerical value	-	
Relay On/Off	On/Off	Off	
Number	I01/.../I06, I11/.../I16, I21/.../I26, I31/.../I36 (Depends on the option.) S01/S02/S03/.../S29/S30	I01	
Detect	On/Off	On	

Ext. channel > Color

Setup items and values are the same as those for measurement channels, except the channel numbers.

Ext. channel > Zone, Scale, Bar graph

Setup items and values are the same as those for measurement channels, except the channel numbers.

Ext. channel > Partial, Alarm mark, Color scale band

Setup items and values are the same as those for measurement channels, except the channel numbers.

Setup Items and Default Values

Display > Trend (Circular)/Save interval

Setup Item	Selectable Range or Selections	Default Value	Setting
Trend/Save interval			
Trend interval [/div]	5s/10s/15s/30s/1min/2min/5min/10min/15min/20min/30min/1h/2h/4h/10h (Depends on the model.)	1min	
Save interval	10min to 31day (Depends on the trend interval.)	1h	
Second interval [/div]	5s/10s/15s/30s/1min/2min/5min/10min/15min/20min/30min/1h/2h/4h/10h (Depends on the model.)	1min	
Circular/Save interval			
Time per revolution [/rev]	20min/30min/1h/2h/6h/8h/12h/16h/1day/2day/1week/2week/4week	1day	
Save interval	10min to 31day (Depends on the time per revolution.)	1h	
Offset time	Off/1h to 23h (Depends on the time per revolution.)	Off	

Display > Trend (Circular), Bar graph, LCD, Monitor

Setup Item	Selectable Range or Selections	Default Value	Setting
Trend			
Trend > Direction	Horizontal/Vertical/Wide/Split	Horizontal	
Trend > Trend clear	On/Off	Off	
Trend > Message direction	Horizontal/Vertical	Horizontal	
Trend > Scale > Digit	Normal/Fine	Normal	
Trend > Scale > Value indicator	Mark/Bargraph	Mark	
Trend > Trend line	1/2/3	2	
Trend > Grid	Auto/4/5/6/7/8/9/10/11/12	Auto	
Circular			
Circular > Full circle action	Allclear/Divclear	Allclear	
Circular > Trend line	1/2/3	2	
Circular > Grid	Auto/4/5/6/7/8/9/10/11/12	Auto	
Bar graph > Direction	Horizontal/Vertical	Vertical	
LCD > Brightness	1/2/3/4/5/6	2	
LCD > Backlight saver > Mode	Off/Dimmer/Timeoff	Off	
LCD > Backlight saver > Saver time	1min/2min/5min/10min/30min/1h	1h	
LCD > Backlight saver > Restore	Key, Key+Alarm	Key+Alarm	
Monitor > Background > Display	White/Black	White	
Monitor > Background > Historical trend	White/Cream/Black/Lightgray	Black	
Monitor > Scroll time	5s/10s/20s/30s/1min	10s	
Monitor > Jump default display	Off/1min/2min/5min/10min/20min/30min/1h	Off	

Display > Annunciator

Setup Item	Selectable Range or Selections	Default Value	Setting
Annunciator position	1 to 80	1	
On/Off	On/Off	Off	
Channel	Channel number	001	
Level	1 /2/3/4/All	1	
Comment txt block No.	1 to 100	1	

Display > FAVORITE Key action

Setup Item	Selectable Range or Selections	Default Value	Setting
Action	History/Favorite	Favorite	
Group display	Current/Saved	Saved	
Time axis zoom	Current/Saved	Saved	

Group set, Trip line

Setup Item	Selectable Range or Selections	Default Value	Setting
Group number	1/2/3/.../35/36	1	
Group set > On/Off	On/Off	Group 1 to 4: On Group 5 to 36: Off	
Group set > Group name	16 characters or less	GROUP1 etc.	
Group set > CH set	39 characters or less	Depends on the model.	
Trip line > 1	On/Off	Off	
Trip line > 2	On/Off	Off	
Trip line > 3	On/Off	Off	
Trip line > 4	On/Off	Off	
Trip line > Position	0 to 100	50	
Trip line > Color	Red/Green/.../S.green (24 colors)	1:Red, 2:Green 3:Blue, 4:Yellow	
Trip line > Line width	1/2/3	2	

Message, Comment Text > Message

Setup Item	Selectable Range or Selections	Default Value	Setting
Message No.	1-10/11-20/21-30/31-40/41-50/51-60/ 61-70/71-80/81-90/91-100	11-20	
1 to 100	32 characters or less	–	

Message, Comment Text > Comment text fields

Setup Item	Selectable Range or Selections	Default Value	Setting
Coment txt field no	1 to 200	1	
Text info	32 characters or less	–	

Message, Comment Text > Comment text block

Setup Item	Selectable Range or Selections	Default Value	Setting
Coment txt block no	1 to 100	1	
Line > 1 > Comment txt field no	1 to 200	1	
Line > 2 > Comment txt field no	1 to 200	1	
Line > 3 > Comment txt field no	1 to 200	1	
Line > 4 > Comment txt field no	1 to 200	1	
Line > 5 > Comment txt field no	1 to 200	1	

Timer, Event action > Timer

Setup Item	Selectable Range or Selections	Default Value	Setting
Timer No.	1/2/3/4 1/2/3/.../11/12 (on models with the /BT2 multi batch option)	1	
Mode	Off/Relative/Absolute	Off	
Relative > Interval	00:01 to 24:00	01:00	
Relative > Reset at Math Start	On/Off	On	
Absolute > Interval	1min/2min/3min/4min/5min/6min/10min/ 12min/15min/20min/30min/1h/2h/3h/4h/ 6h/8h/12h/24h	1h	
Absolute > Ref.time	0 to 23	0:00	

Setup Items and Default Values

Timer, Event action > Match time timer

Setup Item	Selectable Range or Selections	Default Value	Setting
Timer number	1/2/3/4 1/2/3/.../11/12 (on models with the /BT2 multi batch option)	1	
Kind	Off/Day/Week/Month	Off	
Day	1 to 31 (varies depending on the month)	1	
Day of the week	SUN/MON/TUE/WED/THU/FRI/SAT	SUN	
Hour	00:00 to 23:59	00:00	
Timer action	Single/Repeat	Repeat	

Timer, Event action > Event action

Setup Item	Selectable Range or Selections	Default Value	Setting
Logic box number	1/2/3/.../39/40	1	
Event	None/Remote/Relay/Switch/Timer/ Matchtime/Alarm/UserKey/ EventLevelSwitch/EventEdgeSwitch/ Relay-Off/Switch-Off/Alarm-Off/ EventLevelSwitch-Off	None	
Remote > Remote number	1/2/3/4/5/6/7/8	1	
Relay > Relay number	I01/.../I06, I11/.../I16, I21/.../I26, I31/.../I36, (Depends on the option.) I01/.../I06, I11/.../I16, I21/.../I26, I31/.../I36, (Depends on the option.)	I01	
Switch > Switch No.	S01/S02/S03/.../S29/S30	S01	
Timer > Timer No.	1/2/3/4 1/2/3/.../11/12 (on models with the /BT2 multi batch option)	1	
MatchTimeTimer > Match Time Timer No.	1/2/3/4 1/2/3/.../11/12 (on models with the /BT2 multi batch option)	1	
EventLevelSwitch > Event Switch No	1/2/3/.../29/30	1	
EventEdgeSwitch > Event Switch No	1/2/3/.../29/30	1	
Relay-Off > Relay number	I01/.../I06, I11/.../I16, I21/.../I26, I31/.../I36 (Depends on the option.)	I01	
Switch-Off > Switch No.	S01/S02/S03/.../S29/S30	S01	
EventLevelSwitch-Off > Event Switch No	1/2/3/.../30	1	

Setup Item	Selectable Range or Selections	Default Value	Setting
Action	MemoryStart/Stop, MemoryStart, MemoryStop, Trigger (not selectable on a DX with the /AS1 option), AlarmACK, AlarmDisplayReset, MathStart/Stop, MathStart, MathStop, MathReset, SaveDisplay, SaveEvent, Message, Snapshot, DisplayRate1/2, ManualSample, TimerReset, DisplayGroupChange, FavoriteDisplay, CommentDisplay, Flag, PanelLoad (not selectable on a DX with the /AS1 option), TimeAdjust (Depends on the events, etc)	Group	
	1 to 100		
Message > Message No.	All/Select	1	
Message > Write to	1/2/3/.../35/36	All	
Message > Group number	1/2/3/.../35/36	1	
Group > Group number	Key/Select	1	
FavoriteDisplay > Action		Key	
FavoriteDisplay > Select	1/2/3/4/5/6/7/8		
> Favorite Screen No		1	
CommentDisplay	1 to 100		
> Comment Txt Block No	1/2/3/4/5/6/7/8	1	
Flag > Flag number	1/2/3/4	1	
TimerReset > Timer No.	1/2/3/.../11/12 (on models with the /BT2 multi batch option)	1	
	1/2/3		
PanelLoad > Setting file number		1	
The following menus appear when the multi batch function is in use.			
MemoryStart/Stop > Target Action	All/Select	All	
MemoryStart/Stop > Select			
> Batch Group No	1/2/3/.../11/12 (varies depending on settings)	1	
MemoryStart > Target Action	All/Select	All	
MemoryStart > Select			
> Batch Group No	1/2/3/.../11/12 (varies depending on settings)	1	
MemoryStop > Target Action	All/Select	All	
MemoryStop > Select			
> Batch Group No	1/2/3/.../11/12 (varies depending on settings)	1	
SaveDisplay > Target Action	All/Select	All	
SaveDisplay > Select			
> Batch Group No	1/2/3/.../11/12 (varies depending on settings)	1	
SaveEvent > Target Action	All/Select	All	
SaveEvent > Select			
> Batch Group No	1/2/3/.../11/12 (varies depending on settings)	1	
MathReset > Target Action	All/Select	All	
MathReset > Select			
> Batch Group No	1/2/3/.../11/12 (varies depending on settings)	1	
Message > Message No.	1 to 100	1	
Message > Write to	All/Select	All	
Message > Select			
> Batch Group No	1/2/3/.../11/12 (varies depending on settings)	1	
> Display Group No	1/2/3/.../11/12	1	
Message > All			
> Batch Group No	1/2/3/.../11/12 (varies depending on settings)	1	
DisplayGroupChange			
> Batch Group No	1/2/3/.../11/12 (varies depending on settings)	1	
DisplayGroupChange			
> Display Group No	1/2/3/.../11/12	1	

Setup Items and Default Values

Data save > File header, Data file name

Setup Item	Selectable Range or Selections	Default Value	Setting
File header > Characters	50 characters or less	–	
Data file name > Structure	Date/Serial/Batch	Date	
Data file name > Identified strings	16 characters or less	–	

Data save > Save directory

Setup Item	Selectable Range or Selections	Default Value	Setting
Directory name	20 characters or less	DATA0	

Data save > Event data

Setup Item	Selectable Range or Selections	Default Value	Setting
Without /AS1			
Sample rate	25ms/125ms/250ms/500ms/1s/2s/5s/10s/30s/60s /120s/300s/600s/15min/20min/30min (Depends on the model.)	1s	
Mode	Free/Single/Repeat	Free	
Data length	10min to 31day (Depends on the sample rate.)	1h	
Pre-trigger	0/5/25/50/75/95/100	0	
Trigger signal > Key	On/Off	On	
With /AS1			
The Sample rate and Data length items are the same as on a DX without the /AS1 option.			
Mode	Fixed at Free	Free	
There are no Pre-trigger or Trigger signal > Key items.			

Data save > Manual sample

Setup Item	Selectable Range or Selections	Default Value	Setting
Manual sample number	001 to 120	001	
On/Off	On/Off	On	
Channel	Channel number	001	

Data save > Batch text

Setup Item	Selectable Range or Selections	Default Value	Setting
Text field number	1 to 24	1	
Text field > Title of field	20 characters or less	–	
Text field > Characters	30 characters or less	–	

Web Report

Setup Item	Selectable Range or Selections	Default Value	Setting
Web Report No	1/2/3/4/5/6/7/8/9/10	1	
On/Off	On/Off	Off	
Title	64 characters or less	–	
Item > 1 to 10	On/Off	Off	
Item > 1 to 10 > Report CH	R01/R02/.../R60	R01	
Item > 1 to 10 > Value	Max/Min/Ave/Sum/Inst	Sum	
Item > 1 to 10 > Name	16 characters or less	–	

Menu customize

Setup Item	Selectable Range or Selections	Default Value	Setting
Function menu	Select/Hide/View/Transfer	–	
Display menu	Separate/Select/Hide/View/Transfer	–	

End (/AS1 option)

Setup Item	Selectable Range or Selections	Default Value	Setting
End	Yes/No	–	

Basic setting mode

Setup Item	Selectable Range or Selections	Default Value	Setting
Entering basic setting mode. ...	Yes/No	–	

Multi batch tab

Group set, Trip line > Group set

Setup Item	Selectable Range or Selections	Default Value	Setting
First Batch Group No, Last Batch Group No.	1/2/3/4/5/6/7/8/9/10/11/12 (varies depending on settings)	1	
Display Group No	1/2/3/4/5/6/7/8/9/10/11/12	1	
Set Display Group > On/Off	On/Off	Off	
Set Display Group > Group name	16 characters or less	BATCH-1, etc.	
Set Display Group > CH set	39 characters or less	Depends on the model.	
Trip line			
1, 2, 3, 4	On/Off	Off	
Position	0 to 100	50	
Color	Red/Green/.../S.green (24 colors)	1:Red, 2:Green 3:Blue, 4:Yellow	
Line Width	1/2/3	2	

File header, File name

Setup Item	Selectable Range or Selections	Default Value	Setting
First Batch Group No, Last Batch Group No.	1/2/3/.../11/12 (varies depending on settings)	1	
File header > Characters	50 characters or less	–	
Data file name > Structure	Date/Serial/Batch	Date	
Data file name > Identified strings	16 characters or less	–	

Data save > Batch text

Setup Item	Selectable Range or Selections	Default Value	Setting
First Batch Group No, Last Batch Group No.	1/2/3/.../11/12 (varies depending on settings)	1	
Text field number	1 to 24	1	
Text field > Title of field	20 characters or less	–	
Text field > Characters	30 characters or less	–	

End (/AS1 option)

Setup Item	Selectable Range or Selections	Default Value	Setting
End	Yes/No	–	

Set Calibration Tab

Setup Item	Selectable Range or Selections	Default Value	Setting
Calibration correction	Same as Meas channel > Calibration correction		
Finish Calibration > Next calibration due	Year, month, and date	–	
Finish Calibration > Execute	–	–	

End (/AS1 option)

Setup Item	Selectable Range or Selections	Default Value	Setting
End	Yes/No	–	

File tab

Load display data

Setup Item	Selectable Range or Selections	Default Value	Setting
Kind	CF/USB	CF	

Load event data

Setup Item	Selectable Range or Selections	Default Value	Setting
Kind	CF/USB	CF	

Load settings

Setup Item	Selectable Range or Selections	Default Value	Setting
Kind	CF/USB	CF	

Save settings

Setup Item	Selectable Range or Selections	Default Value	Setting
Kind	CF/USB	CF	
File name	32 characters or less	–	

Custom display load > Select

Setup Item	Selectable Range or Selections	Default Value	Setting
Display No.	Internal 1 to Internal 3, External 1 to External 25	Internal 1	
File selection screen	–	–	

Custom display load > All

Setup Item	Selectable Range or Selections	Default Value	Setting
Directory selection screen	–	–	

Custom display save > Select

Setup Item	Selectable Range or Selections	Default Value	Setting
Display No.	Internal 1 to Internal 3, External 1 to External 25	Internal 1	
File name	32 characters or less	–	

Custom display save > All

Setup Item	Selectable Range or Selections	Default Value	Setting
Directory name	20 characters or less	–	

File list/delete (Delete is not available on DXs with the /AS1 option.)

Setup Item	Selectable Range or Selections	Default Value	Setting
Kind	CF/USB	CF	

Load template

Setup Item	Selectable Range or Selections	Default Value	Setting
Report Kind	Hour, Day, Week, Month, Hour+Day, Day+Week, Day+Month	–	

Save template

Setup Item	Selectable Range or Selections	Default Value	Setting
Report Kind	Hour, Day, Week, Month, Hour+Day, Day+Week, Day+Month	–	
Template data save > File name	32 characters or less	–	

Format (Without /AS1)

Setup Item	Selectable Range or Selections	Default Value	Setting
Kind	CF/USB	CF	
Format > Volume name	11 characters or less	–	

End (/AS1 option)

Setup Item	Selectable Range or Selections	Default Value	Setting
End	Yes/No	–	

Setup Items in Basic Setting Mode and Their Default Values

Environment tab

Operating environment

Setup Item	Selectable Range or Selections	Default Value	Setting
Tag/Channel	Tag/Channel	Tag	
Language	English/Japanese/German/French/Chinese	English	
Temperature	C/F	C	
Decimal Point Type	Point/Comma	Point	
Basic setting mode Menu display	On/Off	On	

View, Message, Input, Tag

Setup Item	Selectable Range or Selections	Default Value	Setting
View > Trend type	T-Y/Circular	T-Y	
View > Partial	On/Off	Off	
View > Trend rate switching	On/Off	Off	
Message > Write group	Common/Separate	Common	
Message > Power-fail message	On/Off	Off	
Message > Change message	On/Off	Off	
Input > Value on over-range	Free/Over	Over	
Tag Basic settings > Tag No. Use/Not	Use/Not	Not	

Alarm > Action

Setup Item	Selectable Range or Selections	Default Value	Setting
No logging	On/Off	Off	
Annunciator mode	On/Off	Off	
Sequence	ISA-A-4/ISA-A/ISA-M	ISA-A	
Time off color	White/Green	Green	

Alarm > Level/Color

Setup Item	Selectable Range or Selections	Default Value	Setting
Level	1-2-3-4/1-4-2-3/1-4-3-2	1-2-3-4	
Color > 1	Red/Yellow/Orange/Pink	Red	
Color > 2	Red/Yellow/Orange/Pink	Red	
Color > 3	Red/Yellow/Orange/Pink	Red	
Color > 4	Red/Yellow/Orange/Pink	Red	

Remote

Setup Item	Selectable Range or Selections	Default Value	Setting
Level	1-2-3-4/1-4-2-3/1-4-3-2	1-2-3-4	
Remote Input > 1	N.O/N.C	N.O	
Remote Input > 2	N.O/N.C	N.O	
Remote Input > 3	N.O/N.C	N.O	
Remote Input > 4	N.O/N.C	N.O	
Remote Input > 5	N.O/N.C	N.O	
Remote Input > 6	N.O/N.C	N.O	
Remote Input > 7	N.O/N.C	N.O	
Remote Input > 8	N.O/N.C	N.O	

Security, Media save, Batch

Setup Item	Selectable Range or Selections	Default Value	Setting
Without /AS1			
Security > Key	Off/Login/Keylock	Off	
Security > Communication	Off/Login	Off	
Security > Touch panel	Off/On/Password	On	
Save > Auto save	On/Off	On	
Save > Media FIFO ¹	On/Off	Off	
With /AS1			
Security > Key	Login	Login	
Security > Communication	Off/Login	Off	
Security > Multi login	On/Off	Off	
Security > Password management	On/Off	Off	
Security > Touch panel	Off/On/Password	On	
The Save items are the same as on a DX without the /AS1 option.			
The Batch items are the same as on a DX without the /AS1 option.			

Batch

Setup Item	Selectable Range or Selections	Default Value	Setting
Batch > On/Off	On/Off/MultiBatch	Off (With /AS1, On)	
Batch > Lot-No. digit	Off/4/6/8	6	
Batch > Auto increment	On/Off	On	
Batch operation qty	2/3/4/5/6/7/8/9/10/11/12	4	

Communication > Service port

Setup Item	Selectable Range or Selections	Default Value	Setting
FTP	1 to 65535	21	
HTTP	1 to 65535	80	
SNTP	1 to 65535	123	
Modbus	1 to 65535	502	

Communication > POP3 Details

Setup Item	Selectable Range or Selections	Default Value	Setting
POP Before SMTP > Send delay [second]	0/1/2/3/4/5/6/7/8/9/10	2	
POP3 Login	PLANE/APOP	PLAIN	

Communication > FTP Server Details

Setup Item	Selectable Range or Selections	Default Value	Setting
Output Directory Format	MS-DOS/UNIX	MS-DOS	

Math, Report

Setup Item	Selectable Range or Selections	Default Value	Setting
Math > Value on Error	+Over/-Over	+Over	
Math > Value on Overflow > SUM, AVE	Error/Skip/Limit	Skip	
Math > Value on Overflow > MAX, MIN, P-P	Over/Skip	Over	
Report > Report select > 1	Max/Min/Ave/Sum/Inst	Ave	
Report > Report select > 2	Off/Max/Min/Ave/Sum/Inst	Max	
Report > Report select > 3	Off/Max/Min/Ave/Sum/Inst	Min	
Report > Report select > 4	Off/Max/Min/Ave/Sum/Inst	Sum	
Report > File type	Separate/Combine/Separate2	Separate	
Report > Use Template	Use/Not	Not	

End

Setup Item	Selectable Range or Selections	Default Value	Setting
Do you want to store and make the new settings take effect?	Yes/No/Cancel	-	

Menu tab

Alarm

Setup Item	Selectable Range or Selections	Default Value	Setting
Basic setting			
Reflash	On/Off/On-1s/On-2s	Off	
Rate of change > Decrease	1 to 32	1	
Rate of change > Increase	1 to 32	1	
Indicator	Hold/Nonhold	Nonhold	
Switch, Relay			
Internal Switch > AND	None/S01/S01-S02/.../S01-S29/S01-S30	None	
Relay > AND	None/I01/I01-I02/.../I01-I35/I01-I36	None	
Relay > Action	Energize/De_energ	Energize	
Relay > Hold	Hold/Nonehold	Nonhold	
Relay > Relay Action on ACK ^{†1}	Normal/Reset	Normal	
Hysteresis			
Meas CH > High/Low	0.0 to 5.0	0.5	
Meas CH > Delta High/Low	0.0 to 5.0	0.0	
Math CH > High/Low	0.0 to 5.0	0.0	
Ext. CH > High/Low	0.0 to 5.0	0.0	

A/D, Memory

Setup Item	Selectable Range or Selections	Default Value	Setting
Without /AS1			
Scan interval > Scan mode	Normal/Fast	Normal	
Normal > Scan interval	125ms/250ms(DX2004T, DX2008T) 1s/2s/5s(DX2010T, DX2020T, DX2030T, DX2040T, DX2048T)	125ms 1s	
Normal > A/D integrate	Auto/50Hz/60Hz/100ms	Auto	
Fast † > Scan interval	25ms (DX2004T, DX2008T) 125ms (DX2010T, DX2020T, DX2030T, DX2040T, DX2048T)	25ms 125ms	
Fast † > A/D integrate	600Hz	600Hz	
Memory > Data kind	Display/E+D/Event	Display	
With /AS1			
The Scan interval items are the same as on a DX without the /AS1 option.			
Memory > Data kind	Display/Event	Display	

†: You cannot select this option on a DX with external input channels (/MC1) or when the multi batch function (/BT2) is in use.

Signature (/AS1 option)

Setup Item	Selectable Range or Selections	Default Value	Setting
Process type	Batch/Continue	Batch	
Sign from recorder	Off/Sign1/Sign1+2/Sign1+2+3	Off	
Signature at batch stop	On/Off	Off	
FTP transfer at signing	On/Off	Off	

Burnout, RJC

Setup Item	Selectable Range or Selections	Default Value	Setting
First-CH, Last-CH	Channel number	001	
Burnout set > Mode	Off/Up/Down	Off	
RJC > Mode	Internal/External	Internal	
RJC > Volt	-20000 to 20000μV	0	

Keylock (Without /AS1)

Setup Item	Selectable Range or Selections	Default Value	Setting
Password	8 characters or less	–	
Key action > START	Free/Lock	Free	
Key action > STOP	Free/Lock	Free	
Key action > MENU	Free/Lock	Free	
Key action > USER	Free/Lock	Free	
Key action > DISP/ENTER	Free/Lock	Free	
Key action > FAVORITE	Free/Lock	Free	
Media/USB > External media	Free/Lock	Free	
Media/USB > Load settings	Free/Lock	Free	
Action of Function > AlarmACK	Free/Lock	Free	
Action of Function > Message/Batch	Free/Lock	Free	
Action of Function > Math	Free/Lock	Free	
Action of Function > Data save	Free/Lock	Free	
Action of Function > E-mail/FTP	Free/Lock	Free	
Action of Function > Time set	Free/Lock	Free	
Action of Function > Display Function	Free/Lock	Free	

Login > Basic settings

Setup Item	Selectable Range or Selections	Default Value	Setting
Without /AS1			
Auto logout	Off/1min/2min/5min/10min	Off	
Operation without Login	Off/Display	Off	
With /AS1			
Auto logout	Off/1min/2min/5min/10min	Off	
Operation without Login	Off/Display	Off	
User ID	Use/Not	Use	
Password retry frequency	3/5/Off	3	
Root password > Password	20 characters or less	????????	

Login > Admin settings

Setup Item	Selectable Range or Selections	Default Value	Setting
Without /AS1			
Admin number	1 to 5	1	
Mode	Off/Key/Web/Key+Comm	Off	
User name	20 characters or less	Admin1 etc.	
Password	20 characters or less	????????	
With /AS1			
Admin number	1 to 5	1	
Mode	Off/Key/Web/Key+Comm	Off	
User name	20 characters or less	Admin1 etc.	
User ID	8 characters or less	–	
Password	20 characters or less	????????	
Password expire	Off/1month/3month/6month	Off	

Setup Items and Default Values

Login > User settings

Setup Item	Selectable Range or Selections	Default Value	Setting
Without /AS1			
User number	1 to 30	1	
Mode	Off/Key/Comm/Web/Key+Comm	Off	
User name	20 characters or less	User1 etc.	
Password	20 characters or less	????????	
Authority of user	Off/1/2/3/4/5/6/7/8/9/10	Off	
With /AS1			
User number	1 to 90	1	
Mode	Off/Key/Comm/Web/Key+Comm	Off	
User name	20 characters or less	User1 etc.	
User ID	8 characters or less	–	
Password	20 characters or less	????????	
Password expire	Off/1month/3month/6month	Off	
Authority of user	Off/1/2/3/4/5/6/7/8/9/10	Off	

Login > Authority of user > Key action, Media

Setup Item	Selectable Range or Selections	Default Value	Setting
Without /AS1			
Authority of user	1/2/3/4/5/6/7/8/9/10	1	
Key action > START	Free/Lock	Free	
Key action > STOP	Free/Lock	Free	
Key action > MENU	Free/Lock	Free	
Key action > USER	Free/Lock	Free	
Key action > DISP/ENTER	Free/Lock	Free	
Key action > FAVORITE	Free/Lock	Free	
Media/USB > External media	Free/Lock	Free	
Media/USB > Load settings	Free/Lock	Free	
Authority of user	1/2/3/4/5/6/7/8/9/10	1	
Action of Function > AlarmACK	Free/Lock	Free	
Action of Function > Message/Batch	Free/Lock	Free	
Action of Function > Math	Free/Lock	Free	
Action of Function > Data save	Free/Lock	Free	
Action of Function > E-mail/FTP	Free/Lock	Free	
Action of Function > Time set	Free/Lock	Free	
Action of Function > Display Function	Free/Lock	Free	
With /AS1			
The Authority of user, Key action, and Media/USB items are the same as on a DX without the /AS1 option.			
Actions > AlarmACK	Free/Lock	Free	
Actions > Message/Batch	Free/Lock	Free	
Actions > Math	Free/Lock	Free	
Actions > Data save	Free/Lock	Free	
Actions > E-mail/FTP	Free/Lock	Free	
Actions > Time set	Free/Lock	Free	
Actions > Display Function	Free/Lock	Free	
Action > Calibration	Free/Lock	Free	
Sign record > Signature1	Free/Lock	Free	
Sign record > Signature2	Free/Lock	Free	
Sign record > Signature3	Free/Lock	Free	

Report > Basic settings

Setup Item	Selectable Range or Selections	Default Value	Setting
Report kind	Off/Hour/Day/Hour+Day/Day+Week/Day+Month	Off	
Date	1 to 28	1	
Day of the week (Day+week)	SUN/MON/TUE/WED/THU/FRI/SAT	SUN	
Time (hour)	0 to 23	0:00	

Report > Report settings

Setup Item	Selectable Range or Selections	Default Value	Setting
Report channel number	R01/R02/R03/.../R59R60	R01	
On/Off	On/Off	Depends on the model	
Channel	Channel number	001 etc.	
Sum scale	Off, /s, /min, /h, /day	/s	

Time settings

Setup Item	Selectable Range or Selections	Default Value	Setting
Time zone (HHMM)	-1300 to 1300	900	
Time deviation limit	Off/10s/20s/30s/1min/2min/3min/4min/5min	30s	
Date format	Y/M/D, M/D/Y, D/M/Y, D.M.Y	Y/M/D	
Calendar display > 1st weekday	SUN/MON	MON	

Setup Items and Default Values

Communication (Ethernet) > IP-address, Host settings

Setup Item	Selectable Range or Selections	Default Value	Setting
DHCP	Use/Not	Not	
DNS accession	Use/Not	Use	
Host-name register	Use/Not	Use	
Fixed IP-address > IP-address	0.0.0.0 to 255.255.255.255	0.0.0.0	
Fixed IP-address > Subnet mask	0.0.0.0 to 255.255.255.255	0.0.0.0	
Fixed IP-address > Default gateway	0.0.0.0 to 255.255.255.255	0.0.0.0	
Host settings > Host name	64 characters or less	–	
Host settings > Domain name	64 characters or less	–	

Communication (Ethernet) > DNS settings

Setup Item	Selectable Range or Selections	Default Value	Setting
Server search order > Primary	0.0.0.0 to 255.255.255.255	0.0.0.0	
Server search order > Secondary	0.0.0.0 to 255.255.255.255	0.0.0.0	
Domain suffix search order > Primary	64 characters or less	–	
Domain suffix search order > Secondary	64 characters or less	–	

Communication (Ethernet) > Keep alive, Application time out

Setup Item	Selectable Range or Selections	Default Value	Setting
Keep alive	On/Off	On	
Application time out > On/Off	On/Off	Off	
Application time out > Time	1 to 120 (min)	1	

Communication(Ethernet) > Server > Server modes

Setup Item	Selectable Range or Selections	Default Value	Setting
FTP	Use/Not	Use	
Web	Use/Not	Use ^{*1}	
SNTP	Use/Not	Not	
Modbus	Use/Not	Not	
EtherNet/IP	Use/Not	Not	

Communication(Ethernet) > Server > Allowed Modbus clients

Setup Item	Selectable Range or Selections	Default Value	Setting
Use/Not	Use/Not	Not	
Client number	1/2/3/4/5/6/7/8/9/10	1	
On/Off	On/Off	Off	

Communication (Ethernet) > Web page

Setup Item	Selectable Range or Selections	Default Value	Setting
Without /AS1			
Page type	Operator/Monitor	Operator	
Page type=Operator			
Web page > On/Off	On/Off	Off	
Web page > Access control	Off/Admin	Off	
Web page > Command	Use/Not	Not	
Page type=Monitor			
Web page > On/Off	On/Off	Off	
Web page > Access control	Off/Admin/User	Off	
With /AS1			
Page type	Operator/Monitor	Operator	
Page type=Operator			
Web page > On/Off	On/Off	Off	
Web page > Access control	Off/Admin	Off	

The items when Page type is set to Monitor are the same as on a DX without the /AS1 option.

Communication (Ethernet) > E-Mail > Basic settings

Setup Item	Selectable Range or Selections	Default Value	Setting
SMTP server name	64 characters or less	–	
Port number	0 to 65535	25	
Security	Off/PbS/Auth	Off	
SMTP authorization > User name (when Auth is selected)	32 characters or less	–	
SMTP authorization > Password (when Auth is selected)	32 characters or less	–	

Communication (Ethernet) > E-Mail > Recipients

Setup Item	Selectable Range or Selections	Default Value	Setting
Recipient 1	150 characters or less	–	
Recipient 2	150 characters or less	–	
Sender	64 characters or less	–	

Communication (Ethernet) > E-Mail > POP3 settings

Setup Item	Selectable Range or Selections	Default Value	Setting
POP3 Server name	64 characters or less	–	
Port number	0 to 65535	110	
Login name	32 characters or less	–	
Password	32 characters or less	***** ... ***	

Communication (Ethernet) > E-Mail > Alarm settings

Setup Item	Selectable Range or Selections	Default Value	Setting
Recipient 1	On/Off	Off	
Recipient 2	On/Off	Off	
Active Alarms > Alarm 1	On/Off	Off	
Active Alarms > Alarm 2	On/Off	Off	
Active Alarms > Alarm 3	On/Off	Off	
Active Alarms > Alarm 4	On/Off	Off	
Include INST	On/Off	Off	
Include source URL	On/Off	Off	
Subject	32 characters or less	Alarm_summary	
Header 1	64 characters or less	–	
Header 2	64 characters or less	–	
Send alarm action	On+Off/On	On+Off	
Include tag/ch in Subject	On/Off	Off	

Communication (Ethernet) > E-Mail > Scheduled settings

Setup Item	Selectable Range or Selections	Default Value	Setting
Recipient 1	On/Off	Off	
Interval	1h/2h/3h/4h/6h/8h/12h/24h	24h	
Ref.time	00:00 to 23:59	00:00	
Recipient 2	On/Off	Off	
Interval	1h/2h/3h/4h/6h/8h/12h/24h	24h	
Ref.time	00:00 to 23:59	00:00	
Include INST	On/Off	Off	
Include source URL	On/Off	Off	
Subject	32 characters or less	Periodic_data	
Header 1	64 characters or less	–	
Header 2	64 characters or less	–	

Setup Items and Default Values

Communication (Ethernet) > E-Mail > System settings

Setup Item	Selectable Range or Selections	Default Value	Setting
Recipient 1	On/Off	Off	
Recipient 2	On/Off	Off	
Include source URL	On/Off	Off	
Subject	32 characters or less	System_warning	
Header 1	64 characters or less	–	
Header 2	64 characters or less	–	

Communication (Ethernet) > E-Mail > Report settings

Setup Item	Selectable Range or Selections	Default Value	Setting
Recipient 1	On/Off	Off	
Recipient 2	On/Off	Off	
Include source URL	On/Off	Off	
Subject	32 characters or less	Report_data	
Header 1	64 characters or less	–	
Header 2	64 characters or less	–	

Communication (Ethernet) > FTP client > FTP transfer file

Setup Item	Selectable Range or Selections	Default Value	Setting
Without /AS1			
FTP transfer file > Disp&Event data	On/Off	Off	
FTP transfer file > Report	On/Off	Off	
FTP transfer file > Snapshot	On/Off	Off	
Transfer wait time > Disp&Event data	0 to 120 min	0	
Transfer wait time > Report	0 to 120 min	0	
With /AS1			
FTP transfer file > Disp&Event data	On/Off	Off	
FTP transfer file > Report	On/Off	Off	
FTP transfer file > Snapshot	On/Off	Off	
FTP transfer file > Setting	On/Off	Off	

The Transfer wait time items are the same as on a DX without the /AS1 option.

Communication (Ethernet) > FTP client > FTP connection

Setup Item	Selectable Range or Selections	Default Value	Setting
FTP connection	Primary/Secondary	Primary	
FTP server name	64 characters or less	–	
Port number	0 to 65535	21	
Login name	32 characters or less	–	
Password	32 characters or less	***** ... ***	
Account	32 characters or less	–	
PASV mode	On/Off	Off	
Initial path	64 characters or less	–	

Communication (Ethernet) > SNTP client

Setup Item	Selectable Range or Selections	Default Value	Setting
SNTP client > Use/Not	Use/Not	Not	
SNTP client > Server name	64 characters or less	–	
SNTP client > Port number	0 to 65535	123	
SNTP client > Access interval	Off/1h/8h/12h/24h	8h	
SNTP client > Access reference time	00:00 to 23:59	00:00	
SNTP client > Access timeout	10s/30s/90s	30s	
SNTP client > Time adjust on Start action	On/Off	Off	

Communication (Ethernet) > Modbus client > Basic settings

Setup Item	Selectable Range or Selections	Default Value	Setting
Basic settings > Read cycle	125ms/250ms/500ms/1s/2s/5s/10s	1s	
Basic settings > Retry interval	Off/10s/20s/30s/1min/2min/5min/10min/ 20min/30min/1h	2min	

Communication (Ethernet) > Modbus client > Modbus server settings

Setup Item	Selectable Range or Selections	Default Value	Setting
Server number	1-8/9-16	1-8	
Port	0 to 65535	502	
Modbus server name	64 characters or less	–	
Unit	Auto/Fixed	Auto	
No.	0 to 255	1	

Communication (Ethernet) > Modbus client > Command settings

Setup Item	Selectable Range or Selections	Default Value	Setting
Client command number	1-8/9-16	1-8	
1 to 16	Off/R/R-M/W/W-M/E-M	Off	
First	Depends on the command type.	–	
Last	Depends on the command type.	–	
Server	1/2/3/.../15/16	1	
Regi.	Numerical value	30001	
Type	INT16/UINT16/INT32_B/INT32_L/UINT32_B/ UINT32_L/FLOAT_B/FLOAT_L	INT16	

Communication (Ethernet) > Modbus client > Auto settings

Automatically assigns MW100s to the DX.

Communication (Ethernet) > Password management > KDC connection (/AS1 option)

Setup Item	Selectable Range or Selections	Default Value	Setting
KDC connection	Primary/Secondary	Primary	
KDC server name	64 characters or less	–	
Port number	0 to 65535	88	

Communication (Ethernet) > Password management > Certification key (/AS1 option)

Setup Item	Selectable Range or Selections	Default Value	Setting
Host principal	20 characters or less	–	
Realm name	64 characters or less	–	
Password	20 characters or less	–	
Encryption	AES128/AES256/ARC4	AES128	

Setup Items and Default Values

Communication (Serial) > Basic settings

Setup Item	Selectable Range or Selections	Default Value	Setting
Without /AS1			
Baud rate	1200/2400/4800/9600/19200/38400	9600	
Data length	7/8	8	
Parity	Odd/Even/None	Even	
Handshaking	Off:Off/XON:XON/XON:RS/CS:RS	Off:Off	
Address	1 to 99	1	
Protocol	Normal/Modbus/Modbus-M	Normal	
With /AS1			
The baud rate, data length, parity, handshaking, address items are the same as on a DX without the /AS1 option.			
Protocol	Normal/Modbus/Modbus-M/Barcode	Normal	

Communication (Serial) > Modbus master > Basic settings

Setup Item	Selectable Range or Selections	Default Value	Setting
Read cycle	125ms/250ms/500ms/1s/2s/5s/10s	1s	
Timeout	125ms/250ms/500ms/1s/2s/5s/10s/1min	1s	
Retrials	Off/1/2/3/4/5/10/20	1	
Inter-block delay	Off/5ms/10ms/15ms/45ms/100ms	Off	
Auto recovery	Off/1min/2min/5min/10min/20min/30min/1h	2min	

Communication (Serial) > Modbus master > Command settings

Setup Item	Selectable Range or Selections	Default Value	Setting
Master command number	1-8/9-16	1-8	
1 to 16	Off/R/R-M/W/W-M/E-M	Off	
First	Depends on the command type.	–	
Last	Depends on the command type.	–	
Addr.	1 to 247	1	
Regi.	Numerical value	30001	
Type	INT16/UINT16/INT32_B/INT32_L/UINT32_B/ UINT32_L/FLOAT_B/FLOAT_L	INT16	

Communication (PROFIBUS-DP)

Setup Item	Selectable Range or Selections	Default Value	Setting
Node Address	0 to 125	3	

Status relay

Setup Item	Selectable Range or Selections	Default Value	Setting
Without /AS1			
Fail relay	Fail/Status relay	Fail	
Status relay	Fail/Status relay	Status relay	
With /AS1			
Fail relay	Fail/Status relay/Mem. sample/Invalid user/Login	Fail	
Status relay	Fail/Status relay/Mem. sample/Invalid user/Login	Status relay	

Status Relay > Status Relay Details

Setup Item	Selectable Range or Selections	Default Value	Setting
Memory/Media status	On/Off	Off	
Measurement error	On/Off	Off	
Communication error	On/Off	Off	
Memory stop	On/Off	Off	
Alarm	On/Off	Off	

Set Calibration

Setup Item	Selectable Range or Selections	Default Value	Setting
Use/Not	Use/Not	Not	
Notification	1 to 10	1	
Renotification	10min/30min/1h/8h/24h	1h	

End

Setup Item	Selectable Range or Selections	Default Value	Setting
Do you want to store and make the new settings take effect?	Yes/No/Cancel	–	

File/Initialize tab

Load settings

Setup Item	Selectable Range or Selections	Default Value	Setting
Without /AS1			
Load settings > Kind	CF/USB	CF	
Initialize > Kind	Clear 1/Clear 2/Clear 3	Clear 3	
Media eject	CF/USB	-	
Touch panel calibration	Execute/Check	-	
With /AS1			
Load settings > All settings > Kind	CF/USB	CF	
Load settings > Login info only > Kind	CF/USB	CF	
Load settings > Other settings > Kind	CF/USB	CF	
Initialize > Kind	Clear 1/Clear 2/Clear 3/Clear 4	Clear 3	
Media eject	CF/USB	-	
Touch panel calibration	Execute/Check	-	

End

Setup Item	Selectable Range or Selections	Default Value	Setting
Do you want to store and make the new settings take effect?	Yes/No/Cancel	-	

List of Operator Menu Items

The operator menu is a shortcut to the items in the operation screen menu and the FUNC key menu.

There are limits on the functionality of the operator menu. For example, you may not be able to use some features due to user authority or in situations where there is no data. You cannot tap the buttons that correspond to features that are disabled (the text on the buttons is displayed in gray).

- For details on user limitations and operations when you are not logged in, see IM 04L42B01-01EN.

Operation screen	Description
Operator menu	
Trend	
Message	Writes a message
Free message	Writes a free message
Trend history	Displays the historical trend
AlarmACK	Performs alarm acknowledgment
Home	Displays the specified standard display
Operation screen menu	Displays the Operation screen menu
FUNC key menu	Displays the FUNC key menu
Trend history (*1)	
Data search	Displays the calendar
All data display	Shows the all data display
Information	Displays the information menu that is used to switch to the alarm summary, message summary, information, and operation log (/AS1)(*3) for the historical trend
Exit history	Exits the historical trend display
Add message	Writes an additional message
Add free message	Writes an additional free message
Sign record (*2)	Displays the sign record menu (/AS1)
AlarmACK	Performs alarm acknowledgment
Operation screen menu	Displays the Operation screen menu
FUNC key menu	Displays the FUNC key menu
Overview	
AlarmACK	Performs alarm acknowledgment
Alarm DispRST (*4)	Resets the alarm display
Individ. AlarmACK (*5)	Displays the individual alarm acknowledgment menu
Jump to alm sum	Displays the alarm summary
Jump to trend	Displays the trend of the specified channel
Home	Displays the specified standard display
Operation screen menu	Displays the Operation screen menu
FUNC key menu	Displays the FUNC key menu

*1 When the historical data is invalid and no waveforms are displayed, the following three items are displayed on the operator menu.

Exit history, operation screen menu, and FUNC key menu

*2 Sign record is displayed under the following conditions.

(1) The DX has the /AS1 option, (2) the DX has the sign record feature, (3) a user has logged in using keys, and (4) the internal memory's historical data is being read.

*3 The information menu's operation log is only displayed on DXs with the /AS1 advanced security option.

*4 Alarm DispRST is displayed under the following conditions.

(1) Annunciator mode is turned on and (2) the alarm sequence is ISA-M.

*5 Individ. AlarmACK is displayed under the following conditions.

(1) The DX has the /AS1 advanced security option, (2) annunciator mode is turned off, (3) the alarm indication behavior is set to Hold, and (4) the relay output status that is enabled after the alarm ACK operation is set to Reset.

List of Operator Menu Items

Operation screen	Description
Operator menu	
Alarm summary	
AlarmACK	Performs alarm acknowledgment
History (DISP) (*6)	Displays the historical trend (display data) including the selected item
History (EVENT) (*6)	Displays the historical trend (event data) including the selected item
To history (*7)	Displays the historical trend including the selected item
Information (*8)	Displays the information menu that is used to switch to the alarm summary, message summary, information, and operation log (/AS1)(*3) for the historical trend
Exit history (*8)	Exits the historical trend display
Home	Displays the specified standard display
Operation screen menu	Displays the Operation screen menu
FUNC key menu	Displays the FUNC key menu
Message summary	
Time or username	Switches between displaying the time and the user name
History (DISP) (*6)	Displays the historical trend (display data) including the selected item
History (EVENT) (*6)	Displays the historical trend (event data) including the selected item
To history (*7)	Displays the historical trend including the selected item
Information (*8)	Displays the information menu that is used to switch to the alarm summary, message summary, information, and operation log (/AS1)(*3) for the historical trend
Exit history (*8)	Exits the historical trend display
AlarmACK	Performs alarm acknowledgment
Home	Displays the specified standard display
Operation screen menu	Displays the Operation screen menu
FUNC key menu	Displays the FUNC key menu
Memory summary	
To history (*9)	Displays the historical trend of the specified data
Select save	Saves the specified data
All save	Saves all data
M.sample save (*10)	Saves the manual sampled data
Report save (*10)	Saves the report data
Time or filename	Switches between displaying the time and the file name
Save mode (*9)	Switches to save mode
AlarmACK (*9)	Performs alarm acknowledgment
Home (*9)	Displays the specified standard display
Exit (*10)	Exits save mode
Media eject	Ejects media
Operation screen menu	Displays the Operation screen menu
FUNC key menu	Displays the FUNC key menu
Custom display	
Message	Writes a message
Free message	Writes a free message
AlarmACK	Performs alarm acknowledgment
Trend history	Displays the historical trend
Home	Displays the specified standard display
Operation screen menu	Displays the Operation screen menu
FUNC key menu	Displays the FUNC key menu

*6 This is displayed when both display data and event data have been recorded.

*7 This is displayed when display data or event data has been recorded.

*8 This is displayed when the alarm summary or message summary for the historical trend is displayed.

*9 This is not displayed when the memory summary is in save mode.

*10 This is displayed when the memory summary is in save mode.

Operation screen	Description
Operator menu	
Operation log (*11)	
Change contents	Switches the screen contents
Trend history (*12)	Displays the historical trend
Information (*12)	Displays the information menu that is used to switch to the alarm summary, message summary, information, and operation log (/AS1)(*3) for the historical trend
Exit history (*12)	Exits the historical trend display
AlarmACK	Performs alarm acknowledgment
Home (*13)	Displays the specified standard display
Operation screen menu	Displays the Operation screen menu
FUNC key menu	Displays the FUNC key menu
Annunciator	
AlarmACK	Performs alarm acknowledgment
Alarm DisPRST	Resets the alarm display
Home	Displays the specified standard display
Operation screen menu	Displays the Operation screen menu
FUNC key menu	Displays the FUNC key menu
4-panel	
Expand	Expands the selected screen (to fill all the displays)
4-panel 1	Shows 4-panel 1
4-panel 2	Shows 4-panel 2
4-panel 3	Shows 4-panel 3
4-panel 4	Shows 4-panel 4
AlarmACK	Performs alarm acknowledgment
Home	Displays the specified standard display
Operation screen menu	Displays the Operation screen menu
FUNC key menu	Displays the FUNC key menu
Multi batch overview	
Batch view	Switches to batch mode
AlarmACK	Performs alarm acknowledgment
Home	Displays the specified standard display
Operation screen menu	Displays the Operation screen menu
FUNC key menu	Displays the FUNC key menu
Other screens (*13)	
AlarmACK	Performs alarm acknowledgment
Home	Displays the specified standard display
Operation screen menu	Displays the Operation screen menu
FUNC key menu	Displays the FUNC key menu

*11 This only appears on DXs with the /AS1 advanced security option.

*12 This is the operation log menu for the historical trend.

*13 The digital, bar graph, report data, various log (excluding the operation log), Modbus status (RTU/TCP), relay status, 1/4 simplified historical trend, text field, network information, system information, stacked bar graph, and event switch display screens.