

SAFETY INSTRUCTIONS

Ex/I.S. installation:

- For correct use and installation the manufacturer's manual must be followed. When programming the Transmitter by PC and communication interface or a HART® terminal the intrinsically safe data shall be observed.
- The designation galvanic isolation between the transducer input and the loop supply indicates signal isolation only. It shall not be interpreted as an Intrinsically Safe galvanic isolation like an isolating barrier. Therefore ordinary care in selecting barrier and grounding shall be considered.
- The apparatus must be installed in an enclosure with an Ingress Protection of at least IP 20.
- The terminals 1 and 2 of the equipment have to be electrically connected to a linear barrier located in the non hazardous area.
- For Ex/I.S. data, see chapter 7. Approvals Options.

The YTA70 is a head mount type of temperature transmitter that accepts thermocouple or RTD input and converts it to a 4 to 20 mA DC signal for transmission. The YTA70 specifies HART communication protocol for remote configuration.

It is imperative that users observe the instructions in this manual to ensure the protection and safety of operators.

1. Model and Suffix Codes

Model	Suffix code	Descriptions
YTA70	Temperature Transmitter
Output Signal	-E	4 to 20mA DC with digital communication (HART protocol)
Optional Specifications	/KS2	CENELEC ATEX (KEMA) intrinsically safe approval
	/DS2	FM intrinsically safe/Nonincendive and CENELEC ATEX (KEMA) intrinsically safe approval combination
	/SS2	IECEX intrinsically safe, FM intrinsically safe/ Nonincendive, and CENELEC ATEX (KEMA) intrinsically safe approval combination

2. Warranty

The warranty period of the instrument is as of condition shown when purchasing. Any trouble arising during the warranty period shall be replaced at free of charge. The following problems or troubles shall not be eligible of charge-exempt repair.

- Caused by improper usage or storage of the customer which exceeds the specification requirements.
- Caused by mishandling or modification.
- Caused by fire, earthquake or other acts of God that are not directly a result of problems of the instrument.

3. Handling Precautions

- Read this manual thoroughly and carefully before handling the instruments. Observe the instructions.
- Store the product in location that meets the following requirements.
 - No exposure to rain or water
 - No major mechanical vibration or shock
 - Humidity and Temperature limitations
 - Ordinary conditions(25°C, 65%) is preferable.
 Otherwise, as of specified in "Standard Specifications."
- Avoid corrosive atmosphere for storage and installation.
- For safe installation of the transmitter in hazardous area, the following must be observed. The module must only be installed by qualified personnels who are familiar with the national and international laws, directives, and standards that apply to this area.
- Yokogawa will not be liable for malfunctions or damage resulting from any modification made to this instrument by the customer.

4. Standard Specifications

Accuracy (see table below)

Sensor type	Standard	Input ranges		Minimum span		Accuracy (value whichever is greater)
		°C	°F	°C	°F	
<T/C>						
B	IEC584	400 to 1820	752 to 3308	200	360	±0.1% of span or ±1.0°C
E		-100 to 1000	-148 to 1832	50	90	±0.1% of span or ±0.5°C
J		-100 to 1200	-148 to 2192	50	90	
K		-180 to 1372	-292 to 2502	50	90	
N		-180 to 1300	-292 to 2372	100	180	
R		-50 to 1760	-58 to 3200	200	360	±0.1% of span or ±1.0°C
S		-50 to 1760	-58 to 3200	200	360	
T		-200 to 400	-328 to 752	50	90	±0.1% of span or ±0.5°C
L	DIN43710	-100 to 900	-148 to 1652	50	90	
U		-200 to 600	-328 to 1112	75	135	
W3	ASTM	0 to 2300	32 to 4172	200	360	±0.1% of span or ±1.0°C
W5		0 to 2300	32 to 4172	200	360	
<RTD>						
Pt100	IEC751	-200 to 850	-328 to 1562	10	18	±0.1% of span or ±0.1°C
Ni100	DIN43760	-60 to 250	-76 to 482	10	18	±0.1% of span or ±0.2°C
DC Voltage		-800 to 800 [mV]		2.5 [mV]		±0.1% of span or ±0.01mV
Resistance		0 to 7000 [Ω]		25 [Ω]		±0.1% of span or ±0.1Ω

Cold Junction Compensation Accuracy(For T/C only)

±1°C (±1.8°F)

Ambient Temperature Effects (per 10°C Change)

For E, J, K, L, N, T and U thermocouple inputs:
±0.05% of span or ±0.25°C, whichever is greater

For R, S, B, W3 and W5 thermocouple inputs:
±0.05% of span or ±1°C, whichever is greater

For Pt100 and Ni100 RTD inputs:
±0.05% of span or ±0.05°C, whichever is greater

For DC voltage input:
±0.05% of span or ±5µV, whichever is greater

For Resistance(ohm) input:
±0.05% of span or ±0.05Ω, whichever is greater

Power Supply Effects

±0.005% of FS per Volt

RFI Effects

Tested per EN 61326, field intensity up to 10 V/m.

EMC Conformity

EN 61326

Maximum Zero Offset

±50% of the maximum temperature

Input Signal Source Resistance (for T/C input)

10 MΩ, or 3 kΩ at power-off

Input Lead Wire Resistance (for RTD input)

5 Ω per wire or lower

Burnout

High(NAMUR NE43 upscale), Low(NAMUR NE43 downscale) or value within 3.5 to 20 mA

Output

Two wire 4 to 20 mA DC

Response Time

1 to 60 sec programmable

Ambient Temperature Limits (Option code may affect limit)

-40 to 85°C (-40 to 185°F)

Ambient Humidity Limits

5 to 90% RH at 40°C (104°F)

Supply Voltage

8 to 35 V DC
8 to 30 V DC for Intrinsically safe type
13.8 to 35 V DC for digital communication

Load Resistance

Limitation: 0 to (E-8)/0.0236 [Ω], where E is power supply voltage.

Isolation

Input/output isolated to 1500 V AC.

Mounting

DIN form B head mounting

Terminals

M3 screws

Weight

50 g (0.11 lb)

5. Block Diagram

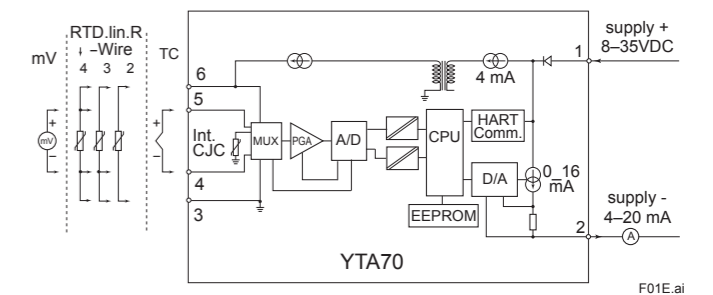

6. Wiring

See wiring diagram. For output signal, use twisted pair or cables with performance equivalent to 600V vinyl insulate cable. For wiring in high or low temperature, use a wire or cable suitable for such temperature. Use cables and wires which meet atmospheric conditions. Take necessary measure to avoid corrosion or damage of cables and wires.



When mounting on a sensor head, do not overtighten the screws.

Wiring Diagram

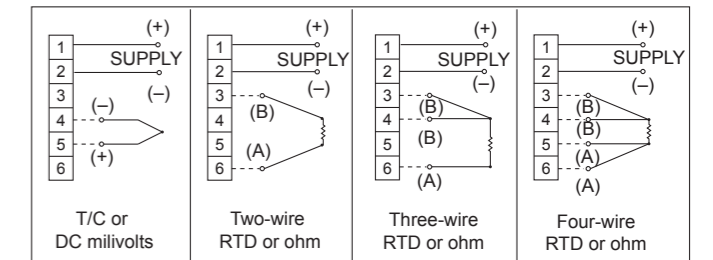

Dimensions

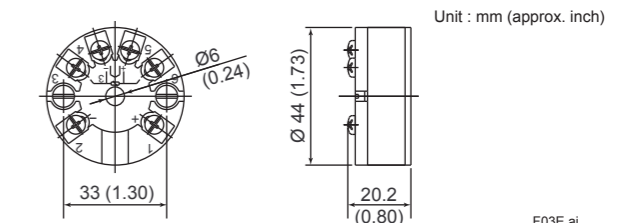

7. Approvals Options

7.1 CENELEC ATEX (KEMA) Intrinsically safe model (/KS2, /DS2, /SS2)

ATEX Certificate: KEMA 10 ATEX0027

Applicable Standard: EN 60079-0: 2006, EN 60079-11: 2007, EN 60079-26: 2007, EN 61241-0: 2006, EN 61241-11: 2006

[Installation diagram]

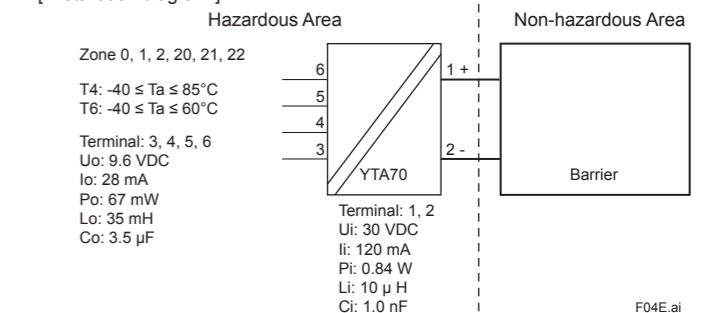

Maximum Ambient Temperature for gas-proof

For T4: 85°C, For T6: 60°C

Maximum Surface Temperature for dust-proof

For T4: T105°C (Ambient Temperature: -40 to 85°C)
For T6: T85°C (Ambient Temperature: -40 to 60°C)

7.2 FM Intrinsically safe/Nonincendive model (/DS2, /SS2)

Applicable Standard: FM 3600, FM 3610, FM 3611, FM 3810

Installation diagram

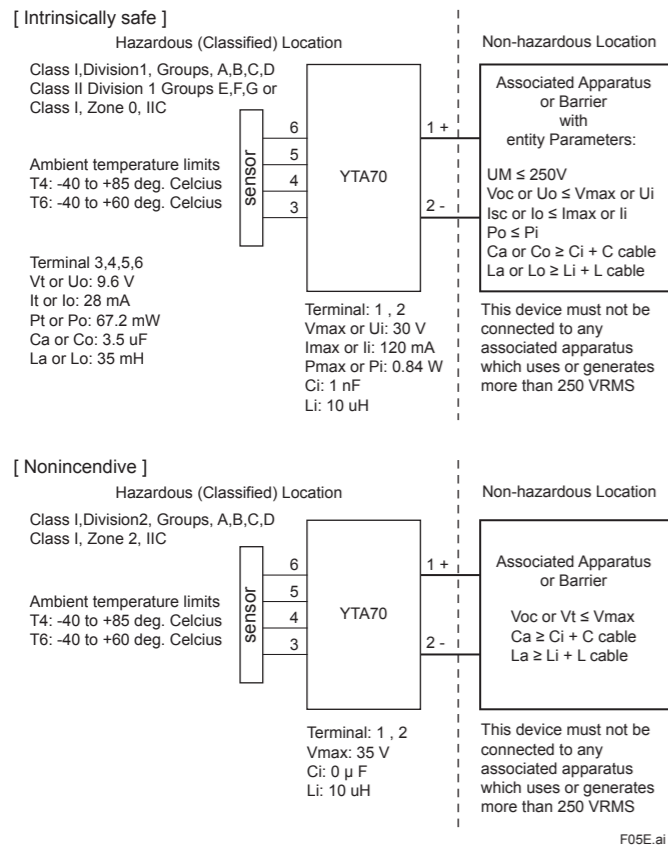

8. HART Communication

8.1 Connection and Requirements

A standard HART communicator can be used for programming the YTA70. The HART communicator must be loaded with the appropriate DDL driver for YTA70.

Minimum loop resistance is 250Ω. If the receiving equipment has a lower resistance, a serial resistor must be inserted to communicate with the HART communicator.

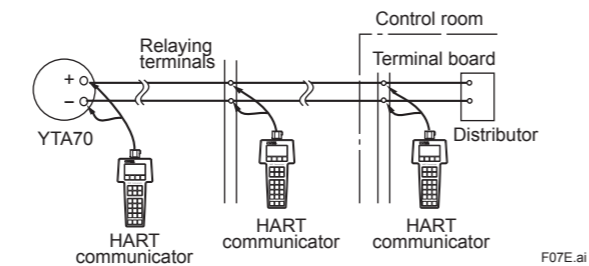

Connection

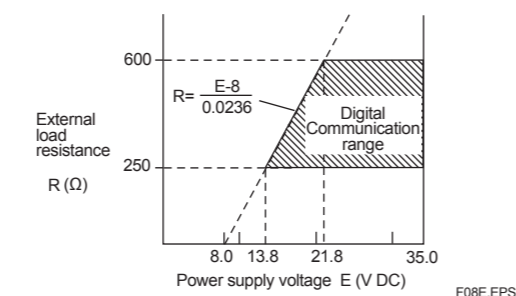

Communication requirement

8.2 Parameters

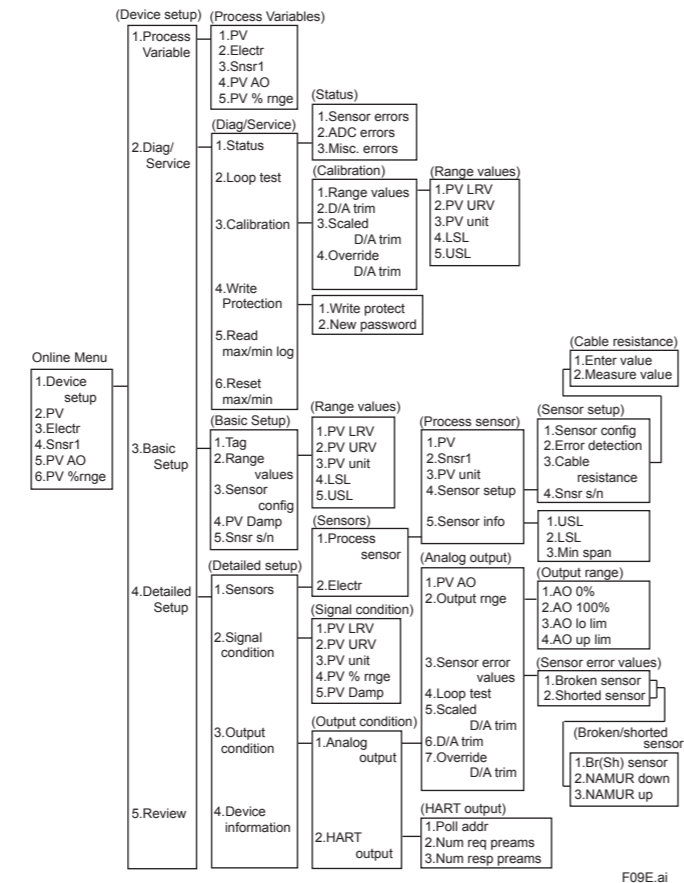

Parameters List

Item	HART Communicator	Selection/Setting Range	Initial Setting	
Process Variable	Process Variable	PV	Measured variables in engineering unit.	
		Electr	Terminal temperature	
	Output value	PV AO	Output value in mA	
		PV % mge	Output value with respect to the range in %	
	PV Log	Read max/min log	Reads the maximum/minimum PV stored in the memory	
	Reset max/min	Clears the PV maximum/minimum log and restart logging		
Signal Condition	Range value	PV LRV/PV URV	Lower/upper range value to defines the 0%/100% value of the measurement	
		LSL/USSL	Shows the max./min. usable value for upper/lower range value	
	Unit	PV unit	Engineering unit to be displayed with such digital value as PV, URV, LRV, USSL, LSL, min.span, etc.	
	Damping	PV Damp	Damping time constant in seconds applied to the digital value. 0 to 62.5(s)	
Sensor Setup	Sensor config	Sensor type (wire, unit)	Sensor type and related settings. [When T/C or millivolts is selected] Always select "single" for a measurement type. [When RTD or ohm is selected] Always select 2-, 3- or 4-wire but others for the number of sensor wires.	
		RTD factor	For RTD only. Leave it to "1."	
		Cold Junction Compensation	For T/C only. Always leave it to "1.internal sensor."	
	Sensor Errors	Error detection	Type of sensor errors to be detected for burnout operation. (1)No test performed, (2)broken sensor, (3)shorted sensor*3, or (4)broken & shorted*3	
	Cable resistance	Enter value	Enter new value of the RTD/ohm cable resistance for compensation.	
		Measure value	Actually measure the cable resistance of 2-wire RTD/ohm for compensation.	
		Minimum span limit	Minimum settable span	
	Output Condition	Analog Output range	AO 0%(100%)	Output value for 0%(100%) in mA.
			AO lo(up) lim	Output lower(upper) limit in mA. NAMUR, or 3.8 to 23mA
			Sensor Error values	Enter or select the output value when sensor error is detected. NAMUR upscale, NAMUR downscale, or value within 3.5 to 23mA
		Loop test	Change the output manually for testing the loop. 4mA, 20mA, or value within 3.5 to 23mA	
Diagnostics		Error status	Sensor errors	Show error status related to a sensor. When any one of the errors turns "ON", check the sensor and wiring.
		ADC errors	Show error status related to analog to digital conversion. When any one of the errors turns "ON", Repower the device. If error remains, replace the device.	
		Misc. errors	Show error status related to a device. When any one of the errors turns "ON", Re-power the device. If error remains, replace the device.	

Item	HART Communicator	Selection/Setting Range	Initial Setting
Calibration	Write protection	Write protect	Write-protects the device, if correct password is entered. *2
		New password	Sets a new password for write protection, if correct password is entered.
	Apply trim	D/A trim	Allows the calibration of a selected analog output with an external reference at the operating endpoint.
		Scaled D/A trim	Allows the calibration of the analog output with the external reference which is scaled at 0 to 100%.
	Clear trim	Override D/A trim	Overrides any previous D/A trimming by restoring factory calibration values.
Device information	Manufacturer	Manufacturer identification code	Yokogawa
	Model	Model name	YTA70-E
	TAG	Tag number, up to 8 alphanumerical characters.	—
	Descriptor	Text which can be used by user in any way. Up to 16 alpha-numerical characters	—
	Message	Text which can be used by user in any way. Up to 32 alpha-numerical characters	—
	Date	Date information. MM/DD/YY. Not implemented. The date is updated whenever changing configuration via PC configurator.	Factory calibration date
	Write protect	Indicates whether the device is write-protected.	Not protected
	Snsr s/n	Not used.	0
	Final assembly number	Not used.	0
	Distributor	—	Yokogawa
Review	Revision #s	Software/hardware revision number	—
	Status	Error status (see "Error status" in this table.)	—
	Input info	List of input variables	—
	Output info	List of output variables	—
	Device information	See "Device information" in this table.	—

*1: Or as specified upon ordering.

*2: The initial setting of password upon shipment is "*****".

*3: With T/C or millivolts for sensor type, the alarm is generated when the input signal drops down below 2.5 mV.

Revision Record

Manual No. : IM 01C50C03-01EN

Title : YTA70 Temperature Transmitter

Edition	Date	Page	Revised item
1st	Mar. 1999	—	New Publication.
2nd	June 1999	1, 6, 10	Add code "/DS1" in the table Add "7.2 FM intrinsically safe model" Add "note 2".
3rd	Feb. 2000	2, 3, 4, 9, 11	Revise accuracy & temperature effect. Correct "Isolation". Add explanation Add "Note".
4th	Mar. 2002	1, 2	Change Optional code KS1 and DS1 to KS2 and DS2 respectively. Add description(4) based on ATEX directives.
5th	July 2003	1, 5, 6	Delete code "KS1" and "/DS1".
6th	Feb. 2007	2, 3, 6	Add handling precaution. Change specifications of FM Intrinsically safe model.
7th	July 2011		Change marking for KS2 and DS2. Change Certificate number and applicable standard. Change electrical data. Add 7.3 IECEx scheme approval.