User's Manual

Model PH72 Personal pH/ORP Meter

IM 12B03D02-01E

Preface

Thank you for purchasing the Model PH72 Personal pH/ORP Meter. Please read this manual thoroughly before using the meter.

The related documents (User's Manual) are as follows.

IM 12B03D02-01E Model PH72 Personal pH/ORP Meter (this manual)
 IM 12B03D02-02E Model PH72 Personal pH/ORP Meter Quick Manual

* the "E" in the document number is the language code.

The following symbol marks are used for safety precautions in this manual.



WARNING

: Indicates that serious injury may result, if the user fails to follow instructions.



CAUTION

: Indicates that minor injury to personnel, or damage to the equipment, may result if the user fails to follow instructions.



WARNING

Do NOT use this instrument where there is a possibility of electrical shock.

Do NOT touch any part of the electrode immediately after using in very hot liquids — otherwise, you may get burned.



CAUTION

Do not apply physical shock or excessive force to the glass sensor, or it may break.

If the meter will not be used for an extended period of time, be sure to remove the batteries. Otherwise battery leakage may occur, causing damage to or malfunction of the meter.

The contents of this manual are subject to change without prior notice.

Yokogawa Electric Corporation assumes no liability for damage, defects, or loss of the product caused by any of the following:

- Misuse by the user;
- Inappropriate or out-of-specifications use of the product;
- Use in an unsuitable environment;
- Repair or modification of this or related products by persons other than Yokogawa-authorized engineers.

Liquid Crystal Display (LCD) Characters

On the LCD alphanumeric characters are displayed as follows.

Alphabet	Display	Alphabet	Display	Numerals	Display
A	<i>A</i>	N	<i>n</i>	0	<i>0</i>
B	<i>b</i>	O	<i>o</i>	1	<i>1</i>
C	<i>C</i>	P	<i>P</i>	2	<i>2</i>
D	<i>d</i>	Q	<i>q</i>	3	<i>3</i>
E	<i>E</i>	R	<i>r</i>	4	<i>4</i>
F	<i>F</i>	S	<i>S</i>	5	<i>5</i>
G	<i>G</i>	T	<i>t</i>	6	<i>6</i>
H	<i>H</i>	U	<i>U</i>	7	<i>7</i>
I	<i>I</i>	V	<i>V</i>	8	<i>8</i>
J	<i>J</i>	W	<i>W</i>	9	<i>9</i>
K	<i>K</i>	X			
L	<i>L</i>	Y	<i>y</i>		
M	<i>M</i>	Z	<i>Z</i>		

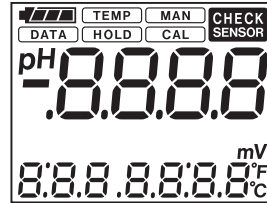

All display segments

F00.ai

Note Regarding Panels Shown in this Manual:

Panels shown in this manual should be regarded as examples. Actual panel format may vary depending on parameter settings and on type of connected sensor.

Flashing Displays

Flashing messages, numbers and digits on the display are indicated in gray in this manual.

Flashing state: *10.0*

Lit state: 10.0

■ Warranty and Service

Yokogawa products and parts are guaranteed to be free from defects in workmanship and materials under normal use and service for a period of (typically) 12 months from the date of shipment from the manufacturer.

Individual sales units may offer different warranty periods, so the original purchase order should be consulted for the conditions of sale. Damage caused by normal wear and tear, inadequate maintenance, corrosion, or due to chemical processes, is excluded from this warranty coverage. In addition, performance deterioration of the sensor caused by the operating environment mentioned above is not considered to be a defect. Yokogawa cannot carry out repairs in such a case so please replace the sensor.

In the event of a warranty claim, any items that are considered to be defective should be sent (freight paid) for repair or replacement (at Yokogawa discretion) to the service department of the relevant sales unit. The following information must be included in a letter accompanying the returned items:

- Model code and serial number

- Copy of original purchase order showing the date

- Length of time used, and the measuring environment

- Fault symptoms, and circumstances of failure

- Statement whether service under warranty or out-of-warranty service is requested

- Complete shipping and billing instructions for return of goods, plus the name and phone number of a contact person who can be reached for further information

Goods that have been in contact with process fluids must be decontaminated / disinfected before shipment, and a statement to this effect should be included. Safety data sheets for all process components that the goods have exposed to should also be included.

■ Batteries and Waste batteries

(Only valid in the EU for EU Battery Directive/Regulation and in the UK for UK Battery Regulation)

Batteries are included in this product. This marking indicates they shall be sorted out and collected as ordained in the EU battery Directive/Regulation and UK battery Regulation.

When you need to replace batteries, contact your local Yokogawa office in the EEA and/or UK respectively.



■ Waste Electrical and Electronic Equipment (WEEE)

(Only valid in the EU for EU WEEE Directive and in the UK for UK WEEE Regulation)

This product complies with the WEEE marking requirement. This marking indicates that you must not discard this electrical/electronic product in domestic household waste. When disposing of products in the EEA and UK, contact your local Yokogawa office in the EEA and/or UK respectively.



■ Authorised Representative in EEA

The Authorised Representative for this product in EEA is Yokogawa Europe B.V. (Euroweg 2, 3825 HD Amersfoort, The Netherlands).

■ Importer for This Product into the Great Britain Market

In relation to UKCA marking, the importer for this product into the Great Britain market via the YOKOGAWA sales channel is:

Yokogawa United Kingdom Limited
Stuart Road Manor Park Runcorn, WA7 1TR, United Kingdom

■ UKCA marking compliant



CONTENTS

Preface	i
1. Outline	1-1
1.1 Features	1-1
1.2 Specifications	1-2
1.3 When You Receive the PH72 Meter Package	1-4
1.4 PH72 Meter Kit	1-5
1.5 PH72 Meter — Part Names and Functions	1-6
1.6 Sensors — Types, Part Names and Functions	1-6
1.7 Spare Parts	1-8
2. Preparation	2-1
2.1 Installing the Batteries	2-1
2.2 Connecting the Sensor Cable	2-2
2.3 Setting the Date and Time	2-2
2.4 Selecting pH or ORP Measurement	2-3
2.5 Wetting Cap	2-4
2.6 Manual Temperature Setting	2-4
2.7 pH Calibration	2-4
3. Measurement	3-1
3.1 Precautions	3-1
3.2 Measurement Procedures	3-2
3.3 Measurement Display Panel	3-3
3.4 Saving a Measured Value	3-3
4. Calibration	4-1
4.1 Automatic Calibration	4-2
4.2 Manual Calibration	4-4
5. Keypad and Display Functions	5-1
5.1 Keypad Functions	5-1
5.2 Display Items	5-2
5.3 Function Mode	5-4
6. Maintenance	6-1
6.1 For Optimum Meter Performance	6-1
6.2 pH Electrode Cleaning	6-1
6.3 Sensor Replacement	6-3
6.4 Rehydrating the Glass Electrode	6-3
6.5 Point to note when performing calibration or measurement	6-3
6.6 Replenishing the Electrode with Filling Solution (KCl solution)	6-4
6.7 Cleaning and Drying Connectors	6-5
6.8 Storage and O-ring/Gasket Replacement	6-6
7. Troubleshooting	7-1
7.1 Causes of Abnormal Readings and Errors	7-1
7.2 Error Messages, Possible Causes, and Corrective Actions	7-2
7.3 Causes of Abnormal Measured Values	7-5
7.4 Other Conditions	7-5
8. ORP Meter	8-1
8.1 ORP Measurement	8-1
8.2 Maintenance of ORP Sensors	8-2
8.3 Checking the ORP Sensor	8-2
9. Technical Information	9-1
9.1 Measurement Principle of pH Meter (Glass Electrode Method)	9-1
9.2 Relationship between EMF of Glass Membrane and pH Value	9-2
9.3 Temperature Compensation	9-4
9.4 The Asymmetry Potential	9-5

Contents

9.5 The Alkaline Error.....	9-5
9.6 The Acid Error.....	9-7
9.7 Calibration Calculation.....	9-7
9.8 ORP (Oxidation-Reduction Potential).....	9-8
9.9 Reference Electrode.....	9-9
9.10 Wetted Part Materials of Sensors.....	9-11
9.11 References.....	9-12
Appendix.....	App-1
Revision Record.....	i

1. Outline

The Model PH72 Personal pH/ORP Meter is a highly accurate, portable pH meter for laboratory and field application. With its self-diagnostic function, the PH72 provides precise measurement of pH and ORP (oxidation-reduction potential). Measurement results can be stored and stored data can be checked on the meter display any time. The PH72 meter is of waterproof construction so that it can safely be used outdoors on a rainy day, and can also withstand being accidentally dropped into water. With its waterproof construction, the PH72 can be used outdoors in any weather and will not be damaged if it accidentally falls into water (tap water, etc.). However, since the PH72 is not hermetically sealed, do not leave it in water for a long time or pour chemical solutions on it.

1.1 Features

Water resistant case

When this meter is used with its dedicated sensor, it meets the requirements of class IP67 according to “Degree of Protection Provided by Enclosure” in IEC 60529.

Simple calibration

Automatic calibration based on preprogrammed data of standard solutions or manual calibration can be done through simple key operations.

Calendar and clock function

Internal clock functions allow “one-touch checking” of measurement date and time.

Data storage function

Up to 300 measured pH values along with their respective solution temperatures, dates and times, can be stored and stored data can be checked on the display any time.

Auto power off function

The meter will turn off power automatically if not operated during a preset time period. The auto power off time can be user configurable in the range of 1 to 120 minutes in increments of 1 minute. The auto power off function can be disabled, where the meter should be used with care to conserve the batteries.

Alarm clock function

The meter can issue an alarm signal at a specified time. Even when meter power is turned off, the internal clock can issue an alarm signal.

Self-diagnostic function

A relevant error message will appear based on the self-diagnostic function.

Large, clear LCD

A measured pH (mV) value, solution temperature, date and time are clearly viewed on the display.

Compact, lightweight, and handy

The meter fits comfortably your hand and also stands firm on the table.

1. Outline

1.2 Specifications

Measurement:	Hydrogen ion concentration (pH) or oxidation-reduction potential (ORP) of solution
Measuring range:	pH: 0 to 14 pH*1 ORP: -2000 to 2000 mV Temperature: 0 to 80°C*2 (or 0 to 100°C*4)
Resolution:	pH: 0.01 pH ORP: 1 mV (0.1 mV: -199.9 to 199.9 mV) Temperature: 0.1°C
Repeatability (without sensor):	pH: ±0.01 pH ORP: ±1 mV
Accuracy:	Temperature: ±0.7°C (0 to 70°C) ±1°C (above 70°C)
Display:	Digital LCD
Indication:	pH or ORP (mV) and solution temperature (simultaneously), sensor check, various messages *3
Temperature compensation (glass electrode emf — temperature characteristics):	Automatic compensation (or manual compensation*4)
Solution temperature:	0 to 80°C (or 0 to 100°C*4) (0 to 50°C when a KCl replenish-free type sensor and its sensor cable are immersed in water)
Solution conductivity:	50 µS/cm or more *5
Calibration:	Automatic (1 or 2 point), manual
Ambient temperature:	0 to 50°C
Wetted Material:	<ul style="list-style-type: none">●KCl replenish-free type combination pH sensor Polypropylene resin (sensor body, protective cover), Glass (glass electrode, temperature sensor protection tube), Ceramics (liquid junction), Silicon rubber (sensor seal)●KCl refillable type combination pH sensor PVC (cable), rigid polyethylene (grip), ethylene propylene rubber (grip and cable connection), Polypropylene resin (sensor body, protective cover), Glass (glass electrode, temperature sensor protection tube), Ceramics (liquid junction), Silicon rubber (sensor seal)●Needle type pH sensor Glass (sensor body)●Test tube size pH sensor Glass (sensor body)●KCl refillable type ORP sensor Platinum (electrode), Polypropylene resin (sensor body, protective cover), Glass (glass electrode, temperature sensor protection tube), Ceramics (liquid junction), Silicon rubber (sensor seal)
Construction:	Protection class IP67 (IEC 60529)
Dimensions:	Approximately 150(H) x 61(W) x 42(D) mm (not including connector part)
Weight:	Approximately 220 g (without sensor)

1. Outline

Power source:	2x AA batteries (LR6) Auto power off function (time configurable: 1 to 120 minutes)
Battery life:	Approximately 600 hours*6 of continuous use (battery type and operating condition dependent)
Functions:	Data memory (300 points), alarm clock, etc.
EMC Compliance:	
EMI (Emission):	EN 61326-1 Class B

Test Item	Frequency Range	Basic Standard
Electromagnetic radiation disturbance	30 to 1000 MHz	CISPR 16-1 and 16-2

EMS (Immunity): EN 61326-1 Table 2 (For use in industrial locations ¹⁷)

No.	Test Item	Test Specification	Basic Standard	Performance Criteria*
1	Electrostatic discharge	4 kV (contact) 8 kV (air)	IEC 61000-4-2	A
2	RF amplitude modulated electromagnetic field	80 to 1000 MHz, 10 V/m (unmodulated) 80% AM (1 kHz)	IEC 61000-4-3	B**
		1.4 to 2.0 GHz, 10 V/m (unmodulated) 80% AM (1 kHz)		A
		2.0 to 4.0 GHz, 3 V/m (unmodulated) 80% AM (1 kHz)		A

* A: Normal performance within the specification limits: $\pm 20\%$ of the measured value.

B: Temporary degradation or loss of function or performance which is self-recoverable.

**Display value may be affected by strong electromagnetic field.

EMC Regulatory Arrangement in Australia and New Zealand (RCM)

EN 61326-1 Class B, Table2

Korea Electromagnetic Conformity Standard Class B 한국 전자과적합성 기준

B급 기기 (가정용 방송통신기자재)

이 기기는 가정용 (B급) 전자과적합기로서

주로 가정에서 사용하는 것을 목적으로 하며,

모든 지역에서 사용할 수 있습니다.

Morocco/EMC Arrêté: NM EN 61326-1

EAC: TP TC 020/2011

Environmental resistance:

Compliant with RoHS*8, WEEE, and EU battery directive

*1: Display range is from -2 to 16 pH.

*2: Display range is from -10 to 120°C. When a needle type or test tube size pH sensor is used. 0 to 50°C when a KCl replenish-free type sensor and its sensor cable are immersed in water.

*3: When needle type or test tube size pH sensor is connected, liquid temperature can not be measured.

*4: When a needle type or test tube size pH sensor is connected.

*5: Confirm that the solution conductivity is 50 $\mu\text{S}/\text{cm}$ or more.

*6: When alkaline batteries are used.

*7: Display value may be affected by strong electromagnetic field.

*8: RoHS: EN IEC 63000 (Style 2.03 and later)

1.3 When You Receive the PH72 Meter Package

Confirm that you received all package components of the PH72 meter you ordered referring to the Model and Suffix Code and the item list in Section 1.4, "PH72 Meter Kit." Carefully inspect the meter and sensor, referring to Section 1.5, "PH72 Meter — Part Names and Functions" and Section 1.6, "Sensors — Types, Part Names and Functions." Particular attention should be taken:

- Not to lose a wetting cap attached on the sensor tip. This cap is needed for storage
- Not to twist or pull the cable
- Not to hit or drop the meter
- Not to get connectors dirty
- In handling of standard solutions and reagents
Solution bottles should be stored in a cool, dark place and tightly capped after use. Once opened, the contents of a bottle should be used early. Dispose of solutions in accordance with local regulations.

1.4 PH72 Meter Kit

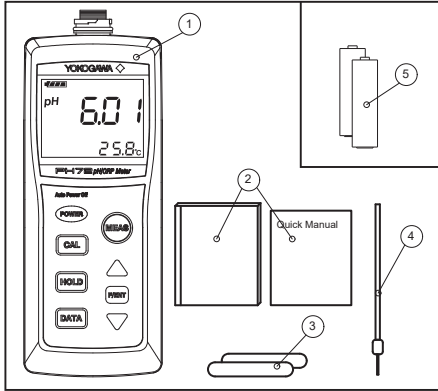

No.	Item
1	Personal pH/ORP meter
2	User's Manual and Quick Manual
3	Non-slip pads (2 pcs)
4	Hand strap
5	Dry batteries, 2x AA batteries
6	KCl replenish-free type pH sensor
7	KCl refillable type pH sensor
8	Needle type pH sensor
9	Test tube size pH sensor
10	KCl refillable type ORP sensor
11	Cotton swabs for sensor cleaning
12	pH 4 standard solution (50 mL)
13	pH 7 standard solution (50 mL)
14	Calibration bottles (2 bottles)
15	3.3 M KCl solution (50 mL)
16	Syringe (5 mL)

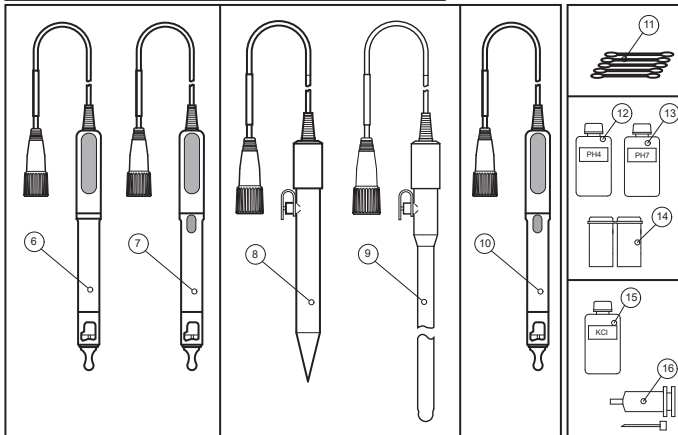

Model	Suffix Code	Specification	Items Included
PH72	-----	Personal pH/ORP meter	1 to 4 in common, plus:
Connecting sensors	-00	Without sensor	None
	-11	With KCl replenish-free type combination pH sensor (cable length: 0.75 m)	6, 11, 12, 13, 14
	-13	With KCl replenish-free type combination pH sensor (cable length: 3 m)	6, 11, 12, 13, 14
	-21	With KCl refillable type combination pH sensor (cable length: 0.75 m)	7, 11, 12, 13, 14, 15, 16
	-23	With KCl refillable type combination pH sensor (cable length: 3 m)	7, 11, 12, 13, 14, 15, 16
	-32	With needle type pH sensor (cable length: 0.75 m)	8, 11, 12, 13, 14, 15, 16
	-33	With test tube size pH sensor (cable length: 0.75 m)	9, 11, 12, 13, 14, 15, 16
	-41	With KCl refillable type ORP sensor (cable length: 0.75 m)	10, 11, 15, 16
	-43	With KCl refillable type ORP sensor (cable length: 3 m)	10, 11, 15, 16
	-51	With KCl refillable type combination pH sensor (cable length: 0.75 m) + KCl refillable type ORP sensor (cable length: 0.75 m)	7, 10, 11, 12, 13, 14, 15, 16
	-60	Meter only, without sensor *1	None
	-61	With KCl refillable type combination pH sensor (cable length: 0.75 m) *1	7, 11, 12, 13, 14, 15, 16
Language	-J	Japanese	
	-E	English	
Country	-AA	Global except South Korea and Malaysia (with batteries)	5
	-NB	South Korea and Malaysia (without batteries) *2	None

*1: PH72-60 and PH72-61 conform to the Japanese Measurement Act. CE marking is not attached.

Its hardware is the same as "PH72-00" or "PH72-21" respectively.

*2: In South Korea and Malaysia, primary battery is limited by regulations.

Prepare batteries with the authorized certification mark for each country.

Note: On the name plate of sensor, Model and Suffix Code of sensor itself (PH72SN-□-AA or OR72SN-□-AA) is indicated. (See Section 1.6.)

1. Outline

1.5 PH72 Meter — Part Names and Functions

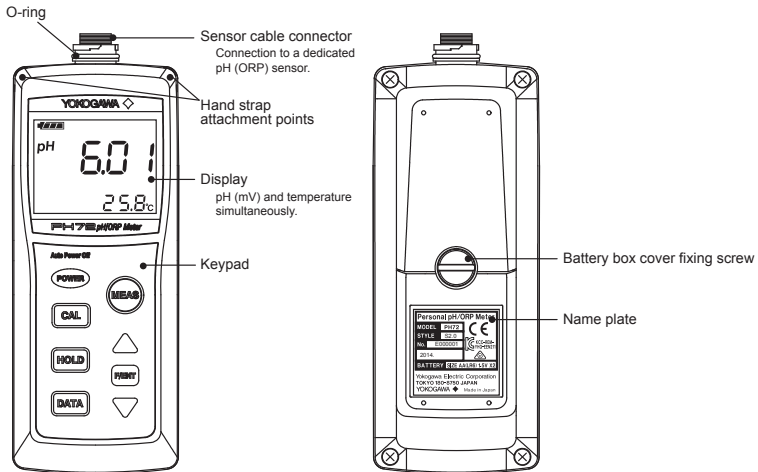

F010501.ai

1.6 Sensors — Types, Part Names and Functions

Sensors available for use with the Model PH71 Personal pH Meter are: general-purpose pH sensors (KCl replenish-free and KCl refillable types), needle type pH sensor, and test tube size pH sensor. Check the Model and Suffix Code on the name plate to identify the type of your sensor.

Example of Name Plate

MODEL	PH72SN	STYLE	S2.0
SUFFIX	-11-AA	NO.	000001
YOKOGAWA		Made in Japan	

Model and Suffix Code for pH and ORP Sensors

Model	Suffix Code	Specification	Remarks*1
PH72SN	-----	pH sensor for Personal pH/ORP meter	
Type	-11	KCl replenish-free type combination pH sensor (cable length: 0.75 m)	
	-13	KCl replenish-free type combination pH sensor (cable length: 3 m)	
	-18	KCl replenish-free type combination pH sensor (cable length: 0.75 m)*2	K9220YA
	-19	KCl replenish-free type combination pH sensor (cable length: 3 m)*2	K9220YB
	-21	KCl refillable type combination pH sensor (cable length: 0.75 m)	
	-23	KCl refillable type combination pH sensor (cable length: 3 m)	
	-28	KCl refillable type combination pH sensor (cable length: 0.75 m)*2	K9220YC
	-32	Needle type pH sensor (cable length: 0.75 m)	
	-33	Test tube size pH sensor (cable length: 0.75 m)	
	-38	Needle type pH sensor (cable length: 0.75 m) *2	K9220YG
	-39	Test tube size pH sensor (cable length: 0.75 m) *2	K9220YJ
	-61	KCl refillable type combination pH sensor (cable length: 0.75 m)	
—	-AA	Always -AA	

Model	Suffix Code	Specification	Remarks*1
OR72SN	-----	ORP sensor for Personal pH/ORP meter	
Type	-41	KCl refillable type ORP sensor (cable length: 0.75 m)	
	-43	KCl refillable type ORP sensor (cable length: 3 m)	
	-48	KCl refillable type ORP sensor (cable length: 0.75 m) *2	K9220YL
	-49	KCl refillable type ORP sensor (cable length: 3 m) *2	
—	-AA	Always -AA	

*1: Part number of PH81, PH82 (previous models).

*2: pH sensor for PH81, PH82 (previous models). Waterproofing is not guaranteed if you use PH82-type sensor in conjunction with PH72 meter.

F010601.ai

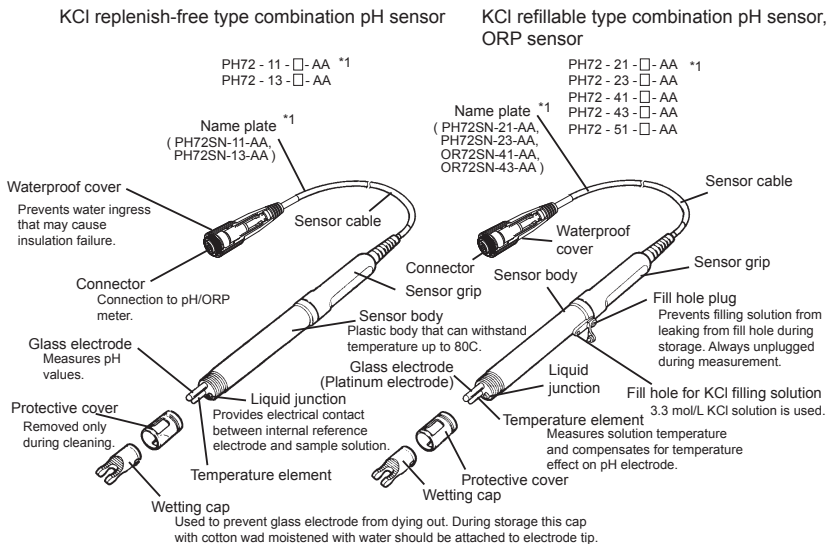





*1: On the name plate of sensor, Model and Suffix Code of sensor itself (PH72SN-□-AA or OR72SN-□-AA) is indicated. (See Section 1.6.)

F010602.ai

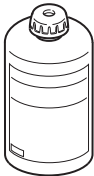
1. Outline

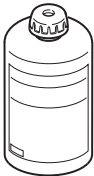
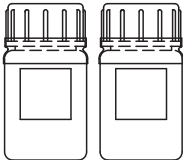
1.7 Spare Parts

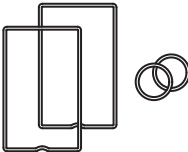
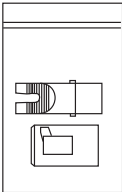
<p>pH 4 Standard solution (Part no. : K9084KF) *</p>  <p>Used for calibration (250 mL).</p>	<p>pH 7 Standard solution (Part no. : K9084KG) *</p>  <p>Used for calibration (250 mL).</p>	<p>pH 9 Standard solution (Part no. : K9084KH) *</p>  <p>Used for calibration (250 mL).</p>
<p>3.3 M KCl solution (Part no. : K9220XH)</p>  <p>Used to replenish KCl refillable type sensor. 3.3 mol/L, 2 bottles x 50 mL</p>	<p>Quinhydrone reagent for ORP Check (Part no. : K9024EC)</p>  <p>Used to check ORP electrode. 3 packs, one pack for 250 mL solution.</p>	<p>Calibration bottle (Part no. : K9220WW)</p>  <p>Used during calibration. 2 x 10-mL bottles.</p>
<p>O-ring and gasket set (Part no. : K9654AY)</p>  <p>2 gaskets for battery box 2 O-rings for connector</p>	<p>Cap set (Part no. : K9220ZY)</p>  <p>Used for sensor. 1 protective cover 1 wetting cap</p>	<p>* Safety data sheet (SDS) https://www.yokogawa.com/library/</p>

F010801.ai

O-rings and gaskets are important parts to ensure that the PH72 meter is water resistant. Replace these parts as required. Refer to Section 6.8, “Storage and O-ring/ Gasket Replacement” for replacement.

2. Preparation

2.1 Installing the Batteries

Install the batteries first.

In South Korea and Malaysia, primary battery is limited by regulations. Please use batteries with the authorized certification mark for each country.



CAUTION

Select a relatively moisture-free location when installing batteries in the meter.

When installing batteries, observe correct polarity (battery orientation). Failure to do so may damage to the meter.

Remove batteries from the meter if it is to be stored for an extended period of time.

Do not leave dead batteries in the meter. They may leak and cause meter failure or erratic operation of the meter.

When replacing batteries, replace both batteries at the same time. If only one battery is replaced, which may leak chemicals and damage the meter.

If the battery box gasket is damaged or dirty then the unit may no longer be waterproof; replace the gasket in this case.

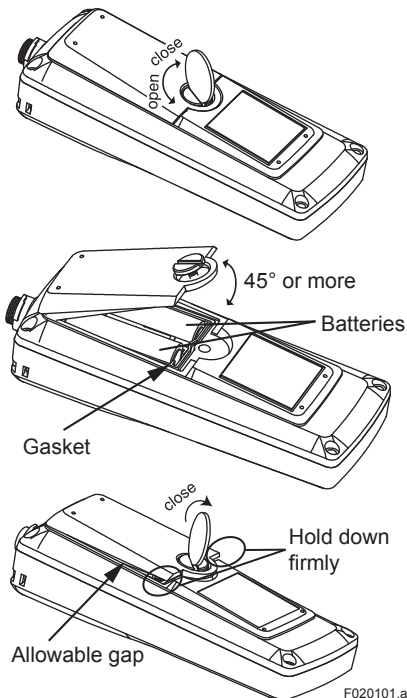

- (1) Loosen the screw holding the battery box cover using a coin or similar object.
- (2) Remove the battery box cover, and then install the batteries observing polarity diagram inside.
- (3) Make sure the gasket on the inside rim of the battery box is free of foreign material.
- (4) Put the cover back on. Insert the tabs on the top of the cover into the slots at an angle of at least 45° and lower the cover into position.
- (5) Hold both sides of the cover down firmly and fasten the screw with a coin or similar object. Tighten the screw in a vertical direction. The head of the screw does not align with the cover. If you feel resistance, stop tightening, loosen the screw, and then try to retighten it. A small gap should remain between the cover and the body even after tightening (due to a gasket).

2. Preparation

2.2 Connecting the Sensor Cable

Connect the sensor cable.



CAUTION

Connect the sensor cable in a place free from moisture.

When connecting the sensor cable, tighten by turning only the silver locknut, do not turn the cable or waterproof cover. Also take care not wet or contaminate the connector.

Sensors for the PH81 or PH82 meters can be connected. When used in conjunction with the PH72 meter, however, water resistance is not guaranteed. This is due to the different construction of the connector cover.

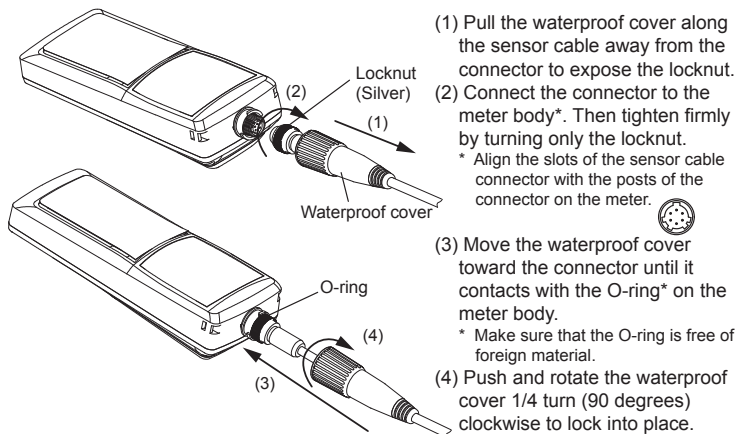

Note: It is recommended that the sensor be kept connected to the meter to avoid contamination of the connectors.

2.3 Setting the Date and Time

After installing the batteries, set the date and time. Note that if the power is turned off before completing minute setting, start with the date setting when you turn on the power next time. By replacing the batteries, the date setting is not affected but the time setting is. So the time must be reset.

Note: If a sensor cable is not connected to the meter, fluctuating readings or an error message may appear. Before pressing **POWER** key, make sure that a sensor has been connected.

2. Preparation

2.5 Wetting Cap

The glass electrode should be kept wet during storage. If the glass electrode dries out, it will take hours to rehydrate and in the meantime the meter may give erroneous readings. The wetting cap is used to prevent the glass electrode from drying out. Sensors are shipped with a wetting cap containing a cotton wad moistened with a few drops of water. For storage replenish the cap with a few drops of water (tap water) and attach to the sensor firmly.

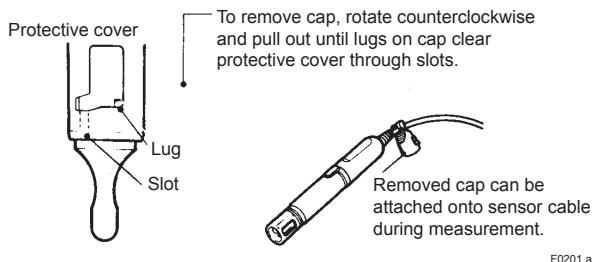

Figure 2.1 Wetting Cap

2.6 Manual Temperature Setting

If a sensor without a built-in temperature element (needle type or test tube size pH sensor) is connected to the meter, **MAN** mark will appear on the display. In this case, measure the temperature of the solution being measured and manually set the measured temperature into the PH72 meter for reliable measurement. The procedure is described in Section 5.3 (2), "Manual temperature setting (M.tP) panel."

Temperature compensation is performed based on a temperature shown on the display of the PH72 meter. If a temperature shown on the display is different from the actual temperature of the sample being measured, the displayed measured value may not be true. The bigger the difference between the temperature displayed on the meter and the actual temperature of the solution, the bigger the error between the displayed measured value and the true value.

If **MAN** mark appears on the display even though a sensor with a built-in temperature element is connected, refer to Section 7.4.

2.7 pH Calibration

The PH72 meter needs to be calibrated:

- when the sensor is connected for the first time;
- after the sensor is replaced;
- after the meter has been stored for a long period;
- after the electrode is cleaned; or
- when necessary.

The calibration procedure is described in Chapter 4, "Calibration."

Note: Calibration results are saved in the meter when the batteries are replaced.

3. Measurement

3.1 Precautions

- (1) After storage for an extended period of time, it is recommended that the meter should be calibrated before taking measurements.
- (2) When using a KCl refillable type sensor, check the level of filling solution (refer to Section 6.6).
- (3) Do not use the meter in a solution with the temperature exceeding 80°C (100°C for the needle type and test tube size pH sensors). When a KCl replenish-free type sensor is used and its sensor grip is immersed, the temperature of the solution should not exceed 50°C. Also, do not use the meter in strongly corrosive solutions, such as a solution containing hydrofluoric acid.
- (4) Remove stains from the PH72 meter body using a soft cloth or tissue. If necessary, use a neutral detergent.
- (5) If an abnormal symptom occurs during measurement, locate the cause of the problem and take corrective actions referring to Chapter 7, "Troubleshooting."
- (6) After measurement, rinse off dirt or the sample solution from the sensor with water and store it (refer to Chapter 6, "Maintenance").
- (7) Keys should be operated by fingers.

Using the PH72 Meter on a Table

The meter is designed as a portable instrument; however, to use it on a table, attach non-slip pads (supplied with the instrument) at top and bottom of the meter to stop it from moving when the sensor is moved.

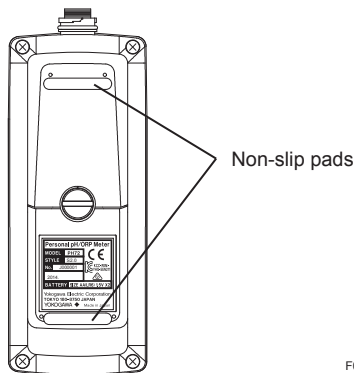

F0301.ai

Figure 3.1 Position of Non-slip Seats

3. Measurement

3.2 Measurement Procedures

Immersing the sensor

Immerse the sensor so that the protective cover part goes under the sample solution level. The sensor does not need to be immersed deeply.

When using a KCl refillable type sensor, the filling solution level must be above the level of solution being measured. This is to prevent the KCl filling solution from being mixed with the sample solution.

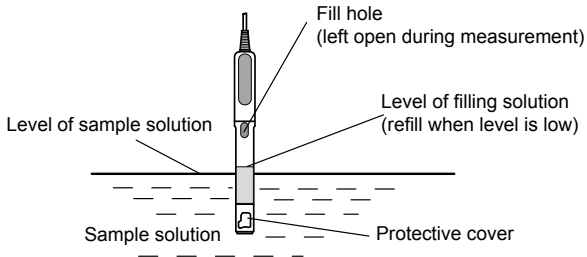

KCl refillable type sensor must be immersed so filling solution level is above the level of sample solution.

F0302.ai

Figure 3.2 How to Immerse the KCl Refillable Type Sensor

Bubbles trapped in the glass electrode tip may interfere with accurate measurement. Before taking measurements, check the electrode tip for bubbles. If present, gently shake the sensor, as shown in Figure 3.3, to dislodge bubbles from the tip.

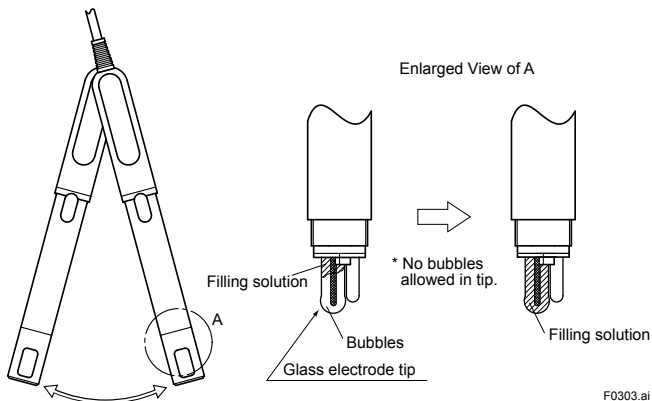

F0303.ai

Figure 3.3 How to Dislodge Bubbles from Glass Electrode Tip

3.3 Measurement Display Panel

When immersing the sensor in a sample solution, a measured pH value will be shown on the display. There are three types of measurement display panels: the standard, calendar, and clock display panels. Use **MEAS** key to cycle through these display panels.

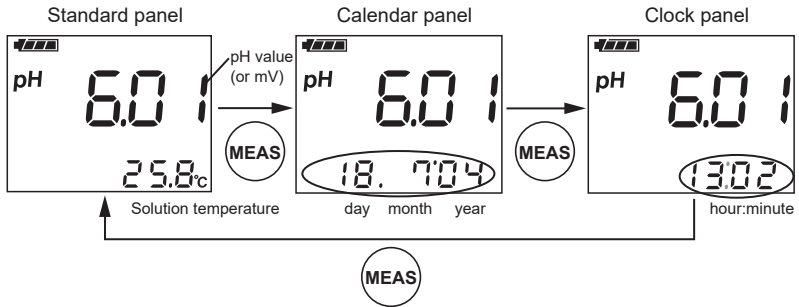

F030301.ai

3.4 Saving a Measured Value

There are two ways to save a measured value: holding temporarily and storing as a record in nonvolatile memory. Measured values stored in nonvolatile memory are not deleted even by replacing the batteries.

(1) HOLD

If **HOLD** key is pressed during measurement, the currently measured value is held temporarily and the displayed value no longer changes. Press **HOLD** or **MEAS** key to return to the measurement mode.

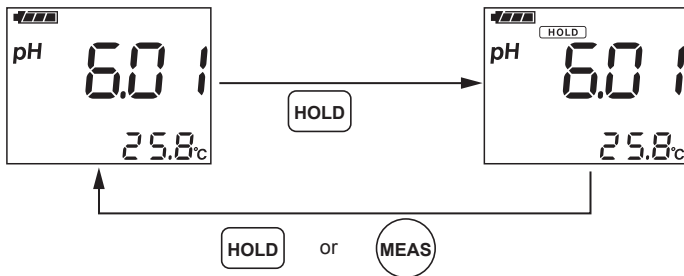

F030401.ai

3. Measurement

(2) Data storage

If the **DATA** key is pressed during measurement, **DATA** mark starts flashing.

Press the **F/ENT** key, then currently measured data can be stored in nonvolatile memory. Data stored are measured pH (or mV), measured temperature, date and time. Up to 300 data including individually deleted data can be stored. If you attempt to store more data, **FULL** will be displayed.

If **FULL** is displayed before the data number has reached 300, run defrag referring to Section 5.3 (15), "Defrag memory (DFLG) panel." This will free up memory occupied by deleted data, allowing data to be stored newly. To check stored data, refer to Section 5.3 (1), "Display stored data (dAt) panel."

Pressing **DATA** or **MEAS** key while **DATA** mark is flashing cancels data storage and returns the meter to measurement mode.

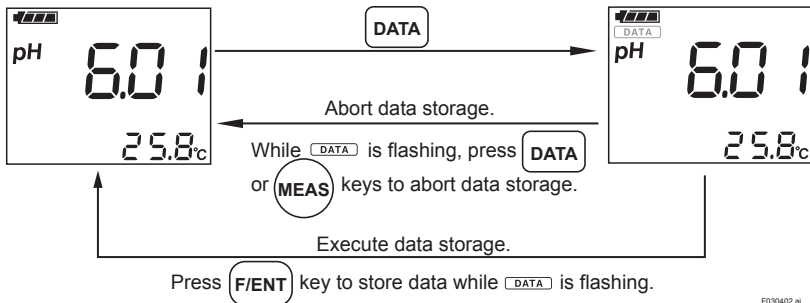

F030402.ai

4. Calibration

Calibration using standard solutions means to measure the pH value of a certified standard solution and to adjust the pH meter so it reads the same value as the certified value of the standard solution. The PH72 meter can be calibrated automatically or manually.

The PH72 meter must be calibrated before measurement if:

- it has been stored for a long period;
- the electrode has been cleaned; or
- otherwise necessary.

Precautions

- (1) Use certified standard solutions. Using deteriorated standard solutions will result in inaccurate calibration. Standard solutions are available as spare parts (see Section 1.8).

Pour a portion of the standard solution into a calibration bottle (supplied) and use for calibration. Do not reuse the portion. Discard it and use a fresh portion for another calibration.

- (2) Do not press  key unless calibration is needed. Otherwise, saved calibration results may be changed.
- (3) Temperature of standard solutions should be close to that of measuring solutions in normal condition. The gap of temperature between those solutions may result in inaccurate measurement.

Before Calibration

The following should be checked and set before calibration.

- (1) Contamination of the sensor

Make sure that no dirt or deposits are present on the sensor.

- (2) Temperature setting

When using a sensor without a built-in temperature element, i.e., a needle type or test tube size pH sensor, the temperature of a standard solution to be used should be set into the meter (refer to Section 5.3 (2), "Manual temperature setting (M.tP) panel").

- (3) Battery condition

Check the battery condition indicator for remaining life. If the indicator is flashing, calibration cannot be performed. Replace the batteries (refer to Section 2.1, "Installing the Batteries").

Error Messages during Calibration

If the meter detects an abnormality during calibration, *Err 1*, *Err 2*, *Err 3* or

 may be displayed. In such a case take corrective actions referring to Chapter 7, "Troubleshooting."

4. Calibration

Canceling Calibration

To cancel the calibration procedure, press **CAL** or **MEAS** key. The meter will return to measurement mode.

1-point and 2-point Calibrations

There are two types of calibrations: 1-point calibration using only one standard solution and 2-point calibration using two standard solutions. One-point calibration is a simplified calibration method which can be used only when the anticipated pH values of sample solutions are near the certified pH value of a standard solution used for calibration. Two-point calibration is generally recommended.

Calibration results are not affected by turning off the power and saved until the next calibration or the initialization of calibration parameters (see Section 5.3 (11)). The last two calibration results are saved in the meter. Therefore, for 1-point calibration, first initialize calibration parameters and then perform a 1-point calibration, or without initializing, perform a 1-point calibration twice using the same standard solution.

4.1 Automatic Calibration

In automatic calibration the Model PH72 Personal pH/ORP Meter automatically recognizes standard solutions being used and calibrates itself using values of Table 4.1. Two types of standard solutions are preprogrammed: NIST (solutions prepared in accordance with Japanese standards, factory default) and US (solutions prepared in accordance with the U.S. standards). If NIST is selected, the meter recognizes standard solutions with pH 2, 4, 7, 9, and 12. The meter recognizes standard solutions with pH 4, 7, and 10 if US is selected.

Table 4.1 pH-Temperature Relationship in pH Standard Solutions

• NIST

Temperature °C \ Std. Solution	0	5	10	15	20	25	30	35	40	45	50	55	60	70	80
pH2	-	1.668	1.670	1.672	1.675	1.679	1.683	1.688	1.694	1.700	1.707	1.715	1.723	1.743	1.766
pH4	4.003	3.999	3.998	3.999	4.002	4.008	4.015	4.024	4.035	4.047	4.060	4.075	4.091	4.126	4.164
pH7	6.984	6.951	6.923	6.900	6.881	6.865	6.856	6.844	6.838	6.834	6.833	6.834	6.836	6.845	6.859
pH9	9.464	9.395	9.332	9.276	9.225	9.180	9.139	9.102	9.068	9.038	9.011	8.985	8.962	8.921	8.885
pH12	13.423	13.207	13.003	12.810	12.627	12.454	12.289	12.133	11.984	11.841	11.705	11.574	11.449	-	-

• US

Temperature °C \ Std. Solution	0	5	10	15	20	25	30	35	40	45	50	55	60
pH4	4.000	3.998	3.997	3.998	4.001	4.005	4.010	4.018	4.027	4.038	4.050	4.064	4.080
pH7	7.120	7.090	7.060	7.040	7.020	7.000	6.990	6.980	6.980	6.978	6.970	6.980	6.980
pH10	10.317	10.245	10.179	10.118	10.062	10.012	9.966	9.926	9.889	9.856	9.828	9.828	9.828

Before Automatic Calibration

Make sure that the correct type of standard solutions to be used for automatic calibration has been selected (refer to Section 5.3 (10), "Standard solution setting (Std) panel").

● Procedure

Example 1: 2-point calibration using pH 7 and pH 4 standard solutions

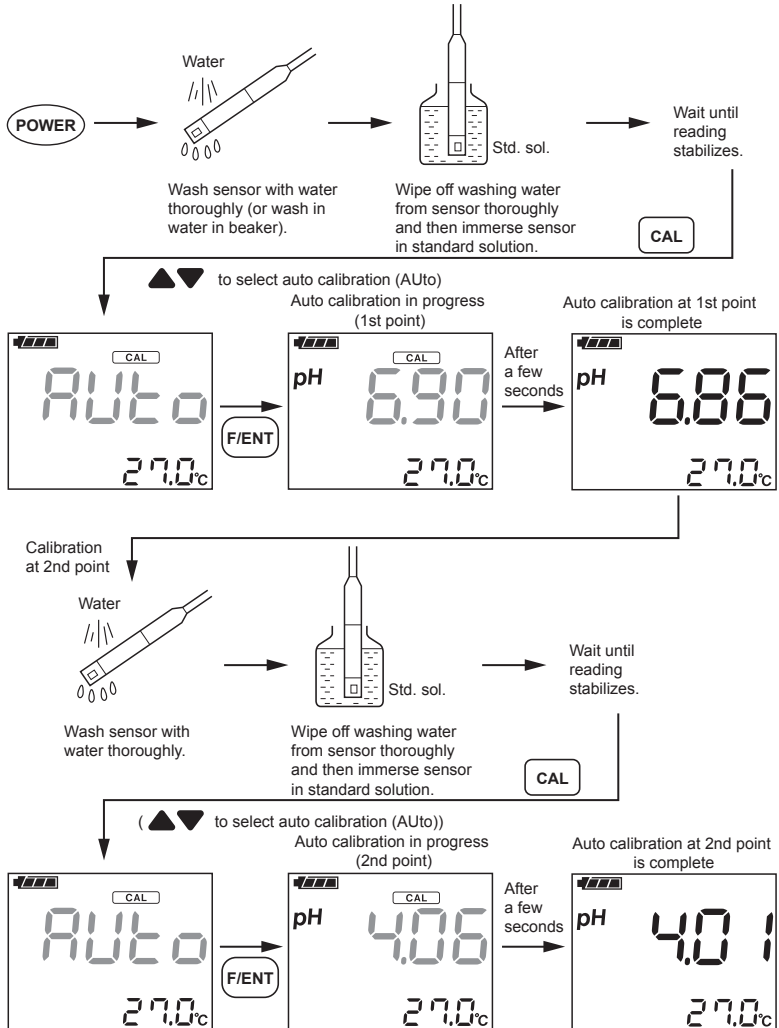

F0401.ai

4. Calibration

The last two calibration results are saved in the meter. Therefore, for 1-point calibration, perform a 1-point calibration twice using the same standard solution, or initialize calibration parameters (refer to Section 5.3 (11), "Initialize calibration parameters (I.CP) panel") before performing a 1-point calibration.

Example 2: Calibration of a sensor without a built-in temperature element* using a pH 7 standard solution

* Needle type or test tube size pH sensor

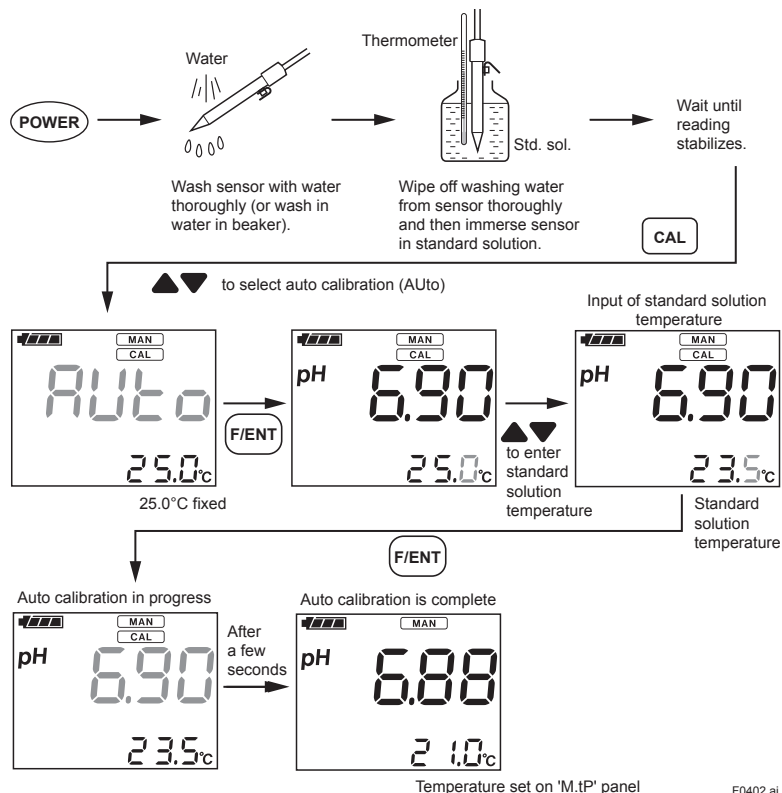

For 2-point calibration, continue the procedure in the same way as Example 1. The difference between Example 1 and 2 is that **MAN** appears on the display and the temperature of a standard solution should be entered manually.

4.2 Manual Calibration

When using standard solutions other than those preprogrammed for automatic calibration (see Section 4.1), calibration should be performed manually.

In 2-point calibration, manual calibration can be performed at both two points or manual calibration performed at one point (either 1st or 2nd) in combination with automatic calibration using a specified standard solution at the other point.

Note: Although manual calibration can be performed using standard solutions the same as the ones preprogrammed for automatic calibration, it only makes the procedure more complicated. When using these standard solutions, automatic calibration should be generally performed.

● **Precautions**

- (1) The difference between the pH values of two standard solutions to be used for 2-point calibration must be at least 0.7 pH. If not, the meter will recognize the two standard solutions as the same calibration point. That is, the second calibration result will override the first calibration value, resulting in 1-point calibration.
- (2) When using alkaline standard solutions, use the standard solution with lower pH for the first point calibration. If not, **CHECK SENSOR** may appear.

● **Procedure**

Example 3: Manual calibration

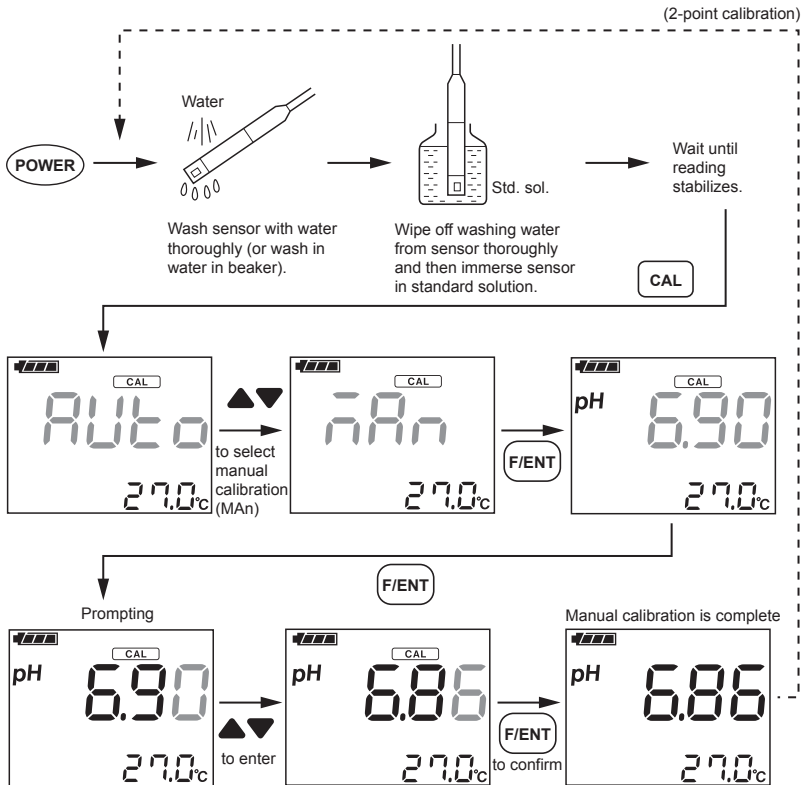

F0403.ai

4. Calibration

For 2-point calibration, continue the procedure following the dotted line. When using a sensor without a built-in temperature element (needle type or test tube size pH sensor), enter the temperature of standard solution following the procedure described in Section 4.1, Example 2.

5. Keypad and Display Functions

There are eight membrane keys on the keypad of the Model PH72 Personal pH Meter. The following key functions are provided.

- Displaying a pH (or mV) value and temperature
- Displaying a pH (or mV) value, date and time
- Holding a pH (or mV) value and temperature
- Storing data — pH (or mV) value and associated information
- Function mode
- Calibration

Turns power on or off.
Automatic Power Off
function (default: 20 min).

Moves to calibration
mode.

Holds the currently
measured value.

Stores the currently
measured value in
memory.

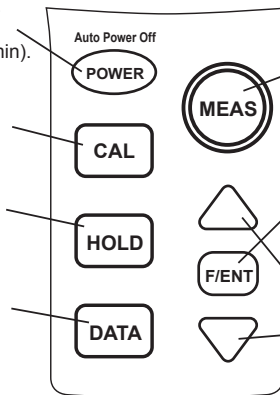

Moves to measurement
mode or switches
measurement display
panels. Also exits from
the current function and
returns to measurement
mode.

Moves to function
mode or confirms data
entry.

Changes setting or
value.

F050001.ai

5.1 Keypad Functions

POWER : Power On/Off key

Pressing and holding this key for at least one second when nothing is displayed on the LCD, will turn the meter on. The meter will be turned off by pressing and holding this key for at least two seconds when the meter is on. If no keys are pressed for a preset time, the meter turns off power automatically (refer to Section 5.3 (8), "Set Auto Power Off time (A.oFF) panel").

CAL : Calibration key

When pressed during measurement, **CAL** mark turns on and the meter moves to calibration mode. To return to measurement mode, press **CAL** or **MEAS** key.

HOLD : HOLD key

When pressed during measurement, **HOLD** mark turns on and the currently displayed measured pH (or mV) value and temperature are held. Pressing **HOLD** or **MEAS** key will turn **HOLD** mark off and return the meter to measurement mode.

5. Keypad and Display Functions

DATA : DATA key

When pressed during measurement, **DATA** mark flash and the currently displayed measured pH (or mV) value and temperature are held temporarily. Pressing **F/ENT** key while **DATA** mark is flashing, will store the held data in memory. After the data is stored successfully, the meter returns to measurement mode automatically. To cancel

data storage, press **DATA** or **MEAS** key while **DATA** mark is flashing. **DATA** mark will turn off and the meter will return to measurement mode.

MEAS : Measurement key

In measurement mode each press of this key cycles through three measurement display panels (refer to Section 3.3, "Measurement Display Panel"). Pressing this key in other modes will return the meter to measurement mode. If you want to cancel any operation, press this key to return to measurement mode.

▲▼ : Setting change keys

Used to change settings.

F/ENT : Entry key

Pressing this key during measurement moves the display to function mode (refer to Section 5.3, "Function Modes"). This key is also used to confirm data entry.

Beep sound

When a key is pressed, the meter acknowledges it using a beep sound.

(1) One beep

The meter will beep once confirming a valid key entry.

(2) Three beeps

The meter will beep three times if the key entry is invalid.

To disable the beep, refer to Section 5.3 (9), "Set beep on/off (bZ.o) panel." Note that the volume of the beep sound is not adjustable.





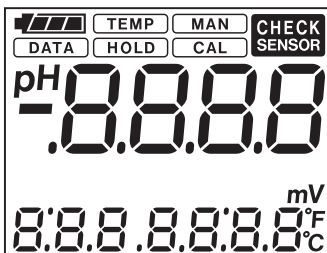





5.2 Display Items

Display items and their descriptions are provided below.



	Battery condition indicator
TEMP	Temperature setting mode
MAN	Manual mode
DATA	Data mode
HOLD	HOLD mode
CAL	Calibration mode
CHECK SENSOR	Sensor check mode

F050201.ai

- (1) **Battery condition indicator**  Indicates the level of the remaining battery life stepwise.  means that there is plenty of life left. A flashing  means that the batteries are low and need to be replaced immediately. When the indicator is flashing, access to calibration mode by pressing  key is rejected. To replace the batteries, first press  key to turn off power and make sure the display has been turned off, and then replace referring to Section 2.1, "Installing the Batteries."
- (2) **Temperature setting mode**  Appears while manual temperature setting is being performed (refer to Section 5.3 (2), "Manual temperature setting (M.tp) panel").
- (3) **Manual mode**  Appears when a sensor without a built-in temperature element (needle type or test tube size pH sensor) is connected to the meter (refer to Section 2.6, "Manual temperature setting").
- (4) **Data mode**  Appears when measured data are stored or when stored data are accessed (refer to Section 5.1, "Keypad Functions," and Section 5.3 (1), "Display stored data (dAt) panel").
- (5) **HOLD mode**  Appears while measured data are being held temporarily (refer to Section 5.1, "Keypad Functions").
- (6) **Calibration mode**  Appears during calibration using standard solutions (refer to Chapter 4, "Calibration").
- (7) **Sensor check mode**  This mark may appear when:
- the pH electrode deteriorated significantly (check is performed during calibration);
 - the standard solution used for calibration changed in quality;
 - deposits are present on the electrode (check is performed during calibration). If deposits are present, clean the sensor (see Section 6.2); or,
 - calibration is performed improperly.
- If you performed an incorrect calibration procedure, initialize the calibration parameters and calibrate the PH71 again (see Section 7.4).

5.3 Function Mode

● Outline

Various functions are supported by function mode. Press **F/ENT** key while the meter is in measurement mode to move to function mode.

Note: The last selected and executed item is displayed when you move to function mode. Use **▲▼** keys to cycle through the items listed in Table 5.1 in that order.

● Setting Procedures

Use **▲▼** keys to move to the desired item. While the desired item is flashing, press **F/ENT** key to access that item panel. To return from function mode to measurement mode, press **MEAS** key anytime.

Table 5.1 Function Mode Item List

Item*	Description	Default*2	For details, refer to:
dAt <i>dAt</i>	Display stored data	no dAtA	Item (1)
M.tP <i>M.tP</i>	Manual temperature setting	25 °C	Item (2)
PV.U <i>PV.U</i>	Set measurement unit	pH	Item (3)
dEL.A <i>dEL.A</i>	Delete all stored data	–	Item (4)
dAtE <i>dAtE</i>	Date setting	2004, 1 (month), 1 (day)	Item (5)
tIME <i>tIME</i>	Time setting	0 hour 0 minute	Item (6)
ALM <i>ALM</i>	Alarm time setting	oFF	Item (7)
A.oFF <i>A.oFF</i>	Set Auto Power Off time	20 min	Item (8)
bZ.o <i>bZ.o</i>	Set beep on/off	on	Item (9)
Std <i>Std</i>	Standard solution setting	nISt	Item (10)
I.CP <i>I.CP</i>	Initialize calibration parameters	no	Item (11)
tP.U <i>tP.U</i>	Set temperature unit	°C	Item (12)
VEr <i>VEr</i>	Check version number	–	Item (13)
dFLG <i>dFLG</i>	Defrag memory	–	Item (14)

*1: For displayed digital characters, see Alphanumeric Display Table in Preface.

*2: "2" denotes that the item is not user configurable.

Operating procedures on each panel are described below.

(1) Display stored data (dAt) panel

Shows stored data on the LCD with DATA mark. When you access this panel, the last stored pH (mV) value and temperature will be displayed with the data number flashing at the lower left of the display. Pressing ▲▼ keys scrolls through all stored data. If no data are stored, “no dAtA” is displayed at the bottom of the display. Each press of DATA key cycles through the day/month, year, and time of the stored data, and “Delete stored data” panels.

• **Individual Deletion**

By pressing F/ENT key when “dEL” appears underneath the value, the currently displayed stored data can be deleted. First F/ENT is flashing. Use ▲▼ keys to switch to flashing **YES** and then press F/ENT key. The stored data with the number to the left of “dEL” will be deleted.

• **Data Numbering after Deletion**

The number displayed at the bottom left indicates the stored data number relative to the beginning of the data store. This number does not necessarily represent the number of stored data. If a data item is deleted, item numbers of data that follow it will be decreased by one.

• **Data Display after Deletion**

If a data item is deleted, the data item after it is displayed. If there is no data after the deleted data item (i.e., it was the last stored data item), the data item before the deleted data item is displayed.

When data item 012 (latest data) is deleted:

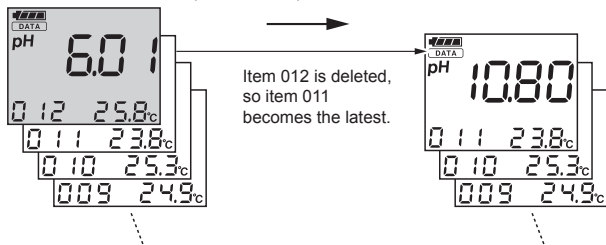

When data item 011 is deleted:

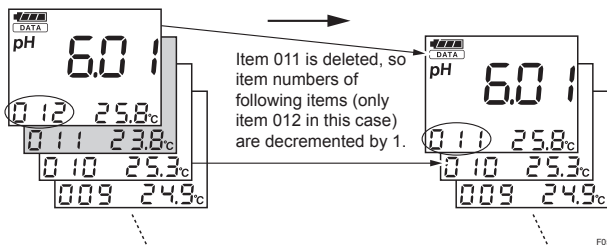

F050300.ai

5. Keypad and Display Functions

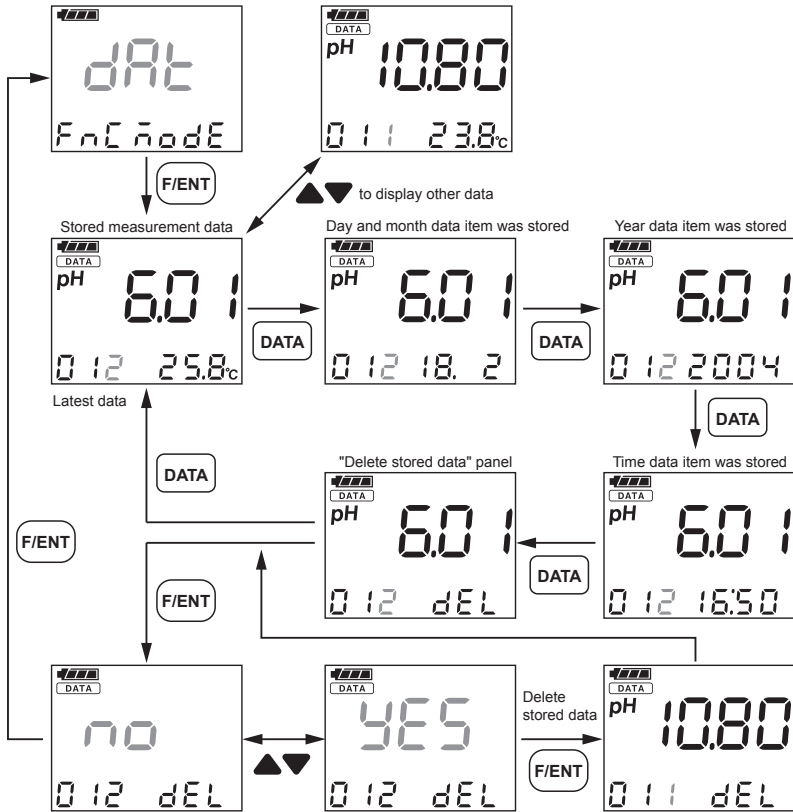

When no stored data.

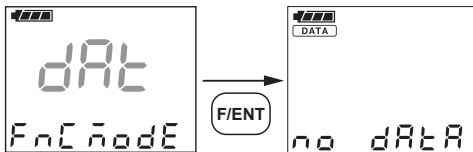

F050301.ai

(2) Manual temperature setting (M.tP) panel

Used to input the temperature of a solution into the meter when using a sensor without a built-in temperature element (needle type or test tube size pH sensor). This setting is not required when a sensor connected has a built-in temperature element. The setting range is from -10.0 to 110.0°C.

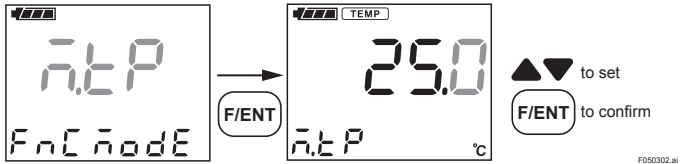

(3) Set measurement unit (PV.U) panel

Used to set a pH unit for pH measurement or a mV unit for ORP measurement.

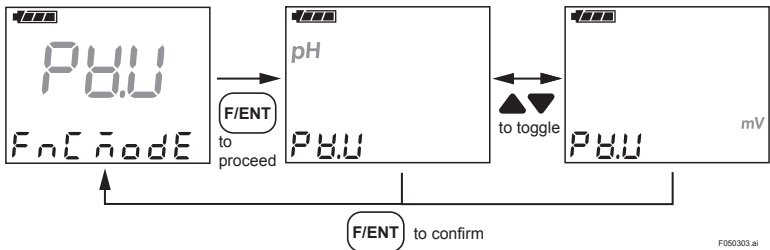

(4) Delete all stored data (dEL.A) panel

Used to delete all stored data. Press F/ENT key on the flashing "dEL.A" panel. nO will be flashing. Use ▲▼ keys to select YES. Press F/ENT key to delete all stored data completely.

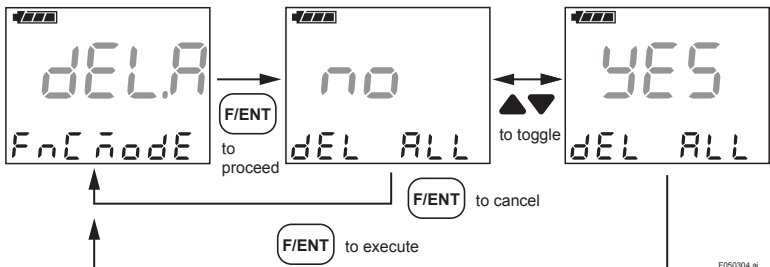

5. Keypad and Display Functions

(5) Date setting (dAtE) panel

Used to set the year (four digits), month and day in this order. Use ▲▼ keys to set the year, month, and day, and press **F/ENT** key to confirm each entry.

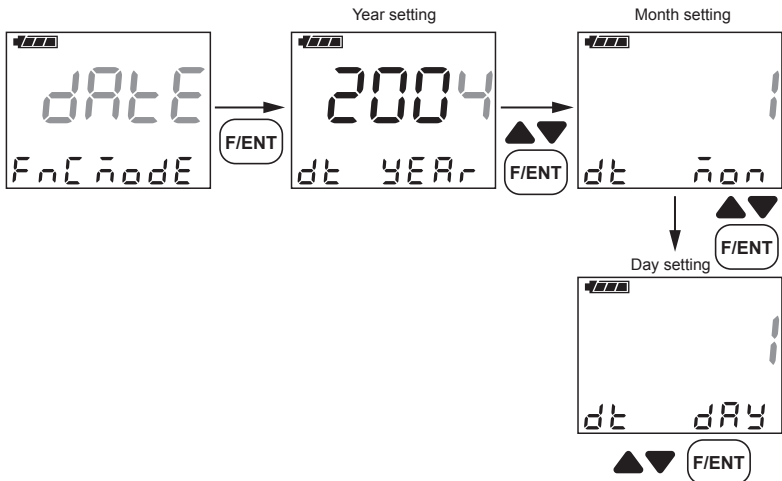

The calendar function will be valid through to year 2090.

(6) Time setting (tIME) panel

Used to set the time — hour (24-hour format) and minute in this order. Use ▲▼ keys to set the time and press **F/ENT** key to confirm each entry.

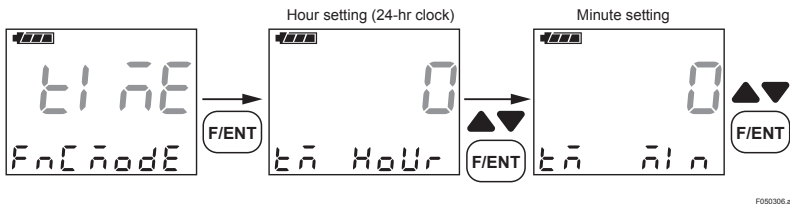

(7) Alarm time setting (ALM) panel

Used to enable/disable the alarm clock and set the alarm clock in minutes and seconds. Use ▲▼ keys to select the desired alarm cycle: 7 days (everyday), 5 days (weekdays) or once. See Item (5), "Time setting (tIME) panel" for setting the time for alarm. The alarm sounds for about 15 seconds. Acknowledge the alarm by pressing any key. The alarm sound will stop. If no key is pressed (no acknowledgement), the alarm sounds for 15 seconds again 3 and 6 minutes after the preset alarm time. Note that the day of the week is not displayed.

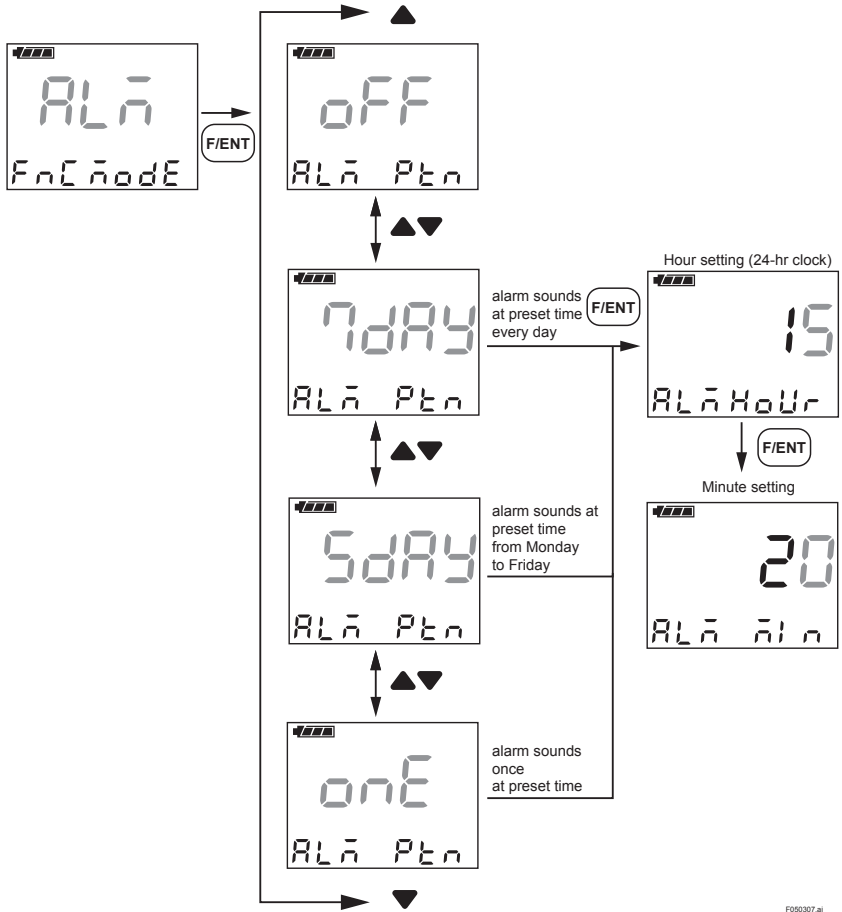

F050307.ai

(8) Set Auto Power Off time (A.oFF) panel

Used to set the automatic power off time. The meter turns off power automatically if no key is pressed during this preset time. The time range is from 1 to 120 minutes. If 0 is set, the Auto Power Off function will be disabled. Use the meter taking care to conserve the batteries.

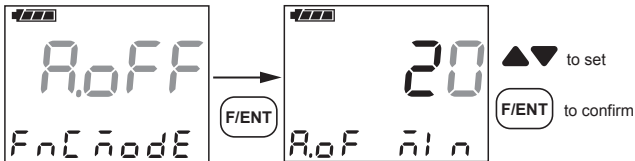

F050308.ai

5. Keypad and Display Functions

(9) Set beep on/off (bZ.o) panel

The beep sound on key press can be enabled/disabled in this panel. Use ▲▼ keys to select on or off and press **F/ENT** key to confirm. Note that this beep setting does not affect the alarm sounding (see Item (7)).

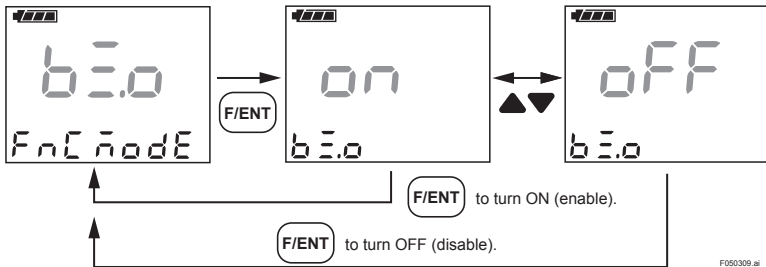

(10) Standard solution setting (Std) panel

Used to select the type of standard solutions: NIST or US. The factory default is NIST. When using standard solutions prepared in accordance with the Japanese standards, use the meter with the factory default of NIST. Select US only when using standard solutions prepared in accordance with the U.S. standards (refer to Chapter 4, "Calibration").

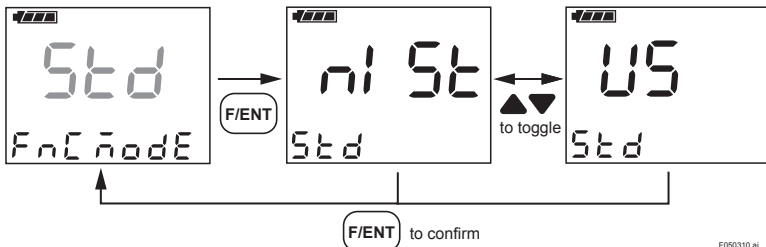

(11) Initialize calibration parameters (I.CP) panel

Used to initialize the parameters saved by calibration to default settings: slope at 1.000 and asymmetry potential at 0.0 mV.

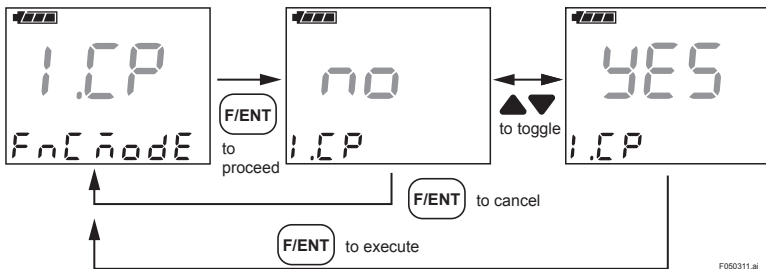

(12) Set temperature unit (tP.U) panel

Used to select the temperature unit: Celsius (°C) or Fahrenheit (°F). Use ▲▼ keys to select the desired temperature unit and press **F/ENT** key to confirm.

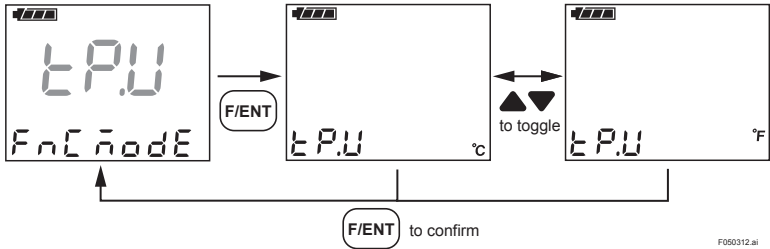
**(13) Check version number (VEr) panel**

Used to check the version number of the program. This is not user configurable.

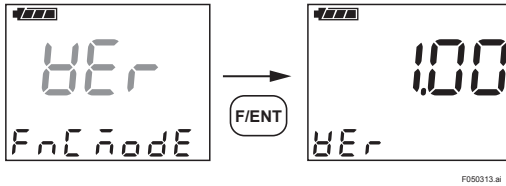
**(14) Defrag memory (dFLG) panel**

Up to 300 data can be stored. Unnecessary data can be individually deleted (refer to Item (1), "Display stored data"), but this individual deletion does not free up memory occupied by deleted data. Therefore, **FULL** may be displayed even though less than 300 data are stored. In such a case, use the defrag function to consolidate data and free up the space occupied by deleted data, thereby allowing up to 300 data to be stored.

While memory defrag is in progress, do NOT turn off the power. In addition, before starting memory defrag check that there is enough battery life left to avoid battery shutoff during memory defrag.

- **Procedure**

Press **F/ENT** key on the flashing "dFLG" display. **n o** will be flashing. Use ▲▼ keys to select **YES**, then press **F/ENT** key. While defrag is in progress, "WAlT" may flash. It may not flash depending on the amount of deleted data. When defrag is complete, "End" appears.

5. Keypad and Display Functions

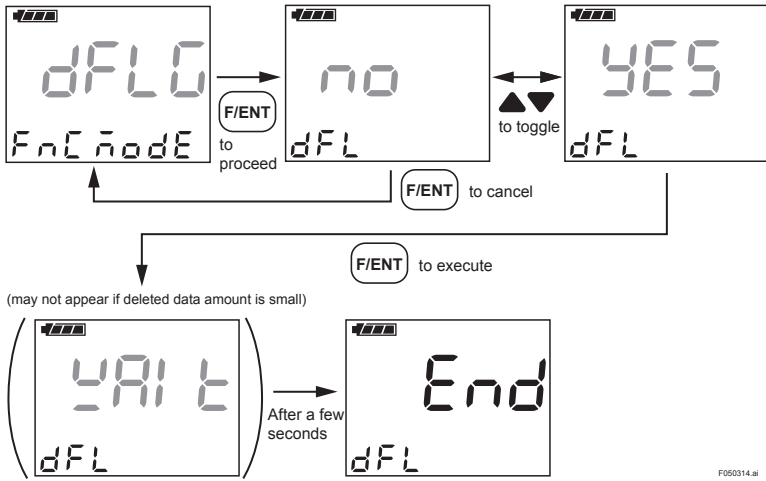

6. Maintenance

6.1 For Optimum Meter Performance

The Model PH72 Personal pH/ORP Meter is simple to operate, but is a precision instrument. To ensure accurate results from the meter, the following precautions should be observed.

Flow Diagram

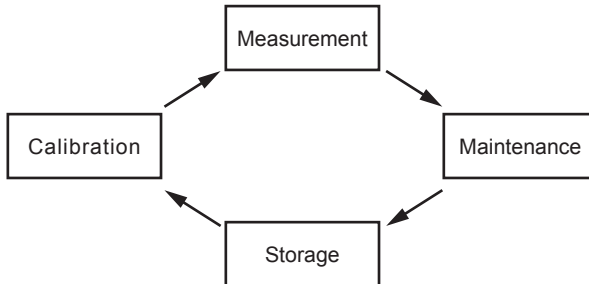

F060101.ai

Table 6.1 Precautions in Each Step

Calibration	Calibration using standard solutions: <ul style="list-style-type: none"> • 1- or 2-point calibration. 2-point calibration is recommended for accurate pH measurement. • Always use certified standard solutions (pH 2, 4, 7, 9, 10, or 12).
Measurement	Sample solution requirements: <ul style="list-style-type: none"> • pH range: 0 to 14 pH • Temperature: 0 to 80°C (0 to 100°C when using needle type or test tube size pH sensor)
Maintenance	<ul style="list-style-type: none"> • After measurement, rinse off remaining sample solution from the electrode thoroughly.
Storage	<ul style="list-style-type: none"> • Avoid a place with high temperature and humidity. • Keep the wetting cap (moisten the cotton wad in the cap with a few drops of water) attached to prevent the glass electrode and liquid junction from drying out.

6.2 pH Electrode Cleaning

Dirt or deposits on the glass electrode or liquid junction can often interfere with accurate measurement. Periodical cleaning is required depending on the nature of the solution being measured.

 **CAUTION**

Do not apply physical shock or excessive force to the glass sensor, or it may break.
Do not rub the glass membrane strongly, or it may be damaged or break.

● **Suspended Solids, Adhesive Material, Microorganisms, Greasy Substances, etc.**

Dirt or deposits on the glass electrode, liquid junction or temperature element should be removed. Clean using a cotton swab soaked with a neutral detergent, and rinse off with water. If necessary, use a toothbrush to clean.

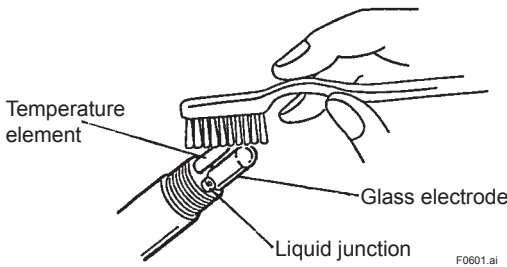

Figure 6.1 How to Clean Using a Toothbrush

● **Chemical Contaminants**

Chemical contaminants can affect the electrode performance even though the electrode appears to be clean. If **CHECK SENSOR** appears on the display, soak the electrode in dilute hydrochloric acid (approximately 0.1 mol/L, 1 to 2 pH) for 10 to 20 minutes (this process is called acid cleaning). Since an electrode deteriorates gradually in service, its performance cannot be recovered completely even if acid cleaning is conducted. After cleaning, rinse off cleaning solution from the electrode with water.

Note: Dilute hydrochloric acid is commercially available at a pharmacy. Handle with care.

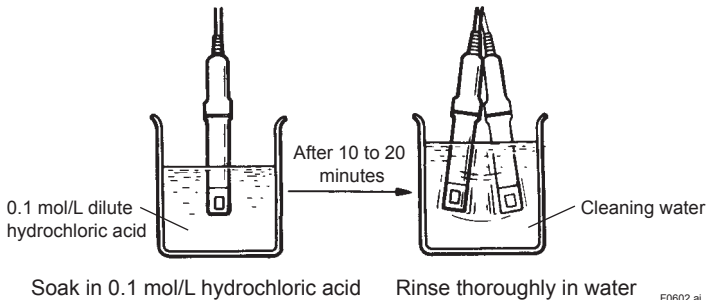



Figure 6.2 Acid Cleaning

6.3 Sensor Replacement

Since a pH sensor undergoes chemical changes with time, its performance deteriorates gradually. Under normal operating conditions a sensor can be used for one or two years. Sensor deterioration, however, speeds up depending on the nature of a sample solution, e.g., a high temperature solution. Storage conditions also affect the sensor life.

If $E r r 2$ or $E r r 3$ appears while calibration is being performed with a sensor for which  is displayed, replace the sensor.

6.4 Rehydrating the Glass Electrode

A dry glass electrode gives fluctuating pH readings. If a glass electrode has dried up, soak it in water (tap water) for 1 to 2 hours or longer to rehydrate. The sensor will give stable pH readings.

6.5 Point to note when performing calibration or measurement

When the internal electrode (Ag / AgCl) of the glass electrode is exposed to sunlight, the electromotive force changes due to the influence of ultraviolet rays. In this case, the pH value may be displayed higher than the actual pH value.

When calibrating the pH sensor and measuring the process solution, keep the glass electrodes out of the sunlight.

6.6 Replenishing the Electrode with Filling Solution (KCl solution)

Replenishment is required only when a KCl refillable type combination sensor is used. An electrode filling solution leaks from the liquid junction little by little during measurement. When the level of filling solution drops to the level shown in Figure 6.3, replenish with a 3.3 mol/L KCl solution supplied.

 **CAUTION**

A syringe tip is sharp. Handle with care.

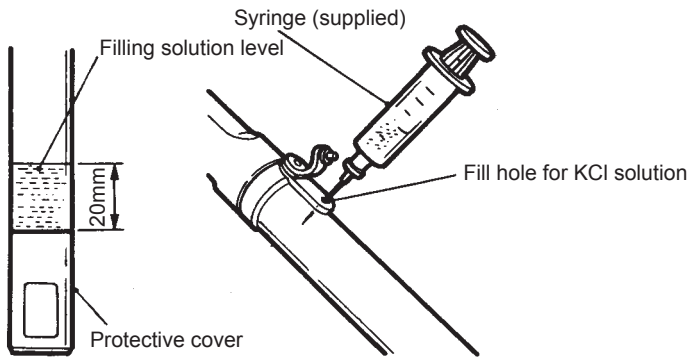

Replenish when filling solution level drops to the level shown above.

How to fill using syringe

F0603.ai

Figure 6.3 Replenishment of Filling Solution

6.7 Cleaning and Drying Connectors

Deteriorated insulation between connector pins can cause inaccurate readings. To remove stains and/or moisture that may cause deteriorated insulation, clean the connector with a dry cloth or a cloth moistened with anhydrous alcohol. If necessary, use a dryer.

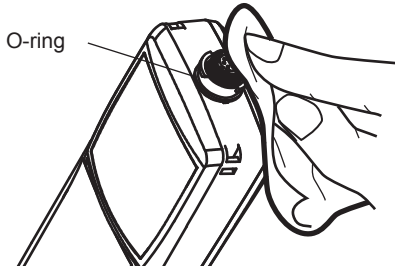

Wipe off stains and/or moisture on meter connector with a dry cloth.

Check that there are no stains on the O-ring.

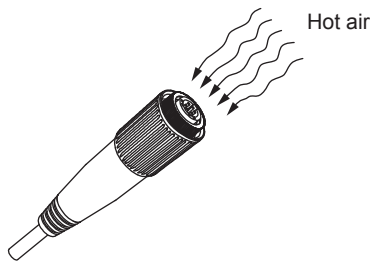

Use a dryer if necessary to remove moisture from connector of sensor cable.

F060601.ai



CAUTION

Use anhydrous alcohol to clean the connectors so no moisture remains. Dry connectors completely.

6.8 Storage and O-ring/Gasket Replacement

● Storage Precautions

Care is required when storing the meter and sensor. To maintain in good condition, observe the following:

- (1) Before storage, wash off remaining sample solution from the sensor with water. Deposits on the liquid junction, if any, must be removed thoroughly, or the junction may be clogged. A clogged junction will cause invalid measurements, e.g., unstable pH readings.
Keep a wetting cap attached to the sensor. For KCl refillable type sensors, seal the fill hole with a plug.
- (2) Leave the sensor connected to the meter body to protect the connectors and O-ring from staining. Contamination may cause deteriorated insulation of connectors or poor water resistance by the O-ring.
- (3) Do not place any object on top of the sensor or on the top of the PH72 meter.

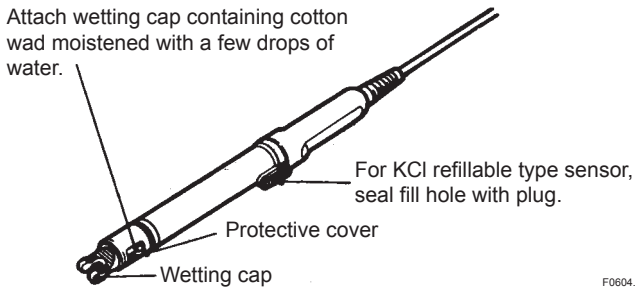

Figure 6.4 Sensor Storage Condition

● Storage Location

When not in use, store the meter and sensor in a safe place. If it is to be stored for a long period, store it in a place:

- With low humidity at or near normal temperatures
- Not exposed to direct sunlight or water
- No corrosive gases are present

● Replacing the O-ring and Gasket

A gasket in the battery box and an O-ring on the sensor connector of the meter can be replaced. Heavily contaminated or damaged gasket and/or O-ring should be replaced.

CAUTION

When installing an O-ring and gasket, clean them and their mounting surfaces with a cloth moistened with alcohol so that they are free from dirt. Otherwise, water resistance may not be assured.

(1) Replacing the O-ring

Install the O-ring on the cylindrical flat part of the connector, as shown below.

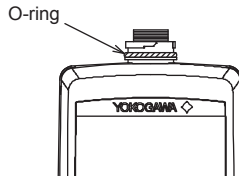

F060701.ai

(2) Replacing the Gasket

Install the gasket on the groove on the battery box so the raised part fits in place as shown below. The gasket is symmetrical right to left and front to back.

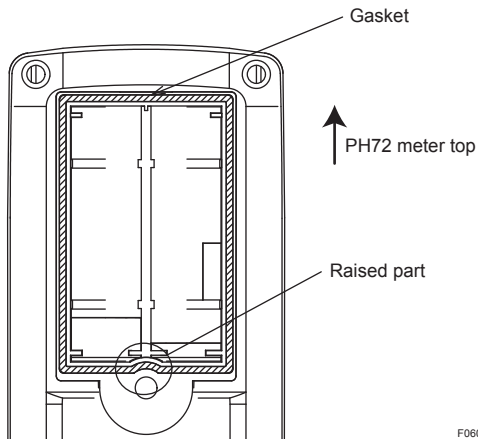

F060702.ai

6. Maintenance

7. Troubleshooting

7.1 Causes of Abnormal Readings and Errors

If the pH reading is unstable or abnormal, or an error message appears, during measurement or calibration, check the following:

- (1) Improper maintenance or usage
- (2) Expired consumables
- (3) Failure

If any trouble occurs, determine the cause and take corrective actions referring to Section 7.2. If the trouble cannot be fixed, contact your nearest Yokogawa sales office.

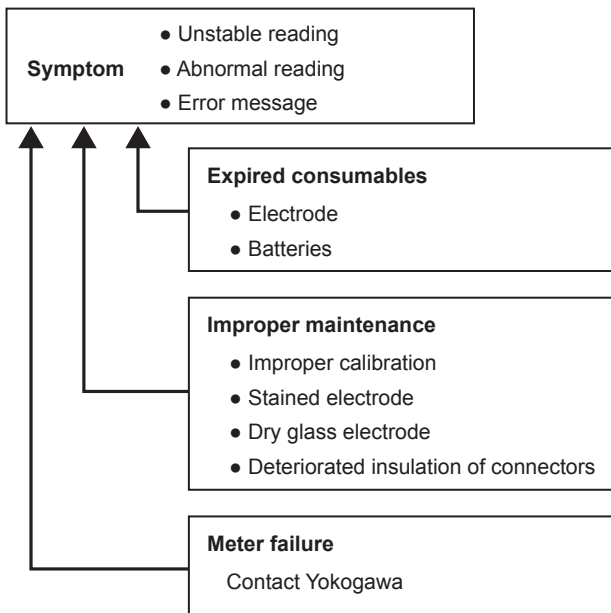

F0701.ai

Figure 7.1 Causes of Abnormal Symptoms

7.2 Error Messages, Possible Causes, and Corrective Actions

Table 7.1 Error Message

Error Message*1	Description	Occurrence
Err1 Err1	Unstable input emf	During calibration
Err2 Err2	Abnormal asymmetry potential	
Err3 Err3	Abnormal slope or calibration temperature	
Err4 Err4	Out of measuring range	During measurement
Err5 Err5	Out of temperature measuring range	
Err6 Err6	Meter electronics failure	

*1: For displayed digital characters, see Alphanumeric Display Table in Preface.

(1) Err1 Unstable input emf

Appears during calibration.

A calibration result is accepted when the variation of input emf for 10 seconds falls within ± 1 mV (approximately ± 0.02 pH equivalent). If the variation for 10 seconds cannot stabilize and is outside the range of ± 1 mV even after 3 minutes has elapsed in calibration, an Err1 message will appear.

Possible Causes:

- Dry electrode
- Clogged liquid junction
- Insulation failure in electronics
- Sensor immersed improperly

Corrective Actions:

- Leave the sensor in a standard solution until the reading stabilizes, and then try recalibration
- Remove dirt or deposits from the liquid junction (see Section 6.2)
- Remove stain or moisture from the connectors (see Section 6.7)
- Immerse the sensor properly (see Section 3.2)
- Immerse the sensor in water for 1 to 2 hours or longer to rehydrate (see Section 6.4)

(2) Err2 Abnormal asymmetry potential

Appears during calibration.

A sensor deteriorates in service and the emf deviates from the initial one. If the difference increases and exceeds the limit that can be compensated by calibration, an Err2 message will appear. It will also appear if the pH value of the standard solution is abnormal or if the asymmetry potential is outside the range of -96 to 120 mV.

Possible Causes:

- Clogged liquid junction
- Insulation failure in electronics
- Improper standard solution
- Dirt or deposits on electrode
- Electrode filling solution has been depleted
- Expired battery life
- Electrode contaminated with standard solution

Corrective Actions:

- Remove dirt or deposits from the liquid junction (see Section 6.2)
- Remove stain or moisture from the connectors (see Section 6.7)
- Use properly prepared standard solutions (see Chapter 4)
- Perform acid cleaning (see Section 6.2)
- For KCl refillable type sensors, replenish with filling solution (see Section 6.6)
- Replace the sensor (see Section 1.6)
- For KCl refillable type sensors, replace the filling solution

(3) Err3 Abnormal slope or calibration temperature

Appears during calibration.

In the Model PH72 Personal pH/ORP Meter standard solution data (NIST and US) are preprogrammed. During automatic calibration the meter recognizes standard solutions being used based on these data. If standard solutions other than the preprogrammed ones are used, an Err3 message will appear. It will also appear if the slope is outside the range of 65 to 125%.

Possible Causes:

- Defective standard solutions
- Dirty electrode
- Clogged liquid junction
- Insulation failure in electronics
- Outside calibration temperature range
- Improper manual temperature setting

Corrective Actions:

- Use properly prepared standard solutions (see Chapter 4)
- Remove dirt or deposits from the electrode and liquid junction (see Section 6.2)
- Remove stain or moisture from the connectors (see Section 6.7)
- Perform calibration within the calibration temperature range
- Set the temperature of the solution used manually and correctly (see Section 5.3 (2))

7. Troubleshooting

(4) Err4Out of measuring range

Appears during measurement.

The Model PH72 Personal pH/ORP Meter can measure the pH value of a solution in the range of 0 to 14 pH. If the pH value of the solution being measured is significantly outside this range (-2 pH or lower and 16 pH or higher), an Err4 message will appear. It will also appear if the electrode is dirty or has dried out. When a new sensor is used for the first time, an Err4 message may appear. This is due to low hydrophilic property a new sensor may have.

Possible Causes:

- Solution pH is significantly outside the measuring range of 0 to 14 pH
- Dry electrode
- Dirt or deposits on electrode

Corrective Actions:

- Immerse the sensor in water for 1 to 2 hours or longer to rehydrate (see Section 6.4)
- Remove dirt or deposits from the sensor (see Section 6.2)

(5) Err5Out of temperature measuring range

Appears during measurement.

With the Model PH72 Personal pH/ORP Meter, a general-purpose sensor can be used in the temperature range of 0 to 80°C and a needle type or test tube size sensor in the temperature range of 0 to 100°C. If the operating temperature is significantly outside this measuring range (below -10.0°C or above 120°C), an Err5 message will appear.

Possible Cause:

- Operating temperature is significantly outside the measuring range

Corrective Action:

- Adjust the temperature of the solution so it falls within the measuring range (0 to 80°C for general purpose types and 0 to 100°C for needle type or test tube size sensor)

(6) Err6Meter electronics failure

Possible Cause:

- Failure of electronics

Corrective Action:

- Contact your nearest Yokogawa sales office

7.3 Causes of Abnormal Measured Values

If error messages do not occur, but measured values seem incorrect, check the following:

- Are proper standard solutions used?
- Is the sensor connected to the meter securely?
- Are air bubbles trapped in the electrode tip?
- Has the electrode dried out?
- Is the electrode dirty?
- Is the sensor damaged or dirty?
- Is the electrode immersed in the sample solution properly?
- Has the level of the electrode filling solution dropped (for KCl refillable type sensors)?
- Is the electrode filling solution contaminated with the sample solution (for KCl refillable type sensors)?
- Has the actual temperature of the solution been set properly (for a needle type or test tube size pH sensor)?

7.4 Other Conditions

- **An alarm sounds**

The alarm is set to sound at the preset alarm time. Refer to Section 5.3 (7), “Alarm time setting (ALM) panel.”

- **Beeps**

The beep sound to acknowledge a key press can be enabled/disabled. Refer to Section 5.3 (9), “Set beep on/off (bZ.o) panel.”

- **CHECK SENSOR appears**

This indicates that the electrode has deteriorated. The electrode may be used continuously even after this mark appears. If a Err 2 or Err 3 message appears in addition to this mark, however, replace the sensor with a new one immediately.

This mark will also appear when deteriorated or poor quality standard solutions are used for calibration, when dirt or deposits are present on the electrode, or when calibration is performed improperly. When it appears, perform acid cleaning (see Section 6.2) and recalibrate using fresh standard solutions.

If the mark remains even though there is no problem with the sensor, the calibration parameters may be incorrect. Initialize the calibration parameters to the slope of 1.000 and asymmetry potential of 0.0 mV (see Section 5.3(10)). Then calibrate the PH71.

- **MAN appears**

This does not indicate any failure if a sensor without a built-in temperature element (a needle type or test tube size pH sensor) is used. If this mark appears, manually set the temperature of a solution (see Section 5.3 (2)).

7. Troubleshooting

If it appears even though a sensor with a built-in temperature element is used, the temperature measuring circuit may have broken. In this case the meter performs temperature compensation assuming that the solution temperature is 25°C.

Therefore, the bigger the difference between the actual temperature of the solution and 25°C, the bigger the error between the displayed measured value and the true value. For reliable measurement replace the sensor with a good one.

This mark will also appear if the sensor is not connected properly. Make sure that the connectors are securely connected.

8. ORP Meter

8.1 ORP Measurement

Use a dedicated ORP sensor for ORP (oxidation-reduction potential) measurement. The ORP sensor is a KCl refillable type with a platinum sensing electrode and looks the same as a KCl refillable type pH sensor. The measuring temperature range of the ORP sensor is 0 to 80°C, the same as that of the pH sensor.

- The default setting for measurement unit of the Model PH72 Personal pH/ORP Meter is pH. Press **F/ENT** key and follow the procedure described in Section 5.3 (3), "Set measurement unit (PV.U) panel" to move to the display with mV unit.

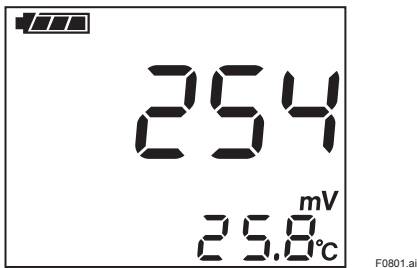

Figure 8.1 Example of Displayed ORP Value

- Immerse the sensor in a sample solution and read after the reading has stabilized.
- To hold a measured value, press **HOLD** key. Press **DATA** key to save a measured value (see Section 3.4).

Note: Unlike pH sensors, ORP sensors do not require calibration. A temperature element incorporated in an ORP sensor is used for measuring the temperature of a solution, e.g., measuring the temperature of a check solution during sensor check (see Section 8.3).

8.2 Maintenance of ORP Sensors

Maintenance of ORP sensors is in accordance with that of pH sensors (refer to Chapter 6, "Maintenance").

Cleaning the Platinum Electrode and Liquid Junction

Dirt or deposits on the platinum electrode or liquid junction may interfere with accurate measurement. Periodical cleaning is required depending on the nature of the solution being measured.

As in the same manner for pH sensors, use a cotton swab or brush to clean (see Section 6.2). If the potential is outside the tolerance after the sensor check has been performed according to the procedure in Section 8.3, clean the platinum of the sensing electrode.

Polish the platinum using a cream cleanser, alumina powder, or baking soda (sodium bicarbonate), and then wash with water.



CAUTION

Do not apply physical shock or excessive force to the glass sensor, or it may break.

Replenishment of Electrode Filling Solution

When the level of KCl filling solution drops, replenish following the procedure in Section 6.6.

8.3 Checking the ORP Sensor

Use a check solution to verify that the ORP sensor operates properly. The oxidation-reduction potential of the check solution to be used should have been correctly determined by a normal ORP sensor. The following explains how to check an ORP sensor using a quinhydrone reagent (spare part).

Preparing a Quinhydrone Solution

Prepare a 250 mL solution in a wide mouthed bottle by dissolving one pack of quinhydrone reagent in deionized water. If the temperature of deionized water is low, the reagent may not be dissolved completely and some powder may float on the surface of the solution. This will not affect the ability of the solution. A quinhydrone solution may change with time, so it should be prepared and used within the same day.

Procedure

- (1) Pour 50 to 100 mL of the prepared check solution into a clean container (200 mL).

- (2) Rinse off the remaining sample solution, if any, from the electrode with water and then wipe off water drops.
- (3) Immerse the electrode tip in the check solution and wait until the reading has stabilized. This should take 5 to 10 minutes.
- (4) Read the mV value and solution temperature. The mV reading at the solution temperature must be within the tolerance (640 mV) shown in Figure 8.2. If it falls within the tolerance, the sensor is normal. If not, clean the sensor following the procedure in Section 8.2.

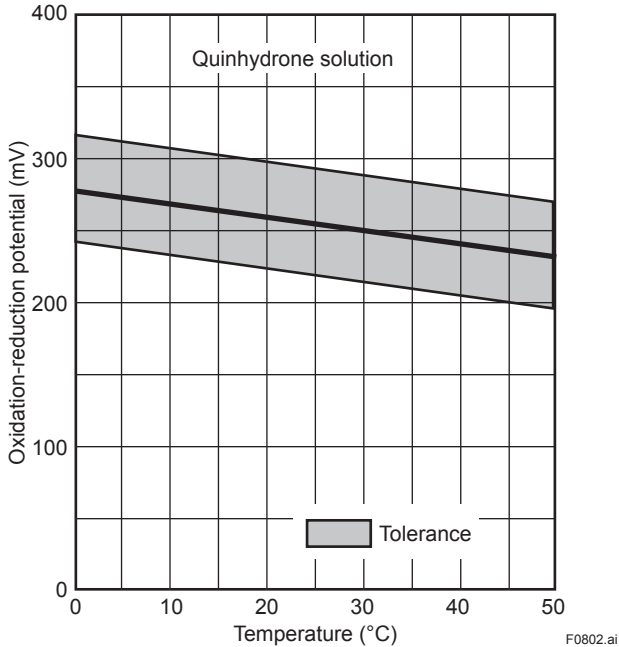

Figure 8.2 Oxidation-Reduction Potential of Check Solution

8. ORP Meter

9. Technical Information

9.1 Measurement Principle of pH Meter (Glass Electrode Method)

A pH meter makes use of the potential difference developed between the two sides of a thin glass membrane that separates two solutions with different pH. Figure 9.1 shows the schematic diagram of the measurement principle. A glass electrode is filled with a pH 7 solution and has an inner electrode that measures the potential difference corresponding to the pH difference between the internal solution and the test solution. A reference electrode has a constant potential irrespective of the pH of the test solution, which is supported by potassium chloride (KCl) solution. It prevents the reference electrode from making contact with the test solution but itself has electrical contact with the test solution through the liquid junction. A voltmeter measures the potential difference between the electrodes. As the membrane resistivity is high (several 10 to 100 M Ω), the voltmeter with high input impedance is required. The external leak resistance should also be sufficiently high (10¹² Ω or greater).

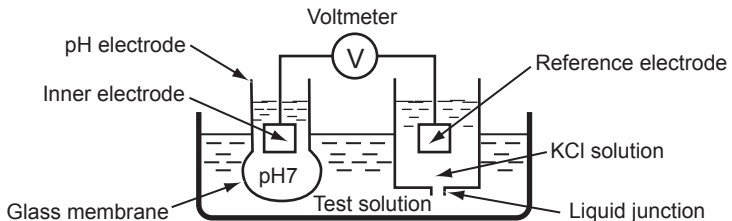

F0901.ai

Figure 9.1 Measurement Principle of pH Meter

9.2 Relationship between EMF of Glass Membrane and pH Value

The relationship between the potential difference (electromotive force) developed across the glass membrane and the pH value had been studied and the theoretical values were determined. Actual values, however, do not match the theoretical values due to manufacturing variations or deterioration with time. Therefore, a pH meter must be calibrated using standard solutions.

The emf of a glass electrode is affected by temperature. To compensate for this temperature effect is called “temperature compensation” which is essential for pH measurement.

Figure 9.2 shows the diagram of glass electrode membrane. Both membrane surfaces in contact with solutions are hydrated and the hydrogen ion activity in these hydrated layers is constant. A boundary potential develops depending on the ratio of the hydrogen ion activities of the hydrated layer and of the solution. This boundary potential, e_i , is expressed from the Nernst equation as follows.

$$e_i = - \frac{2.3026 R T}{F} \text{pH}_i + C_i \text{ (internal solution side) } \dots\dots\dots (9.1)$$

$$e_s = - \frac{2.3026 R T}{F} \text{pH}_s + C_s \text{ (sample solution side) } \dots\dots\dots (9.2)$$

- Where: R : gas constant, 8.3145 [J/(mol·K)]
- T : absolute temperature (t [°C]+273.15) [K]
- F : Faraday constant, 9.6485 x 10⁴ [C/mol]
- C_i : potential at interface between glass and internal solution
- C_s : potential at interface between glass and sample solution

Given the potential at internal solution side is reference, the difference across the membrane e_g is:

$$e_g = e_s - e_i = \frac{2.3026 R T}{F} (\text{pH}_i - \text{pH}_s) + (C_s - C_i) \dots\dots\dots (9.3)$$

To determine the difference of membrane potentials, two inner electrodes are incorporated in a glass electrode and a reference electrode and the difference in potential at two electrodes is measured by a pH converter with high input impedance. This potential difference E_g is expressed as follows when the difference of single electrode potential of the two inner electrodes and $C_s - C_i$ in equation 9.3 are collectively represented by E_{AS} .

$$E_g = \frac{2.3026 R T}{F} (\text{pH}_i - \text{pH}_s) + E_{AS} \dots\dots\dots (9.4)$$

$$E_g = (54.20 + 0.1984 t) \times (\text{pH}_i - \text{pH}_s) + E_{AS} \dots\dots\dots (9.5)$$

9. Technical Information

In the equation, pH_i is the pH buffer solution filled in the glass electrode so the pH should be constant. Using a solution (pH standard solution) with known pH as pH_s at a certain temperature, the relationship between millivolt and pH can be determined, thereby the pH can be directly derived from the membrane potential difference, as shown in Figure 9.3.

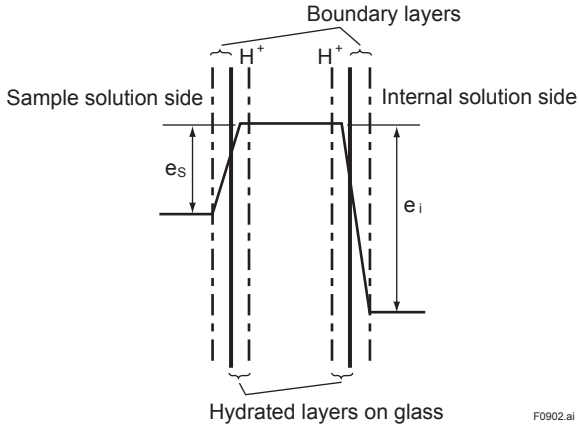

F0902.ai

Figure 9.2 Diagram of Glass Membrane

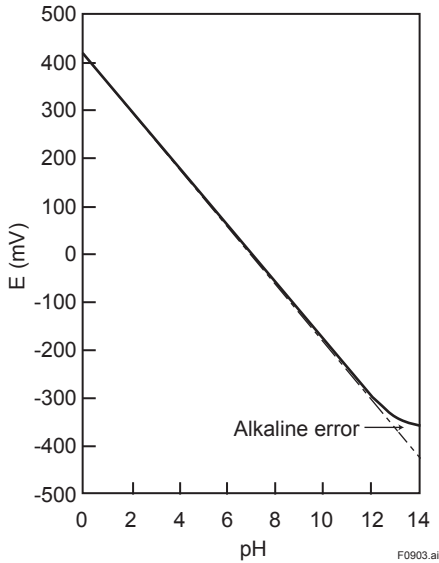

F0903.ai

Figure 9.3 Relationship between Glass Electrode Potential and pH

9.3 Temperature Compensation

In equation 9.3, $2.3026RT/F$ represents the emf per pH unit and varies depending on temperature.

Table 9.1 EMF per pH (values of $2.3026RT/F$)

Temperature (°C)	2.3026RT/F (mV)	Temperature (°C)	2.3026RT/F (mV)	Temperature (°C)	2.3026RT/F (mV)
0	54.20	35	61.14	70	68.09
5	55.19	40	62.14	75	69.08
10	56.18	45	63.13	80	70.07
15	57.18	50	64.12	85	71.07
20	58.17	55	65.11	90	72.06
25	59.16	60	66.11	95	73.05
30	60.15	65	67.10	100	74.04

Table 9.1 presents the relationship between the temperature and the emf per pH unit, and the relationship between the pH and the emf at each temperature is shown in Figure 9.4. Measurement without temperature compensation will result in measured pH values including errors as shown in Table 9.2.

The PH71 meter automatically modifies the calibration line according to the temperature measured by the temperature element incorporated in an electrode (except needle type and test tube size pH sensors).

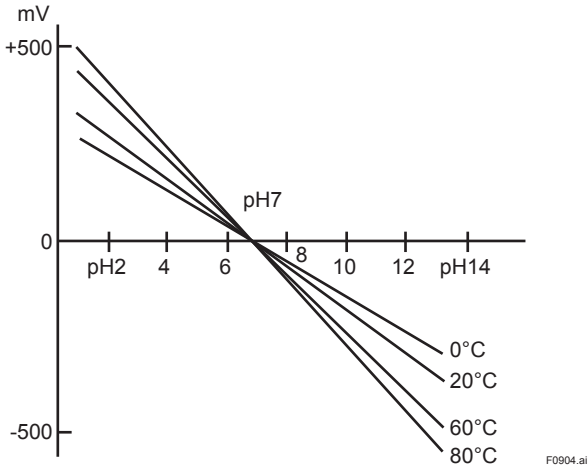

Figure 9.4 pH vs EMF at Each Temperature

Table 9.2 Deviations from True Values in Measurement without Temperature Compensation

pH	Temp.(°C)					
	0	20	25	40	60	80
1	0.50	0.10	0.00	-0.30	-0.70	-1.11
3	0.34	0.07	0.00	-0.20	-0.47	-0.74
5	0.17	0.03	0.00	-0.10	-0.23	-0.37
7	0.00	0.00	0.00	0.00	0.00	0.00
9	-0.17	-0.03	0.00	0.10	0.23	0.37
11	-0.34	-0.07	0.00	0.20	0.47	0.74
13	-0.50	-0.10	0.00	0.30	0.70	1.11

In addition, the pH value of a solution changes with temperature. The pH value of a solution at the actual temperature may be converted into the one at a reference temperature. This is generally called "conversion to reference temperature," which is different from the temperature compensation.

9.4 The Asymmetry Potential

Theoretically when identical buffer solutions ($pH_i = pH_S$) are present on both sides of the membrane of a glass electrode, the emf should be 0 mV. In reality, some potentials ($C_S - C_i$) develop depending on the thickness of the glass membrane, heat treatment process, service history, or other factors. This is called the real asymmetry potential. In addition to this potential, the difference in single electrode potential between the inner electrodes of the glass electrode and of the reference electrode and a liquid junction potential* are collectively referred to as the apparent asymmetry potential or just the asymmetry potential. This asymmetry potential is E_{AS} in equation 9.4.

* Liquid junction potential occurs due to dirt or clogging of the liquid junction or other factors.

9.5 The Alkaline Error

As shown in Figure 9.5, the emf of a glass electrode deviates from the linear value on the alkaline side. This is called the alkaline error. The magnitude of the alkaline error varies depending on the glass membrane compositions. The alkaline error is likely to occur with the presence of sodium and lithium and even with the same pH, it varies depending on the types and concentrations of cations and on the temperature.

9. Technical Information

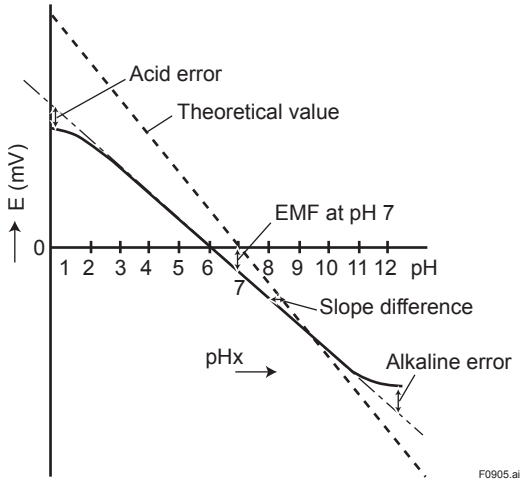

Figure 9.5 EMF Characteristics of Glass Electrode

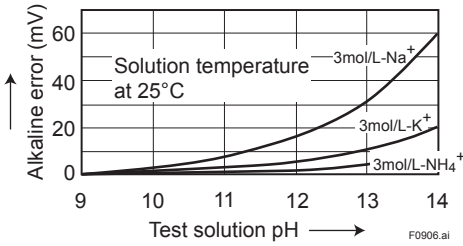

Figure 9.6 Ion Type vs Alkaline Error

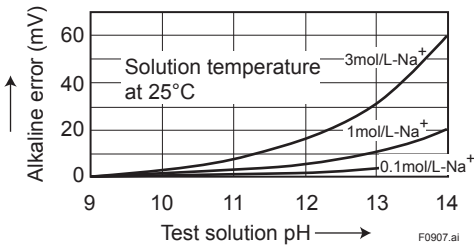

Figure 9.7 Ion Concentration vs Alkaline Error

9.6 The Acid Error

The acid error also varies depending on the glass membrane compositions and the types of acids. It increases gradually with immersion time and finally reaches equilibrium. Once a glass electrode has the acid error, it cannot recover soon even by being soaked in a neutral solution and needs considerable time. Practically, the acid error is small compared to the alkaline error so that it is negligible.

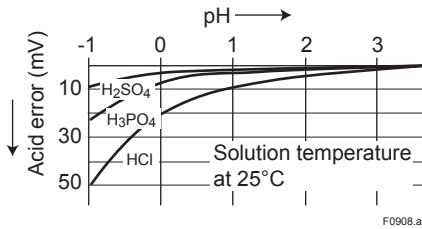

Figure 9.8 Acid Type vs Acid Error

9.7 Calibration Calculation

The PH71 meter is calibrated at 2 points using 2 standard solutions. The first calibration is done so a certain line is drawn through the calibration point (Figure 9.9). The second calibration is done so a line is drawn through the first and second calibration points (Figure 9.10). One-point calibration is a simplified method where only the first calibration of 2-point calibration is performed.

Note: A calibration point is the emf corresponding to the pH value of a standard solution used (refer to Table 4.1).

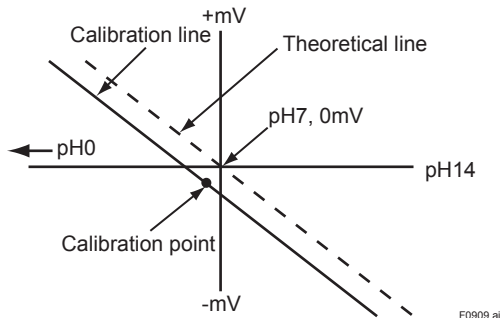
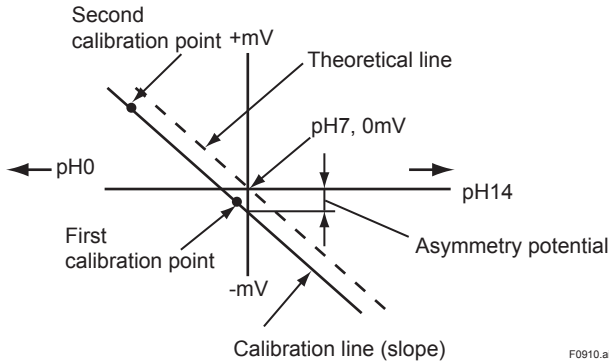

Figure 9.9 Calibration at First Point

9. Technical Information



F0910.ai

Figure 9.10 Calibration at Second Point

9.8 ORP (Oxidation-Reduction Potential)

In general, oxidation is the gain of oxygen or the loss of hydrogen, and reduction is the loss of oxygen or the gain of hydrogen. In the electrochemistry field, oxidation is defined as the loss of electrons and reduction is defined as the gain of electrons. These reactions are reversible and expressed as follows:



where Ox is the oxidized form of substance, Red is the reduced form of substance, e^{-} is an electron, and n is the number of electrons transferred. If an inert electrode (not react with substances in a solution or not corroded by a solution, e.g., platinum or gold) is immersed in a solution where oxidized and reduced forms of substances are present, the electrode will acquire the potential that corresponds the ratio of activities of both forms of substances and reaches its equilibrium. This potential is called the oxidation-reduction potential (ORP). The ORP, E in millivolts, between the indicator electrode and the reference electrode is expressed from the Nernst equation as follows.

$$E = E^{\circ} + \frac{R T}{n F} \ln \frac{[\text{Ox}]}{[\text{Red}]} \dots\dots\dots (9.6)$$

- Where: E : oxidation-reduction potential when potential of standard hydrogen electrode* is 0
- E° : standard electrode potential when $[\text{Ox}] = [\text{Red}]$
- R : gas constant
- F : Faraday constant
- n : number of electrons
- T : absolute temperature
- $[\text{Ox}]$: activity of oxidized form of substance
- $[\text{Red}]$: activity of reduced form of substance

* Standard Hydrogen Electrode (SHE)

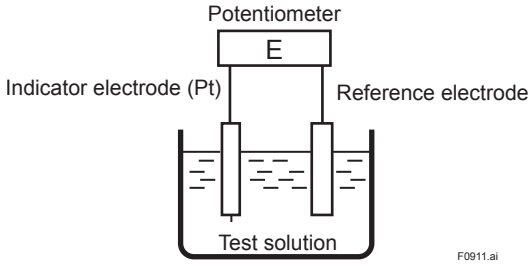

F0911.ai

Figure 9.11 Measurement System of ORP Meter

9.9 Reference Electrode

The oxidation-reduction potential in measurement is a value relative to the reference electrode. If different types of reference electrodes are used, the oxidation-reduction potentials of identical solutions are apparently different. In the electrochemical field, the hydrogen electrode is generally used as a reference electrode. However, it has complicated construction and is impractical. Therefore, in Yokogawa's ORP sensors, an Ag/AgCl electrode filled with a 3.3 mol/L KCl solution is used as a reference electrode.

The relationship between the Ag/AgCl electrode and the standard hydrogen electrode can be derived from the Nernst equation based on the following cell scheme.

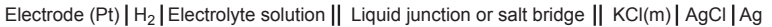

The reaction formula is $\text{AgCl} + e^- \rightleftharpoons \text{Ag} + \text{Cl}^-$, if α represents the activity, from equation 9.6

$$E = E^\circ + \frac{RT}{nF} \ln \frac{[\text{Ox}]}{[\text{Red}]} \dots\dots\dots (9.6)$$

- Where: E : oxidation-reduction potential when potential of standard hydrogen electrode* is 0
- E° : standard electrode potential when [Ox] = [Red]
- R : gas constant
- F : Faraday constant
- n : number of electrons
- T : absolute temperature
- [Ox] : activity of oxidized form of substance
- [Red] : activity of reduced form of substance

* Standard Hydrogen Electrode (SHE)

E'_{AgCl} can be obtained using the average ion activity coefficient, $\gamma_{\pm\text{KCl}}$, of the KCl (m) solution instead of the activity coefficient of Cl^- (actual measurement is impossible).

$$E'_{\text{AgCl}} = E^\circ - \frac{RT}{F} \ln m_{\text{KCl}} \gamma_{\pm\text{KCl}} \dots\dots\dots (9.7)$$

9. Technical Information

The relationship of the molality m , molarity c , activity coefficient at molality γ_{\pm} , and activity coefficient at molarity y_{\pm} , is as follows.

$$m = \frac{c}{d - 0.001 c W} \dots\dots\dots (9.8)$$

$$y_{\pm} = \frac{m d_0}{c} \gamma_{\pm} \dots\dots\dots (9.9)$$

- m : molality [mol/kg]
- c : molarity [mol/L] or [M]
- d : density of solution [g/cm³]
- W : molecular weight of solute
- d_0 : density of solvent [g/cm³]
- γ_{\pm} : activity coefficient at molality
- y_{\pm} : activity coefficient at molarity

From equations 9.7 and 9.9,

$$E'_{AgCl} = E^{\circ} - \frac{R T}{F} \ln \frac{c y_{\pm}}{d_0} \dots\dots\dots (9.10)$$

Obtained from equation 9.10, the potential of the Ag/AgCl electrode filled with a 3.3 mol/L KCl solution, E'_{AgCl} , has the temperature characteristic for the standard hydrogen electrode as shown in Figure 9.12.

To convert E'_{AgCl} to the value for the standard hydrogen electrode,

$$E_{SHE} = E + E'_{AgCl} + E_j \quad [mV] \dots\dots\dots (9.11)$$

- E_{SHE} : oxidation-reduction potential when reference electrode is SHE
- E : oxidation-reduction potential when reference electrode is Ag/AgCl electrode filled with 3.3 mol/L KCl solution
- E'_{AgCl} : potential of Ag/AgCl electrode filled with 3.3 mol/L KCl solution (vs SHE)
- E_j : liquid junction potential (average liquid junction potential between KCl and test solution is approximately 3 mV)

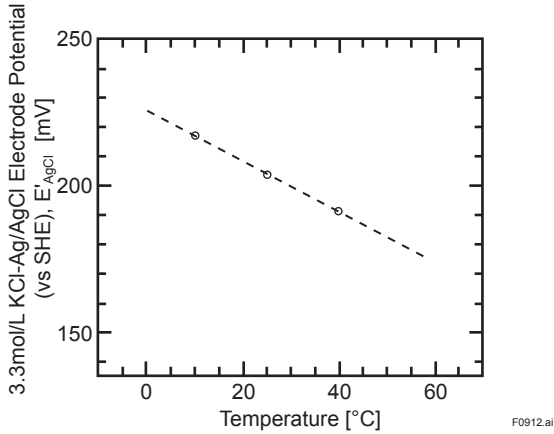

Figure 9.12 Temperature Characteristic of Potential of Ag/AgCl Electrode with 3.3 mol/L KCl, E'_{AgCl} (vs SHE)

9.10 Wetted Part Materials of Sensors

- **General pH Sensors**

Polypropylene resin (sensor body, protective cover)

Glass (glass electrode, temperature element protective tube)

Ceramics (liquid junction)

Silicon rubber (sensor seal)

- When cable is immersed (KCl replenish-free type)

Rigid polyethylene (sensor grip)

PVC (sensor cable)

Ethylene propylene rubber (sensor grip, cable connection)

- **Needle type pH sensor**

Glass (sensor)

- **Test tube size pH sensor**

Glass (sensor)

- **ORP sensor**

Polypropylene resin (sensor body, protective cover)

Platinum (electrode)

Glass (glass electrode, temperature element protective tube)

Ceramic (liquid junction)

Silicon rubber (sensor seal)

9.11 References

- JIS Z8802-1984, *Methods for Determination of pH of Aqueous Solutions*
- Moore, W. J., *Basic Physical Chemistry*, Prentice-Hall, Inc., U.S.A. 1983
- Donald, Andrzej, Julian, *Electrochemistry for chemists 2nd Ed.*, Maruzen 2003
- Bates, R. G., *Determination of pH: theory and practice 2nd Ed.*, John Wiley & Sons, Inc., 1973

Appendix

• Function Mode

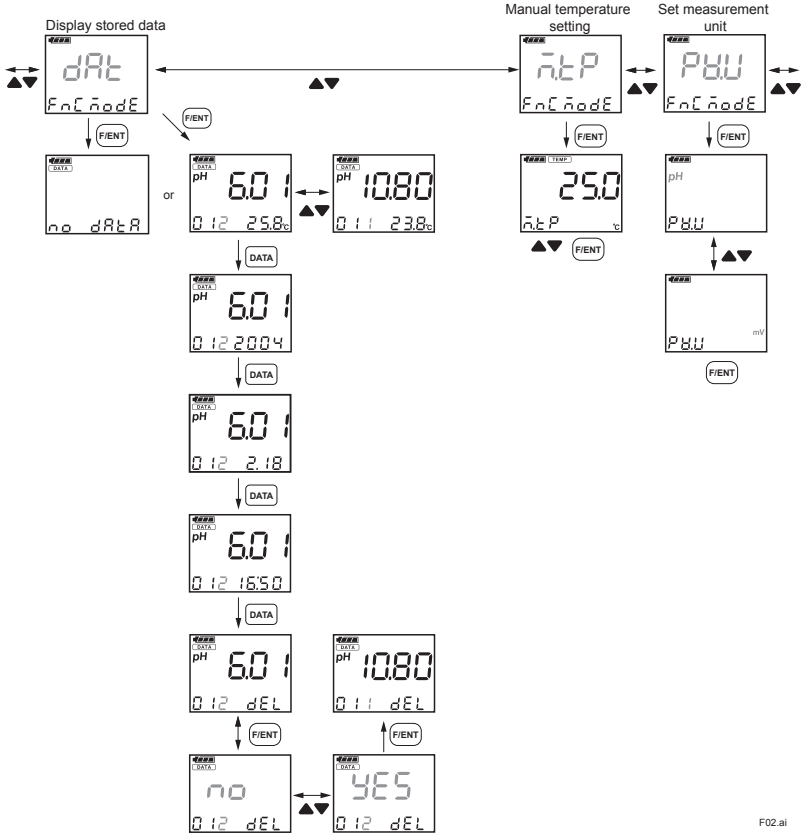

F02.ai

● Function Mode

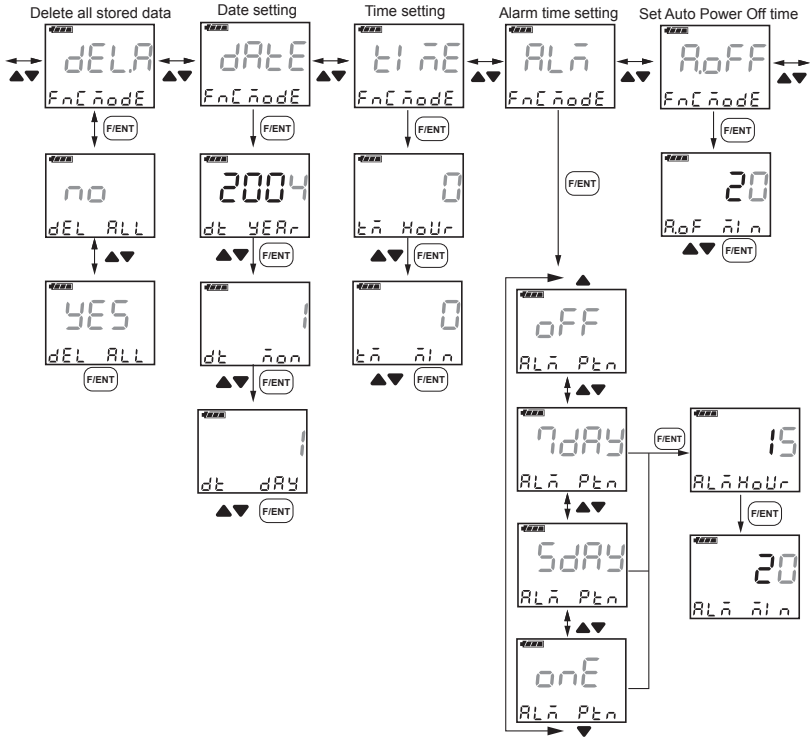

● Switching to Function Mode

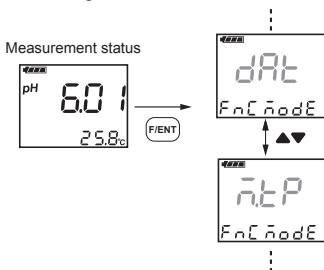

● Reverting to Measurement Mode

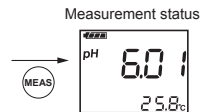

F03.ai

Appendix

• Function Mode

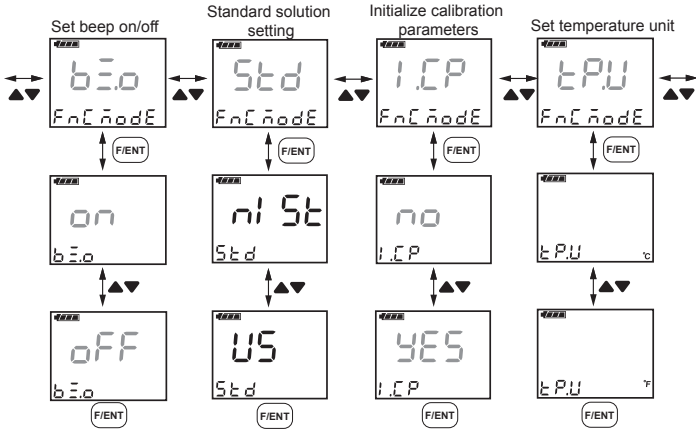

• Function Mode

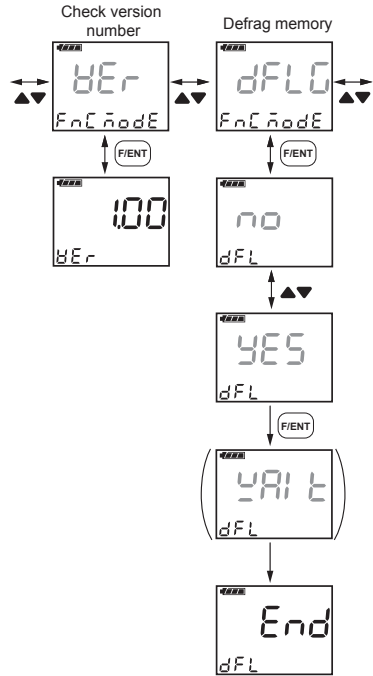

F04.ai

● Calibration

Automatic calibration & Manual calibration

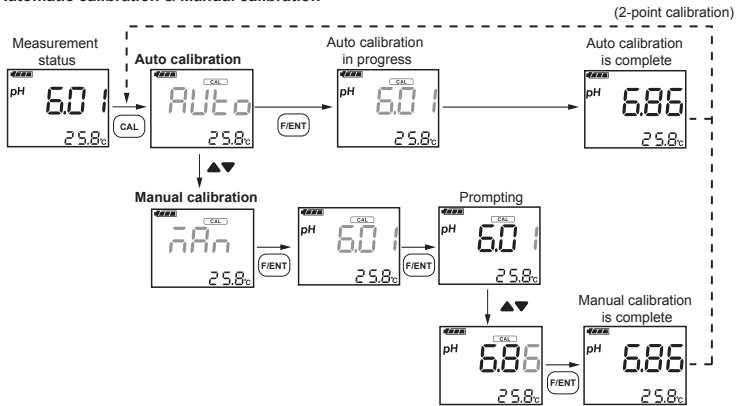

Automatic calibration for needle type or test tube size pH sensor

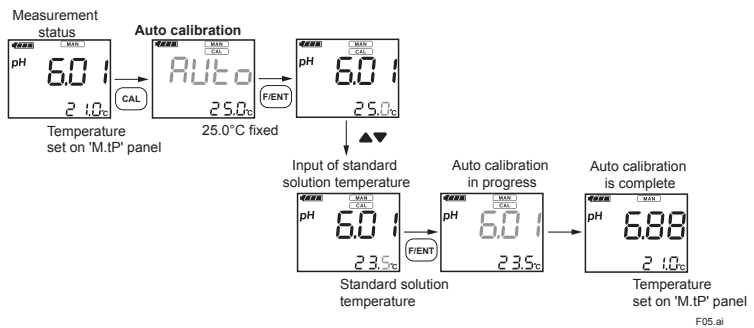

Revision Record

Manual Title : Model PH72 Personal pH/ORP Meter

Manual Number : IM 12B03D02-01E

Edition	Date	Remark (s)
7th	Apr. 2023	Corrected *1 footnote: P.1-3
6th	Jan. 2023	Added UKCA mark, and changed description: P.iv Added Morocco/EMC and EAC certification standard: P.1-3
5th	June 2021	Revised RoHS conformity standards, etc.: P.1-3, 1-5 Addition of Section 6.5: P.6-3
4th	Mar. 2020	Change of accessories, deletion of optional accessories, move MSDS (SDS) to site, revision of specifications, etc., full review
3rd	Aug. 2009	Change of information on EMC compliance: P.1-2
2nd	Apr. 2008	Addition of information on EMC compliance: P.1-2 Addition of CAUTION: P2-2 Correction: P.1, 1-2, 1-6, 2-1, 2-5, 3-1, 5-4, 6-1. 7-6, 8-3, 9-4, 9-6, 9-7
1st	Oct. 2004	Newly published