

**YASKAWA**

# MV1000

MEDIUM VOLTAGE AC DRIVE



## Product Range

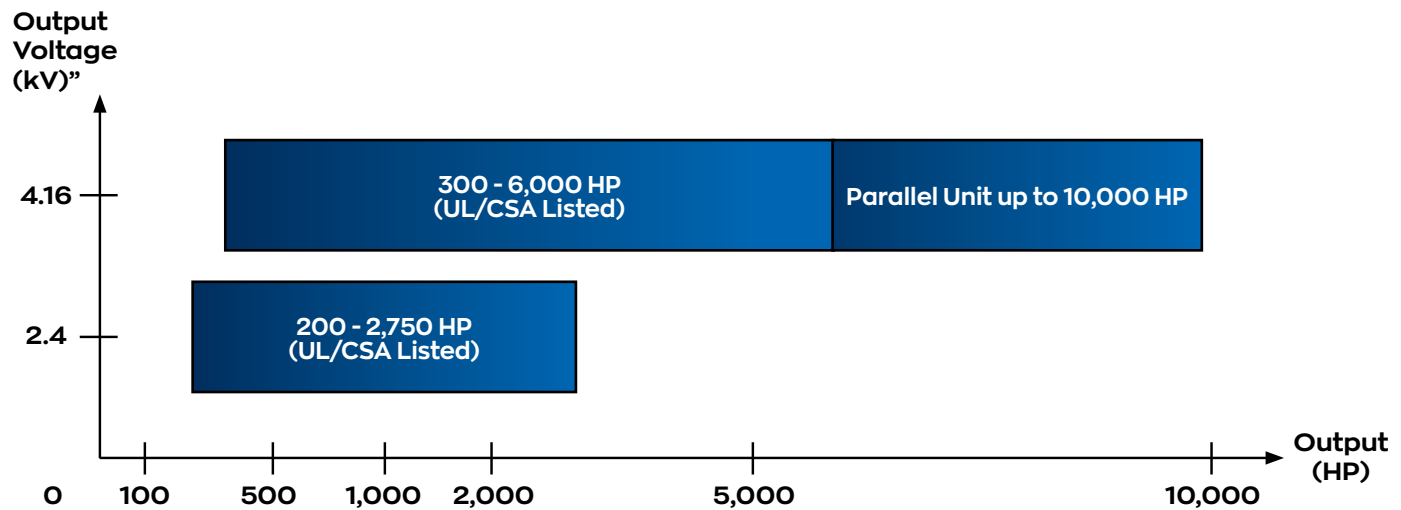

\* 4.16 kV output drives available with 13 kV supply.

Additional input voltages (up to 13 kV) are available upon request.

## COMMON SPECIFICATIONS

Item		Specifications
Control Characteristics	Control Methods	V/f Control (V/f), Open Loop Vector Control (OLV), Closed Loop Vector Control (CLV)
	Frequency Control Range	0.01 to 120 Hz
	Frequency Accuracy (Temperature Fluctuation)	Digital input: within $\pm 0.01\%$ of the max output frequency ( $-10^{\circ}\text{C}$ to $+40^{\circ}\text{C}$ ) Analog input: within $\pm 0.5\%$ of the max output frequency ( $-10^{\circ}\text{C}$ $\pm$ $40^{\circ}\text{C}$ )
	Frequency Setting Resolution	Digital inputs: 0.01 Hz Analog inputs: 1/2048 of the maximum output frequency setting (11 bit plus sign)
	Output Frequency Resolution	0.001 Hz
	Frequency Setting Methods	0 to +10 V, 4 to 20 mA (standard), Network
	Starting Torque	V/f: 130% at 3 Hz, OLV: 130% at 0.3 Hz, CLV: 130% at 0 r/min
	Speed Control Range	V/f: 1:20, OLV: 1:100, CLV: 1:1000
	Speed Control Accuracy	V/f: $\pm 2$ to 3%, OLV: $\pm 0.5\%$ , ( $25^{\circ}\text{C}$ $\pm$ $10^{\circ}\text{C}$ ), CLV: $\pm 0.02\%$ ( $25^{\circ}\text{C}$ $\pm$ $10^{\circ}\text{C}$ )
	Speed Response	OLV: 10 Hz, CLV: 50 Hz
Accel/Decel Time	0.0 to 6000.0 s (4 selectable combinations of independent acceleration and deceleration settings)	
Protection Function	Motor Protection	Electronic thermal overload relay
	Momentary Overcurrent Protection	Drive stops when output current exceeds 132%
	Overload Protection	Drive stops after 60 s at 110% of rated output current
	Overvoltage Protection	Power Cell VPN > 1035 VDC
	Undervoltage Protection	Power Cell VPN < 300 VDC
	Momentary Power Loss Ride-Thru	Resumes operation if power loss is less than 2 s (standard) (UPS Required)
	Overheat Protection	Power Cell = Thermistor, Transformer = PT100 and Thermal Switch
Ground Fault Protection	Electronic circuit protection	
Operating Environment	Ambient Temperature	$-5$ to $+40^{\circ}\text{C}$ (up to $+50^{\circ}\text{C}$ with output current derate)
	Humidity	95% RH or less (no condensation)
	Storage Temperature	$-20$ to $+60^{\circ}\text{C}$ (short-term temperature during transportation)
	Altitude	Up to 2000 m without derating, up to 4000 m with output current and voltage derating
Comm. Options	Communications Protocols (Optional)	EtherNet/IP, DeviceNet, Modbus TCP/IP, Modbus RTU, PROFIBUS DP, and PROFINET

# MV1000 MEDIUM VOLTAGE AC DRIVE

Simple Robust Compact Reliable Safe Feature Packed

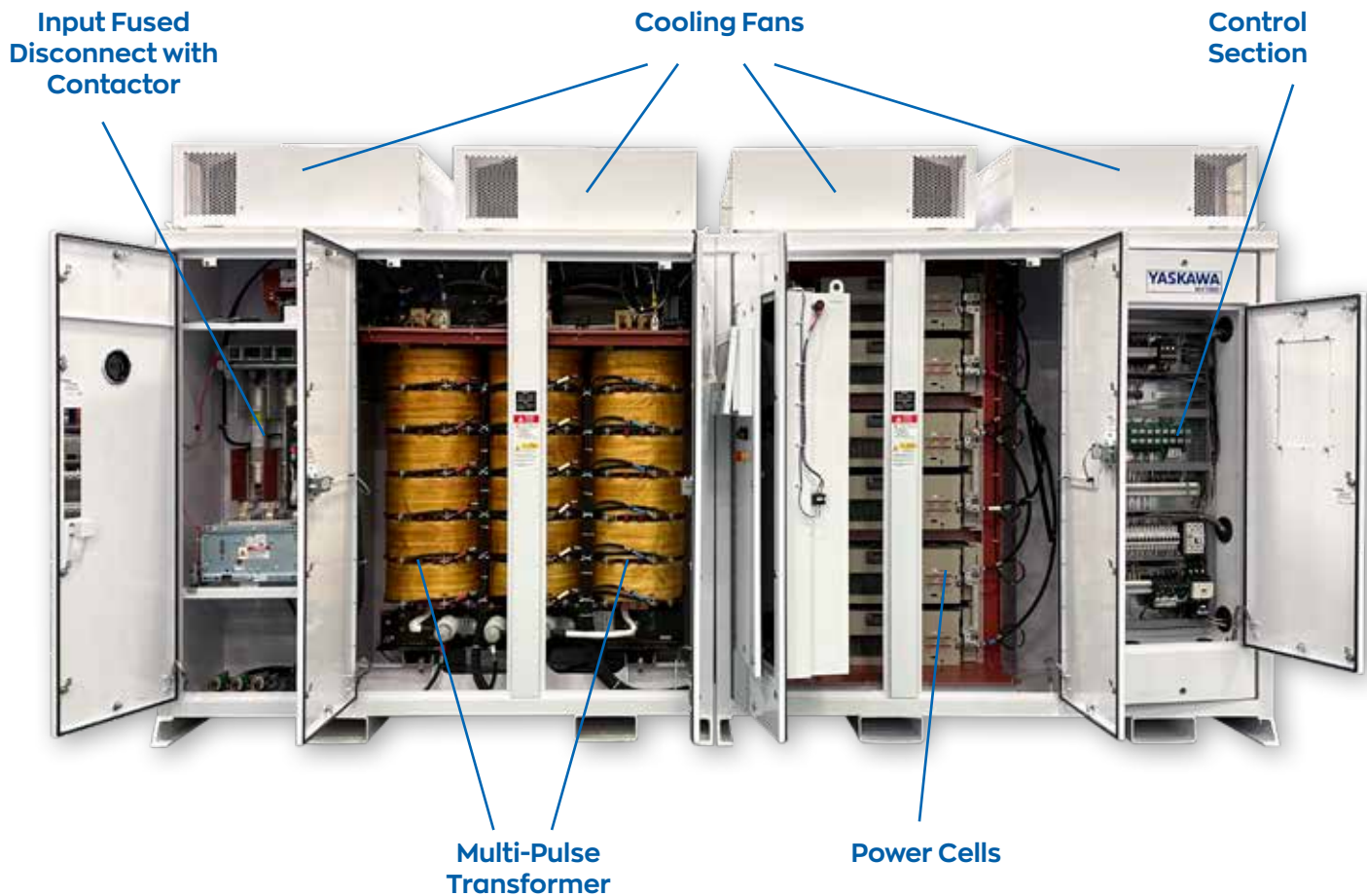

## Yaskawa Quality: Second to None

We're the only industrial drives and motion control manufacturer to win the Deming prize - the most prestigious quality award in manufacturing. Yaskawa constantly tracks and measures product failures in time (FIT). The actual FIT data demonstrates a high quality and reliability rate that is the envy of our Industry.

**Internal Assembly Failure Rate 0.01%**

**Field Assembly Failure Rate 0.0062%**



# MV1000 Features and Advantages

## Yaskawa Smart Harmonic Technology, Exceeds IEEE-519 Requirements

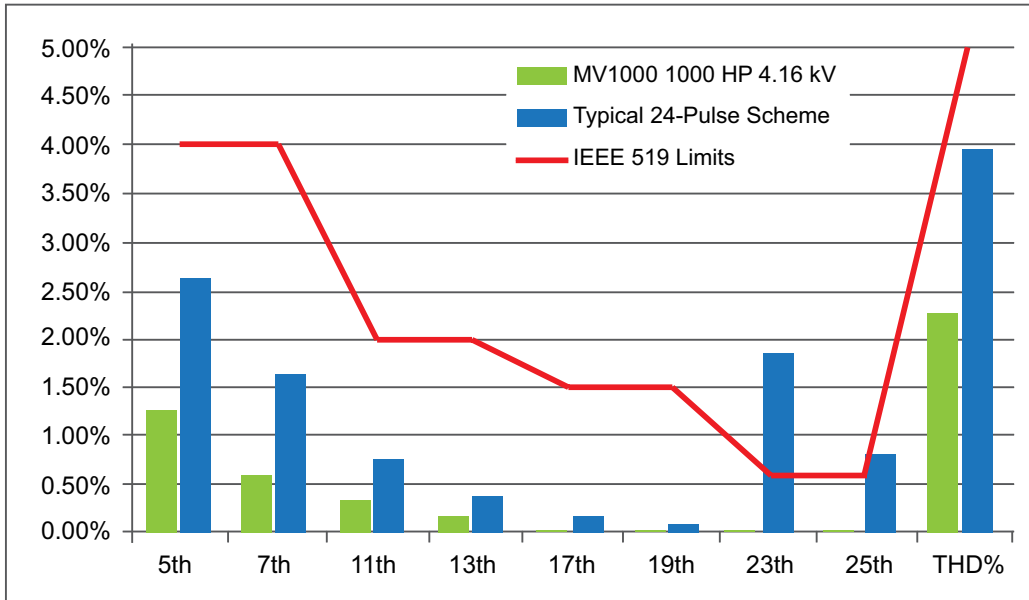

## Motor Friendly 17-Level Phase-to-Phase Waveform

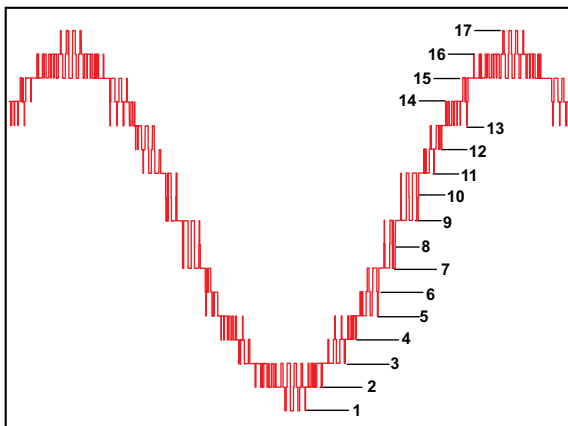

## Easy Maintenance with Modular Construction

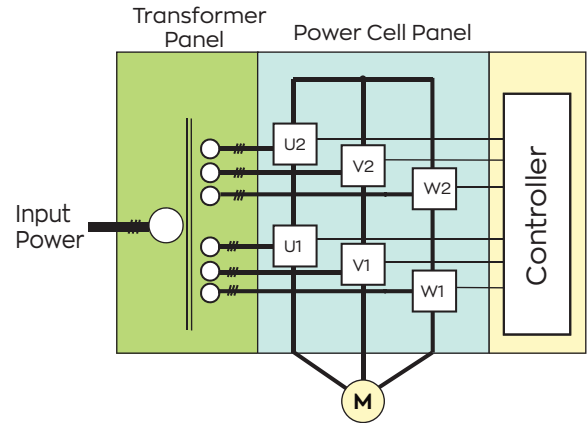

## DriveWizard Medium Voltage

- Manage parameters and drive configuration online or offline
- Connect to drive via serial or network
- Customizable User Parameter group
- Monitor and trend parameters in real time, or save to analyze offline
- Consistent interface with Yaskawa Low Voltage Drives
- View fault history log (last 50 faults)



## Advanced Features

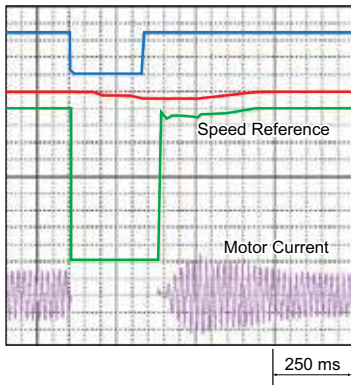

Speed Search Function

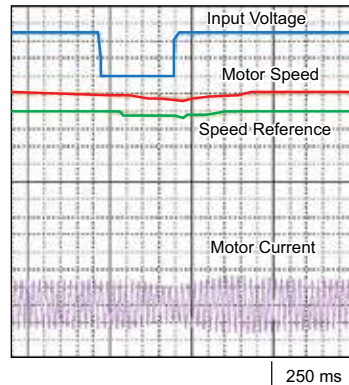

KEB Function

- Power Dip Ride Through
- Kinetic Energy Braking (KEB) Function
- Closed Transition Sync Transfer and Capture
- Speed Search
- Automatic Restart
- Auto Tuning
- Open Loop Vector
- V/Hz Control

## Synchronous Transfer from AC Source to Drive

Drive Output Voltage synchronized with Utility Supply Voltage

Smooth transfer from Drive Output Current to Utility Supply Current

Smooth sinusoidal Motor Current

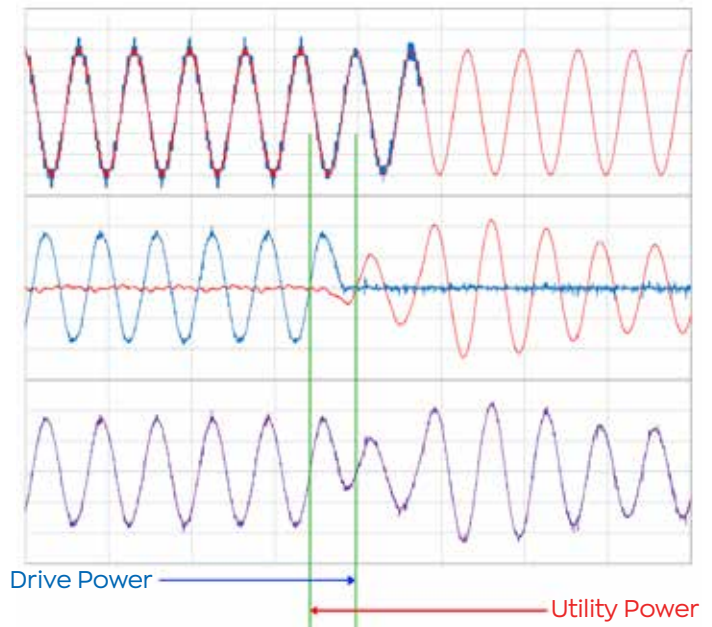

## User Friendly Digital Operator



- Plain English
- Advanced monitoring
- Real Time Clock for Event Logging
- Five (5) line LCD display
- Same keypad interface used in 1000 series LVDs
- Multiple languages



**Fiber-Optic Based Controls for High Reliability (MTBF > 200,000 Hrs)**

YASKAWA.COM



Yaskawa is the leading global manufacturer of low and medium voltage variable frequency drives, servo systems, machine controllers and industrial robots. Our standard products, as well as tailor-made solutions, are well known and have a high reputation for outstanding quality and reliability.

**YASKAWA**

**Yaskawa America, Inc.** | Drives & Motion Division

1-800-YASKAWA | Email: [info@yaskawa.com](mailto:info@yaskawa.com) | [yaskawa.com](http://yaskawa.com)

Document No. BL.MV1000.02 | 08/25/2023 | © 2015 Yaskawa America, Inc.