

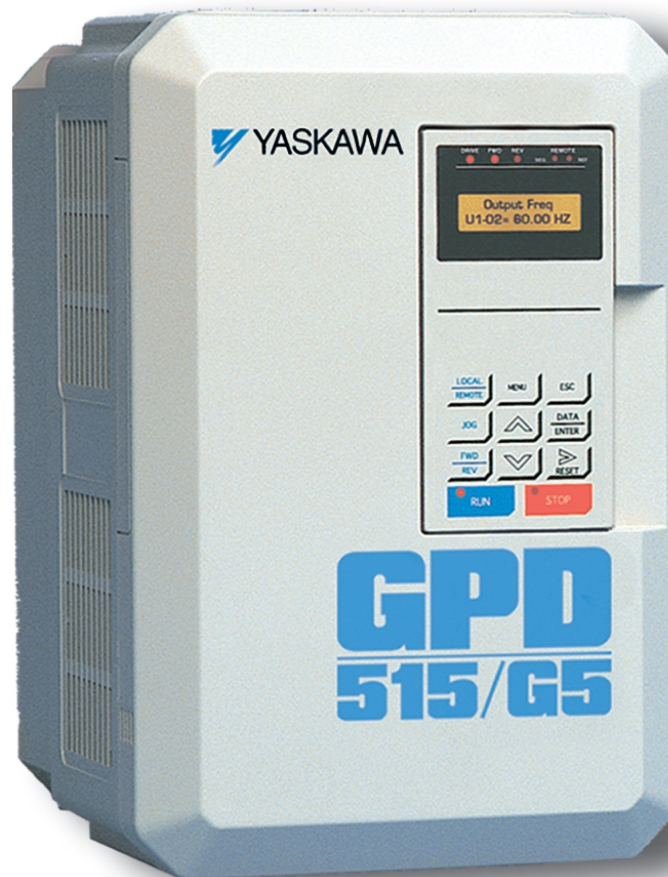

## GPD 515/G5 Drive Technical Manual



Models: GPD515C- and CIMR-G5M Document Number: TM 4515

# GPD 515/G5 Simplified Startup Procedure

This procedure is a simplified step by step guide to installing, programming, and using the GPD 515/G5 drive. It highlights several common installation configurations.

## INSTALLATION

1. Be certain your input voltage source, motor and drive nameplates are all marked either 230V, 460V, or 575 / 600V. Other voltages can be used, but require additional programming.

**CAUTION: Verify that the input voltage matches the drive's nameplate BEFORE applying power or severe damage will result.**

2. Mount drive on a vertical surface with adequate space for air circulation (4.7" above and below, 1.2" on each side)
3. Remove front cover, fit conduit to bottom plate, and connect power and ground wires as shown.

**CAUTION: BE CERTAIN YOU CONNECT INPUT POWER TO TERMINALS L1, L2, AND L3 ONLY, OR SERIOUS DAMAGE WILL RESULT. CONNECT MOTOR TO TERMINALS T1, T2, AND T3 ONLY.**

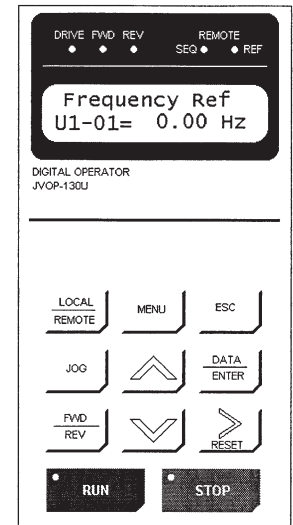

## POWER WIRING SCHEMATIC

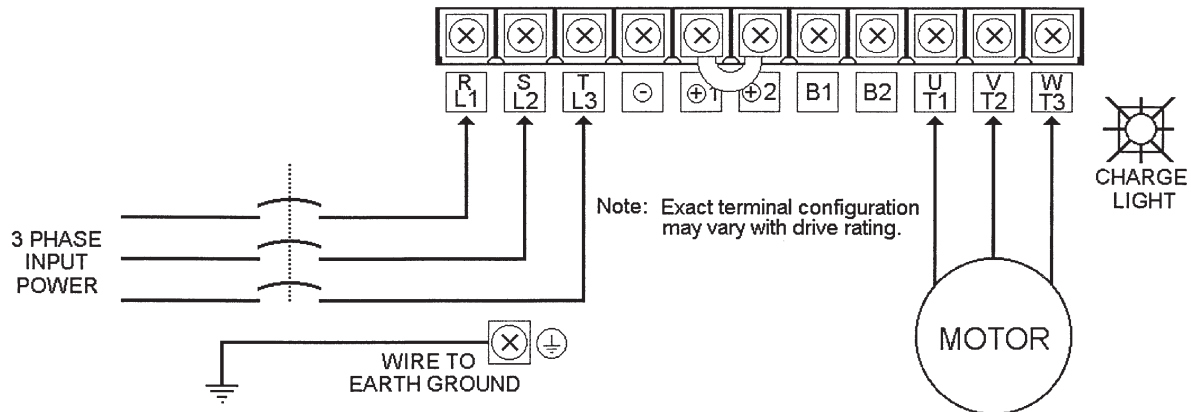

4. **Replace cover and apply input power** – digital operator shows “Frequency Ref U1-01 = 0.00 Hz”; DRIVE, SEQ, REF & STOP LEDs are on. Press the **LOCAL / REMOTE** button. The SEQ & REF LEDs should go off and the FWD LED should go on. Push the **JOG** key noting direction of motor rotation. If it is incorrect, remove power, wait for charge light to go out, then switch wires between terminals T1 and T2. Replace the front cover and apply input power.

5. **Digital Operator** – Parameters that start with an “A” (example A1-03) are found under the “Initialize” menu. Parameters that start with “b thru L” (example b1-01) are found under the “Programming” menu. Before the drive will accept a RUN command, the DRIVE LED must be on. Press the **MENU** key, then the **DATA / ENTER** key to turn the DRIVE LED on. For more specific information on the digital operator, see Section 4.
6. **Choose a configuration from Table 1 below.** Each example listed below contains a control wiring diagram, operation explanation, and all necessary programming. *The drive can be controlled in many more ways than is described in these examples.*

**Table 1: Drive Configuration Examples**

Sequence* Source (Run / Stop)	Reference* Source (Motor Speed)	Description	Example Page
Digital Operator	Digital Operator	This method requires no control wiring connections to the drive. It is most often used during startup of the drive.	Example 1 (Page iii)
2-wire	Digital Operator	With this method, the drive can be started and stopped using an external (remote) signal.	Example 2 (Page iv)
3-wire	Digital Operator	This method is the same as Example 2 above, but uses pushbuttons instead.	Example 3 (Page v)
2-wire	4-20 mA	This method is the same as Example 2, but the reference comes from a remote 4 – 20 mA source such as a PLC.	Example 4 (Page vi)
3-wire	Remote Speed Potentiometer	This method is similar to Example 3, but utilizes a remote mounted speed control potentiometer.	Example 5 (Page vii)
2-wire	0 – 10V DC with several digital presets	This method is similar to 2, but allows switching between an analog reference and three digital preset references.	Example 6 (Page viii)

\* For a more detailed explanation of sequence and reference, consult Page ix of this document.

7. **Control Terminal Wiring** – Remove power and wait for the charge light to go out before making control terminal connections. Control wiring should be sized 16 to 20 AWG. Control wiring should be shielded, with the shield wire connected to terminal 12(G), and the other end of the shield left open. As shown at right, the control terminals are arranged in two rows. The bottom row contains terminals 1 thru 8 and 21 thru 23. The top row contains terminals 11 thru 17, 25 thru 27 & 33.

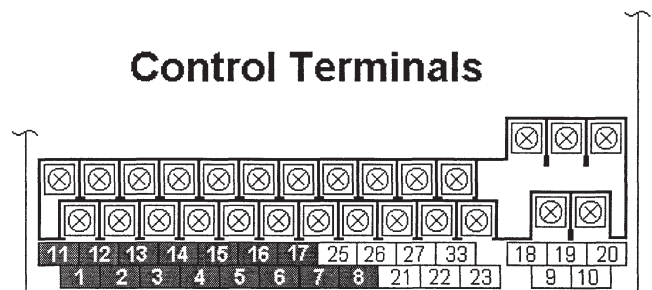

8. **Control Method** – This document assumes that the drive will be left in the open loop vector control method. For a further explanation of control method or to change the control method, consult Section 2.2.
9. **Auto-Tuning** automatically programs drive parameters in order to best match the drive to the motor. This procedure is not required, but should be done when more accurate speed regulation is needed. Consult Section 2.2a or 2.2b for details.

# Example 1: Sequence & Reference From The Digital Operator

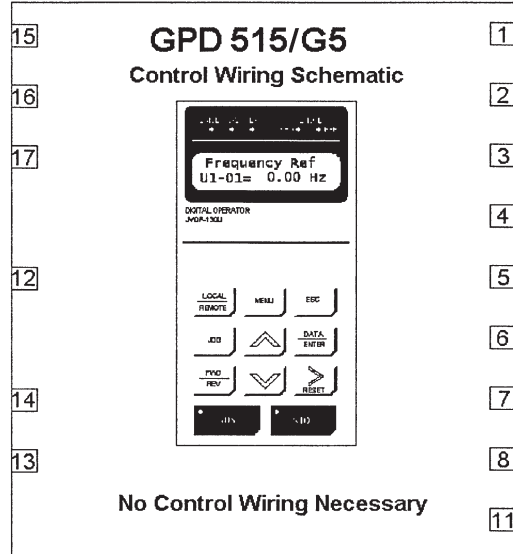

When the drive is set up with the sequence and the reference coming from the digital operator, it is in “Local” control. Local control is often used during startup to verify motor operation, rotation, etc. The drive can be temporarily placed in “Local” control simply by pressing the **LOCAL / REMOTE** key. When the drive is in “Local” control, the SEQ and REF LEDs are off. If power is removed and then restored, the drive will come up in the “Remote” mode (SEQ and REF LEDs are on).

The drive can be programmed so that even if power is lost, the drive will come up in the local mode (see Table 2 below).

## OPERATION:

- The frequency reference is programmed into parameter U1-01 (See Table 2 for details).
- The drive can be started by pressing the **RUN** key on the digital operator.
- The drive can be stopped by pressing the **STOP** key on the digital operator.
- The direction of the motor can be changed regardless of motor speed by pressing the **FWD / REV** key.
- Pressing the **JOG** key when the drive is stopped will cause the motor to run at the jog frequency reference (d1-09).

**Table 2: Programming required for “Local” mode**

Parameter	Display Text	Value	Description
b1-01	Reference Source Operator	0	Sets the frequency reference to come from the digital operator.
b1-02	Run Source Operator	0	Sets the sequence to come from the digital operator.
E2-01	Motor Rated FLA E2-01= X.XX A	User Set	Sets the motor full load amps.
U1-01	Frequency Ref U1-01= XX.XX HZ	User Set	Sets the desired frequency reference. Settable by pressing <b>MENU</b> , <b>DATA / ENTER</b> , then <b>DATA / ENTER</b> , again. Use the arrow keys to set the desired value then press <b>DATA / ENTER</b> .

NOTE: Programming steps listed above assume no prior adjustments to the drive have been made.

## Example 2: Remote Sequence (2-Wire) & Local Reference (Digital Operator)

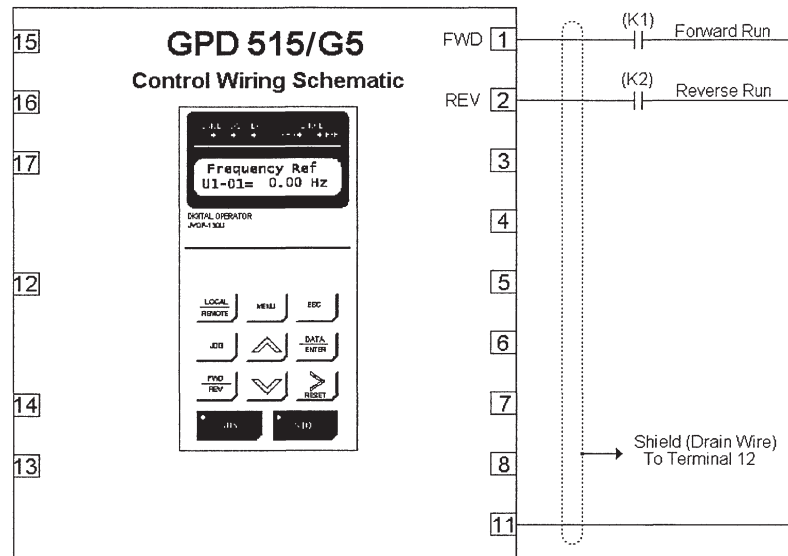

This configuration is used when the sequence comes from a remote source, such as a relay or a PLC. It can also be used with a maintained switch when it is desirable to have the drive restart on restoration of power. It should not be used where safety of attending personnel might be threatened by a restart.

### OPERATION:

- The frequency reference is programmed into parameter U1-01 (See Table 3 for details).
- Close (K1) to Run Forward at frequency set in U1-01.
- Close (K2) to Run Reverse at frequency set in U1-01.
- If both (K1) & (K2) are closed, the drive stops and displays the error message: “EF External Fault.”
- If the **LOCAL / REMOTE** key is pressed, the drive will behave the same as illustrated in Example 1.

**Table 3: Programming Required For Remote 2-wire Sequence & Local Reference**

Parameter	Display Text	Value	Description
A1-03	Init Parameters No Initialize	2220	This parameter can be found under the “Initialize” menu. <b>CAUTION:</b> Setting this value will reset all parameters to their original factory settings (all previous adjustments will be lost) <i>When the drive completes the reset, this parameter returns to 0 – “No Initialize”.</i>
b1-01	Reference Source Operator	0	Sets the frequency reference to come from the digital operator. Display will read “Reference Source Operator”
E2-01	Motor Rated FLA E2-01= X.XX A	User Set	Sets the motor full load amps.
U1-01	Frequency Ref U1-01= XX.XX HZ	User Set	Sets the desired frequency reference. Settable by pressing <b>MENU</b> , <b>DATA / ENTER</b> , then <b>DATA / ENTER</b> , again. Use the arrow keys to set the desired value, then press <b>DATA / ENTER</b> .

NOTE: After the above adjustments have been made, the DRIVE, SEQ and STOP LEDs will be illuminated.

### Example 3: Remote Sequence (3-Wire) & Local Reference (Digital Operator)

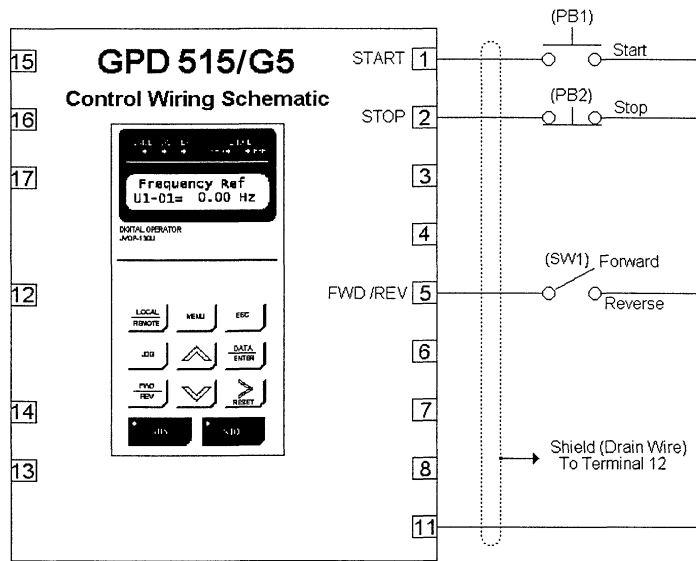

This configuration is best when a person rather than an external controller (PLC, relay, etc.) controls the drive.

#### OPERATION:

- The frequency reference is programmed into parameter U1-01 (See Table 4 for details).
- Close pushbutton (PB1) momentarily while pushbutton (PB2) is closed, and the drive will run at the frequency setting in U1-01. Pushbutton (PB1) does *NOT* need to be maintained.
- Open pushbutton (PB2) at any time and the drive will stop.
- If switch (SW1) is open, the drive will run in the forward direction. If switch (SW1) is closed, the drive will run in the reverse direction. Switch (SW1) can be operated with the drive running at any speed.
- If the **LOCAL / REMOTE** key is pressed, the drive will behave the same as illustrated in Example 1.

**Table 4: Programming Required For Remote 3-wire Sequence & Local Reference**

Parameter	Display Text	Value	Description
A1-03	Init Parameters No Initialize	3330	This parameter can be found under the "Initialize" menu. <b>CAUTION:</b> Setting this value will reset all parameters to their original factory settings (all previous adjustments will be lost) <i>When the drive completes the reset, this parameter returns to 0 – "No Initialize".</i>
b1-01	Reference Source Operator	0	Sets the frequency reference to come from the digital operator. Display will read "Reference Source, Operator"
E2-01	Motor Rated FLA E2-01= X.XX A	User Set	Sets the motor full load amps.
U1-01	Frequency Ref U1-01= XX.XX HZ	User Set	Sets the desired frequency reference. Settable by pressing <b>MENU</b> , <b>DATA / ENTER</b> , then <b>DATA / ENTER</b> , again. Use the arrow keys to set the desired value then press <b>DATA / ENTER</b> .

NOTE: After the above adjustments have been made, the DRIVE, FWD, SEQ and STOP LEDs will be illuminated.

## Example 4: Remote Sequence (2-Wire) & Remote Reference (4 – 20 mA)

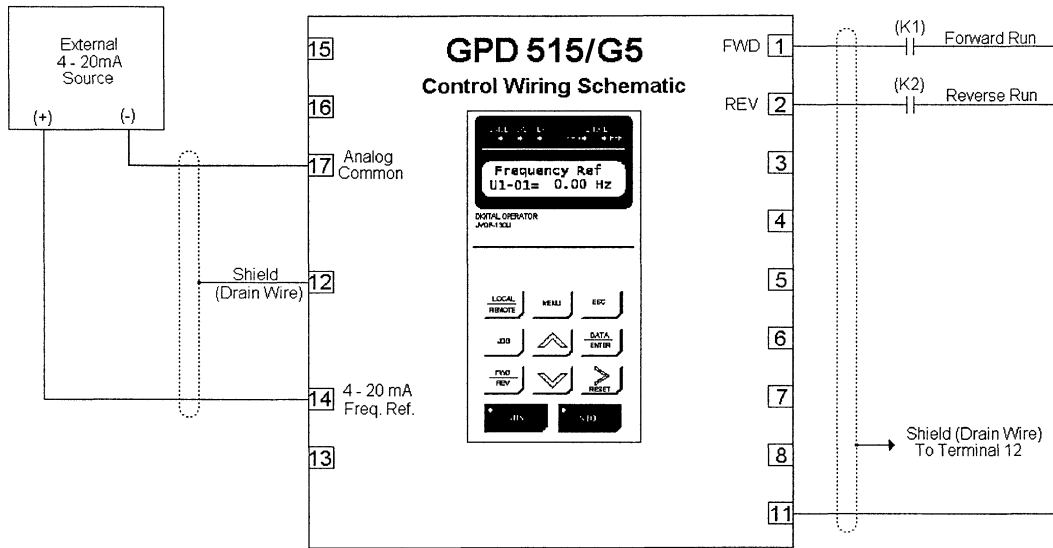

This configuration is used when the start & stop signals and the frequency reference come from a remote source, such as a PLC. It can also be used with a maintained switch when it is desirable to have the drive restart on restoration of power. It should not be used where safety of attending personnel might be threatened by a restart.

### OPERATION:

- Close (K1) to Run Forward.
- Close (K2) to Run Reverse.
- If both (K1) & (K2) are closed, the drive stops and displays the error message: “EF External Fault”.
- Frequency reference is proportional to the signal level at Terminal 14. 4mA = 0 Hz, 12mA = 30 Hz, & 20mA = 60 Hz.
- If the **LOCAL / REMOTE** key is pressed, the drive will behave the same as illustrated in Example 1.

**Table 5: Programming Required For Remote 2-wire Sequence & Remote (4-20 mA) Reference**

Parameter	Display Text	Value	Description
A1-03	Init Parameters No Initialize	2220	This parameter can be found under the “Initialize” menu. <b>CAUTION:</b> Setting this value will reset all parameters to their original factory settings (all previous adjustments will be lost) <i>When the drive completes the reset, this parameter returns to 0 – “No Initialize”.</i>
E2-01	Motor Rated FLA E2-01= X.XX A	User Set	Sets the motor full load amps.

NOTE: After the above adjustments have been made, the DRIVE, SEQ, REF and STOP LEDs will be illuminated.

## Example 5: Remote Sequence (3-Wire) & Manual Reference (Speed Potentiometer)

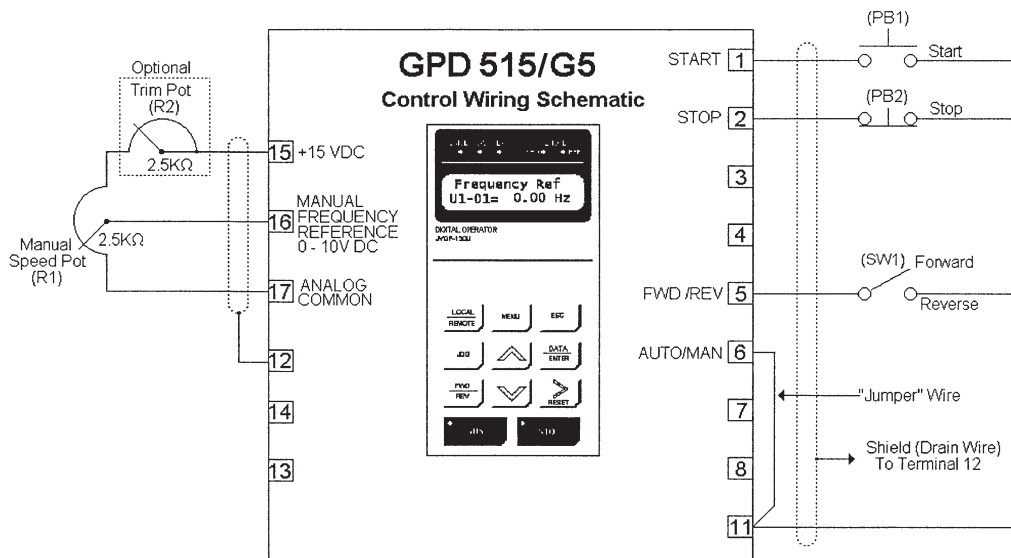

This configuration is best when a person rather than an external controller (PLC, relay, etc.) controls the drive. Both potentiometers (R1) & (R2) should have a resistance value between 2000Ω and 3000Ω and be rated for at least 1 Watt. The trim pot is optional, but without it the manual speed pot will output 10V (60 Hz) at just two-thirds of its rotation. A short jumper wire needs to be installed between terminals 6 & 11. This jumper wire forces the frequency reference to come from the analog value on terminal 16.

### OPERATION:

- Close pushbutton (PB1) momentarily while pushbutton (PB2) is closed and the drive will start. Pushbutton (PB1) does *NOT* need to be maintained.
- Open pushbutton (PB2) at any time and the drive will stop.
- If switch (SW1) is open, the drive will run in the forward direction. If switch (SW1) is closed, the drive runs in the reverse direction. Switch (SW1) can be operated with the drive running at any speed.
- Frequency reference is proportional to the signal level at Terminal 16. 0V = 0 Hz, 5V = 30 Hz, & 10V = 60 Hz.
- If the **LOCAL / REMOTE** key is pressed, the run & stop commands will change over to the digital operator, but the frequency reference will still come from manual speed pot. The jumper installed between terminals 6 and 11 forces the reference to come from terminal 16 regardless of the Local / Remote setting.

**Table 6: Programming Required For Remote 3-wire Sequence & Manual (Speed Pot) Reference**

Parameter	Display Text	Value	Description
A1-03	Init Parameters No Initialize	3330	This parameter can be found under the "Initialize" menu. <b>CAUTION:</b> Setting this value will reset all parameters to their original factory settings (all previous adjustments will be lost) <i>When the drive completes the reset, this parameter returns to 0 – "No Initialize".</i>
E2-01	Motor Rated FLA E2-01= X.XX A	User Set	Sets the motor full load amps.

NOTE: After the above adjustments have been made, the DRIVE, FWD, SEQ, REF, and STOP LEDs will be illuminated.

After the jumper wire and potentiometers are installed and the programming is complete, the trim pot needs to be calibrated. Press **MENU**, then **DATA / ENTER**, and verify that the SEQ and REF LEDs are illuminated. Turn the Manual Speed Pot (R1) all the way up. Adjust the trim pot (R2) so that the "Frequency Reference" display is just flickering between 59.99 Hz and 60.00 Hz. This completes the trim pot calibration.



## Example 6: Remote Sequence (2-Wire) & Remote Reference (0 – 10 VDC) and three digital preset speeds

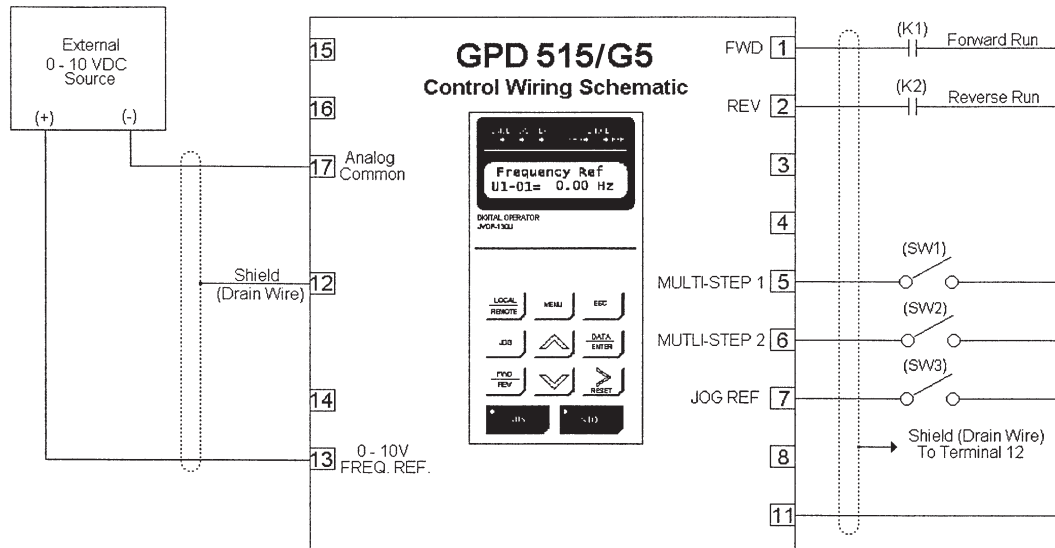

This configuration is used when the start & stop signals and the frequency reference come from a remote source such as a PLC. It can also be used with a maintained switch when it is desirable to have the drive restart on restoration of power. It should not be used where safety of attending personnel might be threatened by a restart. Two digital speeds and a Jog speed can be selected using switches (SW1) thru (SW3).

### OPERATION:

- Close (K1) to Run Forward.
- Close (K2) to Run Reverse.
- If both (K1) & (K2) are closed, the drive stops and displays the error message: “EF External Fault.”
- Frequency reference is determined by the status of switches (SW1), (SW2) and (SW3).
- If the **LOCAL / REMOTE** key is pressed, the drive will behave the same as illustrated in Example 1.

(SW1) Status	(SW2) Status	(SW3) Status	Reference Source
Open	Open	Open	Analog value on terminal 13
Open	Closed	Open	Digital value stored in parameter d1-03
Closed	Closed	Open	Digital value stored in parameter d1-04
Don't Care	Don't Care	Closed	Digital value (JOG Reference) stored in parameter d1-09

**Table 6: Programming Required For Remote 2-wire Sequence & Multiple References**

Parameter	Display Text	Value	Description
A1-03	Init Parameters No Initialize	2220	This parameter can be found under the “Initialize” menu. <b>CAUTION:</b> Setting this value will reset all parameters to their original factory settings (all previous adjustments will be lost) <i>When the drive completes the reset, this parameter returns to 0 – “No Initialize”.</i>
E2-01	Motor Rated FLA E2-01= X.XX A	User Set	Sets the motor full load amps.
d1-03	Reference 3 d1-03= X.XX HZ	User Set	Sets the frequency reference when switch (SW1) is open and switch (SW2) is closed.
d1-04	Reference 4 d1-04= X.XX HZ	User Set	Sets the frequency reference when switches (SW1) & (SW2) are closed.
d1-09	Jog Reference d1-09 = X.XX HZ	User Set	Sets the frequency reference when switch (SW3) is closed. The JOG frequency reference input overrides all other frequency references. The position of (SW1) and (SW2) are irrelevant.

NOTE: After the above adjustments have been made, the DRIVE, SEQ, REF, and STOP LEDs will be illuminated.

## Definitions

**Sequence** – refers to how the drive is started, stopped, and told which direction to run. When the sequence comes from the digital operator (local), the drive is started and stopped using the “RUN” and “STOP” keys on the digital operator, and direction is given via the “FWD/REV” key. Sequence can also come from the drive’s control terminals (remote) using either two-wire or three-wire control. **The sequence inputs to the drive do NOT require any outside voltages to activate them.** Instead, contact closures (either from switches, relay contacts or open collector circuits) activate the sequence inputs.

**Two-wire sequence** – utilizes a “maintained” switch or relay contact. It is used on applications where it is desirable to have the drive restart on restoration of power. It should not be used where safety of attending personnel might be threatened by a restart. This method is generally restricted to unattended fans & pumps, or where another controller is entrusted with the decision to restart. Direction is controlled by maintaining either a forward run or a reverse run command.

**Three-wire sequence** – utilizes “momentary” buttons or switches. This control scheme emulates the traditional 3-wire motor starter control. A momentary closure of a normally open run switch latches the drive in the RUN mode (STOP switch must be closed or the drive will not accept the momentary RUN command). A momentary opening of the normally closed STOP switch unlatches RUN mode bringing the drive to a stop. The three-wire sequence is used where it would be dangerous for the drive to restart after a power outage. This method requires an intentional restart, as the RUN command is unlatched immediately on loss of power. Direction is determined by another maintained contact closure (closed = reverse).

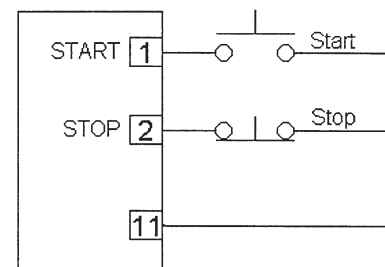

**3-Wire Sequence**

**Reference** - The frequency reference tells the drive how fast to run the motor. There are several source options for the frequency reference. First, the frequency reference can come from the digital operator (local). Simply put, the motor speed can be entered into the keypad. Second, the frequency reference can come from an analog signal (remote), such as 0 to 10 Volts DC. When 0 Volts is applied to the drive, the drive runs at zero speed. When 10V is applied to the drive, it will run at full speed. Apply anything in between and the drive will run at that corresponding frequency (2.5VDC = 25% speed = 15 Hz). If the drive is commanded to run but doesn't, and the RUN LED comes on and the STOP LED flashes, the frequency reference is below the minimum frequency. Increase the frequency reference to run the drive.

**Local Control** – is when the sequence and/or reference comes from the digital operator. If the reference is supposed to come from the digital operator, the REF LED will be off. If the start/stop (sequence) is supposed to come from the digital operator, the SEQ LED will be off.

**Remote Control** – is when the sequence and/or reference comes from the control terminals. If the reference source is supposed to come from terminals 13 or 14, the REF LED will be on. If the start/stop (sequence) is supposed to come from the terminals (2-wire or 3-wire control) the SEQ LED will be on.

# CONTENTS

PARAGRAPH

SUBJECT

PAGE

	<b>GPD 515/G5 SIMPLIFIED START-UP PROCEDURE</b> .....	i
	<b>QUICK REFERENCE FOR GPD 515 PARAMETERS</b> .....	xiv
	<b>CURRENT RATINGS &amp; HORSEPOWER RANGE</b> .....	xvii
	<b>WARNING/CAUTION STATEMENTS</b> .....	xviii
	<b>WARRANTY REGISTRATION</b> .....	xxi
<b>1</b>	<b>INSTALLATION</b> .....	1-1
1.1	General .....	1-1
1.2	Receiving .....	1-1
1.3	Physical Installation .....	1-1
1.4	Electrical Installation .....	1-2
1.4.1	Main Circuit Input/Output .....	1-2
1.4.2	Grounding .....	1-11
1.4.3	Auxiliary Input and Output Power Option Devices .....	1-11
1.4.3a	Conformance to European EMC Directive .....	1-13
1.4.4	Control Circuit .....	1-15
1.4.5	Interconnection - 2-Wire Control (Fig. 1-3) .....	1-20
1.4.6	Interconnection - 3-Wire Control (Fig. 1-4) .....	1-22
1.4.7	Encoder/PG-X2 Connections .....	1-24
<b>2</b>	<b>INITIAL START-UP ("LOCAL" CONTROL)</b> .....	2-1
2.1	Pre-power Checks .....	2-1
2.2	Control Method Selection .....	2-2
2.2a	Power On and Preliminary Checks – Open Loop Vector Control .....	2-3
2.2b	Power On and Preliminary Checks – Flux Vector Control .....	2-6
2.2c	Power On and Preliminary Checks – V/f Control .....	2-11
2.2d	Power On and Preliminary Checks – V/f with PG Feedback Control .....	2-14
2.3	Changing the Language on the Digital Operator .....	2-19
2.4	Calculating Motor Parameters .....	2-20
2.5	Test Run Using Digital Operator ("Local" Control) .....	2-24
2.6	Pre-operation Considerations .....	2-27
2.7	Storage Function .....	2-27
<b>3</b>	<b>OPERATION AT LOAD</b> .....	3-1
<b>4</b>	<b>DIGITAL OPERATOR</b> .....	4-1
4.1	General .....	4-1
4.2	Display and Keypad .....	4-1
4.3	Digital Operator Menu Trees .....	4-4
4.4	Basic Programming .....	4-8
4.5	Modes of Operation .....	4-9

Release Date 4/01/2002

**CONTENTS - Continued**

<b>PARAGRAPH</b>	<b>SUBJECT</b>	<b>PAGE</b>
<b>5</b>	<b>PROGRAMMABLE FEATURES</b> .....	<b>5-1</b>
5.1	General .....	5-1
5.2	Accel/Decel Time .....	5-3
5.3	Accel/Decel: S-Curve Characteristics .....	5-6
5.4	Access Level .....	5-7
5.5	Auto-restart .....	5-7
5.6	Automatic Frequency Regulator (AFR) Gain .....	5-8
5.7	Automatic Speed Regulator (ASR) .....	5-9
5.8	Carrier Frequency .....	5-12
5.9	Critical Frequency Rejection .....	5-13
5.10	DC Injection Braking .....	5-14
5.11	Digital Operator Display Selection .....	5-17
5.12	Display – Monitor (at Power-up) Selection .....	5-19
5.13	Droop .....	5-19
5.14	Dwell .....	5-20
5.15	Encoder (PG) Parameters .....	5-21
5.16	Energy Saving Operation .....	5-26
5.17	External Fault Inputs .....	5-28
5.18	Frequency Reference Command Bias/Gain .....	5-29
5.19	Frequency Reference Input Signals (Auto/Manual) .....	5-31
5.20	Frequency Reference Loss Detection .....	5-33
5.21	Frequency Reference Retention .....	5-33
5.22	Frequency Reference Upper & Lower Limits .....	5-34
5.23	Hunting Prevention .....	5-35
5.24	Jog Reference .....	5-36
5.25	Local Remote and Reference Selection .....	5-39
5.25 A	Local Remote Selection .....	5-39
5.25 B	Multiple Speed Reference Configuration [Multi-step Speed Operation] .....	5-40
5.26	Miscellaneous Parameters .....	5-44
5.27	Miscellaneous Protective Features .....	5-46
5.28	MODBUS Control .....	5-48
5.29	Momentary Power Loss Ride-thru .....	5-50
5.30	Multi-function Analog Inputs (Term. 14 & 16 ) .....	5-53
5.31	Multi-function Analog Monitor Output (Term. 21-23) .....	5-57
5.32	Multi-function Input Terminals (Term. 3-8) .....	5-58
	• Local/Remote .....	5-62
	• External Base Block .....	5-63
	• Speed Search .....	5-64
	• Timer Function .....	5-66
	• Sample/Hold Command .....	5-66
	• Up/Down Frequency Setting .....	5-67
	• Trim Control .....	5-69

**CONTENTS - Continued**

<b>PARAGRAPH</b>	<b>SUBJECT</b>	<b>PAGE</b>
5.33	Multi-function Output Terminals (Term. 9 & 10; 25-27) .....	5-70
	• Frequency or Speed Detection Output Signals .....	5-73
5.34	Phase Loss Detection – Input .....	5-77
5.35	Phase Loss Detection – Output .....	5-77
5.36	PID Control .....	5-78
5.37	Reset Codes; 2-Wire, 3-Wire Initialization .....	5-83
5.38	Slip Compensation .....	5-84
5.39	Stall Prevention .....	5-86
5.40	Stopping Method .....	5-88
5.41	Thermal Overload Protection .....	5-90
5.42	Torque Compensation .....	5-93
5.43	Torque Control (Command) .....	5-95
5.44	Torque Detection .....	5-98
5.45	Torque Limit .....	5-101
5.45.1	Two Motor Operation .....	5-104
5.46	User Parameters .....	5-106
5.47	V/f Pattern - Standard .....	5-106
5.48	V/f Pattern - Custom .....	5-108
5.49	Zero-Servo Control .....	5-110
5.50	Zero Speed Control .....	5-112
<b>6</b>	<b>FAULT INDICATION &amp; TROUBLESHOOTING</b> .....	<b>6-1</b>
6.1	General .....	6-1
6.2	Auto-Tuning Faults and Corrective Actions .....	6-6
6.3	Displaying Faults .....	6-7
6.4	Troubleshooting Flowcharts .....	6-10
6.5	Diode and IGBT (Transistor) Module Resistance Test .....	6-27
6.6	Checking Encoder Pulses .....	6-29
<b>App. 1</b>	<b>LISTING OF PARAMETERS</b> .....	<b>A1-1</b>
<b>App. 2</b>	<b>SPECIFICATIONS</b> .....	<b>A2-1</b>
<b>App. 3</b>	<b>CAPACITY &amp; CONTROL METHOD RELATED PARAMETERS</b> .....	<b>A3-1</b>
<b>App. 4</b>	<b>GPD 515/G5 SPARE PARTS</b> .....	<b>A4-1</b>
<b>App. 5</b>	<b>GPD 515/G5 DIMENSIONS</b> .....	<b>A5-1</b>
<b>App. 6</b>	<b>DYNAMIC BRAKING CONNECTIONS</b> .....	<b>A6-1</b>
<b>Index</b>	.....	<b>I-1</b>

## QUICK REFERENCE FOR GPD 515/G5 PARAMETERS (FACTORY SET)

PARAMETER NUMBER (7)	FACTORY SETTING	USER SETTING	PARA. REF.
A1-00	0		2.3
A1-01	2		5.4
A1-02	2		2.2
A1-03	0		5.37
A1-04	0000		<b>p. A1-1</b>
A2-01 thru A2-32	(1)	(1)	(1)
b1-01	1		5.25 A
b1-02	1		5.25 A
b1-03	0		5.40
b1-04	0		<b>p. A1-2</b>
b1-05	0		5.50
b1-06	1		<b>p. A1-2</b>
b1-07	0		<b>p. A1-2</b>
b1-08	0		5.26
b2-01	0.5		5.10
b2-02	50		5.10
b2-03	0.00		5.10
b2-04	0.00		5.10
b2-08	0		5.10B
b3-01	0 (6)		5.32 D
b3-02	100		5.32 D
b3-03	2.0		5.32 D
b4-01	0.0		5.32 E
b4-02	0.0		5.32 E
b5-01	0		5.36
b5-02	1.00		5.36
b5-03	1.0		5.36
b5-04	100.0		5.36
b5-05	0.00		5.36
b5-06	100.0		5.36
b5-07	0.0		5.36
b5-08	0.00		5.36
b5-09	0		5.36D
b5-10	1.0		5.36D
b5-11	0		5.36D
b5-12	0		5.36E
b5-13	0		5.36E
b5-14	1.0		5.36E
b6-01	0.0		5.14
b6-02	0.0		5.14
b6-03	0.0		5.14
b6-04	0.0		5.14
b7-01	0.0		5.13
b7-02	0.05		5.13
b8-01	80		5.16A
b8-02	0.0		5.16A
b8-03	0		5.16B
b8-04	Note 2		5.16B
b8-05	Note 2		5.16B
b9-01	5		5.49
b9-02	10		5.49
C1-01	10.0		5.2
C1-02	10.0		5.2
C1-03	10.0		5.2
C1-04	10.0		5.2
C1-05	10.0		5.2
C1-06	10.0		5.2

PARAMETER NUMBER (7)	FACTORY SETTING	USER SETTING	PARA. REF.
C1-07	10.0		5.2
C1-08	10.0		5.2
C1-09	10.0		5.2
C1-10	1		5.2
C1-11	0.00		5.2
C2-01	0.20		5.3
C2-02	0.20		5.3
C2-03	0.20		5.3
C2-04	0.00		5.3
C3-01	1.0 (6)		5.38
C3-02	200 (6)		5.38
C3-03	200		5.38
C3-04	0		5.38
C3-05	0		5.38
C3-06	0		5.38
C4-01	1.00		5.42
C4-02	20 (6)		5.42
C4-03	0.0		5.42
C4-04	0.0		5.42
C4-05	10		5.42
C5-01	20.00 (6)		5.7
C5-02	0.500 (6)		5.7
C5-03	20.00 (6)		5.7
C5-04	0.500 (6)		5.7
C5-05	5.0		<b>p. A1-8</b>
C5-06	0.004		5.7
C5-07	0.0		5.7
C5-08	400		<b>p. A1-8</b>
C6-01	10.0 (5)		5.8
C6-02	10.0 (5)		5.8
C6-03	0 (5)		5.8
C7-01	1		5.23
C7-02	1.00		5.23
C8-08	1.00		5.6
C8-09	50		5.6
C8-30	2		<b>p. A1-9</b>
d1-01	0.0		5.25 B
d1-02	0.0		5.25 B
d1-03	0.0		5.25 B
d1-04	0.0		5.25 B
d1-05	0.0		5.25 B
d1-06	0.0		5.25 B
d1-07	0.0		5.25 B
d1-08	0.0		5.25 B
d1-09	6.0		5.25 B
d2-01	100.0		5.22
d2-02	0.0		5.22
d3-01	0.0		5.9
d3-02	0.0		5.9
d3-03	0.0		5.9
d3-04	1.0		5.9
d4-01	0		5.21
d4-02	10		5.32 H
d5-01	0		5.43
d5-02	0		5.43
d5-03	1		5.43
d5-04	0		5.43
d5-05	10		5.43
d5-06	0		5.43

PARAMETER NUMBER (7)	FACTORY SETTING	USER SETTING	PARA. REF.
E1-01	230V, 460V or 575V (5)		5.48
E1-02	0		5.41
E1-03	F		5.47
E1-04	60.0		5.48
E1-05	230.0V, 460.0V or 575.0V (5)		5.48
E1-06	60.0		5.48
E1-07	3.0 (6)		5.48
E1-08	(2) (6)		5.48
E1-09	0.5 (6)		5.48
E1-10	(2) (6)		5.48
E1-11	0.0		5.48
E1-12	0.0		5.48
E1-13	0.0		5.48
E2-01	(5)		5.41
E2-02	(5)		2.4
E2-03	(5)		2.4
E2-04	4		2.4
E2-05	(5)		2.4
E2-06	(5)		2.4
E2-07	0.50 (5)		2.4
E2-08	0.75 (5)		2.4
E2-09	0.0 (5)		2.4
E2-10	(See Note 3)		<b>p. A1-13</b>
E3-01	2		5.45.1
E4-01	60.0	230.0V, 460.0V or 575.0V (5)	5.45.1
E4-02			5.45.1
E4-03	60.0		5.45.1
E4-04	3.0 (6)		5.45.1
E4-05	(2) (6)		5.45.1
E4-06	0.5 (6)		5.45.1
E4-07	(2) (6)		5.45.1
E5-01	(5)		5.45.1
E5-02	(5)		5.45.1
E5-03	(5)		5.45.1
E5-04	4		5.45.1
E5-05	(5)		5.45.1
E5-06	(5)		5.45.1
F1-01	1024		5.15 A
F1-02	1		5.15 B
F1-03	1		5.15 C
F1-04	3		5.15 D
F1-05	0		5.15 E
F1-06	1		(8)
F1-07	0		5.15 F
F1-08	115		5.15 C
F1-09	0.0 (6)		5.15 C
F1-10	10		5.15 D
F1-11	0.5		5.15 D
F1-12	0		5.15 G
F1-13	0		5.15 G
F1-14	2.0		5.15 B
F2-01	0		(9)
F3-01	0		(10)

## QUICK REFERENCE FOR GPD 515/G5 PARAMETERS (FACTORY SET)

PARAMETER NUMBER (7)	FACTORY SETTING	USER SETTING	PARA. REF.
F4-01	2		(11)
F4-02	1.00		(11)
F4-03	3		(11)
F4-04	0.50		(11)
F4-05	0.0		(11)
F4-06	0.0		(11)
F5-01	0		(12)
F5-02	1		(12)
F6-01	0		(13)
F7-01	1		(14)
F8-01	1		p. A1-17
F9-01	0		p. A1-17
F9-02	0		p. A1-17
F9-03	1		p. A1-17
F9-04	0		p. A1-17
F9-05	1		p. A1-17
F9-06	1		p. A1-17
H1-01	24		5.32
H1-02	14		5.32
H1-03	3 (0) (3)		5.32
H1-04	4 (3) (3)		5.32
H1-05	6 (4) (3)		5.32
H1-06	8 (6) (3)		5.32
H2-01	0		5.33
H2-02	1		5.33
H2-03	2		5.33
H3-01	0		5.19
H3-02	100.0		5.18
H3-03	0.0		5.18
H3-04	0		5.19
H3-05	0		5.30
H3-06	100.0		5.18
H3-07	0.0		5.18
H3-08	2		5.19
H3-09	1F		5.30
H3-10	100.0		5.18
H3-11	0.0		5.18
H3-12	0.00		p. A1-19

PARAMETER NUMBER (7)	FACTORY SETTING	USER SETTING	PARA. REF.
H4-01	2		5.31
H4-02	1.00		5.31
H4-03	0.0		5.31
H4-04	3		5.31
H4-05	0.50		5.31
H4-06	0.0		5.31
H4-07	0		5.31
H5-01	1F		5.28
H5-02	3		5.28
H5-03	0		5.28
H5-04	3		5.28
H5-05	1		5.28
L1-01	1		5.41
L1-02	8.0		5.41
L2-01	0		5.29
L2-02	0.7 (5)		5.29
L2-03	0.5 (5)		5.32 D
L2-04	(5)	190,	5.29
L2-05	190	380, or	5.29
L2-06	0.0	546 (5)	p. A1-21
L3-01	1		5.39
L3-02	150		5.39
L3-03	50		5.39
L3-04	1		5.39
L3-05	1		5.39
L3-06	160		5.39
L4-01	0.0		5.33
L4-02	2.0		5.33
L4-03	0.0		5.33
L4-04	2.0		5.33
L4-05	0		5.20
L5-01	0		5.5
L5-02	0		5.5
L6-01	0		5.44
L6-02	150		5.44
L6-03	0.1		5.44

PARAMETER NUMBER (7)	FACTORY SETTING	USER SETTING	PARA. REF.
L6-04	0		5.44
L6-05	150		5.44
L6-06	0.1		5.44
L7-01	200		5.45
L7-02	200		5.45
L7-03	200		5.45
L7-04	200		5.45
L8-01	0		5.27
L8-02	(5)		5.27
L8-03	3		5.27
L8-05	0		5.34
L8-07	1		5.35
L8-10	1		5.27
L8-17	1		5.27
L8-19	0		5.27
o1-01	6		5.12
o1-02	1		5.12
o1-03	0		5.11
o1-04	0		5.11
o1-05	0		5.11
o2-01	1		5.26
o2-02	1		5.26
o2-03	0		5.46
o2-04	(5)		p. A3-1
o2-05	0		5.26
o2-06	1		5.26
o2-07	00000		5.26
o2-08	0		5.26
o2-09	1		p. A1-26
U1-01 thru U1-34	(4)	—	(4)
U2-01 thru U2-14	(4)	—	(4)
U3-01 thru U3-08	(4)	—	(4)

- (1) To establish a custom User Access Level, refer to paragraph 5.4.
- (2) Initial value is related to V/f curve selected by **E1-03** setting.
- (3) Settings in parentheses reflect 3-wire control initialization values.
- (4) Monitor displays ( **UX-XX** ) are display or output selections, rather than parameter setup; therefore, user setting is not possible.
- (5) Factory setting depends on drive rating. See Table A3-1.
- (6) Factory setting depends on Control Method ( **A1-02** ).
- (7) Not all parameters are accessible in all Access Levels ( **A1-01** ) and Control Methods ( **A1-02** ); see Section 5.
- (8) Only effective with PG-D2 or PG-B2 option card; see instruction sheet 2Y25-396.
- (9) Only effective with AI-14B or AI-14U option card; see instruction sheet 2Y25-296 or -295.
- (10) Only effective with DI-08 or DI-16H2 option card; see instruction sheet 2Y25-294 or -400.
- (11) Only effective with AO-08, AO-12 or AO-12B2 option card; see instruction sheet 2Y25-297 or -438.
- (12) Only effective with DO-02C option card; see instruction sheet 2Y25-402.
- (13) Only effective with DO-08 option card; see instruction sheet 2Y25-350.
- (14) Only effective with PO-36F option card; see instruction sheet 2Y25-298.

## Current Ratings & Horsepower Range

RATED INPUT	CURRENT RATING (AMPS)	NOMINAL HORSEPOWER (150% OL)	NEW DRIVE MODEL NO. CIMR-G5M	OLD DRIVE MODEL NO. GPD515C-
2 3 0 V	3.2	0.75	20P41F	A003
	6	1 & 1.5	20P71F	A006
	8	2	21P51F	A008
	11	3	22P21F	A011
	17.5	5	23P71F	A017
	25	7.5	25P51F	A025
	33	10	27P51F	A033
	49	15	20111F	A049
	64	20	20151F	A064
	80	25 & 30	20181F	A080
4 6 0 V	96	30	20221F	A096
	130	40 & 50	20300F	A130
	160	60	20370F	A160
	224	75	20550F	A224
	300	100	20750F	A300
	1.8	0.75	40P41F	B001
	3.4	1 & 2	40P71F	B003
	4.8	3	41P51F	B004
	8	5	43P71F	B008
	11	7.5	44P01F	B011
	14	10	45P51F	B014
	21	15	47P51F	B021
	27	20	40111F	B027
	34	25	40151F	B034
	41	30	40181F	B041
52	40	40221F	B052	
65	50	40301F	B065	
80	60	40371F	B080	
96	75	40451F	B096	
128	100	40551F	B128	
165	125	40750F	B165	
224	150	41100F	B224	
302	200 & 250	41600F	B302	
340	300	41850F	B340	
450	350	42200F	B450	
605	400 & 500	43000F	B605	
6 0 0 V	3.5	2	51P51F	C003
	4.1	3	52P21F	C004
	6.3	5	53P71F	C006
	9.8	7.5	55P51F	C010
	12.5	10	57P51F	C012
	17	15	50111F	C017
	22	20	50151F	C022
	27	25	50181F	C027
	32	30	50221F	C032
	41	40	50301F	C041
	52	50	50371F	C052
	62	60	50451F	C062
	77	75	50551F	C077
99	100	50751F	C099	
130	125	50900F	C130	
172	150	51100F	C172	
200	200	51600F	C200	





**WARNING**

**Do not touch circuit components until main input power has been turned off and “CHARGE” lamp is extinguished. The capacitors are still charged and can be quite dangerous.**

**Do not connect or disconnect wires and connectors while power is applied to the circuit.**



**CAUTION**

**Know your application before using either Initialization function of A1-03 . This parameter must be set to " 0 " for Drive mode operation.**

**" 1110 " = User Default Parameter Initialization**

**" 2220 " = Factory 2-Wire Control Initialization (Maintained RUN Contact)**

**" 3330 " = Factory 3-Wire Control Initialization (Momentary START/STOP Contact)**

**Entering any Initialization code resets all parameters, and automatically returns A1-03 setting to " 0 ". If the GPD 515 is connected for 3-Wire control and this parameter is set to " 2220 " (2-Wire Control Initialization), the motor may run in reverse direction WITHOUT A RUN COMMAND APPLIED. Equipment damage or personal injury may result.**



**CAUTION**

**When drive is programmed for auto-restart ( L5-02 = " 1 " thru " 10 " ), the motor may restart unexpectedly — personal injury may result.**

## **IMPORTANT**

Wiring should be performed only by qualified personnel.

Always ground the drive using ground terminal ( $\perp$ ). See paragraph 1.4.3, "Grounding".

Verify that the rated voltage of the drive matches the voltage of the incoming power.

Never connect main circuit output terminals T1, T2, and T3 to AC main circuit power supply.

All parameters have been factory set. Do not change their settings unnecessarily.

Do not perform a "HIPOT" or withstand voltage test on any part of the drive. Equipment uses semi-conductors and is vulnerable to high voltage.

The Control PCB employs CMOS ICs which are easily damaged by static electricity. Use proper electrostatic discharge (ESD) procedures when handling the Control PCB.

Any modification of the product by the user is not the responsibility of Yaskawa, and will void the warranty.

# Technical Training



It is important that users of our products have a totally satisfying ownership experience.

Training is one of the most effective ways to ensure that satisfaction. Because of this conviction, Yaskawa Electric has operated a full-time professional training department since 1965.

Our trainers are full-time instructors, with a wealth of "real-life" product experience gained through field service at customer facilities. This experience, combined with backgrounds in engineering and education, has earned national recognition for our technical training programs.



Courses are conducted at the headquarters training facility, in selected cities, and at customer sites. Courses are available to cover all the issues of concern to product users: application, theory of operation, troubleshooting and repair, adjustment

and startup, operation, programming, network communication, and optimizing the functions of Yaskawa drives.

We work hard to make all of our products user-friendly, and our owner manuals easy to use.

In spite of that, the simple fact is that you will learn better and faster in a class environment combined with hands-on practice, than by self-teaching when under the stress of a maintenance or operations problem.

## On-Site Training and Customized Courses

Training courses are also provided at the user's site. Course content can be customized to the specific installation and application if requested. For further information about on-site training and courses specific to your installation and application, visit our website at [www.drives.com](http://www.drives.com).

Please send training information on:

Name \_\_\_\_\_

Position/Title \_\_\_\_\_

Company \_\_\_\_\_

Address \_\_\_\_\_

City \_\_\_\_\_ State \_\_\_\_\_ Zip \_\_\_\_\_

Phone \_\_\_\_\_

Fax \_\_\_\_\_

Representative (if known): \_\_\_\_\_

FAX this completed form to (847) 887-7185

# Section 1. RECEIVING AND INSTALLATION

## 1.1 GENERAL

The GPD 515/G5, hereafter referred to as the drive, is a general purpose sine-coded pulse width modulated AC motor drive which generates an adjustable voltage/frequency three phase output for complete speed control of most conventional squirrel cage induction motors. Automatic stall prevention and voltage boost prevents nuisance tripping during load or line side transient conditions. The drive will not induce any voltage line notching distortion back to the utility line and maintains a displacement power factor of not less than 0.98 throughout its speed range.

When properly installed, operated and maintained, the drive will provide a lifetime of service. It is mandatory that the person who operates, inspects, or maintains this equipment thoroughly read and understand this manual before proceeding.

This manual primarily describes the GPD 515/G5, but contains basic information for the operator control station as well. This manual is equally applicable to drives labelled GPD 515 or G5.

## 1.2 RECEIVING

The drive is thoroughly tested at the factory. After unpacking, verify the part numbers with the purchase order (invoice). Any damages or shortages evident when the equipment is received must be reported immediately to the commercial carrier who transported the equipment. Assistance, if required, is available from your sales representative.

If the drive will be stored after receiving, keep it in its original packaging and store according to storage temperature specifications in Appendix 2.

## 1.3 PHYSICAL INSTALLATION

Location of the drive is important to achieve proper performance and normal operating life. The unit should be installed in an area where it will be protected from:

- Direct sunlight, rain or moisture.
- Corrosive gases or liquids.
- Vibration, airborne dust or metallic particles.

When preparing to mount the drive, lift it by its base, **never** by the front cover. For effective cooling as well as proper maintenance, the drive must be installed on a flat, non-flammable vertical surface (wall or panel) using four mounting screws. There **MUST** be a **MINIMUM** 4.7 in. clearance above and below the drive to allow air flow over the heat sink fins. A minimum 1.2 in. clearance is required on each side on the drive.

A GPD 515/G5 in a free-standing floor-mount cabinet must be positioned with enough clearance for opening the door of the cabinet; this will ensure sufficient air space for cooling. Make sure air entering the drive is below 113°F (45°C) (for protected chassis drives), or below 104°F (40°C) (for NEMA 1 drives), by adding a fan or other cooling device, if needed. See environmental specifications in Appendix 2.

## 1.4 ELECTRICAL INSTALLATION

All basic interconnections (using the Digital Operator) are shown in Figures 1-3 and 1-4.

### 1.4.1 Main Circuit Input/Output

Complete wire interconnections according to Table 1-2, Figure 1-3 and Figure 1-4. Be sure to observe the following:

- Use 600V vinyl-sheathed wire or equivalent. Wire size and type should be determined by local electrical codes.
- Avoid routing power wiring near equipment sensitive to electrical noise.
- Avoid running input and output wiring in the same conduit.
- NEVER connect AC main power to output terminals T1(U), T2(V), and T3(W).
- NEVER allow wire leads to contact metal surfaces. Short-circuit may result.
- NEVER connect power factor correction capacitors to the drive output. Consult Yaskawa when connecting noise filters to the drive output.
- WIRE SIZING MUST BE SUITABLE FOR CLASS I CIRCUITS.
- When connecting motor to drive's output terminals, include a separate ground wire. Attach ground wire solidly to motor frame and to drive's ground terminal.  $\perp$
- When using armored or shielded cable for connection between drive and motor, solidly connect armor or shield to motor frame, and to drive's ground terminal.  $\perp$
- Motor lead length should NOT EXCEED 164 feet (50 meters), and motor wiring should be run in a separate conduit from other power wiring. If lead length must exceed this distance, reduce carrier frequency (see paragraph 5.8) and consult factory for proper installation procedures.
- Use UL listed closed loop connectors or CSA certified ring connectors sized for the selected wire gauge. Install connectors using the correct crimp tool recommended by the connector manufacturer.

WIRE SIZE		TERMINAL SCREW	CLOSED-LOOP CONNECTOR	CLAMPING TORQUE			
AWG	mm <sup>2</sup>			STEEL		COPPER	
				lb-in	N-m	lb-in	N-m
20	0.5	M3.5	1.25 - 3.5	7.8	0.9	7.0	0.8
18	0.75	M4	1.25 - 4	13.0	1.5	10.4	1.2
16	1.25	M4	1.25 - 4	13.0	1.5	10.4	1.2
14	2	M4	2 - 4	13.0	1.5	10.4	1.2
		M5	2 - 5	26.1	20.9	3.1	2.4
12	3.5	M4	3.5 - 4	13.0	1.5	10.4	1.2
		M5	3.5 - 5	26.1	20.9	3.1	2.4
10	5.5	M4	5.5 - 4	13.0	1.5	10.4	1.2
		M5	5.5 - 5	26.1	20.9	3.1	2.4
8	8	M5	8 - 5	26.1	20.9	3.1	2.4
		M6	8 - 6	40.9	34.8	4.8	4.1
6	14	M6	14 - 6	40.9	34.8	4.8	4.1
4	22	M8	22 - 8	100.0	82.6	11.7	10.7
2	38	M8	38 - 8	100.0	82.6	11.7	10.7
		M10	38 - 10	182.6	156.5	21.4	18.4
1/0	60	M10	60 - 10	182.6	156.5	21.4	18.4
3/0	80	M10	80 - 10	182.6	156.5	21.4	18.4
4/0	100	M10	100 - 10	182.6	156.5	21.4	18.4
		M12	100 - 12	313.0	191.3	36.7	23.1
MCM300	150	M12	150 - 12	313.0	191.3	36.7	23.1
MCM400	200	M12	200 - 12	313.0	191.3	36.7	23.1
MCM650	325	M12	325 - 12	313.0	191.3	36.7	23.1
		M16	325 - 16	313.0	191.3	36.7	23.1

**Table 1-1. Typical Wire Sizing For Main Circuit\***

SECTION A. 230V					
NEW DRIVE MODEL NO. CIMR-G5M	OLD DRIVE MODEL NO. GPD515C-	TERMINAL SYMBOL	TERMINAL SCREW	WIRE SIZE	
				AWG	mm <sup>2</sup>
20P41F 20P71F	A003, A006	L1 (R), L2 (S), L3 (T), ⊖, ⊕1, ⊕2, B1, B2, T1 (U), T2 (V), T3 (W), ≍	M4	14 - 10	2 - 5.5
21P51F	A008	L1 (R), L2 (S), L3 (T), ⊖, ⊕1, ⊕2, B1, B2, T1 (U), T2 (V), T3 (W)	M4	14 - 10	2 - 5.5
		≍	M4	12 - 10	3.5 - 5.5
22P21F	A011	L1 (R), L2 (S), L3 (T), ⊖, ⊕1, ⊕2, B1, B2, T1 (U), T2 (V), T3 (W), ≍	M4	12 - 10	3.5 - 5.5
23P71F	A017	L1 (R), L2 (S), L3 (T), ⊖, ⊕1, ⊕2, B1, B2, T1 (U), T2 (V), T3 (W), ≍	M4	10	5.5
25P51F 27P51F	A025, A033	L1 (R), L2 (S), L3 (T), ⊖, ⊕1, ⊕2, B1, B2, T1 (U), T2 (V), T3 (W)	M5	8	8
		≍	M5	10 - 8	5.5 - 8
20111F	A049	L1 (R), L2 (S), L3 (T), ⊖, ⊕1, ⊕2, ⊕3, T1 (U), T2 (V), T3 (W)	M6	4	22
		≍	M6	8	8
20151F	A064	L1 (R), L2 (S), L3 (T), ⊖, ⊕1, ⊕2, ⊕3, T1 (U), T2 (V), T3 (W)	M8	3	30
		≍	M6	8	8
20181F 20221F	A080, A096	L1 (R), L2 (S), L3 (T), ⊖, ⊕1, ⊕2, ⊕3, T1 (U), T2 (V), T3 (W)	M8	3	30
		≍	M8	6	14
		ℓ1 (r), ℓ2 (s)	M4	20 - 10	0.5 - 5.5
20300F	A130	L1 (R), L2 (S), L3 (T), T1 (U), T2 (V), T3 (W)	M10	4/0	100
		⊖, ⊕3, ≍	M8	4	22
		ℓ1 (r), ℓ2 (s)	M4	20 - 10	0.5 - 5.5
20370F	A160	L1 (R), L2 (S), L3 (T), T1 (U), T2 (V), T3 (W)	M10	1/0 x 2P	60 x 2P
		⊖, ⊕3, ≍	M8	4	22
		ℓ1 (r), ℓ2 (s)	M4	20 - 10	0.5 - 5.5
20550F	A224	L1 (R), L2 (S), L3 (T), T1 (U), T2 (V), T3 (W)	M10	1/0 x 2P	60 x 2P
		⊖, ⊕3, ≍	M8	3	30
		ℓ1 (r), ℓ2 (s)	M4	20 - 10	0.5 - 5.5
20750F	A300	L1 (R), L2 (S), L3 (T), T1 (U), T2 (V), T3 (W)	M12	4/0 x 2P	100 x 2P
		⊖, ⊕3, ≍	M8	1	50
		ℓ1 (r), ℓ2 (s)	M4	20 - 10	0.5 - 5.5

\* Consult local electrical codes for wire sizing requirements.

**Table 1-1. Typical Wire Sizing For Main Circuit - Continued\***

Section B. 460V					
NEW DRIVE MODEL NO. CIMR-G5M	OLD DRIVE MODEL NO. GPD515C-	TERMINAL SYMBOL	TERMINAL SCREW	WIRE SIZE	
				AWG	mm <sup>2</sup>
40P41F	B001	L1 (R), L2 (S), L3 (T), ⊖, ⊕1, ⊕2, B1, B2, T1 (U), T2 (V), T3 (W), ≡	M4	14 - 10	2 - 5.5
40P71F	B003,	L1 (R), L2 (S), L3 (T), ⊖, ⊕1, ⊕2, B1, B2, T1 (U),	M4	14 - 10	2 - 5.5
41P51F	B004,	T2 (V), T3 (W)			
43P71F	B008	≡	M4	12 - 10	3.5 - 5.5
44P01F	B011,	L1 (R), L2 (S), L3 (T), ⊖, ⊕1, ⊕2, B1, B2, T1 (U),	M4	12 - 10	3.5 - 5.5
45P51F	B014	T2 (V), T3 (W), ≡			
47P51F	B021	L1 (R), L2 (S), L3 (T), ⊖, ⊕1, ⊕2, B1, B2, T1 (U), T2 (V), T3 (W), ≡	M4	8 - 6	8 - 14
40111F	B027,	L1 (R), L2 (S), L3 (T), ⊖, ⊕1, ⊕2, B1, B2, T1 (U),	M5	8 - 6	8 - 14
40151F	B034	T2 (V), T3 (W)			
		≡	M6	8	8
40181F	B041	L1 (R), L2 (S), L3 (T), ⊖, ⊕1, ⊕2, ⊕3, T1 (U), T2 (V), T3 (W)	M6	6	14
		≡	M8	8	8
		ℓ1 (r), ℓ2 (s)	M4	20 - 10	0.5 - 5.5
40221F	B052	L1 (R), L2 (S), L3 (T), ⊖, ⊕1, ⊕2, ⊕3, T1 (U), T2 (V), T3 (W)	M6	4	22
		≡	M8	8	8
		ℓ1 (r), ℓ2 (s)	M4	20 - 10	0.5 - 5.5
40301F	B065	L1 (R), L2 (S), L3 (T), ⊖, ⊕1, ⊕2, ⊕3, T1 (U), T2 (V), T3 (W)	M8	4	22
		≡	M8	8	8
		ℓ1 (r), ℓ2 (s)	M4	20 - 10	0.5 - 5.5
40371F	B080	L1 (R), L2 (S), L3 (T), ⊖, ⊕1, ⊕2, ⊕3, T1 (U), T2 (V), T3 (W)	M8	3	30
		≡	M8	6	14
		ℓ1 (r), ℓ2 (s)	M4	20 - 10	0.5 - 5.5
40451F	B096	L1 (R), L2 (S), L3 (T), ⊖, ⊕1, ⊕2, ⊕3, T1 (U), T2 (V), T3 (W)	M8	1	50
		≡	M8	6	14
		ℓ1 (r), ℓ2 (s)	M4	20 - 10	0.5 - 5.5
40551F	B128	L1 (R), L2 (S), L3 (T), T1 (U), T2 (V), T3 (W)	M10	4/0	100
		⊖, ⊕3, ≡	M8	4	22
		ℓ1 (r), ℓ2 200 (s200), ℓ2 400 (s400)	M4	20 - 10	0.5 - 5.5
40750F	B165	L1 (R), L2 (S), L3 (T), T1 (U), T2 (V), T3 (W)	M10	1/0 x 2P	60 x 2P
		⊖, ⊕3, ≡	M8	4	22
		ℓ1 (r), ℓ2 200 (s200), ℓ2 400 (s400)	M4	20 - 10	0.5 - 5.5
41100F	B224	L1 (R), L2 (S), L3 (T), T1 (U), T2 (V), T3 (W)	M10	1/0 x 2P	60 x 2P
		⊖, ⊕3, ≡	M8	3	30
		ℓ1 (r), ℓ2 200 (s200), ℓ2 400 (s400)	M4	20 - 10	0.5 - 5.5
41600F	B302	L1 (R), L2 (S), L3 (T), T1 (U), T2 (V), T3 (W)	M12	4/0 x 2P	100 x 2P
		⊖, ⊕3, ≡	M8	1	50
		ℓ1 (r), ℓ2 200 (s200), ℓ2 400 (s400)	M4	20 - 10	0.5 - 5.5
41850F	B340,	L1 (R), L2 (S), L3 (T), ⊖, ⊕1, ⊕3, T1 (U), T2 (V),	M16	MCM650 x 2P	325 x 2P
42200F	B450,	T3 (W)			
43000F	B605	≡	M8	1/0	60
		ℓ1 (r), ℓ2 200 (s200), ℓ2 400 (s400)	M4	20 - 10	0.5 - 5.5

\* Consult local electrical codes for wire sizing requirements.

**Table 1-1. Typical Wire Sizing For Main Circuit - Continued\***

Section C. 600V						
NEW DRIVE MODEL NO. CIMR-G5M	OLD DRIVE MODEL NO. GPD515C-	TERMINAL SYMBOL	TERMINAL SCREW	WIRE SIZE		
				AWG	mm <sup>2</sup>	
51P51F 52P21F	C003, C004	L1 (R), L2 (S), L3 (T), ⊖, ⊕1, ⊕2, B1, B2, T1 (U), T2 (V), T3 (W)	M4	14-10	2 - 5.5	
		≡				
53P71F	C006	L1 (R), L2 (S), L3 (T), ⊖, ⊕1, ⊕2, B1, B2, T1 (U), T2 (V), T3 (W)	M4	14-10	2 - 5.5	
		≡		12-10	3.5-5.5	
55P51F	C010	L1 (R), L2 (S), L3 (T), ⊖, ⊕1, ⊕2, B1, B2, T1 (U), T2 (V), T3 (W)	M4	12-10	3.5-5.5	
		≡				
57P51F	C012	L1 (R), L2 (S), L3 (T), ⊖, ⊕1, ⊕2, B1, B2, T1 (U), T2 (V), T3 (W)	M4	10	5.5	
		≡		12-10	3.5-5.5	
50111F	C017	L1 (R), L2 (S), L3 (T), ⊖, ⊕1, ⊕2, B1, B2, T1 (U), T2 (V), T3 (W)	M5	10-6	5.5-14	
		≡	M6			
50151F	C022	L1 (R), L2 (S), L3 (T), ⊖, ⊕1, ⊕2, B1, B2, T1 (U), T2 (V), T3 (W)	M5	8-6	8-14	
		≡	M6	10-6	5.5-14	
50181F 50221F	C027 C032	L1 (R), L2 (S), L3 (T), ⊖, ⊕1, B1, B2, T1 (U), T2 (V), T3 (W)	M6	8-6	8-14	
		≡	◆	10-6	5.5-14	
		ℓ1 (r), ℓ2(∗)	M4	14 - 10	2 - 5.5	
50301F	C041	L1 (R), L2 (S), L3 (T), ⊖, ⊕1, T1 (U), T2 (V), T3 (W)	M8	6-1/0	14-50	
		≡	◆	8-2	8-30	
		ℓ1 (r), ℓ2(∗)	M4	14 - 10	2 - 5.5	
50371F	C052	L1 (R), L2 (S), L3 (T), ⊖, ⊕1, T1 (U), T2 (V), T3 (W)	M8	4-1/0	22-50	
		≡	◆	8-2	8-30	
		ℓ1 (r), ℓ2(∗)	M4	14 - 10	2 - 5.5	
50451F	C062	L1 (R), L2 (S), L3 (T), ⊖, ⊕1, T1 (U), T2 (V), T3 (W)	M8	3-1/0	30-50	
		≡	◆	8-2	8-30	
		ℓ1 (r), ℓ2(∗)	M4	14 - 10	2 - 5.5	
50551F	C077	L1 (R), L2 (S), L3 (T), ⊖, ⊕1, T1 (U), T2 (V), T3 (W)	M8	2-1/0	30-50	
		≡	◆	6-2	22-30	
		ℓ1 (r), ℓ2(∗)	M4	14 - 10	2 - 5.5	
50751F	C099	L1 (R), L2 (S), L3 (T), ⊖, ⊕1, T1 (U), T2 (V), T3 (W)	M8	2/0-1/0	50-60	
		≡	◆	4-2	22-30	
		ℓ1 (r), ℓ2(∗)	M4	14 - 10	2 - 5.5	
50900F	C130	L1 (R), L2 (S), L3 (T), ⊖, ⊕1, T1 (U), T2 (V), T3 (W)	M10	3/0-300	80-150	
		≡	◆	4-2/0	22-60	
		ℓ1 (r), ℓ2(∗)	M4	14 - 10	2 - 5.5	
51100F	C172	L1 (R), L2 (S), L3 (T), ⊖, ⊕1, T1 (U), T2 (V), T3 (W)	M12	300-400	150-200	
		≡	◆	4-2/0	22-60	
		ℓ1 (r), ℓ2(∗)	M4	14 - 10	2 - 5.5	
51600F	C200	L1 (R), L2 (S), L3 (T), ⊖, ⊕1, T1 (U), T2 (V), T3 (W)	M12	350-400	180-200	
		≡	◆	3-2/0	30-60	
		ℓ1 (r), ℓ2(∗)	M4	14 - 10	2 - 5.5	

\* Consult local electrical codes for wire sizing requirements.

◆Indicates terminal uses a pressure lug.



**Table 1-2. Terminal Functions and Voltages of Main Circuit**

SECTION A. 230V					
TERMINAL	FUNCTION				
	New Model No. CIMR-G5M	20P41F - 27P51F	20111F - 20151F	20181F 20221F	20300F - 20750F
	Old Model No. GPD515C-	A003 - A033	A049 - A064	A080, - A096	A130 - A300
L1 (R) L2 (S) L3 (T)	Three phase Main circuit input power supply 200 / 208 / 220V at 50 Hz; 200 / 208 / 220 / 230V at 60 Hz				
T1 (U) T2 (V) T3 (W)	Three phase AC output to motor 0V to max. input voltage level				
B1 B2	DB Resistor terminals (B1 & B2)		-----		
⊖					
⊕1 ⊕2	DC Reactor terminals (⊕1 & ⊕2) DC Bus terminals (⊕1 & ⊖)			-----	
⊕3	-----	DB Unit terminals (⊕3 & ⊖)			
ℓ <sub>1</sub> (r) ℓ <sub>2</sub> (z)	-----			Power for heat sink fan: ℓ <sub>1</sub> to ℓ <sub>2</sub> : 230 VAC	
≡	Ground terminal (100 ohms or less)				
SECTION B. 460V					
TERMINAL	FUNCTION				
	New Model No. CIMR-G5M	40P41F - 40151F	40181F - 40451F	40551F - 43000F	
	Old Model No. GPD515C-	B001 - B034	B041 - B096	B128 - B605	
L1 (R) L2 (S) L3 (T)	Three phase Main circuit input power supply 380 / 400 / 415 / 460V at 50/60 Hz				
T1 (U) T2 (V) T3 (W)	Three phase AC output to motor 0V to max. input voltage level				
B1 B2	DB Resistor terminals (B1 & B2)		-----		
⊖					
⊕1 ⊕2	DC Reactor terminals (⊕1 & ⊕2) DC Bus terminals (⊕1 & ⊖)			-----	
⊕3	-----	DB Unit terminals (⊕3 & ⊖)			
ℓ <sub>1</sub> (r) ℓ <sub>2</sub> (z) ℓ <sub>2</sub> 200 (z200) ℓ <sub>2</sub> 400 (z400)	-----		Power for heat sink fan: ℓ <sub>1</sub> to ℓ <sub>2</sub> : 230 VAC	Power for heat sink fan: ℓ <sub>1</sub> to ℓ <sub>2</sub> 200: 230 Vac ℓ <sub>1</sub> to ℓ <sub>2</sub> 400: 460 Vac	
≡			Ground terminal		

----- indicates that terminals are not present.

**Table 1-2. Terminal Functions and Voltages of Main Circuit**

SECTION C. 600V				
TERMINAL	FUNCTION			
	New Model No. CIMR-G5M	51P51F - 50151F	50181F - 50221F	50301F - 51600F
	Old Model No. GPD515C-	C003 - C022	C027 - C032	C041 - C200
L1 (R) L2 (S) L3 (T)	Three phase Main circuit input power supply 500 / 575 / 600V at 50 Hz / 60HZ			
T1 (U) T2 (V) T3 (W)	Three phase AC output to motor 0V to max. input voltage level			
B1 B2	DB Resistor terminals (B1 & B2)			-----
⊖				
⊕1 ⊕2	DC Reactor terminals (⊕1 & ⊕2) DC Bus terminals (⊕1 & ⊖)	DB Units terminals (⊕1 & ⊖) (C041 to C200 only) DC Bus terminals (⊕1 & ⊖)		
ℓ1 (r) ℓ2 (z)	-----	Power for heat sink fan: ℓ1 to ℓ2 : 600 VAC		
≡	Ground terminal (100 ohms or less)			

## Main Circuit Configuration Block Diagrams 230V

CIMR-G5M20P41F to 27P51F  
GPD515C-A003 to -A033

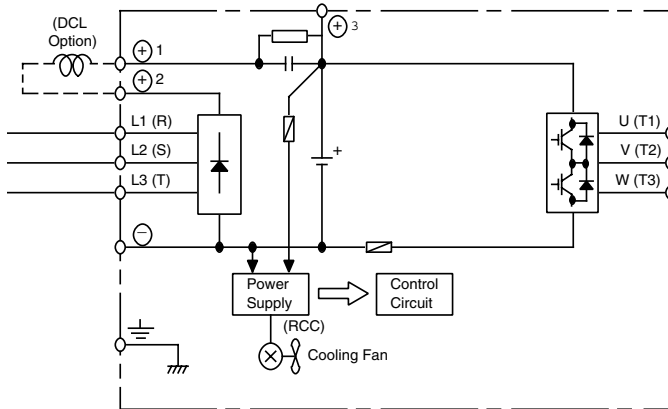
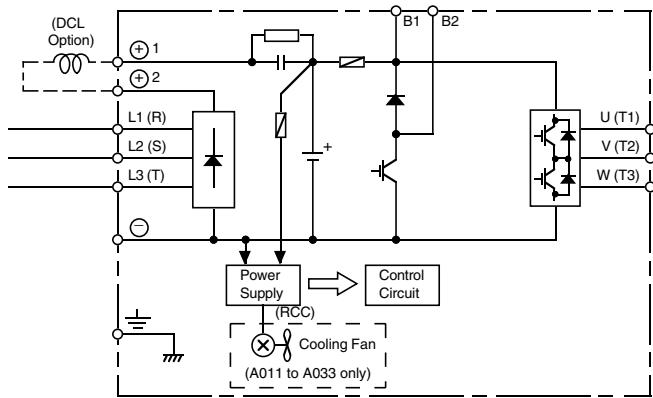

CIMR-G5M20111F to 20151F  
GPD515C-A049 to -A064

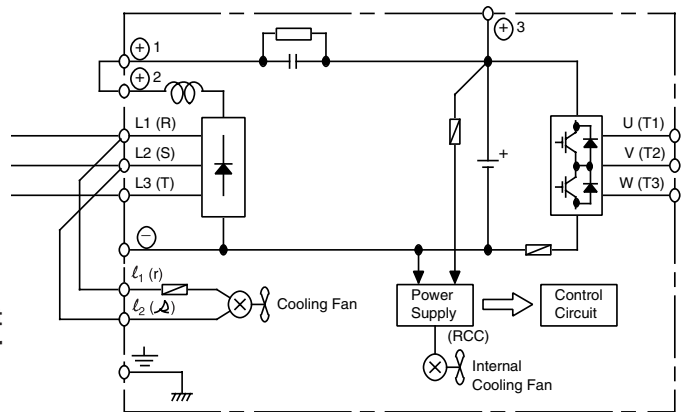

CIMR-G5M20181F, 20221F  
GPD515C-A080, -A096

**When using DC input as main circuit power, connect 230Vac to control power transformer terminals  $\ell$  (r) and  $\ell$  (s).**

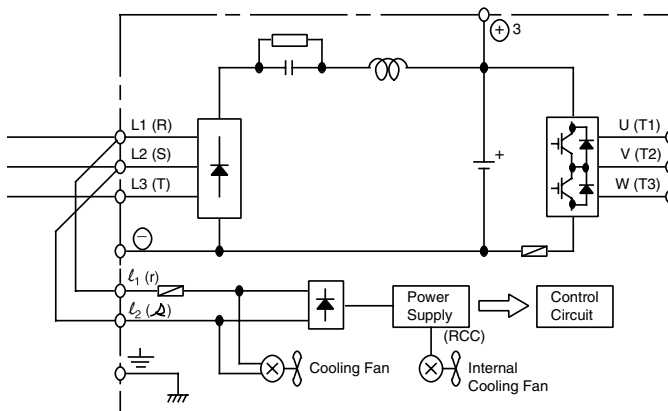

CIMR-G5M20300F to 20750F  
GPD515C-A130 to -A300

**When using DC input as main circuit power, connect 230Vac to control power transformer terminals  $\ell$  (r) and  $\ell$  (s).**

## Main Circuit Configuration Block Diagrams 460V

CIMR-G5M40P41F to 40151F  
GPD515C- B001 to - B034

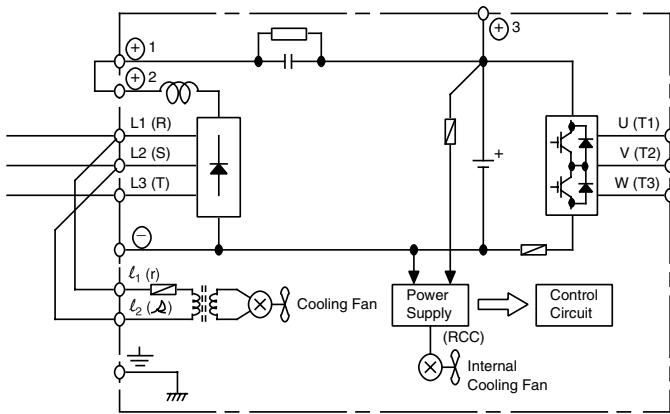
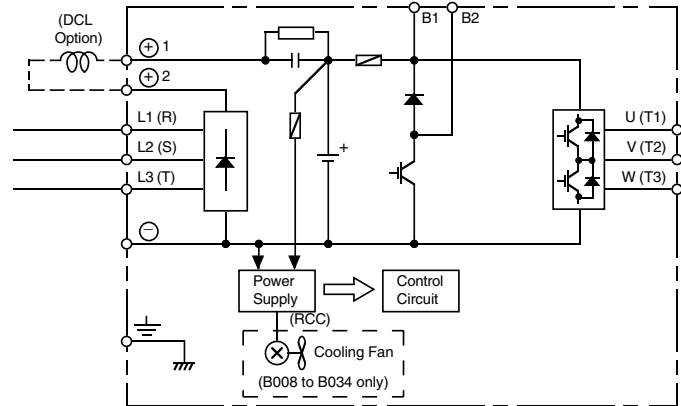

CIMR-G5M40181F to 40451F  
GPD515C- B041 to - B096

**When using DC input as main circuit power, connect 460Vac to control power transformer terminals  $l_1$  (r) and  $l_2$  (s).**

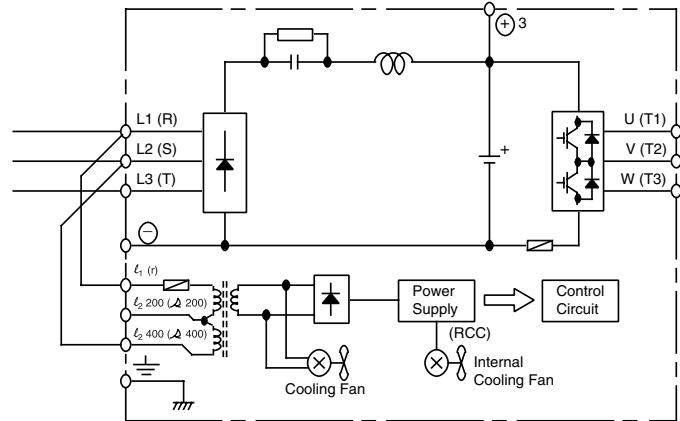

CIMR-G5M40551F to 41600F  
GPD515C- B128 to - B302

**When using DC input as main circuit power, connect 460Vac to control power transformer terminals  $l_1$  (r) and  $l_2$  400 (s400).**

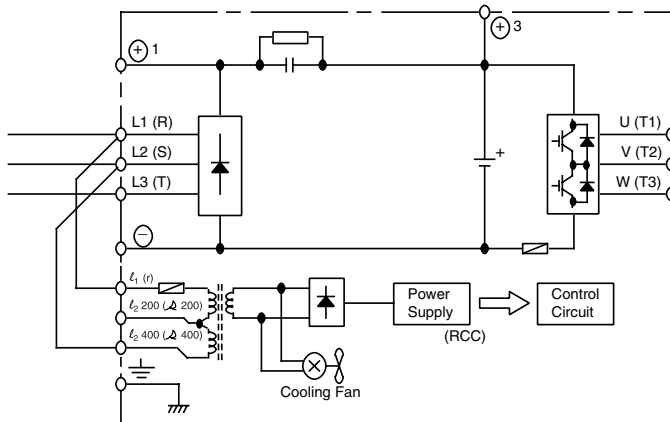

CIMR-G5M41850F to 43000F  
GPD515C- B340 to - B605

**When using DC input as main circuit power, connect 460Vac to control power transformer terminals  $l_1$  (r) and  $l_2$  400 (s400).**

## Main Circuit Configuration Block Diagrams 600V

CIMR-G5M51P51F to 50151F  
GPD515C- C003 to - C022

**When using DC input as main circuit power, connect 600Vac to control power transformer terminals r and s.**

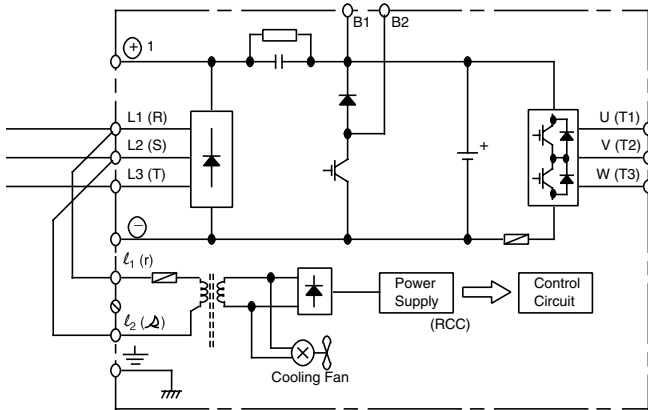
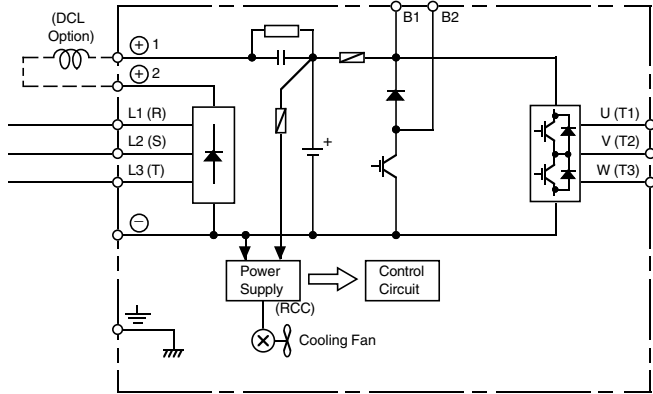

CIMR-G5M50181F to 50221F  
GPD515C-C027 to -C032

**When using DC input as main circuit power, connect 600Vac to control power transformer terminals r and s.**

CIMR-G5M50301F to 51600F  
GPD515C-C041 to -C200

**When using DC input as main circuit power, connect 600Vac to control power transformer terminals r and s.**

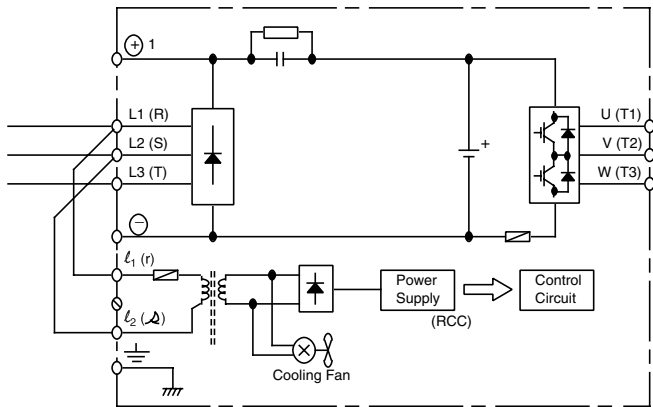

## 1.4.2 Grounding

- The drive must be solidly grounded using the main circuit ground terminal. ⚡
- If Drive is installed in a cabinet with other equipment, ground leads for all equipment should be connected to a common low-impedance ground point within the cabinet.
- The supply neutral should be connected to the ground point within the cabinet.
- Select appropriate ground wire size from Table 1-1.
- Make all ground wires as short as practical.
- NEVER ground the drive in common with welding machines or other high power electrical equipment.
- Where several drives are used, ground each directly to the ground point (see Figure 1-1). DO NOT FORM A LOOP WITH THE GROUND LEADS.
- When connecting a motor to the drive's output terminals, include a separate ground wire. Attach ground wire solidly to motor frame and to drive's ground terminal. ⚡
- When using armored or shielded cable for connection between drive and motor, solidly connect armor or shield to motor frame, and to the drive's ground terminal. ⚡

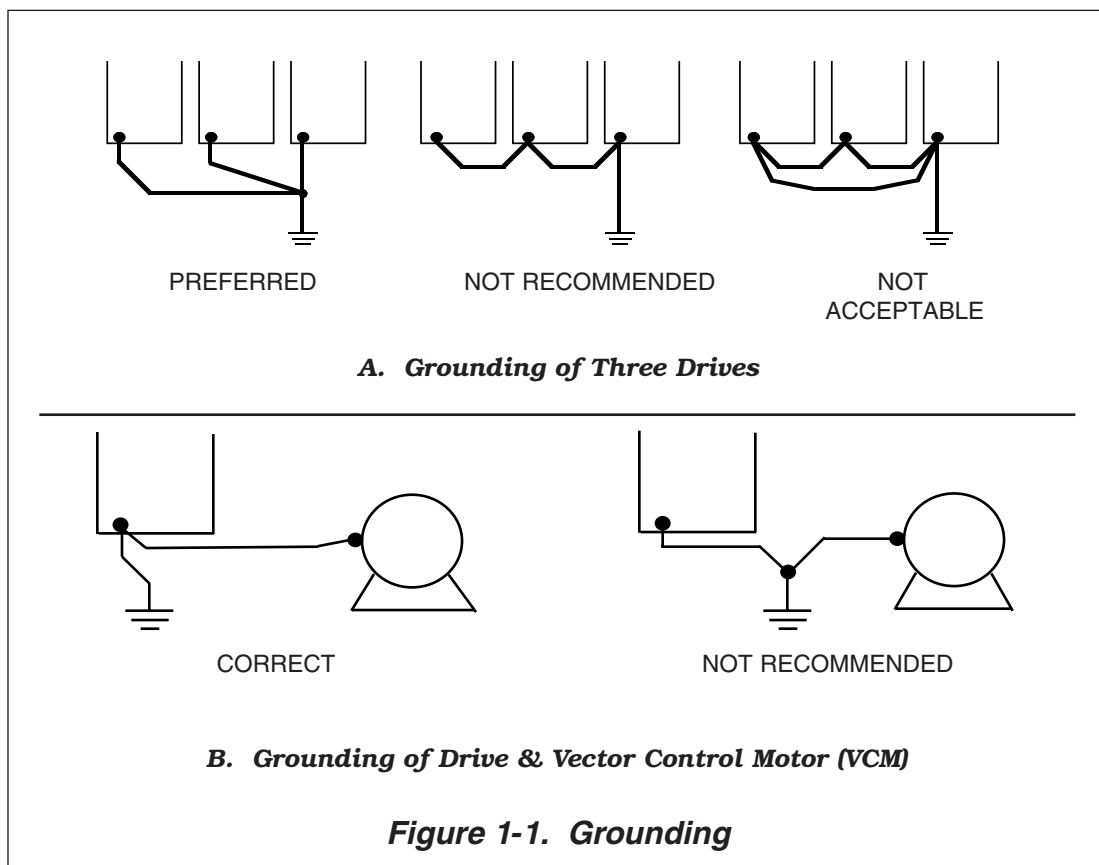

## 1.4.3 Auxiliary Input and Output Power Option Devices

A disconnect device (circuit breaker, contactor, disconnect switch, etc.) should NOT be used as a means of starting and stopping the drive or motor.

A disconnect device can be installed for emergency stop purposes, but when that disconnect device is opened, there may be loss of electrical braking.

Figure 1-2 is a factory guideline for proper wiring practices and relative locations within the electrical path from the line to the load. It does not imply what devices are needed for a particular application, nor does it show what devices were shipped with a particular order. Therefore, disregard those items in the diagram which are not being used in your installation. However, it *is* recommended that an input or DC reactor be used with models GPD515C-A003 thru -A064 (CIMR-G5M20P41F thru 20151F), -B001 thru -B034 (40P41F thru 40151F), and -C003 thru -C062 (51P51F thru 51451F) when wired to a source of 600 kVA or greater. Mount all optional power devices close to the drive, and keep electrical connections as short as possible.

**NOTES**

1. Connect drive ground terminal or panel to earth ground. Always use low impedance paths and connections.
2. Mount input and output RFI filters physically as close to the drive as possible (on the same panel, if possible). Filters should have a solid connection from filter ground terminal to the cabinet ground point. If multiple input or output RFI filters are used, they must be wired in parallel.
3. Shield individual conductors with metallic conduit, or use armored or shielded cable.
4. Connect output conduit armored cable or shielded cable in a manner that allows it to act as an unbroken shield from the drive panel to the motor casing.
5. RF noise filter (different from RFI filter) part no. 05P00325-0023 is a delta wye capacitor network which is wired in parallel with the drive input terminals. On the smaller drives with die cast chassis, it must be mounted externally. On the larger drives with sheet metal chassis, it may be mounted inside the area where the input power wiring enters the drive. On units equipped with bypass, it may be wired to the primary side of the circuit breaker and mounted to the bypass panel or sidewall.
6. Connection points:

	Drive Terminals
Input Power	L1, L2, L3
Output Power	T1, T2, T3

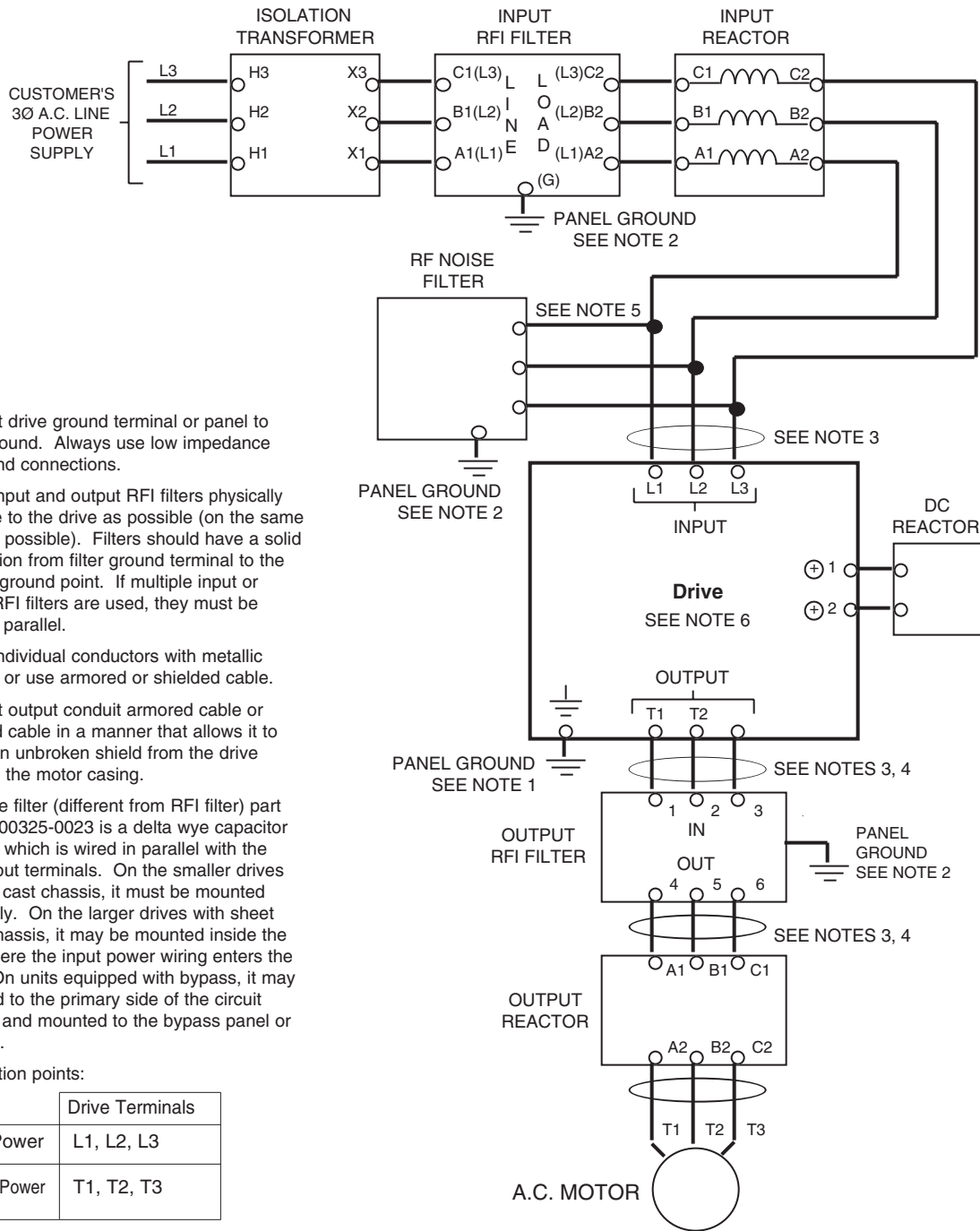

**Figure 1-2. Customer Connection Diagram For Isolation Transformers, Input Reactors, Input RFI Filters, DC Reactors, Output Reactors and Output RFI Filters**

### 1.4.3a Conformance to European EMC Directive

In order to conform to EMC standards, the following methods are required for line filter application, cable shielding and drive installation. The following explains the outline of the methods.

The line filter and the drive must be mounted on the same metal plate. The filter should be mounted as close to the drive as practical. The cable must be kept as short as possible and the metal plate should be securely grounded. The ground of the line filter and the drive must be bonded to the metal plate with as much bare-metal contact as possible.

For main circuit input cables, a screened cable is recommended within the panel, and is also suggested for external connections. The screen of the cable should be connected to a solid ground. For the motor cables, a screened cable (max. 20 m) must be used and the screen of the motor cable should be connected to ground at both ends by a short connection, again using as much bare-metal contact as possible.

For more detailed explanation, refer to document EZZ006543, "Installation Guidelines For EMC Directive using Yaskawa AC Drive Products."

Table 1-2.1 and Figure 1-2A show the line filter list for EMC standards and the installation/wiring of the drive and line filter.

**Table 1-2.1. Line Filters for Drive**

New Drive Model Number CIMR-G5M	Old Drive Model Number GPD 515C-	Line Filter			
		Part Number 05P00325-	Rated Current (A)	Mass (kg)	Dimensions in mm <sup>(1)</sup> L x W x D <sup>(2)</sup>
40P41F, 40P71F	B001, B003	0106	8	1.8	320 x 143 x 46
41P51F, 43P71F, 44P01F	B004, B008, B011	0103	20	1.8	320 x 143 x 46
45P51F, 47P51F	B014, B021	0104	30	3.0	350 x 213 x 51
40111F, 40151F	B027, B034	0105	60	5.3	435 x 268 x 56
40181F, 40221F	B041, B052	0107	80	7.5	350 x 180 x 90
40301F	B065	0108	100	13.8	420 x 200 x 130
40371F	B080	0109	150	13.8	480 x 200 x 160
40451F	B096	0110	160	25	480 x 200 x 160
40551F	B128	0111	180	25	480 x 200 x 160
40750F, 41100F	B165, B224	0112	300	25	480 x 200 x 160
41600F	B302	0113	400	45	588 x 250 x 200
41850F	B340	0119	500	Consult Factory	
42200F	B450	0120	600		
43000F	B605	0121	900		

<sup>(1)</sup> 1mm = 0.0394 inches

<sup>(2)</sup> D is the distance the filter will extend outward from the surface of the metal plate.



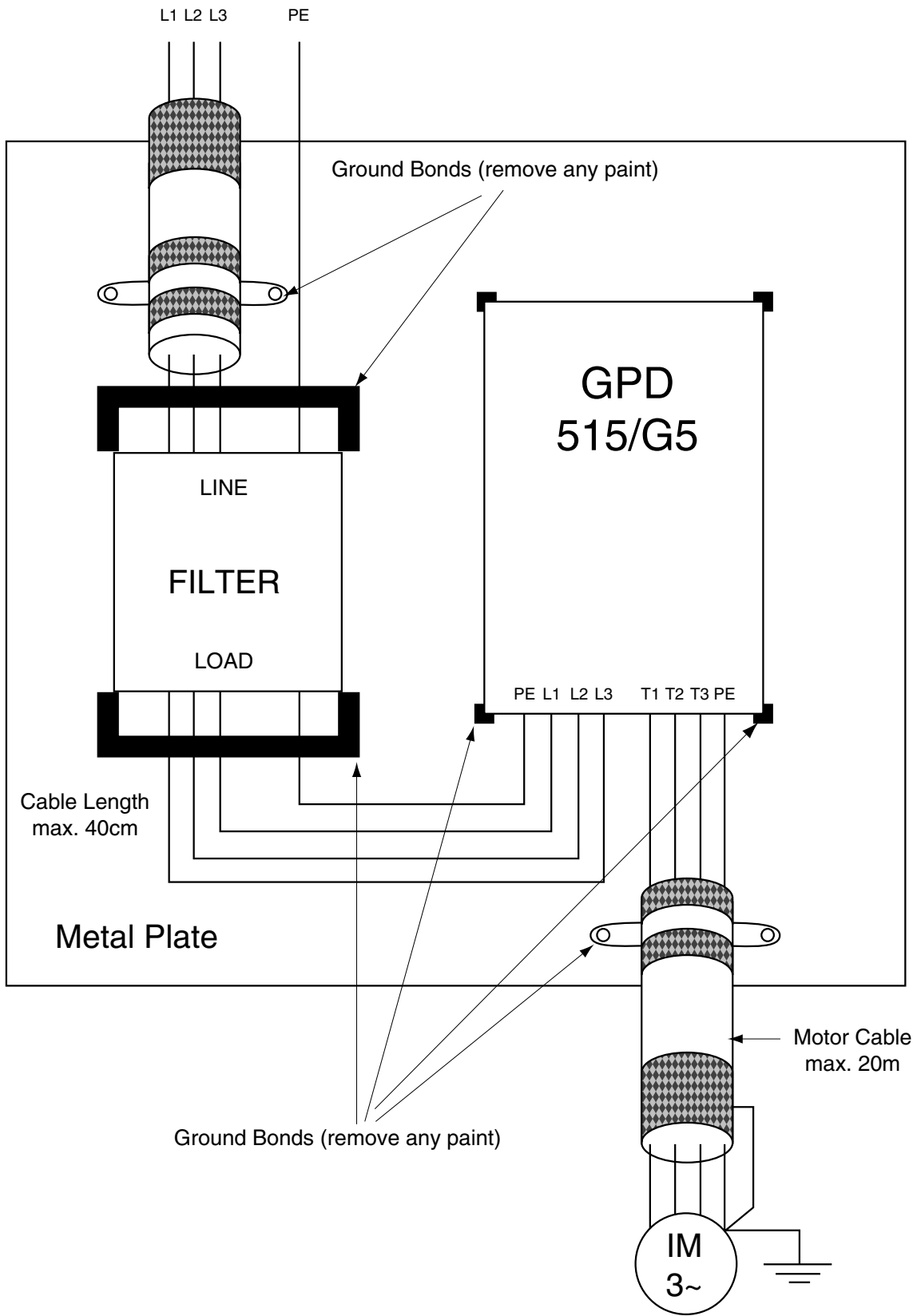

**Figure 1-2A. Installation of Line Filter and GPD 515/G5**

#### 1.4.4 Control Circuit

All basic control circuit (signal) interconnections are shown in the appropriate diagram:

- Interconnections for external two-wire control in combination with the Digital Operator are shown in Figure 1-3.
- Interconnections for external three-wire control in combination with the Digital Operator are shown in Figure 1-4.

Make wire connections according to Figures 1-3, 1-4 and Table 1-3; observe the following:

- Signal Leads: Terminals 1-8 & 11; 12-17 & 33; and 21-27.
- Control Leads: Terminals 9 & 10 and 18-20.
- Use twisted shielded or twisted-pair shielded wire (20-16 AWG [0.5 – 1.25mm<sup>2</sup>]) for control and signal circuit leads. The shield sheath **MUST** be connected at the drive end **ONLY** (terminal 12). The other end should be dressed neatly and left unconnected (floating). See Figure 1-2B.
- Signal leads and feedback leads (PG) must be separated from control leads main circuit leads and any other power cables to prevent erroneous operation caused by electrical noise.
- Lead length should **NOT EXCEED** 164 feet (50 meters). Wire sizes should be determined considering the voltage drop.
- All AC relays, contactors and solenoids should have RC surge suppressors installed across their coils.
- All DC relays, contactors and solenoids should have diodes installed across their coils.

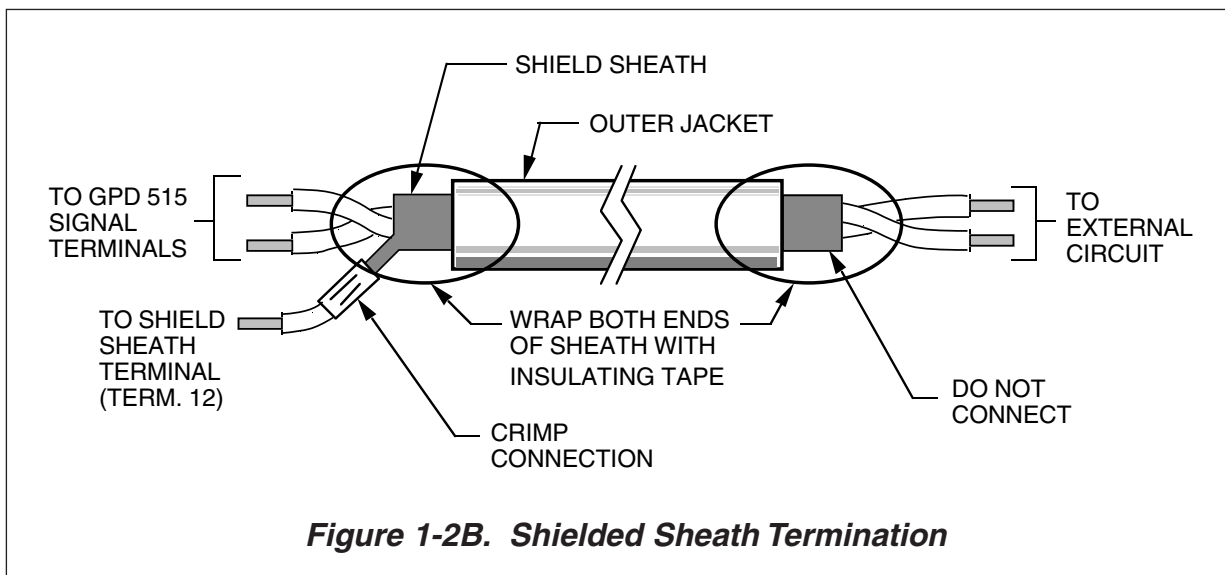



**Table 1-3. Terminal Functions and Signals of Control Circuit**

TERMINAL	FUNCTIONS	DESCRIPTION / SIGNAL LEVELS
1	2-WIRE CONTROL: Forward Run / Stop signal (See NOTE 1)	Run at closed, stop at open (See NOTE 2)
	3-WIRE CONTROL: Run signal	Run at closed (See NOTE 2)
2	2-WIRE CONTROL: Reverse Run / Stop signal (See NOTE 1)	Run at closed, stop at open (See NOTE 2)
	3-WIRE CONTROL: Stop signal	Stop at open (See NOTE 2)
3	External fault input	Fault at closed (see NOTES 2 & 3). When the External Fault input is applied, the drive's Fault relay trips (shutdown) and the motor coasts to a stop. The Digital Operator displays "EF3" failure.
4	Fault Reset input (external)	Fault Reset at closed (see NOTES 2 & 3). The Fault Reset input will reset the Fault relay, if the drive is in "stopped" condition. Both Forward Run/Stop signal and Reverse Run/Stop signal must be OPEN.
5	Multi-step Speed Reference 1	Effective when closed (See NOTES 2 & 3)
6	Multi-step Speed Reference 2	Effective when closed (See NOTES 2 & 3)
7	Jog Reference	Run at preset jog frequency when closed
8	External baseblock	Drive output stops when closed
9, 10	Multi-function contact output (N.O.). One of 18 functions are available, by setting of parameter H2-01 .	Contact capacity: 250 Vac at 1A or less 30 Vdc at 1A or less
11	Sequence control input common for terminals 1-8.	Sequence control input 0 V
12	Connection for shield sheath of signal leads	- - - -
13	Frequency reference analog input (voltage); auto input – can be changed to manual by setting of parameter H3-01 .	0 to +10V (20K ohms) -10 to +10V (20K ohms)
14	Frequency reference analog input (current); can be changed to voltage input by setting of parameter H3-08 and cutting jumper J1.	4-20mA (250 ohms)
15	Frequency reference power supply	+15V (Control power supply for frequency setting: max 20 mA)
17	Frequency reference analog input common	0 V
18	Multi-function contact output (N.O./N.C.).	Closed at fault
19		Open at fault
20		Common
		Contact capacity: 250 Vac at 1A or less 30 Vdc at 1A or less

**Table 1-3. Terminal Functions and Signals of Control Circuit - Continued**

TERMINAL	FUNCTIONS	DESCRIPTION / SIGNAL LEVELS	
21	Multi-function analog monitor 1 (+)	Output current or output frequency is selectable	Type of analog signal (operation parameter) to be output is selected by setting of parameters <b>H4-01</b> and <b>H4-04</b> . Monitor output: 0 to +11V; 2 mA maximum
22	Multi-function analog monitor (-)		
23	Multi-function analog monitor 2 (+)		
25	Multi-function open collector output 1	One of 18 functions available, by setting of parameters <b>H2-02</b> and <b>H2-03</b> .	Photocoupler insulation output: +48V, 50 mA maximum
26	Multi-function open collector output 2		
27	Multi-function open collector output common		0V
33	Frequency reference power supply		-15V Control power supply for frequency setting: max 20 mA

NOTES:

1. When Forward Run and Reverse Run inputs are both closed for more than 500 ms, the Digital Operator displays a blinking “**EF**” alarm code and the motor (if rotating) is decelerated by the drive to a stop. This stop condition is not stored by the drive (on Digital Operator, red LED at **STOP** key does not light); **IF ONE OF THE INPUTS IS OPENED, THE MOTOR WILL IMMEDIATELY START UP AGAIN.**
2. Terminals 1-8 source +24 Vdc (8mA max.) and operate in a Low = True (ON) configuration when connected to terminal 11.

When using relays for input to terminals 1-8, use relays with highly reliable contacts (for very small current) with a capacity of 30 Vdc or more and rated current of 100mA or higher. When using transistor (open collector) input, use transistors with rated voltage of 35 Vdc or more and rated current of 100mA or more.

3. These terminals are multi-function inputs. The indicated functions are their settings, based on a 2-Wire reset. For 3-Wire reset definitions, and other settings, see descriptions for “Multi-Function Input Terminals”, parameters **H1-01** thru **H1-06** , in paragraph 5.32.



## 1.4.5 Interconnection – 2-Wire Control Operation - Figure 1-3.

Notes referred to in figure 1-3.

- \* – Indicates components not supplied.
  - \*\* – Branch circuit protection (circuit breaker or input fuses) must be supplied by customer.
  - – Indicates customer connection terminal. Wire only to terminals shown. Note that not all terminals shown are available in all ratings – see Tables 1-1 and 1-2.
  - ( ) – Indicates alternate terminal marking, i.e., (R) and L1.
  - ▲ – Function labels shown for these terminals are determined by factory settings of parameters **H1-01** through **H1-06**. See paragraph 5.32.
  - – Function labels shown for these terminals are determined by factory settings of parameters **H2-01** through **H2-03**. See paragraph 5.33.
  - ◆ – Function labels shown for these terminals are determined by factory settings of parameters **H3-01**, **-04**, **-05**, **-08**, & **-09**. See paragraphs 5.19 & 5.30.
  - – Function labels and signal levels shown for these terminals are determined by factory settings of parameters **H4-01** & **H4-04**. See paragraph 5.31.
1. If only a remote Manual Speed pot (1RH) is used, 3SS is not needed; in that case, a jumper must be added between terminals 5 and 11. This jumper will override both the Auto and Digital Operator frequency references, regardless of the programming of parameter **b1-01**. If you are using a remote speed command or the Digital Operator, DO NOT install this jumper. See paragraph 5.19.
  2. The Drive Electronic Thermal Overload function (parameters **L1-01**, **L1-02**) meets standards set by UL and cUL for motor thermal overload protection. If local code requires separate mechanical overload protection, an overload relay should be installed, interlocked with the drive as shown. It should be the manual reset type to prevent automatic restart following a motor fault and subsequent contact reclosure after cool down.
  3. Insulated twisted shielded wire is required.  
2-conductor #18 GA. (Belden #8760 or equivalent). 3-conductor #18 GA. (Belden #8770 of equivalent). Connect shield ONLY AT DRIVE END. Stub and isolate other end.
  4. Digital Operator is standard on every drive. Remote operators, as shown, may not be required.
  5. Customer to connect terminal  $\perp$  to earth ground (100  $\Omega$  or less, 230V; 10  $\Omega$  or less, 460V and 600V).
  6. Wire only one of the inputs as an Auto Reference. If **H3-09** is set to “1F”, terminals 13 and 14 are added for the internal frequency reference.
  7. If the Dynamic Braking (DB) option is used, wire per Appendix 6 instructions.
  8. An optional DC reactor may be added for harmonic attenuation, if needed; see separate instruction sheet for wiring.
  9. If application does not allow reverse operation, **b1-04**, Reverse Run Prohibit, should be set to “1” (Reverse Run Disabled), and the Reverse Run/Stop input can be eliminated.
  10. If supplying the drive with DC voltage instead of 3 $\phi$  AC, remove jumpers from terminals  $l1$  and  $l2$  and connect a separate 1 $\phi$  AC supply to  $l1$  and  $l2$  instead.
  11. Use  $l1$  (R) and  $l2$  (S) for single-phase input. Note that for drives up through GPD515C-A064, -B034, and -C032 (CIMR-G5M20151F, 40151F, and 50221F) must be derated by 50%. Consult factory for derating of larger drives.

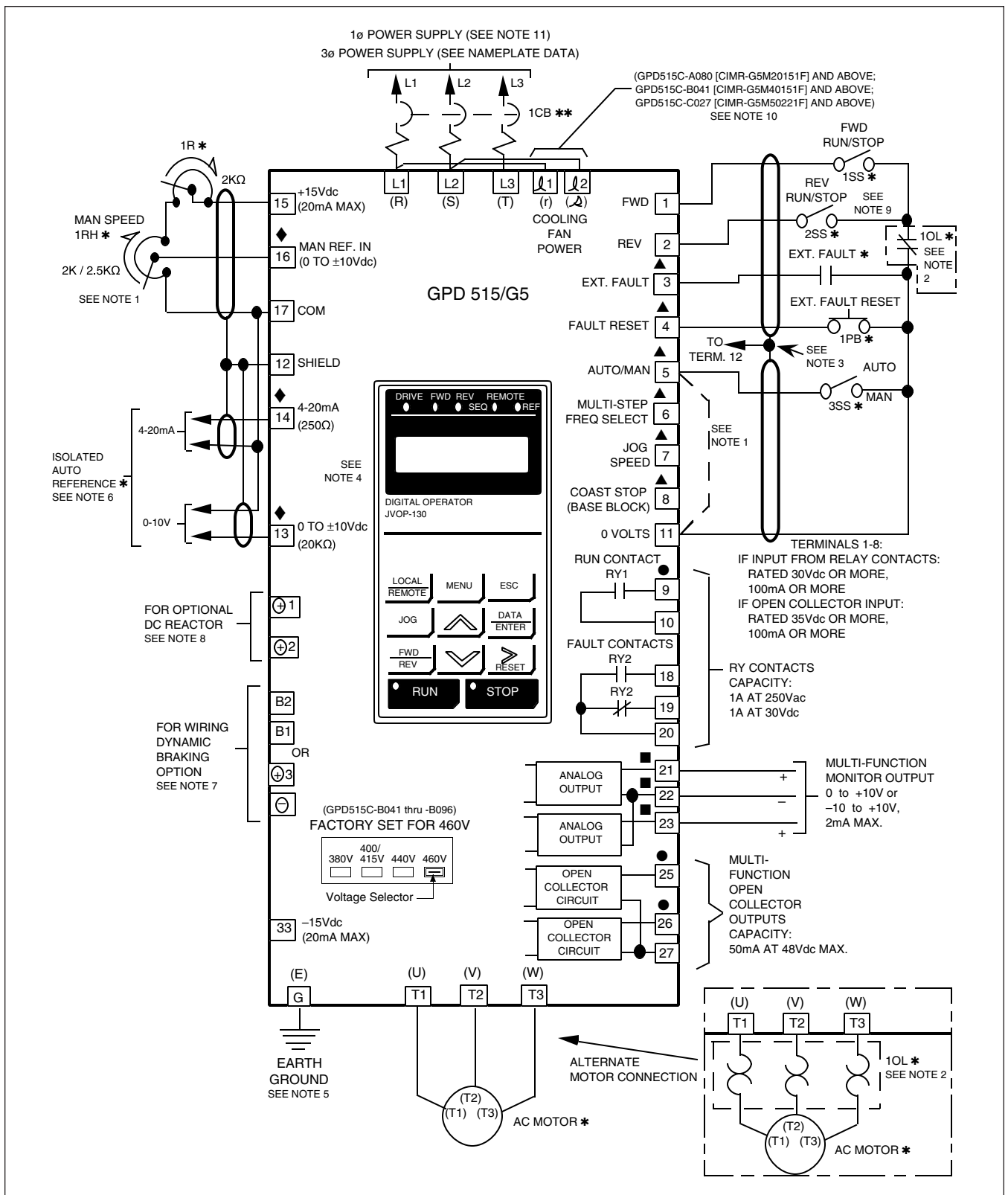

BASIC INTERCONNECT DIAGRAM FOR 2-WIRE CONTROL

**Figure 1-3. 230, 460 or 600V Interconnections - 2-Wire Control**  
(with parameters b1-01 = 1, b1-02 = 1, H1-01 = 24, H1-02 = 14, H1-03 = 3,  
H1-04 = 4, H1-05 = 6, and H1-06 = 8)

See Figure 1-5 for Closed-loop PG connections



## 1.4.6 Interconnection – 3-Wire Control Operation Figure 1-4.

Notes referred to in figure 1-4.

- \* – Indicates components not supplied.
  - \*\* – Branch circuit protection (circuit breaker or input fuses) must be supplied by customer.
  - – Indicates customer connection terminal. Wire only to terminals shown. Note that not all terminals shown are available in all ratings – see Tables 1-1 and 1-2.
  - ( ) – Indicates alternate terminal marking, i.e., (R) and L1.
  - ▲ – Function labels shown for these terminals are determined by factory settings of parameters **H 1 - 01** through **H 1 - 06** : **H 1 - 01** = 24, **H 1 - 02** = 14, **H 1 - 03** = 0, **H 1 - 04** = 3, **H 1 - 05** = 4, **H 1 - 06** = 6. See paragraph 5.32.
  - – Function labels shown for these terminals are determined by factory settings of parameters **H 2 - 01** through **H 2 - 03** . See paragraph 5.33.
  - ◆ – Function labels shown for these terminals are determined by factory settings of parameters **H 3 - 01**, **- 0 4**, **- 0 5**, **- 0 8**, & **- 0 9** . See paragraphs 5.19 & 5.30.
  - – Function labels and signal levels shown for these terminals are determined by factory settings of parameters **H 4 - 01** & **H 4 - 04** . See paragraph 5.31.
1. If only a remote Manual Speed pot (1RH) is used, 2SS is not needed; in that case, a jumper must be added between terminals 6 and 11. This jumper will override both the Auto and Digital Operator frequency references, regardless of the programming of parameter **b 1 - 01** . If you are using a remote speed command or the Digital Operator, DO NOT install this jumper. See paragraph 5.19.
  2. The Drive Electronic Thermal Overload function (parameters **L 1 - 01** , **L 1 - 02** ) meets standards set by UL and cUL for motor thermal overload protection. If local code requires separate mechanical overload protection, an overload relay should be installed, interlocked with the drive as shown. It should be the manual reset type to prevent automatic restart following a motor fault and subsequent contact reclosure after cool down.
  3. Insulated twisted shielded wire is required.  
2-conductor #18 GA. (Belden #8760 or equivalent). 3-conductor #18 GA. (Belden #8770 of equivalent). Connect shield ONLY AT DRIVE END. Stub and isolate other end.
  4. Digital Operator is standard on every drive. Remote operators, as shown, may not be required.
  5. Customer to connect terminal  $\perp$  to earth ground (100  $\Omega$  or less, 230V; 10  $\Omega$  or less, 460V and 600V).
  6. Wire only one of the inputs as an Auto Reference. If **H 3 - 09** is set to " 1F ", terminals 13 and 14 are added for the internal frequency reference.
  7. If the Dynamic Braking (DB) option is used, wire per Appendix 6 instructions.
  8. An optional DC reactor may be added for harmonic attenuation, if needed; see separate instruction sheet for wiring.
  9. If application does not allow reverse operation, **b 1 - 04** , Reverse Run Prohibit, should be set to " 1 " (Reverse Run Disabled), and the Forward/Reverse input can be eliminated.
  10. If supplying the drive with DC voltage instead of 3 $\phi$  AC, remove jumpers from terminals  $\ell 1$  and  $\ell 2$  and connect a separate 1 $\phi$  AC supply to  $\ell 1$  and  $\ell 2$  instead.
  11. Use  $\ell 1$  (R) and  $\ell 2$  (S) for single-phase input. Note that for drives up through GPD515C-A064, -B034, and -C032 (CIMR-G5M20151F, 40151F, and 50221F) must be derated by 50%. Consult factory for derating of larger drives.

### CAUTION

**Before running, parameter A1-03 must be set to " 0 ". Resetting drive constant A1-03 to " 2220 " may cause the motor to run in the reverse direction WITHOUT A RUN COMMAND, and possibly result in damage to the equipment or personal injury.**

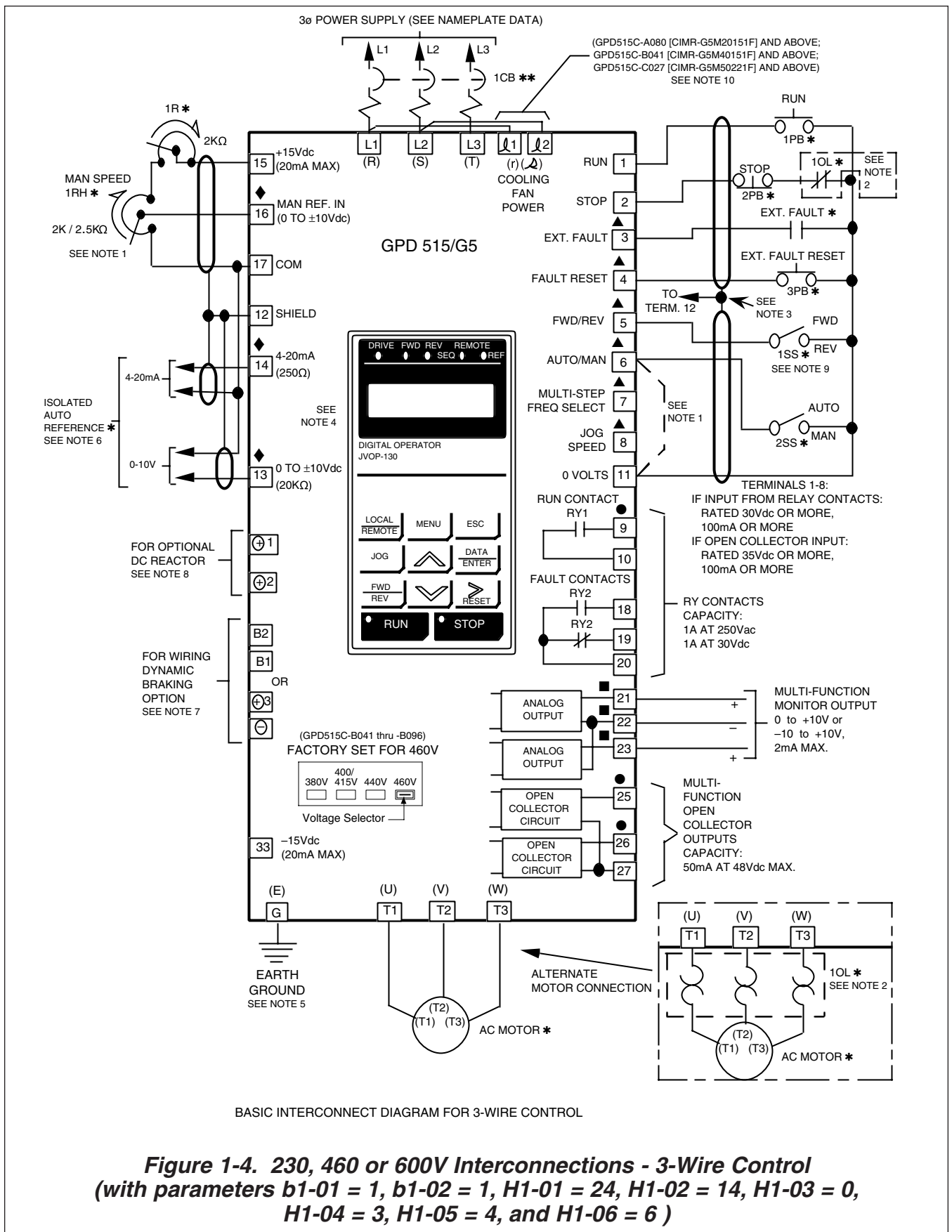

See Figure 1-5 for Closed-loop PG connections

### 1.4.7 Encoder Feedback

If either the Flux Vector (A1-02 = 3) or Volts Per Hertz with Encoder (A1-02 = 1) control method is desired, an encoder feedback board for the drive is required.

The drive can accept many types of encoder feedback. Table 1-4 shows which option board is needed for each type of encoder.

**Table 1-4. Encoder feedback option board types.**

Option Board	Control Method(s)	Electrical Input Scheme	Required Signals From Encoder
PG-X2	ALL	Quadrature, Line Driver	A+, A-, B+, & B- (Z+, Z- optional)
PG-W2*	ALL	Dual Input, Quadrature, Line Driver	A+, A-, B+, B-, (Z+, Z- optional)
PG-B2	ALL	Quadrature, Single Ended	A, B, & Common
PG-D2	All, Except Flux Vector	Line Driver	A+ & A-
PG-A2	All, Except Flux Vector	Single Ended	A & Common

\*Accepts inputs from two encoders. Primarily used with custom software.

The most common encoder used with the drive is the Quadrature, Line Driver style encoder. When an encoder of this type is used, a PG-X2 option board must be mounted onto the drive. The encoder then wires to the PG-X2 option board.

Table 1-5 and Figure 1-5 show connections for the PG-X2 and some typical encoders.

**Table 1-5. Encoder (PG) Connection**

FUNCTION	PG-X2 TERMINAL TA1	EPC (1) MODEL 755A	DYNAPAR H-20 (2) (Pin #)	DYNAPAR HS-35	LAKESHORE/NORTHSTAR SL-56
+12V (200mA)	1	White	D	D	6
0V	2	Black	F	F	1
+5V	3	No Connection	No Connection	No Connection	No Connection
A+	4	Red	A	A	3
A-	5	Green	H	H	8
B+	6	Brown	B	B	2
B-	7	Yellow	I	I	7
SHIELD	TA3	Shield	E	No Connection	10

(1) For PG, EPC Model 755A, Orange and Blue wires are not used.

(2) For PG, Dynapar H-20, pins C, G, and J are not used.

The PG-X2 card also has a connector TA2 which provides processed PG signal output for use by an external pulse monitor. This connection can be made according to Figure 1-5.

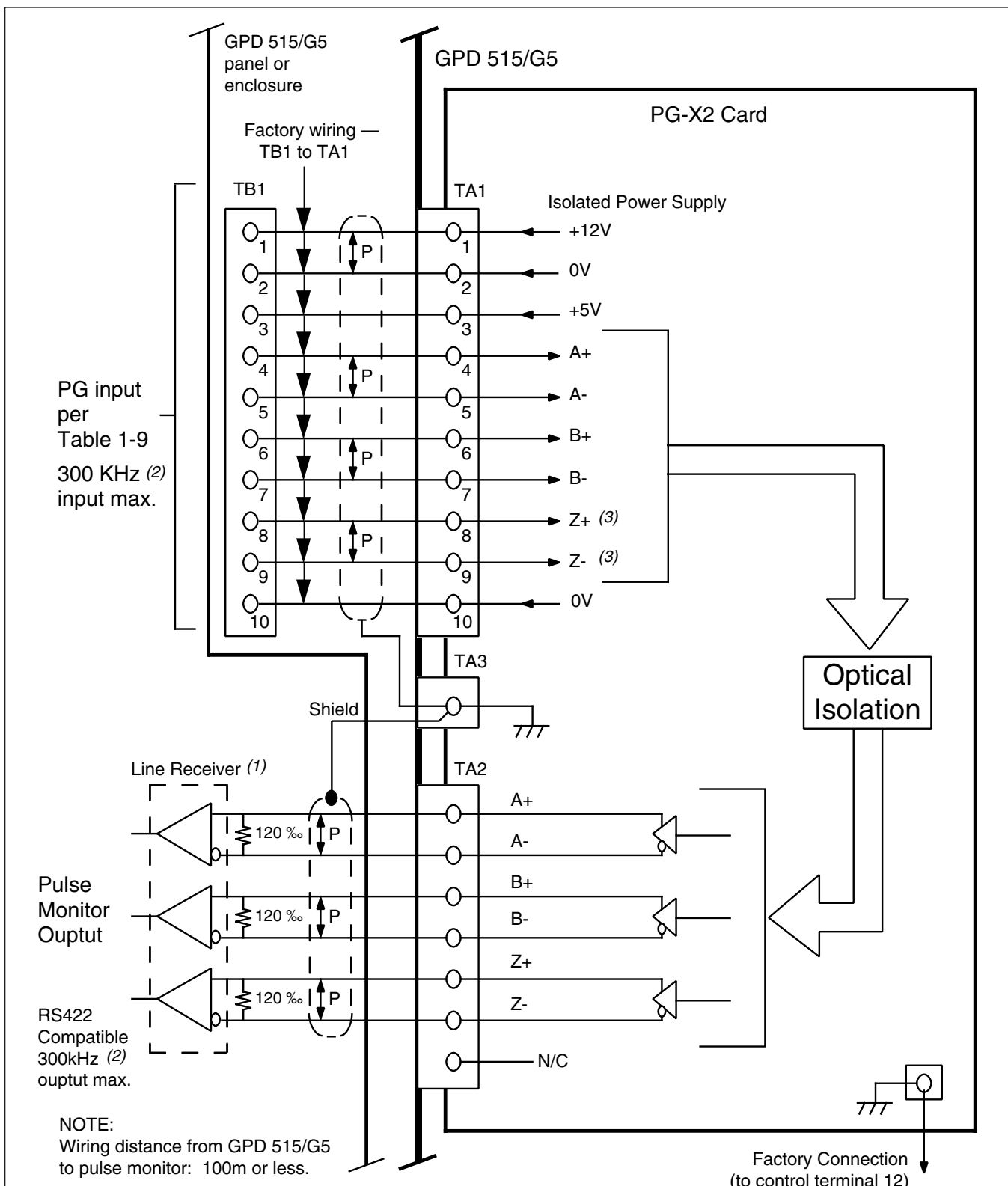

**Figure 1-5. PG-X2 Card Input/Output Connections**



## Section 2. INITIAL START-UP ("LOCAL" CONTROL)

### 2.1 PRE-POWER CHECKS

- Verify wires are properly connected and no erroneous grounds exist.
- Remove all debris from the drive enclosure. Check for loose wire clippings.
- Verify all mechanical connections inside the drive are tight.
- Verify motor is not connected to load.
- Apply input power only after the front cover is in place. DO NOT remove the front cover or Digital Operator while input power is on.
- **For 460V, GPD515C-B041 thru -B096 (CIMR-G5M40P41F thru 40451F):** Verify that the drive power voltage select connector, located at lower left corner inside drive chassis (see Figure 2-1), is positioned correctly for the input power line voltage. Voltage is preset to 460V at the factory. Reposition, if required, to match nominal line voltage.

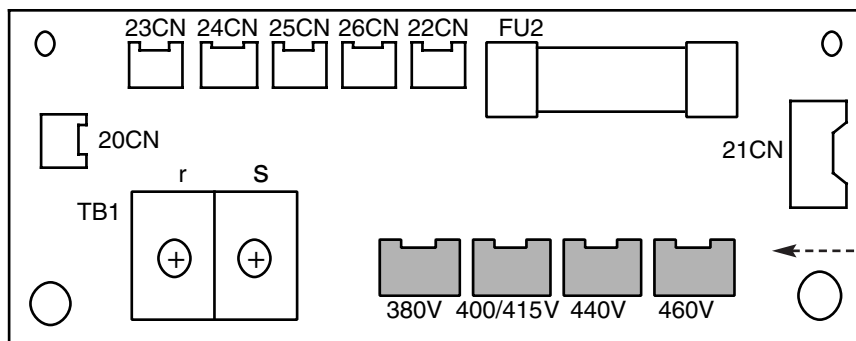

Figure 2-1a. Power Voltage Selection in 460V drive

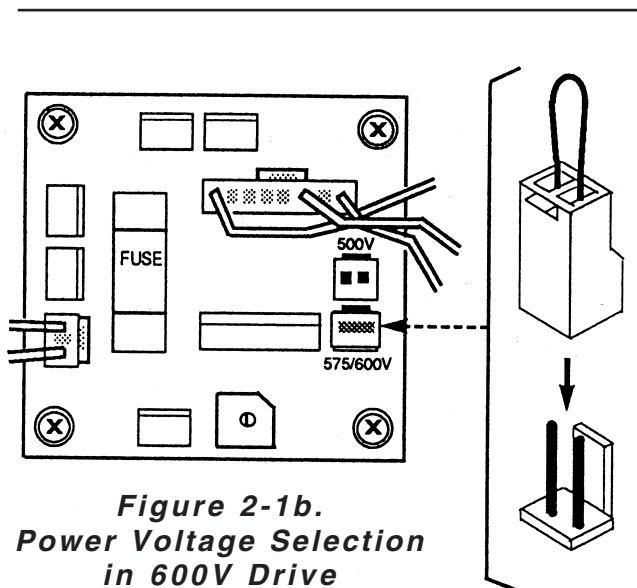

Figure 2-1b.  
Power Voltage Selection  
in 600V Drive

**For 600V, GPD515C-C027 thru -C200 (CIMR-G5M50181F thru 51600F).**

Verify that the drive power voltage select connector, located at lower left corner inside drive chassis (see Figure 2-1b), is positioned correctly for the input power line voltage. Voltage is preset to 600V at the factory. Reposition, if required, to match nominal line voltage.

## 2.2 CONTROL METHOD SELECTION

- Determine the proper control method for the application using Figure 2-2.

NOTE: For a more complete determination of control method, consult factory.

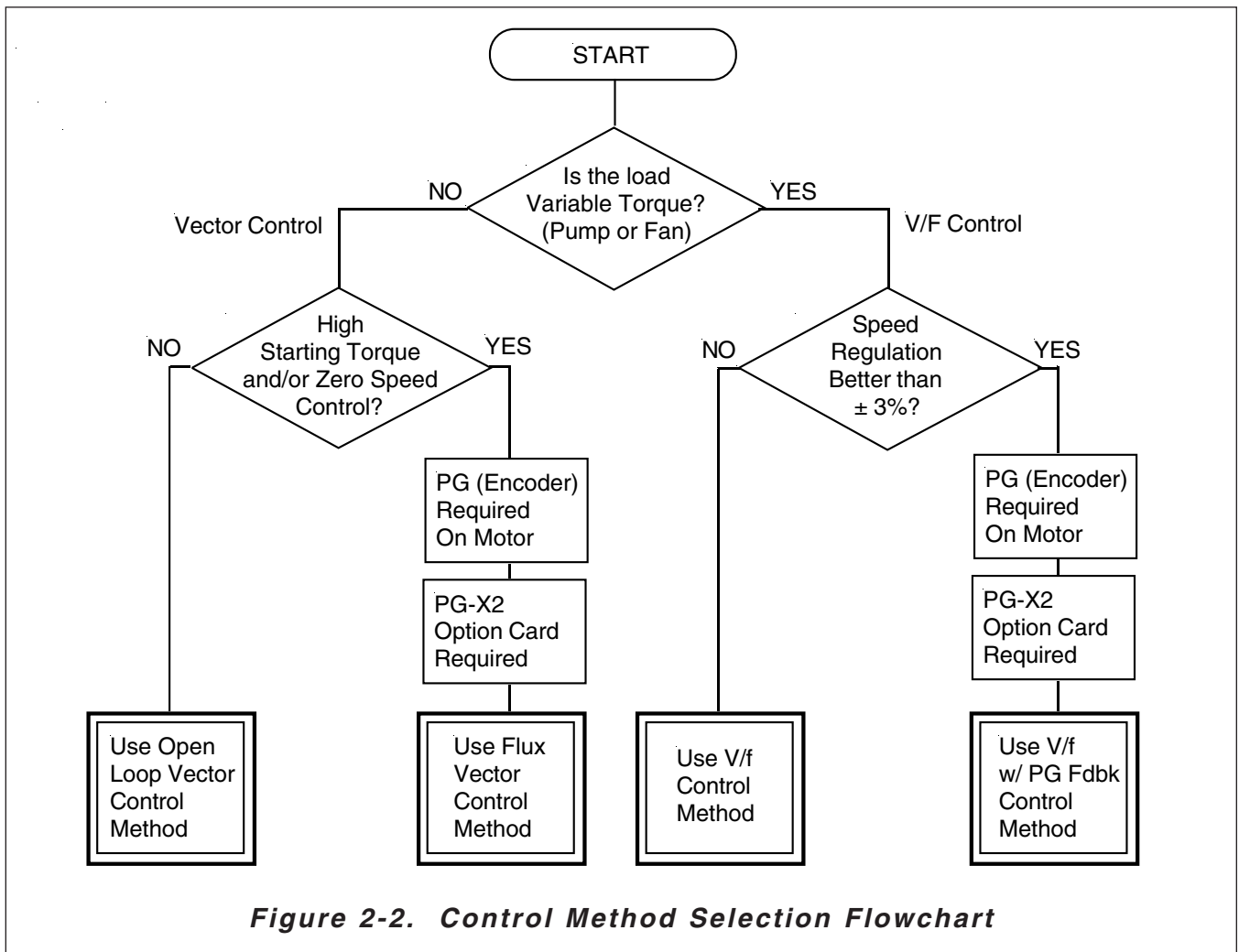









- If the selected control method requires a PG encoder on the motor, verify that a PG-X2 card is installed in the drive (see separate option installation sheet for details) and that all encoder wiring is correct.

- Proceed to the correct Power On and Preliminary Checks procedure:







Control Method	POWER ON AND PRELIMINARY CHECKS Section
Open Loop Vector	2.2a
Flux Vector	2.2b
V/f	2.2c
V/f with PG Feedback	2.2d

## 2.2a POWER ON AND PRELIMINARY CHECKS - OPEN LOOP VECTOR CONTROL









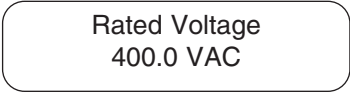

DESCRIPTION	KEY SEQUENCE	DIGITAL OPERATOR DISPLAY
Apply input power to the drive. If the display is not in English, go to section 2.3, "CHANGING THE LANGUAGE ON THE DIGITAL OPERATOR".		
Set the control method of the drive to Open Loop Vector. (Set <b>A1-02</b> to 2.)  NOTE: The drive leaves the factory set for Open Loop Vector control — this step may not be required.	Press <b>MENU</b> , then 	** Main Menu ** Initialize
	Press <b>DATA ENTER</b> , then  twice	Control Method V/F Control
	Press <b>DATA ENTER</b> , then set drive to Open Loop Vector using:  	A1-02= 2 Open Loop Vector
	Write value to memory by pressing <b>DATA ENTER</b>	Entry Accepted  briefly, then Control Method Open Loop Vector
Set parameter access level to Advanced. This allows all parameters to be viewed and modified.	Press <b>MENU</b> , then 	** Main Menu ** Initialize
	Press <b>DATA ENTER</b> , then 	Access Level Quick Start
	Press <b>DATA ENTER</b> , then set drive to Advanced using:  	A1-01= 4 Advanced Level
	Write value to memory by pressing: <b>DATA ENTER</b>	Entry Accepted  briefly, then Access Level Advanced Level

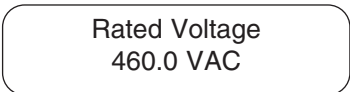

**2.2a (continued)**

DESCRIPTION	KEY SEQUENCE	DIGITAL OPERATOR
<p>Check the motor rotation using the JOG function.</p> <p>NOTE: The frequency reference for this operation comes from <b>d1-09</b> and is factory set to 6 Hz.</p> <p><b>WARNING</b>  <b>THE NEXT KEY-PRESS WILL CAUSE THE MOTOR TO MOVE; TAKE APPROPRIATE PRECAUTIONS.</b></p>	<p>Press , then </p>	<p>Frequency Ref U1-01= 0.00 HZ</p>
	<p>If either or both of the <b>SEQ</b> and <b>REF</b> lights are on, press </p>	
<p>The motor should ramp up to speed, and rotation should be counter-clockwise if the <b>FWD</b> light is on. Rotation should be clockwise if the <b>REV</b> light is on. If rotation is incorrect, reverse any two motor leads, then repeat the motor rotation check.</p>	<p>Press &amp; hold </p>	<p>Frequency Ref U1-01= 6.00 HZ</p> <p><b>RUN</b> light will illuminate</p>
	<p>Release </p>	
<p><b>Run the Auto-Tuning routine:</b></p> <p><b>WARNING</b>  <b>THE MOTOR WILL MOVE WHEN AUTO-TUNING IS EXECUTED! TAKE PROPER PRECAUTIONS!</b></p> <p><b>CAUTION</b>  <b>Motor should be disconnected from the load before executing the auto-tuning routine.</b></p> <p>NOTE: If the motor cannot be disconnected from the load, or if Auto-Tuning fails, motor parameters should be entered manually. See section 2.4 for the procedure.</p> <p>Enter the motor nameplate values needed to perform Auto-tuning</p>	<p>Press , then  3 times</p>	<p><b>** Main Menu **</b>  <b>Auto-Tuning</b></p>

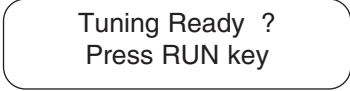
**2.2a (continued)**

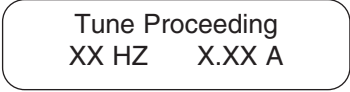
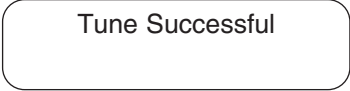
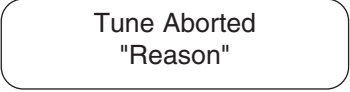
DESCRIPTION	KEY SEQUENCE	DIGITAL OPERATOR
<p>When all of the parameters are entered, execute Auto-Tuning.</p> <p>The drive will first output current to the motor, then run the motor at a high speed. During tuning, the following message will appear:</p> <p>If no problems are encountered, the following message will appear:</p> <ul style="list-style-type: none"> <li>If a problem occurs during Auto-Tuning execution, see section 6.2, AUTO TUNING FAULTS AND CORRECTIVE ACTIONS.</li> </ul> <p><b>Proceed to section 2.5, "TEST RUN USING DIGITAL OPERATOR"</b></p>	Press  twice	
	Set the correct <u>Nameplate</u> voltage of the motor, using:   	
	Write the value to memory by pressing 	 briefly, then 
	Enter the current and the rest of the parameters following a similar procedure to that of the motor nameplate voltage.	
	Press 	
	Press 	  
	<ul style="list-style-type: none"> <li>If a problem occurs during Auto-Tuning execution, see section 6.2, AUTO TUNING FAULTS AND CORRECTIVE ACTIONS.</li> </ul>	

## 2.2b POWER ON AND PRELIMINARY CHECKS - FLUX VECTOR CONTROL

- Ensure motor is disconnected from load. To assure safety, disconnect the coupling or belt which connects the motor with the machine, so that motor operation is isolated prior to test operation.
- Verify the encoder to be used meets the following criteria: Line driver type (8830, 88C30), output pulse levels of 5-12V, and quadrature (A+, A-, B+, B-). Power supply for the encoder from the PG-X2 card is capable of 200mA @ 12VDC or 200mA @ 5VDC. Do not use both of these power supplies simultaneously.
- Verify that the encoder PPR (pulses per revolution) and expected motor speed do not exceed the bandwidth of the PG-X2 card, using the following formula:





$$300,000 \text{ Hz} \geq 1.2 \times (\text{Max Speed in RPM} / 60) \times \text{PPR of encoder}$$

NOTE: Speed in RPM = 120 x frequency / number of motor poles

















Example: Encoder PPR = 1024, Maximum speed = 1750 RPM

$$300,000 \text{ Hz} \geq 1.2 \times (1750 / 60) \times 1024$$



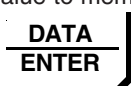

$$300,000 \text{ Hz} \geq 35,840 \text{ Hz} \quad - \quad \text{Acceptable}$$

DESCRIPTION	KEY SEQUENCE	DIGITAL OPERATOR DISPLAY
Apply input power to the drive. If the display is not in English, go to section 2.3, "CHANGING THE LANGUAGE ON THE DIGITAL OPERATOR".		
Set the control method of the drive to Flux Vector (Set A1-02 to 3.)	Press <b>MENU</b> , then 	** Main Menu ** Initialize
	Press <b>DATA ENTER</b> , then  twice	Control Method Open Loop Vector
	Press <b>DATA ENTER</b> , then set drive to Flux Vector using:  	A1-02= 3 Flux Vector
	Write value to memory by pressing <b>DATA ENTER</b>	Entry Accepted briefly, then Control Method Flux Vector







**2.2b (continued)**

DESCRIPTION	KEY SEQUENCE	DIGITAL OPERATOR DISPLAY
<p>Set parameter access level to Advanced. This allows all parameters to be viewed and modified.</p>	Press  , then 	<div style="border: 1px solid black; border-radius: 10px; padding: 5px; text-align: center;"> <b>** Main Menu **</b> Initialize           </div>
	Press  , then 	<div style="border: 1px solid black; border-radius: 10px; padding: 5px; text-align: center;">             Access Level Quick Start           </div>
	Press  , then set drive to Advanced using:  	<div style="border: 1px solid black; border-radius: 10px; padding: 5px; text-align: center;">             A1-01= 4 Advanced Level           </div>
	Write value to memory by pressing: 	<div style="border: 1px solid black; border-radius: 10px; padding: 5px; text-align: center;">             Entry Accepted           </div> <p style="text-align: center;">briefly, then</p> <div style="border: 1px solid black; border-radius: 10px; padding: 5px; text-align: center;">             Access Level Advanced Level           </div>
<p>Set PG Pulses/Rev to the correct value. (NOTE: For a Yaskawa vector motor, the correct value is 1024.)</p>	Press  , then  twice	<div style="border: 1px solid black; border-radius: 10px; padding: 5px; text-align: center;"> <b>** Main Menu **</b> Programming           </div>
	Press  , then  4 times	<div style="border: 1px solid black; border-radius: 10px; padding: 5px; text-align: center;">             Group F Options           </div>
	Press  3 times	<div style="border: 1px solid black; border-radius: 10px; padding: 5px; text-align: center;">             PG Pulses/Rev 00600           </div>
	Set the correct PPR, using:   	<div style="border: 1px solid black; border-radius: 10px; padding: 5px; text-align: center;">             PG Pulses/Rev 01024           </div>
	Write value to memory by pressing: 	<div style="border: 1px solid black; border-radius: 10px; padding: 5px; text-align: center;">             Entry Accepted           </div> <p style="text-align: center;">briefly, then</p> <div style="border: 1px solid black; border-radius: 10px; padding: 5px; text-align: center;">             PG Pulses/Rev F1-01= 1024           </div>











**2.2b (continued)**

DESCRIPTION	KEY SEQUENCE	DIGITAL OPERATOR DISPLAY
<p>Display motor speed.</p>	<p>Press , then ,</p> <p>then </p> <p>Press , then  4 times</p>	<div data-bbox="1101 424 1446 516" style="border: 1px solid black; border-radius: 10px; padding: 5px; text-align: center;">                     Function U1 Monitor                 </div> <div data-bbox="1101 546 1446 638" style="border: 1px solid black; border-radius: 10px; padding: 5px; text-align: center;">                     Motor Speed U1-05= 0.00 HZ                 </div>
<p>Rotate the motor shaft counter-clockwise by hand (as viewed from the load end of the motor).</p> <ul style="list-style-type: none"> <li>• As the shaft is turned counter-clockwise, a low positive speed should be indicated.</li> <li>• As the shaft is turned clockwise, a low negative speed should be indicated.</li> <li>• If the speed doesn't change when the motor shaft is rotated, check encoder wiring and connections. The pulses from the encoder can also be checked; see section 6.6, "CHECKING ENCODER PULSES."</li> <li>• If the polarity is wrong, switch the channels on the input to the PG-X2 card (on terminal block TA1, swap wires at terminals 4 &amp; 6 and swap wires at terminals 5 &amp; 7).</li> </ul>		<div data-bbox="1101 772 1446 865" style="border: 1px solid black; border-radius: 10px; padding: 5px; text-align: center;">                     Motor Speed U1-05= 2.38 HZ                 </div> <div data-bbox="1101 915 1446 1008" style="border: 1px solid black; border-radius: 10px; padding: 5px; text-align: center;">                     Motor Speed U1-05=- 1.47 HZ                 </div>

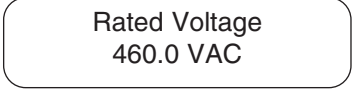



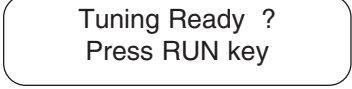

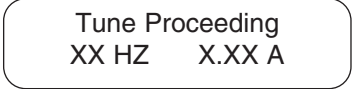
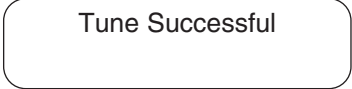
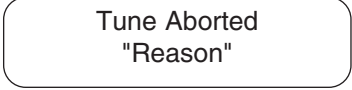

**2.2b (continued)**

DESCRIPTION	KEY SEQUENCE	DIGITAL OPERATOR DISPLAY
<p>Check the motor rotation using the JOG function.</p> <p>NOTE: The frequency reference for this operation comes from <b>d1-09</b> and is factory set to 6 Hz.</p> <p><b>WARNING</b>  <b>THE NEXT KEY-PRESS WILL CAUSE THE MOTOR TO MOVE; TAKE APPROPRIATE PRECAUTIONS.</b></p>	<p>Press , then </p> <p>If either or both of the <b>SEQ</b> and <b>REF</b> lights are on, press </p>	<p>Frequency Ref U1-01= 0.00 HZ</p>
<p>The motor should ramp up to speed, and rotation should be counter-clockwise if the <b>FWD</b> light is on. Rotation should be clockwise if the <b>REV</b> light is on. If the motor does not accelerate smoothly or oscillates, reverse any two motor leads, then repeat the motor rotation check.</p>	<p>Press &amp; hold </p> <p>Release </p>	<p>Frequency Ref U1-01= 6.00 HZ</p> <p><b>RUN</b> light will illuminate</p>
<p>Run the Auto-Tuning routine:</p> <p><b>WARNING</b>  <b>THE MOTOR WILL MOVE WHEN AUTO-TUNING IS EXECUTED! TAKE PROPER PRECAUTIONS!</b></p> <p><b>CAUTION</b>  <b>Motor should be disconnected from the load before executing the auto-tuning routine.</b></p> <p>NOTE: If the motor cannot be disconnected from the load, or if Auto-Tuning fails, motor parameters should be entered manually. See section 2.4 for the procedure.</p> <p>Enter the motor nameplate values needed to perform Auto-tuning</p>	<p>Press , then  3 times</p>	<p>** Main Menu ** Auto-Tuning</p>

**2.2b (continued)**













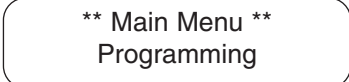

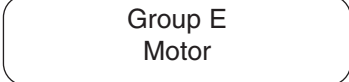

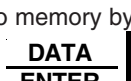

DESCRIPTION	KEY SEQUENCE	DIGITAL OPERATOR DISPLAY
<p>When all of the parameters are entered, execute Auto-Tuning.</p> <p>The drive will first output current to the motor, then run the motor at a high speed. During tuning, the following message will appear:</p> <p>If no problems are encountered, the following message will appear:</p> <ul style="list-style-type: none"> <li>If a problem occurs during Auto-Tuning execution, see section 6.2, AUTO TUNING FAULTS &amp; CORRECTIVE ACTIONS .</li> </ul> <p><b>Proceed to section 2.5, "TEST RUN USING DIGITAL OPERATOR"</b></p>	Press  twice	
	Set the correct <u>Nameplate</u> voltage of the motor, using:   	
	Write the value to memory by pressing 	 <p>briefly, then</p> 
	Enter the current and the rest of the parameters following a similar procedure to that of the motor nameplate voltage.	
	Press 	
	Press 	 
<ul style="list-style-type: none"> <li>If a problem occurs during Auto-Tuning execution, see section 6.2, AUTO TUNING FAULTS &amp; CORRECTIVE ACTIONS .</li> </ul>		
<p><b>Proceed to section 2.5, "TEST RUN USING DIGITAL OPERATOR"</b></p>		

## 2.2c POWER ON AND PRELIMINARY CHECKS - V/f CONTROL

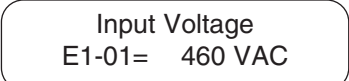

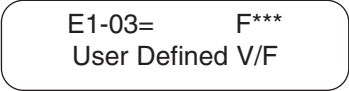

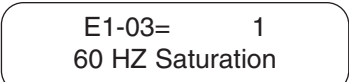
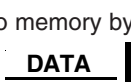
DESCRIPTION	KEY SEQUENCE	DIGITAL OPERATOR DISPLAY
Apply input power to the drive. If the display is not in English, go to section 2.3, "CHANGING THE LANGUAGE ON THE DIGITAL OPERATOR".		
Set the control method of the drive to V/f Control. (Set <b>A1-02</b> to 0.)	Press <b>MENU</b> , then 	** Main Menu ** Initialize
	Press <b>DATA ENTER</b> , then  twice	Control Method Open Loop Vector
	Press <b>DATA ENTER</b> , then set drive to V/f Control using:  	A1-02= 0 V/F Control
	Write value to memory by pressing <b>DATA ENTER</b>	Entry Accepted  briefly, then Control Method V/F Control
Set parameter access level to Advanced. This allows all parameters to be viewed and modified.	Press <b>MENU</b> , then 	** Main Menu ** Initialize
	Press <b>DATA ENTER</b> , then 	Access Level Quick Start
	Press <b>DATA ENTER</b> , then set drive to Advanced using:  	A1-01= 4 Advanced Level
	Write value to memory by pressing: <b>DATA ENTER</b>	Entry Accepted  briefly, then Access Level Advanced Level

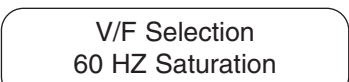

**2.2c (continued)**

DESCRIPTION	KEY SEQUENCE	DIGITAL OPERATOR DISPLAY
<p>Select the drive input voltage, then select an appropriate V/f pattern. Refer to section 5.38, "V/F PATTERN – STANDARD" or 5.39, "V/F PATTERN – CUSTOM".</p> <p>NOTE: A standard V/f pattern for a 60 HZ motor is pattern 1 (60 HZ Saturation).</p>	Press  , then  twice	
	Press  , then  3 times	
	Press 	
	Press  twice, then set the drive to the nominal input line voltage using:  	
	Write to memory by pressing: 	 briefly, then 
	Press  twice, then 	
	Then set the drive to desired V/F pattern using:  	
	Write to memory by pressing: 	 briefly, then 

**2.2c (continued)**

DESCRIPTION	KEY SEQUENCE	DIGITAL OPERATOR DISPLAY
<p>Check the motor rotation using the JOG function.</p> <p>NOTE: The frequency reference for this operation comes from <b>d1-09</b> and is factory set to 6 Hz.</p> <p><b>WARNING</b></p> <p><b>THE NEXT KEY-PRESS WILL CAUSE THE MOTOR TO MOVE; TAKE APPROPRIATE PRECAUTIONS.</b></p>	<p>Press , then </p> <p>If either or both of the <b>SEQ</b> and <b>REF</b> lights are on, press </p>	<p>Frequency Ref U1-01= 0.00 HZ</p>
<p>The motor should ramp up to speed, and rotation should be counter-clockwise if the <b>FWD</b> light is on. Rotation should be clockwise if the <b>REV</b> light is on. If rotation is incorrect, reverse any two motor leads, then repeat the motor rotation check.</p>	<p>Press &amp; hold </p> <p>Release </p>	<p>Frequency Ref U1-01= 6.00 HZ</p> <p><b>RUN</b> light will illuminate</p>
<p><b>Proceed to section 2.5, "TEST RUN USING DIGITAL OPERATOR"</b></p>		

## 2.2d POWER ON AND PRELIMINARY CHECKS - V/f WITH PG FEEDBACK

- Ensure motor is disconnected from load. To assure safety, disconnect the coupling or belt which connects the motor with the machine so that motor operation is isolated, prior to test operation.
- Verify the encoder to be used meets the following criteria: Line driver type (8830, 88C30), output pulse levels of 5-12V, and quadrature (A+, A-, B+, B-). Power supply for the encoder from the PG-X2 card is capable of 200mA @ 12VDC or 200mA @ 5VDC. Do not use both of these power supplies simultaneously.
- Verify that the encoder PPR (pulses per revolution) and expected motor speed do not exceed the bandwidth of the PG-X2 card, using the following formula:









$$300,000 \text{ Hz} \geq 1.2 \times (\text{Max Speed in RPM} / 60) \times \text{PPR of encoder}$$

NOTE: Speed in RPM = 120 x frequency / # of motor poles

















Example: Encoder PPR = 1024, Maximum speed = 1750 RPM

$$300,000 \text{ Hz} \geq 1.2 \times (1750 / 60) \times 1024$$















$$300,000 \text{ Hz} \geq 35,840 \text{ Hz} \quad - \quad \text{Acceptable}$$

DESCRIPTION	KEY SEQUENCE	DIGITAL OPERATOR DISPLAY
Apply input power to the drive. If the display is not in English, go to section 2.3, "CHANGING THE LANGUAGE ON THE DIGITAL OPERATOR".		
Set the control method of the drive to V/f w/PG Feedback (Set A1-02 to 1.)	Press  , then 	<b>** Main Menu **</b> Initialize
	Press  , then  twice	Control Method Open Loop Vector
	Press  , then set drive to V/F w/PG Fdbk using:  	A1-02= 1 V/F w/PG Fdbk
	Write value to memory by pressing 	Entry Accepted briefly, then  Control Method V/F w/PG Fdbk





**2.2d (continued)**

DESCRIPTION	KEY SEQUENCE	DIGITAL OPERATOR DISPLAY
<p>Set parameter access level to Advanced. This allows all parameters to be viewed and modified.</p>	<p>Press , then </p>	<p><b>** Main Menu **</b> Initialize</p>
	<p>Press , then </p>	<p>Access Level Quick Start</p>
	<p>Press , then set drive to Advanced using:  </p>	<p>A1-01= 4 Advanced Level</p>
	<p>Write value to memory by pressing: </p>	<p>Entry Accepted briefly, then Access Level Advanced Level</p>
<p>Set PG Pulses/Rev to the correct value. (NOTE: For a Yaskawa vector motor, the correct value is 1024.)</p>	<p>Press , then  twice</p>	<p><b>** Main Menu **</b> Programming</p>
	<p>Press , then  4 times</p>	<p>Group F Options</p>
	<p>Press  3 times</p>	<p>PG Pulses/Rev 00600</p>
	<p>Set the correct PPR, using:   </p>	<p>PG Pulses/Rev 01024</p>
	<p>Write value to memory by pressing: </p>	<p>Entry Accepted briefly, then PG Pulses/Rev F1-01= 1024</p>





**2.2d (continued)**

DESCRIPTION	KEY SEQUENCE	DIGITAL OPERATOR DISPLAY
<p>Select the drive input voltage, then select an appropriate V/F pattern. Refer to section 5.38, "V/F PATTERN – STANDARD" or 5.39, "V/F PATTERN – CUSTOM".</p> <p>NOTE: A standard V/F pattern for a 60 HZ motor is pattern 1 (60 HZ Saturation).</p>	Press  , then  twice	<div style="border: 1px solid black; border-radius: 10px; padding: 5px; text-align: center;"> <b>** Main Menu **</b>            Programming         </div>
	Press  , then  3 times	<div style="border: 1px solid black; border-radius: 10px; padding: 5px; text-align: center;">           Group E            Motor         </div>
	Press 	<div style="border: 1px solid black; border-radius: 10px; padding: 5px; text-align: center;">           Function E1            V/F Pattern         </div>
	Press  twice, then set the drive to the nominal input line voltage using:  	<div style="border: 1px solid black; border-radius: 10px; padding: 5px; text-align: center;">           Input Voltage            460 VAC         </div>
	Write to memory by pressing: 	<div style="border: 1px solid black; border-radius: 10px; padding: 5px; text-align: center;">           Entry Accepted         </div> <p style="text-align: center;">briefly, then</p> <div style="border: 1px solid black; border-radius: 10px; padding: 5px; text-align: center;">           Input Voltage            E1-01= 460 VAC         </div>
	Press  twice, then 	<div style="border: 1px solid black; border-radius: 10px; padding: 5px; text-align: center;">           E1-03= F***            User Defined V/F         </div>
	Then set the drive to desired V/F pattern using:  	<div style="border: 1px solid black; border-radius: 10px; padding: 5px; text-align: center;">           E1-03= 1            60 HZ Saturation         </div>
	Write to memory by pressing: 	<div style="border: 1px solid black; border-radius: 10px; padding: 5px; text-align: center;">           Entry Accepted         </div> <p style="text-align: center;">briefly, then</p> <div style="border: 1px solid black; border-radius: 10px; padding: 5px; text-align: center;">           V/F Selection            60 HZ Saturation         </div>



**2.2d (continued)**

DESCRIPTION	KEY SEQUENCE	DIGITAL OPERATOR DISPLAY
<p>Display motor speed.</p>	<p>Press , then ,</p> <p>then </p> <p>Press , then  4 times</p>	<div data-bbox="1101 424 1446 512" style="border: 1px solid black; border-radius: 10px; padding: 5px; text-align: center;">                     Function F1 Monitor                 </div> <div data-bbox="1101 546 1446 634" style="border: 1px solid black; border-radius: 10px; padding: 5px; text-align: center;">                     Motor Speed U1-05= 0.00 HZ                 </div>
<p>Rotate the motor shaft counter-clockwise by hand (as viewed from the load end of the motor).</p> <ul style="list-style-type: none"> <li>• As the shaft is turned counter-clockwise, a low positive speed should be indicated.</li> <li>• As the shaft is turned clockwise, a low negative speed should be indicated.</li> <li>• If the speed doesn't change when the motor shaft is rotated, check encoder wiring and connections. The pulses from the encoder can also be checked; see section 6.6, "CHECKING ENCODER PULSES."</li> <li>• If the polarity is wrong, switch the channels on the input to the PG-X2 card (on terminal block TA1, swap wires at terminals 4 &amp; 6 and swap wires at terminals 5 &amp; 7).</li> </ul>		<div data-bbox="1101 772 1446 861" style="border: 1px solid black; border-radius: 10px; padding: 5px; text-align: center;">                     Motor Speed U1-05= 2.38 HZ                 </div> <div data-bbox="1101 911 1446 999" style="border: 1px solid black; border-radius: 10px; padding: 5px; text-align: center;">                     Motor Speed U1-05=- 1.47 HZ                 </div>

**2.2d (continued)**

DESCRIPTION	KEY SEQUENCE	DIGITAL OPERATOR DISPLAY
<p>Check the motor rotation using the JOG function.</p> <p>NOTE: The frequency reference for this operation comes from <b>d1-09</b> and is factory set to 6 Hz.</p> <p><b>WARNING</b>  <b>THE NEXT KEY-PRESS WILL CAUSE THE MOTOR TO MOVE; TAKE APPROPRIATE PRECAUTIONS.</b></p>	<p>Press  , then </p> <p>If either or both of the <b>SEQ</b> and <b>REF</b> lights are on, press </p>	<p>Frequency Ref U1-01= 0.00 HZ</p>
<p>The motor should ramp up to speed, and rotation should be counter-clockwise if the <b>FWD</b> light is on. Rotation should be clockwise if the <b>REV</b> light is on. If rotation is incorrect, reverse any two motor leads, then repeat the motor rotation check.</p>	<p>Press &amp; hold </p> <p>Release </p>	<p>Frequency Ref U1-01= 6.00 HZ</p> <p><b>RUN</b> light will illuminate</p>
<p><b>Proceed to section 2.5, "TEST RUN USING DIGITAL OPERATOR"</b></p>		

## 2.3 CHANGING THE LANGUAGE ON THE DIGITAL OPERATOR

DESCRIPTION	KEY SEQUENCE	DIGITAL OPERATOR DISPLAY
Power ON		
Bring up the Main Menu and go to Initialize mode.	Press <b>MENU</b> , then  , then <b>DATA</b> / <b>ENTER</b>	[ Display in Wrong Language ]
Change the language.	Press <b>DATA</b> / <b>ENTER</b> , then select the correct language using:  	A1-00= 0 English
Write value to memory.	Press <b>DATA</b> / <b>ENTER</b>	Entry Accepted briefly, then Select Language English
Return to operating mode.	Press <b>MENU</b> , then <b>DATA</b> / <b>ENTER</b>	Frequency Ref U1-01= 0.00 HZ









## 2.4 CALCULATING MOTOR PARAMETERS

This procedure can be used as an alternative to auto-motor tuning. If the motor being used with the drive did not pass motor auto-tuning or if the motor cannot be disconnected from the load, the motor parameters need to be calculated and entered manually.











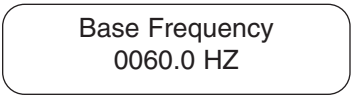

**This procedure only applies to the Open Loop Vector Control method & the Flux Vector Control method.**

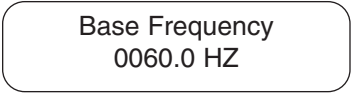
The following information used in the calculation formulas is usually listed on the motor nameplate. If no-load current is not marked on the nameplate and the motor manufacturer is not able to supply it, use the default value of  $(0.3 \times I_{FLA}) = I_{NLA}$ .

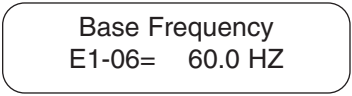

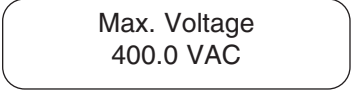

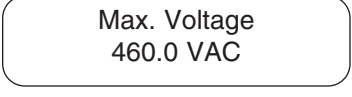

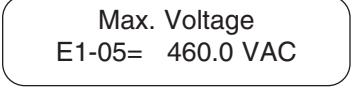





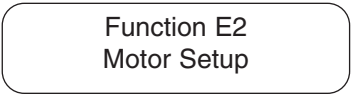

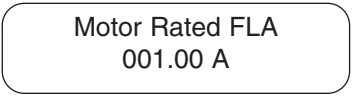

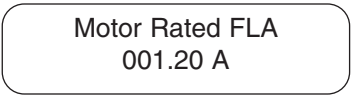

Motor Voltage (V)	$V_m$
Motor Rated Speed (RPM)	$N_R$
Motor Rated Frequency (Hz)	$f_R$
Motor Synchronous Speed (RPM)	$N_S$ ( $N_S = f_R * 120 / \text{number of motor poles}$ )
Full Load Amps (FLA)	$I_{FLA}$
No-Load Amps (NLA)	$I_{NLA}$

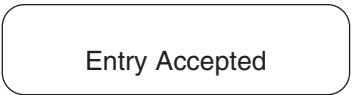
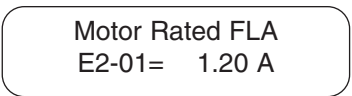
DESCRIPTION	KEY SEQUENCE	DIGITAL OPERATOR DISPLAY
Enter the Maximum frequency ( E1-04 ). For constant torque applications, set to motor nameplate frequency. For constant horsepower applications, set to maximum frequency desired.	Press <b>MENU</b> , then  twice	** Main Menu ** Programming
	Press <b>DATA ENTER</b> , then  3 times	Group E Motor
	Press <b>DATA ENTER</b> twice	Input Voltage E1-01= 460 VAC
	Press  twice, then <b>DATA ENTER</b>	Max. Frequency 0060.0 HZ
	Set the maximum frequency using:    <b>RESET</b>	Max. Frequency 0060.0 HZ
	Write value to memory by pressing <b>DATA ENTER</b>	Entry Accepted  briefly, then  Max. Frequency E1-04= 60.0 HZ

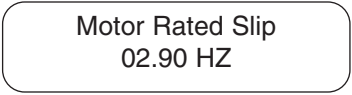



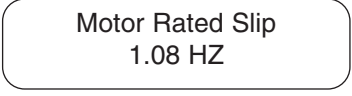

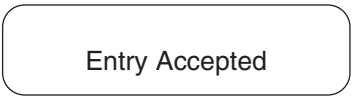
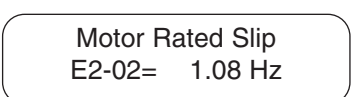





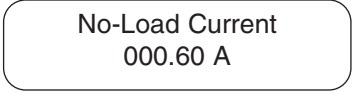

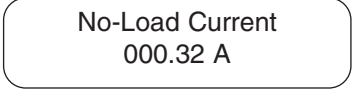

**2.4 (continued)**

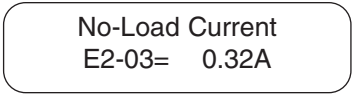
DESCRIPTION	KEY SEQUENCE	DIGITAL OPERATOR DISPLAY
<p>Enter the Base frequency ( <b>E1-06</b> ). This value can be obtained from the motor nameplate (rated frequency).</p>	<p>Press  twice , then </p>	
	<p>Set the base frequency using:</p> 	
	<p>Write value to memory by pressing </p>	<p>Entry Accepted</p> <p>briefly, then</p> 
<p>Enter the maximum motor voltage ( <b>E1-05</b> ). This value can be obtained from the motor nameplate (rated voltage).</p>	<p>Press  , then </p>	
	<p>Set the maximum voltage using:</p> 	
	<p>Write value to memory by pressing </p>	<p>Entry Accepted</p> <p>briefly, then</p> 

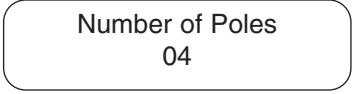
**2.4 (continued)**

DESCRIPTION	KEY SEQUENCE	DIGITAL OPERATOR DISPLAY
<p>Enter the motor rated full load amps ( <b>E2-01</b> ). This value can be obtained from the motor nameplate (motor full load amps).</p>	Press  , then 	
	Press  twice	
	Set the FLA using:   	
	Write value to memory by pressing 	 briefly, then 
<p>Enter the motor rated slip ( <b>E2-02</b> ). This value can be calculated using the following formula:</p> $E2-02 = \frac{(N_s - N_r)}{N_s} \times 60 \times 0.7$ <p> <math>N_r</math> = nameplate rated speed  <math>N_s</math> = synchronous speed  <math>N_s = f_R \times 120 / \#</math> of motor poles         </p>	Press  , then 	
	Set motor rated slip using:   	
	Write value to memory by pressing 	 briefly, then 

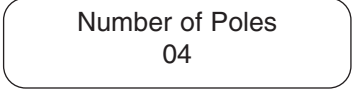
## 2.4 (continued)

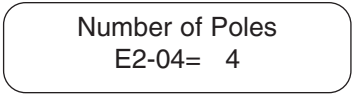
DESCRIPTION	KEY SEQUENCE	DIGITAL OPERATOR DISPLAY										
Enter the motor no-load current ( <b>E2-03</b> ). This value can sometimes be obtained from the motor nameplate. If it is unavailable, use the following formula to calculate it: 1-5 HP: $I_{NLA} = I_{FLA} \times 0.50$ 5-15 HP: $I_{NLA} = I_{FLA} \times 0.40$ > 15 HP: $I_{NLA} = I_{FLA} \times 0.30$	Press  , then 											
	Set motor no load current using:   											
	Write value to memory by pressing 	 briefly, then 										
Enter number of motor poles ( <b>E2-04</b> ).  (Assuming an $f_R$ of 50 or 60 Hz)  <table border="1" style="margin-left: 20px;"> <thead> <tr> <th>Rated Speed (RPM)</th> <th># of motor poles</th> </tr> </thead> <tbody> <tr> <td>2400-3600</td> <td>2</td> </tr> <tr> <td>1300-1800</td> <td>4</td> </tr> <tr> <td>900-1200</td> <td>6</td> </tr> <tr> <td>660-900</td> <td>8</td> </tr> </tbody> </table>  <i>Note: This step is not required for Open Loop Vector Control method (A1-02=0).</i>	Rated Speed (RPM)	# of motor poles	2400-3600	2	1300-1800	4	900-1200	6	660-900	8	Press  , then 	
	Rated Speed (RPM)	# of motor poles										
	2400-3600	2										
1300-1800	4											
900-1200	6											
660-900	8											
Set number of motor poles using:   												
Write value to memory by pressing 	 briefly, then 											
Parameters <b>E2-05</b> to <b>E2-09</b> : Factory set values are acceptable.												

## 2.5 TEST RUN USING DIGITAL OPERATOR ("LOCAL" CONTROL)

The operation shown in Figure 2-3 and described in Table 2-5 is for a standard 60 Hz motor.

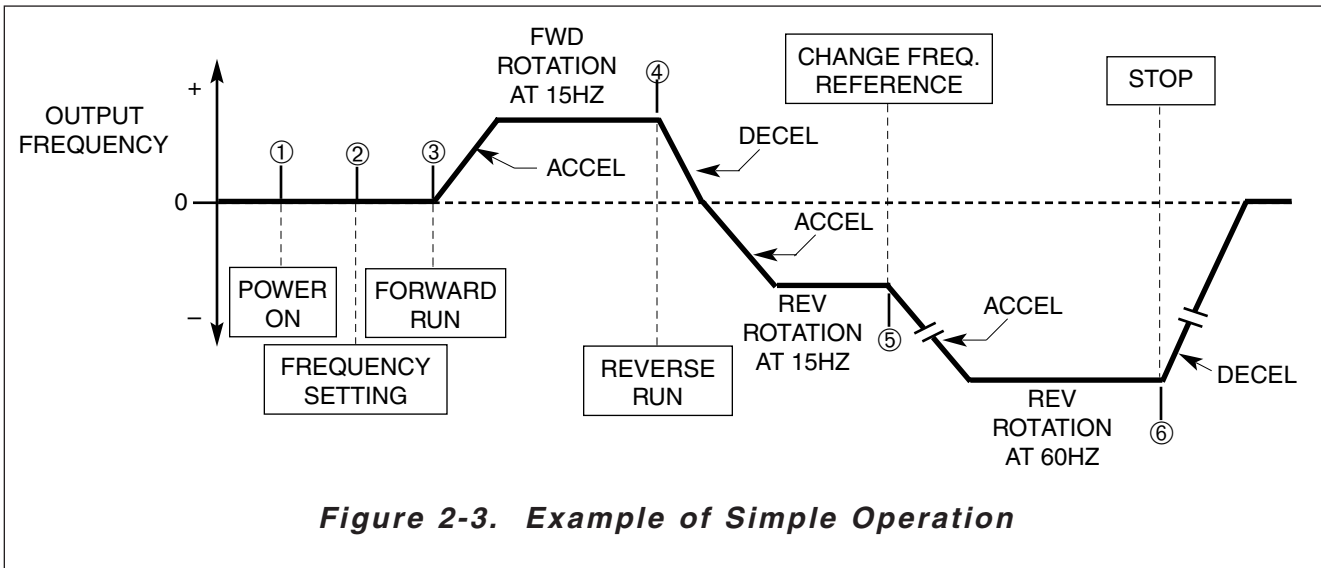

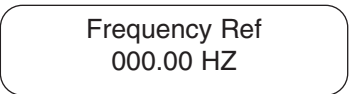



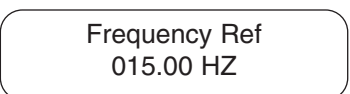

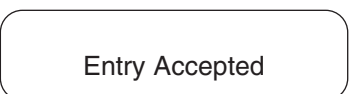
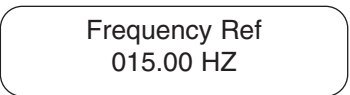

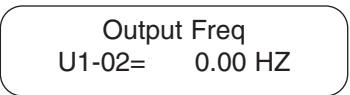

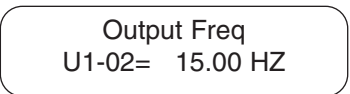
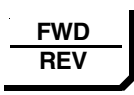
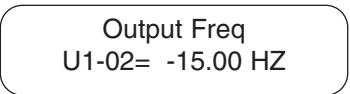



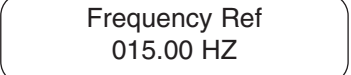



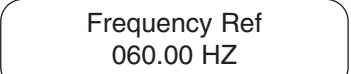

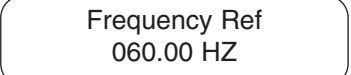

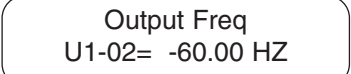

Table 2-5. Test Run With Digital Operator

DESCRIPTION	KEY SEQUENCE	DIGITAL OPERATOR DISPLAY
Power ON	Press <b>MENU</b> , then <b>DATA ENTER</b>	Frequency Ref U1-01= 0.00 HZ
If either the <b>SEQ</b> or <b>REF</b> lights are on, they should be turned off by pressing the <b>LOCAL/REMOTE</b> key. This will set the drive so it can be completely controlled by the Digital Operator.	Press <b>LOCAL/REMOTE</b>	<b>SEQ</b> and <b>REF</b> lights are off, <b>DRIVE</b> and <b>FWD</b> lights are on.  Frequency Ref U1-01= 0.00 HZ

**Table 2-5. Test Run With Digital Operator - Continued**

DESCRIPTION	KEY SEQUENCE	DIGITAL OPERATOR DISPLAY
Set a run frequency of 15 Hz.	Press 	
	Set the frequency to 15 using:   	
	Write the value to memory by pressing 	 briefly, then 
Display the output frequency.	Press  , then 	
Run the motor in the forward direction.	Press 	<b>RUN</b> light comes on and motor ramps up to speed.  NOTE: Output frequency may be slightly higher than the frequency reference, depending on the control method selected.
Run the motor in the reverse direction.	Press 	<b>RUN</b> light remains on. <b>FWD</b> light goes out and <b>REV</b> light comes on. The motor ramps down to zero speed, then ramps up in the opposite direction.  NOTE: output frequency may be slightly higher than the frequency reference, depending on the control method selected.

**Table 2-5. Test Run With Digital Operator - Continued**

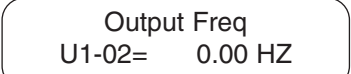
DESCRIPTION	KEY SEQUENCE	DIGITAL OPERATOR DISPLAY
Change the frequency reference from 15 Hz to 60 Hz.	Press  , then  twice	
	Change the frequency using:   	
	Write the value to memory by pressing 	 briefly, then 
Display the output frequency.	Press  , then 	  NOTE: Output frequency may be slightly higher than the frequency reference, depending on the control method selected.
Stop the motor.	Press 	The STOP light turns on, and the RUN light blinks during the deceleration of the motor.  

## 2.6 PRE-OPERATION CONSIDERATIONS

---

- After completing the Test Run, connect the motor to the load.
- Additional control circuit wiring can be added, and parameters in the drive can be programmed to configure the drive system to your specific application, including "Remote" (2-wire or 3-wire) Control. See Section 5 for description of programmable features, and also see instruction sheets for any options included with the drive.
- Record all parameter values (see Quick Reference sheets at the front of this manual).

## 2.7 STORAGE FUNCTION

---

The drive uses internal NV-RAM to store information when power is removed or in the event of a power failure. Therefore, when power is reapplied, operation will begin at the same state as when power was removed.

The following information is stored:

- Last Main Speed Reference setting and forward/reverse selection from Digital Operator.
- The sequence of failure conditions that occurred before power was removed (including content of a " **CPF** " failure).





## Section 3. OPERATION AT LOAD

After completing the start-up, and programming of parameters, turn off the AC main circuit power. Make additional wiring connections required for the external control functions selected by the parameter programming. Connect the driven machine to the motor. Verify that the driven machine is in running condition, and that no dangerous conditions exist around the drive system.



**When starting and stopping the motor, use the operation signals (RUN/STOP, FWD/REV), NOT the magnetic contactor on the power supply side (if present).**

Run the motor under load with control by the Digital Operator using the same procedure as for the Test Run (Table 2-5). If the Digital Operator is used in combination with external commands or external commands only are used, the procedure must be altered accordingly.

For preset starting (one-touch operation after setting the frequency), perform the following:

1. Set the speed and press **RUN**. Motor accelerates, at the rate corresponding to the preset accel time, to the preset speed. The accel time ( **C1-01** ) is set too short relative to the load if the RPM of the accelerating motor does not increase smoothly, or if a fault is displayed on the Digital Operator.
2. Press **STOP**. Unless coast to stop operation has been selected (by programming of **b1-03** ), the motor decelerates, at the rate corresponding to the preset decel time ( **C1-02** ), to a stop.



# Section 4. DIGITAL OPERATOR

## 4.1 GENERAL

All functions of the GPD 515/G5 are accessed using the Digital Operator. In addition to controlling motor operation, the operator can enter information into the drive memory to configure the drive to the application by entering the Program mode.

## 4.2 DISPLAY AND KEYPAD

The Digital Operator has a 2 line by 16 character LCD display. Both numeric and alphanumeric data can appear on the display.

Indicator lamps and keys on the Digital Operator are described in Figure 4-1.

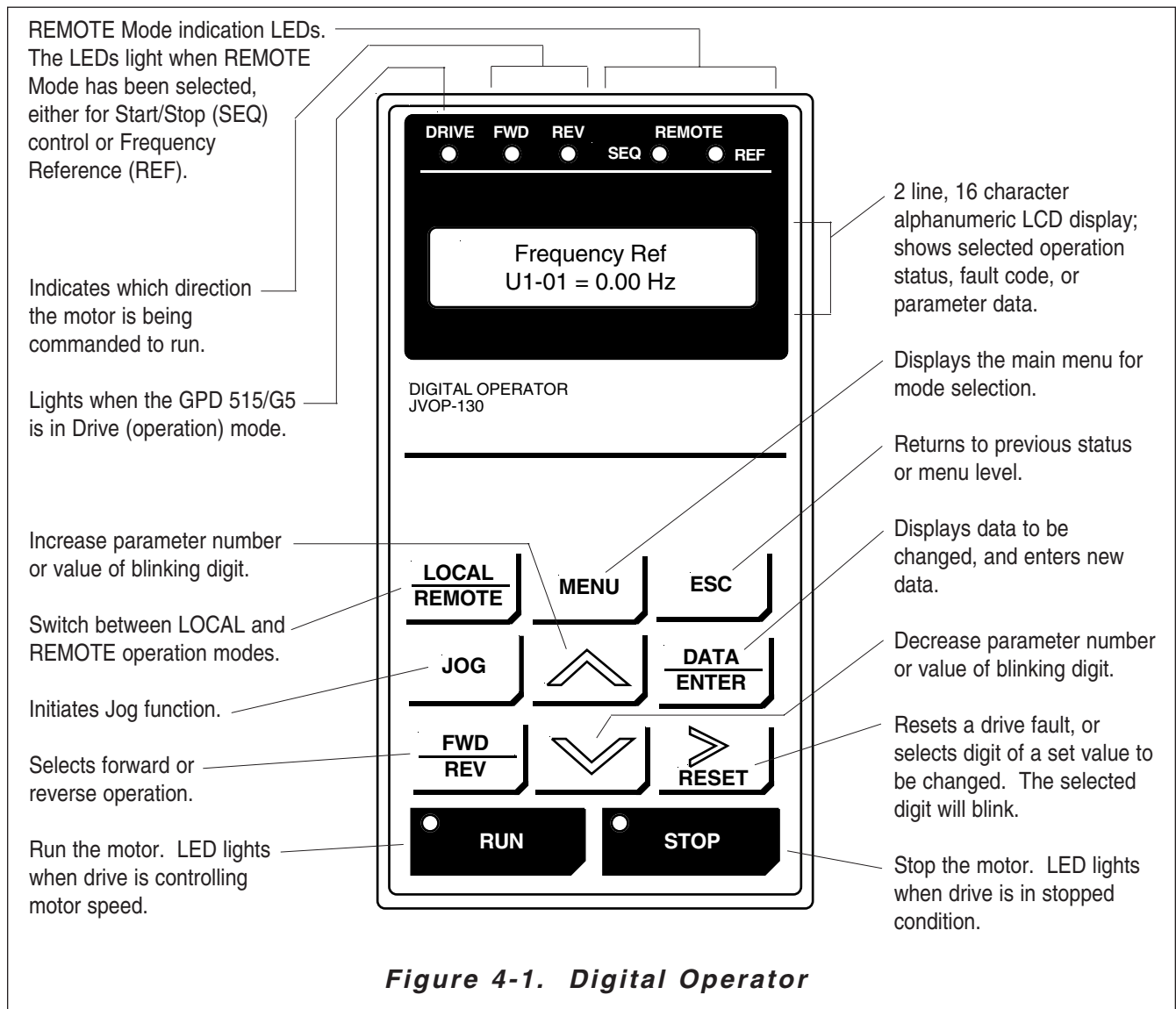

Figure 4-1. Digital Operator

**Table 4-1. Digital Operator Controls**

A. INDICATOR LAMPS	
NAME	FUNCTION
<b>DRIVE</b>	Lights when the drive is in the Drive mode of operation.
<b>FWD</b>	Lights when Forward motor run has been selected.
<b>REV</b>	Lights when Reverse motor run has been selected.
<b>REMOTE SEQ</b>	Lights when the drive is programmed to operate from external RUN and STOP signals.
<b>REMOTE REF</b>	Lights when the drive is programmed to operate by an external frequency reference signal.
<b>RUN</b>	Off when drive is in stopped condition; lights steadily when Run signal is active; blinks after Stop signal has been received and drive output is ramping down. (See Figure 4-2.)
<b>STOP</b>	Lights steadily at initial power-up; blinks after Run signal becomes active but frequency reference is zero; off when drive output is controlling motor speed. (See Figure 4-2.)
B. KEYPAD KEYS	
LABEL	FUNCTION
<b><u>LOCAL</u></b> <b><u>REMOTE</u></b>	Pressing this key toggles between the Local (Digital Operator) and Remote (Terminals) modes of operation. Active only when the drive is in stopped condition.
<b>JOG</b>	IN DRIVE MODE: Pressing and holding this key will initiate Jog function: drive output goes to programmed Jog Frequency ( <b>d1-09</b> ) to check motor operation, or to position machine. When key is released, output returns to zero and motor stops. If the motor is already running, pressing this key will have no effect. NOTE: Disabled if the drive is programmed to use an external JOG input.
<b><u>FWD</u></b> <b><u>REV</u></b>	IN DRIVE MODE: Each press of this key will toggle between Forward and Reverse motor run direction. The selected direction is indicated by the <b>FWD</b> or <b>REV</b> lamp being lit. If the selection is made while the drive is stopped, it determines the direction the motor will run when started. If the selection is changed during running, the drive will ramp the motor to zero speed and then ramp it up to set speed in the opposite (i.e. newly selected) direction.
<b>RUN</b>	IN DRIVE MODE: If the drive is not programmed to operate by external RUN and STOP signals (as indicated by <b>REMOTE SEQ</b> lamp being lit), pressing this key will produce a Run command to initiate drive output to the motor. However, output frequency will be zero if the frequency reference is zero at the time this key is pressed.
<b>STOP</b>	IN DRIVE MODE: Pressing this key will produce a Stop command. The drive will decelerate the motor in the programmed stopping manner, then drive output will be disconnected from the motor.

**Table 4-1. Digital Operator Controls - Continued**

B. KEYPAD KEYS – Continued	
LABEL	FUNCTION
<b>MENU</b>	IN DRIVE MODE: Pressing this key will display the top level of the menu tree for selecting and reading parameters. The drive will change to Program mode. IN PROGRAM MODE: Pressing this key will display the top level of the menu tree for returning to the Drive mode. Pressing the <b>MENU &amp; DATA/ENTER</b> keys in succession will change to Drive mode and display the frequency reference setting.
<b>ESC</b>	Each time this key is pressed the display returns to the previous level in the menu tree or to the status prior to pressing <b>DATA/ENTER</b> .
<b>DATA ENTER</b>	IN DRIVE MODE <b>OR</b> PROGRAM MODE: When a parameter number is being displayed, pressing this key will display the parameter's set value which is presently in memory. IN PROGRAM MODE ONLY: After the displayed set value has been changed as desired, pressing this key will write the new set value into the drive memory to replace the old value.
<b>&gt; RESET</b>	IN DRIVE MODE <b>OR</b> PROGRAM MODE: When a changeable data value is being displayed, pressing this key moves the blinking (i.e. "changeable") position to the next digit to the right. If at the right-most position, this will wrap-around to the first position on the left side of the display.
<b>^ (up arrow)</b>	IN DRIVE MODE <b>OR</b> PROGRAM MODE: Pressing this key will increase the value of the blinking digit in the display by 1. Pressing this key will increase a parameter number by 1.
<b>v (down arrow)</b>	IN DRIVE MODE <b>OR</b> PROGRAM MODE: Pressing this key will decrease the value of the blinking digit in the display by 1. Pressing this key will decrease a parameter number by 1.

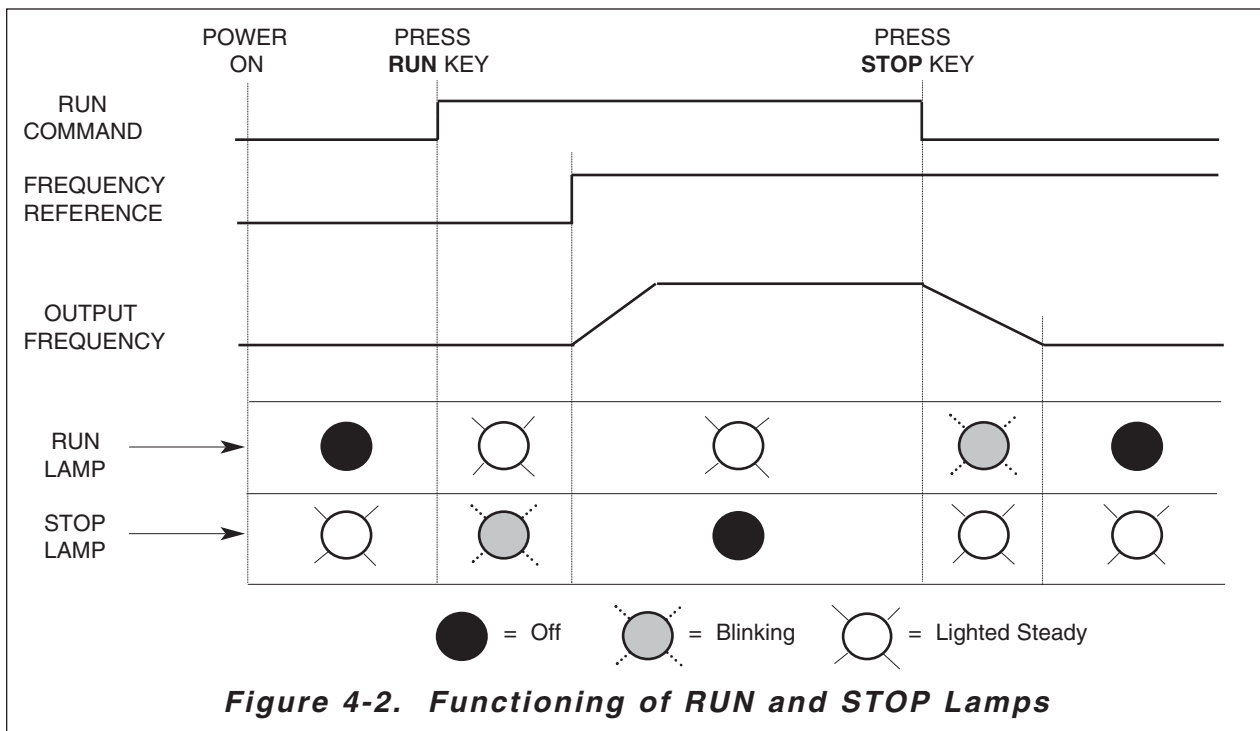

## 4.3 DIGITAL OPERATOR MENU TREES

### A. Quick-start Access Level

The flowchart tree below illustrates the process of accessing drive parameters when the Access Level is set to Quick Start ( **A1-01** = 2 ).

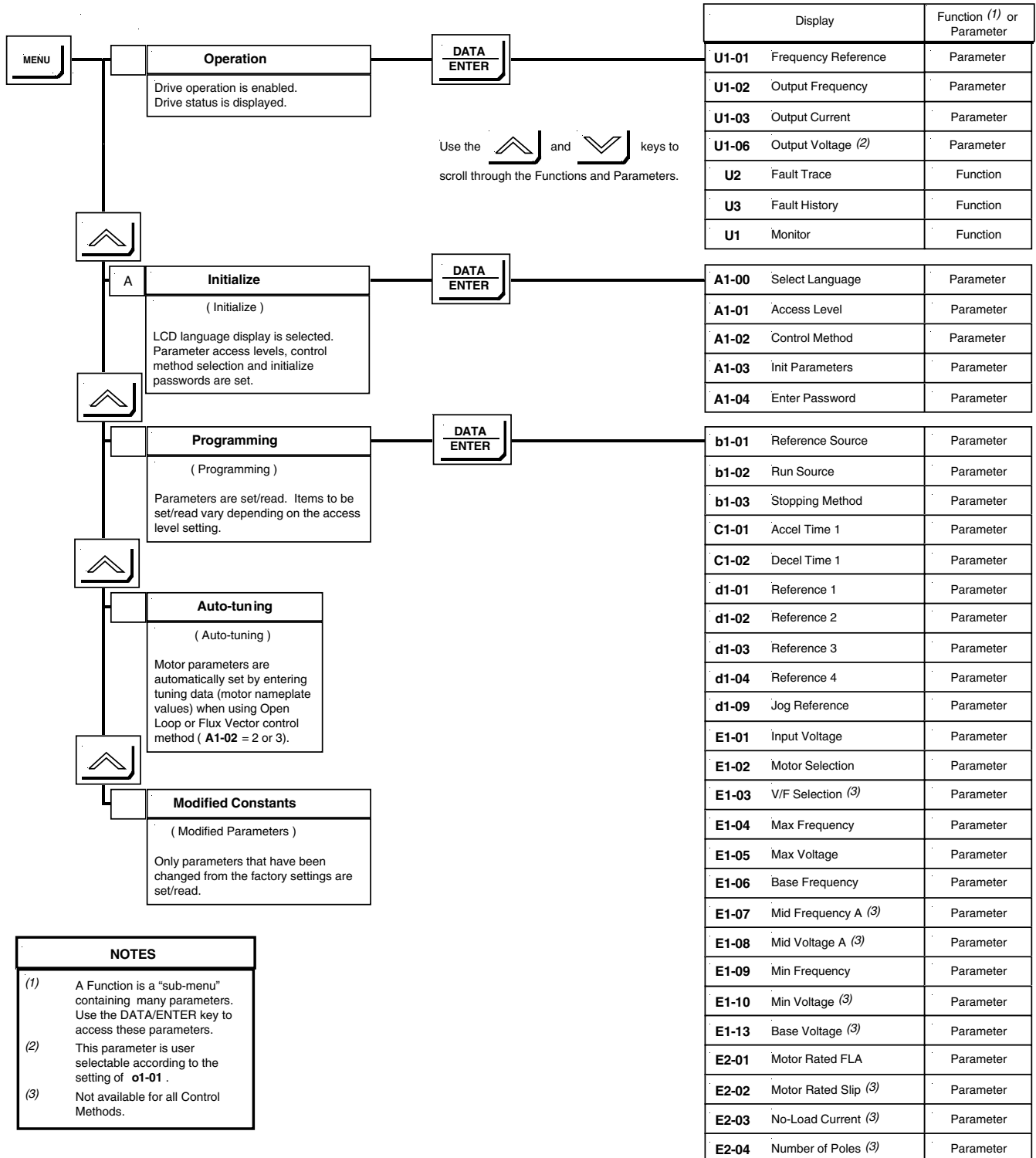

#### NOTES

- (1) A Function is a "sub-menu" containing many parameters. Use the DATA/ENTER key to access these parameters.
- (2) This parameter is user selectable according to the setting of **a1-01**.
- (3) Not available for all Control Methods.

**B. Basic Access Level**

The flowchart tree below illustrates the process of accessing drive parameters when the Access Level is set to Basic ( **A1-01** = 3).

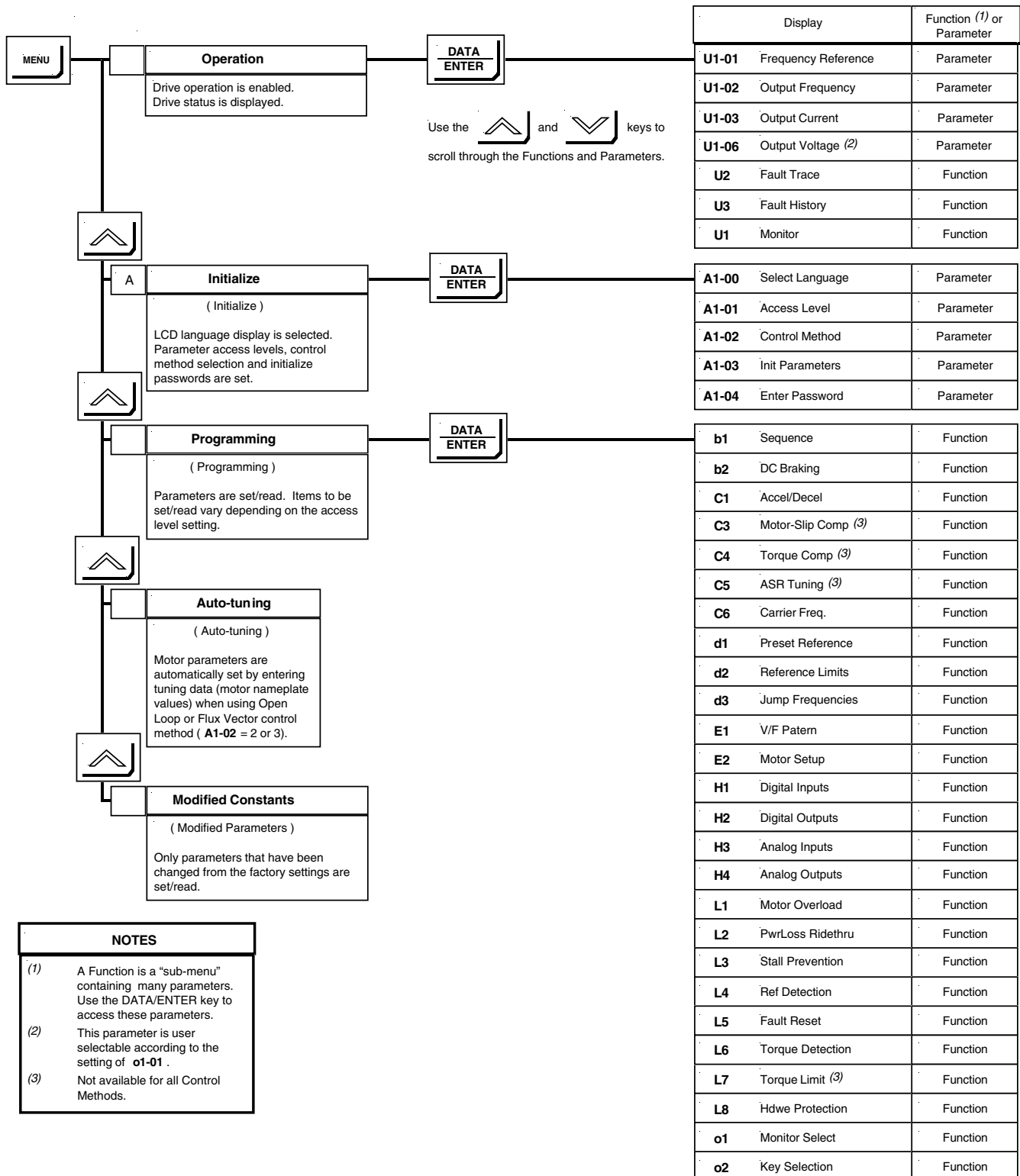

**NOTES**

(1) A Function is a "sub-menu" containing many parameters. Use the DATA/ENTER key to access these parameters.

(2) This parameter is user selectable according to the setting of **o1-01**.

(3) Not available for all Control Methods.



C. Advanced Access Level

The flowchart tree below illustrates the process of accessing drive parameters when the Access Level is set to Advanced ( **A1-01** = 4).

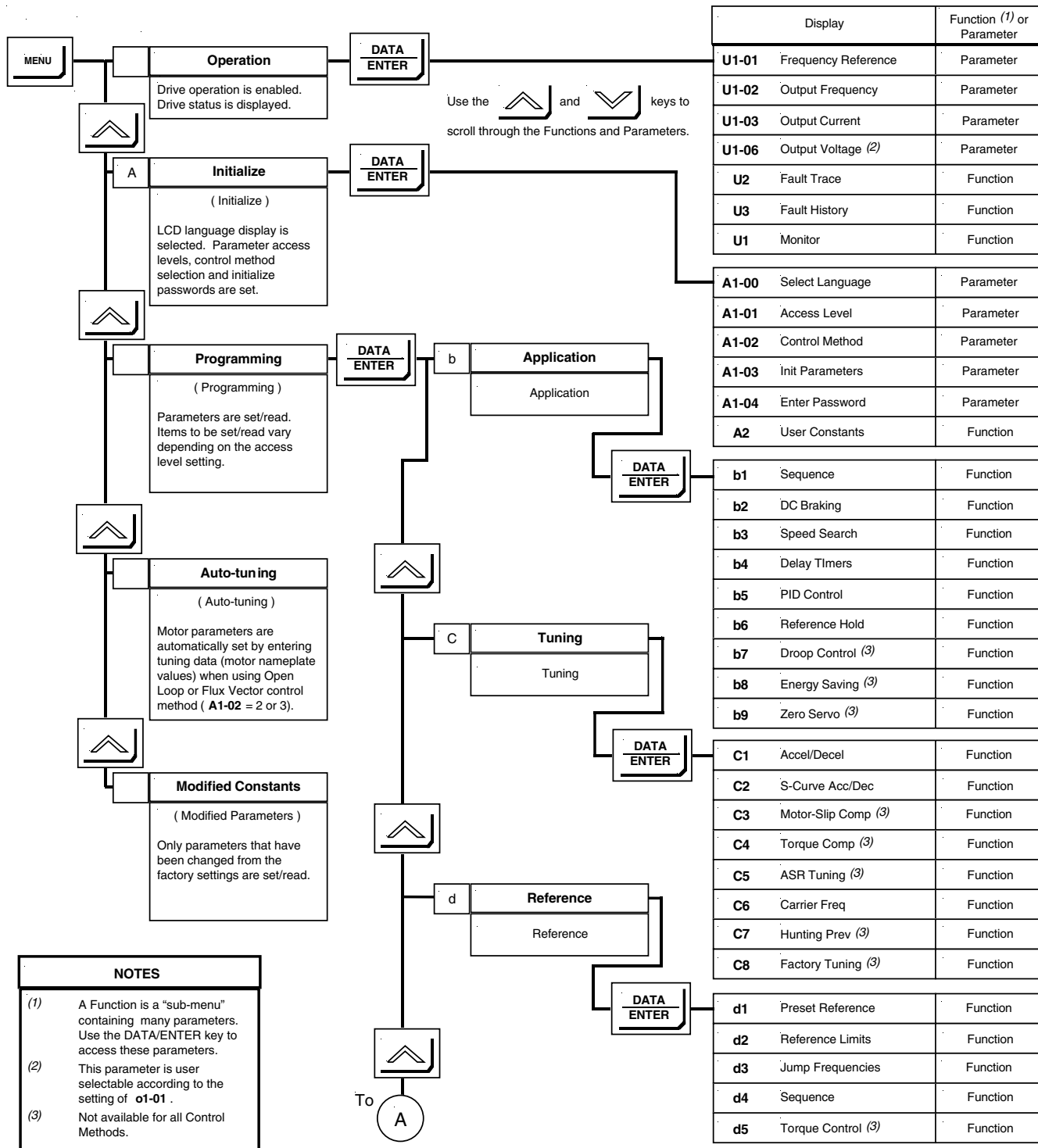

## 4.3 DIGITAL OPERATOR MENU TREES

Continued

### C. Advanced Access Level (Continued)

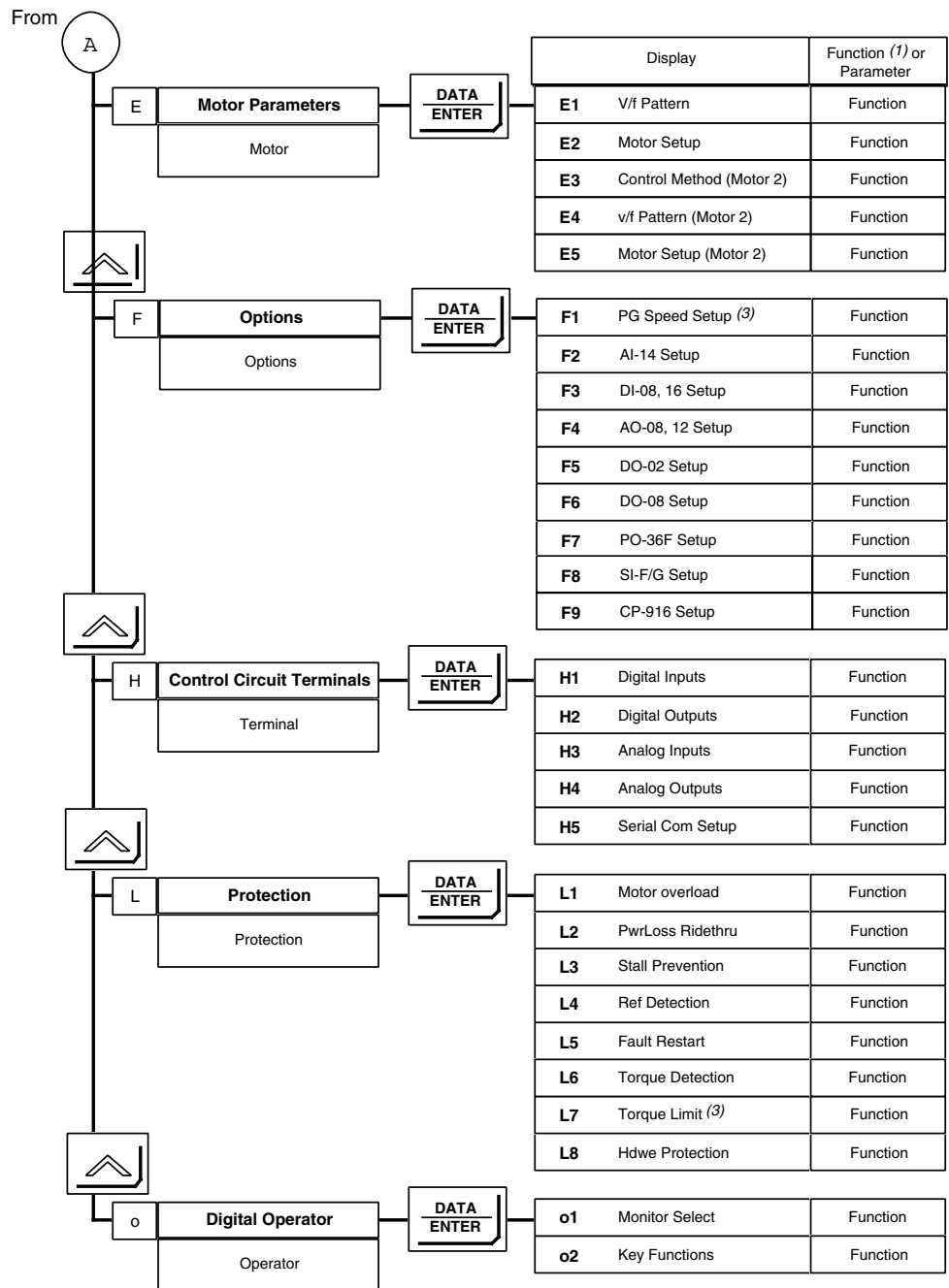

## 4.4 BASIC PROGRAMMING

All parameters are set by accessing them through a menu tree with multiple access levels. The setting of the Access Level in the Initialization Menu determines which parameters appear on the Digital Operator. To see Example 1 and 2 in detail, refer to Tables 4-5, 4-6 and 4-7.

**Table 4-2. Parameter Menu**

Menu Level (Advanced Access)	Reference Name	Digital Operator Display Example 1	Digital Operator Display Example 2
Level 1 Level 2	Digital Operator Mode Parameter Group	Programming C – Tuning	Initialize —
Level 3 Level 4	Parameter Function Parameter Name	C1 Accel/Decel Decel Time 1	— Control Method
Level 5 Level 6	Parameter Number Parameter Setting Value	C1-02 10.0 sec	A1-02 V/F Control

The parameters are arranged by groups. The following table shows which Parameter Group(s) appear under which Mode.

**Table 4-3. Parameter Groups**









Digital Operator Modes	Operation	Initialize	Programming	Auto-Tuning	Modified Constants
<b>Parameter Groups List *</b>	U – Monitor	A – Initialize	b – Application	No Group Name	No Group Name
			C – Tuning		
			d – Reference		
			E – Motor		
			F – Options		
H – Terminals					
L – Protection					
o – Operator					

\* For a complete listing of parameters, see Appendix 1.

## 4.5 MODES OF OPERATION











The procedure for choosing a mode is shown in Table 4-4.

**Table 4-4. Digital Operator Mode Selection**















DESCRIPTION	KEY SEQUENCE	DIGITAL OPERATOR DISPLAY
		Frequency Ref U1-01= 0.00 HZ
Top of Main Menu • Displays Operation Mode (drive changes to Program mode).	Press 	** Main Menu ** Operation
• Displays Initialize Mode.	Press 	** Main Menu ** Initialize
• Displays Programming Mode.	Press 	** Main Menu ** Programming
• Displays Auto-Tuning Mode (displayed only when Vector Control Method is selected).	Press 	** Main Menu ** Auto-Tuning
• Displays Modified Parameter Menu.	Press 	** Main Menu ** Modified Constants
Top of Main Menu • Return to Operation.	Press  or 	** Main Menu ** Operation
• Select Operation Mode. • Displays frequency reference setting (changes to Drive mode).	Press 	Frequency Ref U1-01= 0.00 HZ

Parameters are changed by pressing the **MENU** key to enter the Program mode, then advancing through the levels of the menu to access the parameter that is desired to be changed. Only the parameters listed in Table A1-11 (Appendix 1) may be changed while the drive is running.









**Table 4-5. Example 1A: Changing a Parameter in Quick-start Access Level**

DESCRIPTION	KEY SEQUENCE	DIGITAL OPERATOR DISPLAY
		<div style="border: 1px solid black; border-radius: 10px; padding: 5px; text-align: center;">                     Frequency Ref U1-01= 0.00 HZ                 </div>
<ul style="list-style-type: none"> <li>Select Programming Mode.</li> </ul>	Press  , then  twice	<div style="border: 1px solid black; border-radius: 10px; padding: 5px; text-align: center;">                     ** Main Menu ** Programming                 </div>
<ul style="list-style-type: none"> <li>Select the Parameter Name.</li> </ul>	Press  , then  4 times	<div style="border: 1px solid black; border-radius: 10px; padding: 5px; text-align: center;">                     Decel Time 1 C1-02= 10.0 sec                 </div>
<ul style="list-style-type: none"> <li>Select the Decel Time 1 parameter setting. (The first digit of the value to be set blinks.)</li> </ul>	Press 	<div style="border: 1px solid black; border-radius: 10px; padding: 5px; text-align: center;">                     Decel Time 1 0010.0 sec                 </div>
<ul style="list-style-type: none"> <li>Change reference value.</li> </ul>	Change value by pressing   	<div style="border: 1px solid black; border-radius: 10px; padding: 5px; text-align: center;">                     Decel Time 1 0001.0 sec                 </div>
<ul style="list-style-type: none"> <li>Write into memory.</li> </ul>	Press 	<div style="border: 1px solid black; border-radius: 10px; padding: 5px; text-align: center;">                     Entry Accepted                 </div> briefly, then <div style="border: 1px solid black; border-radius: 10px; padding: 5px; text-align: center;">                     Decel Time 1 C1-02= 1.0 sec                 </div>
Top of Main Menu <ul style="list-style-type: none"> <li>Return to Operation.</li> </ul>	Press 	<div style="border: 1px solid black; border-radius: 10px; padding: 5px; text-align: center;">                     ** Main Menu ** Operation                 </div>
<ul style="list-style-type: none"> <li>Select Operation Mode (changes to Drive mode).</li> </ul>	Press 	<div style="border: 1px solid black; border-radius: 10px; padding: 5px; text-align: center;">                     Frequency Ref U1-01= 0.00 HZ                 </div>

**Table 4-6. Example 1B: Changing a Parameter in Advanced Access**

DESCRIPTION	KEY SEQUENCE	DIGITAL OPERATOR DISPLAY
		<div style="border: 1px solid black; border-radius: 10px; padding: 5px; text-align: center;">                     Frequency Ref U1-01= 0.00 HZ                 </div>
<ul style="list-style-type: none"> <li>Select Programming Mode.</li> </ul>	Press  , then  twice	<div style="border: 1px solid black; border-radius: 10px; padding: 5px; text-align: center;">                     ** Main Menu ** Programming                 </div>
<ul style="list-style-type: none"> <li>Select Tuning Parameter Group.</li> </ul>	Press  , then 	<div style="border: 1px solid black; border-radius: 10px; padding: 5px; text-align: center;">                     Group C Tuning                 </div>
<ul style="list-style-type: none"> <li>Select the Accel/Decel Function.</li> </ul>	Press 	<div style="border: 1px solid black; border-radius: 10px; padding: 5px; text-align: center;">                     Function C1 Accel/Decel                 </div>
<ul style="list-style-type: none"> <li>Select the Parameter Name.</li> </ul>	Press  , then 	<div style="border: 1px solid black; border-radius: 10px; padding: 5px; text-align: center;">                     Decel Time 1 C1-02= 10.0 sec                 </div>
<ul style="list-style-type: none"> <li>Select the Decel Time 1 parameter setting. (The first digit of the value to be set blinks.)</li> </ul>	Press 	<div style="border: 1px solid black; border-radius: 10px; padding: 5px; text-align: center;">                     Decel Time 1 0010.0 sec                 </div>
<ul style="list-style-type: none"> <li>Change reference value.</li> </ul>	Change value by pressing   	<div style="border: 1px solid black; border-radius: 10px; padding: 5px; text-align: center;">                     Decel Time 1 0001.0 sec                 </div>
<ul style="list-style-type: none"> <li>Write into memory.</li> </ul>	Press 	<div style="border: 1px solid black; border-radius: 10px; padding: 5px; text-align: center;">                     Entry Accepted                 </div> briefly, then <div style="border: 1px solid black; border-radius: 10px; padding: 5px; text-align: center;">                     Decel Time 1 C1-02= 1.0 sec                 </div>
Top of Main Menu <ul style="list-style-type: none"> <li>Return to Operation.</li> </ul>	Press 	<div style="border: 1px solid black; border-radius: 10px; padding: 5px; text-align: center;">                     ** Main Menu ** Operation                 </div>
<ul style="list-style-type: none"> <li>Select Operation Mode (changes to Drive mode).</li> </ul>	Press 	<div style="border: 1px solid black; border-radius: 10px; padding: 5px; text-align: center;">                     Frequency Ref U1-01= 0.00 HZ                 </div>

**Table 4-7. Example 2: Changing Control Method in Quick-start Access Level**

DESCRIPTION	KEY SEQUENCE	DIGITAL OPERATOR DISPLAY
		<div style="border: 1px solid black; border-radius: 10px; padding: 5px; text-align: center;">                     Frequency Ref U1-01= 0.00 HZ                 </div>
<ul style="list-style-type: none"> <li>Select Initialize Mode.</li> </ul>	Press  , then 	<div style="border: 1px solid black; border-radius: 10px; padding: 5px; text-align: center;">                     ** Main Menu ** Initialize                 </div>
<ul style="list-style-type: none"> <li>Select the Parameter Name.</li> </ul>	Press  , then  twice	<div style="border: 1px solid black; border-radius: 10px; padding: 5px; text-align: center;">                     Control Method Open Loop Vector                 </div>
<ul style="list-style-type: none"> <li>Change data value.</li> </ul>	Press  , then  twice	<div style="border: 1px solid black; border-radius: 10px; padding: 5px; text-align: center;">                     A1-02= 0 V/F Control                 </div>
<ul style="list-style-type: none"> <li>Write into memory.</li> </ul>	Press 	<div style="border: 1px solid black; border-radius: 10px; padding: 5px; text-align: center;">                     Entry Accepted                 </div> briefly, then <div style="border: 1px solid black; border-radius: 10px; padding: 5px; text-align: center;">                     Control Method V/F Control                 </div>
Top of Main Menu <ul style="list-style-type: none"> <li>Return to Operation.</li> </ul>	Press 	<div style="border: 1px solid black; border-radius: 10px; padding: 5px; text-align: center;">                     ** Main Menu ** Operation                 </div>
<ul style="list-style-type: none"> <li>Select Operation Mode (changes to Drive mode).</li> </ul>	Press 	<div style="border: 1px solid black; border-radius: 10px; padding: 5px; text-align: center;">                     Frequency Ref U1-01= 0.00 HZ                 </div>

# Section 5. PROGRAMMABLE FEATURES

## 5.1 GENERAL

This section describes features of the GPD 515/G5 which are defined by programmed settings in the various parameters in memory. Since most features use more than one parameter, the descriptions appear in alphabetical order by the function name. In Table 5-1, the functions are grouped into operational categories. To cross reference a particular parameter to the features to which it applies, see the listings in Appendix 1, or the Index.

**Table 5-1. List of Features Defined By Parameters**

<b>FUNCTION</b>	<b>PARAGRAPH REFERENCE</b>	<b>PARAMETER(S)</b>
<b>SET-UP</b>		
Initialization (Reset), 2-Wire or 3-Wire	5.37	<b>A1-03</b>
Access Level	5.4	<b>A1-01</b>
Control Method Selection	2.2	<b>A1-02</b>
Drive Capacity, Parameters Affected By	Table A3-1	_____
Volts/Hertz Patterns, Standard	5.47	<b>E1-03</b>
Volts/Hertz Pattern, Custom	5.48	<b>E1-04</b> thru <b>-10</b>
Input Voltage Setting	5.37	<b>E1-01</b>
Encoder (PG) Parameters	5.15	<b>F1-10</b> thru <b>F1-14</b>
Thermal Motor Overload Protection	5.41	<b>E1-02; E2-01; L1-01, L1-02</b>
Digital Operator Display, Re-scaling	5.11	<b>o1-03, o1-04</b>
Input Phase Loss Detection	5.34	<b>L8-05</b>
Output Phase Loss Detection	5.35	<b>L8-07</b>
User Parameters	5.46	<b>A2-01</b> thru <b>-32; o2-03</b>
Miscellaneous Parameters	5.26	<b>o2-01,-02,-05,-06,-07,-08</b>
<b>STARTING</b>		
Accel Time	5.2	<b>C1-01,-03,-05,-07,-11</b>
S-Curve Characteristics	5.3	<b>C2-01,-03</b>
Dwell	5.14	<b>b6-01</b> thru <b>-04</b>
DC Injection Braking at Start	5.10	<b>b2-01,-02,-03</b>
<b>STOPPING</b>		
Stopping Method	5.40	<b>b1-03</b>
Decel Time	5.2	<b>C1-02,-04,-06,-08,-09,-11</b>
Dwell	5.14	<b>b6-01</b> thru <b>-04</b>
DC Injection Braking at Stop	5.10	<b>b2-01,-02,-04</b>
<b>SPEED CONTROL</b>		
Frequency Ref. Input Signals (Auto/Manual) (Term. 13, 16)	5.19	<b>H3-01</b> thru <b>-12</b>
Frequency Reference, Upper & Lower Limits	5.22	<b>d1-01</b> thru <b>-08</b>
Jog Reference	5.24	<b>d1-09</b>
Speed Reference Selection (Local/Remote)	5.25 A	<b>b1-01,-02; H1-01</b> thru <b>-06</b>
Multi-step Speed Setting	5.25 B	<b>d1-01</b> thru <b>-09; H1-01</b> thru <b>-06</b>
Sample/Hold	5.32 F	<b>H1-01</b> thru <b>-06</b>
Up/Down Frequency Setting	5.32 G	<b>H1-01</b> thru <b>-06</b>



**Table 5-1. List of Features Defined By Parameters - Continued**

FUNCTION	PARAGRAPH REFERENCE	PARAMETER(S)
<b>SPEED CONTROL - continued</b>		
Automatic Frequency Regulator (AFR) Gain	5.6	<b>C8-08</b>
Automatic Speed Regulator (ASR)	5.7	<b>C5-01 thru -04,-06; H1-01 thru -06</b>
Frequency Reference Retention	5.20	<b>d4-01</b>
MODBUS Control	5.28	<b>b1-01,-02; H5-01 thru -04</b>
PID Control	5.36	<b>b1-01; b5-01 thru -08</b>
Zero-Servo Control	5.49	<b>b2-01; b9-01; H5-01 thru -04</b>
Zero Speed Control	5.50	<b>b1-05; E1-09</b>
<b>REVERSE</b>		
Reverse Run Disabled	Table A1-2	<b>b1-04</b>
<b>RUNNING</b>		
Critical Frequency Rejection	5.9	<b>d3-01 thru -04</b>
Carrier Frequency	5.8	<b>C6-01,-02,-03</b>
Speed Search	5.32 D	<b>b2-01,-02,-03; H1-01 thru -06; L2-03,-04</b>
Speed Coincidence	5.33 A	
Energy Saving	5.16	<b>b8-01,-02; H1-01 thru -06</b>
Slip Compensation	5.38	<b>C3-01 thru -04</b>
<b>RUNNING IMPROVEMENTS</b>		
Torque Compensation	5.42	<b>C4-01,-02</b>
Stall Prevention	5.39	<b>L3-01 thru -06</b>
Droop	5.13	<b>b7-01,-02</b>
Hunting Prevention	5.23	<b>C7-01,-02</b>
<b>PROTECTIVE FEATURES</b>		
Momentary Power Loss Ride-thru	5.29	<b>H1-01 thru -06; L2-01,-02</b>
Auto Restart	5.5	<b>L5-01,-02</b>
Frequency Reference Loss Detection	5.20	<b>L4-05</b>
Overtorque Detection	5.42	<b>L6-01 thru -06</b>
Miscellaneous Protective Functions	5.27	<b>L8-01,-02</b>
<b>DRIVE CONTROLS, INPUT</b>		
Multi-function Analog Inputs (Term. 16, 14)	5.29	<b>H3-05,-09</b>
Frequency Reference Bias and Gain	5.17	<b>H3-03,-07,-11; H3-02,-06,-10</b>
Multi-function Input Terminals (Term. 3-8)	5.31	<b>H1-01 thru -06</b>
External Fault Terminals	5.31	<b>H1-01 thru -06</b>
<b>DRIVE OUTPUT</b>		
Multi-function Output Terminals (Term. 9 & 10; 25-27)	5.32	<b>H2-01,-02,-03</b>
Analog Monitor Output (Multi-function) (Term. 21-23)	5.30	<b>H4-01 thru -07</b>
<b>MONITOR DISPLAY</b>		
Digital Operator Display Selection	5.11	<b>o1-03</b>
Display – Monitor (at Power-up) Selection	5.12	<b>o1-02</b>



## 5.2 ACCEL/DECEL TIME

Continued

B. (Continued)

Data **A** : Accel/Decel Hold (Speed HOLD Command)

By programming data " A " into one of the multifunction input parameters ( **H1-01** thru **H1-06** ), one of the multi-function input terminals (3 thru 8) becomes a HOLD command input. As long as the HOLD command is present, accel and decel are in a prohibit state, and the output speed is held at the level it was at the time the HOLD command was input. When the HOLD command is removed while the system is still in Run condition, accel or decel will again become active to allow output to reach set speed. If Stop is initiated while the HOLD command is present, the prohibit state is cancelled and the system enters stop operation.

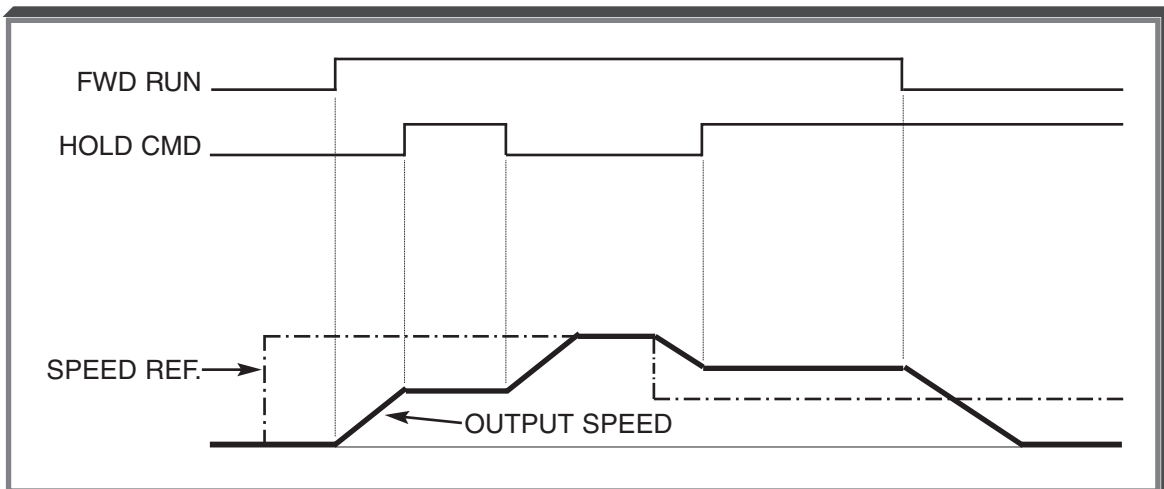

**HOLD Function Timing**

C. **C1-09** : Fast-Stop Decel Time

Factory setting: **10.0**

Range: 0.0 to 6000.0 seconds

**H1-01 thru H1-06** : Multi-function Inputs  
(Term. 3 thru 8)

Data **15** : Fast-Stop

The Fast-Stop Decel Time is used instead of the selected Decel Time ( **C1-02** , **-04** , **-06** or **-08** ) if:

- 1) It has been selected as the decel time for a specific fault ( **H5-04** , **L8-03** , etc.), or
- 2) One of the multi-function inputs has been programmed for Fast-Stop, and the corresponding input is closed.

## 5.2 ACCEL/DECEL TIME

Continued

### D. H3-05 : Multi-Function Analog Input (Term. 16)

The multi-function analog input at terminal 16 may be configured to allow analog control or the Accel/Decel time. The input voltage, in the range of 1 to 10V, determines the coefficient by which the Accel/Decel time is reduced:

$$\text{Actual Accel/Decel Time} = \frac{\text{Accel/Decel Time}}{\text{Coefficient}}$$

#### EXAMPLE:

Accel/Decel Time = 10 sec \*  
Voltage Ref. at Term. 16 = 5V

$$\text{Actual Accel/Decel Time} = \frac{10 \text{ sec}}{5 \text{ (coefficient)}} = 2 \text{ sec}$$

\* **C1-01** or **C1-02** setting, or selected accel/decel setting.

### Data 5 : Accel/Decel Time Coefficient

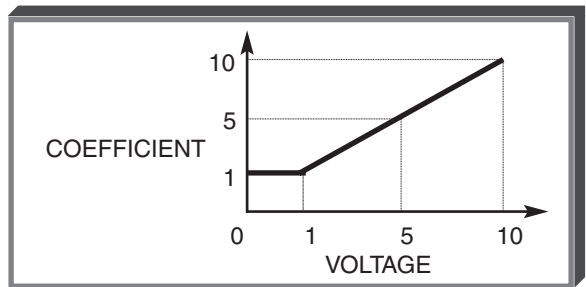
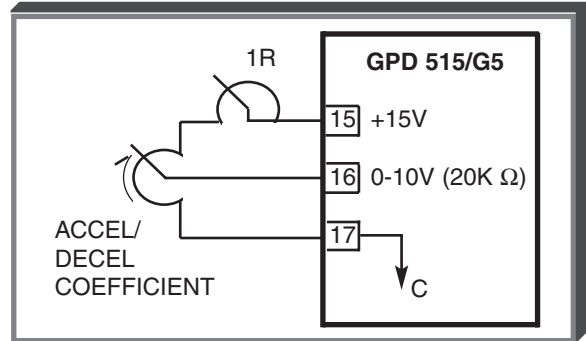

### E. C1-10 : Accel/Decel Time Setting Unit

Factory setting: **1**

Range: 0 = 0.01 seconds  
1 = 0.1 seconds

In addition to determining the setting resolution, this parameter controls the range of **C1-01** thru **C1-09**; if the resolution is 0.01 sec., the range is 0.000 to 600.00 sec. If the resolution is set to 0.1 sec., the range is 0.0 to 6000.0 sec.

### F. C1-11 : Accel/Decel Switching Frequency

Factory setting: **0.0**

Range: 0.0 to 400.0 Hz

By using **C1-11**, the Accel and Decel times can be automatically switched from Time 1 to Time 4. If the output frequency is greater than or equal to the **C1-11** frequency, the **C1-01** and **C1-02** times are used. If the output frequency is below **C1-11**, **C1-07** and **C1-08** are used instead.

NOTE: If used in conjunction with a multi-function input (**H1-01** thru **H1-06** set to "A" or "1A"), the multi-function input has priority over the **C1-11** switching frequency.

### 5.3 ACCEL/DECEL: S-CURVE CHARACTERISTICS

- C2-01** : S-Curve Characteristic Time at Accel Start
- C2-02** : S-Curve Characteristic Time at Accel End
- C2-03** : S-Curve Characteristic Time at Decel Start
- C2-04** : S-Curve Characteristic Time at Decel End

Factory setting (each): <b>0.20</b>
Range (each): 0.00 to 2.50 seconds

Setting of these parameters determine the S-curve (starting and ending) characteristics of the acceleration and deceleration ramp.

Each is set in increments of 0.01 seconds.

NOTE: Actual accel time =  
 Set accel time +  $\frac{C2-01 + C2-02}{2}$   
 Actual decel time =  
 Set decel time +  $\frac{C2-03 + C2-04}{2}$

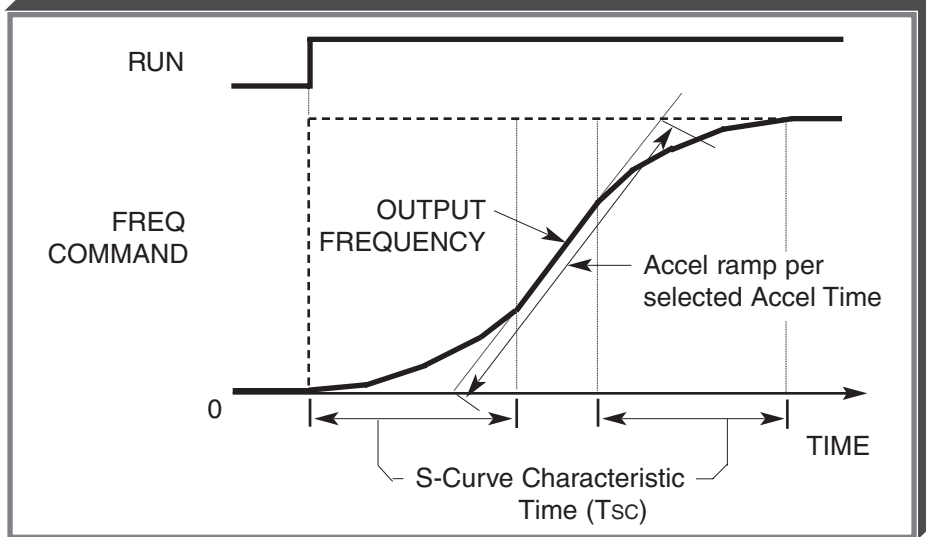

The following figure shows FWD/REV switching and acceleration & deceleration to a stop with S-curve active.

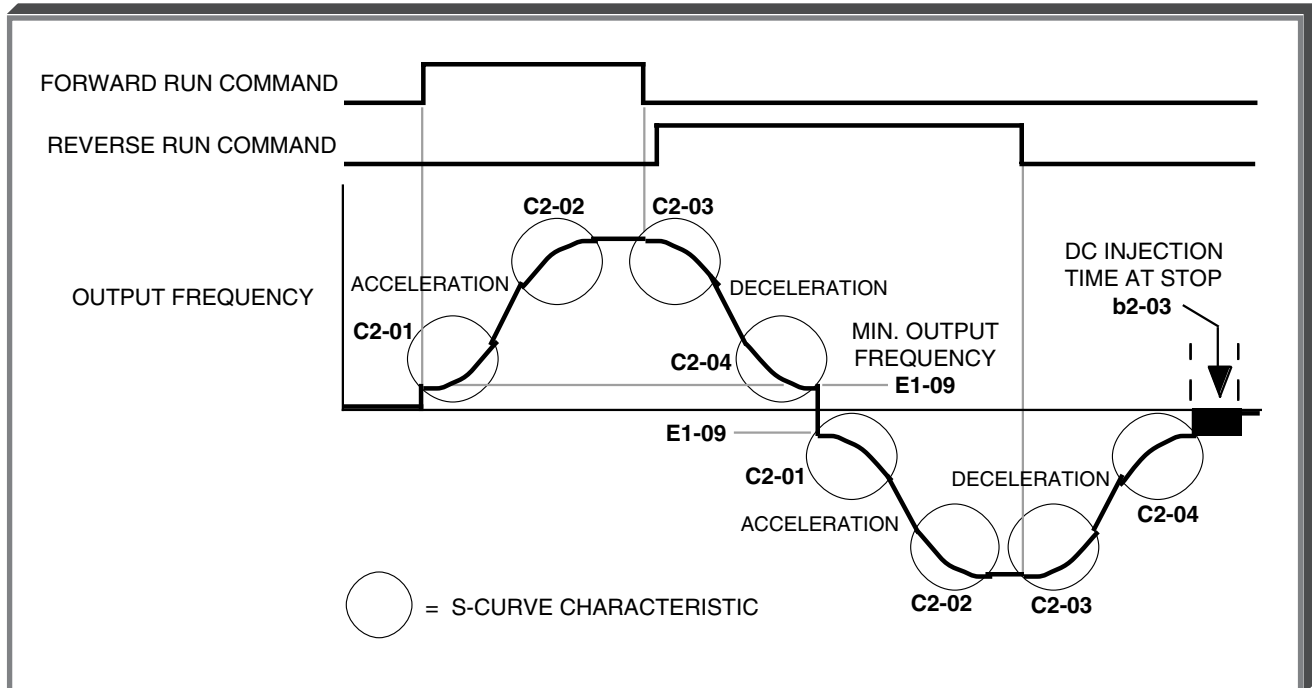

## 5.4 ACCESS LEVEL

### A. A1-01 : Parameter Access Level

Factory setting: **2**

Range: 0 to 4

This setting determines which parameters are accessible, which are also dependent upon the setting of the Control Method ( **A1-02** ).

The default setting is for Quick-start Access Level, which accesses 32 parameters. Basic Access Level allows access to 90 additional parameters. Advanced Level accesses all parameters available for a given Control Method setting. The User Program Access Level will only be available if one or more parameters are programmed into **A2-01** through **A2-32**.

Setting	Description
0	Monitor Only
1	User Program
2	Quick-start
3	Basic
4	Advanced

See paragraph 4.3 for menu trees for each of the Access Levels, and paragraph 4.5, Examples 1A and 1B, for programming examples in different Access Levels.

**B. User Program.** Parameters **A2-01** through **A2-32** can each be set by the user to allow a customized Access Level. The drive must first be temporarily set to Advanced Access Level ( **A1-04** = 4); then use the “up arrow”, “down arrow” and “right arrow” keys to set **A2-01** to the first parameter to which access is desired, **A2-02** to the next, etc.

Only the parameters entered into **A2-01** through **A2-32** will be available for monitoring and modifying if **A1-01** is then set to "1".

## 5.5 AUTO-RESTART

### A. L5-01 : Number of Auto-Restart Attempts

Factory setting: **0**

Range: 0 to 10

When a fault occurs during operation, the drive can be programmed for an auto-restart operation to automatically reset the fault. Auto-restart operation will use the number of reset attempts set in this parameter, up to the maximum of 10. When set to " 0 ", no auto-restarts will be attempted.

- The following faults can be automatically reset:
  - OC: Overcurrent
  - GF: Ground fault
  - OV: Overvoltage
  - UV1: Undervoltage (Power UV)
  - OL3: Overtorque Detect
- The following conditions WILL NOT initiate auto-restart:
  1. OL, EF\_ , PUF or CPF\_ fault.
  2. When OC or UV occurs during deceleration.
  3. When **L2-01** is programmed to stop during momentary power failure (data = " 0 "). (See paragraph 5.29, **MOMENTARY POWER LOSS RIDE-THRU.**)
- The number of restart attempts available will be reset to the **L5-01** setting when:
  1. 10 minutes has elapsed without a fault occurring.
  2. The **RESET** key, or external Fault Reset push button, is pressed.
  3. Power is removed from the Drive.

## 5.5 AUTO-RESTART

Continued

### B. L5-02 : Fault Contact Status During Auto-Restart

Factory setting: **0**

Range: 0 or 1

This digit controls how the fault contact responds to a drive fault during the auto-restart operation.

**0** = Fault contact will not actuate during auto-restart attempts

**1** = Fault contact actuates during auto-restart attempts

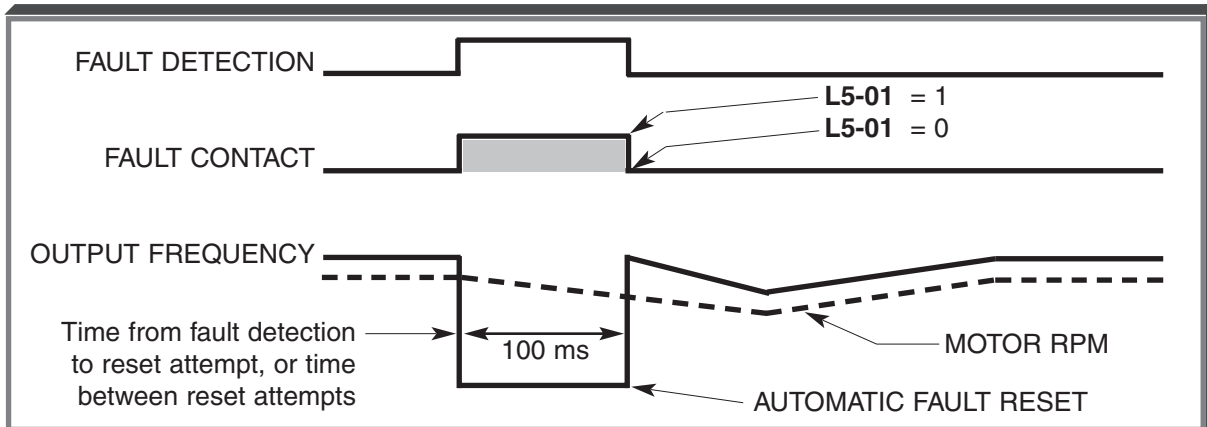

*Auto-Restart Operation Timing*

## 5.6 AUTOMATIC FREQUENCY REGULATOR (AFR) GAIN

### C8-08 : AFR Gain

Factory setting: **1.00**

Range: 0.00 to 10.00

### C8-09 : AFR Time

Factory setting: **50**

Range: 0 to 1000 msec

Useable only in Open Loop Vector Control Method ( **A1-02** = 2), these parameters affect the speed response or prevent the motor from hunting. To improve the speed response, increase **C8-08** and/or decrease **C8-09**. To stop the motor from hunting, decrease **C8-08** and/or increase **C8-09**.

## 5.7 AUTOMATIC SPEED REGULATOR (ASR)

A. **C5-01** : ASR Proportional Gain 1 (ASRP1)

Factory setting: **20.00**

Range: 0.00 to 300.00

**C5-02** : ASR Integral Time 1 (ASRI1)

Factory setting: **0.500**

Range: 0.000 to 10.000 seconds

Parameters **C5-01** and **C5-02** provide adjustments to enable the optimum performance during load disturbances. The proportional gain (**C5-01**) adjusts the amount of instantaneous droop as a function of loss, and provides damping from load disturbances such as speed reference change, or a change in load. The integral time (**C5-02**) adjusts the response time of the drive to the load disturbances.

NOTE: Speed control response is increased by increasing the proportional gain setting and decreasing the integral time. However, instability or hunting may occur between the drive and the load if **C5-01** (ASR Proportional Gain) is set too high, or **C5-02** (ASR Integral Time) is set too low.

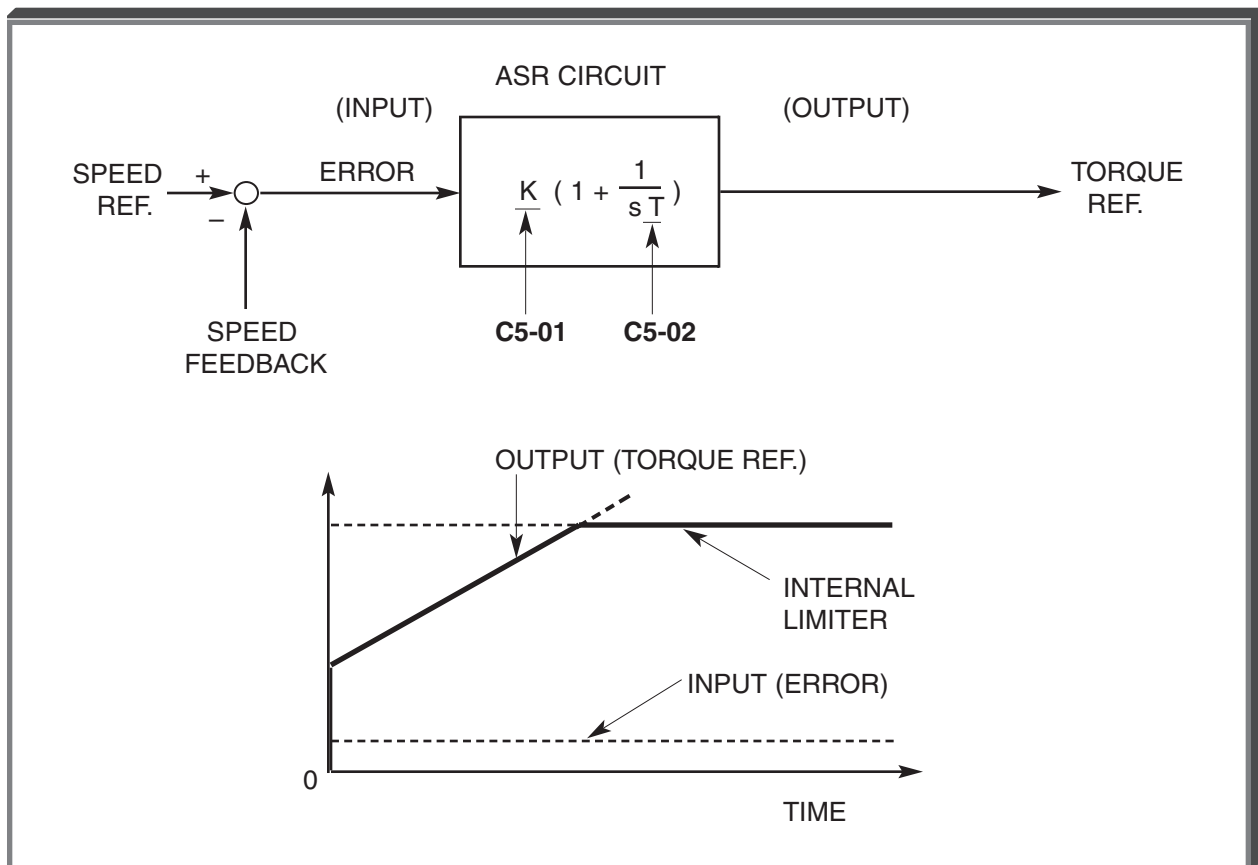



**EXAMPLES OF C5-01 AND C5-02 ADJUSTMENTS**

**ASR Gain ( C5-01 ) Adjustment Only**

Speed Ref. = 10% of max.  
**C5-01 = 30.00**  
 C5-02 = 0.000

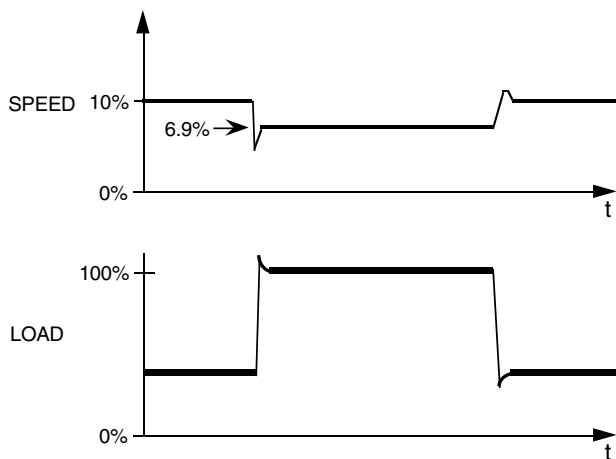

Speed Ref. = 10% of max.  
**C5-01 = 60.00**  
 C5-02 = 0.000

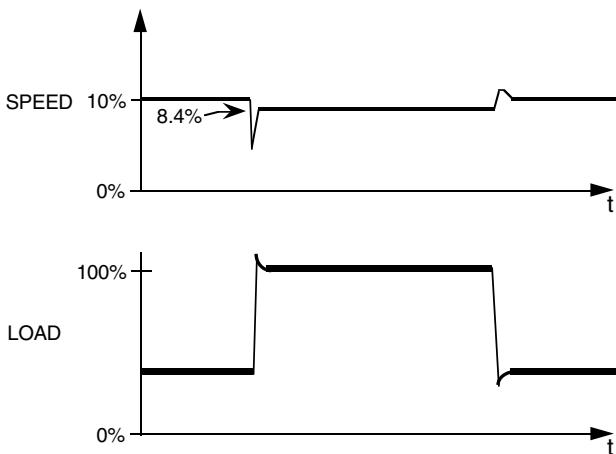

**ASR Integral Time ( C5-02 ) Adjustment Only**

Speed Ref. = 10% of max.  
 C5-01 = 30.00  
**C5-02 = 10.000**

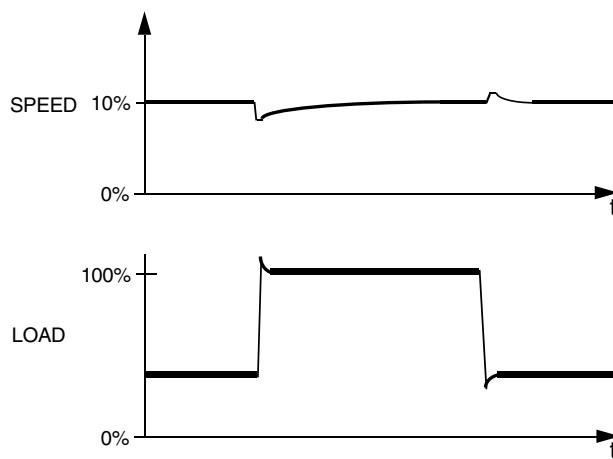

Speed Ref. = 10% of max.  
 C5-01 = 30.00  
**C5-02 = 1.000**

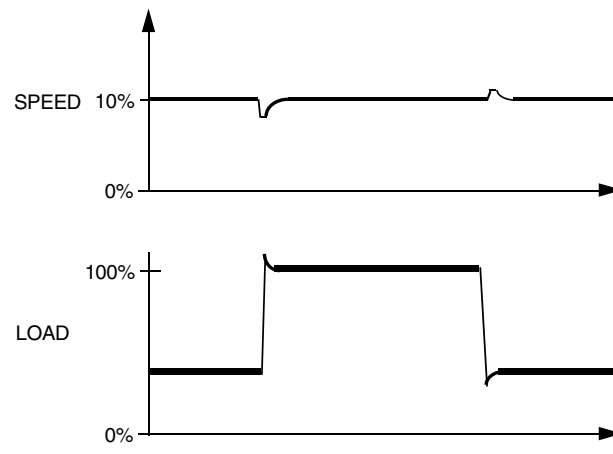

## 5.7 AUTOMATIC SPEED REGULATOR (ASR)

Continued

**B. C5-03** : ASR Proportional Gain 2 (ASRP2)

Factory setting: **20.00**

Range: 0.00 to 300.00

**C5-04** : ASR Integral Time 2 (ASRI2)

Factory setting: **0.500**

Range: 0.000 to 10.000 seconds

Parameter **C5-03** is used as an additional proportional gain adjustment, and parameter **C5-04** determines the response time for Proportional Gain 2 (**C5-03**).

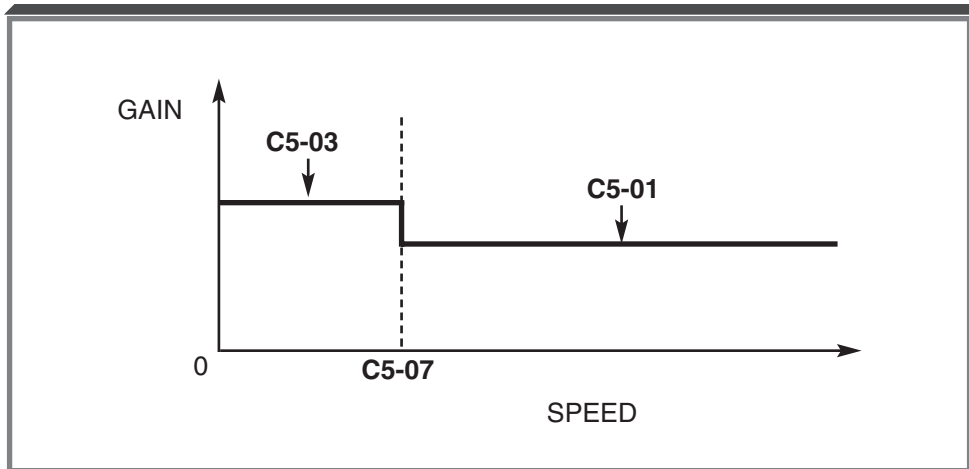

**C. H1-01** thru **H1-06**: Multi-function Input Terminal Function Selection (Term. 3 thru 8)

Data **E**: ASR Integral Reset (IRST)

By programming data " E " into one of the multi-function input parameters ( **H1-01** thru **H1-06** ), one of the multi-function input terminals (3 thru 8) becomes an ASR integral reset. When there is a long time lag between the applying of control power and actual run operation, output voltage may be produced due to the integrator offset. In such cases, the integral reset function should be ON until the start of run operation.

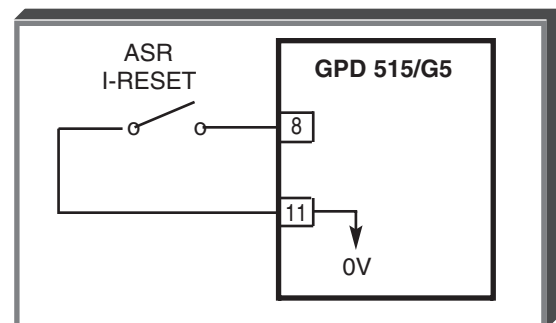

**D. C5-06** : ASR Output Lag Time

Factory setting: **4**

Range: 0 to 500 msec

This function is used as a filter for mechanical problems such as mechanical backlash, play, etc., which may prevent the ASR proportional gain from being increased as adjusted.

## 5.8 CARRIER FREQUENCY

**C6-01** : Carrier Frequency Upper Limit

Factory Setting: *See Table A3-1*

**C6-02** : Carrier Frequency Lower Limit

Range (each): 0.4 to 15.0 kHz

**C6-03** : Carrier Frequency Proportional Gain

Factory Setting: *See Table A1-3*

Range: 0 to 99

The relationship between output frequency and carrier frequency is determined from the set values of **C6-01** to **C6-03**.

(a) For constant carrier frequency (set value of **C6-01**):

Set **C6-03** = 0, and set the same value in both **C6-01** and **C6-02**.

(b) For synchronous mode (only with proportional section):

Set **C6-03** = 12, 24, 36, or 48. These setting values establish carrier frequencies of 12f, 24f, 36f, or 48f, respectively, where f = output frequency.

(c) In Vector Control mode, ONLY **C6-01** is effective.

CARRIER FREQUENCY UPPER LIMIT	K
<b>C6-01</b> ≥ 10.0 kHz	3
10.0 kHz > <b>C6-01</b> ≥ 5.0 kHz	2
<b>C6-01</b> < 5.0 kHz	1

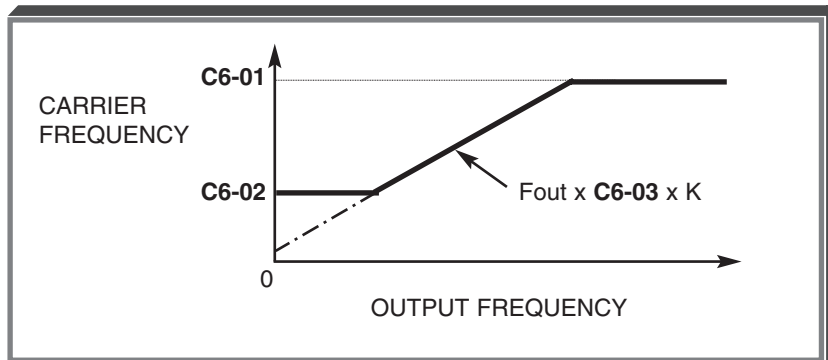

NOTE: Fault code "oPE11" is displayed if either of the following conditions is detected:

- C6-03** > 6, and **C6-02** > **C6-01**
- C6-01** > 5.0 kHz, and **C6-02** ≤ 5.0 kHz

## 5.9 CRITICAL FREQUENCY REJECTION

- A. **d3-01** : Prohibited Frequency 1  
**d3-02** : Prohibited Frequency 2  
**d3-03** : Prohibited Frequency 3

Factory setting (each): **0.0**

Range (each): 0.0 to 400.0 Hz

These parameters allow programming of up to three prohibited frequency points for eliminating problems with resonant vibration of the motor/machine. This feature does not actually eliminate the selected frequency values, but will accelerate and decelerate the motor through the prohibited bandwidth.

- B. **d3-04** : Prohibited Frequency Deadband

Factory setting: **1.0**

Range: 0.0 to 20.0 Hz

This parameter determines the width of the deadband around each selected prohibited frequency point. The factory setting is " 1.0 ", which establishes a deadband of  $\pm 1.0$  Hz.

### EXAMPLE:

Vibration encountered between 30.0 and 36.0 Hz.

SOLUTION: Set **d3-01** = 33.0. This is the center of the problem frequency band.

Set **d3-04** = 3.0. This will cause the drive to reject all frequency command values between 30.0 and 36.0 Hz.

A frequency command in the deadband will be converted to the bottom value of the deadband, e.g. a command of 33 Hz would result in a run frequency of 30 Hz.

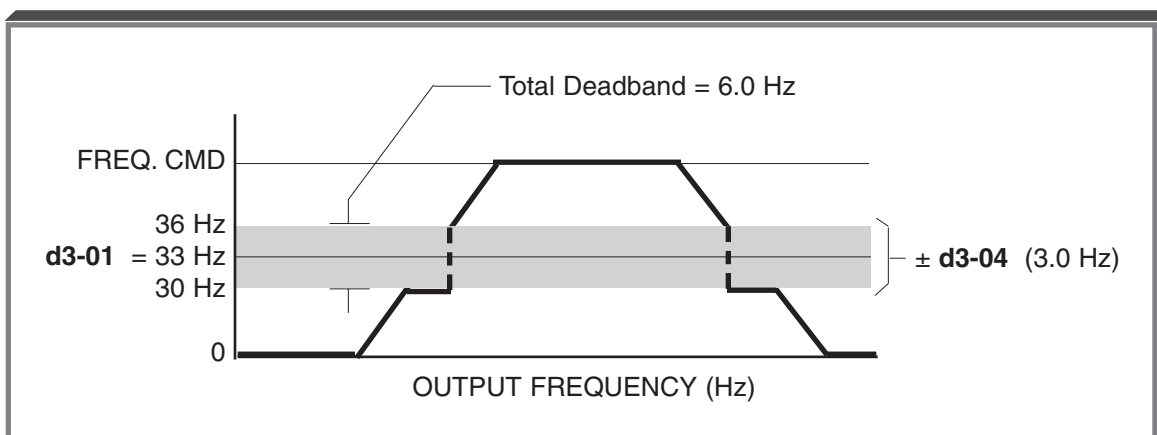

## 5.10 DC INJECTION BRAKING

A. **b1-03** : Motor Stopping Method Selection

Factory setting: **0**

Range: 0 to 3

**b2-04** : DC Injection Time at Stop

Factory setting: **0.50**

Range: 0.00 to 10.00 seconds

When full range DC injection braking stop is enabled (**b1-03** = 2), DC injection braking is used to stop a motor more quickly than normal coast to stop, without the need for braking resistors. When a STOP command is issued, there is a 0.5 second time delay to apply DC to two phases of the motor's stator winding. Then DC injection current is applied. The duration of DC braking is a time period proportional to **b2-04** (at 10% output frequency) and the level of output frequency at the time the STOP command is issued.

Braking torque is 50-70% of full load motor torque.

### EXAMPLE:

**b2-04** = 0.5 sec (at 10% output)

Braking time at Fmax (100% output frequency) =  $10 \times 0.5 = 5$  seconds

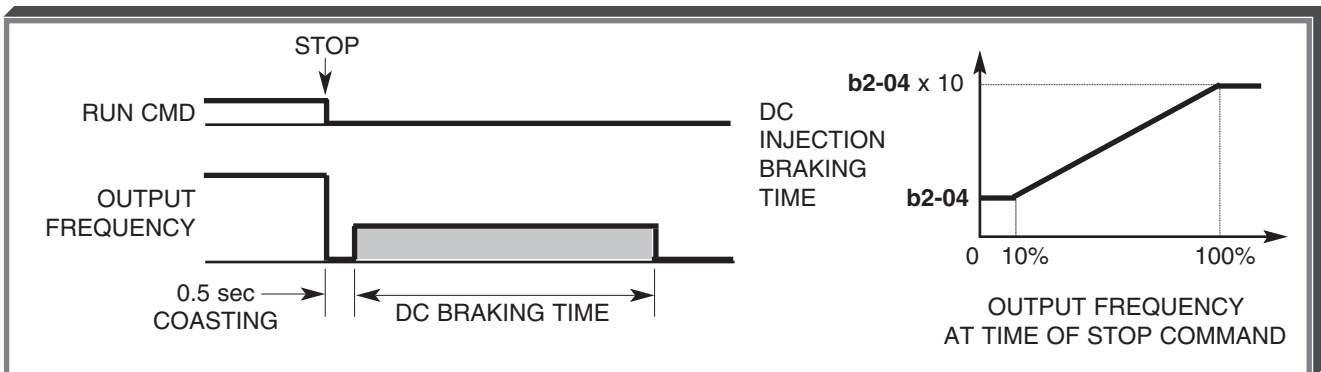

**Full Range DC Injection Braking Stop Sequence**

## 5.10 DC INJECTION BRAKING Continued

**B. b2-01** : DC Inj. Braking Start Frequency

Factory Setting: <b>0.5</b>
-----------------------------

Range: 0.1 to 10.0 Hz
-----------------------

**b2-02** : DC Injection Braking Current  
(% of Drive Rated Current)

Factory setting: <b>50</b>
----------------------------

Range: 0 to 100 %
-------------------

**b2-03** : DC Injection Time at Start

Factory setting: <b>0.00</b>
------------------------------

Range: 0.00 to 10.00 seconds
------------------------------

**b2-04** : DC Injection Time at Stop

Factory setting: <b>0.00</b>
------------------------------

Range: 0.00 to 10.00 seconds
------------------------------

DC injection can be used to stop a motor whose rotational direction is uncertain at start-up. For this operation, application of DC injection braking current is controlled by a multi-function input (see paragraph 5.8.D).

With ramp to stop enabled ( **b1-03** = 0 ), after a STOP command is received the drive controls motor deceleration according to the Decel Time setting, until output frequency reaches the DC Injection Braking Start Frequency ( **b2-01** setting). Then the drive output is turned off and DC injection current is applied to the motor. The effective DC injection time and current should be set to provide adequate stopping without excessive motor heating. The DC injection voltage is determined by the DC injection braking current and motor impedance.

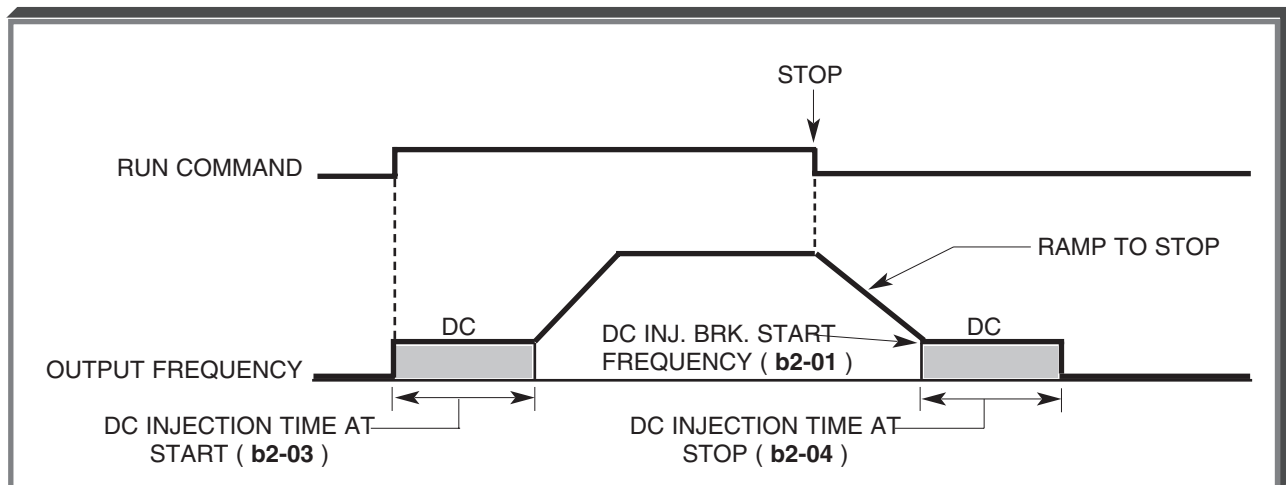

**DC Braking Sequence**

**b2-08** : Field Compensation  
At Start

Factory setting: <b>0</b>
---------------------------

Range: 0 to 500%
------------------

This parameter adjusts the amount of motor current during DC Injection at start. A setting of 0% disables this feature. A setting of 100% equals motor no-load current (**E2-03**). This current level will be applied until the DC Injection Time at Start (**b2-03**) expires. This parameter is useful when starting motors that are relatively higher in horsepower than the drive, due to the requirement for increased magnetizing current. This parameter may also compensate for reduced starting torque due to motor circuit inefficiencies.

## 5.10 DC INJECTION BRAKING

Continued

### C. H3-05 : Multi-function Analog Input (Term. 16)

Data 6 : DC Injection Braking Current Adjust

The multi-function analog input at terminal 16 may be configured to allow analog control of the amount of DC injection braking current (from 0% to 100% of the current level set in **b2-02**), which directly controls the amount of DC injection voltage applied to the motor.

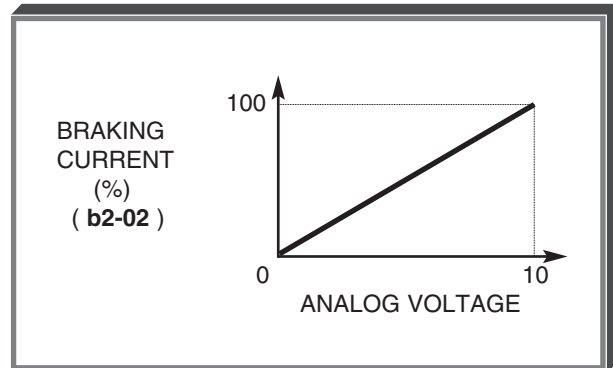
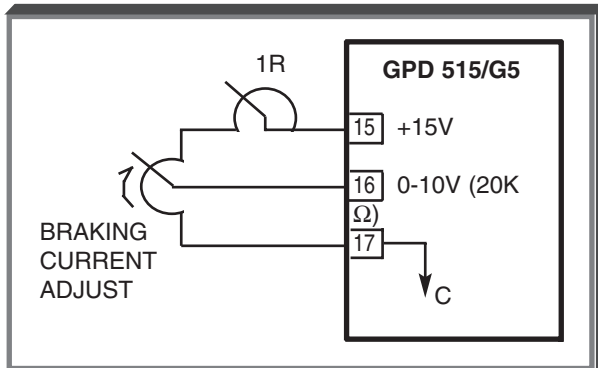

### D. H1-01 thru H1-06 : Multi-function Inputs (Term. 3 thru 8)

Data 60 : DC Injection Braking Command

Any multi-function input terminal can be utilized to control DC injection braking. When used, DC injection current will be applied until the input is removed, provided that the drive output frequency is *below* the DC Braking Start Frequency (**b2-01**).

#### EXAMPLE:

**H1-06 = 60**

Contact input at Terminal 8 is the DC Injection Braking Command

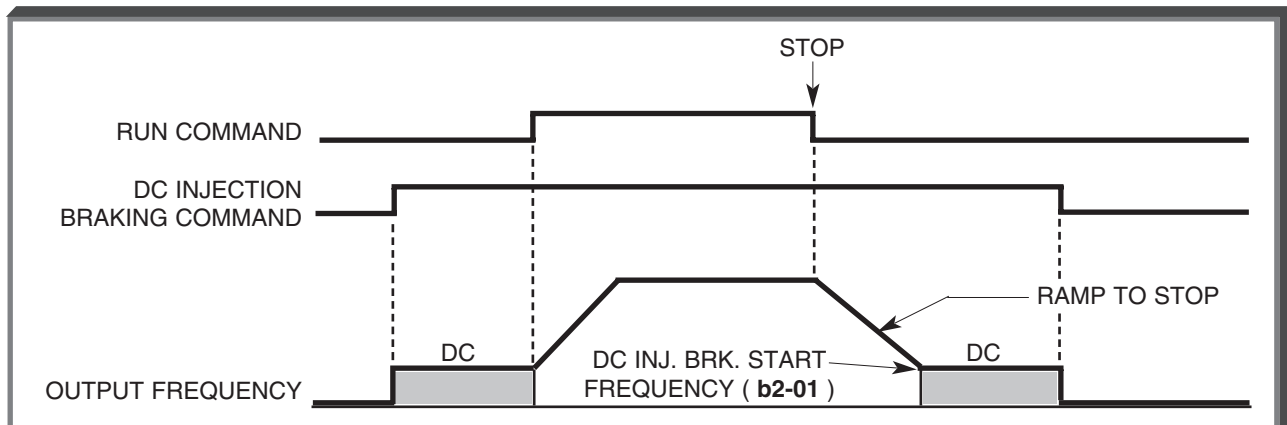
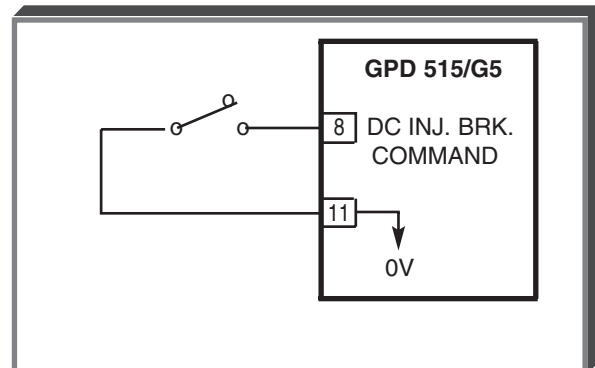

**DC Braking Sequence**

## 5.11 DIGITAL OPERATOR DISPLAY SELECTION

**o1-03** : Display Scaling

Factory setting: **0**

Range: 0 to 39999

This parameter determines the scaling of the Digital Operator display, for both Output Frequency and all Frequency References.

DATA	DISPLAY
<b>0</b> (factory setting)	Output frequency, in increments of 0.01 Hz.
<b>1</b>	Output frequency, in increments of 0.01 %.
<b>2 to 39</b> (no. of motor poles)	<p>Motor synchronous speed (<math>P = \frac{120 \times F}{N_s}</math>) in increments of 1 RPM * (39999 max).</p> <p>P = no. of motor poles F = Frequency N<sub>s</sub> = motor synchronous speed</p> <p>NOTE: If motor synchronous speed exceeds 39999 RPM, display holds at " <b>39999</b> ".</p>
<b>00040</b> to <b>39999</b>	<p>Line speed or other parameter. Setting must be 5 digits.</p> <p style="text-align: center;">X X X X X</p> <p style="text-align: center;">└───┬───┘ Display value at maximum frequency ( <b>E1-04</b> )(include leading zeroes if necessary)</p> <p style="text-align: center;">└───┬───┘ Location of decimal point:  <b>0</b> = X X X X  <b>1</b> = X X X . X  <b>2</b> = X X . X X  <b>3</b> = X . X X X                      (See <b>CAUTION</b> on next page)</p> <p><b>EXAMPLE:</b></p> <p>To display Line Speed, based on 54.32 FPM at 60 Hz:  <b>o1-03</b> setting = <b>25432</b></p>

\* Ineffective when in Flux Vector Control mode.



## 5.11 DIGITAL OPERATOR DISPLAY SELECTION

Continued

Exceptions to the general format are as follows:

<b>o1-03</b>	<b>DISPLAY</b>
" 1 0 0 0 0 "	= 1 0 0 0 . 0
" 2 0 0 0 0 "	= 1 0 0 . 0 0
" 3 0 0 0 0 "	= 1 0 . 0 0 0

### CAUTION

**When setting a value in o1-03, the decimal point position selected will automatically affect all of the Frequency Reference Memory Settings ( d1-01 thru d1-09; see Table A1-4).**

#### EXAMPLE:

**o1-03** factory setting: **0 0 0 0 0**  
**d1-09** (Jog) factory setting: **0 0 6 . 0 0** (6 Hz)

**o1-03** changed to **1 0 6 0 0**  
 Decimal point at X X X.X

**d1-09** setting becomes **0 0 6 0 . 0**

Therefore, for 10.00 Hz Jog frequency, **d1-09** must be reprogrammed to " **0 0 1 . 0 0** " .

#### **o1-04** : Digital Operator Display Units

Factory setting: **0**

Range: 0 or 1

This parameter sets the frequency units for Flux Vector mode.

The setting of **o1-04** affects the following parameters:

- E1-04** : Maximum Frequency
- E1-06** : Base Frequency
- E1-07** : Mid Frequency A
- E1-09** : Minimum Frequency
- E1-11** : Mid Frequency B

<b>Setting</b>	<b>Description</b>
0	Hertz
1	RPM

#### **o1-05** : Parameter/Address Display Selection

Factory setting: **0**

Range: 0 or 1

This parameter selects whether the parameter addresses are displayed on the Digital Operator by parameter number, or by its corresponding MODBUS address number.

<b>Setting</b>	<b>Description</b>
0	Parameter Number
1	MODBUS Address

## 5.12 DISPLAY – MONITOR ( AT POWER-UP) SELECTION

**o1-02** : Monitor Selection After Power-up

Factory setting: **1**

Range: 1 to 4

This parameter determines which monitor display will appear on the Digital Operator when the drive is powered up. The number programmed into **o1-02** corresponds to the appropriate **U1-XX** parameter, which determines monitor status.

o1-02 SETTING	MONITOR SELECTION
<b>1</b>	<b>U1-01</b> — Frequency Reference
<b>2</b>	<b>U1-02</b> — Output Frequency
<b>3</b>	<b>U1-03</b> — Output Current
<b>4</b>	<b>U1-XX</b> — Monitor parameter selected by <b>o1-01</b>

**o1-01** : Monitor Selection

Factory setting: **6**

Range: 4 to 38

This setting allows the user to select an item to be displayed in the monitored parameters list. The **o1-01** parameter corresponds to the **o1-02** setting "4 - Selected Monitor". For example, to display DC bus voltage in the monitored parameters list, set parameter **o1-01** to "7" for monitor selection **U1-07**.

## 5.13 DROOP

**b7-01** : Droop Control Gain

Factory setting: **0.0**

Range: 0.0 to 100.0%

When active, the speed decreases or increases in proportion to load torque. As the load increases, the speed droops according to the percentage set in **b7-01**. As the load decreases, the speed increases.

Maximum droop is reached at full load. Maximum speed is based on the maximum output frequency setting ( **E1-04** ). Excessive droop, which results in a significant difference between the speed reference and the speed feedback, may activate a Speed Deviation ( **DEV** ) fault. The deviation detection level is an adjustable value, which can be set in parameter **F1-10**.

**b7-02** : Droop Control Delay Time

Factory setting: **0.05**

Range: 0.03 to 2.00 seconds

The setting of this parameter determines the drive's droop response time to a load change.

### NOTE

Only available in the Flux Vector Control Method ( **A1-02** = 3 ).

## 5.14 DWELL

**b6-01** : Dwell Frequency at Start

Factory setting: **0.0**

Range: 0.0 to 400.0 Hz

**b6-02** : Dwell Time at Start

Factory setting: **0.0**

Range: 0.0 to 10.0 seconds

**b6-03** : Dwell Frequency at Stop

Factory setting: **0.0**

Range: 0.0 to 400.0 Hz

**b6-04** : Dwell Time at Stop

Factory setting: **0.0**

Range: 0.0 to 10.0 seconds

This function allows the drive to temporarily suspend acceleration or deceleration and remain at a desired output frequency for a specified length of time.

After receiving a run command, the drive accelerates to the designated dwell start frequency (**b6-01**). The output is then held at that frequency for the duration of the dwell time at start (**b6-02**). After that length of time the drive continues to accelerate to the set frequency.

When the run command is removed the drive decelerates to the designated dwell stop frequency (**b6-03**). The output is then held at that frequency for the duration of the dwell time at stop (**b6-04**). After that length of time the drive continues to decelerate until the output frequency is zero.

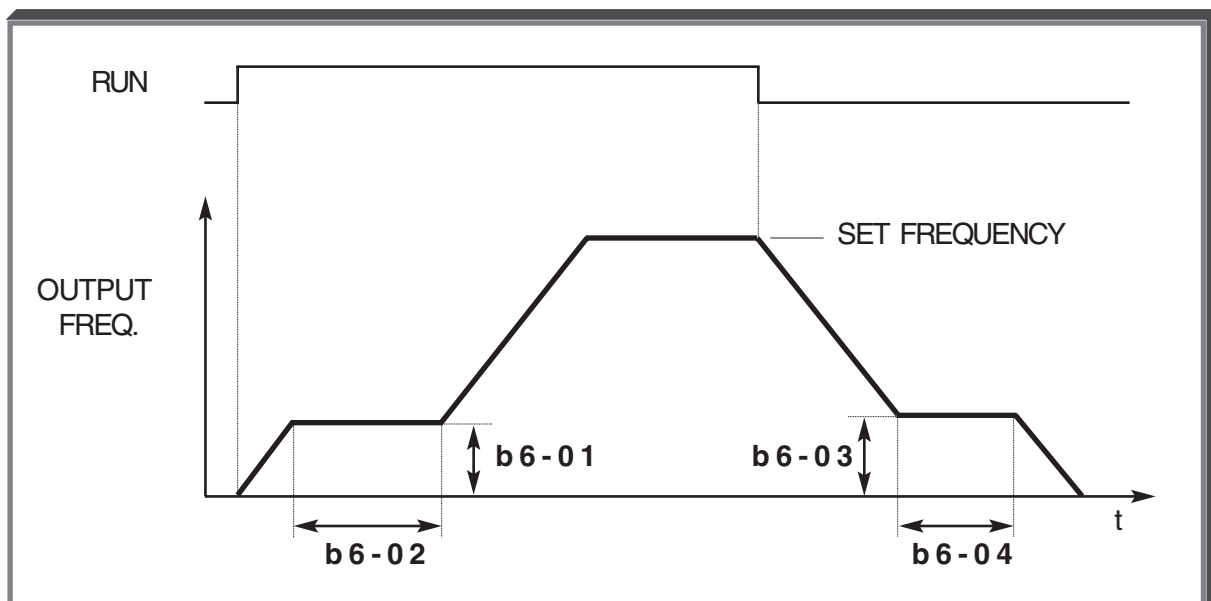

## 5.15 ENCODER (PG) PARAMETERS

A. **F1-01** : Encoder (PG) Constant

Factory setting: <b>1 0 2 4</b>
---------------------------------

Range: 0 to 60000 ppr
-----------------------

This parameter is set to the Pulses Per Revolution (ppr) to the encoder used with the motor.

B. **F1-02** : Operation Selection at PG  
Open Circuit

Factory setting: <b>1</b>
---------------------------

Range: 0 : Ramp to Stop 1 : Coast to Stop 2 : Fast-stop 3 : Alarm Only
---

**F1-14** : PG Open Circuit Detection  
Delay Time

Factory setting: <b>2.0</b>
-----------------------------

Range: 0.0 to 10.0 seconds
----------------------------

The setting of **F1-02** determines the stopping method when a PG Open Circuit ( **PGo** ) is detected. A PG open circuit is detected when no pulses are received from the pulse generator within the time specified by **F1-14** . (Note: The PG Open fault is disabled when zero speed is commanded.)

### NOTE

Only available in the V/f w/PG and the Flux Vector Control Methods  
( **A1-02** = 1 or 3).

**5.15 ENCODER (PG) PARAMETERS**

Continued

**C. F1-08** : Overspeed Detection LevelFactory setting: **115**

Range: 0 to 120 %

**F1-09** : Overspeed Detection Delay TimeFactory setting: *See Table A3-2*

Range: 0.0 to 2.0 seconds

**F1-03** : Operation Selection at  
OverspeedFactory setting: **1**

Range: 0 : Ramp to Stop

1 : Coast to Stop

2 : Fast-stop

3 : Alarm Only

Parameters **F1-08** and **F1-09** work together to determine when an overspeed ( **oS** ) fault will occur. Parameter **F1-08** sets the desired overspeed level as a percentage of the maximum output frequency ( **E1-04** ), and **F1-09** determines how long the overspeed condition will be allowed to exist before a fault will occur. Parameter **F1-03** determines the stopping method when an overspeed fault ( **oS** ) occurs.

**EXAMPLE:**

A given application requires that if motor speed were to ever reach 1980 RPM, an overspeed fault would occur and the motor should coast to stop. The motor has 4 poles, and maximum frequency ( **E1-04** ) = 60Hz.

$$\mathbf{F1-08} = \frac{\text{Desired Overspeed Level} \times \text{Number of Motor Poles}}{120 \times \text{Maximum Frequency}} \times 100\%$$

( **E2-04** )  
( **E1-04** )

$$\mathbf{F1-08} = \frac{1980 \times 4}{120 \times 60} \times 100\% = \mathbf{110\%}$$

$$\mathbf{F1-03} = \mathbf{1} \quad \text{Coast to Stop}$$

**NOTE**

Only available in the V/f w/PG and Flux Vector Control Methods  
( **A1-02** = 1 or 3).

**5.15 ENCODER (PG) PARAMETERS**

Continued

**D. F1-10** : Excessive Speed Deviation  
Detection Level

Factory setting: **1 0**

Range: 0 to 50 %

**F1-11** : Excessive Speed Deviation  
Detection Delay Time

Factory setting: **0.5**

Range: 0.0 to 10.0 seconds

**F1-04** : Operation Selection at  
Speed Deviation

Factory setting: **3**

Range: 0 : Ramp to Stop

1 : Coast to Stop

2 : Fast-stop

3 : Alarm Only

Parameters **F1-10** and **F1-11** work together to determine when a Speed Deviation ( **DEV** ) fault will occur. Parameter **F1-10** determines how far the motor speed has to differ from the speed reference (set as a percentage of **E1-04** ), and **F1-11** determines how long the speed has to deviate before a fault will occur. Use **F1-04** to determine stopping method if a speed deviation fault occurs.

**EXAMPLE:**

**F1-10** = 10 %, **F1-11** = 0.5 sec, **F1-04** = 1, and **E1-04** (Max Frequency) = 60 Hz. As can be seen below, the motor speed must drop over 10% below the speed reference for 0.5 seconds before a fault occurs.

$$10\% \text{ speed} = \mathbf{E1-04} \times 0.1 = 60 \times 0.1 = 6\text{Hz}$$

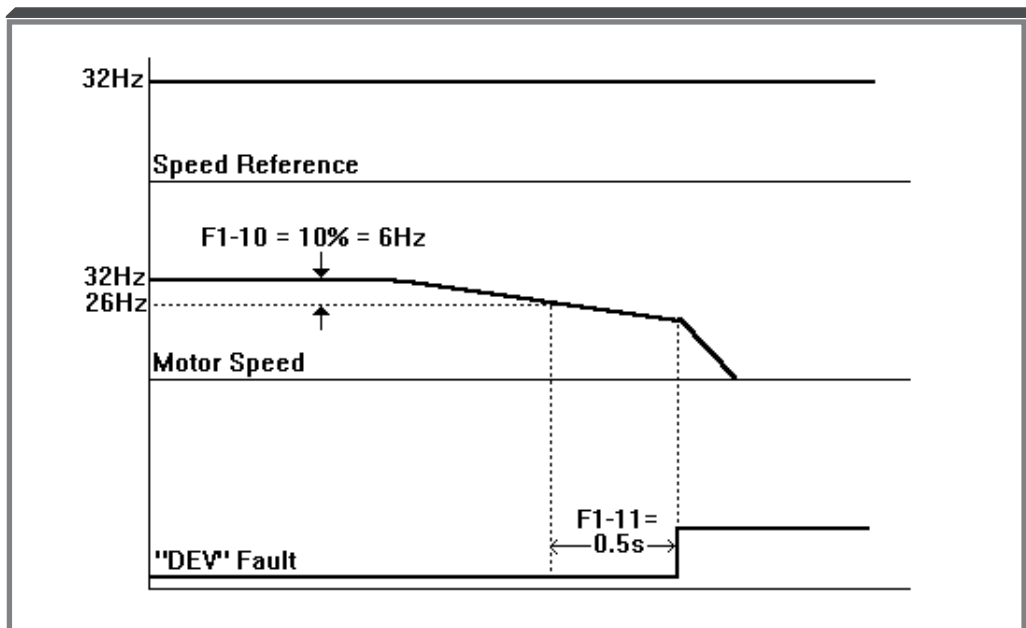
**NOTE**

Only available in the V/f w/PG and Flux Vector Control Methods ( **A1-02** = 1 or 3).

## 5.15 ENCODER (PG) PARAMETERS

Continued

### E. F1-05 : PG Rotation

Factory setting: <b>0</b>
---------------------------

Range: 0 : Counter-clockwise 1 : Clockwise
---

The setting of **F1-05** determines how the drive interprets the incoming pulses from the pulse generator. It can be used to change direction of the motor without having to change encoder wiring.

#### EXAMPLE:

To run a particular machine “forward” requires the motor shaft to turn in a clockwise direction when viewed from the output shaft end of the motor. The motor/encoder that is installed is running counter-clockwise as forward. In order to change the direction of the motor, two of the motor leads need to be swapped, and **F1-05** needs to be changed to a **1**.

#### NOTE

Only available in the V/f w/PG and Flux Vector control modes ( **A1-02** = 1 or 3).

### F. F1-07 : Integral Value During Accel/Decel Selection

Factory setting: <b>0</b>
---------------------------

Range: 0 : Disabled 1 : Enabled
------------------------------------

The setting of **F1-07** determines whether the automatic speed regulator (ASR) integral operation is performed during accel/decel.

#### NOTE

Only available in the V/f w/PG Control Method ( **A1-02** = 1).

## 5.15 ENCODER (PG) PARAMETERS

Continued

G. **F1-12** : Number of PG Gear Teeth 1

Factory setting: <b>0</b>
---------------------------

Range: 0 to 1000
------------------

**F1-13** : Number of PG Gear Teeth 2

Factory setting: <b>0</b>
---------------------------

Range: 0 to 1000
------------------

Parameters **F1-12** and **F1-13** are used to set the gear ration when there is a gear ratio between the motor and the pulse generator. This function is disabled when **F1-12** and **F1-13** are set to **0**.

$$\text{Motor Speed (RPM)} = \text{Load Speed (RPM)} \times \frac{\text{PG Gear Teeth 2}}{\text{PG Gear Teeth 1}}$$

( **F1-13** )  
( **F1-12** )

### EXAMPLE:

A motor is connected to a load through a toothed timing belt. The sheave on the motor has 23 teeth, and the sheave on the load had 75 teeth. The only mechanically practical place to mount a pulse generator for speed feedback is on the same shaft as the load sheave. In order to correctly scale the encoder feedback, **F1-12** needs to be set to **23**, and **F1-13** needs to be set to **75**.

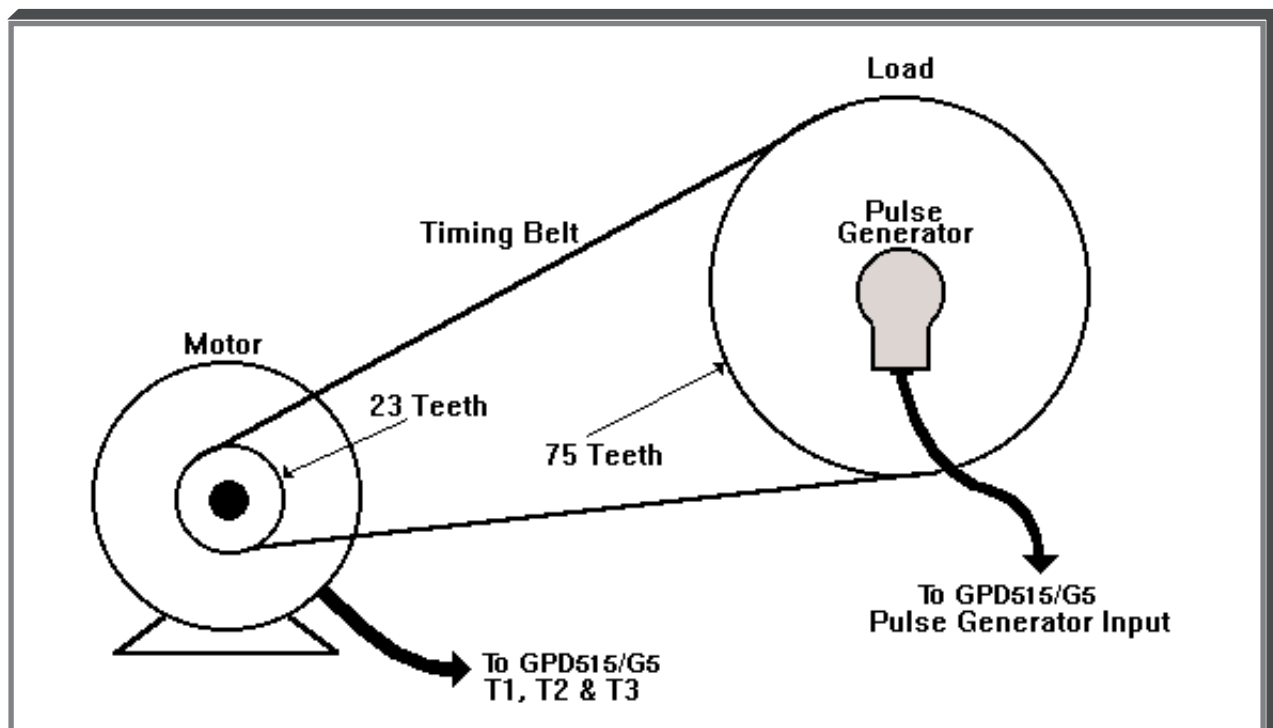

NOTE

Only available in the V/f w/PG Control Method ( **A1-02** = 1 ).



## 5.16 ENERGY SAVING OPERATION

### A. Energy Saving V/f Control Methods

Factory setting: **0**

Range: 0 to 100 %

**b8-01** : Energy Saving Gain

This parameter is only available in the V/f or V/f w/PG Control Methods (**A1-02** = 0 or 1). This parameter sets, in increments of 1%, the level to which the output voltage is reduced during the energy-saving operation.

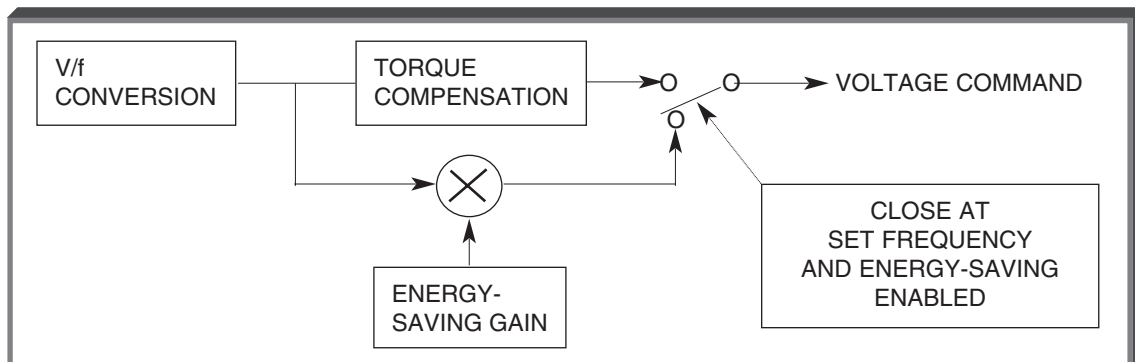

**Output Voltage During Energy-Saving Operation**

**b8-02** : Energy Saving Frequency

Factory setting: **0.0**

Range: 0 to 400 Hz

This parameter is only available in the V/f or V/f w/PG control methods (**A1-02** = 0 or 1). The energy saving function will only activate if all of the following conditions are met: a multi-function input is activated which is set to energy savings (data **63**), output frequency is above the Energy Saving Frequency **b8-02**, and the drive is up to its set speed (output frequency = frequency reference).

### B. Energy Saving – Open Loop Vector & Flux Vector Control Methods

Factory setting: **0**

Range: 0 or 1

**b8-03** : Automatic Energy Saving Selection

Setting	Description
0	Disabled – Energy saving mode will not be activated under light loads.
1	Enabled – The energy saving mode will automatically be activated under light loads.

This parameter is only available when in the open loop vector or flux vector control methods (**A1-02** = 2 or 3). When **b8-03** is set to a 1, a multi-function contact input is **not** required to activate energy saving mode. This function is separate and should not be confused with parameters **b8-01** and **b8-02**. When the drive detects a lightly loaded motor, the output voltage will automatically be reduced.

## 5.16 ENERGY SAVING OPERATION

Continued

**b8-04** : Automatic Energy Saving Control Gain

Factory setting: **0.7\***

Range: 0.0 to 10.0

\*Factory setting becomes **1.0** when **A1-02 = 3**

**b8-05** : Automatic Energy Saving Control Time Constant

Factory setting: **0.50\*\***

Range: 0.00 to 10.0 sec.

\*\*Factory setting becomes **0.01** when **A1-02 = 3**

These parameters are only available when in the open loop vector or flux vector control methods (**A1-02 = 2 or 3**). Parameters **b8-04** and **b8-05** adjust the energy savings voltage regulator. Increasing the gain (**b8-04**) and/or decreasing the time constant (**b8-05**) will increase the responsiveness of the energy savings function. If the response is set too fast, the drive may become unstable. If the response is set too slow, the drive may respond incorrectly when the motor load is re-applied.

**H1-01** thru **H1-06** : Multi-function Inputs (Term. 3 thru 8)

Data **63** : Energy Saving Operation

A multi-function input must be used to command energy saving operation.

When the external Energy-Saving Operation command is closed at set frequency, the energy-saving operation shown below is enabled. In the energy saving operation, the output voltage is the value of the energy saving gain (**b8-01**; factory set to 80%) multiplied by the V constants defined by **E1-05, -08 and -10**.

### NOTE

If energy saving operation is enabled before accel time is complete, output V/Hz is not affected until set frequency is reached; then output voltage is reduced by energy-saving gain (**b8-01**) setting.

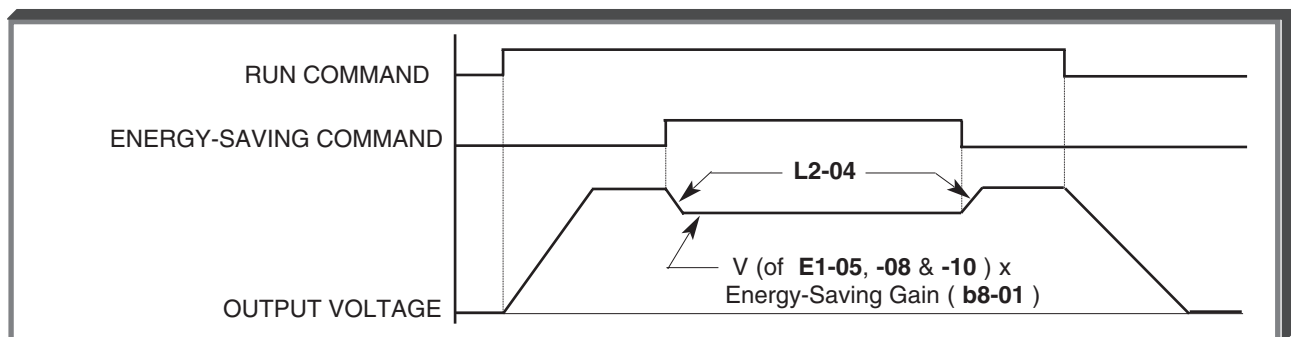
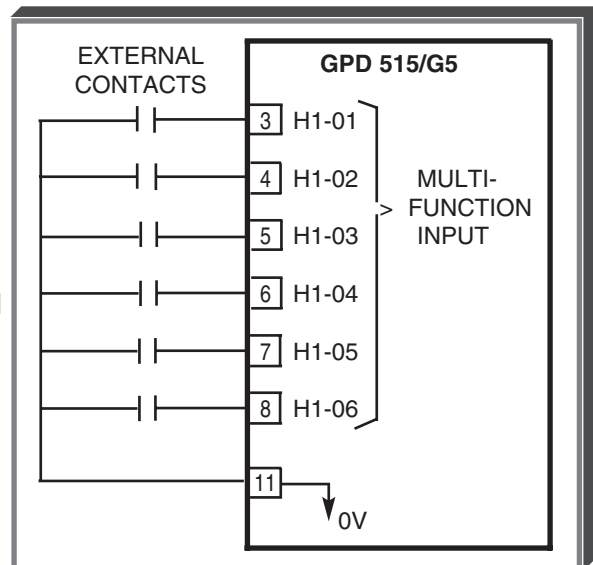

**Energy-Saving Run Timing**

## 5.17 EXTERNAL FAULT INPUTS

**H1-01** thru **H1-06** : Multi-function  
Inputs (Term. 3 thru 8)

Data **20-2F** : External Fault

The multi-function input terminals can be used to define various modes of external faults. When the External Faults 1-4 are inputted, " **EF3** " to " **EF8** " are displayed on the Digital Operator (steady for a major fault situation, blinking for a minor fault situation). The second digit of the **H1-01** thru **H1-06** setting is entered in hexadecimal values which defines what type of external fault contact is used and how the drive will react to the fault input.

H1-0X Data: 2 __	Mode (Note 2)				Always Detected	During Operation	Terminal Input (Note 1)	
	0	1	2	3			N.O.	N.C.
0	X				X		X	
1	X				X			X
2	X					X	X	
3	X					X		X
4 (Factory Set)		X			X		X	
5		X			X			X
6		X				X	X	
7		X				X		X
8			X		X		X	
9			X		X			X
A			X			X	X	
B			X			X		X
C				X	X		X	
D				X	X			X
E				X		X	X	
F				X		X		X

### NOTES

1. N.O. = normally open contact; N.C. = normally closed contact.
2. Mode 0 = Ramp to Stop (decel time per **C1-02**);  
Mode 1 = Coast Stop;  
Mode 2 = Emergency Stop (decel time per **C1-09**);  
Mode 3 = Continuous operation (minor fault).

### EXAMPLE:

To program External Fault 3 (Terminal 3)  
for a N.C. contact, always detected, and  
drive to continue operation:

**H1-01** = 2D

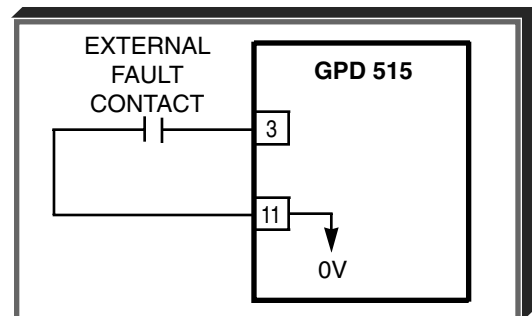

## 5.18 FREQUENCY REFERENCE BIAS/GAIN

**H3-02** : Frequency Reference Gain (Term. 13)  
**H3-06** : Frequency Reference Gain (Term. 16)  
**H3-10** : Frequency Reference Gain (Term. 14)

Factory setting (each): **100.0**

Range (each): 0.0 to 1000.0 %

These parameters can be used to set the frequency command gain, in increments of 0.1%, for its respective terminal.

**H3-03** : Frequency Reference Bias (Term. 13)  
**H3-07** : Frequency Reference Bias (Term. 16)  
**H3-11** : Frequency Reference Bias (Term. 14)

Factory setting (each): **0.0**

Range (each): -100.0 to 100.0 %

These parameters can be used to set the frequency command bias, in increments of 0.1%, for its respective terminal.

NOTE: If **H3-09** = 1F, **H3-10** and **H3-11** have no effect. Gain and bias for terminal 14 are set by **H3-02** and **H3-03**, respectively.

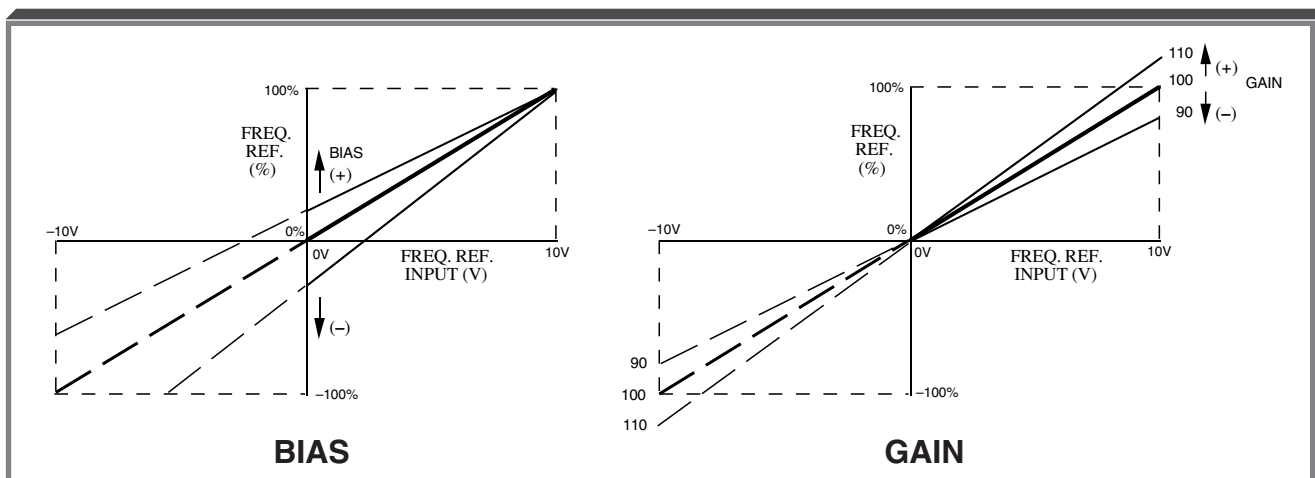

### ADJUSTMENT PROCEDURE:

- A. For 0-10 Vdc input (term. 13 or 16)
  1. With no input, adjust Bias (**H3-03** or **H3-07** setting) until an output of 0.0 Hz is obtained.
  2. With full scale input, adjust Gain (**H3-02** or **H3-06** setting) until an output of 60.0 Hz (or other desired max. output frequency) is obtained.
- B. For 4-20mA input (term. 14)
  1. With 4mA input, adjust Bias (**H3-11** setting) until an output of 0.0 Hz is obtained.
  2. With 20mA input, adjust Gain (**H3-10** setting) until an output of 60.0 Hz (or other desired max. output frequency) is obtained.

### NOTE

Follow the same adjustment procedure for other desired frequency setpoints.

## 5.18 FREQUENCY REFERENCE BIAS/GAIN

Continued

### ADJUSTMENT PROCEDURE (continued):

- C. For inverse-acting frequency reference
1. Begin with **H3-02** & **H3-03** settings as shown below.
  2. Fine tune as indicated in A or B above.

Frequency reference inputs:  
 terminals 13 & 17 — 0-10 VDC  
 terminals 14 & 17 — 4-20 mA

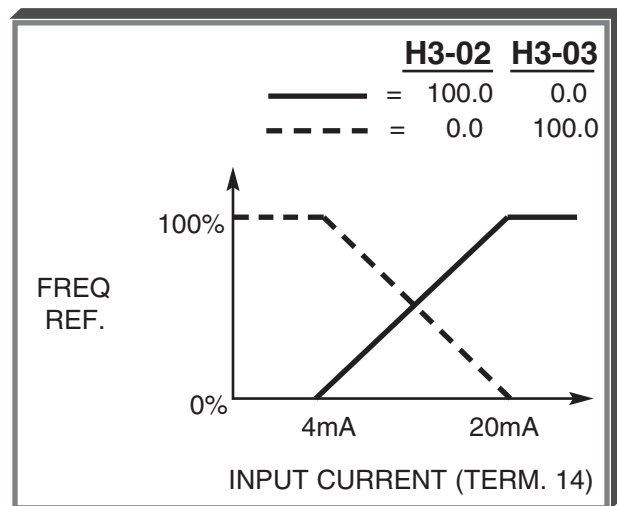
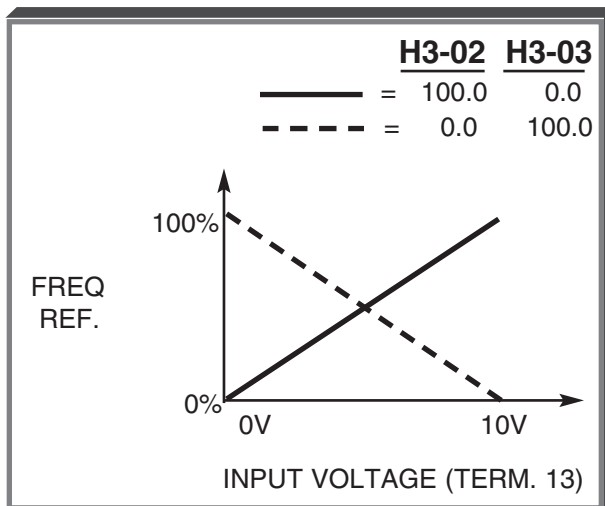
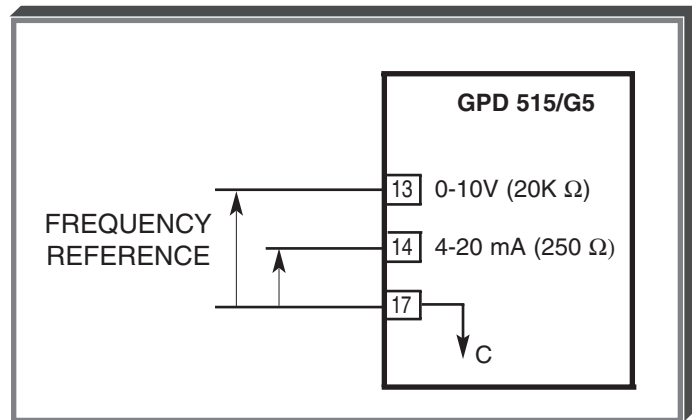

## 5.19 FREQUENCY REFERENCE INPUT SIGNALS (AUTO/MANUAL)

**H3-01** : Auto Speed Reference Signal  
Level Selection (Term. 13)

Factory setting: <b>0</b>
Range: 0 or 1

To change the control circuit terminal 13 input level, program **H3-01** .

Setting	Terminal 13 Input Level
0	0 to 10 V
1	-10 to 10 V

**H3-04** : Multi-function Analog Input 1 Signal  
Level Selection (Term. 16)

Factory setting: <b>0</b>
Range: 0 or 1

To change the control circuit terminal 16 input level, program **H3-04** .

Setting	Terminal 16 Input Level
0	0 to 10 V
1	-10 to 10 V

**H3-08** : Multi-function Analog Input 2 Signal  
Level Selection (Term. 14)

Factory setting: <b>2</b>
Range: 0 to 2

To change the control circuit terminal 14 input level, program **H3-08** .

Setting	Terminal 14 Input Level
0	0 to 10 V
1	-10 to 10 V
2	4 to 20 mA

### IMPORTANT

In addition to setting parameter **H3-08** = 0 or 1 for a voltage input, jumper J1 on the drive's Control PCB must be cut.

Examples of wiring the drive for frequency references from various sources are shown on the next page.

### NOTE

If parameter **H3-09** = 1F terminals 13 and 14 are added and used as the internal frequency reference.

## 5.19 FREQUENCY REFERENCE INPUT SIGNALS (AUTO/MANUAL)

Continued

A. Speed pot or 0-10VDC signal only:

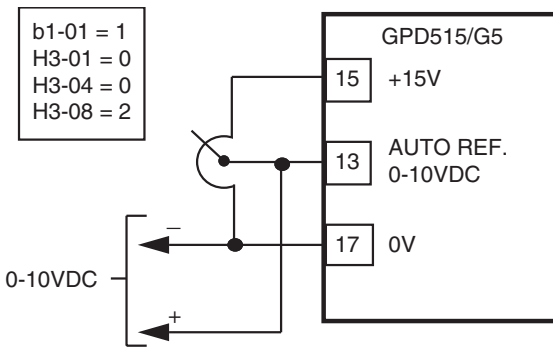

B. 4-20mA signal only:

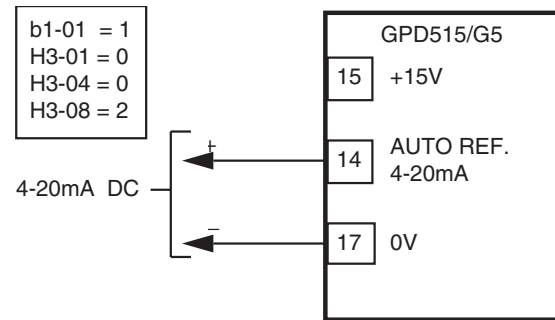

C. 0-10VDC signal (auto) and speed pot (manual):

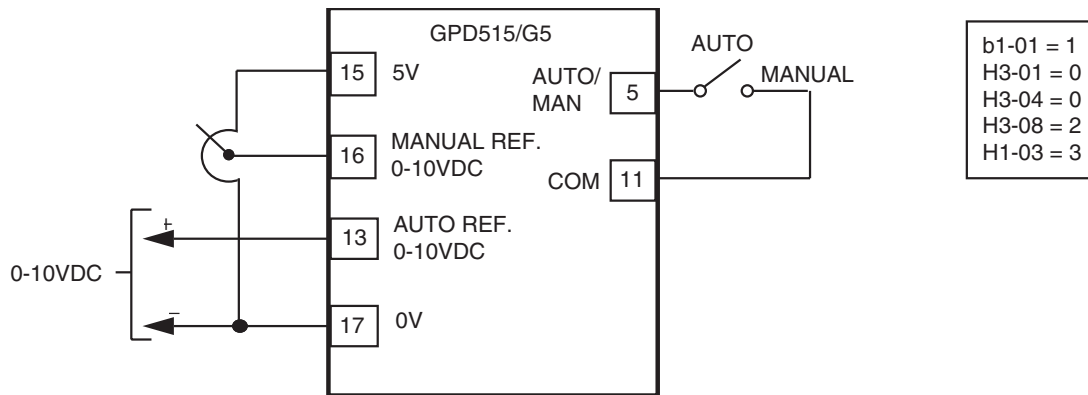

For a bidirectional speed pot, set **H3-04 = 1** and connect the low side to terminal 33 instead of terminal 17.

D. 4-20mA DC signal (auto) and 0-10VDC signal or speed pot (manual):

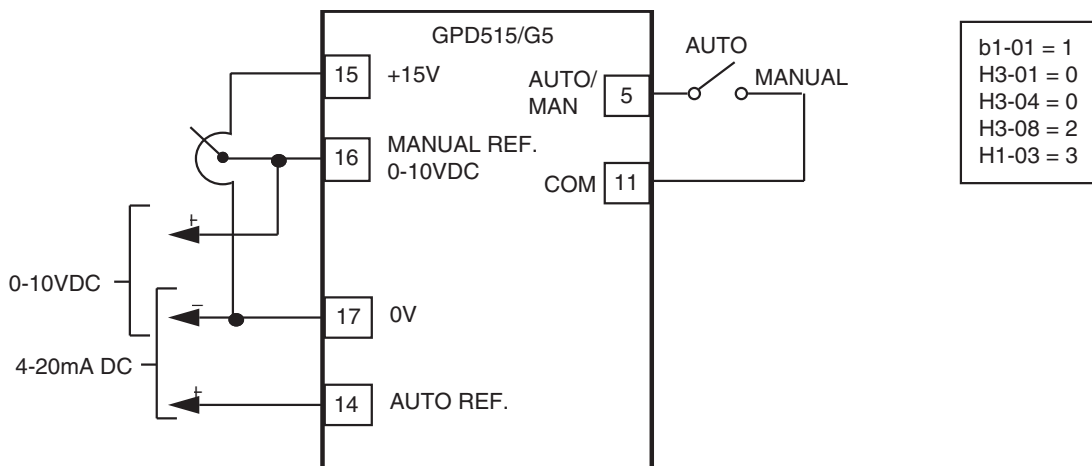

For a -10 to +10V input instead of 0-10V at terminal 13, set **H3-01 = 1**.

## 5.20 FREQUENCY REFERENCE LOSS DETECTION

**L4-05** : Frequency Reference Loss Detection

Factory setting: **0** (disabled)

Range: 0 or 1

The reference loss detection function is either enabled or disabled, based on the setting of **L4-05**. When enabled (data " 1 "), the reference loss detection compares the change in reference with respect to time. If the reference decreases by 90% in more than 0.4 seconds, the drive will decelerate to the set reference; if the reference decreases by 90% in less than 0.4 seconds, the drive will continue to operate at 80% of the output frequency. To regain control of output frequency, either exceed the set reference (80% of reference) or initiate a STOP command. If Auto Reference is less than  $F_{max}$  (**E1-04**) x .05, this function is not performed.

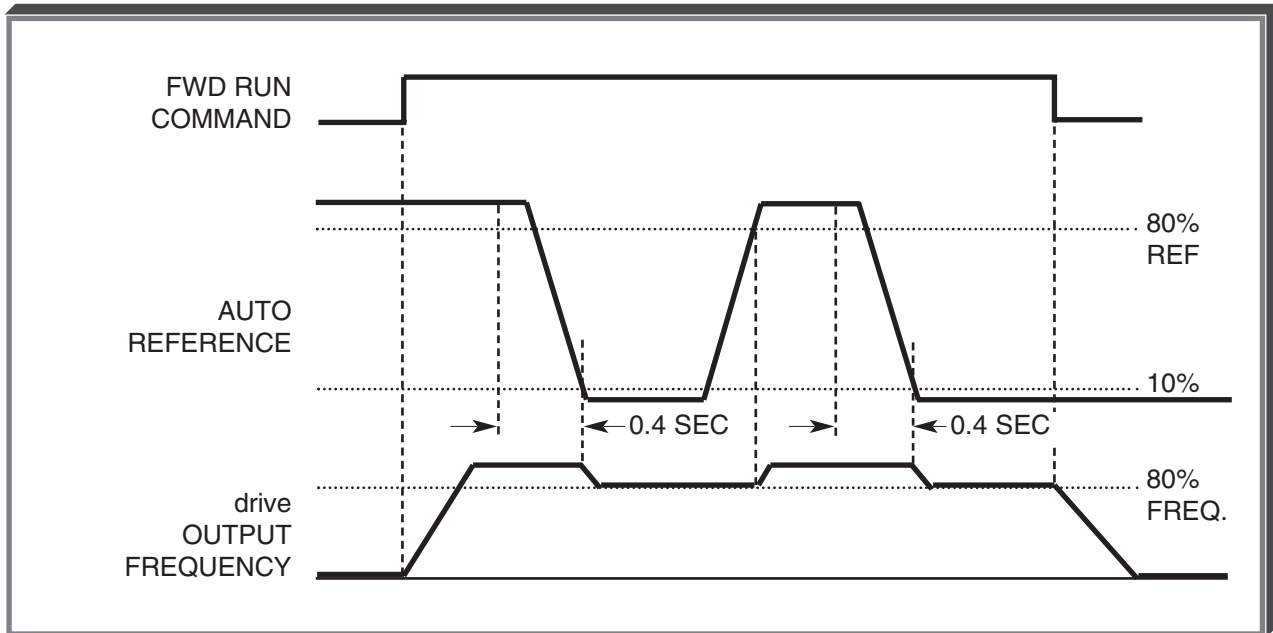

**Timing Chart**

*Note:* This function applies only to frequency references at terminal **13** or **14**. Frequency reference loss detection does not function at terminal **16**.

## 5.21 FREQUENCY REFERENCE RETENTION

**d4-01** : Frequency Reference Retention

Factory setting: **0**

Range: 0 or 1

This parameter can be used to retain the held frequency reference in **U1-01** when power is removed. Set **d4-01** = 1 if this is desired when using Up/Down or Sample/Hold commands as a multi-function contact input.

Setting	Description
0	Not retained
1	Held reference retained in Frequency Reference 1 ( <b>U1-01</b> )



## 5.22 FREQUENCY REFERENCE UPPER & LOWER LIMITS

**d2-01** : Frequency Reference Upper Limit

Factory setting: **100.0**

Range: 0.0 to 110.0 %

**d2-02** : Frequency Reference Lower Limit

Factory setting: **0.0**

Range: 0.0 to 109.0 %

These two parameters set the range for the frequency command signal. Each is set, in increments of 0.1%, as a percentage of maximum frequency (Fmax; **E1-04**) as established by either the selected standard V/f pattern or custom V/f pattern.

NOTE: All references are affected by the upper and lower limit points.

### EXAMPLE:

**E1-04** = " 60 " Hz (100%)

**d2-01** = " 80.0 " % = 48Hz – Max. speed

**d2-02** = " 10.0 " % = 6Hz – Min. speed

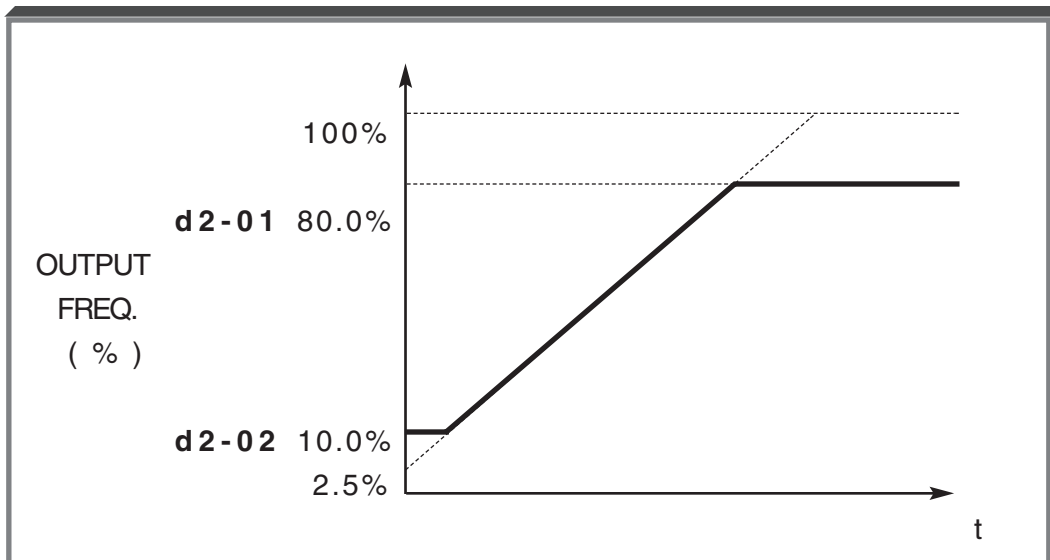

## 5.23 HUNTING PREVENTION

**C7-01** : Hunt Prevent Selection

Factory setting: **1**

Range: 0 or 1

Hunting often occurs following a load change, but may also occur when the motor is in the process of settling to a steady operating frequency. Setting **C7-01** = 1 enables the anti-hunt feature, which will reduce or suppress oscillation.

Setting	Description
0	Disabled
1	Enabled

**C7-02** : Hunt Prevent Gain

Factory setting: **1.00**

Range: 0.00 to 2.50

This parameter adjusts the hunt prevent gain. It should be decreased for a vibrating condition under heavy loads, and increased for hunting under light loads.

### NOTE

This function is only available in the Volts/Hertz Control Method, both with and without PG feedback ( **A1-02** = 0 or 1).

## 5.24 JOG REFERENCE

**d1-09** : Jog Reference

Factory setting: **6.00**

Range: 0.00 to 400.00 Hz

When jog operation is selected (either by the Digital Operator **JOG** key, or by external Jog and Run signals), the drive output will ramp to the output level set by this parameter.

When the Digital Operator is used, Jog can only be initiated from the stopped condition. When the drive is running, the **JOG** key will have no effect on drive output.

When an external Jog signal is present, it will override the existing operation mode and the drive will ramp to the level set by this parameter.

### EXAMPLES:

#### OPERATION FROM DIGITAL OPERATOR

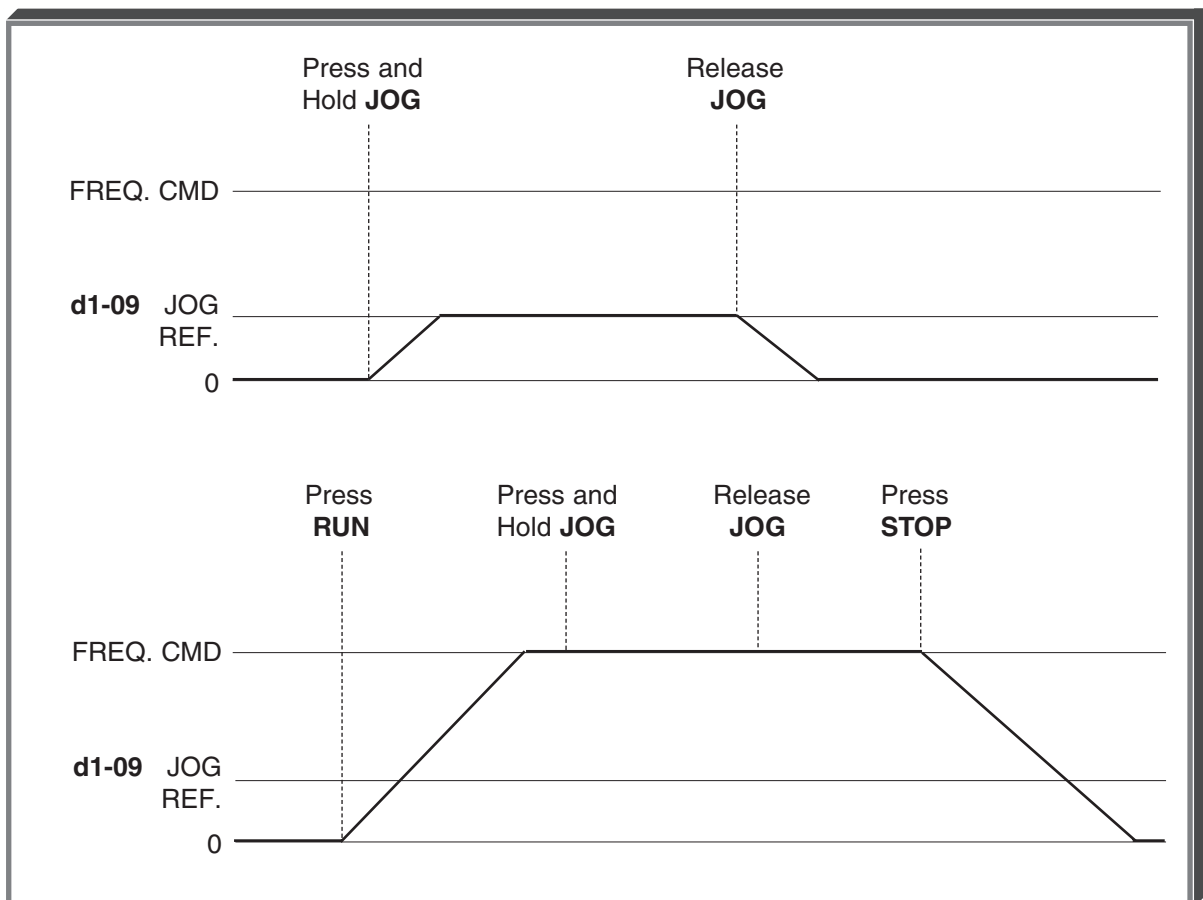

**5.24 JOG REFERENCE** Continued

**EXAMPLES:**

**OPERATION BY REMOTE SIGNAL INPUT (RUN & JOG1)**

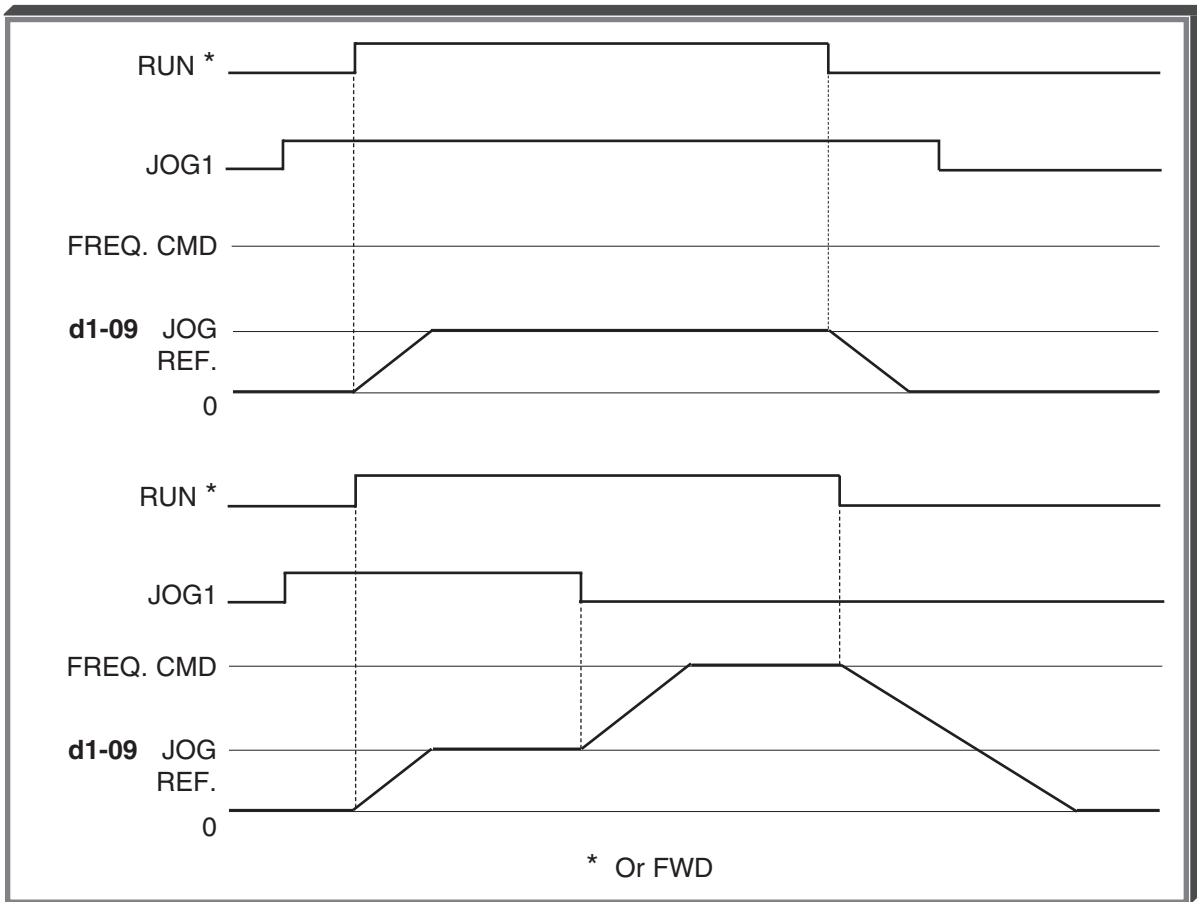

**JOG2 — 2-WIRE CONFIGURATION**

**b 1 - 02 = 1 (Remote Control)**

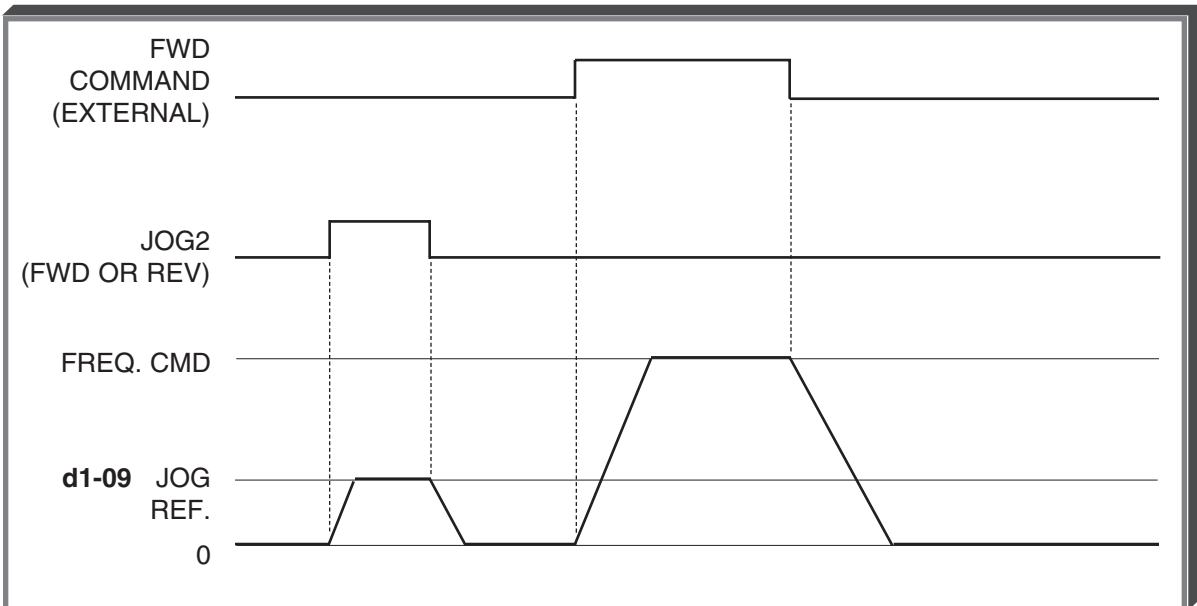

## EXAMPLES:

## JOG2 — 3-WIRE CONFIGURATION

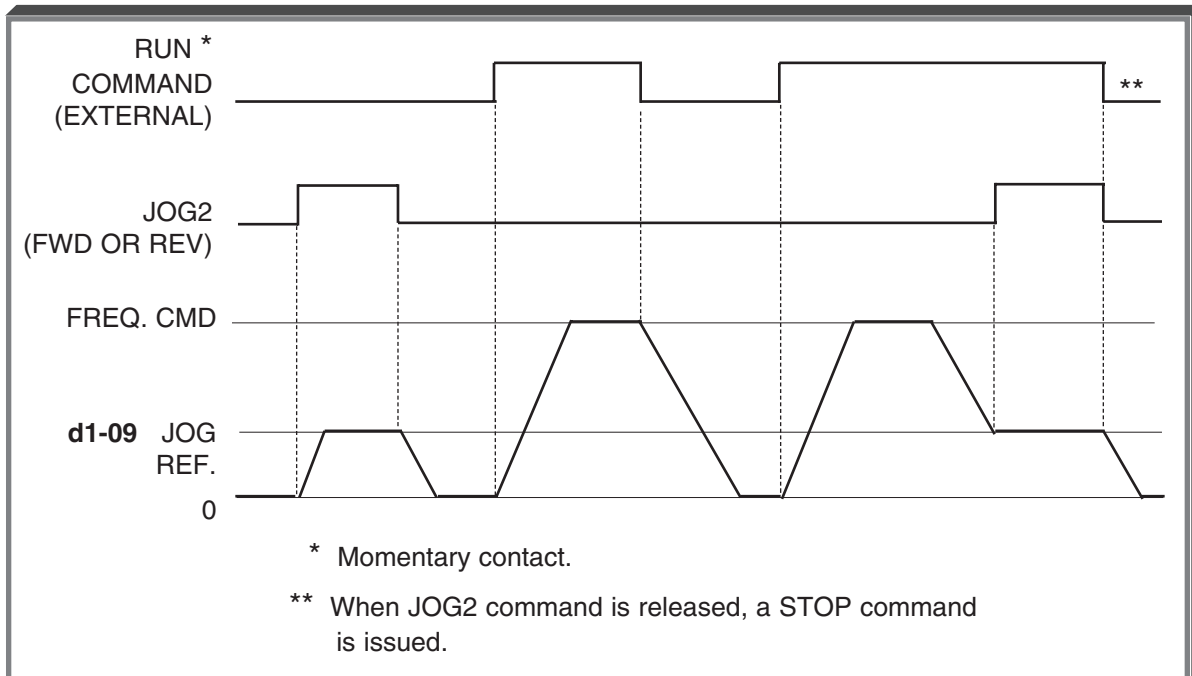
**b1-02 = 1** (Remote Control)

## NOTES:

- Use of external Jog input is selected by setting data " 6 ", " 12 ", or " 13 " in one of the parameters **H1-01** thru **H1-06** .
  - The factory configuration for 2-wire control is **H1-05 = 6**, for JOG1 input at terminal 7.
  - The factory configuration for 3-wire control is **H1-06 = 6**, for JOG1 input at terminal 8.
  - To select JOG2 - FWD, set data " 12 " into one of these parameters. To select JOG2 - REV, set data " 13 " into one of these parameters. JOG2 does not require an active RUN command to allow Jog operation.
- JOG2 (FWD or REV) has priority over FWD and REV Run in the 2-wire control configuration, and priority over RUN, STOP, and FWD/REV commands in 3-wire control configuration.
- JOG2 - FWD and JOG2 - REV can be selected independently.
- b1-04 = 1** (Reverse Run disabled) will override JOG2- REV.

Also see descriptions of **MULTI-FUNCTION INPUT TERMINALS** and **RESET CODES**.

## 5.25 LOCAL/REMOTE AND REFERENCE SELECTION

**d1-01** : Memory 1      **d1-06** : Memory 6  
**d1-02** : Memory 2      **d1-07** : Memory 7  
**d1-03** : Memory 3      **d1-08** : Memory 8  
**d1-04** : Memory 4      **d1-09** : Jog Reference  
**d1-05** : Memory 5      (See paragraph 5.24)

Factory setting:

**d1-01** thru **d1-08** : **0.00**  
**d1-09** : **6.00**

Range (all): 0.00 to 400.00 Hz

**H3-05** : Multi-function Analog Input (Term. 16) (See paragraph 5.30)

**b1-02** : Operation Method Selection

**H1-03** thru **H1-06** : Multi-function Input Terminals; data " 3 ", " 4 ", " 5 ", and " 6 " [ or " C " ], respectively, for Reference Select 1, 2, 3 and Jog [ or Multi-function Analog Input at Term. 16 ] (See paragraph 5.31).

For Local/Remote select, see paragraph 5.31, data " 1 " description.

**b1-01** : Reference Selection (See below, or separate Option Instruction Sheet).

The drive allows selection of one of twelve references. Two are analog inputs, nine are stored in memory, and one can be from an option card, either analog or digital. In most configurations either the local reference ( **d1-01** ) or the remote AUTO reference will be utilized.

### NOTE

The range and resolution of the **d1-XX** parameters is dependent on the setting of **o1-03** (see paragraph 5.11).

## 5.25 A Local/Remote Reference Selection

**b1-01** : Reference Selection

Data: **0** = Local (Digital Operator) frequency reference  
**1** = Remote (terminals) frequency reference

By programming **b1-01** = 1, the external Auto reference input will be used. If **b1-01** is programmed to " 0 ", the value in **d1-01** will be used as a frequency command.

### IMPORTANT

**d1-01** will change each time the operator enters a new frequency command from the Digital Operator's " **U1-01 = XX.XX** " prompt. Another way to think of this is that when the drive is first powered up, the Digital Operator displays " **Frequency Reference U1-01 = XX.XX HZ** ". The value displayed is the current setting of **d1-01** . If the operator changes the display, then **d1-01** will also be changed.

**5.25 B Multiple Speed Reference Configuration [Multi-step Speed Operation]**

In a multiple reference configuration, four modes may be selected.

**NOTE**

In the descriptions of Mode 1 thru Mode 4, the external terminal listings differ depending on whether the drive is set for 2-wire or 3-wire control. For 3-wire control, one of these terminals is dedicated to the FWD/REV selection; therefore, multiple reference operation will use fewer of the memory settings and is a more limited function.

Depending on the control wiring configuration and the multi-step mode chosen, the motor can be operated at up to nine different speeds.

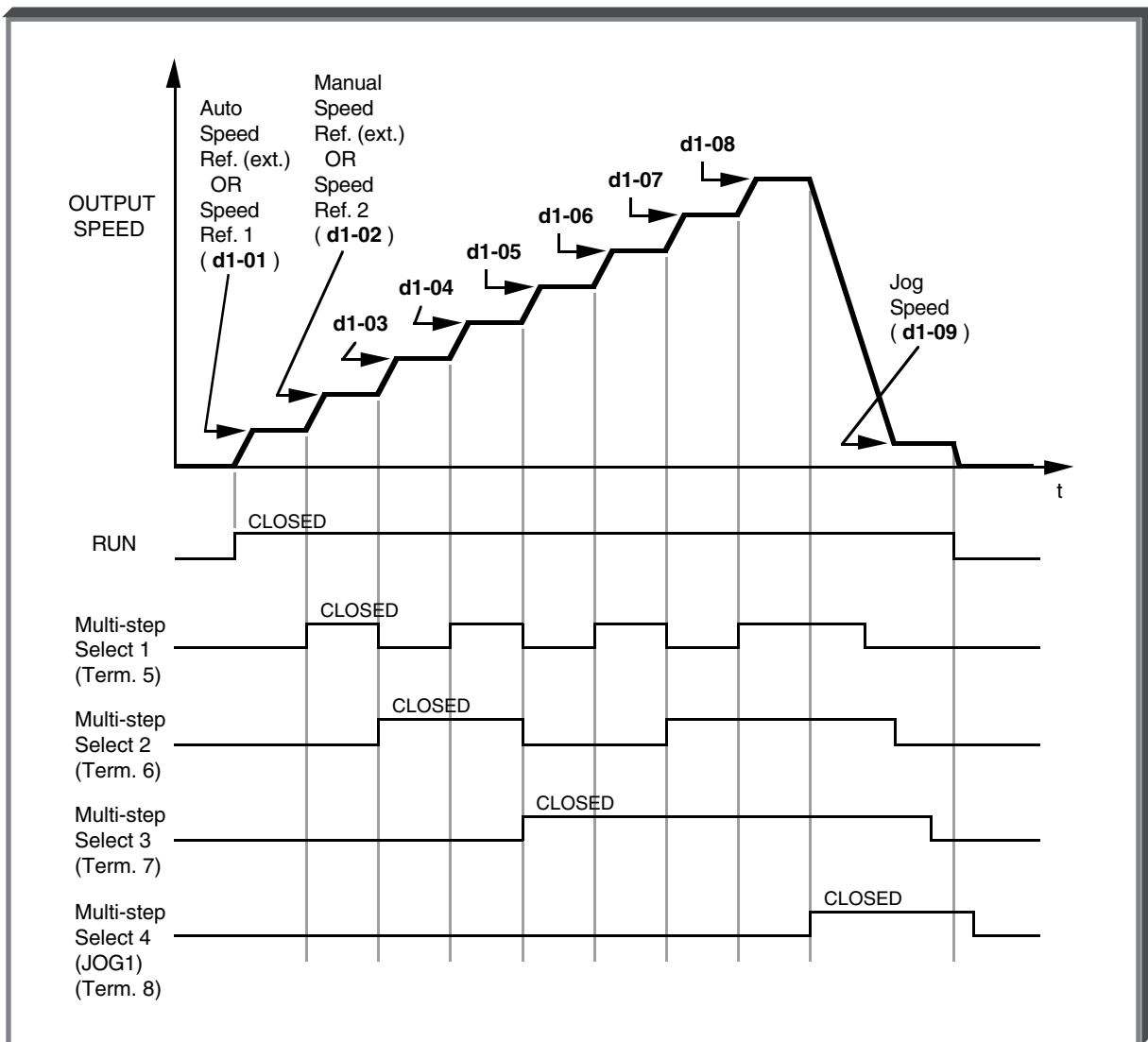

**Typical Multi-step Speed Operation**

## 5.25 LOCAL/REMOTE AND REFERENCE SELECTION

Continued

**Mode 1 (Memory Data Only)** uses only memory locations **d1-01** thru **d1-09**.

The input commands at terminals 3 thru 8 are a combination of 1's and 0's, which are received as an on or off condition at each terminal. Every combination selects a specific speed reference.

- b1-01** = local/remote operation (frequency reference);
- H1-03** = frequency reference select 1 at terminal 5;
- H1-04** = frequency reference select 2 at terminal 6;
- H1-05** = frequency reference select 3 at terminal 7;
- H1-06** = JOG reference select at terminal 8;
- H3-05** = manual reference at terminal 16.

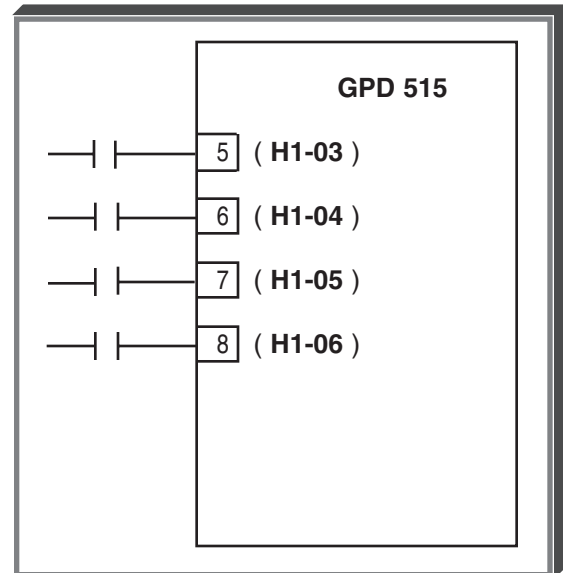

### 2-WIRE CONTROL

- b1-01** = 0
- H1-03** = 3
- H1-04** = 4
- H1-05** = 5
- H1-06** = 6
- H3-05** = \*

### 3-WIRE CONTROL

- b1-01** = 0
- H1-03** = 0
- H1-04** = 3
- H1-05** = 4
- H1-06** = 6
- H3-05** = \*

Freq. Ref.	External Terminal			
	8	7	6	5
d1-01	0	0	0	0
d1-02 *	0	0	0	1
d1-03	0	0	1	0
d1-04	0	0	1	1
d1-05	0	1	0	0
d1-06	0	1	0	1
d1-07	0	1	1	0
d1-08	0	1	1	1
d1-09	1	X	X	X

Freq. Ref.	External Terminal			
	8	7	6	5
d1-01	0	0	0	■
d1-02 *	0	0	1	■
d1-03	0	1	0	■
d1-04	0	1	1	■
d1-09	1	X	X	■

1 = Closed; 0 = Open;  
X = No effect; ■ = FWD/REV

\* **H3-05** selects the function of the multi-function analog input. If data value " 0 " is entered, the analog input represents manual reference. If **d1-02** is to be utilized, then **H3-05** **MUST NOT** be set to " 0 ". Set **H3-05** to " 1F " when Multi-function Analog Input (terminal 16) is not being used.



## 5.25 LOCAL/REMOTE AND REFERENCE SELECTION

Continued

**Mode 2 (Memory, Auto, Manual)** uses Auto, Manual and **d1-03** thru **d1-09**.

The input commands at terminals 3 thru 8 are a combination of 1's and 0's, which are received as an on or off condition at each terminal. Every combination selects a specific speed reference.

- b1-01** = remote operation;
- H1-03** = frequency reference select 1 at terminal 5 (Auto/Manual);
- H1-04** = frequency reference select 2 at terminal 6;
- H1-05** = frequency reference select 3 at terminal 7;
- H1-06** = JOG reference select at terminal 8;
- H3-05** = manual reference at terminal 16.

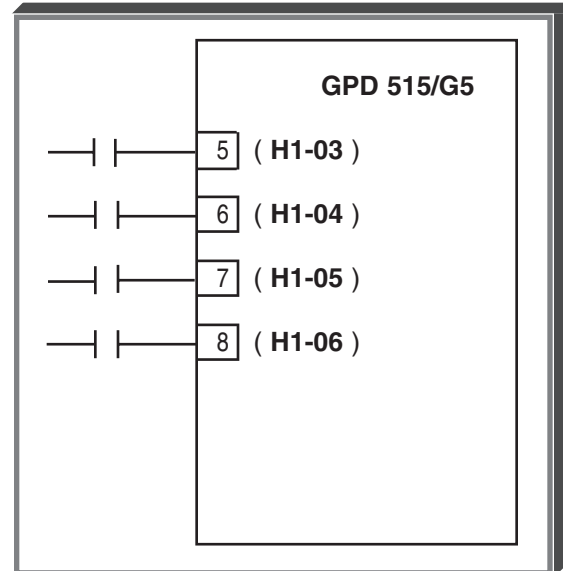

### 2-WIRE CONTROL

- b1-01** = 1
- H1-03** = 3
- H1-04** = 4
- H1-05** = 5
- H1-06** = 6
- H3-05** = 0

### 3-WIRE CONTROL

- b1-01** = 1
- H1-03** = 0
- H1-04** = 3
- H1-05** = 4
- H1-06** = 6
- H3-05** = 0

Freq. Ref.	External Terminal			
	8	7	6	5
Auto	0	0	0	0
Manual (Multi-func.)	0	0	0	1
d1-03	0	0	1	0
d1-04	0	0	1	1
d1-05	0	1	0	0
d1-06	0	1	0	1
d1-07	0	1	1	0
d1-08	0	1	1	1
d1-09	1	X	X	X

Freq. Ref.	External Terminal			
	8	7	6	5
Auto	0	0	0	■
Manual (Multi-func.)	0	0	1	■
d1-03	0	1	0	■
d1-04	0	1	1	■
d1-09	1	X	X	■

1 = Closed; 0 = Open;  
X = No effect; ■ = FWD/REV

## 5.25 LOCAL/REMOTE AND REFERENCE SELECTION

Continued

**Mode 3 ( d1-01, Manual, d1-03 thru d1-09)** uses d1-01, Manual and **d1-03** thru **d1-09** .

The input commands at terminals 3 thru 8 are a combination of 1's and 0's, which are received as an on or off condition at each terminal. Every combination selects a specific speed reference.

- b1-01** = local operation;
- H1-03** = frequency reference select 1 at terminal 5 (Auto/Manual);
- H1-04** = frequency reference select 2 at terminal 6;
- H1-05** = frequency reference select 3 at terminal 7;
- H1-06** = JOG reference select at terminal 8;
- H3-05** = manual reference at terminal 16.

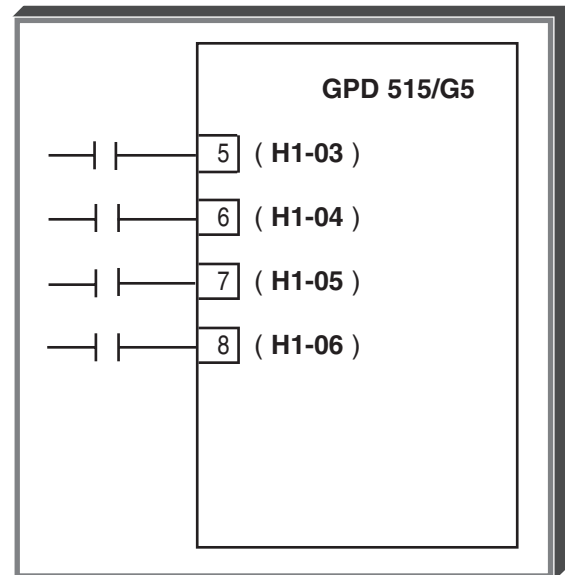

### 2-WIRE CONTROL

- b1-01** = 0
- H1-03** = 3
- H1-04** = 4
- H1-05** = 5
- H1-06** = 6
- H3-05** = 0

### 3-WIRE CONTROL

- b1-01** = 0
- H1-03** = 0
- H1-04** = 3
- H1-05** = 4
- H1-06** = 6
- H3-05** = 0

Freq. Ref.	External Terminal			
	8	7	6	5
d1-01	0	0	0	0
Manual (Multi-func.)	0	0	0	1
d1-03	0	0	1	0
d1-04	0	0	1	1
d1-05	0	1	0	0
d1-06	0	1	0	1
d1-07	0	1	1	0
d1-08	0	1	1	1
d1-09	1	X	X	X

Freq. Ref.	External Terminal			
	8	7	6	5
d1-01	0	0	0	■
Manual (Multi-func.)	0	0	1	■
d1-03	0	1	0	■
d1-04	0	1	1	■
d1-09	1	X	X	■

1 = Closed; 0 = Open;  
X = No effect; ■ = FWD/REV

## 5.25 LOCAL/REMOTE AND REFERENCE SELECTION

Continued

### Mode 4

The final consideration for multiple frequency command configuration modes is that any combination of reference values may be configured for operation. As an example, if only three speed references are required, then the following example will work.

**b1-01** = local operation;  
**H1-03** = frequency select 1 at terminal 5;  
**H1-04** = frequency select 2 at terminal 6;  
**H3-05** = manual reference at terminal 16.

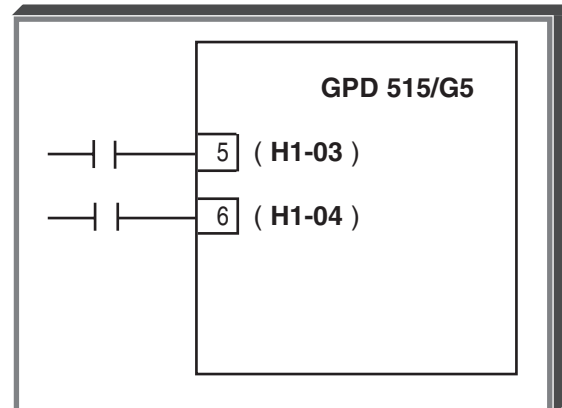

### 2-WIRE CONTROL

**b1-01** = 0  
**H1-03** = 3  
**H1-04** = 5  
**H3-05** = 0

Freq. Ref.	External Terminal			
	8	7	6	5
d1-01	0	0	0	0
Manual (Multi-func.)	0	0	0	1
d1-03	0	0	1	0

## 5.26 MISCELLANEOUS PARAMETERS

**o2-01** : LOCAL/REMOTE Key Selection

Factory setting: 1

Range: 0 or 1

This parameter determines if the LOCAL/REMOTE key is operative.

Setting	Description
0	Disabled
1	Enabled

## 5.26 MISCELLANEOUS PARAMETERS

Continued

### o2-02 : STOP Key Function

Factory setting: **1**

Range: 0 or 1

This parameter determines if the STOP key is operative during remote run.

Setting	Description
0	Disabled
1	Enabled

### o2-05 : Digital "Motor Operated Pot"

Factory setting: **0**

Range: 0 or 1

Setting this parameter to " 1 " allows the setting of the frequency reference to imitate a motor operated pot reference.

Setting	Description
0	Drive accepts frequency command after ENTER is pressed
1	Drive accepts frequency reference immediately

### o2-06 : Operator Detection Selection

Factory setting: **1**

Range: 0 or 1

Setting this parameter to " 0 " allows the drive to continue to run when the Digital Operator is disconnected from the drive.

Setting	Description
0	Disabled (operation continues)
1	Enabled (motor coasts to stop and fault is displayed)

### o2-07 : Elapsed Timer Setting

Factory setting: **0**

Range: 0 or 65535

This parameter allows the user to preset a starting value for the elapsed timer. Elapsed time is accumulated according to the setting of **o2-08**.

**5.26 MISCELLANEOUS PARAMETERS**

Continued

**o2-08** : Elapsed Timer SelectionFactory setting: **0**

Range: 0 or 1

This parameter determines whether the timer is active whenever power is applied to the drive or whenever the drive is in run mode.

Setting	Description
0	Timer active whenever power is applied to the drive
1	Timer active whenever drive is in "run" mode

**b1-08** : Run Command Selection  
During ProgramFactory setting: **0**

Range: 0 or 1

This parameter determines if the drive will accept a run command while in the "program" mode. The drive is in the "program" mode whenever the drive light is off.

Setting	Description
0	Disabled – If a run is commanded while the drive is in the "program" mode (drive light is off), it will not run.
1	Enabled – If a run is commanded while the drive is in the "program" mode (drive light off), it will operate normally.

**5.27 MISCELLANEOUS PROTECTIVE FUNCTIONS****L8-01** : Internal Dynamic Braking (Heatsink)  
Resistor ProtectionFactory setting: **0**

Range: 0 or 1

Set this parameter to " 1 " only if a heatsink-mount resistor will be used with the drive. Set **L8-01** to " 0 " if not using Dynamic Braking, or if using a remote DB resistor.

Setting	Description
0	Not provided
1	Provided

**L8-02** : OH (Overheat) Protection  
Alarm LevelFactory setting: **See Table A3-1**

Range: 50 to 130 °C

This parameter sets the temperature at which the heatsink thermostat will indicate an overtemperature condition. The corresponding action the drive will take is dependent upon the setting of **L8-03** (see below).

**L8-03** : Operation Selection After OH  
(Overheat) Pre-alarmFactory setting: **3**

Range: 0 to 3

Setting	Description
0	Ramp to Stop (using <b>C1-02</b> )
1	Coast to Stop (base block)
2	Fast-stop (using <b>C1-09</b> )
3	Alarm Only (operation continues)

**5.27 MISCELLANEOUS PROTECTIVE FUNCTIONS**

Continued

**L8-10** : Output Ground Fault  
Detection SelectionFactory setting: **1**

Range: 0 or 1

Setting	Description
0	Disabled – The drive will not detect a ground fault condition
1	Enabled – The drive will detect a ground fault condition

**L8-17** : IGBT Protection Selection  
at Low FrequencyFactory setting: **1**

Range: 0 or 3

Setting	Description
0	Drive relies on L8-19 protection.
1	Lower fc – When output current is greater than 100%, and output frequency is less than or equal to 10 Hz, the carrier frequency is automatically decreased to between 8 kHz and 2 kHz depending on the drive size. The carrier will automatically return to the normal value after the load is reduced.
2	Short term OL2 – OL2 occurs in 2 seconds when output frequency is 6 Hz or less and in current limit (approx. 175% of drive rated current).
3	I-Limit=150% – Current is limited to 150% of drive rated current.

Parameter **L8-17** assists in protecting the output transistors (IGBTs) from overheating when the output current is high and the output frequency is low.

**L8-19** : OL2 Selection At Low SpeedFactory setting: **0**

Range: 0 or 1

Setting	Description
0	Disabled – Drive Overload (OL2) protection is the same at low speed as it is at high speed.
1	Enabled – Drive Overload (OL2) protection responds more quickly when output frequency is 6 Hz or less.

This parameter allows the selection of normal or quick Drive Overload (OL2) protection below 6 Hz. It is recommended that this parameter be enabled at all times. In some instances quick drive overload protection (**L8-19=1**) may not be desired, such as when operating in flux vector at zero speed. If **L8-19** is set to 0 (disabled) **L8-17** must be set to 1, 2, or 3.

Caution: When disabling OL2 protection at low speeds (**L8-19=0**), set the carrier frequency (**C6-01** & **C6-02**) equal to or less than 2 kHz.

## 5.28 MODBUS CONTROL

The drive can perform serial communication by using a programmable controller (PLC) and MODBUS™ protocol. MODBUS is composed of one master PLC and 1 to 31 (maximum) slave units (GPD 515/G5). In serial communication between the master and slaves, the master always starts transmission and the slaves respond to it.

The master communicates with one slave at a time. Address numbers are assigned to each slave in advance, and the master specifies an address to communicate with. The slave which receives the command from the master executes the function, and then responds to the master.

### A. Communication Specifications

- Interface : RS-232C (standard); RS-485, RS-422 (option - requires communication interface card CM085)
- Synchronization : Asynchronous
- Transmission parameters : *Baud rate* — Selectable from 1200, 2400, 4800, 9600 BPS ( **H5-02** )  
*Data length* — Fixed to 8 bits  
*Parity* — Parity / no parity, even / odd selectable ( **H5-03** )  
*Stop bit* — Fixed to 1 bit
- Protocol : MODBUS
- Maximum number to units to be connected : 31 units (when RS-485 is used)

### B. Sending/Receiving Data

Data that can be sent and received are run/stop commands, frequency reference, fault reset, drive status, and setting and reading of parameters.

- b1-01** : Reference Selection
- b1-02** : Operation Method Selection

Factory setting (each): <b>1</b>
----------------------------------

Range (each): 0 to 4
----------------------

Select the run command and frequency reference input method in **b1-01** and **b1-02**. To provide a run command and frequency reference by communication, set this data to " 2 ". Monitoring of run status, parameter setting/reading, fault reset and multi-function input command from the PLC are enabled. The multi-function input command is OR'ed with the command input from control circuit terminals 3-8.

**EXAMPLE:** **b1-01** and **b1-02** settings are " 3 ".

- Open : Run by frequency reference from control circuit terminal 13 or 14 and run command from control circuit terminal 1 or 2.
- Closed : Run by frequency reference and run command from serial communication.

**5.28 MODBUS CONTROL**

Continued

**H5-01** : Serial Communication Station AddressFactory setting: **1 F**Range: 1 to 1F (Hex)  
(= 1 to 31 decimal)

Each slave on the same transmission line must be given a unique address.

**H5-02** : Serial Communication Baud RateFactory setting: **3**

Range: 0 to 4

Selects the baud rate, as indicated by the following table:

Setting	Baud Rate (BPS)
0	1200
1	2400
2	4800
3	9600
4	19.2 K

**H5-03** : Serial Communication Parity SelectionFactory setting: **0**

Range: 0 to 2

Selects the parity, as indicated by the following table:

Setting	Parity
0	None
1	Even
2	Odd

NOTE: To change the values set in **H5-01** thru **H5-03** and enable the new settings, it is necessary to turn OFF power to the Drive, then turn it ON again.

**H5-05** : Serial Communication Error ( **CE** )  
DetectionFactory setting: **1**

Range: 0 or 1

This parameter determines whether or not the drive will detect a CE condition. The corresponding action the drive will take is dependent upon the setting of **H5-04** .

Setting	Description
0	Disabled
1	Enabled



**5.28 MODBUS CONTROL**

Continued

**H5-04** : Stopping Method After Serial Communication Error ( **CE** )Factory setting: **3**

Range: 0 to 3

Setting	Description
0	Ramp to Stop (using <b>C1-02</b> )
1	Coast to Stop (base block)
2	Fast-stop (using <b>C1-09</b> )
3	Alarm Only (operation continues)

**5.29 MOMENTARY POWER LOSS RIDE-THRU****L2-01** : Momentary Power Loss Ride-thru Protection**0** = Disabled (Factory setting)**1** = Enabled – 2 sec. power loss ride-thru**2** = Enabled – indefinite power loss ride-thru, provided control power is maintained

The setting of this parameter either enables or disables the ride-thru feature of the drive. If disabled, the unit will stop immediately whenever a power loss occurs. If enabled, the drive will continue to operate during a momentary power loss of up to 80%, but if the loss exceeds the identified time period, the drive will stop.

**L2-02** : Power Loss Ride-Thru Deactivation TimeFactory setting: *See Table A3-1*

Range: 0.0 to 2.0 seconds

If the loss exceeds the length of time identified by **L2-02** , the drive will stop. The factory setting of this parameter, in 0.1 second increments, is related to the drive's capacity rating (see Appendix 3).

Note that the RUN command must be maintained throughout the ride-thru period. If **L2-01** is set to " 2 ", a " **UV** " alarm is displayed during power loss, and no fault signal is output at any multi-function output that is programmed for a fault.

## 5.29 MOMENTARY POWER LOSS RIDE-THRU

Continued

**L2-03** : Momentary Power Loss Minimum  
Base Block Time

Factory setting: *See Table A3-1*

Range: 0.0 to 5.0 seconds

When a power loss is detected, the output is baseblocked for the amount of time set in **L2-03**. During this time, residual voltage in the motor is allowed to diminish. This guards against faults resulting from the drive output turning on while the motor still has residual voltage.

If the minimum baseblock time ( **L2-03** ) is greater than the power loss ride-thru time ( **L2-02** ), drive operation resumes after the minimum baseblock time. If the minimum baseblock time is less than the power loss ride-thru time, drive operation resumes after recovery of input power.

**L2-04** : Momentary Power Loss Recovery  
Ramp Time

Factory setting: **0.3**

Range: 0.0 to 2.0 seconds

After recovery from a momentary power loss, the drive performs a speed search. The ramp recovery time ( **L2-04** ) is the time it takes the output voltage to return to the preset V/f pattern.

**L2-05** : Undervoltage Detection Level

Factory setting: **190** (230V ratings)  
**380** (460V ratings)

Range: 150 to 210 VDC (230V ratings)  
300 to 420 VDC (460V ratings)

The setting of this parameter determines the DC bus undervoltage trip point. When the voltage level on the DC bus drops below this value, a UV (undervoltage) fault will occur.

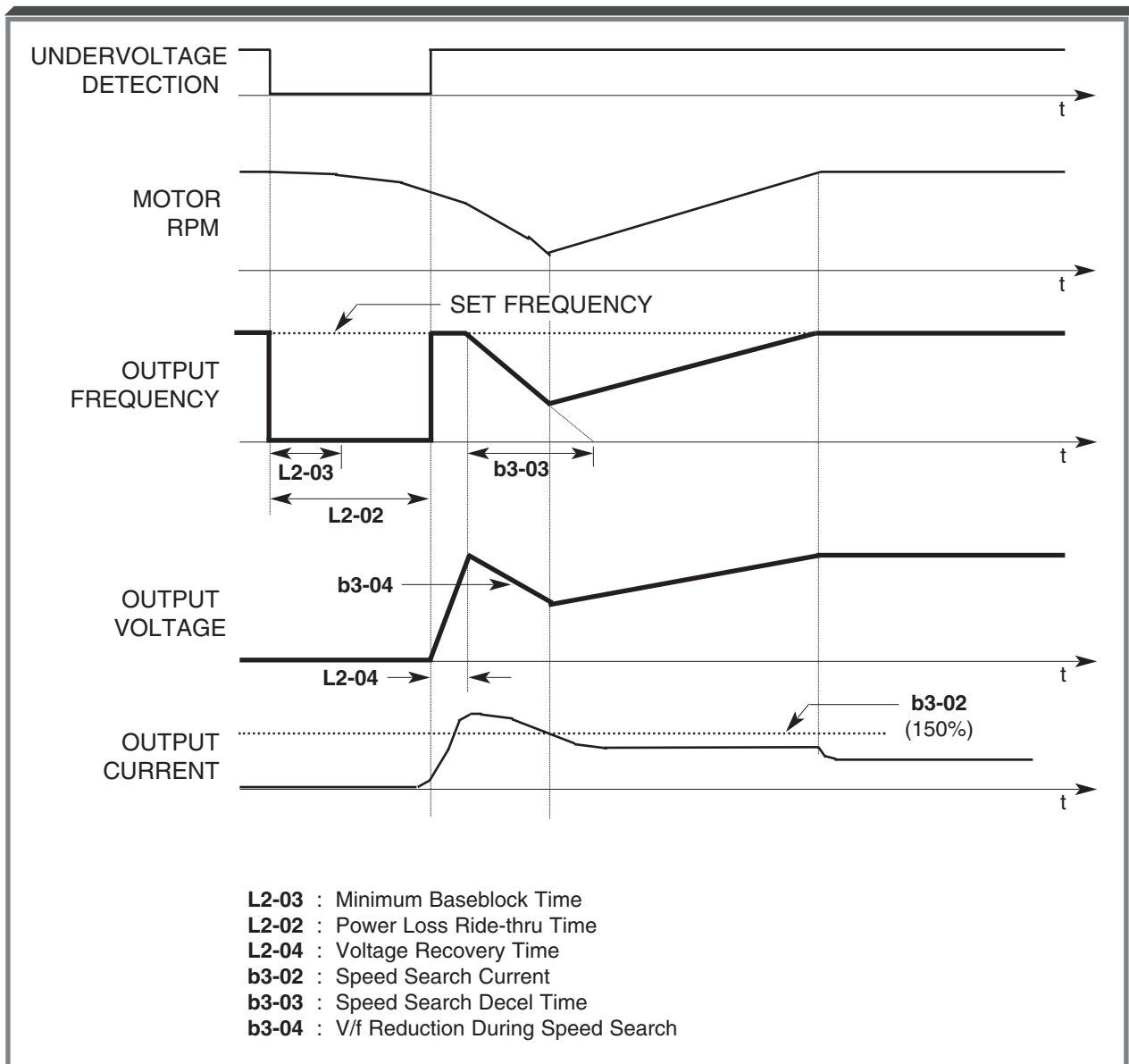

***Momentary Power Loss Ride-thru, With Speed Search***

### 5.30 MULTI-FUNCTION ANALOG INPUTS (Term. 14 & 16)

**H3-05** : Multi-function Analog Input 1 Selection (Term. 16)

**H3-09** : Multi-function Analog Input 2 Selection (Term. 14)

Programming **H3-05** or **H3-09** per the chart below configures terminal 16 or 14 for analog control. The figures following the chart show how each setting configures the analog input.

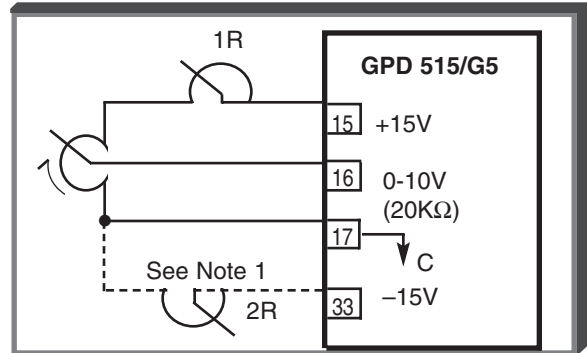

**TABLE 5-1; H3-05 and H3-09 Data Settings**

DATA	FUNCTION	DESCRIPTION	AVAILABILITY (See Note 2)		
			0,1	2	3
0	Manual reference	External reference input	X	X	X
1	Frequency reference gain (FGAIN)	Total gain = Internal gain ( <b>H3-02</b> ) x FGAIN	X	X	X
2	Frequency reference bias (FBIAS)	Total bias = Internal bias ( <b>H3-03</b> ) + FBIAS; FBIAS is based on Fmax ( <b>E1-04</b> )			X X
4	VBIAS	Voltage boost after V/f conversion	X	—	—
5	Accel/decel time coefficient	Accel/decel time varied by analog input	X	X	X
6	DC injection braking current adjust	DC injection braking current varied by analog input (10V/drive rated current); internal setting ( <b>b2-02</b> ) ineffective	X	X	—
7	Overtorque detection level	Internal overtorque detection level ( <b>C6-02</b> ) disabled	X	X	X
8	Stall prevention level during running	Stall prevention level ( <b>L3-06</b> = 100% level) varied by analog input	X	—	—
9	Frequency reference lower limit	Frequency reference lower limit is set by analog input. Either <b>d2-02</b> setting value or analog input, whichever is greater, becomes effective.	X	X	X
A	Setting prohibited frequency 4	Analog input sets a fourth prohibited frequency, in addition to those set by <b>d3-01</b> thru <b>d3-03</b>	X	X	X
B	PID feedback	Provides feedback signal for use with PID control ( <b>b5-01</b> )	X	X	X
C	PID Set Point	Provides a setpoint signal for use with PID control. (Frequency reference no longer acts as PID setpoint.)	X	X	X
D	Frequency Reference Bias 2 (FBIAS2)	Additional frequency reference bias input. Total bias = Internal bias ( <b>H3-03</b> ) + FBIAS + FBIAS2. FBIAS2 is based on Fmax ( <b>E1-04</b> ).			X X
E - F	Not Used		—	—	—
10	FWD torque limit	10V = 100% of motor rated torque (forward direction) Quadrant 1 (See Note 3)	—	X	X
11	REV torque limit	10V = 100% of motor rated torque (reverse direction) Quadrant 3 (See Note 3)	—	X	X
12	Regenerative torque limit (TLG)	10V = 100% of motor rated torque (forward & reverse regeneration) Quadrants 2 & 4 (See Note 3)	—	X	X

### 5.30 MULTI-FUNCTION ANALOG INPUTS (Term. 14 & 16)

Continued

DATA	FUNCTION	DESCRIPTION	AVAILABILITY (See Note 2)		
			0,1	2	3
13	Torque reference (in Torque Control); Torque limit (in Speed Control)	10V = 100% of motor rated torque (forward & reverse) Quadrants 1, 2, 3, & 4 (See Note 3)	—	—	X
14	Torque compensation	See paragraph 5.43.	—	—	X
15	Torque limit		—	X	X
1F	"Not Used"	When programmed in H3-05, terminal 16 input has no effect. When programmed in H3-09, terminal 14 input is added to the terminal 13 frequency reference.	X	X	X

NOTES:

- For a bidirectional pot input instead of 0-10V, set **H3-04** = 1 (for terminal 16) or **H3-08** = 1 (for terminal 14), and connect the low (negative) side of the pot to terminal 33. If using a -10 to +10V input, connect the positive side to terminal 16 or 14, and the negative side to terminal 17.
- Column headings refer to set value of **A1-02**, Control Method; 0 = V/f, 1 = V/f w/PG, 2 = Open Loop Vector, 3 = Flux Vector. "X" in column indicates Available, "—" indicates Not Available.
- Quadrant 1 is forward motor rotation, torque in forward direction;  
Quadrant 2 is forward motor rotation, torque in reverse direction (regeneration);  
Quadrant 3 is reverse motor rotation, torque in reverse direction;  
Quadrant 4 is reverse motor rotation, torque in forward direction (regeneration).

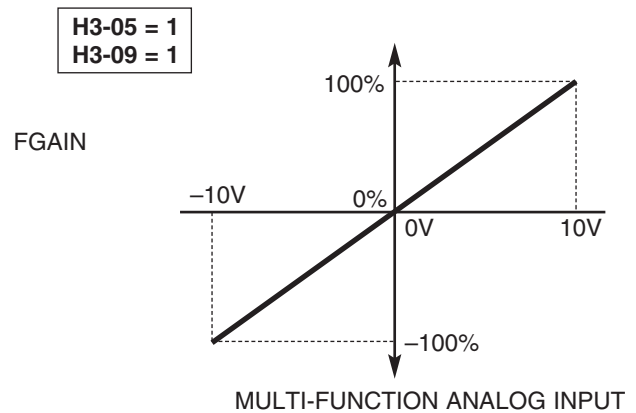
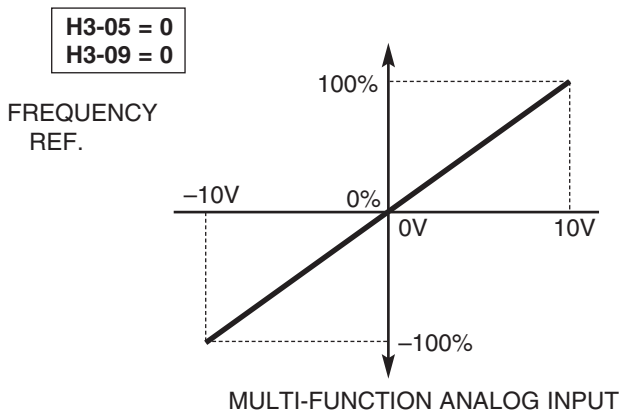

**5.30 MULTI-FUNCTION ANALOG INPUTS (Term. 14 & 16)**

Continued

H3-05 = 2 or C  
H3-09 = 2 or C

FBIAS &  
FBIAS2

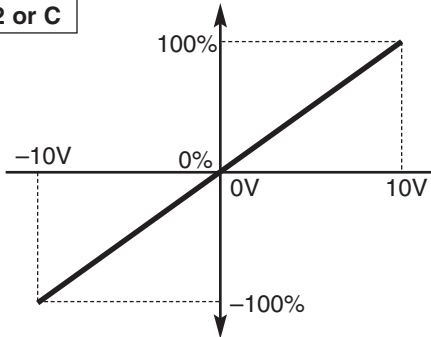

MULTI-FUNCTION ANALOG INPUT

H3-05 = 4  
H3-09 = 4

VBIAS

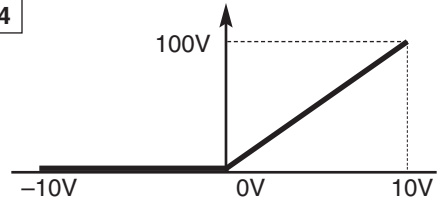

MULTI-FUNCTION ANALOG INPUT

H3-05 = 5  
H3-09 = 5

REDUCTION  
COEFFI-  
CIENT

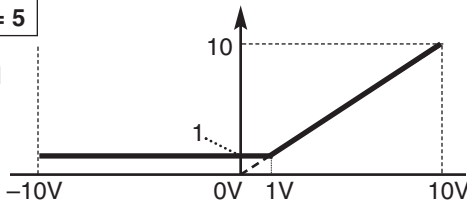

MULTI-FUNCTION ANALOG INPUT

$$\text{Actual accel or decel time} = \frac{\text{Accel or decel time}}{\text{Coefficient}}$$

H3-05 = 6  
H3-09 = 6

DC INJECTION  
BRAKING  
CURRENT

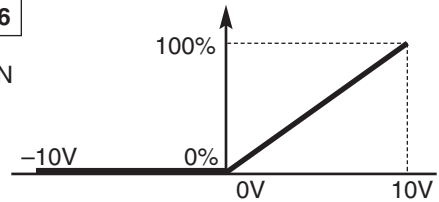

MULTI-FUNCTION ANALOG INPUT

H3-05 = 7  
H3-09 = 7

OVERTORQUE  
DETECTION  
LEVEL

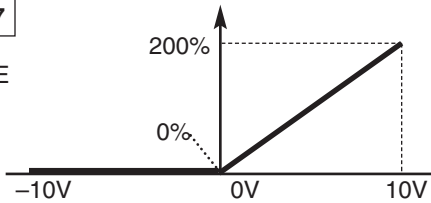

MULTI-FUNCTION ANALOG INPUT

H3-05 = 8  
H3-09 = 8

STALL  
PREVENTION  
LEVEL DURING  
RUNNING  
(PERCENT  
OF L3-06  
10V  
SETTING)

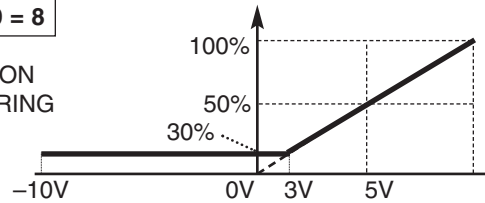

MULTI-FUNCTION ANALOG INPUT

H3-05 = 9  
H3-09 = 9

FREQUENCY  
REFERENCE  
LOWER LIMIT

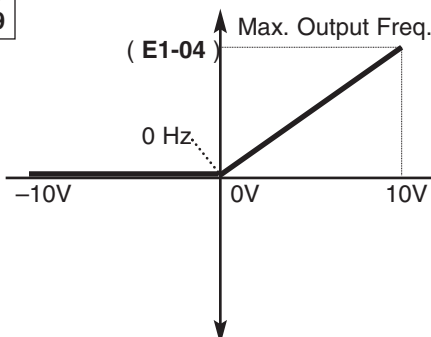

MULTI-FUNCTION ANALOG INPUT

H3-05 = A  
H3-09 = A

SETTING  
PROHIBITED  
FREQUENCY 4

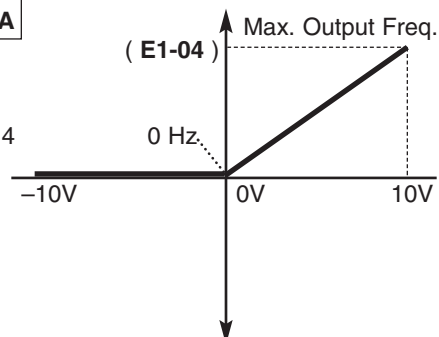

MULTI-FUNCTION ANALOG INPUT

### 5.30 MULTI-FUNCTION ANALOG INPUTS (Term. 14 & 16)

Continued

H3-05 = 10  
H3-09 = 10

FWD  
TORQUE  
LIMIT

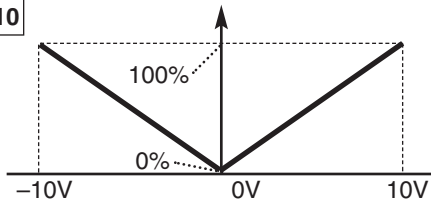

MULTI-FUNCTION ANALOG INPUT

H3-05 = 11  
H3-09 = 11

REV  
TORQUE  
LIMIT

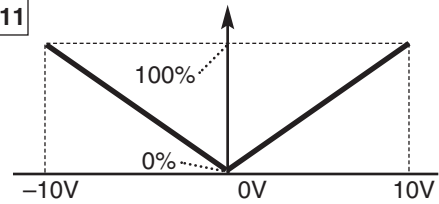

MULTI-FUNCTION ANALOG INPUT

H3-05 = 12  
H3-09 = 12

REGEN  
TORQUE  
LIMIT

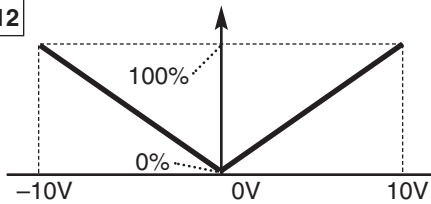

MULTI-FUNCTION ANALOG INPUT

H3-05 = 13  
H3-09 = 13

TORQUE  
REFERENCE

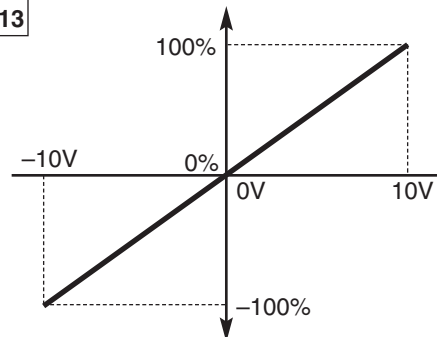

MULTI-FUNCTION ANALOG INPUT

H3-05 = 14  
H3-09 = 14

TORQUE  
COMPEN-  
SATION

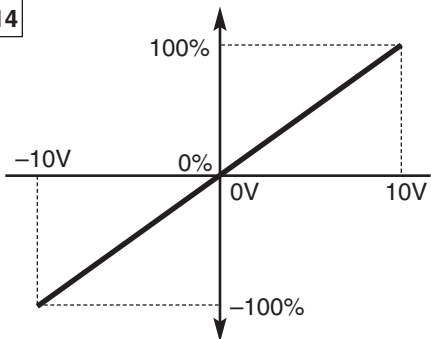

MULTI-FUNCTION ANALOG INPUT

H3-05 = 15  
H3-09 = 15

TORQUE  
LIMIT

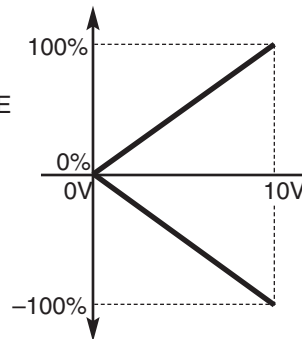

MULTI-FUNCTION ANALOG INPUT

#### H3-12 : Analog Input Filter Time Constant

Factory setting: **0.00**

Range: 0.00 to 2.00 seconds

This parameter adjusts the time it takes to process the analog input signal. The signal that comes into the drive on terminals 13, 14 and 16 goes through an analog to digital converter, and then to the control circuit. This filter time constant determines the time between converting and processing.

For cases when there is noise on the analog signal, this time constant may be increased. Extending the processing time can help prevent erratic performance of the drive.

### 5.31 MULTI-FUNCTION ANALOG MONITOR OUTPUT (Term. 21-23)

**H4-01** : Multi-function Analog Monitor  
Output 1 Selection

Factory setting: <b>2</b>
---------------------------

Range: 1 to 38
----------------

**H4-04** : Multi-function Analog Monitor  
Output 2 Selection

Factory setting: <b>3</b>
---------------------------

Range: 1 to 38
----------------

The analog monitor outputs provides a 0 to  $\pm 10$  Vdc signal between terminals 21 & 22 (or 23 & 22), proportional to the value of the **U1-XX** parameter identified by the setting of **H4-01** (or **H4-04**). (See Appendix 1 for listing of **U1-XX** parameters.)

Factory setting, monitor output 1 =  
**H4-01=2 (U1-02)** : Output Frequency  
(10V = Fmax)

Factory setting, monitor output 2 =  
**H4-04=3 (U1-03)** : Drive output current  
(5V = continuous rated current)

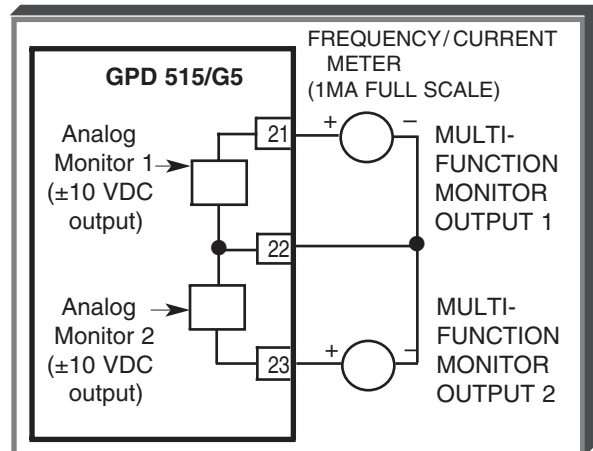

#### NOTE

This output is suitable for metering, but SHOULD NOT be used for external control circuits. To produce an output signal for use by external control circuits, an Analog Monitor option card (AO-08 or AO-12) must be installed in the drive.

**H4-02** : Multi-function Analog Monitor 1 Gain

Factory Setting : <b>1.00</b>
-------------------------------

**H4-05** : Multi-function Analog Monitor 2 Gain

Factory Setting : <b>0.50</b>
-------------------------------

Range (each): 0.00 to 2.50
----------------------------

The settings of these parameters, in increments of 0.01, are used to calibrate the output at terminals 21 & 22 or 23 & 22.

**H4-03** : Multi-function Analog Monitor 1 Bias

Factory Setting (each): <b>0.0 %</b>
--------------------------------------

**H4-06** : Multi-function Analog Monitor 2 Bias

Range (each): -10.0 to +10.0 %
--------------------------------

The settings of these parameters, in increments of 0.1 %, are used to calibrate the output at terminals 21 & 22 or 23 & 22.

**H4-07** : Multi-function Analog Monitor Signal  
Level Selection

Factory Setting: <b>0</b>
---------------------------

Range: 0 or 1
---------------

This function allows the analog monitor output(s) to have a unipolar output signal (0-10V), or a bipolar output signal (0 to  $\pm 10$ V).

0 : Analog output is + voltage only (absolute value).

1 : Analog output is  $\pm$  voltage according to sign (direction).



## 5.32 MULTI-FUNCTION INPUT TERMINALS (Term. 3-8)

**H1-01** : Terminal 3 Function  
**H1-02** : Terminal 4 Function  
**H1-03** : Terminal 5 Function  
**H1-04** : Terminal 6 Function  
**H1-05** : Terminal 7 Function  
**H1-06** : Terminal 8 Function

Factory settings:	2-Wire control	3-Wire control
<b>H1-01</b>	<b>24</b>	<b>24</b>
<b>H1-02</b>	<b>14</b>	<b>14</b>
<b>H1-03</b>	<b>3</b>	<b>0</b>
<b>H1-04</b>	<b>4</b>	<b>3</b>
<b>H1-05</b>	<b>6</b>	<b>4</b>
<b>H1-06</b>	<b>8</b>	<b>6</b>

These six parameters select the input signal functions for terminals 3 thru 8, and can be independently set.

Parameter settings are checked whenever power is applied to the drive, or upon exiting Program mode. A parameter set value failure ( **oPE3** ) will occur if any of the following conditions are detected among these six parameters:

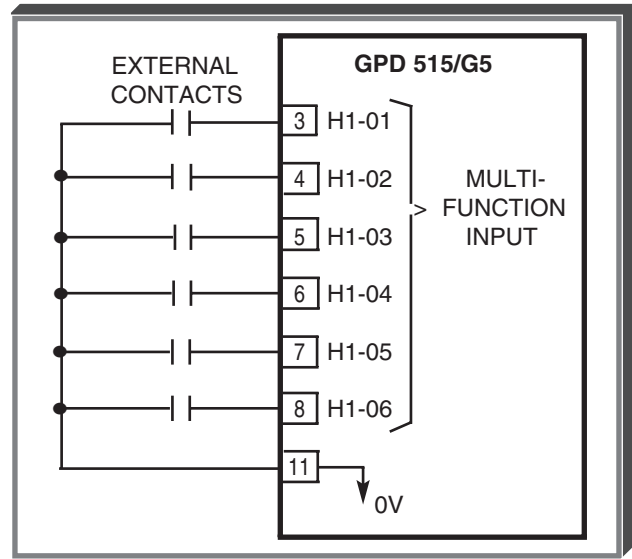

- (1) Two or more of the parameters contain the same value (except for External Fault, data " 2X ").
- (2) Two or three Speed Search functions (data " 61 ", " 62 ", or " 64 ") have been selected.
- (3) Any Speed Search function (data " 61 ", " 62 ", or " 64 ") has been entered into any parameter other than **H1-06** .
- (4) Both the Sample/Hold (data " A ") and Up/Down (data " 10 " & " 11 ") functions have been selected.
- (5) The Up function (data " 10 ") and the Down function (data " 11 ") have not both been selected.
- (6) The Trim Control Increase (Data "1C") AND Trim Control Decrease (Data "1D") Functions have not both been selected.

Table 5-2 lists the possible data setting values for these parameters, with the function and a brief description for each one.

For a few of the data settings, a more detailed description is given on the following pages; for others, the description is given in other PROGRAMMABLE FEATURES paragraphs.

**5.32 MULTI-FUNCTION INPUT TERMINALS (Term. 3-8)**

Continued

**Table 5-2. H1-01 thru H1-06 Data Settings**

DATA	FUNCTION	DESCRIPTION	AVAILABILITY (See Note 1)			
			0	1	2	3
<b>0</b>	Forward/Reverse selection for 3-wire control	Redefines terminals to: 1 = Run; 2 = Stop; corresponding terminal (3-8) = FWD/REV select	X	X	X	X
<b>1</b>	Local/Remote selection	Open = Operates according to setting of <b>b1-01</b> and <b>b1-02</b> Closed = Operates from keys of the Digital Operator <b>See Data description following this table</b>	X	X	X	X
<b>2</b>	Option / drive reference selection	Open = Operates from Digital Operator and or external terminals Closed = Operates from installed option	X	X	X	X
<b>3</b>	Multi-step reference select 1	<b>See paragraph 5.25 B</b>	X	X	X	X
<b>4</b>	Multi-step reference select 2		X	X	X	X
<b>5</b>	Multi-step reference select 3		X	X	X	X
<b>6</b>	Jog frequency reference	Closed = Jog selected <b>See paragraph 5.24 &amp; 5.25 B</b>	X	X	X	X
<b>7</b>	Accel/decel time selection 1	Open = Accel/decel by <b>C1-01 / C1-02</b> Closed = Accel/decel by <b>C1-03 / C1-04</b> <b>See paragraph 5.2 B</b>	X	X	X	X
<b>8</b>	External base block (N.O. contact input)	Closed = Shuts off drive output (speed reference is held) <b>See Data description following this table</b>	X	X	X	X
<b>9</b>	External base block (N.C. contact input)	Open = Shuts off drive output (speed reference is held) <b>See Data description following this table</b>	X	X	X	X
<b>A</b>	Accel/decel ramp hold (speed hold command)	Closed = Hold <b>See paragraph 5.2 B</b>	X	X	X	X
<b>B</b>	External overheat alarm signal	Closed = "oH2" blinks on the Digital Operator, and operation continues (minor fault)	X	X	X	X
<b>C</b>	Multi-function analog input selection	Open = Analog inputs (terms. 14 & 16) are disabled Closed = Analog inputs (terms. 14 & 16) are enabled	X	X	X	X
<b>D</b>	Speed control disable	Open = Speed control enabled Closed = Speed control disabled	—	X	—	X
<b>E</b>	ASR integral reset (IRST)	Closed = Integral reset <b>See paragraph 5.7 C</b>	—	X	—	X
<b>F</b>	Terminal Not Used	Drive does not react to input	X	X	X	X

**5.32 MULTI-FUNCTION INPUT TERMINALS (Term. 3-8)**

Continued

**Table 5-2. H1-01 thru H1-06 Data Settings - Continued**

DATA	FUNCTION	DESCRIPTION	AVAILABILITY (See Note 1)			
			0	1	2	3
<b>10</b>	Up function	<b>See Data description following this table</b>	X	X	X	X
<b>11</b>	Down function		X	X	X	X
<b>12</b>	Forward jog (Jog2)	<b>See paragraph 5.24</b>	X	X	X	X
<b>13</b>	Reverse jog (Jog2)		X	X	X	X
<b>14</b>	Fault Reset	Resets a fault, only if RUN command is not present	X	X	X	X
<b>15</b>	Fast-Stop (N.O.)	Open = No Effect Closed = Ramp to stop by Fast-Stop Decel Time ( <b>C1-09</b> )	X	X	X	X
<b>16</b>	Motor 2 Select	Switches between two different sets of motor parameters Open = Use parameter <b>A1-02</b> , <b>E1</b> Parameter & <b>E2</b> Parameters. Closed = Use parameter <b>E3-01</b> , <b>E4</b> Parameters & <b>E5</b> Parameters.	X	X	X	X
<b>17</b>	Fast Stop (N.C.)	Closed = No Effect Open = Ramp to stop by Fast-Stop Decel Time ( <b>C1-09</b> )	X	X	X	X
<b>18</b>	Timer function (ON or OFF delay)	<b>See Data description following this table</b>	X	X	X	X
<b>19</b>	PID control disable	Closed = PID control is disabled – setpoint becomes frequency reference	X	X	X	X
<b>1A</b>	Accel/decel time selection 2	Open = Accel/decel by <b>C1-01</b> thru <b>C1-04</b> Closed = Accel/decel by <b>C1-05</b> thru <b>C1-08</b> <b>See paragraph 5.2 B</b>	X	X	X	X
<b>1B</b>	Program lockout	Open = Programming from Digital Operator is disabled Closed = Programming from Digital Operator is enabled	X	X	X	X
<b>1C</b>	Trim control increase	Closed = Increase analog frequency reference by <b>d4-02</b> value <b>See Data description following this table</b>	X	X	X	X
<b>1D</b>	Trim control decrease	Closed = Decrease analog frequency reference by <b>d4-02</b> value <b>See Data description following this table</b>	X	X	X	X
<b>1E</b>	Analog reference sample/hold	Open = Hold frequency reference Closed = Sample frequency reference <b>See Data description following this table</b>	X	X	X	X
<b>1F</b>	Frequency reference selection	Open = Freq. ref. from term. 13 Closed = Freq. ref. from term. 14	X	X	X	X

**5.32 MULTI-FUNCTION INPUT TERMINALS (Term. 3-8)** Continued

**Table 5-2. H1-01 thru H1-06 Data Settings - Continued**

DATA	FUNCTION	DESCRIPTION	AVAILABILITY (See Note 1)			
			0	1	2	3
20 thru 2F	External fault	Second digit of setting is a hexadecimal value which defines what type of external contact is used and how the drive will react when the signal input is active. <b>See paragraph 5.17</b>	X	X	X	X
30	PID integral reset	Closed = Set calculated integral time value to 0. <b>See paragraph 5.36F</b>	X	X	X	X
31	PID Integral Hold	Closed = Hold integrator at its present level (PID Control). <b>See paragraph 5.36F</b>	X	X	X	X
60	DC injection braking command	Closed = DC injection braking active <b>See paragraph 5.10 D</b>	X	X	X	X
61	Speed Search 1	Closed * = Speed Search operation from maximum frequency <b>See Data description following this table</b>	X	—	X	—
62	Speed Search 2	Closed * = Speed Search operation from set frequency <b>See Data description following this table</b>	X	—	X	—
63	Energy saving operation	Closed = Energy saving <b>See paragraph 5.16</b>	X	X	—	—
64	Speed Search 3	Closed * = Speed Search operation from output frequency <b>See Data description following this table</b>	X	—	X	—
65	Kinetic energy braking ride-thru NC	Closed = KEB ride-thru is disabled	X	X	X	X
66	Kinetic energy braking ride-thru NO	Closed = KEB ride-thru is enabled	X	X	X	X
71	Speed / torque control selection	Open = Speed control operation Closed = Torque control operation <b>See paragraph 5.43</b>	—	—	—	X
72	Zero-Servo command	Open = Zero-Servo OFF Closed = Zero-Servo ON <b>See paragraph 5.49 A</b>	—	—	—	X
77	ASR gain selection	Closed = ASR proportional gain is set according to <b>C5-03</b>	—	—	—	X

## NOTES:

- \* All contact closures must be maintained, except for speed search (Data " 61 ", " 62", & ' 64 "), which may be momentary (see paragraph 5.32 D).
- 1. Column headings refer to set value of **A 1 - 02**, Control Method; 0 = V/f, 1 = V/f w/PG, 2 = Open loop vector, 3 = Flux vector.

**5.32 MULTI-FUNCTION INPUT TERMINALS (Term. 3-8)**

Continued

**A. Data 1: Local/Remote**

Set **b1-01** and **b1-02** to data " 1 " to select external inputs as the source for frequency reference and operation commands. The use of a Local/Remote command input allows switching between Digital Operator control and the external terminal input signals, without the need to re-program **b1-01** and **b1-02** . If the status of the Local/Remote command input is changed while the drive is running, the Local/Remote operation selection is not completed until the next time the drive is stopped.

Closed = Controlled locally (Digital Operator)

Open = Controlled according to the setting of **b1-01** and **b1-02**

**NOTE**

If manual speed is selected

- by the external Auto/Manual switch (3SS [2-wire] or 2SS [3-wire]),
- by jumper from terminal 5 to 11 (2-wire control),
- or - by jumper from terminal 6 to 11 (3-wire control),

the drive speed reference will be controlled by manual speed reference regardless of the state of the Local/Remote input.

**b1-07: Local / Remote Run Selection**

Factory Setting: <b>0</b>
---------------------------

Range: 0 to 1
---------------

<b>Setting</b>	<b>Description</b>
0	Cycle External Run
1	Accept External Run

When switching from local (digital operator) back into remote (terminals) and a remote run command is present, parameter **b1-07** determines how the drive will react. With a setting of "1", the drive will start running as soon as remote mode is selected. A setting of " 0 " will require the run command to be removed and re-applied *after* the remote mode is selected.

**B. Data 8 : External Base Block by N.O. Contact**

- When either the Forward Run command or Reverse Run command is present, and the external Base Block command is applied (i.e. contact closed), coast stop is accomplished (after a 20 msec delay), while the frequency command is maintained. When the Base Block command is removed, the drive will recover in a manner similar to that of Speed Search operation, except that it searches up from 0 Hz, and supersedes a Speed Search command.

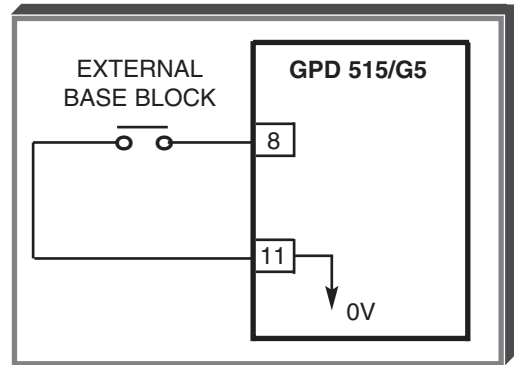

- When both the Forward Run command and Reverse Run command are open, and the external Base Block command is applied (i.e. contact closed), coast stop is accomplished and after a 20 msec delay the frequency command is changed to 0Hz. When the Base Block command is removed, the drive will remain in stopped condition until Forward Run command or Reverse Run command is again applied.
- When external Base Block command is active, a blinking " **BB** " will be displayed on the Digital Operator.

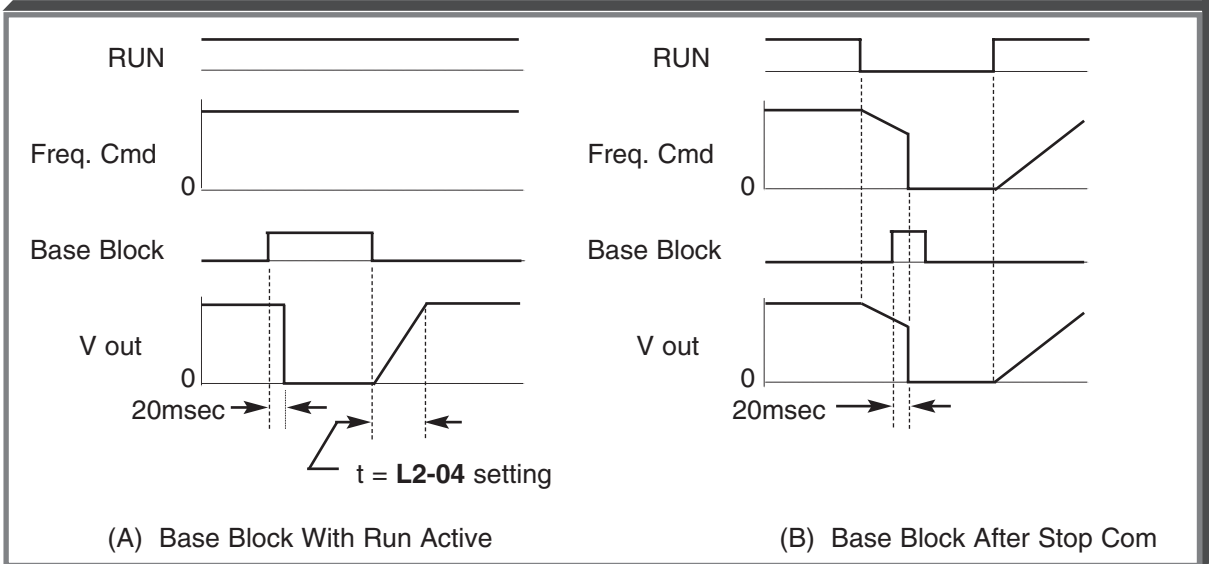

**C. Data 9 : External Base Block by N.C. Contact**

Base block operation is the same as described above, except that the Base Block contact must be *open* to be recognized.

## 5.32 MULTI-FUNCTION INPUT TERMINALS (Term. 3-8)

Continued

- D. Data **6 1** : Speed Search From Max Frequency  
Data **6 2** : Speed Search From Set Frequency  
Data **6 4** : Speed Search From Output Frequency

A multi-function input terminal is utilized to activate speed search. When the external speed search command is closed, the base is blocked for the min. base block time, **L2-03**, then the speed search is made. The operation depends on the set value.

### IMPORTANT

Set values **6 1**, **6 2** & **6 4** CANNOT be selected in combination.

- When **6 1** is set, the speed search begins with the maximum frequency.
- When **6 2** is set, the speed search begins with the frequency command that has been set after the search command was received.
- When **6 4** is set, the speed search begins with the last output frequency before the speed search command was received.

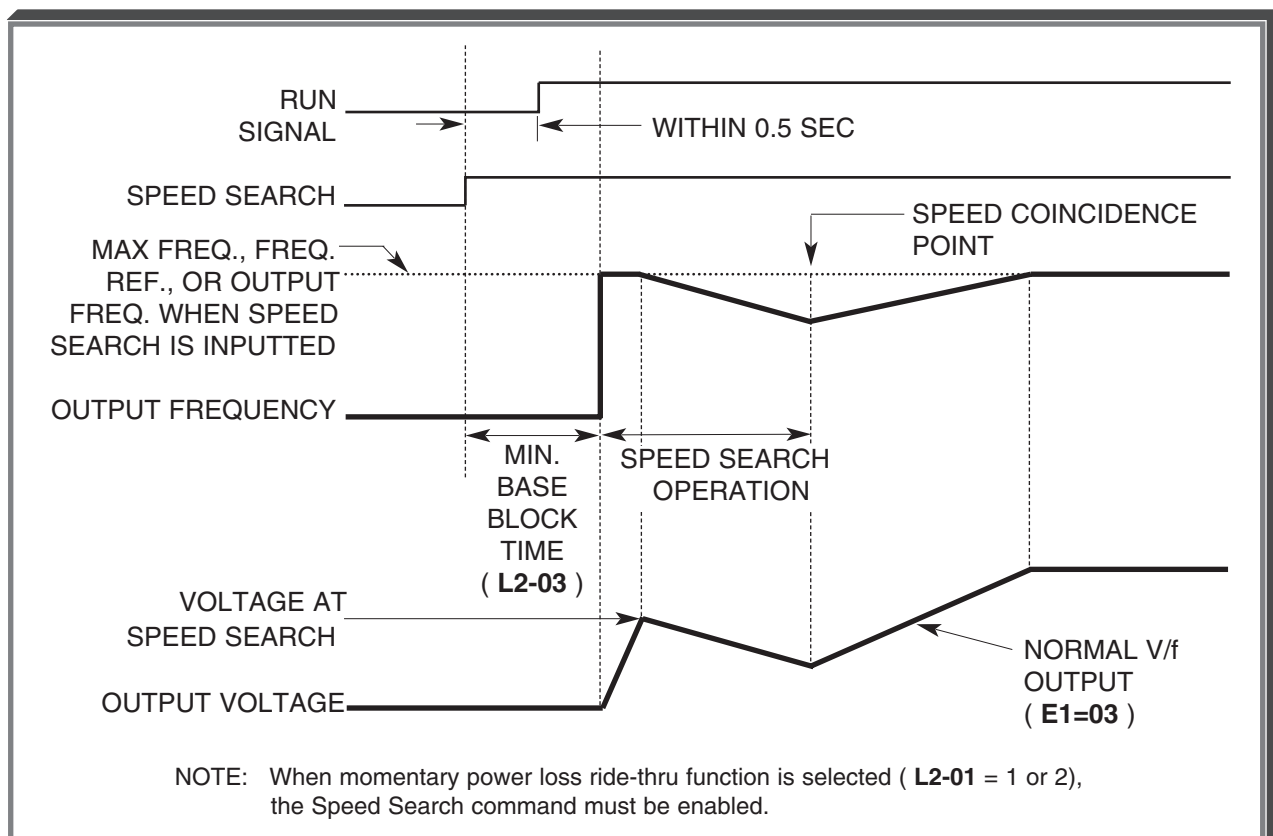

**Speed Search Operation Timing**

## 5.32 MULTI-FUNCTION INPUT TERMINALS (Term. 3-8)

Continued

**b3-01** : Speed Search Selection

Factory setting: **0** = Disabled (when V/f control or Open Loop Vector control has been selected)  
**1** = Enabled (when V/f w/PG control or Flux Vector control has been selected)

Range: 0 or 1

**b3-02** : Speed Search Deactivation Current Level

Factory setting: **150**

Range: 0 to 200 %

**b3-03** : Speed Search Deceleration Time

Factory setting: **2.0**

Range: 0.0 to 10.0 sec.

After power recovery, if the drive output current is larger than the set value of **b3-02**, speed search is started, using a decel rate per the setting of **b3-03**. When drive output current is lower than the set value of **b3-02**, speed search is complete and acceleration or deceleration is continued at the normal rate (**C1-XX**) to set frequency.

**L2-03** : Minimum Baseblock Time

Factory setting: *See Table A3-1*

Range: 0.1 to 5.0 sec.

When a momentary power loss is detected, the drive output transistors are disabled for a period of time determined by the setting of **L2-03**. The **L2-03** setting should represent the time required for the motor residual voltage to go to zero.

When the momentary power loss time exceeds the minimum base block time, the speed search operation is started immediately after power recovery.

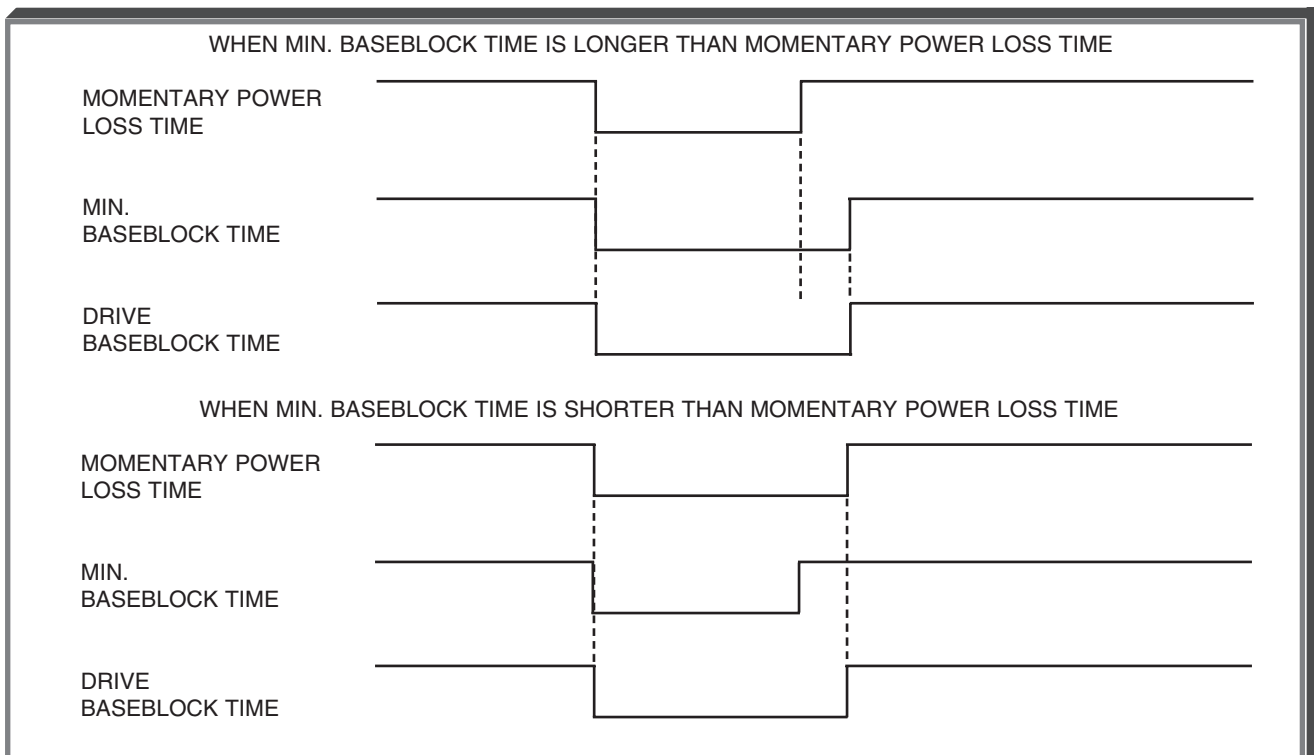



### 5.32 MULTI-FUNCTION INPUT TERMINALS (Term. 3-8)

Continued

#### E. Data 18 : Timer Input Function

**H2-01** : Multi-function Output Terminals (9 & 10)  
**H2-02** : Multi-function Output Terminals (25 & 27)  
**H2-03** : Multi-function Output Terminals (26 & 27)

**b4-01** : On-delay Timer

**b4-02** : Off-delay Timer

Data 12 : Timer Function

Factory setting: **0.0**

Range: 0.0 to 300.0 sec.

Factory setting: **0.0**

Range: 0.0 to 300.0 sec.

When the timer function input is “closed” for longer than On-delay Timer ( **b4-01** ), the timer function output closes.

When the timer input is “open” for longer than Off-delay Timer ( **b4-02** ), the timer function output opens.

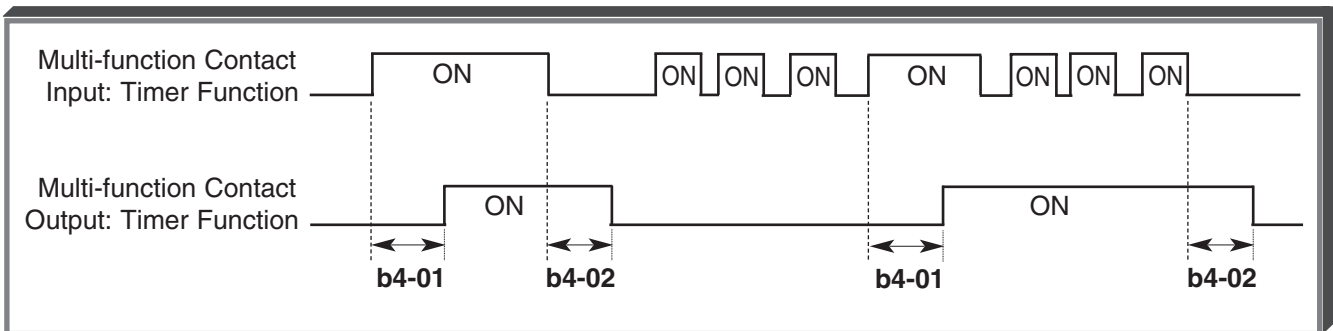

As can be seen, the timer function must be programmed as both a multi-function input **and** an output to be effective.

#### F. Data 1E : Sample/Hold Command

This function applies only to an analog voltage or current input used as a frequency reference at terminals 13 or 14.

If the Sample/Hold command is present (contact is closed) for more than 0.1 sec., the frequency reference will follow (sample) the analog signal, e.g. if 5V corresponds to 50% frequency, a 5V analog signal will produce 50% frequency reference if the Sample/Hold command is present.

If the Sample/Hold command is removed (contact is opened) while the Drive is still in Run condition, the frequency reference is held at the level it was at the time the Sample/Hold command was removed, e.g. the frequency reference would remain at 50%, even though the analog signal increased to 8V.

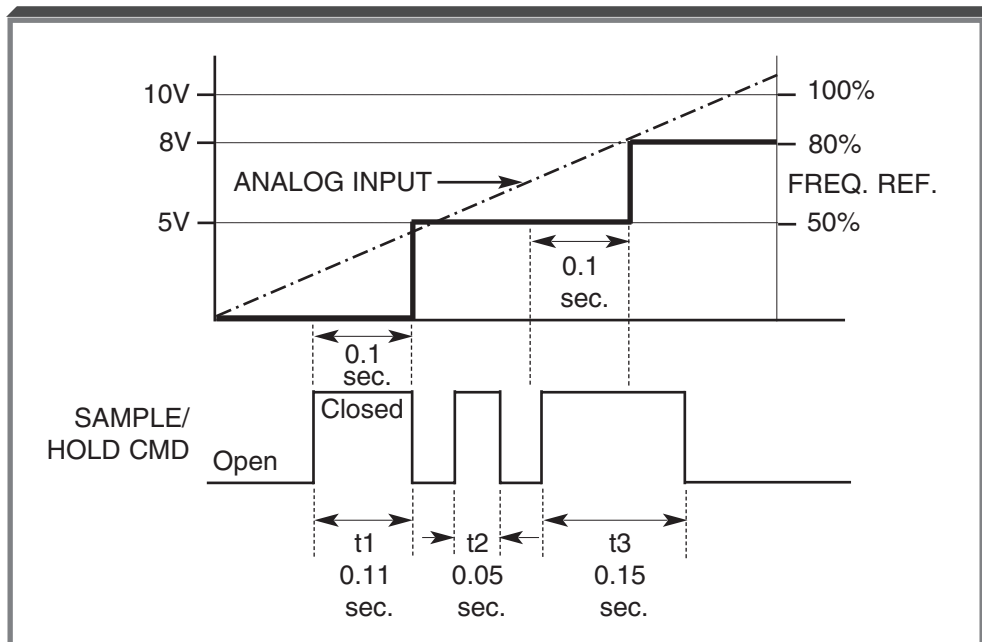

**Sample/Hold Function Timing**

- G.** Data 10 : Up Function  
Data 11 : Down Function

**d4-01** : Frequency Reference Hold  
Function Selection

Factory setting: **0**

Data: 0 = Disabled  
1 = Enabled

Programming data " 10 " and " 11 " for two of the six multi-function input terminals allows those inputs to be used for Up/Down frequency setting by simulating the action of a MOP (motor operated potentiometer).

**NOTES:**

1. Set parameter **b1-02** = 1.
2. **OPE3** fault will occur if " 10 " and " 11 " data settings are not used together.
3. **OPE3** fault will occur if " 10 " and " 11 " data settings are programmed at the same time as setting " A " (Accel/decel ramp hold).
4. Jog has priority over Up/Down function.
5. Up/Down has priority over Multi-step Speed inputs.
6. Up/Down is ineffective when operation is from the Digital Operator.

(NOTES continued on next page)

**G.** (Continued)

NOTES (Continued):

7. Upper limit speed is set by the formula:

$$E1-04 (F_{max}) \times d2-01 (\text{Freq. Ref. Upper Limit})$$

8. Lower limit speed is either the reference from external terminals 13 or 14, or from **d2-01** , Frequency Reference Lower Limit.

9. If **d4-01** = " 0 ", Frequency Reference will be reset to 0 Hz if the stop command is given, or if input power is removed and reapplied.

10. If **d4-01** = " 1 ", the drive will retain the last valid Frequency Reference if a stop command is given or if input power is removed, and will accelerate to that reference upon reapplication of a run command.

**EXAMPLE:**

**H1-05** Data **10** : Up function

**H1-06** Data **11** : Down function

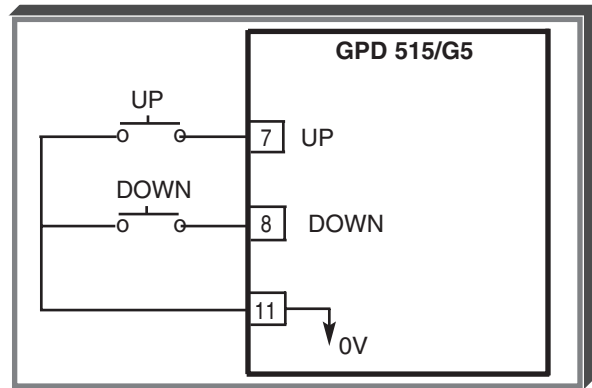

INPUT SIGNAL		FUNCTION
UP	DOWN	
Open	Open	HOLD
Closed	Open	UP (Frequency command approaches frequency command upper limit)
Open	Closed	DOWN (Frequency command approaches minimum output frequency or frequency command lower limit, whichever is larger)
Closed	Closed	HOLD

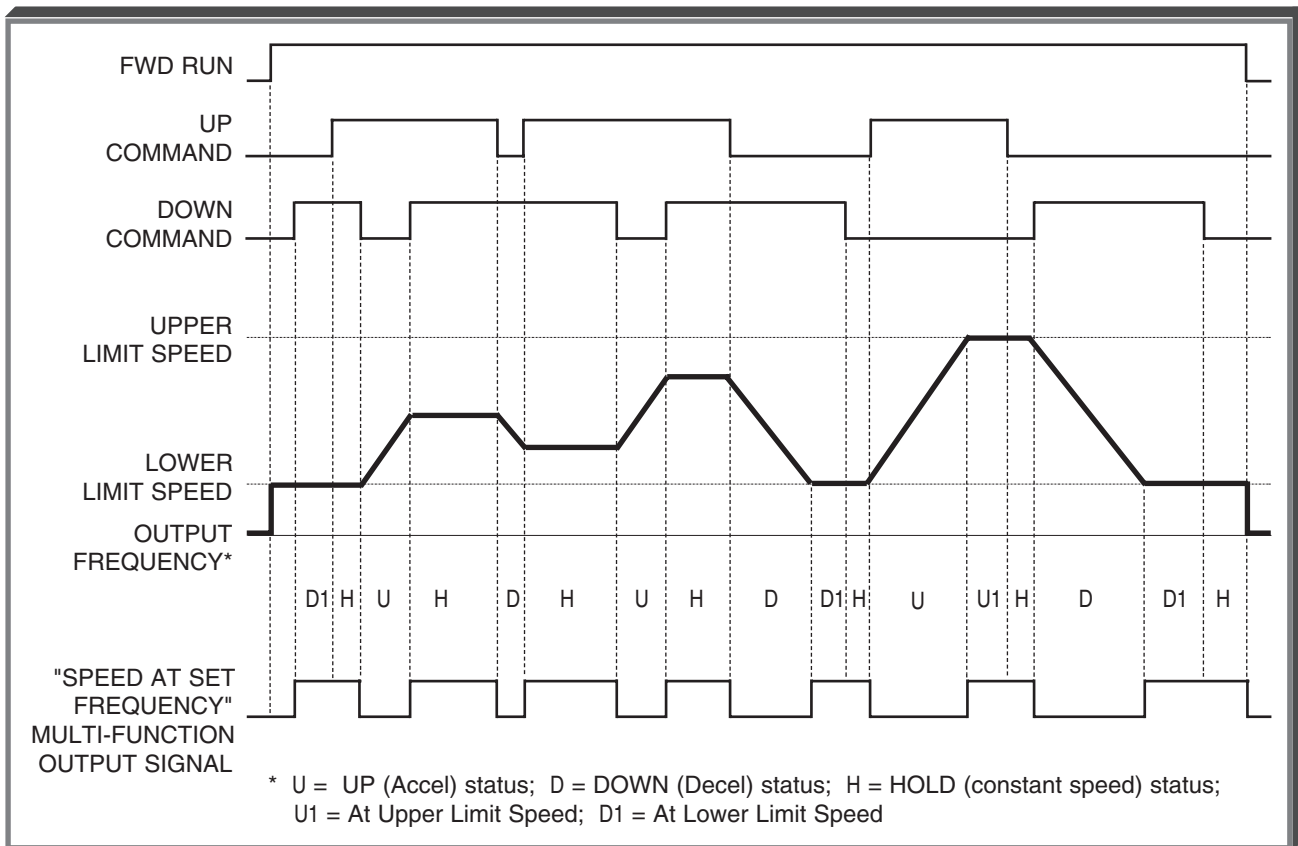

**Up/Down Frequency Setting Timing**

- H. Data **1C** : Trim Control Increase
- Data **1D** : Trim Control Decrease

**d4-02** : Trim Control Level

Factory setting: <b>10</b>
Range: 0 to 100 %

The value of **d4-02** is a percentage of the maximum output frequency ( **E1-04** ).

When the trim control increase input is closed, the value of **d4-02** gets added to the analog frequency reference.

When the trim control decrease input is closed, the value of **d4-02** gets subtracted from the analog frequency reference.

### 5.33 MULTI-FUNCTION OUTPUT TERMINALS (Term. 9 & 10; 25-27)

- H2-01** : Contact Output (external terminals 9 & 10)
- H2-02** : Open Collector Output (external terminals 25 & 27)
- H2-03** : Open Collector Output (external terminals 26 & 27)

A contact, or two different open collector outputs, can be programmed to change states during any of the conditions indicated in Table 5-3.

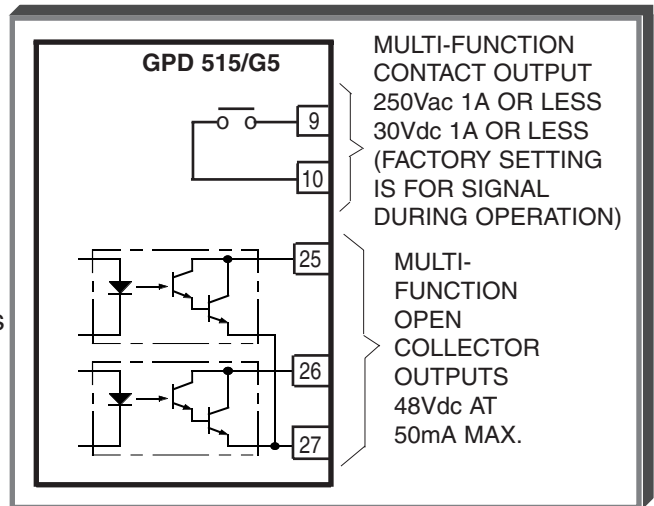

#### IMPORTANT

If an open collector output is applied to a DC relay, the relay **MUST** be diode protected, as shown in the recommended configuration below.

Recommended Configuration for DC Relays

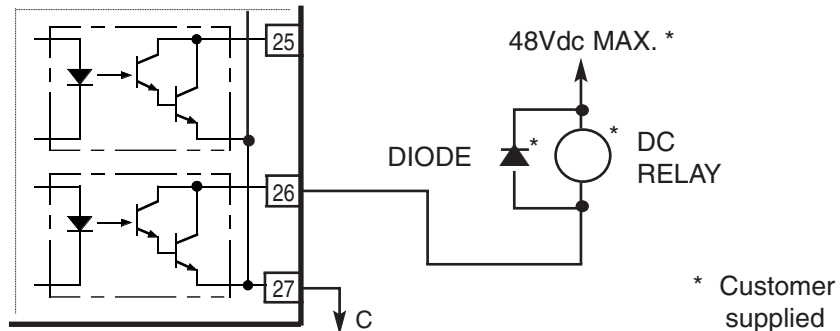

**5.33 MULTI-FUNCTION OUTPUT TERMINALS (Term. 9 & 10; 25-27)**

Continued

**Table 5-3. H2-01 thru H2-03 Data Settings**

DATA	CONDITION	SIGNAL LEVEL	AVAILABILITY (See Note 1)		
			0, 1	2	3
<b>0</b>	During Operation	Closed = Drive is operating	X	X	X
<b>1</b>	Zero speed	Closed = Drive is at 0Hz	X	X	X
<b>2</b>	Speed at set frequency 1	Closed = Freq. Ref. – <b>L4-02</b> ≤ output freq ≤ Freq. Ref. + <b>L4-02</b> <b>See Data description following this table</b>	X	X	X
<b>3</b>	Speed coincidence 1	Closed = Speed at set frequency and <b>L4-01 – L4-02</b> ≤ output freq. ≤ <b>L4-01 + L4-02</b> <b>See Data description following this table</b>	X	X	X
<b>4</b>	Frequency detection 1 – low	Closed = Output frequency ≤ <b>L4-01</b> <b>See Data description following this table</b>	X	X	X
<b>5</b>	Frequency detection 1 – high	Closed = Output frequency ≥ <b>L4-01</b> <b>See Data description following this table</b>	X	X	X
<b>6</b>	Operation ready	Closed = Drive is ready for operation	X	X	X
<b>7</b>	During undervoltage detection	Closed = Undervoltage detected	X	X	X
<b>8</b>	During base block	Closed = Drive output base block is active; motor is coasting	X	X	X
<b>9</b>	Frequency reference mode	Open = Command by external input Closed = Command by Digital Operator	X	X	X
<b>A</b>	Run reference mode	Open = Run by external input Closed = Run by Digital Operator	X	X	X
<b>B</b>	Overtorque detection 1	Closed = Overtorque detected	X	X	X
<b>C</b>	Frequency reference missing	Closed = Frequency reference is missing	X	X	X
<b>D</b>	Braking resistor fault	Closed = Braking resistor is overheating or has faulted	X	X	X
<b>E</b>	Fault	Closed = Drive fault has occurred (except <b>CPF00</b> , <b>CPF01</b> )	X	X	X
<b>F</b>	Not Used				
<b>10</b>	Alarm (minor fault)	Closed = Alarm condition is present	X	X	X
<b>11</b>	During fault reset	Closed = Drive is performing fault reset	X	X	X
<b>12</b>	Timer output function	<b>See paragraph 5.32 E</b>	X	X	X

**5.33 MULTI-FUNCTION OUTPUT TERMINALS (Term. 9 & 10; 25-27)**

Continued

**Table 5-3. H2-01 thru H2-03 Data Settings - Continued**

DATA	CONDITION	SIGNAL LEVEL	AVAILABILITY (See Note 1)		
			0, 1	2	3
13	Speed at set frequency 2	Closed = Freq. Ref. - <b>L4-04</b> ≤ output freq ≤ Freq. Ref. + <b>L4-04</b> See Data description following this table	X	X	X
14	Speed coincidence 2	Closed = Speed at set frequency and <b>L4-03</b> - <b>L4-04</b> ≤ output freq. ≤ <b>L4-03</b> + <b>L4-04</b> See Data description following this table	X	X	X
15	Frequency detection 2 – low	Open = Output freq. ≥ <b>L4-03</b> + <b>L4-04</b> Closed = Output frequency ≤ <b>L4-03</b> See Data description following this table	X	X	X
16	Frequency detection 2 – high	Open = Output freq. ≤ <b>L4-03</b> + <b>L4-04</b> Closed = Output frequency > <b>L4-03</b> See Data description following this table	X	X	X
17	Overtorque detection 1 (N.C.)	Open = Overtorque 1 detected according to settings of <b>L6-01</b> thru <b>L6-03</b>	X	X	X
18	Overtorque detection 2 (N.O.)	Closed = Overtorque 2 detected according to settings of <b>L6-04</b> thru <b>L6-06</b>	X	X	X
19	Overtorque detection 2 (N.C.)	Open = Overtorque 2 detected according to settings of <b>L6-04</b> thru <b>L6-06</b>	X	X	X
1A	During reverse run	Closed = Drive operation in reverse	X	X	X
1B	During base block 2	Open = Drive output base block is active; motor is coasting	X	X	X
1C	Motor 2 Selected	Closed = Motor 2 is selected	X	X	X
1D	Regenerating	Closed = Regenerating mode [ only when <b>A1-02</b> is set for Flux Vector Control ]	—	—	X
1E	During restart	Closed = Retry operation after a fault	X	X	X
1F	OL1 pre-alarm	Closed = Thermal overload level exceeds 90% of fault detection level	X	X	X
20	OH pre-alarm	Closed = Cooling fin temperature exceeds <b>L8-02</b> level	X	X	X
21 – 2F	Not Used				
30	During torque limit	Closed = Torque limit	—	X	X
31	During speed limit	Closed = Speed limit reached [ only when <b>A1-02</b> is set for Flux Vector Control ]	—	—	X

**Table 5-3. H2-01 thru H2-03 Data Settings - Continued**

DATA	CONDITION	SIGNAL LEVEL	AVAILABILITY (See Note 1)		
			0, 1	2	3
<b>32</b>	Not Used				
<b>33</b>	Zero-Servo complete	Closed = Zero-Servo is complete <b>See paragraph 5.49 C</b>	—	—	X
<b>34 – 36</b>	Not Used				
<b>37</b>	During operation	Closed = Drive is operating (except during base block or injection braking)	X	X	X
<b>38 – 3F</b>	Not Used				

NOTES:

- Column headings refer to set value of **A 1 - 0 2**, Control Method; 0 = V/f, 1 = V/f w/PG, 2 = Open loop vector, 3 = Flux vector.

**A. Data 2–5, 13–16 : Frequency or Speed Detection Output Signals**

**L 4 - 0 1** : Speed Coincidence Detection Level

Factory setting: <b>0.0</b>
Range: 0.0 to 400.0 Hz

**L 4 - 0 2** : Speed Coincidence Detection Width

Factory setting: <b>2.0</b>
Range: 0.0 to 20.0 Hz

**L 4 - 0 3** : Speed Coincidence Detection Level (+/-)

Factory setting: <b>0.0</b>
Range: -400.0 to +400.0 Hz

**L 4 - 0 4** : Speed Coincidence Detection Width (+/-)

Factory setting: <b>2.0</b>
Range: 0.0 to 20.0 Hz

These speed coincidence parameters are used to control contact output at terminals 9 & 10, or one of the open collector outputs at terminals 25 & 26 (with respect to terminal 27), when selected by **H 1 - 0 1** thru **H 1 - 0 3**. Both **L 4 - 0 1** and **L 4 - 0 2** are insensitive to motor direction.

The output contact will close, or the open collector output will go low, when the acceleration or deceleration is completed, or output frequency or speed is within the detection width for the selected output function. See the timing diagrams on the following pages.



**Frequency detection 1 – low**

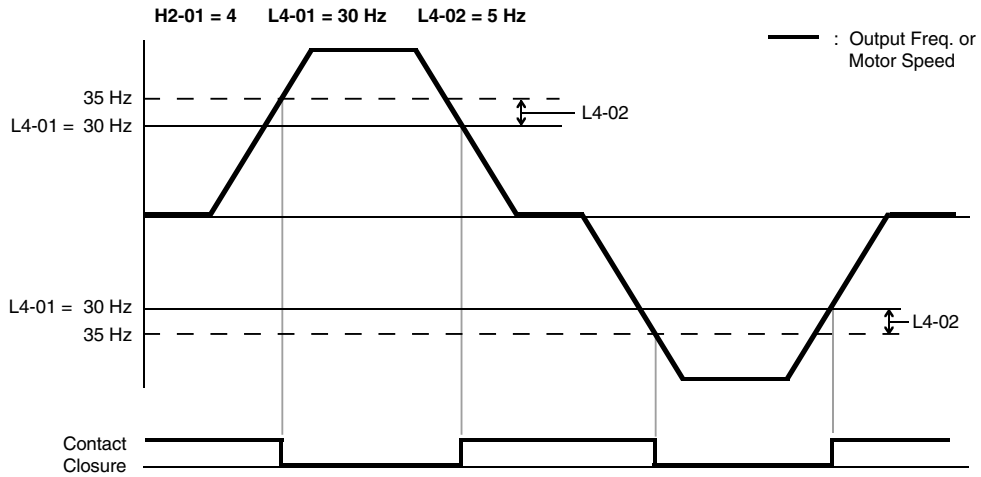

**Frequency detection 1 – high**

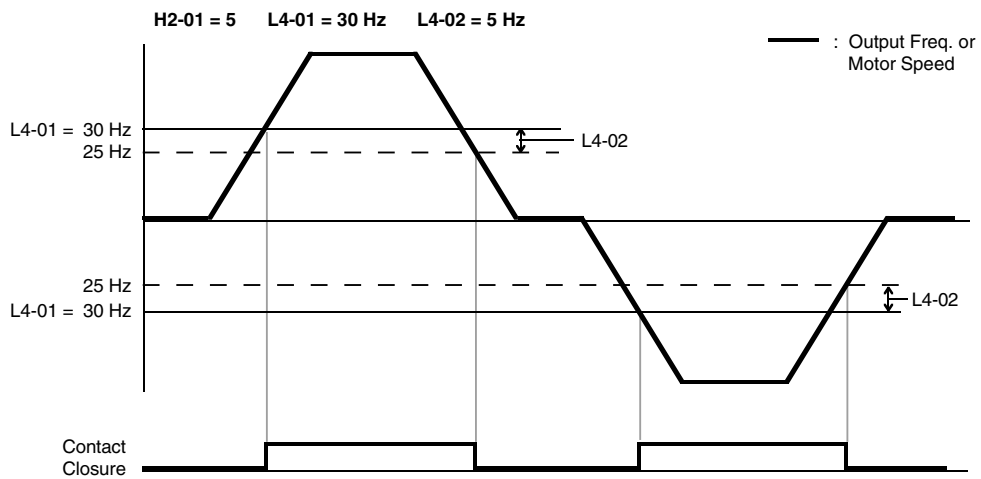

**Frequency detection 2 – low**

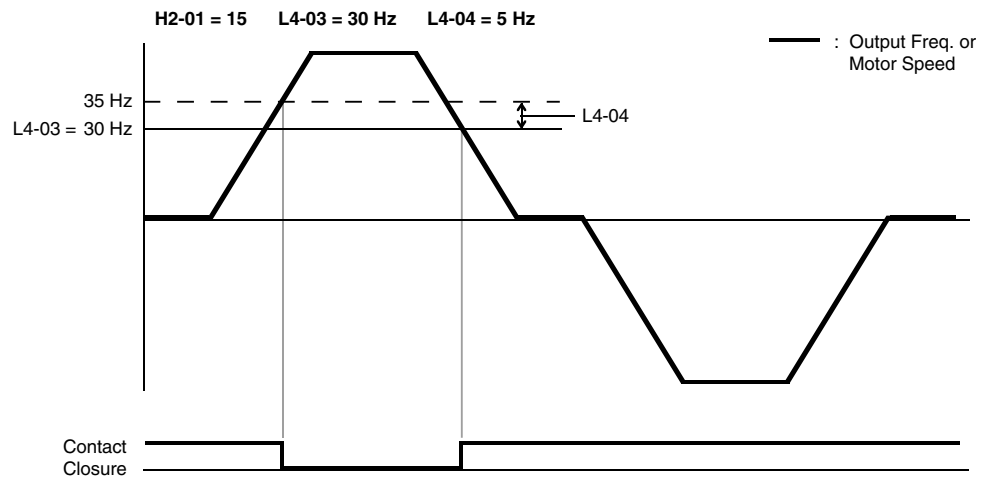

**Frequency detection 2 – high**

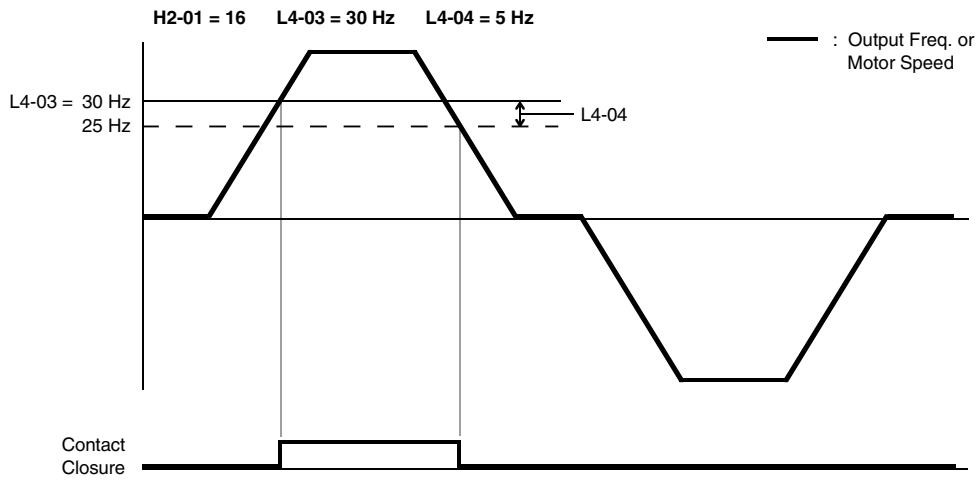

**Speed at set frequency 1**

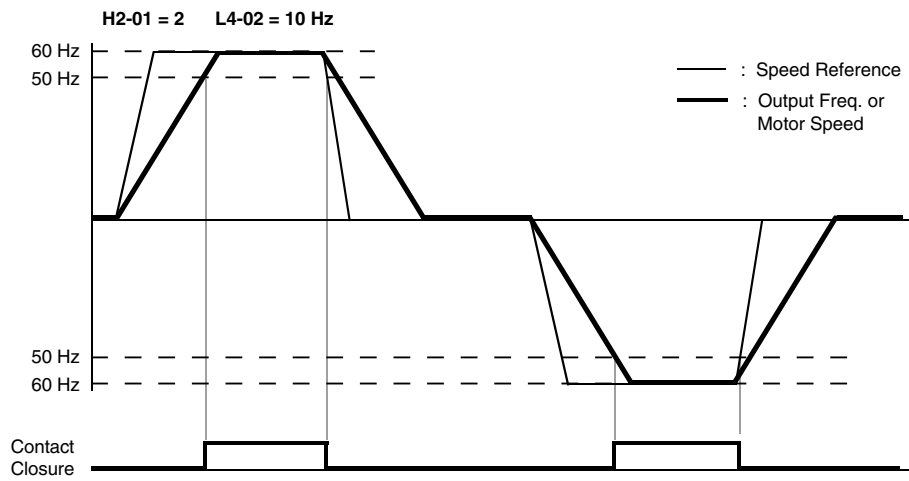

**Speed at set frequency 2**

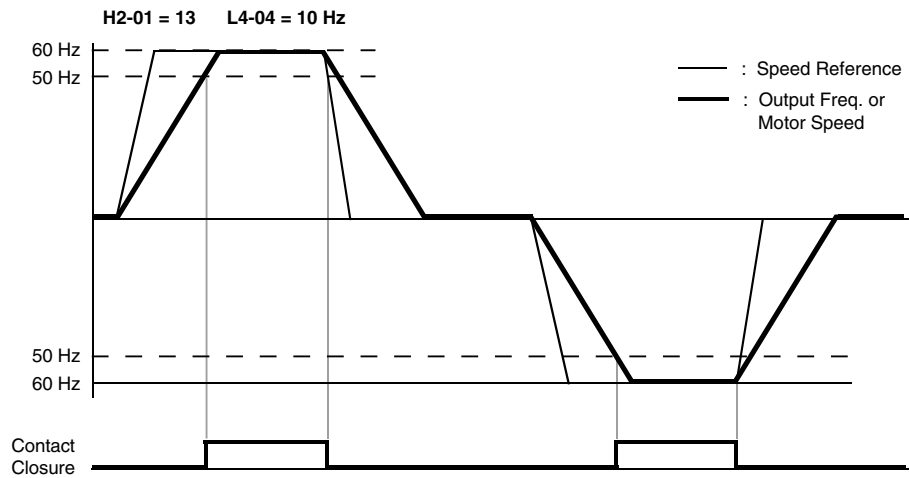

**Speed coincidence 1**

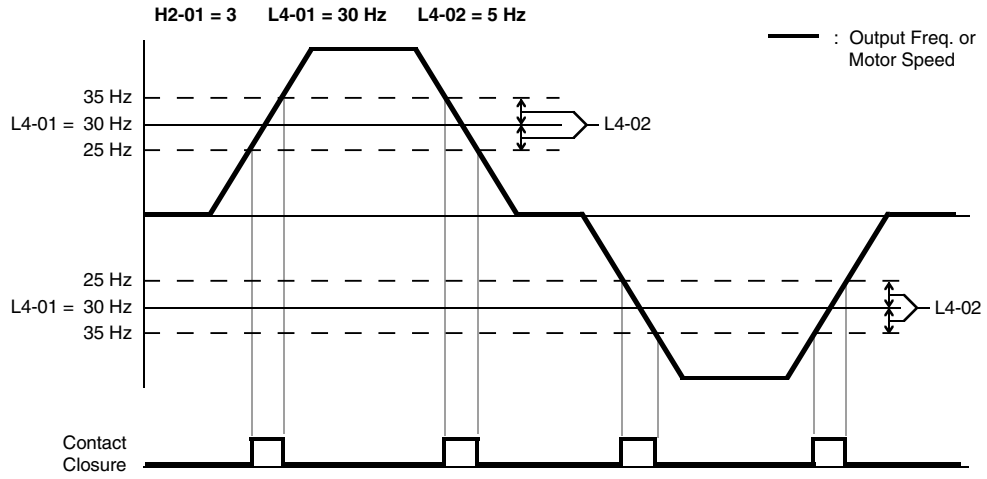

**Speed coincidence 2**

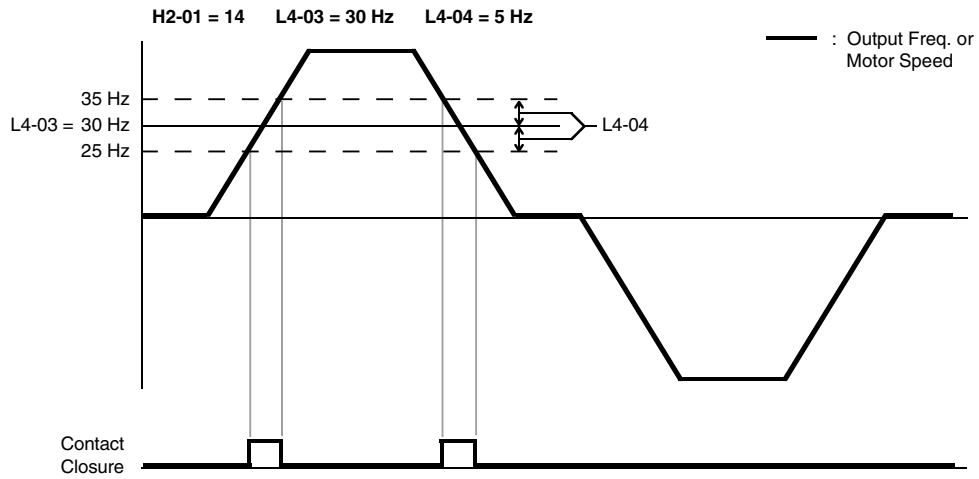

### 5.34 PHASE LOSS DETECTION, INPUT

---

**L8-05** : Input Phase Loss Detection Selection

Factory setting: <b>0</b>
---------------------------

Range: 0 or 1
---------------

The input phase loss detection circuit monitors the DC bus current ripple and activates when one of the input phases is lost. This causes a " **PF** " fault to occur and the motor to coast to a stop.

Setting	Description
0	Input phase loss detection disabled
1	Input phase loss detection enabled

### 5.35 PHASE LOSS DETECTION, OUTPUT

---

**L8-07** : Output Phase Loss Detection Selection

Factory setting: <b>1</b>
---------------------------

Range: 0 or 1
---------------

The output phase loss detection circuit monitors the DCCT's and activates when one of the output phases is lost. This causes a " **LF** " fault to occur and the motor to coast to a stop.

Setting	Description
0	Output phase loss detection disabled
1	Output phase loss detection enabled

## 5.36 PID CONTROL

The Proportional, Integral and Derivative control function provides closed-loop control, or regulation, of a system process variable (pressure, temperature, etc.). This regulation is accomplished by comparing a feedback signal to a setpoint reference, which results in an error signal. The PID control algorithm then performs calculations, based upon the PID parameter settings ( **b5-01** thru **b5-14** ), on this error signal. The result of the PID algorithm is then used as the new frequency reference, or is added to the existing speed reference.

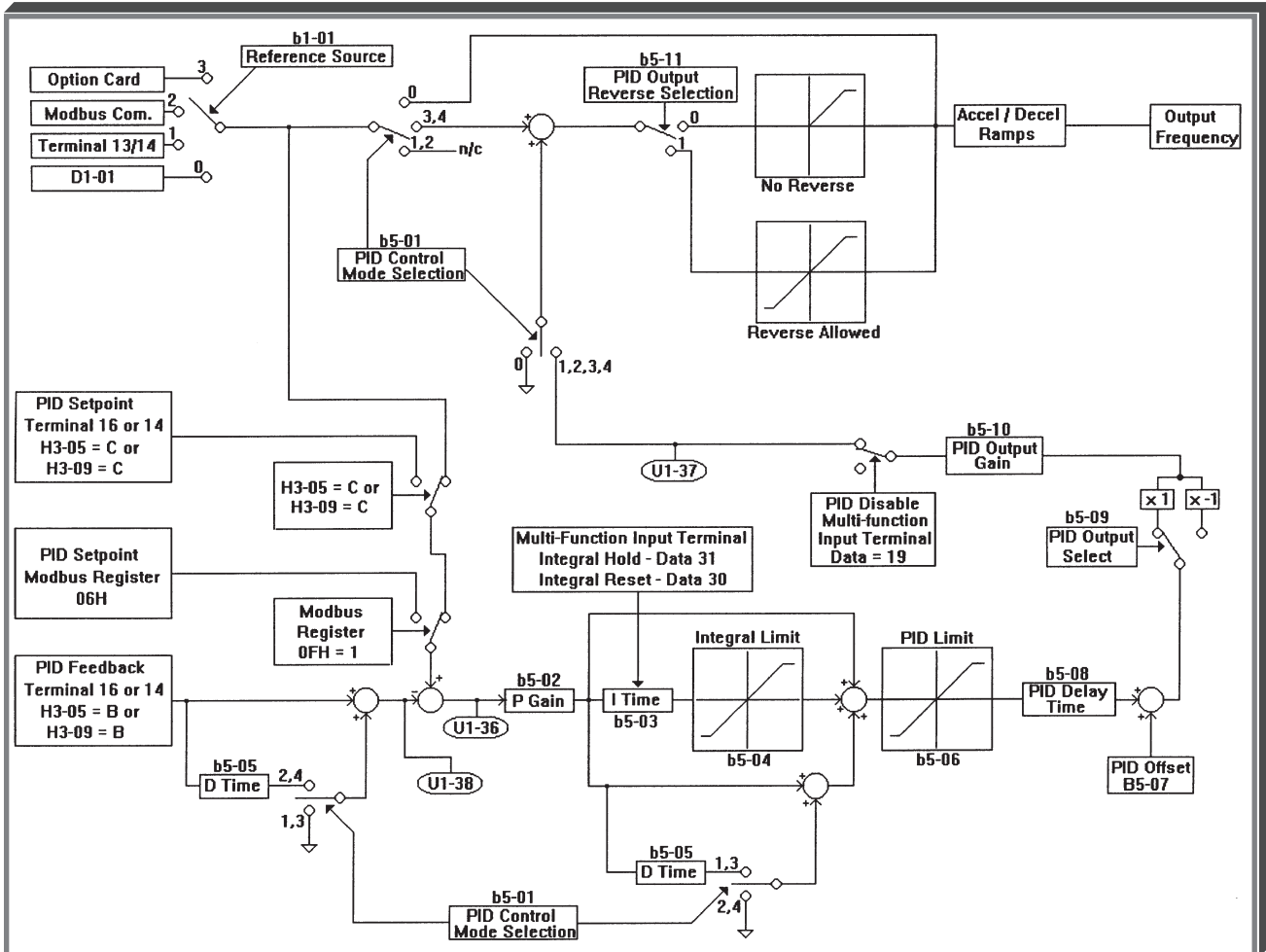

### A. **b5-01** : PID Selection

Factory setting: **0**

Range: 0 to 4

Using this parameter, PID control can be enabled, and the type of PID control can be selected.

Setting	Description
0	PID Disabled
1	PID Enabled (D = Feedback)
2	PID Enabled (D = Feed forward)
3	PID Enabled, Reference + PID (D = Feedback)
4	PID Enabled, Reference + PID (D = Feedback forward)

**B. Setpoint Reference Selection**

**b1-01** : Reference Selection

Factory setting: <b>1</b>
---------------------------

Range: 0 to 4
---------------

**d1-01** thru **d1-09** : Multi-step Frequency Presets

Factory settings: <b>d1-09 = 6.0</b> all others = <b>0.0</b>
---

Range (each): 0.0 to 400.0 Hz
-------------------------------

**H3-01** : Auto Speed Reference Signal Level Selection (Term. 13)

Factory setting: <b>0</b>
---------------------------

Range: 0 or 1
---------------

**H3-04** : Multi-Function Analog Input 1 Level Selection (Term. 16)

Factory setting: <b>0</b>
---------------------------

Range: 0 or 1
---------------

**H3-05** : Multi-Function Analog Input 1 Selection (Term. 16)

Factory setting: <b>0</b>
---------------------------

Range: 0 to 1F
----------------

**H3-08** : Multi-Function Analog Input 2 Level Selection (Term. 14)

Factory setting: <b>2</b>
---------------------------

Range: 0 to 2
---------------

**H3-09** : Multi-Function Analog Input 2 Selection (Term. 14)

Factory setting: <b>1 F</b>
-----------------------------

Range: 0 to 1F
----------------

The PID setpoint can come from the frequency reference (terminal 13 for 0 – 10 VDC or the multi-step speed parameters **d1-01** thru **d1-09**) or a Multi-Function Analog Input.

PID Setpoint examples:

- External Terminal 13: Set **b1-01** to data " 1 " or
- Multi-step speed parameters: Set **b1-01** to data " 0 " (See Multi-step Speed Setting, paragraph 5.25B) or
- External Terminal 16: Set **H3-05** to data " C " or
- External Terminal 14: Set **H3-09** to data " C "

**C. Feedback Signal Selection**

**H3-05** : Multi-function Analog Input 1 Selection (Term. 16)

Factory setting: <b>0</b>
---------------------------

Range: 0 to 1F
----------------

**H3-09** : Multi-function Analog Input 2 Selection (Term. 14)

Factory setting: <b>1 F</b>
-----------------------------

Range: 0 to 1F
----------------

Select the PID control Feedback Signal from external terminal 14 for a current signal (4-20mA DC) or from terminal 16 for a voltage (0-10 VDC or –10 to +10 VDC).

PID Feedback examples:

- Current signal (4-20mA): Set **H3-09** to data " B " and **H3-08** to data " 2 ".
- Voltage signal (0-10 VDC): Set **H3-05** to data " B " and **H3-04** to data " 0 ".
- Voltage signal (–10 to 10 VDC): Set **H3-05** to data " B " and **H3-04** to data " 1 ".

**D. PID Settings****b5-02** : Proportional GainFactory setting: **1.00**

Range: 0.00 to 10.00

Proportional gain is the value by which the error signal is multiplied to generate a new PID controller output. A higher setting will result in a more responsive system. A lower setting will result in a more stable system.

**b5-03** : Integral TimeFactory setting: **1.0**

Range: 0.0 to 360.0 seconds

This parameter determines how fast the PID controller will seek to eliminate any steady-state error. The smaller the setting, the faster the error will be eliminated. To eliminate the integral function entirely, set this parameter to 0.0 seconds. A lower setting will result in a more responsive system. A higher setting will result in a more stable system.

**b5-04** : Integral Value Limit<sup>(1)</sup>Factory setting: **100.0**

Range: 0.0 to 100.0 %

This parameter will limit the effect that the integrator can have. It works whether the PID controller output is positive or negative. It can also be used to prevent integrator “wind-up.”

**b5-05** : Derivative TimeFactory setting: **0.00**

Range: 0.0 to 10.00 seconds

This parameter can be adjusted to increase system response to fast load or reference changes, and to reduce overshoot upon startup. To eliminate the differential function entirely, set this parameter to 0.00 seconds.

**b5-06** : PID Output Limit<sup>(1)</sup>Factory setting: **100.0**

Range: 0.0 to 100.0 %

Parameter **b5-06** can be used to set the maximum effect the PID controller will have on the system. It also will limit the PID output when it is either positive or negative. NOTE: When the PID output limit is reached, the integrator will hold and not change in value until the PID output is less than the PID output limit.

**b5-07** : PID Offset Adjustment<sup>(1)</sup>Factory setting: **0.0**

Range: -100.0 to 100.0 %

This parameter will add a fixed percentage to the PID output. It can be used to tune out small system offsets. NOTE: This parameter is set as a percentage of maximum output frequency (**E1-04**).

<sup>(1)</sup> These parameters are factory set for optimum results for most applications, and generally do not need to be changed.

**5.36 PID CONTROL**

Continued

**b5-08** : Output Lag Filter Time<sup>(1)</sup>Factory setting: **0.00**

Range: 0.00 to 10.00 seconds

This parameter adds a filter to the PID output to keep it from changing too quickly. The higher the setting, the slower the PID output will change.

**b5-09** : PID Output SelectionFactory setting: **0**

Range: 0 or 1

Setting	Description
<b>0</b> (Not Inverted)	The output of the PID controller will decrease when there is an increase in feedback level.
<b>1</b> (Inverted)	The output of the PID controller will increase when there is an increase in the feedback level.

**b5-10** : PID Output Selection<sup>(1)</sup>Factory setting: **1.0**

Range: 0.0 to 25.0

This parameter is a multiplier in the output of the PID controller. Increasing this parameter will make the PID controller more responsive. Be careful not to increase this parameter too much or the drive/system will become unstable.

**b5-11** : PID Output Reverse SelectionFactory setting: **0**

Range: 0 or 1

Setting	Description
<b>0</b>	If the PID controller calls for a “negative” speed (reverse), the drive/motor will stop.
<b>1</b>	If the PID controller calls for a “negative” speed (reverse), the drive/motor will run in reverse.

All of these parameters are interactive, and will need to be adjusted until the control loop is properly tuned, i.e. stable with minimal steady-state error. A general procedure for tuning these parameters is as follows:

1. Adjust Proportional Gain until continuous oscillations in the Controlled Variable are at a minimum.
2. The addition of Integral Time will cause the steady-state error to approach zero. The time should be adjusted so that this minimal error is attained as fast as possible, without making the system oscillate.
3. If necessary, adjust derivative time to reduce overshoot during startup. The drive’s accel and decel rate times can also be used for this purpose.

<sup>(1)</sup> These parameters are factory set for optimum results for most applications, and generally don’t need to be changed.



## 5.36 PID CONTROL

Continued

### E. Feedback Loss Detection

Factory setting: **0**

Range: 0 to 2

**b5-12** : Feedback Loss Detection Selection

Setting	Description
<b>0</b>	Feedback loss detection is disabled
<b>1</b>	Feedback loss detection is enabled - alarm only (drive continues running).
<b>2</b>	Feedback loss detection is enabled - fault (drive coasts to stop)

**b5-13** : Feedback Loss Detection Level (PID)

Factory setting: **0**

Range: 0 to 100 %

**b5-14** : Feedback Loss Detection  
Delay Time (PID)

Factory setting: **1.0**

Range: 0.0 to 25.5

When feedback loss detection is enabled (**b5-12** = data “1” or “2”), the drive will detect if the feedback signal falls below the **b5-13** level for more than the **b5-14** delay time and respond according to the setting of **b5-12**.

### F. Multi-Function Input Terminals

**H1-01 thru H1-06** : Multi-function Inputs  
(Term. 3 thru 8)

Data **30** : PID Integral Reset

By programming data “30” into one of the multi-function parameters (**H1-01** thru **H1-06**), the corresponding multi-function input terminal (3 thru 8) will reset the integrator’s value to zero.

**H1-01 thru H1-06** : Multi-function Inputs  
(Term. 3 thru 8)

Data **31** : PID Integral Hold

By programming data “31” into one of the multi-function parameters (**H1-01** thru **H1-06**), the corresponding multi-function input terminal (3 thru 8) will hold the integrator’s output value. When the contact is closed (on the Multi-Function Input Terminal), whatever value the integrator is outputting will remain the same until the contact is opened.

### 5.37 RESET CODES: 2-WIRE, 3-WIRE INITIALIZATION

**A1-03** : Parameter Selection / Initialization

Factory setting: **0**

Data: **0** = No Initialization  
**1 1 1 0** = User Default Parameter Initialization  
**2 2 2 0** = 2-Wire Control Initialization  
**3 3 3 0** = 3-Wire Control Initialization

By entering either " 2220 " or " 3330 " into this parameter, a reset to factory configuration (parameter initialization) is accomplished. The parameters which are NOT affected are:

**A1-00** : Language Selection      **E1-03** : V/f Pattern Selection  
**A1-02** : Control Method Selection      **o2-04** : GPD 515 Capacity

Parameter	Terminal	Factory Configuration for	
		2-Wire Control	3-Wire Control
<b>H1-01</b>	3	" 24 " = External Fault	" 24 " = External Fault
<b>H1-02</b>	4	" 14 " = Fault Reset	" 14 " = Fault Reset
<b>H1-03</b>	5	" 3 " = Multi-step Ref. Select 1	" 0 " = FWD/REV Command
<b>H1-04</b>	6	" 4 " = Multi-step Ref. Select 2	" 3 " = Multi-step Ref. Select 1
<b>H1-05</b>	7	" 6 " = Jog Freq. Ref.	" 4 " = Multi-step Ref. Select 2
<b>H1-06</b>	8	" 8 " = External Base Block	" 6 " = Jog Freq. Ref. (N.O. contact)

#### CAUTION

Know your application before using either Initialization function of **A1-03** . This parameter must be set to " 0 " for Drive mode operation.

- " 1110 " = User Default Parameter Initialization
- " 2220 " = Factory 2-Wire Control Initialization (Maintained RUN Contact)
- " 3330 " = Factory 3-Wire Control Initialization (Momentary START/STOP Contact)

Entering either Initialization code resets all parameters to factory settings (except for **A1-00**, **A1-02**, **o2-04**, & **E1-03**), and automatically returns **A1-03** setting to " 0 " (No Initialization). If the GPD 515 is connected for 3-Wire control and this parameter is set to " 2220 " (2-Wire Control Initialization), the motor may run in reverse direction WITHOUT A RUN COMMAND APPLIED. Equipment damage or personal injury may result.

When **o2-03** = 1, the existing parameter settings become default user settings and the " 1110 " initialization option appears in **A1-03** . When **o2-03** is not set to " 1 " , this option is not available. Anytime the **A1-03** parameter is set to " 1110 " , all parameter settings that have been changed return to the default user settings (only 50 parameters may be stored as default settings). This is NOT a Factory Initialization.

## 5.38 SLIP COMPENSATION

**C3-01** : Slip Compensation Gain

Factory setting: **0.0** \*

Range: 0.0 to 2.5

\* Note: Factory setting changes to "1.0" for Flux Vector and Open Loop Vector control methods.

**C3-02** : Slip Compensation Primary Delay Time

Factory setting: **2000** \*

Range: 0 to 10000 ms

\* Note: Factory setting changes to "200" for Flux Vector and Open Loop Vector control methods.

**C3-03** : Slip Compensation Limit

Factory setting: **200**

Range: 0 to 250 %

**C3-04** : Slip Compensation Selection During Regeneration

Factory setting: **0**

Data: **0** = Disabled  
**1** = Enabled

**C3-05** : Flux Select

Factory setting: **0**

Range: 0 or 1

Setting	Description
<b>0</b>	Slip Included - Flux is calculated after slip compensation is applied.
<b>1</b>	Slip Excluded - Flux is calculated after slip compensation is applied.

This parameter is only available in the open loop vector control method (**A1-02** = 2). When **C3-05** is set to 0, the motor will enter the constant horsepower range when motor speed exceeds motor rated synchronous speed. When **C3-05** = 1, the motor will enter the constant horsepower range when output frequency is equal to the motor rated frequency.

**C3-06** : Output Voltage Limit

Factory setting: **0**

Range: 0 or 1

Setting	Description
<b>0</b>	Disabled - Output voltage limit and slip compensation are disabled above base speed.
<b>1</b>	Enabled - Output voltage limit and slip compensation are enabled above base speed.

When the control method is set to open loop vector (**A1-02** = 2), this parameter enables and disables slip compensation when operating in the constant horsepower region (output frequency is equal to or greater than motor rated frequency). In order to achieve proper slip compensation, output voltage is reduced slightly starting at 90% of motor rated frequency.

When the control method is set to flux vector (**A1-02** = 3), a **C3-06** setting of "1" will improve torque linearity at and above base speed.

### 5.38 SLIP COMPENSATION

Continued

**C3-01** Slip Compensation is used to increase motor speed to account for slip; this is accomplished by boosting output frequency, with a corresponding boost in output voltage. Sets the slip compensation gain, in increments of 0.1%. When the gain is " 1.0 ", the output frequency is increased by 1% of the **E1-06** setting at rated current. A setting of " 0.0 " results in no slip compensation. **C3-02** & **C3-03** affect this gain as shown in the block diagram. **C3-04** determines whether the slip compensation gain will be enabled or disabled during regeneration.

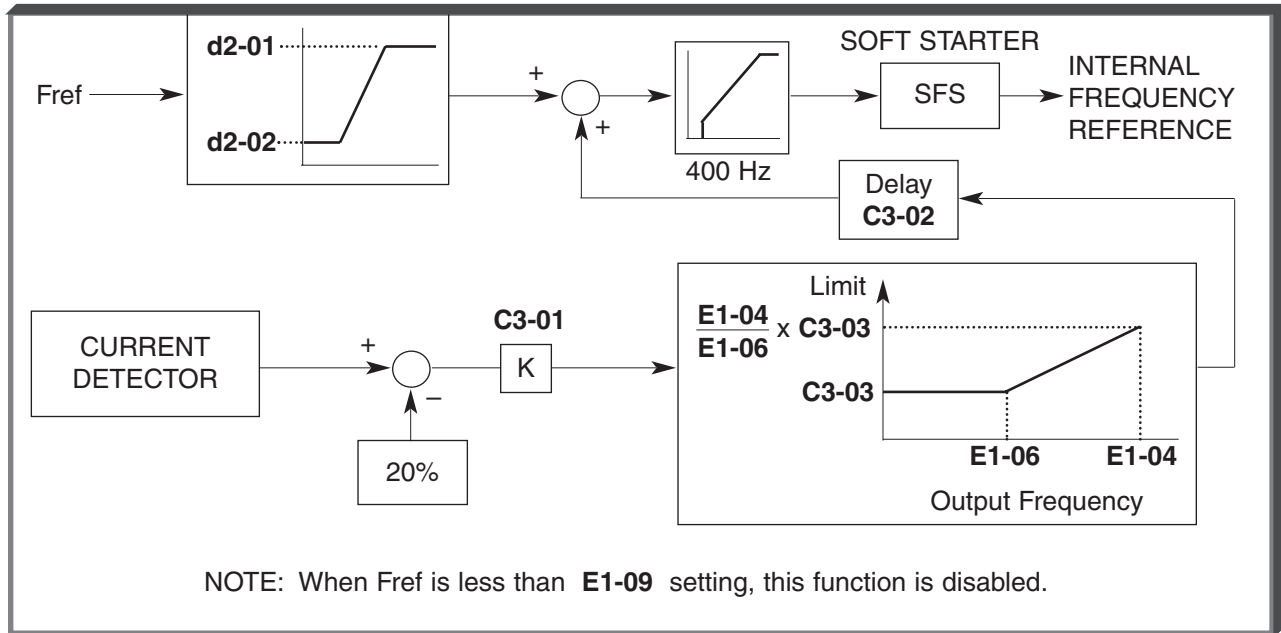

**Slip Compensation Block Diagram**

#### EXAMPLE

Desired frequency is 45 Hz  
 Motor slip = 2% at full load  
 $C3-01 = 2.0$   
 Actual output frequency at full load =  $45 \times 1.02 = 45.90$  Hz

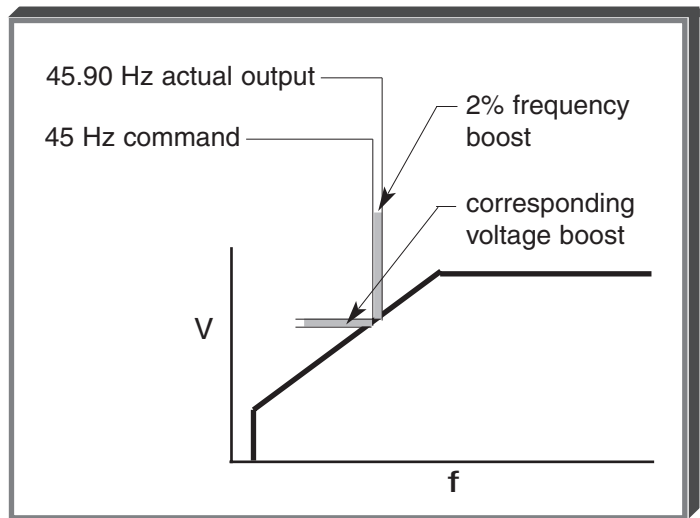

## 5.39 STALL PREVENTION

### A. L3-04 : Stall Prevention Selection During Decel

Factory setting: **1**

L 3 - 0 4 Setting	Function
0	Stall prevention during deceleration disabled. An excessively short deceleration time will generate an overvoltage fault (OV) and the drive will stop.
1	Stall prevention during deceleration enabled (General Purpose). The DC bus voltage level is monitored, and the deceleration rate is automatically extended to prevent an overvoltage condition. This deceleration rate may be longer than the set value (C1-02).
2	Stall prevention during deceleration enabled, auto adjust (Intelligent). By monitoring DC bus voltage, the deceleration rate is automatically adjusted so that deceleration can be completed in the shortest amount of time, regardless of the set deceleration time.
3	Stall prevention during deceleration enabled, with DB resistor. This setting lengthens decel ramp time whenever the drive goes into current limit during a deceleration. Intended to be used when dynamic braking is installed. Note: Not available in the flux vector control method ( <b>A1-02 = 3</b> ).

Stall prevention during deceleration automatically adjusts the deceleration rate while monitoring the DC bus voltage to prevent overvoltage during deceleration.

When the motor load is large or decel time is short, actual decel time may be longer than the set value because of stall prevention.

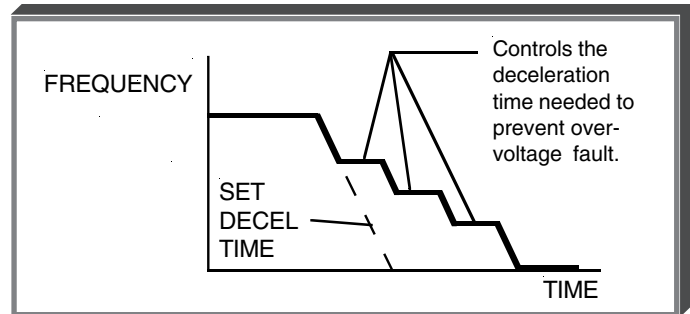

### B. L3-01 : Stall Prevention Selection During Accel

Factory setting: **1**

Setting	Function
0	Stall prevention during acceleration disabled
1	Stall prevention during acceleration enabled
2	Stall prevention during acceleration enabled, auto adjust

### 5.39 STALL PREVENTION

Continued

Factory setting: **150**

Range: 0 to 200 %

#### L3-02 : Stall Prevention Level During Accel

This parameter determines the actual drive output current level during an acceleration condition. Set in percent of drive rated output current (see Appendix 2). A setting of " 200 " will disable stall prevention during acceleration.

During acceleration, if the output current exceeds the value in **L3-02**, acceleration stops and frequency is maintained. When the output current goes below the value set in **L3-02**, acceleration resumes.

In the constant horsepower region [actual output frequency  $\geq$  max. voltage frequency ( **E1-06** )], the stall prevention level during acceleration is changed by the following formula:

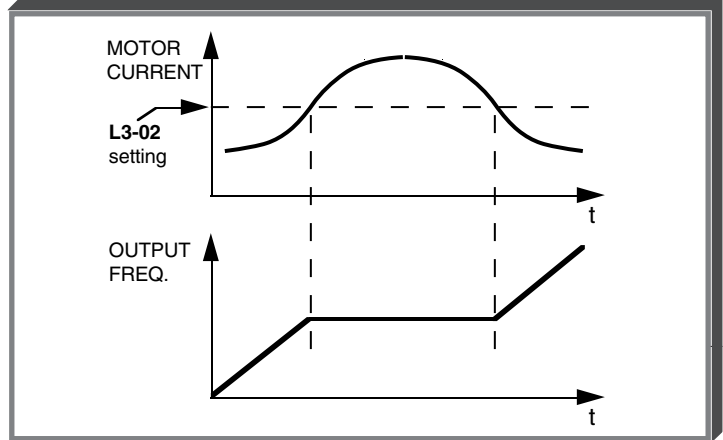

$$\text{Stall prevention level during accel (constant horsepower)} = \text{Stall prevention level during accel (CHP) (L3-03)} \times \frac{\text{Max. voltage frequency}}{\text{Actual output frequency}}$$

#### L3-03 : Stall Prevention Limit During Accel (CHP)

Factory setting: **50**

Range: 0 to 100 %

#### C. L3-05 : Stall Prevention Selection During Running

Factory setting: **1**

Setting	Function
0	Stall prevention during running disabled
1	Stall prevention during running enabled; uses Decel time 1 ( <b>C1-02</b> )
2	Stall prevention during running enabled; uses Decel time 2 ( <b>C1-04</b> )

#### L3-06 : Stall Prevention Level During Running

Factory setting: **160**

Range: 30 to 200 %

This parameter determines the actual drive output current level while operating at set speed (frequency). Set in percent of drive rated output current (see Appendix 2). A setting of " 200 " will disable stall prevention during running.

During running at set speed, if the output current exceeds the value set in **L3-06**, the drive will begin to decelerate. When the output current goes below the value set in **L3-06**, acceleration begins, up to the set frequency.

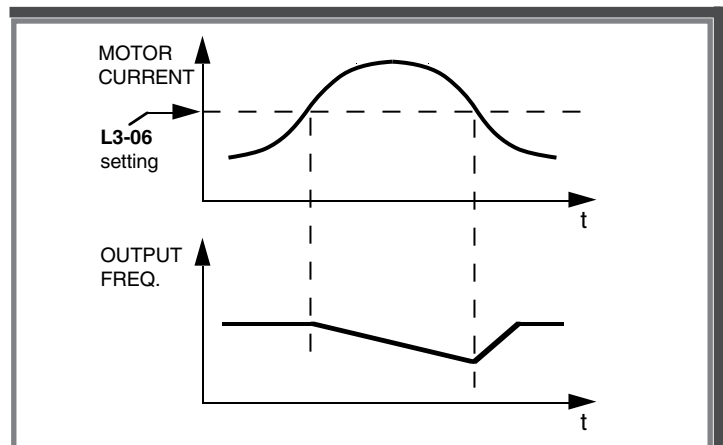

## 5.40 STOPPING METHOD

### b1-03 : Stopping Method Selection

Factory setting: **0**

Range: 0 to 3

Selects the stopping method suitable for the application.

Setting	Description
0	Deceleration (ramp) to stop
1	Coast to stop
2	Full range DC injection to stop
3	Coast to stop with timer

#### A. Data 0 : Deceleration to Stop

Upon removal of the FWD (REV) Run command, the motor decelerates at the deceleration rate determined by the time set in Decel Time 1 ( **C1-02** ), and DC injection braking is applied immediately before stop. If the decel time is too short or the load inertia is too large, an overvoltage ( **OV** ) fault may occur on a stop command — the decel time must be increased.

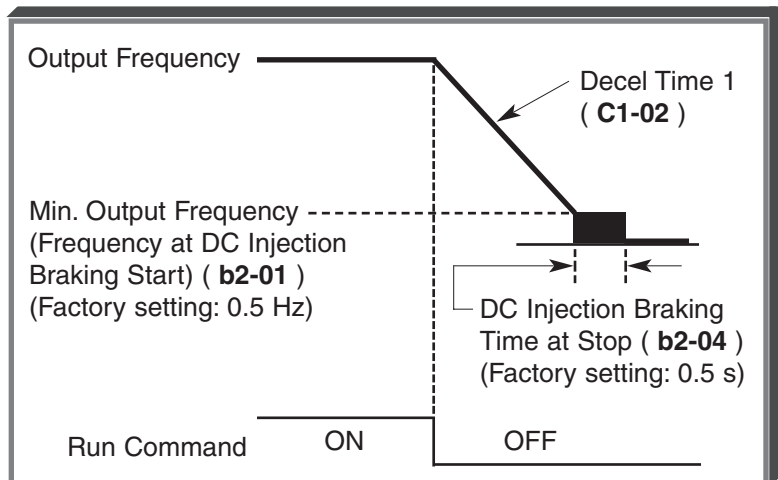

#### B. Data 1 : Coast to Stop

Upon removal of the FWD (REV) Run command, the motor coasts to rest.

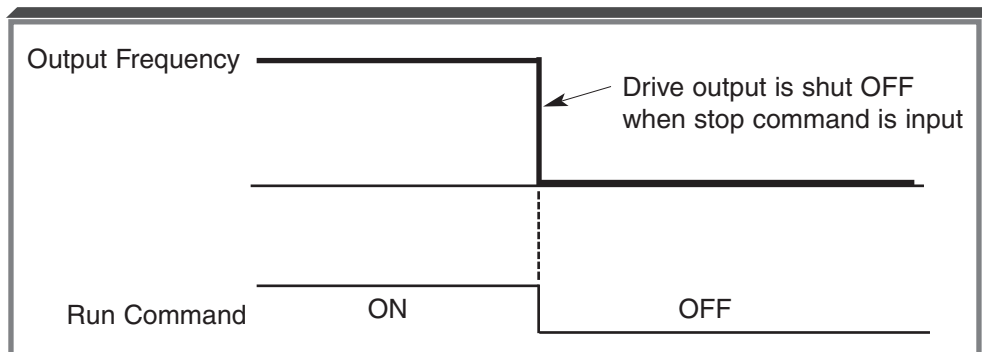

## 5.40 STOPPING METHOD

Continued

### C. Data 2 : Full-range DC Injection Stop

When a STOP command is issued, there is a 0.5 second time delay, before a DC injection current is applied to two phases of the motor's stator winding. The duration of DC braking is a time period proportional to **b2-04** (at 10% output frequency) and the level of output frequency at the time the STOP command is issued.

Braking torque is 50-70% of full load motor torque.

#### EXAMPLE

**b2-04** = 0.5 sec (at 10% output)

Braking time at Fmax (100% output frequency) =  $\frac{100\%}{10\%} \times 0.5 = 5 \text{ sec.}$

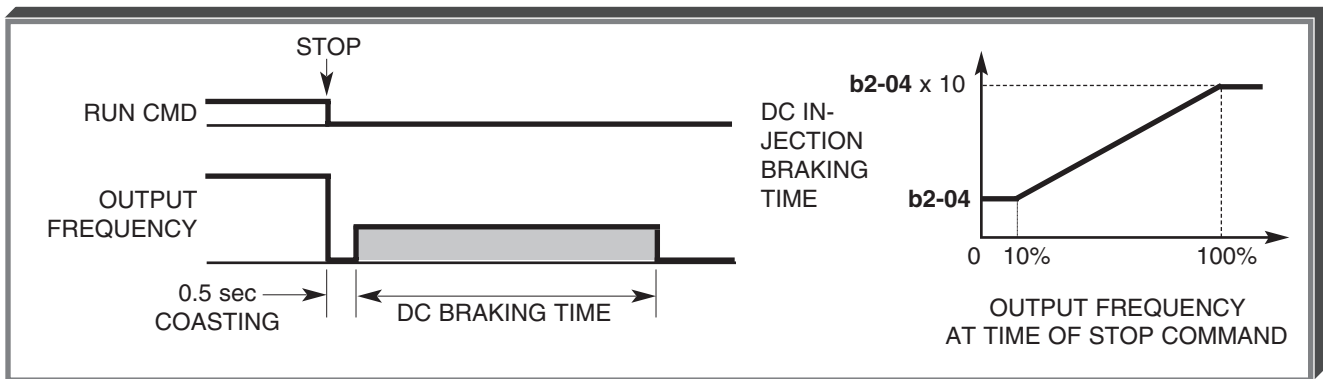

*Full Range DC Injection Braking Stop Sequence*

### D. Data 3 : Coast to Stop With Timer

When programmed for coast to stop with timer, a Run command is ignored if issued during the time the motor would normally be decelerating ( **C1-02** ), or for the minimum base block time ( **L2-03** ), whichever is longer.

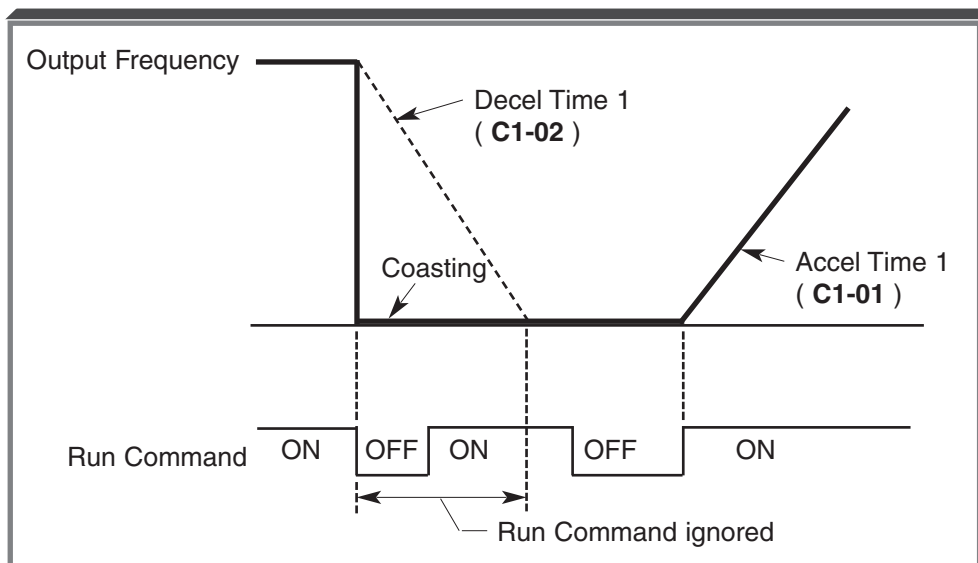



## 5.41 THERMAL OVERLOAD PROTECTION

**E2-01** : Motor Rated Current

Factory setting: *See Table A3-1*

Range: 0.01 to 1500.0 A

This parameter should be set according to the rated current value shown on the motor nameplate; this value must be within 10-120% percent of the *drive rated current* (refer to Specifications in Appendices 2 & 3 of this manual).

**L1-01** : Motor Overload Protection Selection

Factory setting: **1**

Setting	Electronic Thermal Characteristics
0	Electronic thermal overload protection disabled
1	Electronic thermal overload protection enabled

**L1-02** : Motor Overload Protection Time  
Constant

Factory setting: **8.0**

Range: 0.1 to 20.0 min.

This parameter sets the electronic thermal overload relay protection time. Actual overload time can be calculated using the time from the overload characteristics curves then multiplying that time by **L1-02** / 8.

The drive protects against motor overload with a UL-recognized, built-in electronic thermal overload relay.

The electronic thermal overload function monitors motor temperature, based on drive output current and time, to protect the motor from overheating. When the electronic thermal overload relay is enabled, an "**OL1 Motor Overloaded**" fault occurs, shutting OFF the drive output and preventing excessive overheating of the motor.

When operating with one drive connected to only one motor, an external thermal relay is not needed. When operating several motors with one drive, install a thermal overload relay on each motor.

## 5.41 THERMAL OVERLOAD PROTECTION

Continued

E1-02 : Motor Selection

Factory setting: **0**

Range: 0 to 2

Setting	Electronic Thermal Characteristics
0	General-purpose motor (TEFC)
1	Blower cooled or totally enclosed non-ventilated (TEBC or TENV)
2	Vector Motor

This parameter sets whether a general-purpose or a blower-cooled motor is used. The motor overload detection function operates differently, as shown, for each of these two motor types.

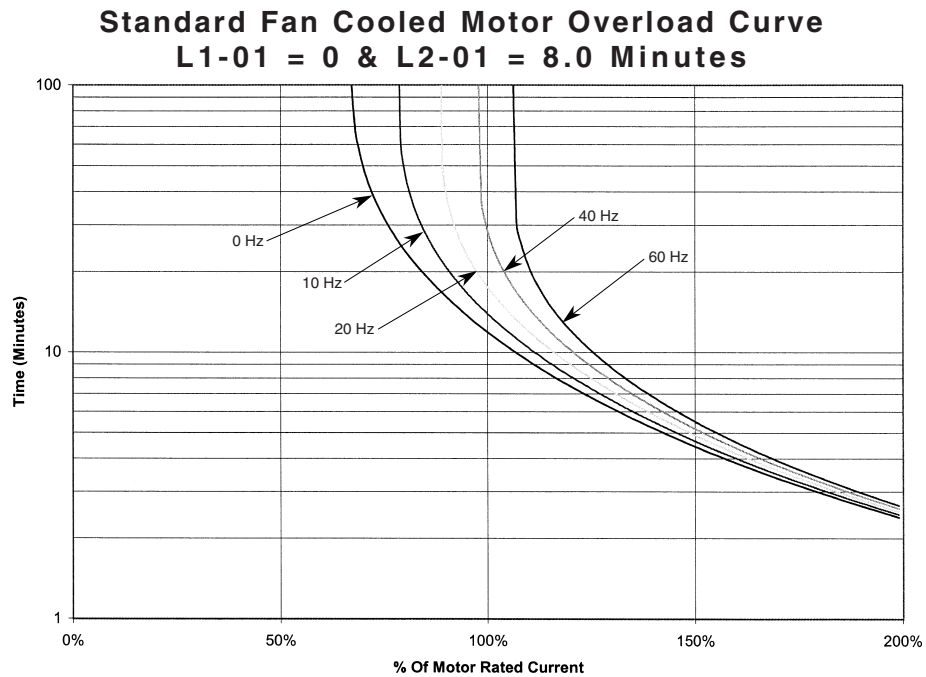

**Standard Blower Cooled Motor Overload Curve  
L1-01 = 1 & L1-02 = 8.0 Minutes**

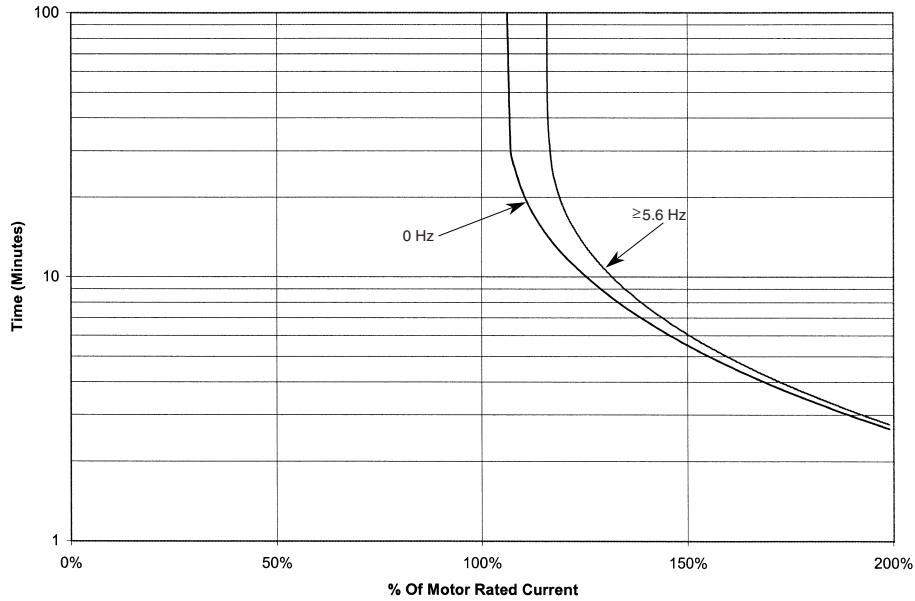

**Vector Motor Overload Curve  
L1-01 = 2 & L1-02 = 8.0 Minutes**

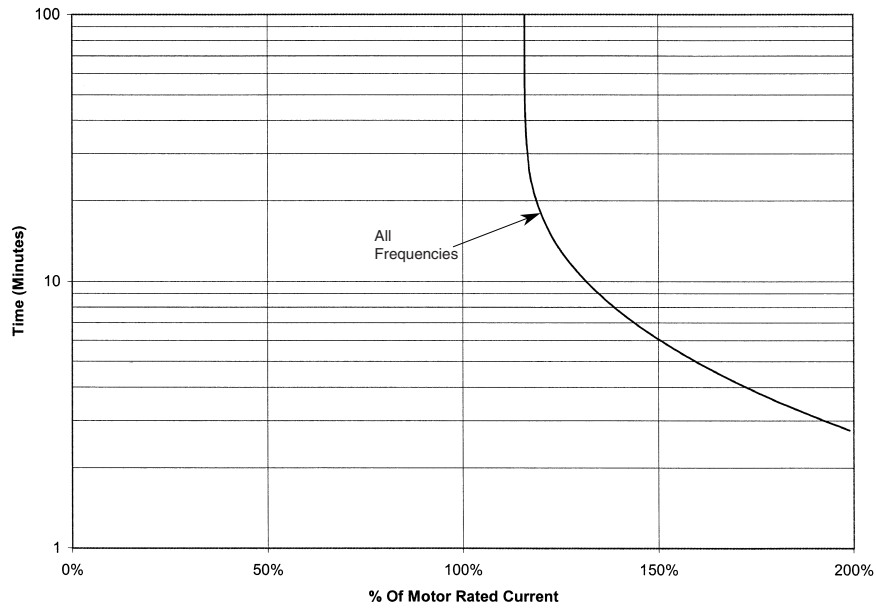

NOTE: If a TEFC motor is going to be run at or near 100% of rated current at frequencies below 30 Hz for an extended period of time, select the blower cooled curve ( **E1-02 = 1** ).

## 5.42 TORQUE COMPENSATION

**C4-02** : Torque Compensation Time Constant

Factory setting: *See Table A3-2*

Range: 0 to 10000 ms

This parameter adjusts a time delay for the torque compensation gain. Increase to add torque stability, decrease to improve torque response.

**C4-01** : Torque Compensation Gain [  $K_T$  ]

Factory setting: **1.00**

Range: 0.00 to 2.50

Sets the torque compensation, in increments of 0.1. When the motor has the same capacity as that of the drive, the gain is 1.0. When a smaller motor is used, the gain should be set to 1.5 (typical).

This parameter, in conjunction with **E2-05** (Motor Line-to-Line Resistance) and **E2-07** & **E2-08** (Motor Iron Core Saturation Coefficient 1 & 2), is used by the drive's automatic torque boost function to match the drive's output voltage boost to the motor load. Except for the most demanding of high starting torque applications, the factory settings of these parameters will be adequate. The factory settings are programmed to match the performance characteristics of typical AC motors.

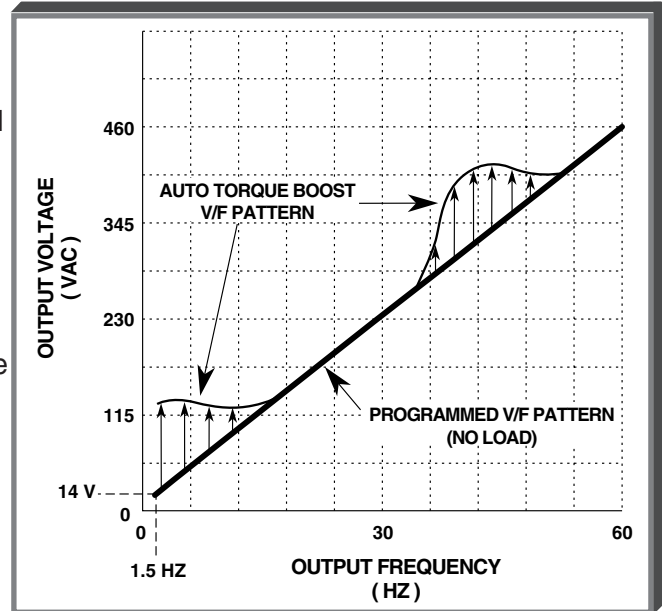

**Example of Torque Compensation Operation**

The calculation of compensated torque uses the following formula:

$$\text{Compensated Value} \approx \frac{(\sqrt{3} \cdot V_{ac} \cdot I_{ac} \cdot \cos \Phi) - W_I - R_{cable}}{\text{Frequency}} \times K_T$$

Where

\*  $W_I$  = **E2-07, E2-08**

$R_{cable}$  = **E2-05**

$K_T$  = **C4-01**

$\Phi$  = Power Factor (calculated by the drive)

\* Adjusted by Auto-tune feature.

**5.42 TORQUE COMPENSATION**

Continued

<b>C4-03</b> : Forward Torque Compensation At Start (Open Loop Vector Only)	Factory setting: <b>0.0</b>
	Range: 0.0 to 200.0 %
<b>C4-04</b> : Reverse Torque Compensation At Start (Open Loop Vector Only)	Factory setting: <b>0.0</b>
	Range: -200.0 to 0.0 %
<b>C4-05</b> : Torque Compensation At Start Time Constant (Open Loop Vector Only)	Factory setting: <b>10</b>
	Range: 0 to 200 ms

Parameters **C4-03** thru **C4-05** help to improve the starting / breakaway torque response when using the open loop vector control method (**A1-02 = 2**). The amount of torque applied at start when a forward run is commanded is set by parameter **C4-03**. The amount of torque applied at start when a reverse run is commanded is set by parameter **C4-04**. The amount of time that the torque is applied is controlled by parameter **C4-05**.

## 5.43 TORQUE CONTROL (COMMAND)

NOTE: This function can only be used in Flux Vector control method ( **A1-02** = 3 ).

One of two methods may be used to run the drive in torque control.

**A1.** Torque control can be set by programming parameter **d5-01** .

**d5-01** : Torque Control Selection

Factory setting: **0**

Setting	Control Method
0	Speed Control
1	Torque Control

**OR**

**A2.** Torque control can be set by programming a multi-function input terminal for Speed / Torque Control Selection (Data **7 1** ). The drive will be in torque control when the corresponding input terminal is closed. This selection can be delayed by programming **d5-06** for a delay time.

**H1-01** thru **H1-06** : Multi-function Input  
(Term. 3 thru 8)

Data **7 1** : Speed / Torque  
Control Selection

**d5-06** : Speed/Torque Control Selection Timer

Factory setting: **0**

Range: 0 to 100 ms

**B.** Regardless of which way torque control is selected, the torque reference will be input to the drive at terminals 16 & 17 (Multi-function analog input).

**H3-05** : Multi-function Analog Input  
(Term. 16)

Data **1 3** : Torque  
Reference

The scaling (with factory defaults for gain & bias) is 10V on terminal 16 = 100% of the motor rated torque.

### 5.43 TORQUE CONTROL (COMMAND)

Continued

C. **d5-03** : Speed Limit Selection

Factory setting: **1**

Range: 1 or 2

**d5-04** : Speed Limit

Factory setting: **0**

Range: -120 to +120 %

When setting the drive for torque control, a speed limit is required. This speed limit can come from either a programmed value ( **d5-04** ), or an analog input (Term. 13 or 14).

d5-03 Setting	Speed Limit Source	Programming Required
1	Analog Input (Term. 13 or 14)	Reference source needs to be set for terminals ( <b>b1-01</b> = 1 ) AND the drive needs to be set for "Remote" reference (REF light on the Digital Operator needs to be on). <b>and</b> <b>d5-03</b> (Speed Limit Selection) must be set to "Analog Input".
2	Programmed Value ( <b>d5-04</b> )	<b>d5-04</b> is set as a percentage of the maximum frequency. (NOTE: this value can be set to a negative value by pressing the "up arrow" or "down arrow" keys while the left-most zero is flashing on the Digital Operator display). <b>and</b> <b>d5-03</b> (Speed Limit Selection) must be set to "Program Setting".

D. Torque compensation can be utilized by programming terminal 14 for Torque Compensation ( **H3-09** = 14). The analog voltage present on terminal 14 will determine torque compensation value.

E. **d5-02** : Torque Reference Delay Time

Factory setting: **0**

Range: 0 to 1000 ms

This function is used to avoid excessive changes in torque, which may be caused by abnormal resonance when the torque reference changes rapidly.

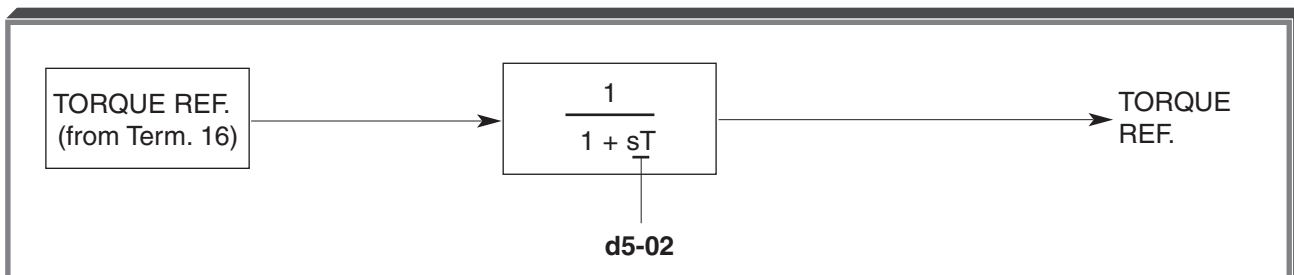

F. **d5-05** : Speed Limit Bias

Factory setting: **10**

Range: 0 to 120 %

Sets bias value for speed limit (torque control mode only) as a percentage of maximum frequency.

## 5.43 TORQUE CONTROL (COMMAND)

Continued

### G. Simplified block diagram:

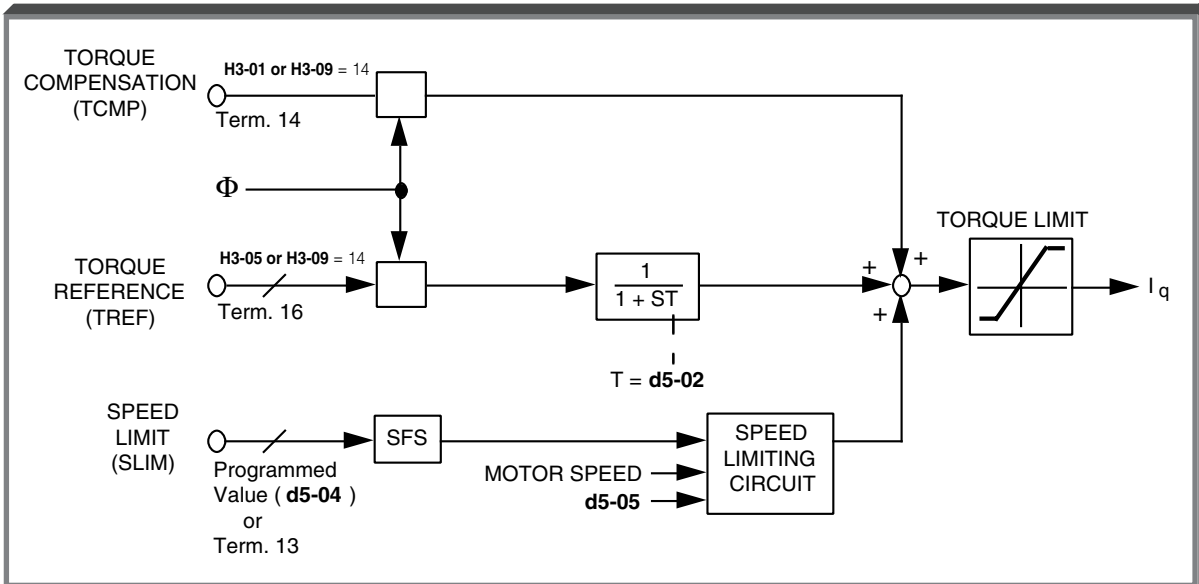

The figure below shows the relationship between speed, speed limit, torque, and torque limit.

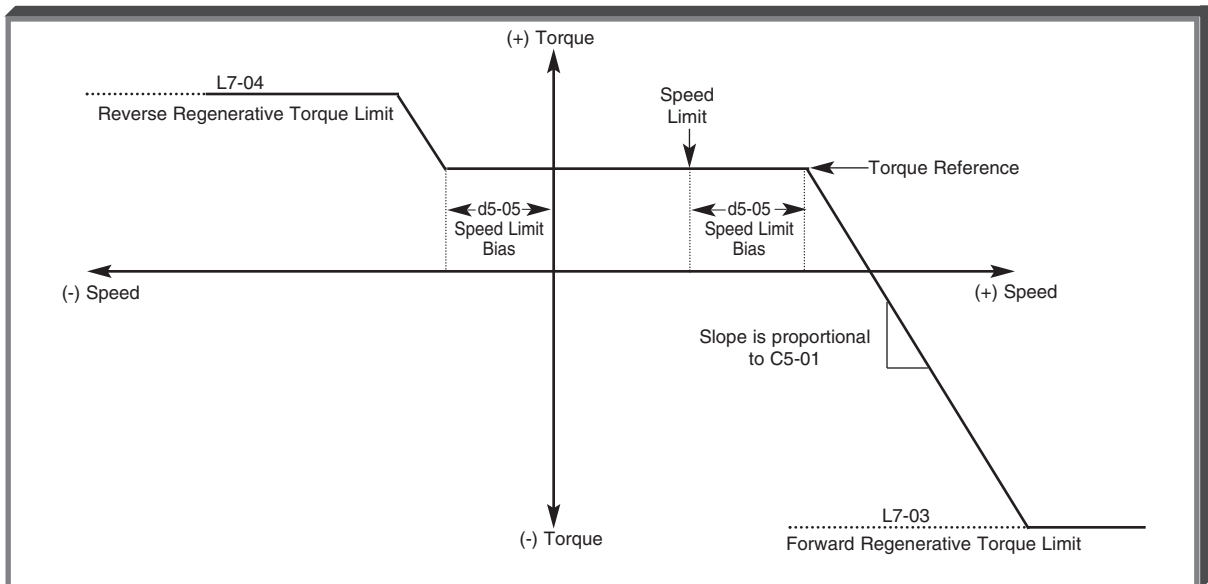



## 5.44 TORQUE DETECTION

Torque detection is used to compare drive rated output current with the overtorque detection level. When the output current is equal to or greater than the defined level, an overtorque condition exists. This will be indicated as an " **OL3** " fault on the Digital Operator. This feature can be selected to operate over a wide range of conditions.

- A. **L6-01** : Torque Detection Selection 1  
**L6-04** : Torque Detection Selection 2

Factory setting (each): <b>0</b>
----------------------------------

These parameters determine whether the torque detection function of the drive is enabled, under what conditions it will detect for overtorque, and what operation it will perform after detecting an overtorque.

Setting	Torque Detection	Operation After Overtorque Detection	Detection Condition
0	Disabled	—	—
1	Enabled	Continues	Only at set frequency
2	Enabled	Continues	At all times except during stopping or DC injection braking
3	Enabled	Coast to stop	Only at set frequency
4	Enabled	Coast to stop	At all times except during stopping or DC injection braking

- For overtorque detection during accel or decel, set to " 2 " or " 4 ".
- For continuous operation after overtorque detection, set to " 1 " or " 2 ". During detection, the Digital Operator displays and " **OL3** " alarm (blinking).
- To stop the drive at an overtorque detection fault, set to " 3 " or " 4 ". At detection, the Digital Operator displays an " **OL3** " fault.

- B. **L6-02** : Overtorque Detection Level 1  
**L6-05** : Overtorque Detection Level 2

Factory setting (each): <b>150</b>
------------------------------------

Range (each): 0 to 300 %
--------------------------

These are the reference points for determining that an overtorque condition exists. Set as a percent of drive rated current (see Appendix 2).

- C. **L6-03** : Overtorque Detection Time 1  
**L6-06** : Overtorque Detection Time 2

Factory setting (each): <b>0.1</b>
------------------------------------

Range (each): 0.0 to 10.0 seconds
-----------------------------------

Determines how long an overtorque condition must exist before another event will occur, e.g. coast to stop, multi-function output change of state, or " **OL3** " warning or fault display.

## 5.44 TORQUE DETECTION Continued

### D. H3-05 : Multi-function Analog Input (Term. 16)

Data 7 : External Overtorque  
Detection Level Adjustment

The multi-function analog input at terminal 16 may be configured to allow analog control of the overtorque detection level. When this function is programmed into **H3-05**, the internal overtorque detection level (**L6-02**) is disabled.

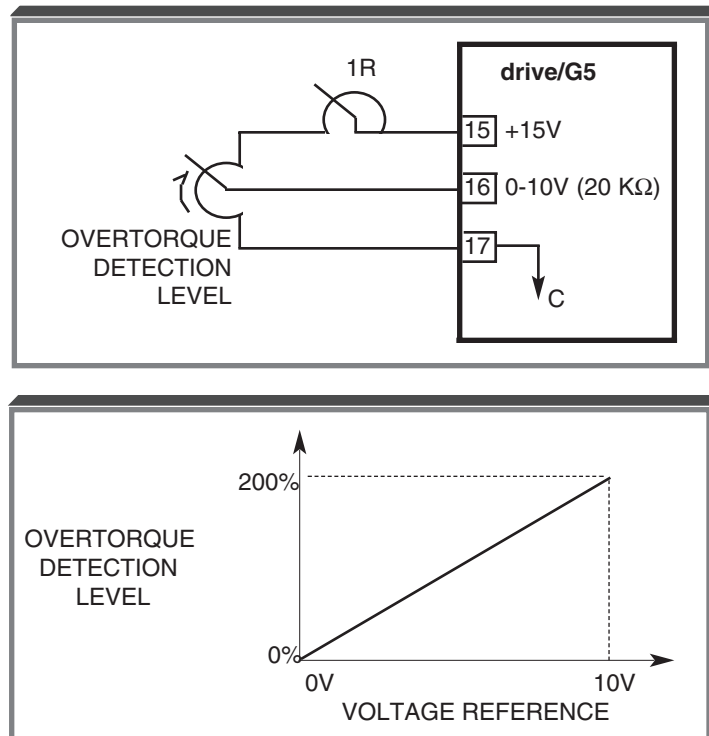

### E. H2-01 : Multi-function Output (Term. 9 & 10) H2-02 : Multi-function Output (Term. 25-27) H2-03 : Multi-function Output (Term. 26-27)

Data B : Overtorque  
Detection

A contact, or two open collector outputs, can be programmed to change states during an overtorque detection condition.

## 5.44 TORQUE DETECTION

Continued

### EXAMPLE OF OVERTORQUE DETECTION

- L6-01** setting: **2** — Detect during run, energize multi-function output, display alarm  
**L6-02** setting: **110 %** — Level at which torque detection is sensed  
**L6-03** setting: **1.0 s** — Time delay before overtorque event occurs  
**H2-01** setting: **B** — "Torque Detection 1" multi-function output (normally open)

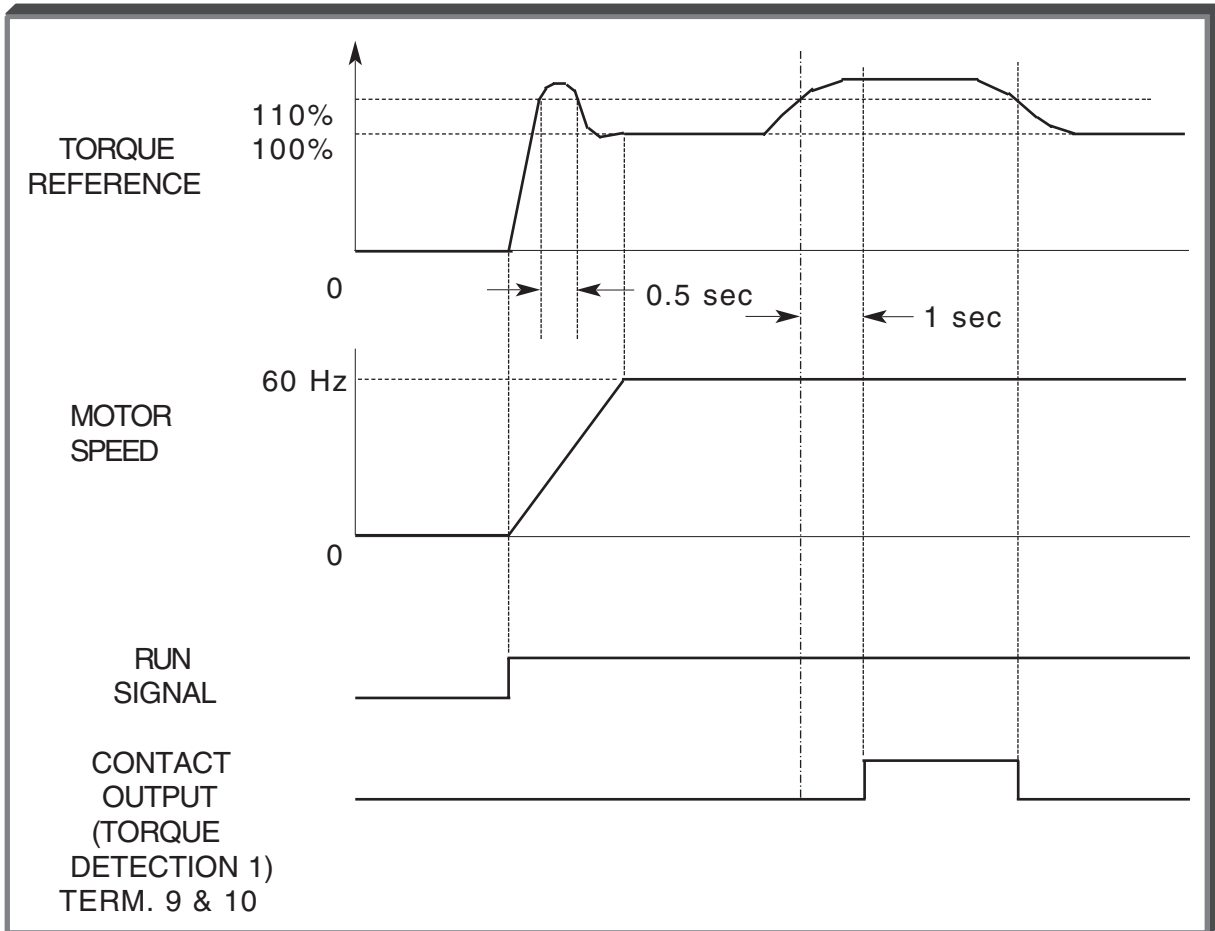

*Torque Detection Timing Diagram*

## 5.45 TORQUE LIMIT

- A. **L7-01** : Forward Torque Limit  
**L7-02** : Reverse Torque Limit  
**L7-03** : Forward Regenerative Torque Limit  
**L7-04** : Reverse Regenerative Torque Limit

Factory setting (each): **200**

Range (each): 0 to 300 %

These parameters provide the ability to limit the amount of torque produced by the motor in all four quadrants of operation: FWD motoring, REV motoring, FWD regen, and REV regen. The torque limit functions as a torque current reference limit. Torque limit is active in both speed mode and torque mode.

### EXAMPLE:

- L7-01** Forward Torque Limit = **150 %**  
**L7-02** Reverse Torque Limit = **150 %**  
**L7-03** Forward Regenerative Torque Limit = **20 %**  
**L7-04** Reverse Regenerative Torque Limit = **20 %**

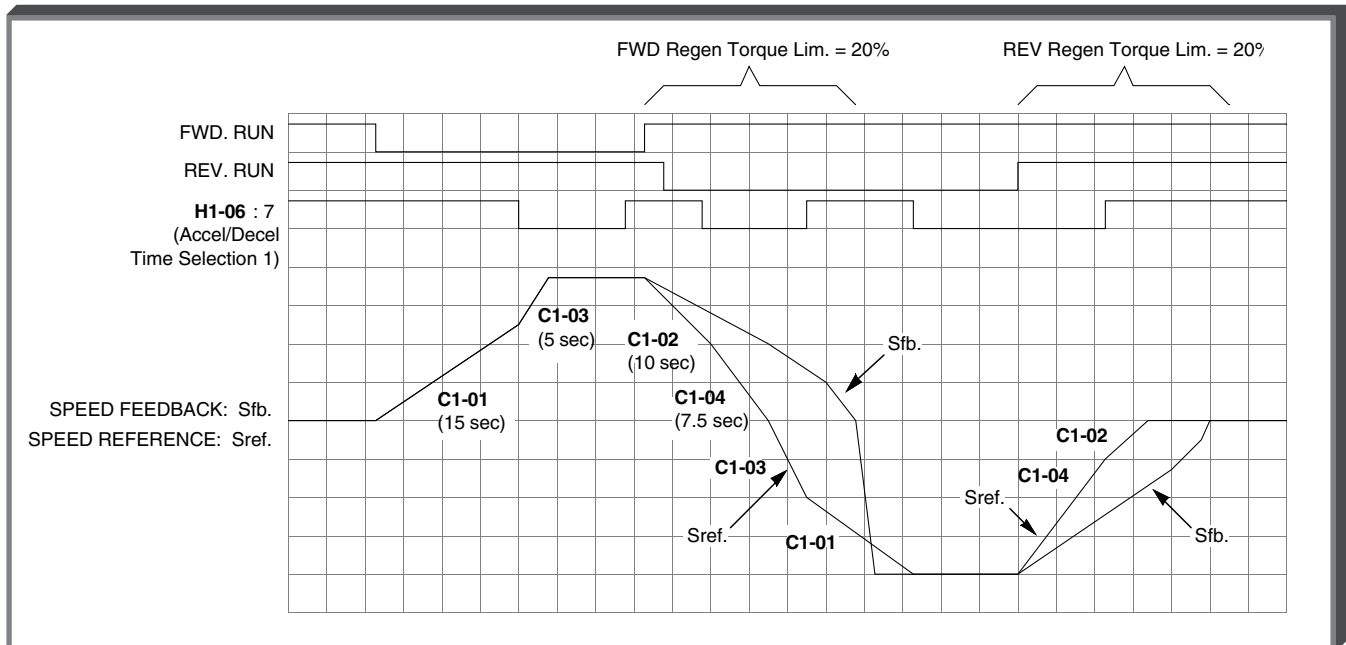

During regeneration, the regeneration torque limits have been exceeded, thus the actual speed (Sfb) doesn't follow the speed reference (Sref). This example also demonstrates the accel/decel selection 1 ( **H1-06** data **7** ).

## 5.45 TORQUE LIMIT

Continued

### B. H3-05 : Multi-function Analog Input 1 Selection (Term. 16)

Data 1 0 : FWD Torque Limit

The multi-function analog input at terminal 16 may be configured to allow analog control of the torque limit for both FWD & REV modes. However, the analog reference controls both FWD torque limit & REV regen torque limit.

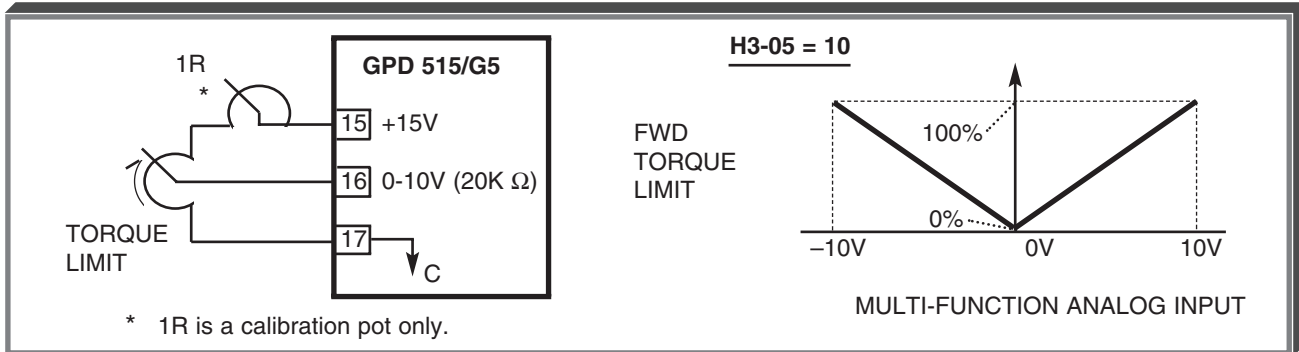

NOTE: A minimum priority circuit is associated with the torque limit function, which means that the lowest value torque limit setting will have priority.

#### EXAMPLE:

Forward Torque Limit  $L7-01 = 80\%$   
FWD Torque Limit (Term. 16) = 100% (10V)

The  $L7-01$  value will have priority over the analog reference value.

Data 1 1 : REV Torque Limit

The multi-function analog input at terminal 16 may be configured to allow analog control of the torque limit for both FWD & REV modes. However, the analog reference controls both REV torque limit & FWD regen torque limit.

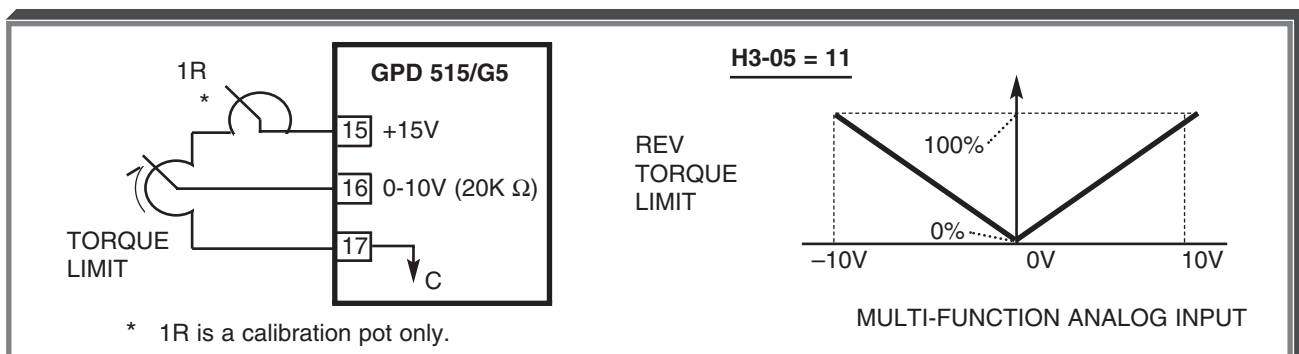

NOTE: A minimum priority circuit is associated with the torque limit function, which means that the lowest value torque limit setting will have priority.

## 5.45 TORQUE LIMIT

Continued

### Data 1 2 : Regenerative Torque Limit

The multi-function analog input at terminal 16 may be configured to allow analog control of the torque limit for both FWD & REV modes. However, the analog reference controls both FWD torque limit & REV regenerative torque limits.

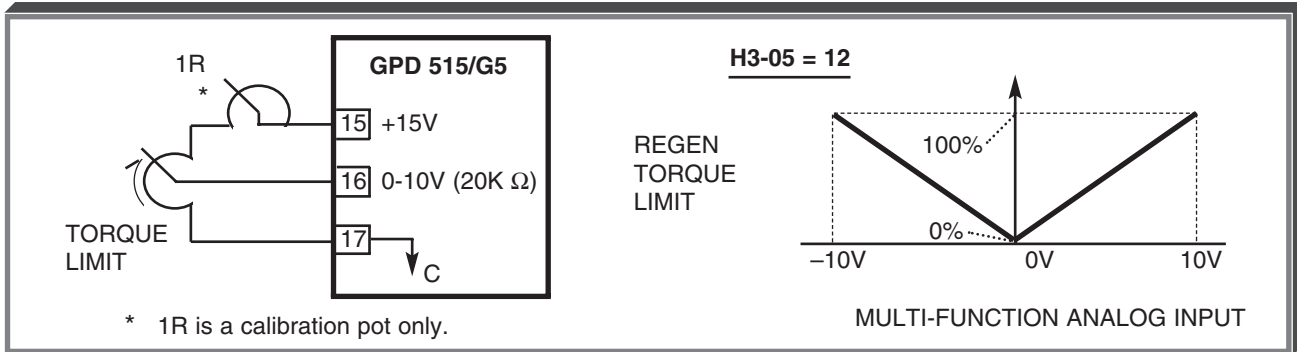

NOTE: A minimum priority circuit is associated with the torque limit function, which means that the lowest value torque limit setting will have priority.

### Data 1 3 \* : FWD & REV Torque Limit

\* NOTE: When **H3-05** is set for "1 3", Terminal 16 is a torque limit ONLY if speed mode is selected (**d5-01** = 0). If **d5-01** = 1 (torque mode), Terminal 16 will be a torque reference.

### Data 1 5 : FWD & REV Torque Limit

The multi-function analog input at terminal 16 may be configured to allow analog control of the torque limit for both FWD & REV modes. However, the analog reference controls both FWD & REV torque limits, and the FWD & REV regenerative torque limits.

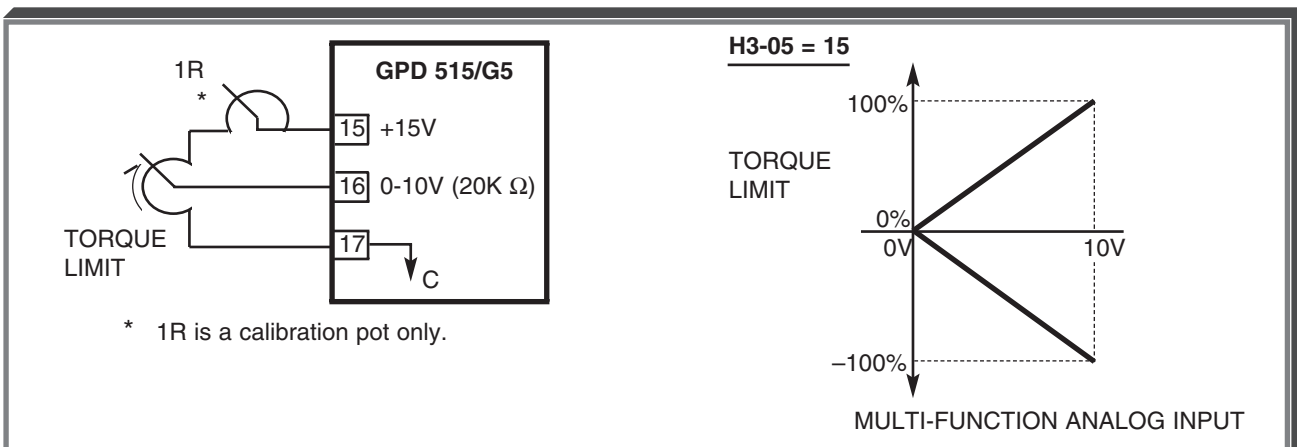

NOTE: A minimum priority circuit is associated with the torque limit function, which means that the lowest value torque limit setting will have priority.

## 5.45.1 TWO MOTOR OPERATION

**E3-01:** Control Method Selection (Motor 2)

Factory setting : **2**

Range : 0 to 4

Setting	Description
0	V/f control
1	V/f with PG feedback
2	Open loop vector
3	Flux vector

Parameter	Description	Factory Settings		
		230V Ratings	460V Ratings	600V Ratings
<b>E4-01</b>	Maximum Output Frequency (Motor 2)	60.0 Hz	60.0 Hz	60.0 Hz
<b>E4-02</b>	Maximum Voltage (Motor 2)	230.0 V	460.0 V	575.0 V
<b>E4-03</b>	Base Frequency (Motor 2)	60.0 Hz	60.0 Hz	60.0 Hz
<b>E4-04</b>	Mid. Output Frequency (Motor 2)	3.0 Hz	3.0 Hz	3.0 Hz
<b>E4-05</b>	Mid. Output Voltage (Motor 2)	12.6 V	25.3 V	36.6 V
<b>E4-06</b>	Min. Output Frequency (Motor 2)	0.5 Hz	0.5 Hz	0.5 Hz
<b>E4-07</b>	Min. Output Voltage (Motor 2)	2.3 V	4.6 V	6.5 V

These seven parameters define the V/f pattern for motor 2. The illustration below shows how these parameters relate to each other in establishing the V/f pattern.

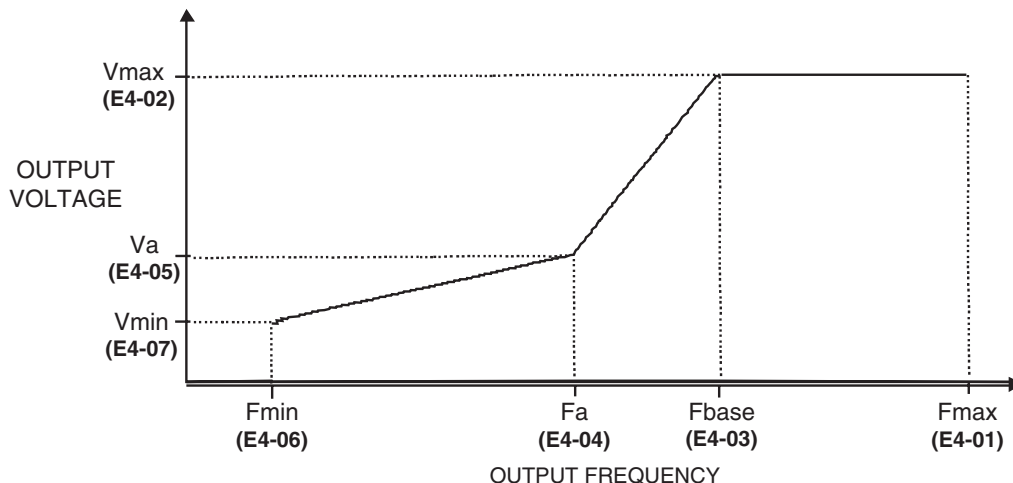

Parameter **E3-01** determines which control method the drive will use when motor 2 is selected. If **E3-01** is set to a 2 or a 3, the second motor needs to be auto-tuned. First select motor 2 (via a multi-function input) then run the auto-tuning routine as described in Section 2.2A or 2.2B. Parameters **E4-01** thru **E4-07** and **E5-01** thru **E5-06** are set when an auto-tune is executed on motor 2. If auto-tuning is not possible, use section 2.4 and the table below to manually calculate and enter the motor parameters.

Parameter	Description	Set by Auto-Tune?	Equivalent Motor 1 Parameter
<b>E5-01</b>	Motor Rated Current (Motor 2)	Yes	<b>E2-01</b>
<b>E5-02</b>	Motor Rated Slip (Motor 2)	Yes	<b>E2-02</b>
<b>E5-03</b>	Motor No-load Current (Motor 2)	Yes	<b>E2-03</b>
<b>E5-04</b>	Number of Motor Poles (Motor 2)	Yes	<b>E2-04</b>
<b>E5-05</b>	Motor Line-to-line Resistance (Motor 2)	Yes	<b>E2-05</b>
<b>E5-06</b>	Motor Leakage Inductance (Motor 2)	Yes	<b>E2-06</b>

## 5.45.1 TWO MOTOR OPERATION

Continued

**H1-01 thru H1-06** : Multi-function Inputs  
(Term. 3 thru 8)

Data **1 6** : Motor 2 Select

This function allows the drive to control two different motors at different times. When a multi-function input is set to a data of "16", two different sets of motor parameters can be selected with a contact closure.

Multi-Function Input Term.	Control Method Setting Parameter	V/f Pattern Parameters	Motor Parameters
Open (Motor 1)	<b>A1-02</b>	<b>E1-04 thru E1-13</b>	<b>E2-01 thru E2-09</b>
Closed (Motor 2)	<b>E3-01</b>	<b>E4-01 thru E4-07</b>	<b>E5-01 thru E5-06</b>

The table above illustrates which parameters are used when motor 1 or motor 2 is selected.

The drive needs to be in the stop condition before the multi-function input is opened or closed, otherwise a "Motor Running" warning will be displayed.

**H2-01 thru H2-03** : Multi-function Outputs  
(Term. 9 & 10, 25, 26, & 27)

Data **1 C** : Motor 2 Selected

When a multi-function output terminal is programmed to a data of "1C", that output will close whenever motor 2 is selected. As shown in the example below, a multi-function input selects between motor 1 and motor 2. The multi-function output will only change states when the drive is in the stopped condition in order to prevent internal drive damage.

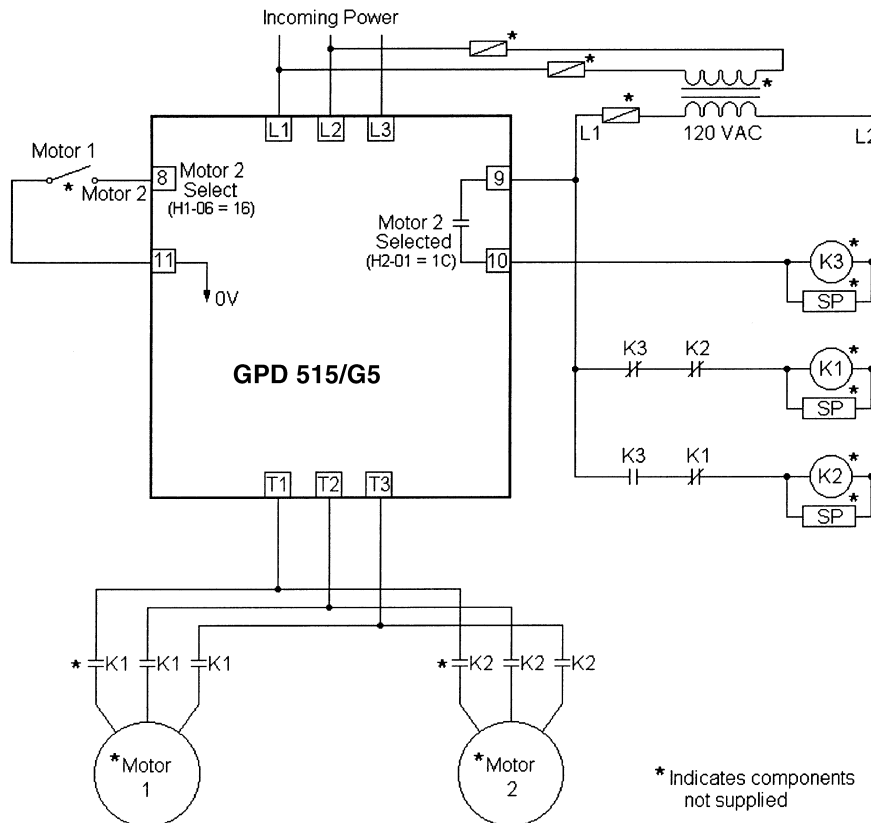



## 5.46 USER PARAMETERS

### A2-01 thru A2-32 : User Select Parameters

Data: Programmable  
(see below)

This function allows the user to select an exclusive list of parameters, providing a customized access level.

When the Access Level ( **A1-01** ) is set to "Advanced", the "Function A2 User Constants" option will appear in the top level of the menu. The parameters desired for custom access are entered into **A2-XX** parameters.

After any parameters have been programmed, the "User Program" option appears in the choice of Access Levels. Choosing this option will allow only those parameters programmed in **A2-XX** to be accessed in "Programming". Up to 32 parameters may be programmed. To add parameters to or delete parameters from **A2-XX**, change the Access Level back to Advanced.

### o2-03 : User Parameter Default Value

Factory setting: 0

Range: 0 to 2

Setting	Description
0	Disabled
1	Set Default
2	Clears all

This parameter is used to store settings as initialization values. Set all parameters to the user-defined default values, then set **o2-03** to "1"; each changed parameter value is then accepted and stored as its initialization value. Up to 50 parameters may have data stored as their new (user-defined) initialization value.

"User Initialize" becomes available in the Initialize Parameter option ( **A1-03** ). Setting this parameter to "1110" resets all settings to the user-defined defaults, rather than to factory defaults.

## 5.47 V/f PATTERN - STANDARD

### E1-03 : V/f Pattern Selection

This parameter is factory preset to " F ". Table 5-4 describes 14 other preset patterns, one of which may be better suited for your specific application and load characteristics. However, if none of these patterns are suitable, this parameter can be set to " F " (V/f pattern - custom). The exact pattern is then defined by the settings of **E1-04** thru **E1-10**, described in paragraph 5.48, V/f Pattern – Custom.

**Table 5-4. Standard (Preset) V/f Patterns**

APPLI-CATION	SPECIFICATION	E1-03 DATA	V/f PATTERN (NOTE 3)	APPLI-CATION	SPECIFICATION	E1-03 DATA	V/f PATTERN (NOTE 3)
G P E U N R E P R O A S L E	50Hz	0		H I G H T O R Q U E  S T A R T I N G	50Hz Starting Torque Low	8	
	60Hz Saturation	1			50Hz Starting Torque High	9	
	50Hz Saturation	2			60Hz Starting Torque Low	A	
					60Hz Starting Torque High	B	
	72Hz	3		C O N S T A N T  H O R S E P O W E R	90Hz	C	
V T A R I A B L E *	50Hz	Variable Torque 1			120Hz	D	
		Variable Torque 2					
	60Hz	Variable Torque 1		180Hz	E		
		Variable Torque 2					7

NOTES:

- \* Consult Yaskawa for assistance when these settings are desired (typically used for blowers, centrifugal pumps, and fans).
- 1. The following conditions must be considered when selecting a V/f pattern:
  - Pattern matches the voltage-frequency characteristics of the motor.
  - Maximum motor speed.
- 2. V/f pattern for high starting torque should be selected for:
  - Wiring distance.
  - Large voltage drop at start.
  - AC reactor connected to drive input or output.
  - Use of motor rated below drive max. output.
- 3. Patterns shown are for 230V input; for other input, multiply all (V) values by  $(V_{IN}/230)$ . i.e., for 460V input, multiply by  $460/230 = 2$ . For 575V input, multiply by  $\frac{575}{230} = 2.5$

## 5.48 V/f PATTERN - CUSTOM

### A. E1-01 : Input Voltage Setting

Factory Setting: **230, 460 or 575 V**

Range: 155 to 255 V (230V ratings)  
 310 to 510 V (460V ratings)  
 445 to 733 V (600V ratings)

This parameter should be set to match the rated (nominal) input voltage.

### B. E1-04 : Maximum Output Frequency

E1-05 : Maximum Voltage . . . . .

E1-06 : Base Frequency

E1-07 : Mid. Output Frequency A

E1-08 : Mid. Output Voltage A . . . . .

E1-09 : Min. Output Frequency

E1-10 : Min. Output Voltage . . . . .

E1-11 : Mid. Output Frequency B

E1-12 : Mid. Output Voltage B . . . . .

E1-13 : Base Voltage . . . . .

	Initial Voltage Values		
	230V RATINGS	460V RATINGS	600V RATINGS
E1-05	230.0 V	460.0 V	575.0 V
E1-08	12.6 V	25.3 V	36.6 V
E1-10	2.3 V	4.6 V	6.5 V
E1-12	0.0 V	0.0 V	0.0 V
E1-13	0.0 V	0.0 V	0.0 V

These ten parameters define the custom V/f pattern, **only if E1-03 is set to "F"** (see paragraph 5.47). The illustration below shows how these constants relate to each other in establishing the custom V/f pattern.

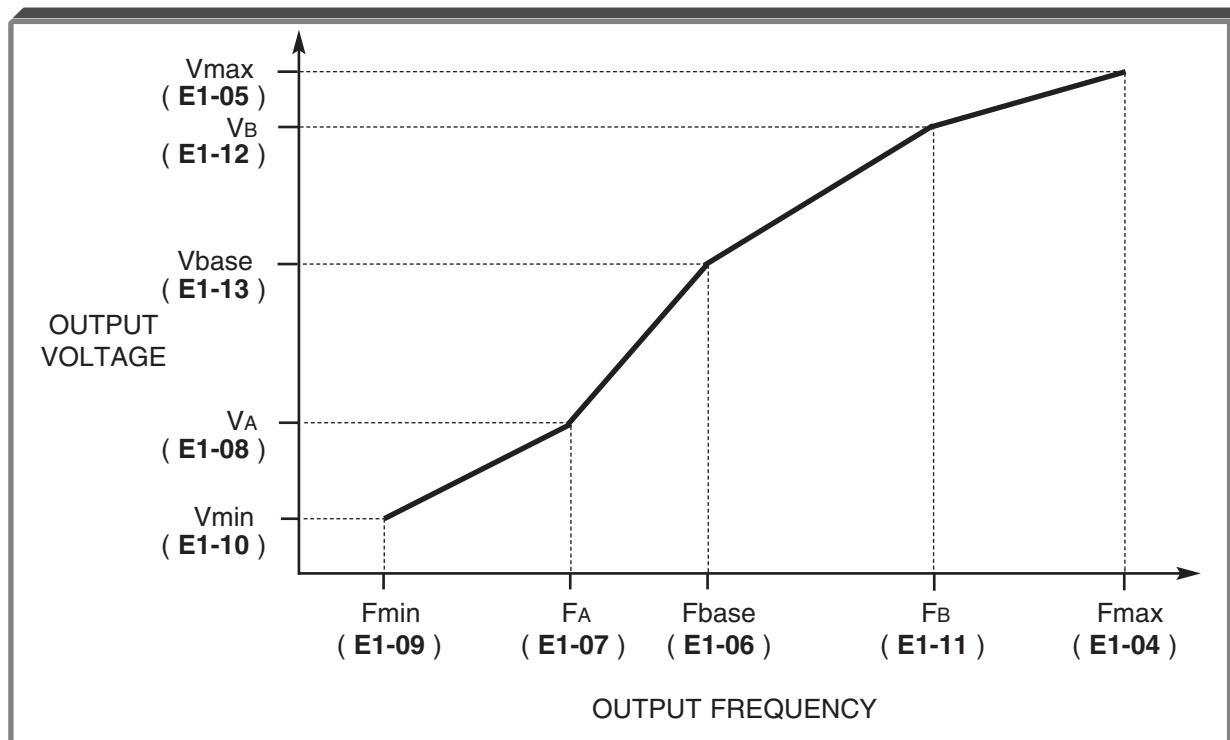

**V/f Characteristics Set by E1-04 thru E1-10**

**5.48 V/f PATTERN - CUSTOM**

Continued

NOTE: To establish a V/f pattern with a straight line from Fmin to Fbase, set  $F_A = F_{min}$ ,  $F_B = 0.0$  Hz, and  $V_{base} = 0.0$  V. The settings of  $V_A$ ,  $V_B$  and  $V_{base}$  are then disregarded and do not affect the V/f pattern.

**IMPORTANT**

The parameter settings are checked whenever power is applied to the drive, or each time the **ENTER** key is pressed while in the Program mode. A parameter set value failure ( **OPE5** ) will occur if any part of the following relationship among **E1-04** thru **E1-13** is not TRUE:

$$F_{max} \geq F_B \geq F_{base} \geq F_A \geq F_{min} \text{ (unless } F_A \text{ or } F_B = 0.0)$$

## 5.49 ZERO-SERVO CONTROL

NOTE: This function can only be used in Flux Vector control method ( **A1-02** = 3 ).

**A. H1-01** thru **H1-06** : Multi-function Input  
(Term. 3 thru 8)

Data **72** : Zero Servo Command  
(for Speed control mode only)

By programming data " 72 " into one of the multi-function input parameters ( **H1-01** thru **H1-06** ), one of the multi-function input terminals (3 thru 8) becomes a zero-servo control selection input. When the input terminal (i.e. external contact) is open, the zero-servo function is disabled, and when the contact is closed, the zero-servo function is enabled.

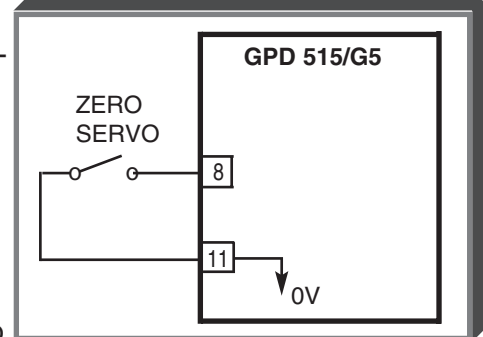

The purpose of the zero-servo function is to provide position control capability at zero speed. When zero-servo is enabled, and the actual speed is less than the DC Injection Start Frequency ( **b2-01** ), the shaft position is maintained by monitoring the PG feedback pulses, and correcting the position error. However, this function doesn't have the same capabilities of a position controller, because there is no marker pulse feedback. Therefore, it will not stop in the same position every time the servo function is enabled.

### CAUTION

**Applications that require decelerating large inertia loads in very short decel times may cause overshoots, and a possible runaway condition, causing equipment damage. Adjustment of zero-servo gain ( b9-01) may be required. Setting b9-01 to " 0 " may correct a runaway condition.**

**b2-01** : DC Injection Braking Start Frequency

Factory setting: **0.5**

Range: 0.0 to 10.0 Hz

The speed level at which the zero-servo function is enabled is determined by **b2-01** (DC Injection Braking Start Frequency), and the closure of the multi-function input. This function also determines operation at zero speed.

**5.49 ZERO-SERVO CONTROL**

Continued

**B. b9-01 : Zero-Servo Gain**Factory setting: **5**

Range: 0 to 100

This function provides an adjustment for the position loop gain.

**CAUTION**

**The higher the gain, the better the response. However, too high a gain can cause hunting or overshoot, and possible runaway condition.**

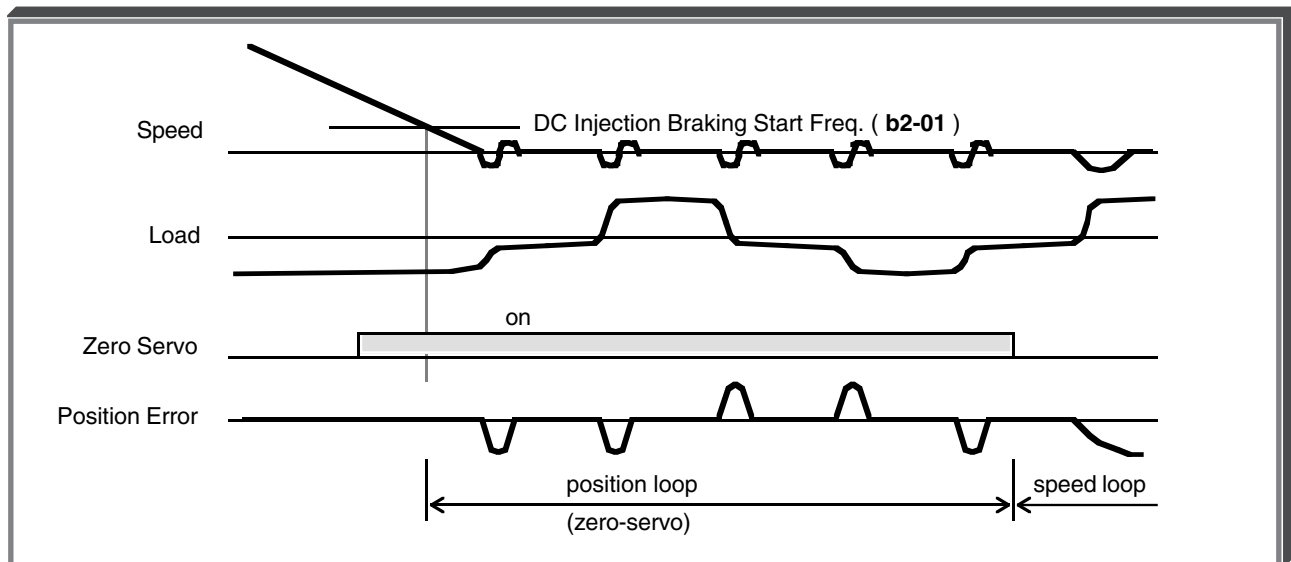
**Zero-Servo Timing****C. b9-02 : Zero-Servo Completion Width**Factory setting: **10**

Range: 0 to 16383 pulses

**H2-01 thru H2-03 : Multi-function Output**  
(Term. 9 & 10; 25; 26)

**Data 33 : Zero-Servo**  
**Completed**

(See paragraph 5.33)

The function of **b9-02** is to set the number of pulses used for the multi-function output terminals. During zero-servo, the multi-function output will be closed (ON) until the number set into **b9-02** has been completed. After the number of pulses have been completed, the multi-function output changes to the open (OFF) state.

## 5.50 ZERO SPEED CONTROL

NOTE: This function can only be used in Flux Vector control method ( **A1-02 = 3** ).

### A. **b1-05** : Zero Speed Operation

Factory setting: **0**

Range: 0 to 3

The setting of this parameter determines which Zero Speed mode is enabled (see figures on following pages).

Setting	Description
0	Run at Frequency Reference
1	STOP
2	Run at Minimum Frequency
3	Run at Zero RPM

### **E1-09** : Minimum Output Frequency

Factory setting: **0.0 \***

Range: 0.0 to 400.0 Hz

\* Note: If control method is anything other than Flux Vector ( **A1-02 = 3** ), the Factory Setting is **0.5**

This parameter sets the speed reference level at which Zero Speed mode operation will activate, in accordance with the selection programmed in **b1-05** (see figures on following pages).

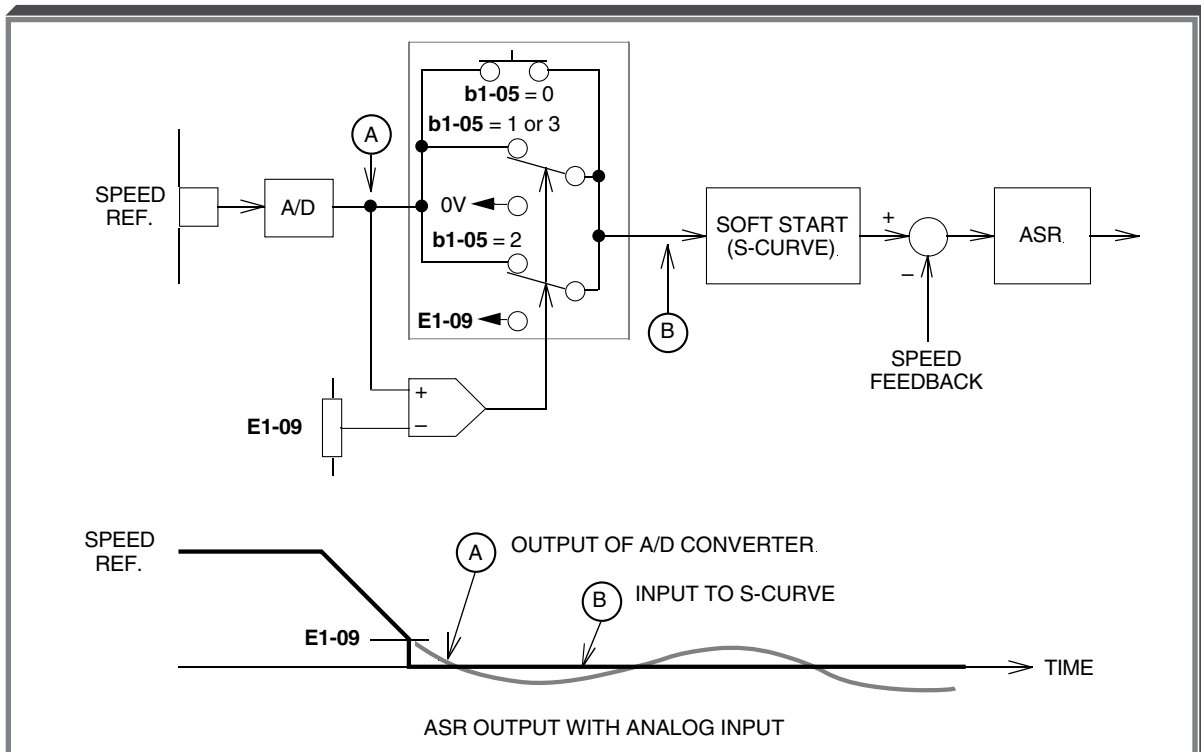

When the Speed Reference input is an analog signal, Zero Speed mode operation over long periods of time will cause the output to drift.

**5.50 ZERO SPEED CONTROL**

Continued

**b1-05 : 0** Run at Frequency Reference

**E1-09 :** (Minimum Output Frequency) ineffective

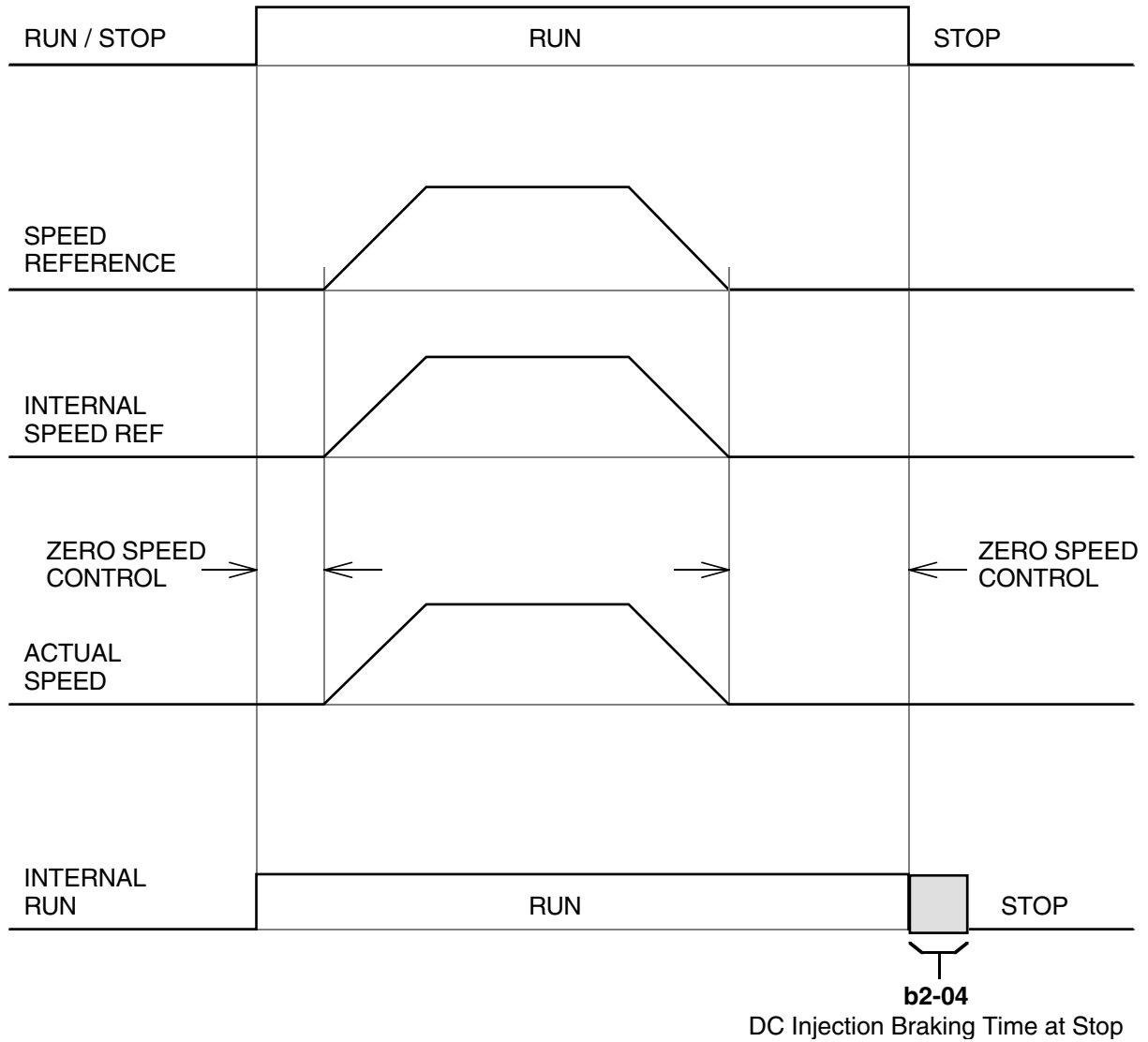

**b1-05 : 1** STOP

**E1-09 :** (Minimum Output Frequency) effective





**5.50 ZERO SPEED CONTROL** Continued

**b1-05 : 2** Run at Minimum Frequency

**E1-09 :** (Minimum Output Frequency) effective

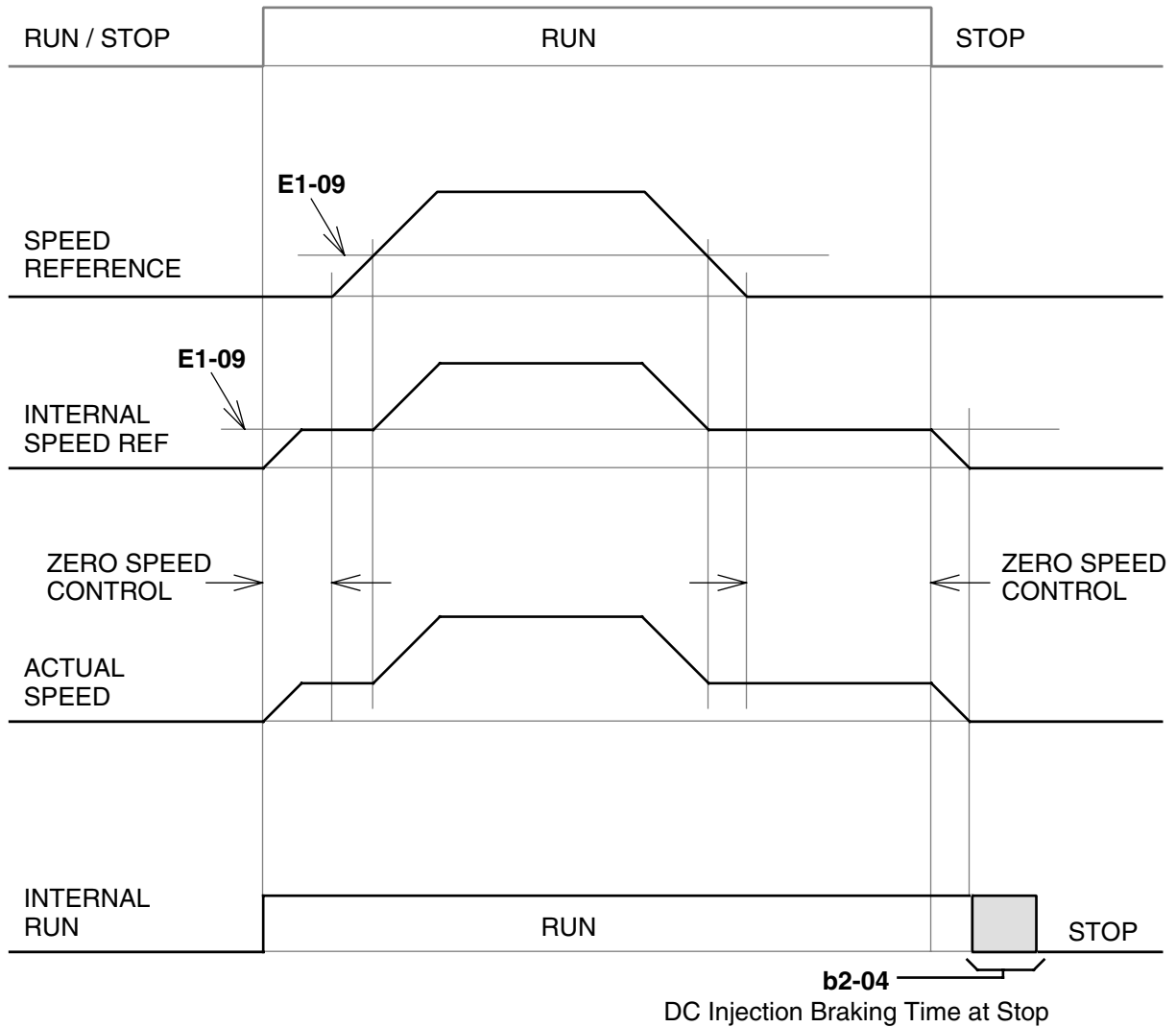

**5.50 ZERO SPEED CONTROL**

Continued

**b1-05 : 3** Run at Zero RPM

**E1-09 :** (Minimum Output Frequency) effective

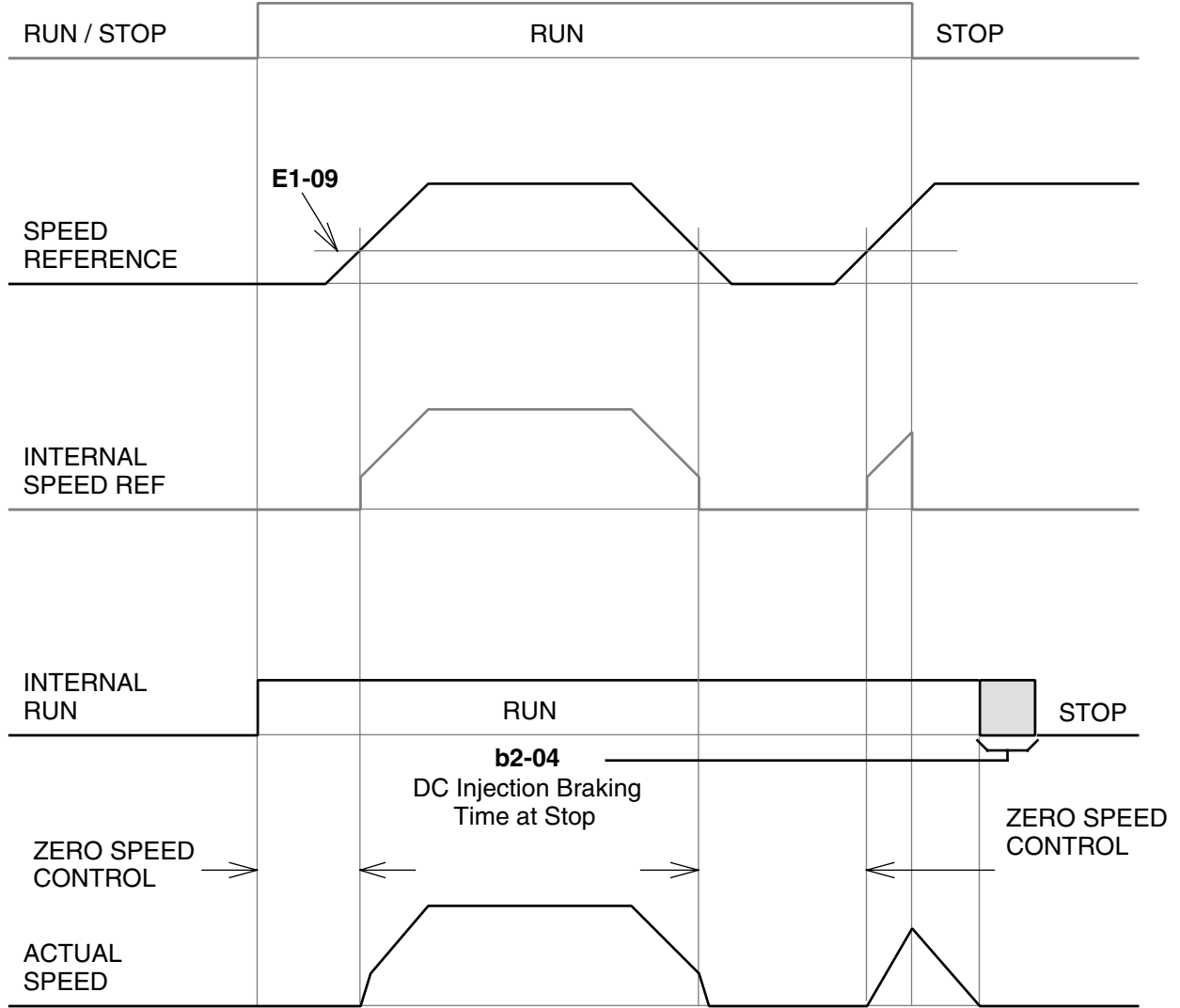

# Section 6. FAULT INDICATION & TROUBLESHOOTING

## 6.1 GENERAL

A failure in the GPD 515/G5 can fall into one of two categories, Alarm or Fault.

A blinking "Alarm" indication is a warning that a drive trouble condition will soon occur, or that a programming error has been made. The drive will continue to operate during an "Alarm" indication.

A blinking "Minor Fault" indication is displayed during less serious faults, or when a problem exists in the external circuitry. The drive will continue to operate, and a "Minor Fault" contact will be closed if a multi-function output is programmed for the condition.

A steady "Major Fault" indication is displayed when the drive's Fault relay has tripped. The motor coasts to a stop, and a fault signal output is present at control circuit terminals 18 - 20.

**Table 6-1. Fault Indication and Details**

DIGITAL OPERATOR DISPLAY	DESCRIPTION	DETAILS	TYPE (Note 1)
BUS Option Com Err	Communication Option Card error	Communication error while drive is set for Run Command and/or Frequency Reference from Serial Communication card.	<b>A</b> (Note 2)
CALL Serial Com Call	SI-B communication error	Control data was not received when power supply was turned on.	<b>A</b>
CE Memobus Com Err	Communication error	Control data was not received for 2 seconds after initial communication.	<b>M</b>
CF Out of Control	Motor out of control	Drive cannot determine speed of motor – Open Loop Vector Control Method ( <b>A1-02</b> = 2) only. (Note 3)	<b>M</b>
CPF00 COM-ERR (OP & INV)	Control circuit fault 1	Communication between Digital Operator and drive was not established within 5 seconds after power was applied, or an internal hardware or software fault was detected on power-up. (Note 3)	<b>M</b>
CPF01 COM-ERR (OP & INV)	Control circuit fault 2	Communication errors between the Digital Operator and drive occurred for over 2 seconds after communication was last established, or an internal hardware or software fault occurred after power-up. (Note 3)	<b>M</b>

**Table 6-1. Fault Indication and Details – Continued**

DIGITAL OPERATOR DISPLAY	DESCRIPTION	DETAILS	TYPE (Note 1)
CPF02 BB Circuit Failure	Baseblock circuit fault	Drive failure. (Note 3) Replace Control card.	<b>M</b>
CPF03 EPROM Error	EPROM fault		
CPF04 Internal A/D Err	Internal A/D fault		
CPF05 External A/D Err	External A/D fault		
CPF06 Option Error	Option card connection failure	Check option card connection. Option card failure. (Note 3)	<b>M</b>
CPF20 Option A/D Error	A/D converter fault in Analog Speed Reference card	Option card (AI-14B) A/D converter malfunction. (Note 3)	<b>M</b>
CPF21 Option CPU down	Communication option card self-diagnostic error.	Communication option card failure.	<b>M</b>
CPF22 Option Type Err	Communication option card Model code error.		
CPF23 Option DPRAM Err	Communication option card DPRAM error.		
DEV Speed Deviation	Speed deviation	Deviation between speed reference and speed feedback exceeded the deviation level ( <b>F1-10</b> & <b>F1-11</b> ). Stop mode selection possible ( <b>F1-04</b> ).	<b>m</b> (Note2)
E - 15 SI - F/G Com Err	SI - F/G Communications Error	A communications error occurred and <b>b1-01=3</b> and/or <b>b1-02=3</b> .	<b>M</b> (Note2)
EF External Fault	Both FWD and REV commands were applied simultaneously	Drive is in “temporary” Ramp to Stop condition; one input command must be removed to resume operation.	<b>m</b>
EF0 Opt External Flt	External fault input from Communication option card.	Check communication option card connection and signal.	<b>M</b> (Note 2)
EF3 External Fault 3	External fault signal at terminal 3	A fault condition has occurred in the external circuit(s) monitored by the contact providing input to the indicated terminal. Stop mode selection possible ( <b>H1-01</b> thru <b>H1-06</b> ) (See Section 5.17) (Note 3)	<b>M</b> (Note 2)
EF4 External Fault 4	External fault signal at terminal 4		

**Table 6-1. Fault Indication and Details – Continued**

DIGITAL OPERATOR DISPLAY	DESCRIPTION	DETAILS	TYPE (Note 1)
EF5 External Fault 5	External fault signal at terminal 5	A fault condition has occurred in the external circuit(s) monitored by the contact providing input to the indicated terminal.	<b>M</b> (Note 2)
EF6 External Fault 6	External fault signal at terminal 6	Stop mode selection possible ( <b>H1-01</b> thru <b>H1-06</b> ). (See Section 5.17)	
EF7 External Fault 7	External fault signal at terminal 7	(Note 3)	
EF8 External Fault 8	External fault signal at terminal 8		
E-10 SI-F / G CPU Down	SI-F / G Communications Error	A communications error occurred and <b>b1-03 = 3</b> and/or <b>b1-02 = 3</b> .	<b>M</b> (Note 2)
ERR EPROM R/W Err	EPROM write-in fault	drive failure. Cycle power, then attempt to initialize. Replace Control card.	<b>m</b>
FbL Feedback Loss	PID Feedback Reference Loss	PID feedback reference loss detection is enabled ( <b>b5-12 = 1</b> or <b>2</b> ) and the PID feedback input is less than the PID feedback loss detection level ( <b>b5-13</b> ) for longer than the PID feedback loss detection time ( <b>b5-14</b> ).	<b>m</b> (Note 2)
GF Ground Fault	Ground fault	Drive output ground current exceeded 50% of driverated current.	<b>M</b>
LF Output Pha Loss	Drive output has open phase	Problem in drive-to-motor wiring. Enable/disable with <b>L8-07</b> .	<b>M</b>
OC Overcurrent	Overcurrent	Drive output current exceeded 200% of drive rated current. (Note 3)	<b>M</b>
OH Heatsnk Overtemp	Cooling fin overheat	Heatsink fin temperature exceeded the setting of <b>L8-02</b> . (Note 3)	<b>m</b> (Note 2)
OH1 Heatsnk MAX Temp	Drive overheat	Heatsink fin temperature exceeded 105°C (221°F) (Note 3), or internal cooling fan has failed.	<b>M</b>
OH2 Over Heat 2	Drive overheat Pre-alarm	A multi-function input ( <b>H1-01</b> to <b>H1-06</b> ) is programmed for OH2 Alarm Signal (data “B”) and the corresponding input terminal is closed.	<b>A</b>
OL1 Motor Overloaded	Motor overload	Protects the motor. Motor thermal overload protection has tripped. <b>L1-02</b> has been exceeded (initial value: 150% for 60 sec.). (Note 3)	<b>M</b>

**Table 6-1. Fault Indication and Details – Continued**

DIGITAL OPERATOR DISPLAY	DESCRIPTION	DETAILS	TYPE (Note 1)
OL2 Inv Overloaded	Drive overload	Protects the drive. Drive overload protection has tripped.	<b>M</b>
OL3 Overtorque Det 1	Overtorque detect 1	Output current exceeds Overtorque Detection Level 1 ( <b>L6-02</b> ).	(Note 2)
OL4 Overtorque Det 2	Overtorque detect 2	Output current exceeds Overtorque Detection Level 2 ( <b>L6-05</b> ).	(Note 2)
OPE01 kVA Selection	Drive capacity selection fault	<b>o2-04</b> has been changed from the correct factory setting value. Refer to Table A3-1.	<b>A</b>
OPE02 Limit	Parameter set out of range	One or more parameter values are not within the allowable setting range.	<b>A</b>
OPE03 Terminal	Multi-function input setting fault	<b>H1-01</b> thru <b>H1-06</b> (multi-function input)-2 or more parameters are set to the same data (other than " F " and " FF "). See paragraph 5.32.	<b>A</b>
OPE05 Sequence Select	Option card selection error	Frequency reference and/or run source is set for option card ( <b>b1-01=3</b> and/or <b>b1-02=3</b> ), but no option card is connected.	<b>A</b>
OPE06 PG Opt Missing	PG-X2 card not installed	Control method set to Flux Vector or V/F with PG, and no PG-X2 card is installed.	<b>A</b>
OPE07 Analog Selection	Multi-function analog input selection error	Both multi-function analog inputs ( <b>H3-05</b> and <b>H3-09</b> ) have been programmed for the same data (except 1F) OR an AI-14B option card is connected, the drive is programmed for 3-channel individual ( <b>F2-01=0</b> ), and a multi-function input is programmed for Option/Inverter Selection ( <b>H1-01</b> to <b>H1-06=2</b> ).	<b>A</b>
OPE08 Terminal	Selection Parameter error	A parameter has been changed that is not available in the present Control Method. Example: <b>H1-08=72</b> (Zero Servo Command) is set while the drive is in Flux Vector Control ( <b>A1-02=3</b> ), then the Control Method is changed to Open Loop Vector ( <b>A1-02=2</b> ).	<b>A</b>
OPE10 V/F Ptrn Setting	V/f data setting fault	Occurs when the custom V/f pattern does not meet the following criteria: ( <b>E1-04</b> ) ≥ ( <b>E1-06</b> ) > ( <b>E1-07</b> ) ≥ ( <b>E1-09</b> )	<b>A</b>
OPE11 CarrFrq/ON-Delay	Carrier frequency parameter(s) set out of range	Occurs when the carrier frequency parameters are set as follows: ( <b>C6-01</b> ) > 5 kHz and ( <b>C6-02</b> ) ≤ 5 kHz; ( <b>C6-03</b> ) > 6 and ( <b>C6-01</b> ) < ( <b>C6-02</b> )	<b>A</b>
OPR Oper Disconnect	Operator disconnected	Digital Operator has been disconnected from drive while in Run mode.	<b>M</b> (Note 2)

**Table 6-1. Fault Indication and Details – Continued**

DIGITAL OPERATOR DISPLAY	DESCRIPTION	DETAILS	TYPE (Note 1)
OS Overspeed	Motor overspeed	Motor speed exceeds overspeed level ( <b>F1-08</b> & <b>F1-09</b> ). Stop mode selection possible ( <b>F1-03</b> ). (Note 3)	<b>M</b> (Note 2)
OV DC Bus Overvolt	Overvoltage	Detection level: Approx. 400VDC for 230V rated unit; Approx. 800V for 460VDC rated unit; approx 1050 VDC for 600V rated unit. (Note 3)	<b>M</b>
PF Input Pha Loss	drive input phase missing	Incoming power supply has an open phase, or a large imbalance exists between L1, L2 & L3.Enable/disable with <b>L8-05</b> .	<b>M</b>
PGO PG Open	PG cable wires are disconnected	Pulse generator is disconnected from the PG-X2 card (Terminal TA1).	<b>M</b> (Note 2)
PUF DC Bus Fuse Open	Fuse blown	DC fuse has cleared. Check for short circuit in output circuitry. (Note 3)	<b>M</b>
RH DynBrk Resistor	Braking resistor overheat	Braking resistor unit temperature exceeds the allowable value. (Heatsink-mount resistor only, and only if <b>L8-01</b> =1).	<b>M</b>
RR DynBrk Transistor	Braking transistor failure	Braking transistor failure.	<b>M</b>
SC Short Circuit	Short circuit on drive output terminals	Very low impedance on output of drive. Check for correct motor wiring / capacity.	<b>M</b>
SVE Zero Servo Fault	Zero Servo fault	Shaft position changed by more than 500,000 revolutions during zero servo operation.	<b>M</b>
UV DC Bus Undervolt	Momentary power loss	Low voltage has been detected, but momentary power loss ride-thru is enabled ( <b>L2-01</b> ), and momentary power loss ride-thru time ( <b>L2-02</b> ) has not yet been exceeded. (Note 3)	<b>m</b>
UV1 DC Bus Undervolt	Main circuit undervoltage	Occurs 2 seconds after detection of low voltage. Detection level: approx 190VDC for 230V rated unit; approx 380VDC for 460V rated unit; approx 546 VDC for 600V rated unit. (Note 3)	<b>A</b>
UV2 CTL PS Undervolt	Control circuit undervoltage	Control circuit voltage is low during operation.	<b>A</b>
UV3 MC Answerback	Main contactor fault	Main circuit magnetic contactor (soft charge contactor) does not operate correctly.	<b>A</b>

**NOTES:**

1. **A** = Alarm; **m** = Minor Fault; **M** = Major Fault.
2. The stop mode, and therefore the fault type (alarm, minor or major), is selectable.
3. See section 6.4 for flowcharts to use in troubleshooting these fault conditions.



## 6.2 AUTO-TUNING FAULTS & CORRECTIVE ACTIONS

DIGITAL OPERATOR DISPLAY	DESCRIPTION	CORRECTIVE ACTION
Tune Aborted Data Invalid	Motor data is not correct	<ul style="list-style-type: none"> <li>Check the input data.</li> <li>Check the drive and motor capacities.</li> </ul>
Tune Aborted Resistance	Line-to-line resistance not within tolerance	<ul style="list-style-type: none"> <li>Check the input data.</li> <li>Check the motor wiring.</li> </ul>
Tune Aborted No-Load Current	No-load current (magnetizing current) not within tolerance	
Tune Aborted Sat Coef 1	Iron core saturation coefficient 1 not within tolerance	
Tune Aborted Sat Coef 2	Iron core saturation coefficient 2 not within tolerance	
Tune Aborted Rated Slip	Rated slip not within tolerance	
Tune Aborted Accelerate	Motor did not accelerate in the specified time	<ul style="list-style-type: none"> <li>Increase acceleration time ( <b>C1-01</b> ).</li> <li>Increase torque limit values ( <b>L7-01</b> , <b>-02</b> ) if they are reduced from factory settings.</li> <li>Uncouple the motor from the load.</li> </ul>
Tune Aborted PG Direction	Encoder phasing opposite that of motor phasing	<ul style="list-style-type: none"> <li>Swap two motor leads.</li> </ul> <p style="text-align: center;"><b>OR</b></p> <ul style="list-style-type: none"> <li>Swap channels on the input to the PG-X2 card (on terminal block TA1, swap wires at terminals 4 &amp; 6 and swap wires at terminals 5 &amp; 7).</li> </ul>
Tune Aborted Motor Speed	Torque reference exceeded 100% during auto-tuning	<ul style="list-style-type: none"> <li>Uncouple motor from load.</li> <li>Increase acceleration time ( <b>C1-01</b> ).</li> <li>Check input data, especially the encoder PPR ( <b>F1-01</b> ).</li> </ul>
Tune Aborted Over Load <small>(Displayed after completion of tuning)</small>	Torque reference exceeded 20% during auto-tuning	
Tune Aborted Minor Fault : XXX	A minor drive fault occurred	<ul style="list-style-type: none"> <li>Check Table 6-1 for specific minor fault indicated by "XXX."</li> </ul>
Tune Aborted PG Circuit	PG cable wires are disconnected	<ul style="list-style-type: none"> <li>Pulse generator is disconnected from the PG-X2 card (Terminal TA1). Check PG wiring.</li> </ul>







## 6.3 DISPLAYING FAULTS

### A. Displaying Fault Conditions

Whenever the fault relay trips (drive shutdown), the fault that caused the trip (except for Illegal Constant or Control Function Hardware) is entered into non-volatile RAM. The drive also retains the operating conditions when the fault occurred.

These conditions can only be displayed when the drive is in the Drive mode (DRIVE light is on).

**Table 6-2. Displaying Fault Conditions**

DESCRIPTION	KEY SEQUENCE	DIGITAL OPERATOR DISPLAY (See Note 1)
If a major fault has just occurred, but the drive <b>has not</b> been reset, proceed directly to <b>Step A</b> .		The <b>DRIVE</b> and <b>STOP</b> lights are illuminated, and the <b>FWD</b> , <b>REV</b> , <b>SEQ</b> , & <b>REF</b> lights are flashing.  <div style="border: 1px solid black; border-radius: 10px; padding: 5px; text-align: center;">                     EF3 External Fault 3                 </div>
If the drive <b>has</b> been reset, the conditions at the last fault can still be displayed:  Proceed to <b>Step A</b> .	Press  , then  , then  4 times	<div style="border: 1px solid black; border-radius: 10px; padding: 5px; text-align: center;">Function U2 Fault Trace</div>
	Press 	<div style="border: 1px solid black; border-radius: 10px; padding: 5px; text-align: center;">Current Fault None</div>
<b>Step A</b> Display the frequency reference that was present when the fault occurred.	Press 	<div style="border: 1px solid black; border-radius: 10px; padding: 5px; text-align: center;">Last Fault External Fault 3</div>
	Press 	<div style="border: 1px solid black; border-radius: 10px; padding: 5px; text-align: center;">Frequency Ref U2-03= 10.00 Hz</div>
Display the output frequency that was present when the fault occurred.	Press 	<div style="border: 1px solid black; border-radius: 10px; padding: 5px; text-align: center;">Output Freq U2-04= 10.00 Hz</div>

**Table 6-2. Displaying Fault Conditions – Continued**

DESCRIPTION	KEY SEQUENCE	DIGITAL OPERATOR DISPLAY (See Note 1)
Continue pressing 	to cycle through all of the condition displays. These include: output current, output voltage, DC bus voltage, kWatts, input terminal status, output terminal status, operation status, and elapsed time.	
NOTE: To decode the input terminal status, output terminal status, and operation status displays, refer to Appendix 1, Table A1-10, U1-10 to U1-12.		

NOTES:

- Actual displays will differ depending on the recorded fault and the operating conditions.

If the FWD, REV, SEQ, & REF lights are flashing, enter a RESET command (from the Digital Operator or external signal) to prepare the drive for restart of operation.







**IMPORTANT:** In 2-wire control, any RUN/STOP command must be removed before the RESET will be accepted.

**B. Displaying Fault History**



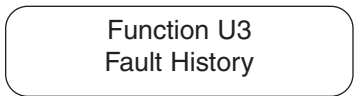

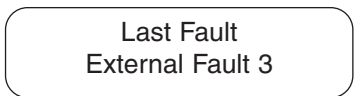

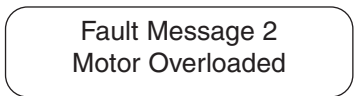
Whenever the fault relay trips (drive shutdown), the fault that caused the trip (except for Illegal Constant or Control Function Hardware) is entered into non-volatile RAM. The drive retains the last four faults and the operating conditions when the last fault occurred. (NOTE: Time is in operating hours.)

These faults can only be displayed when the drive is in the Drive mode (DRIVE light is on). The drive can be stopped or running.

**Table 6-3. Displaying Fault History**

DESCRIPTION	KEY SEQUENCE	DIGITAL OPERATOR DISPLAY (See Note 1)
Display the fault history function menu.	Press  , then  , then  twice	
Display the last fault that occurred (most recent in time)	Press 	
Display the second from the last fault that occurred.	Press 	

**Table 6-3. Displaying Fault History – Continued**

DESCRIPTION	KEY SEQUENCE	DIGITAL OPERATOR DISPLAY (See Note 1)
Display the third from the last fault that occurred.	Press 	<div style="border: 1px solid black; border-radius: 10px; padding: 5px; text-align: center;">                     Fault Message 3 DC Bus Undervolt                 </div>
Display the fourth from the last fault that occurred.	Press 	<div style="border: 1px solid black; border-radius: 10px; padding: 5px; text-align: center;">                     Fault Message 4 None                 </div> <p>NOTE: If less than four faults have occurred since the drive was initialized, "None" will appear on the Digital Operator.</p>
Display the operating hours when the <b>last</b> fault occurred.	Press 	<div style="border: 1px solid black; border-radius: 10px; padding: 5px; text-align: center;">                     Elapsed Time 1 U3-05= 57 H                 </div>
Display the operating hours when the <b>second</b> from the last fault occurred.	Press 	<div style="border: 1px solid black; border-radius: 10px; padding: 5px; text-align: center;">                     Elapsed Time 2 U3-06= 41 H                 </div>
Display the operating hours when the <b>third</b> from the last fault occurred.	Press 	<div style="border: 1px solid black; border-radius: 10px; padding: 5px; text-align: center;">                     Elapsed Time 3 U3-07= 5 H                 </div>
Display the operating hours when the <b>fourth</b> from the last fault occurred.	Press 	<div style="border: 1px solid black; border-radius: 10px; padding: 5px; text-align: center;">                     Elapsed Time 4 U3-08= 0 H                 </div>

NOTES:

1. Actual displays will differ depending on the recorded fault and the operating conditions.

## 6.4 TROUBLESHOOTING FLOWCHARTS

If the drive malfunctions, locate the cause and take corrective action by following the flowcharts given in this section.

### A. TROUBLESHOOTING MOTOR SYMPTOMS

Motor Does Not Rotate .....	Chart 6.1
Motor Stalls During Acceleration.....	Chart 6.2
Motor Does Not Rotate at Set Speed.....	Chart 6.3
Motor Hunting .....	Chart 6.4

### B. TROUBLESHOOTING FOR FAULT CONDITIONS

oV – Overvoltage .....	Chart 6.5
PUF – DC Bus Fuse Open .....	Chart 6.6
oC – Overcurrent .....	Chart 6.7
oL1 – Motor Overload .....	Chart 6.8
UV – Undervoltage .....	Chart 6.9
oH – Heatsink Overtemp .....	Chart 6.10
CPFXX – Control Function Error .....	Chart 6.11
EFX – External Fault .....	Chart 6.12
oS – Overspeed .....	Chart 6.13
CF – Out of Control .....	Chart 6.14



#### WARNING

Oscilloscope chassis may be at voltages potentially hazardous to life if not properly grounded. If oscilloscope is used to measure high voltage waveforms, use only a dual channel oscilloscope in the differential mode with X100 probes. Always connect oscilloscope chassis to earth ground.



#### WARNING

Voltages dangerous to life exist when equipment is open and energized. Do not work alone.



#### CAUTION

To prevent equipment damage always remove incoming three-phase power before test equipment is connected or removed. Never disconnect or connect the wiring while the power is applied.

**TROUBLESHOOTING CHART 6.1**

**MOTOR DOES NOT ROTATE**

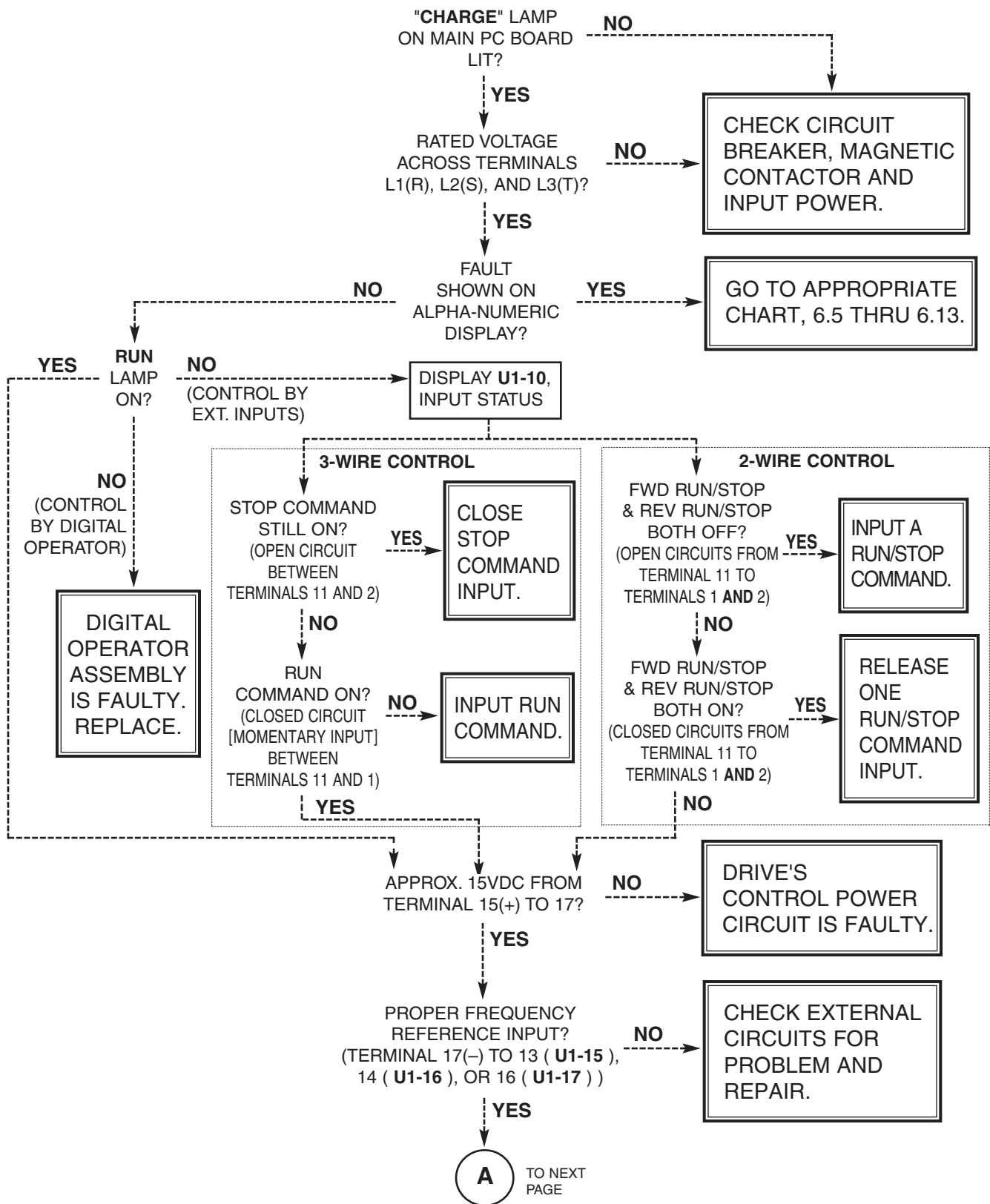

**TROUBLESHOOTING CHART 6.1 (Continued)**

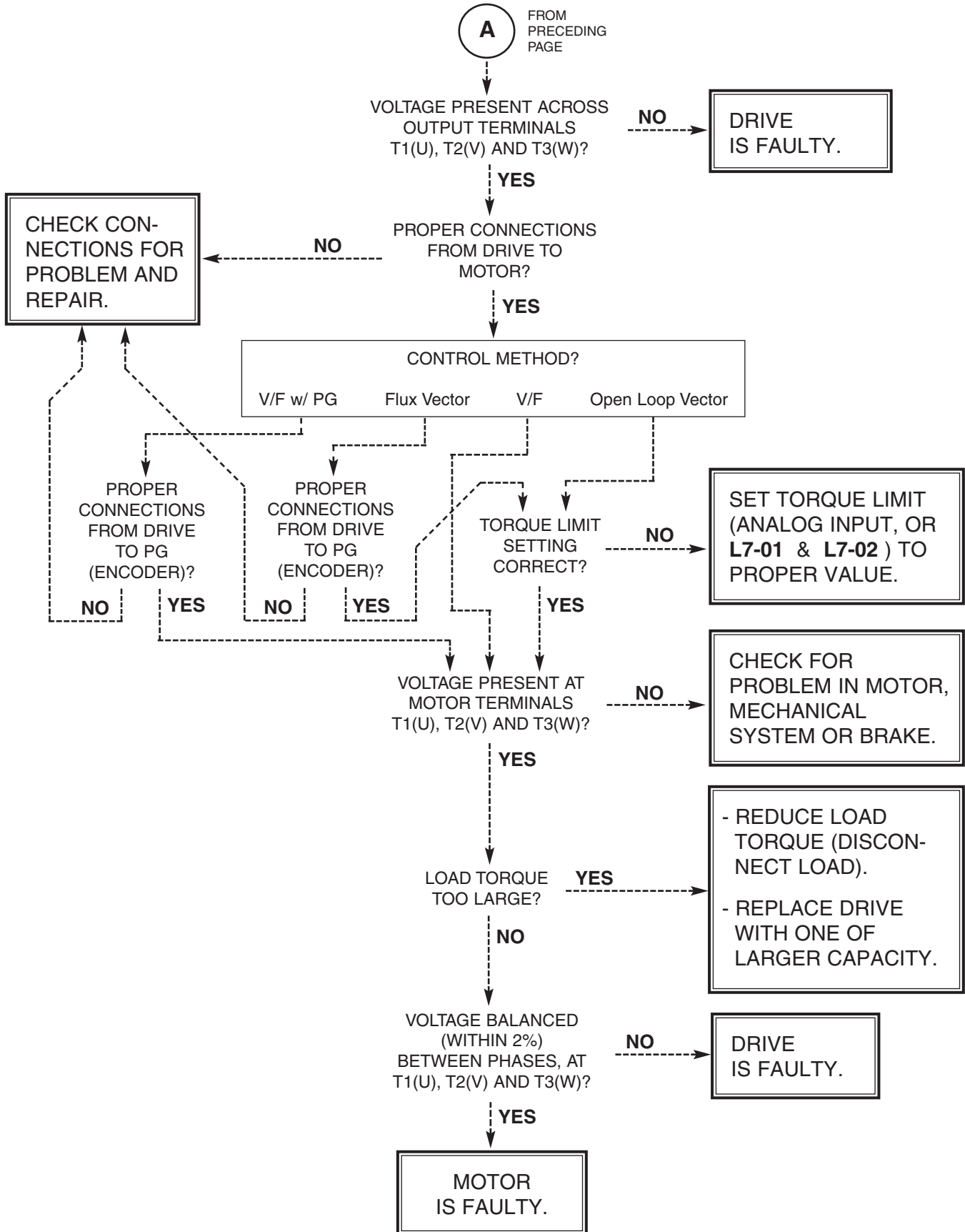

**TROUBLESHOOTING CHART 6.2**

**MOTOR STALLS DURING ACCELERATION**

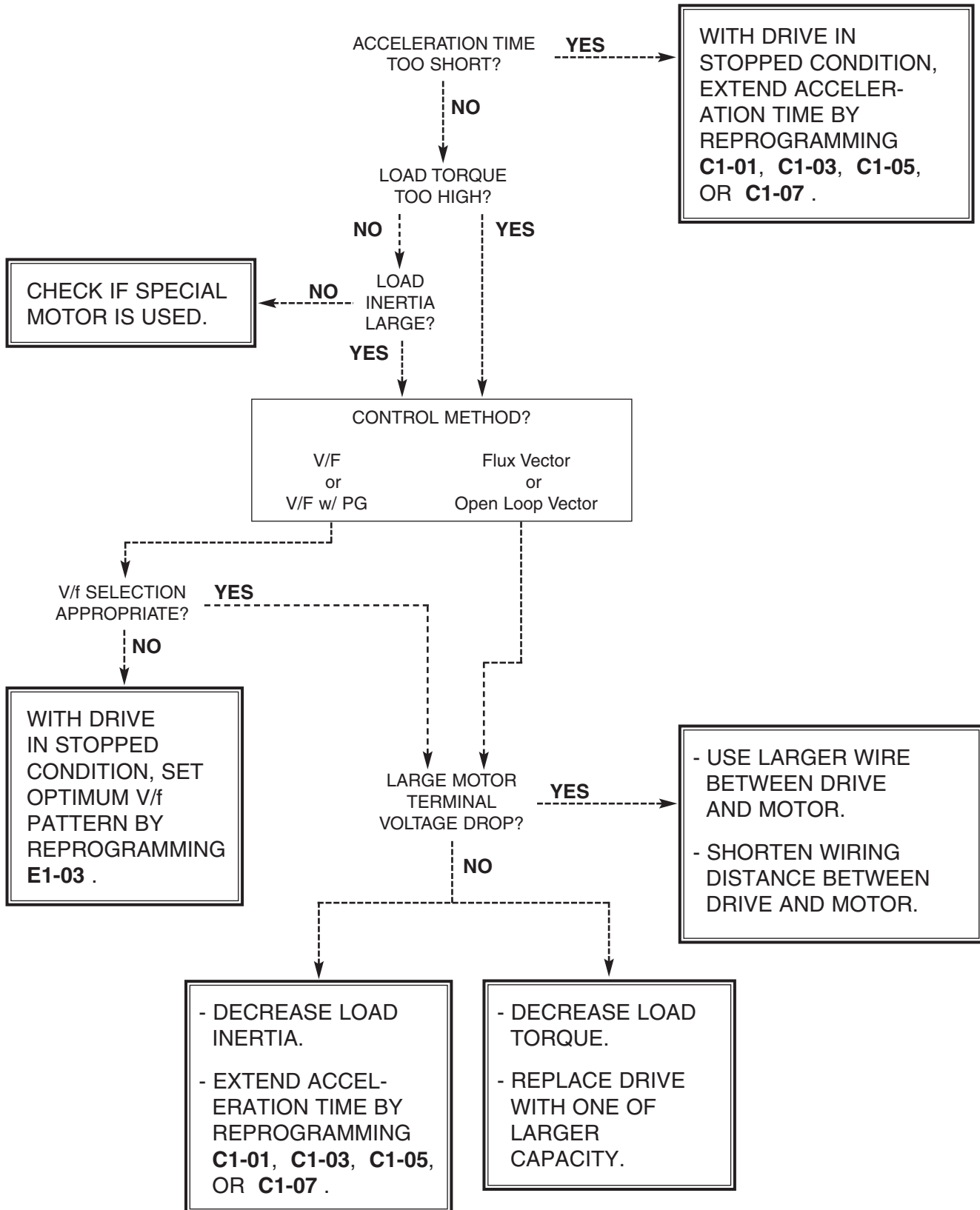



## TROUBLESHOOTING CHART 6.3

### MOTOR DOES NOT ROTATE AT SET SPEED

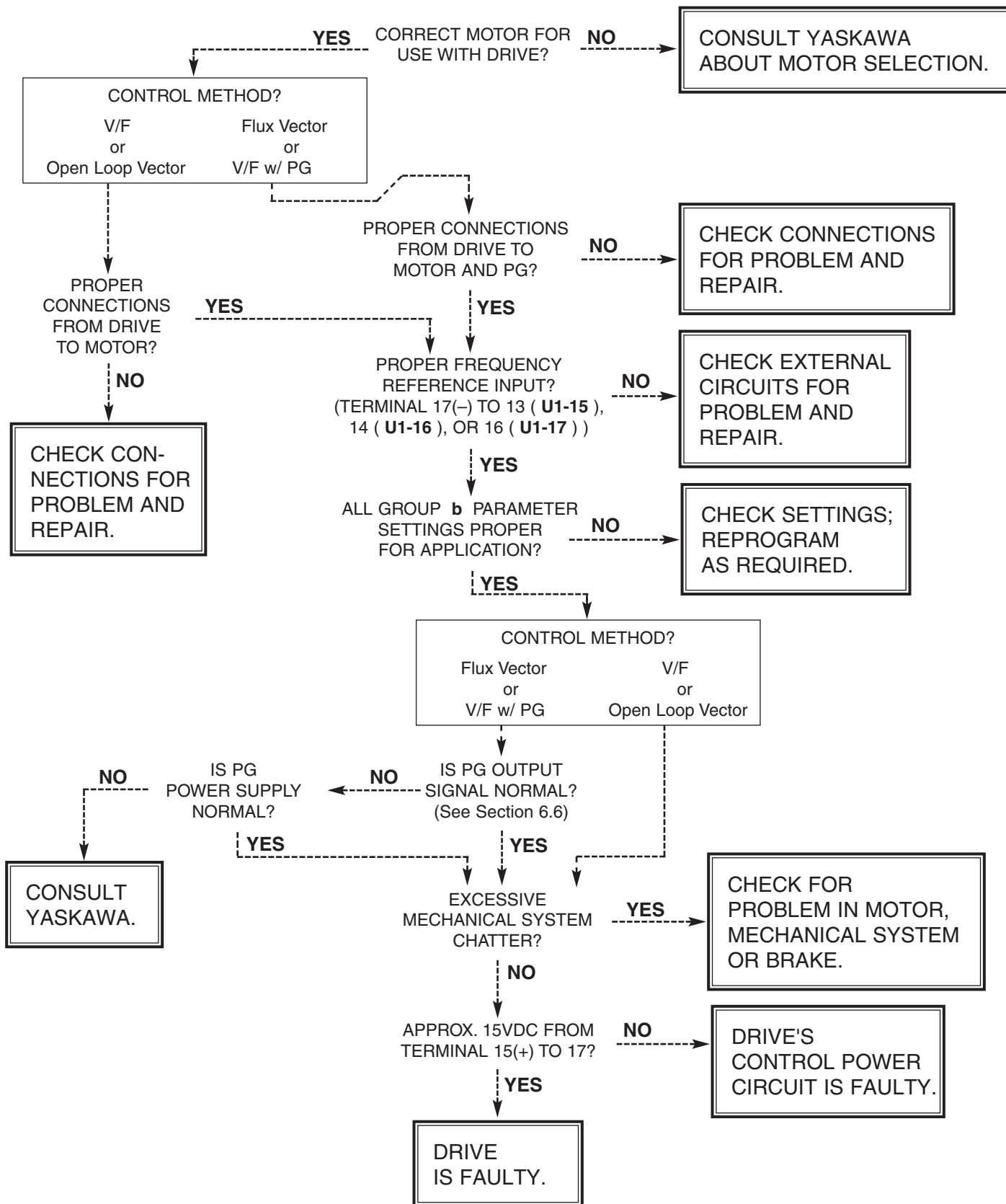

**TROUBLESHOOTING CHART 6.4**

**MOTOR HUNTING**

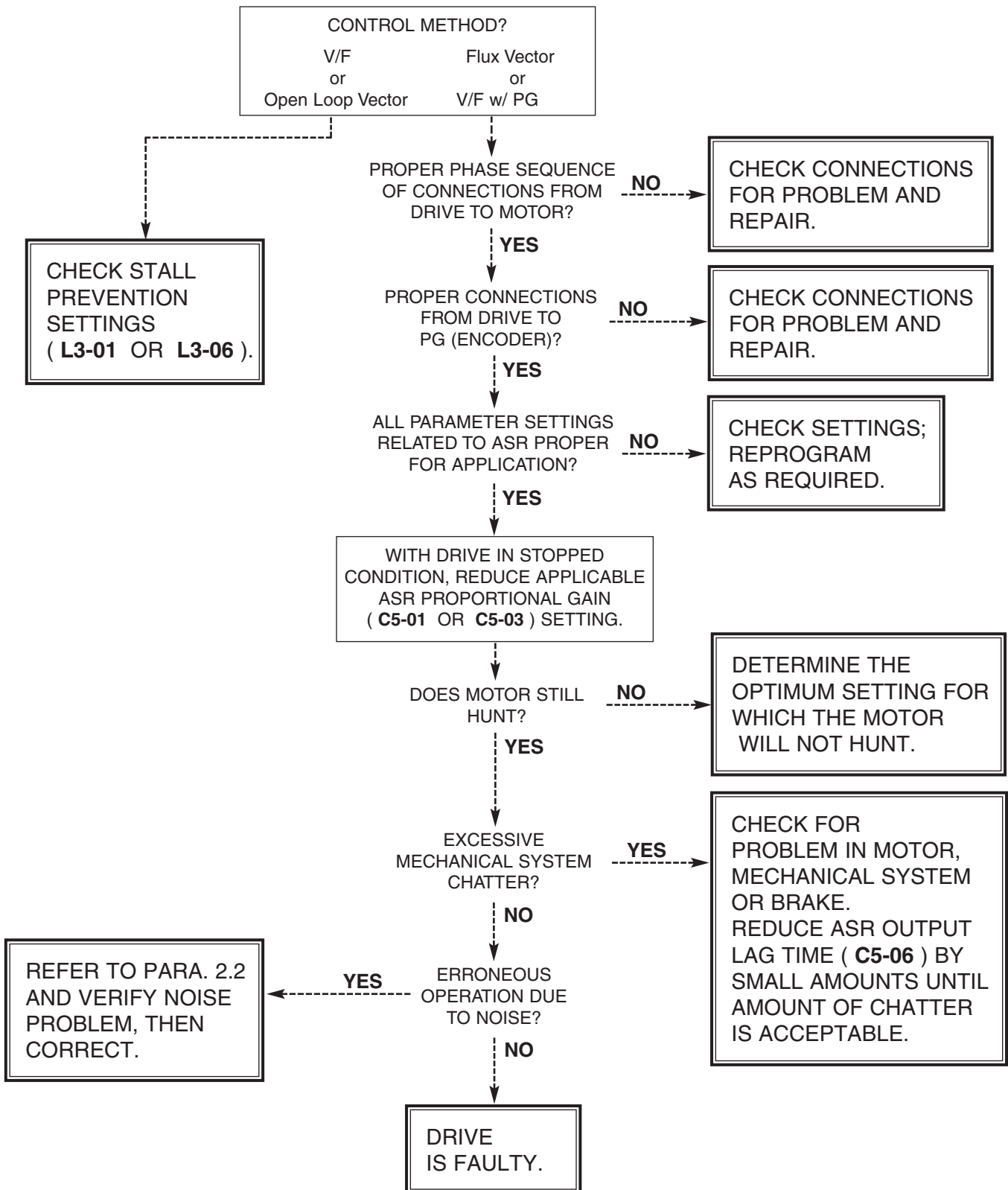

**TROUBLESHOOTING CHART 6.5**

**" oV – Overvoltage " FAULT INDICATION**

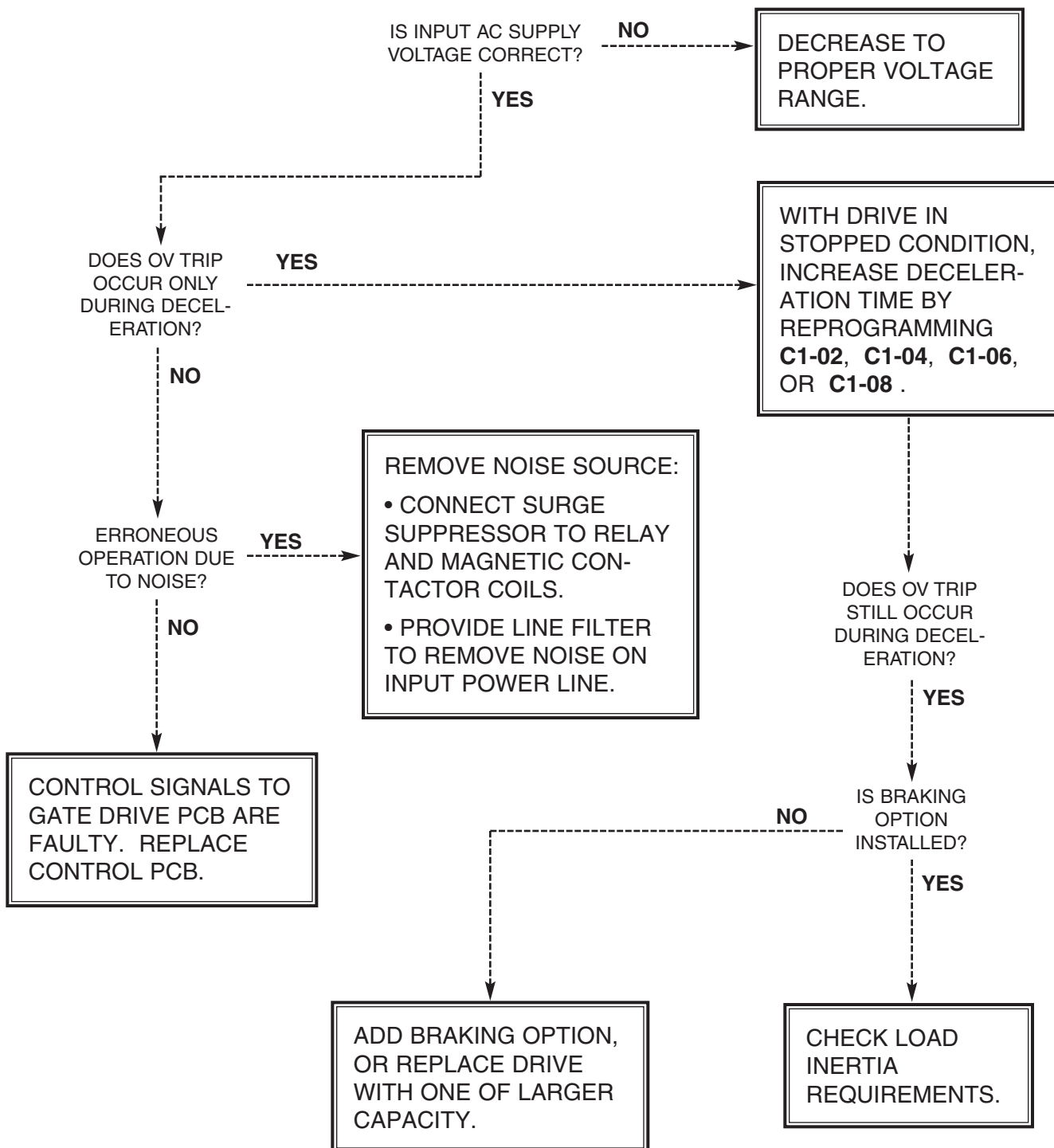

**TROUBLESHOOTING CHART 6.6**

**" PUF – DC Bus Fuse Open " FAULT INDICATION**

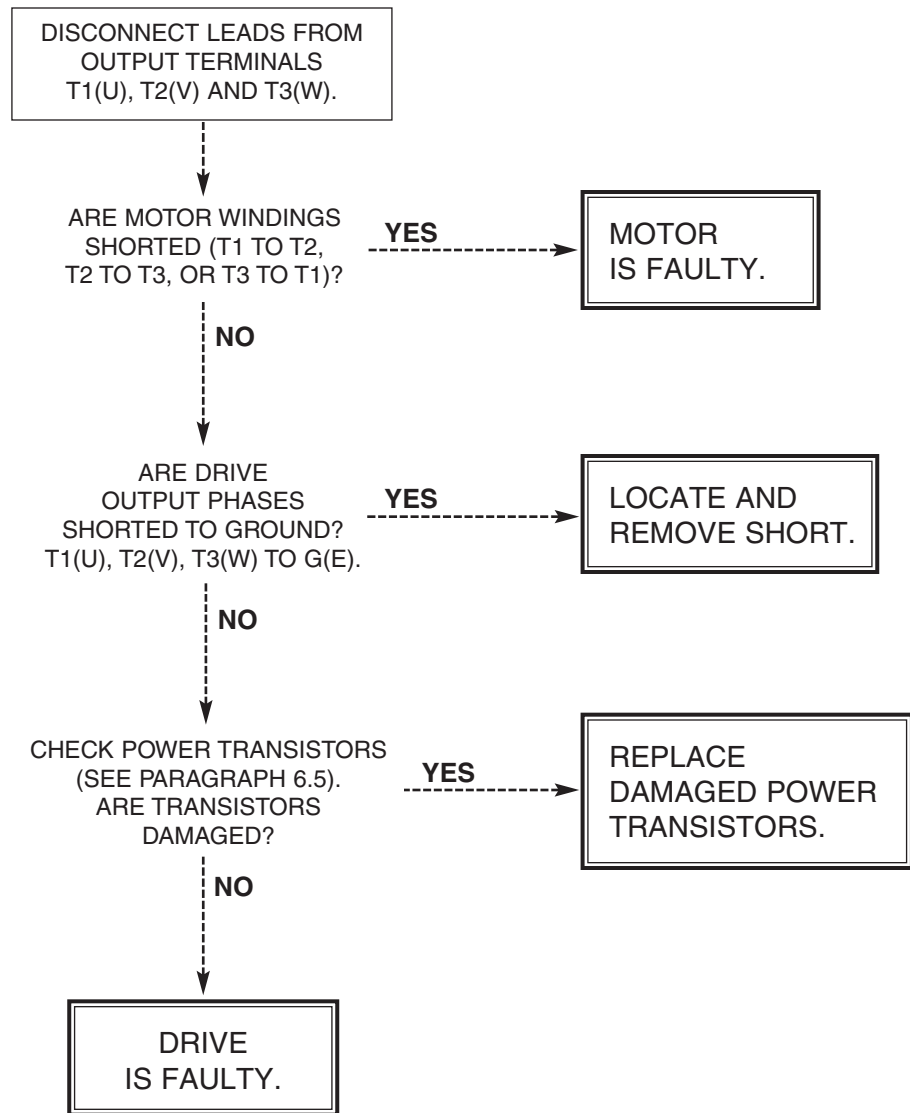

**DO NOT REPLACE DC BUS FUSE WITHOUT FIRST CHECKING OUTPUT TRANSISTORS.**

## TROUBLESHOOTING CHART 6.7

### " oC – Overcurrent " FAULT INDICATION

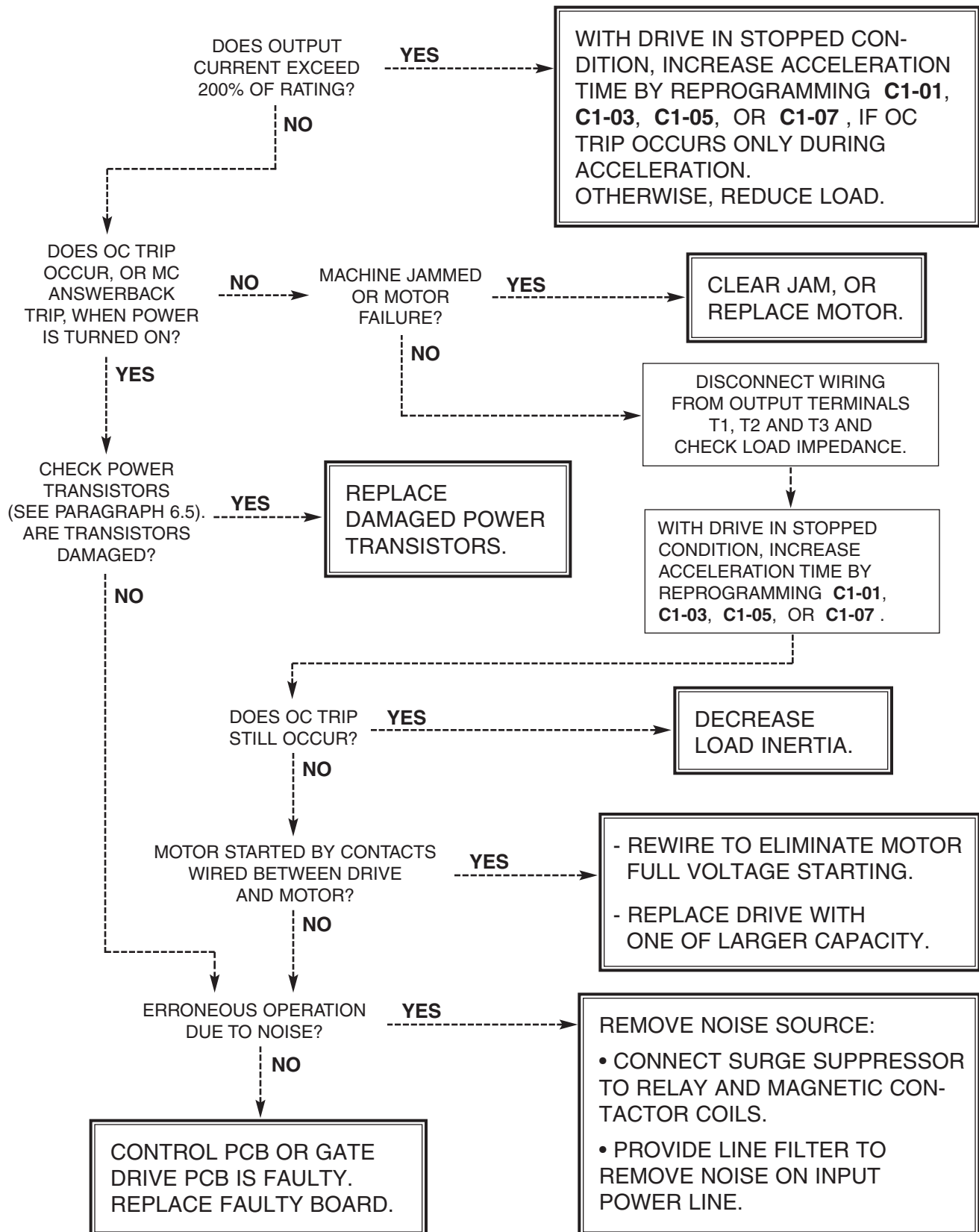

**TROUBLESHOOTING CHART 6.8**

**" oL1 – Motor Overload " FAULT INDICATION**

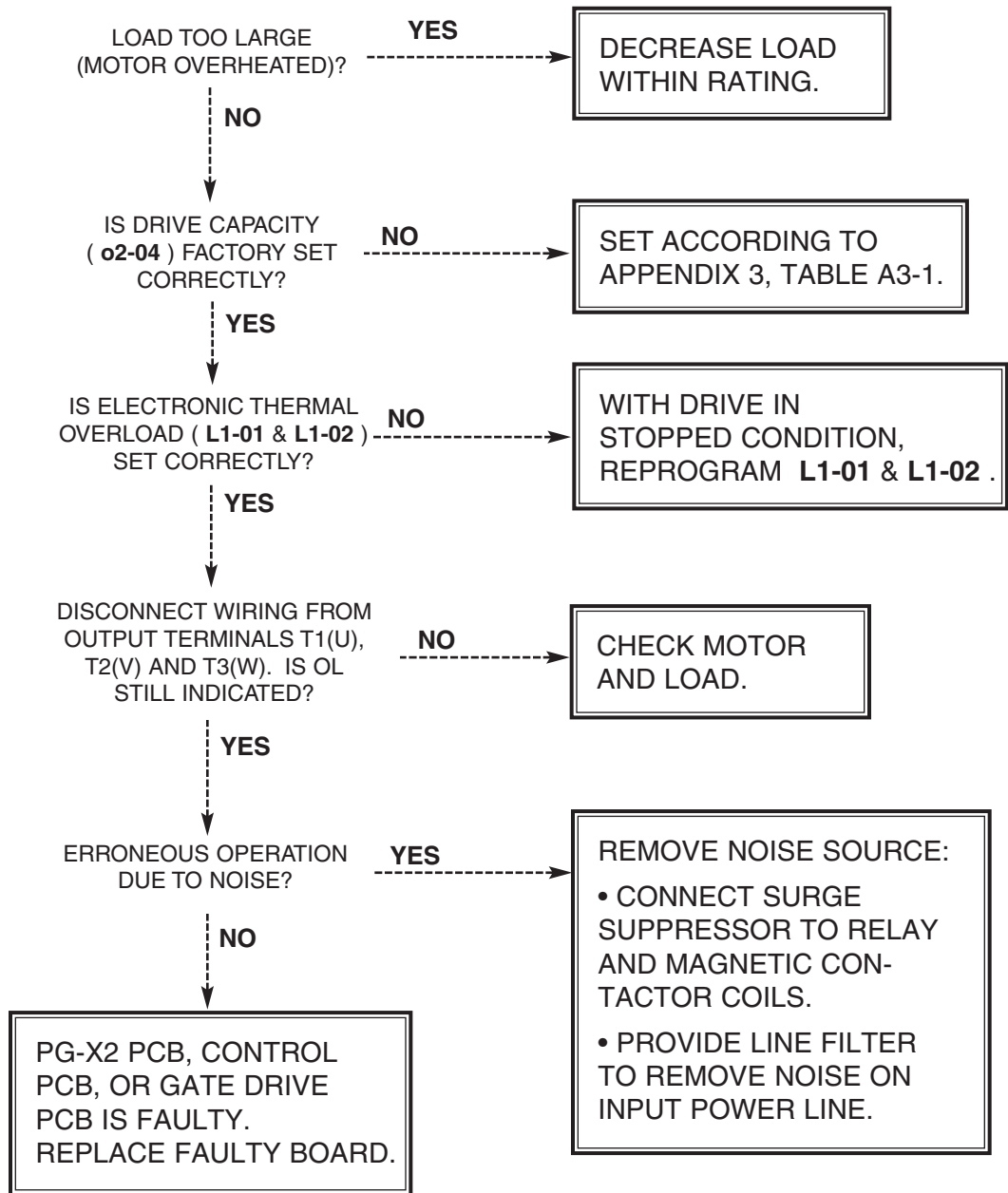

**TROUBLESHOOTING CHART 6.9**

**" UV – Undervoltage " FAULT INDICATION**

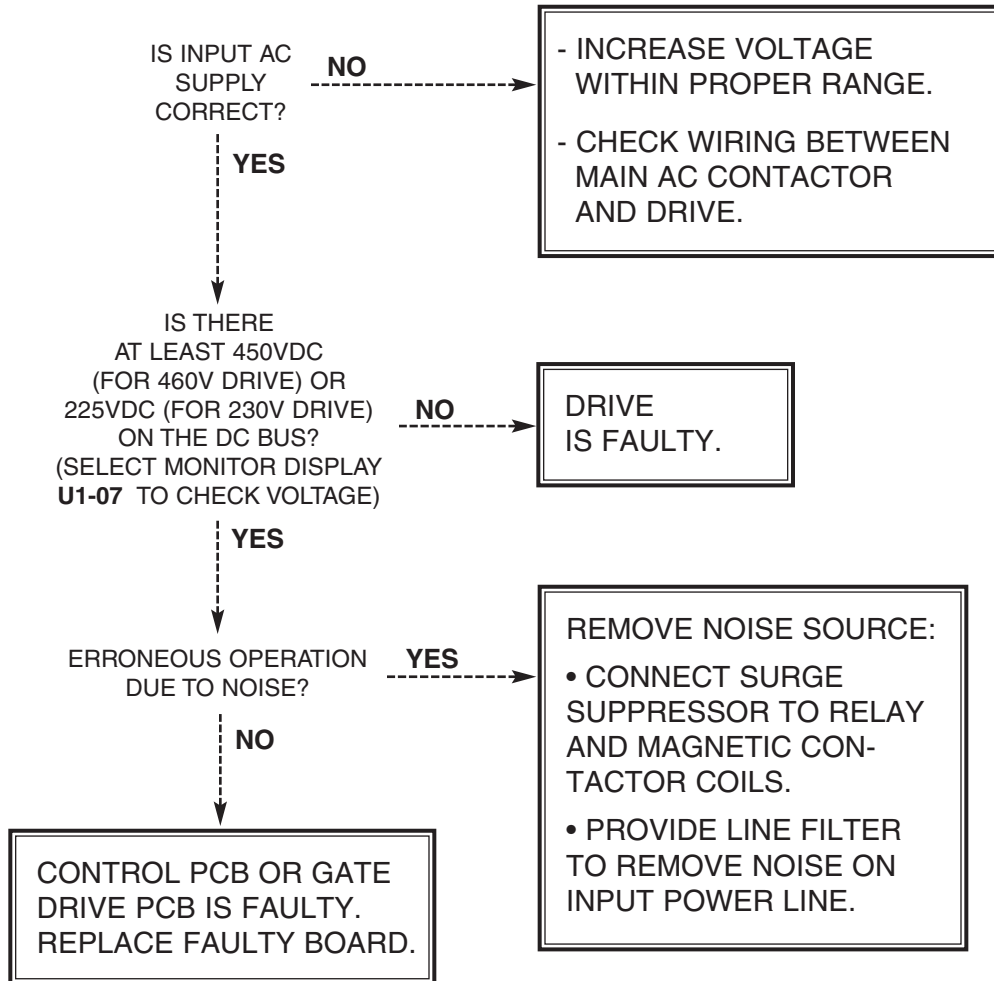

**TROUBLESHOOTING CHART 6.10**

**" oH – Heatsink Overtemp " FAULT INDICATION**

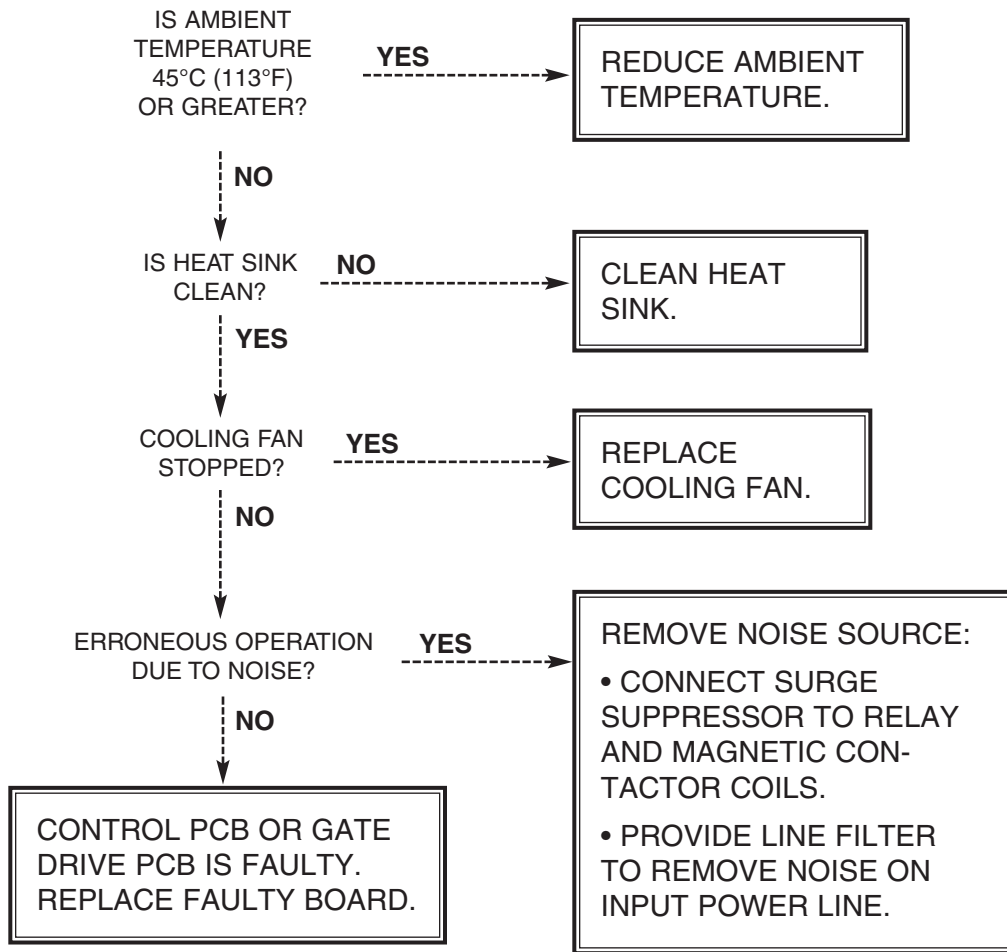



## TROUBLESHOOTING CHART 6.11

### " CPFXX – " CONTROL FUNCTION ERROR FAULT INDICATION

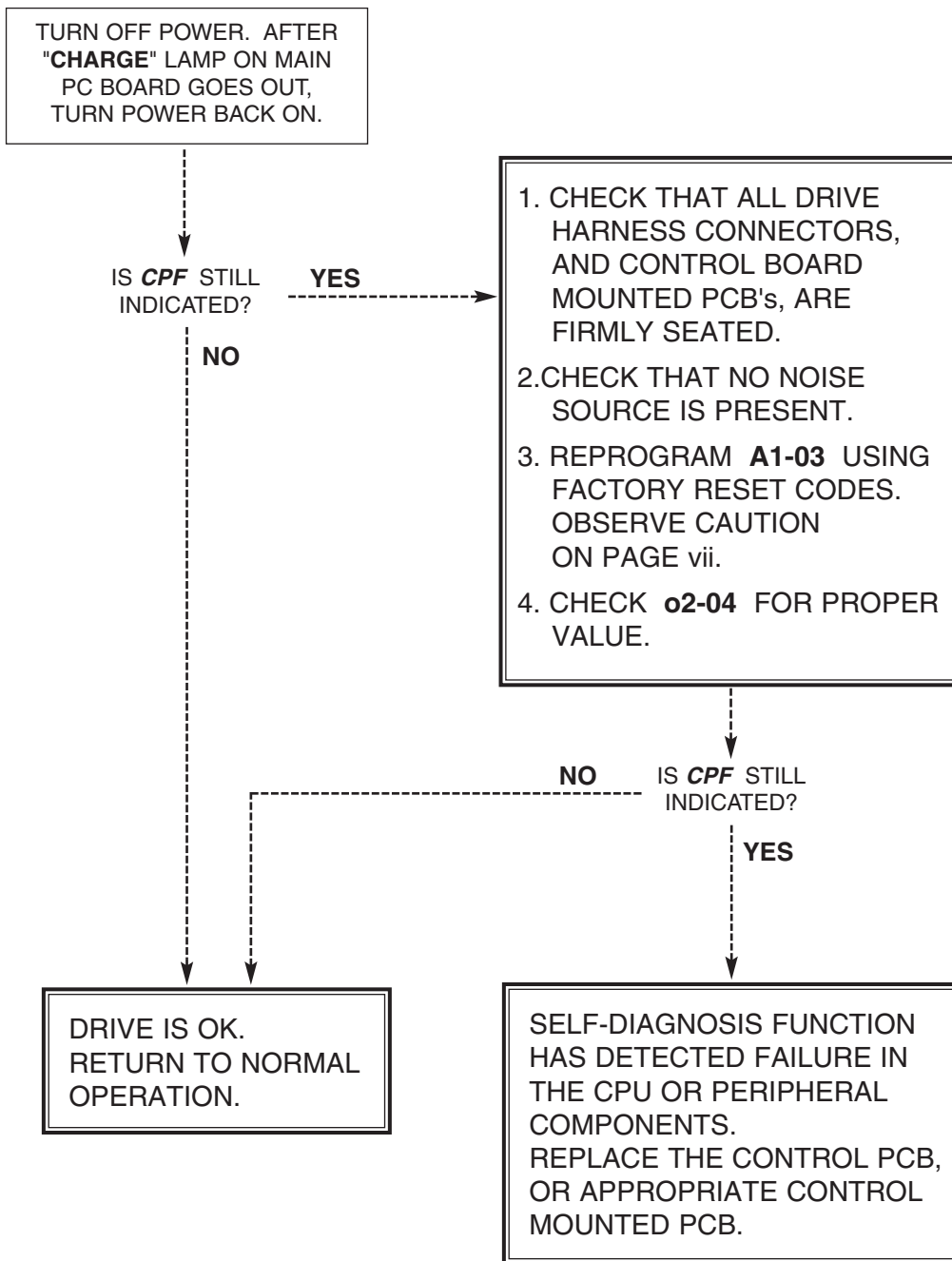

**TROUBLESHOOTING CHART 6.12**

**" EFX – " EXTERNAL FAULT INDICATION**

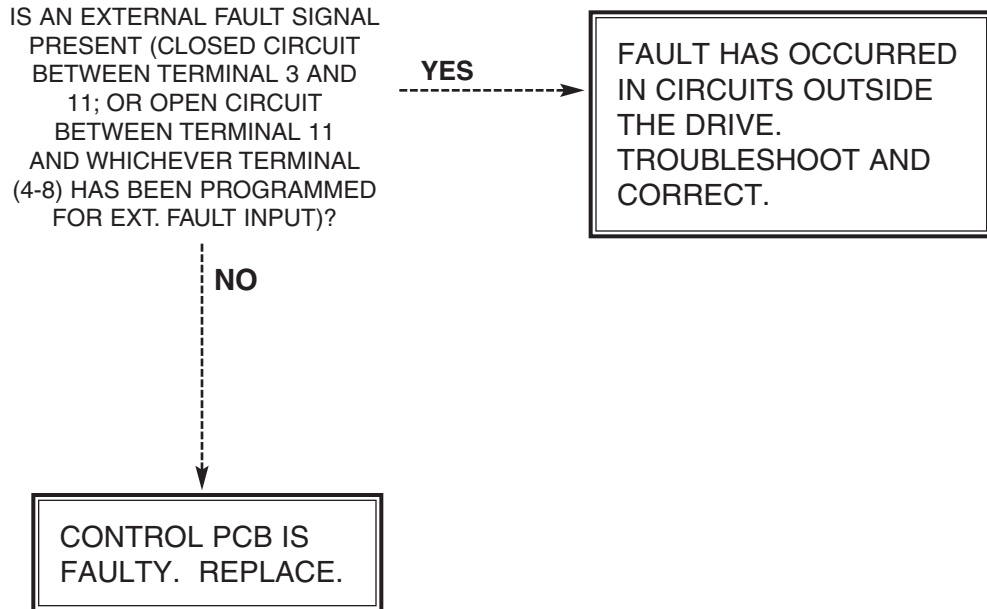

**TROUBLESHOOTING CHART 6.13**

**" oS – Overspeed " FAULT INDICATION**

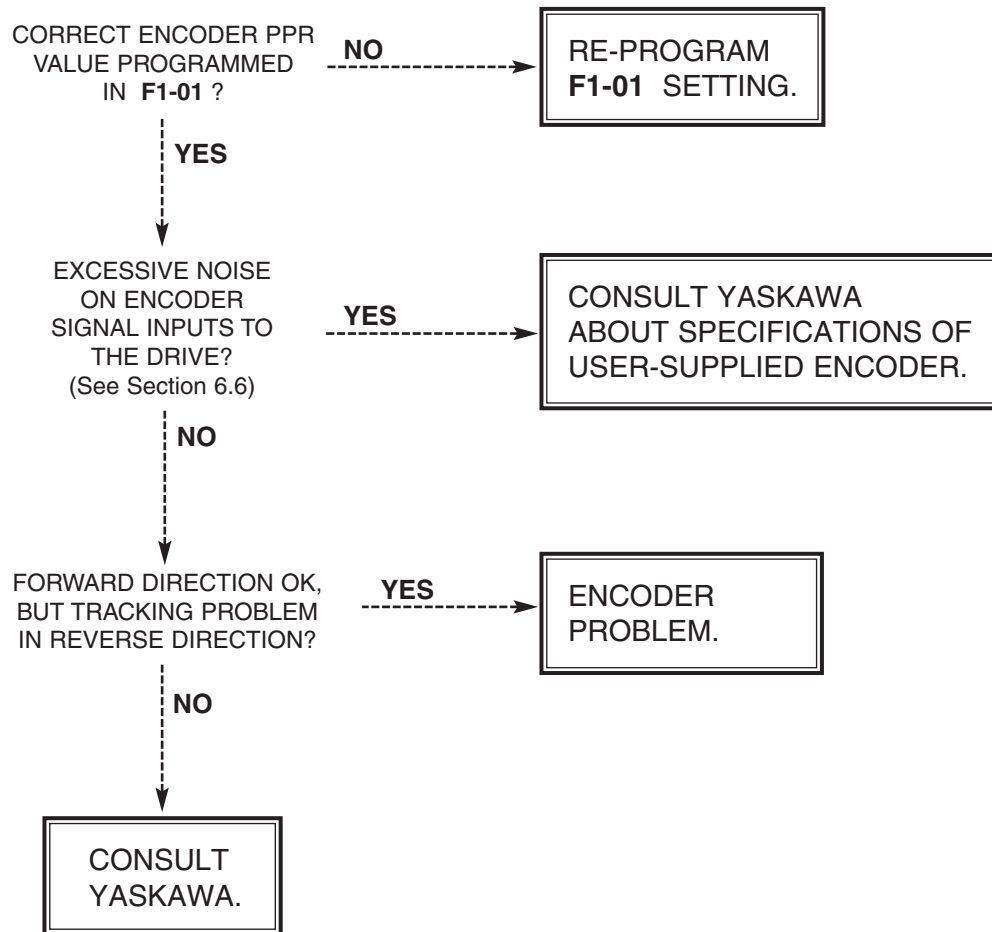

**TROUBLESHOOTING CHART 6.14**

**" CF – Out of Control " FAULT INDICATION**

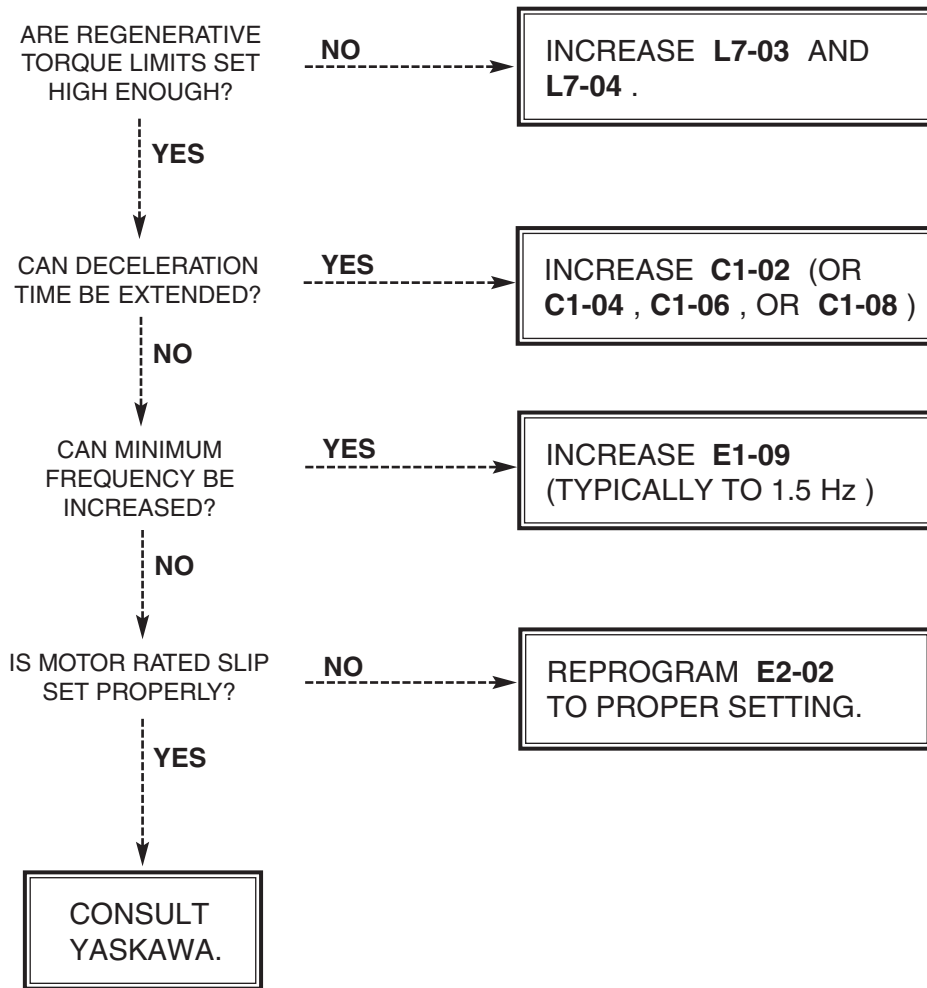

**TROUBLESHOOTING CHART 6.15**

**NO DIGITAL OPERATOR DISPLAY**

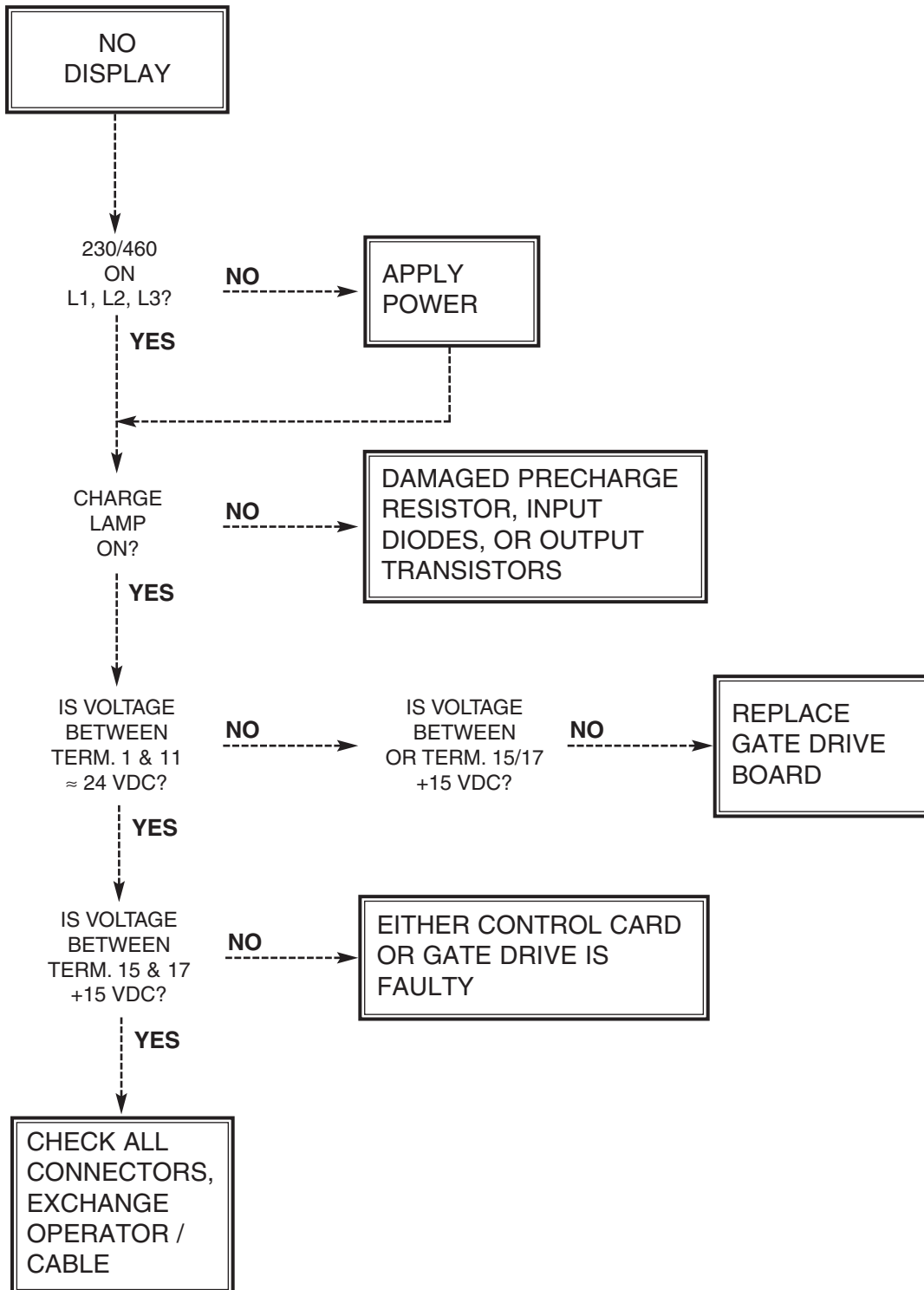

## 6.5 DIODE AND IGBT (TRANSISTOR) MODULE RESISTANCE TEST

### A. DIODE MODULE

Measure the resistance across the module terminals with a volt-ohm meter. Set the meter at the X1 range. The measured resistance should be within the values listed in Table 6-4.

NOTE: If the DC bus fuse is blown (PUF), the values shown below may not be accurate.

### WARNING

Power should be removed from L1, L2, & L3 and the CHARGE light should be out prior to conducting these tests.

Table 6-4. Diode Module Resistances

+	-	NORMAL READING (OHMS)	ABNORMAL READING (OHMS)	+	-	NORMAL READING (OHMS)	ABNORMAL READING (OHMS)
ON	ON			ON	ON		
L1	⊕1	2.5 to 50 Ω or 0.25 to 0.7 if using → scale	0 Ω or INFINITE	L1	⊖	INFINITE	LESS THAN 1M Ω
L2	⊕1			L2	⊖		
L3	⊕1			L3	⊖		
⊖	L1			⊕2	L1		
⊖	L2			⊕2	L2		
⊖	L3			⊕2	L3		
				⊕2	⊖	MAGNITUDE OF CAP CHARGE TO INFINITE	0 Ω or INFINITE

### RESISTANCE TEST FOR 3Ø CONVERTER MODULES (BRIDGE RECT)

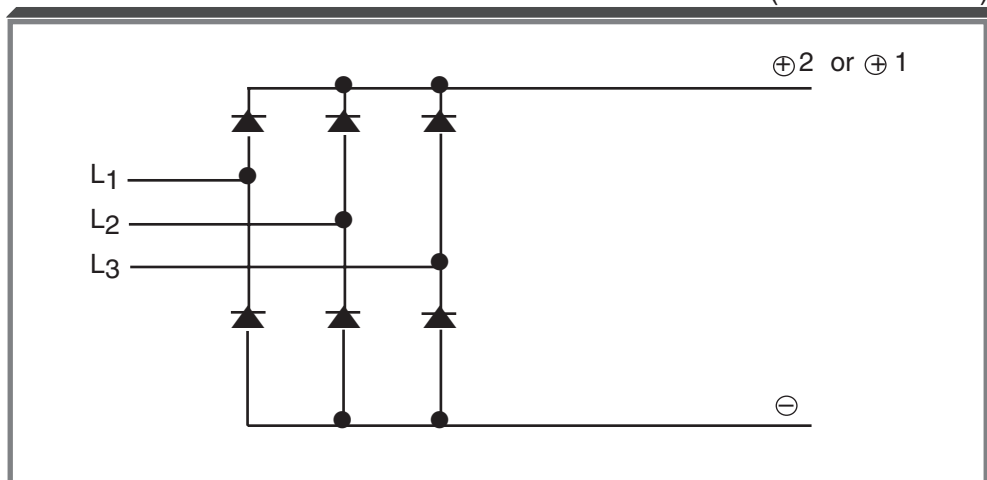

VOM RESISTANCE SCALE R x 1  
 + IS THE POSITIVE POLARITY LEAD \*  
 - IS THE NEGATIVE POLARITY LEAD

\* The VOM red lead is not necessarily the positive potential in the resistance mode. For these tests the + lead refers to the positive potential. Make sure you know which polarity you have on your VOM.

## B. TRANSISTOR MODULE

Measure the resistance across the module terminals with a volt-ohm meter. Set the meter to the X1 range. The measured resistance should be within the values listed in Table 6-5.

NOTE: If the DC bus fuse is blown (PUF), the values shown below may not be accurate.

**Table 6-5. Transistor Module Resistances**

+	-	NORMAL READING (OHMS)	ABNORMAL READING (OHMS)
ON	ON		
B1/⊕3/⊕1 B1/⊕3/⊕1 B1/⊕3/⊕1 T1/U T2/V T3/W	T1/U T2/V T3/W ⊖ ⊖ ⊖	INFINITE	0 Ω
T1/U T2/V T3/W ⊖ ⊖ ⊖	B1/⊕3/⊕1 B1/⊕3/⊕1 B1/⊕3/⊕1 T1 T2 T3	2.5 to 50 Ω or 0.3 to 0.7 if using scale	0 Ω or INFINITE

### RESISTANCE TEST FOR 3Ø TRANSISTOR MODULES

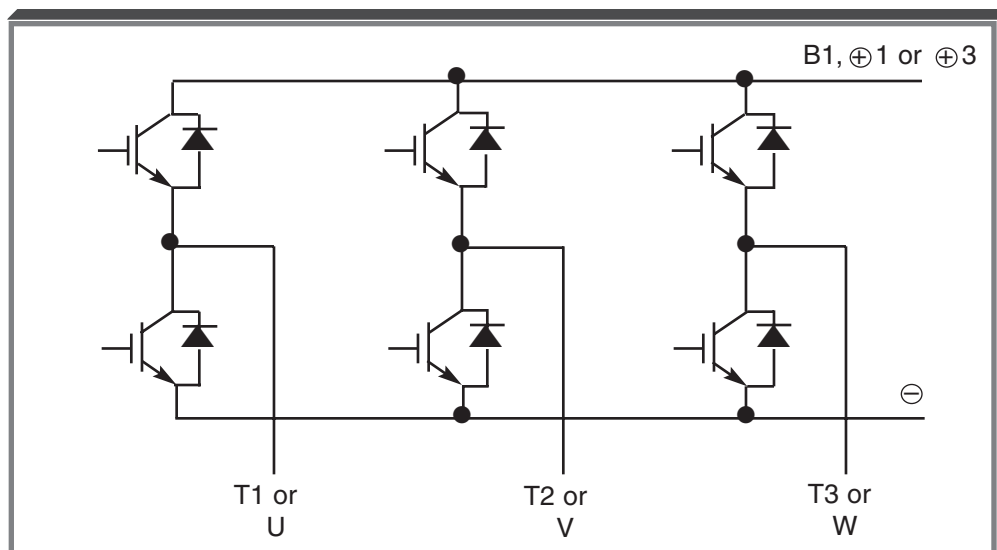

VOM RESISTANCE SCALE R x 1  
+ IS THE POSITIVE POLARITY LEAD \*  
- IS THE NEGATIVE POLARITY LEAD

\* The VOM red lead is not necessarily the positive potential in the resistance mode. For these tests the + lead refers to the positive potential. Make sure you know which polarity you have on your VOM.

## 6.6 CHECKING ENCODER PULSES

In order to check the encoder pulses, an oscilloscope is needed. The pulses can be checked after they have been processed by the PG-X2 card or at the motor.

### WARNING

**The following tests require power to be applied to the drive while the front cover is off. Proper precautions should be taken to prevent electric shock and damage to the equipment.**

#### A. Checking Encoder Pulses at Test Points on the PG-X2 Card

1. Remove power from L1, L2, & L3 and wait for the CHARGE light to go out.
2. Connect the common of the oscilloscope to the test point labeled GND.
3. Connect one channel of the scope to PA. (If the scope is two channel, connect the second channel to PB).
4. Set the scope for 2V/div, 50ms/div, normal trigger, and rising edge trigger.
5. Apply power to the GPD 515, but do **NOT** apply a run command.
6. Turn the motor shaft by hand. As Figure 6-1 shows, there should be pulses on both channels at a +5V level, 50% duty cycle, and they should be separated by 90 electrical degrees (half a pulse).
7. If one or both channels do not have the correct pulses present (i.e. missing pulses, incorrect duty cycle, improper voltage, etc.), go to procedure B.

#### B. Checking the Pulses at the Input to the PG-X2 Card

1. Remove power from L1, L2, & L3 and wait for the CHARGE light to go out.
2. Connect the common of the scope to terminal 2 of TA1.
3. Connect one channel of the scope to terminal 4 of TA1. (If the scope is two channel, connect the second channel to terminal 5 of TA1.)
4. Set the scope for 5V/div, 50ms/div, normal trigger, and rising edge trigger.
5. Apply power to the drive, but do **NOT** apply a run command.
6. Turn the motor shaft by hand. As Figure 6-1 shows, there should be pulses on both channels, 50% duty cycle, and they should be the inverse of each other (separated by 180 electrical degrees).
7. Disconnect the two scope channels, and reconnect them to terminals 6 and 7 of TA1.



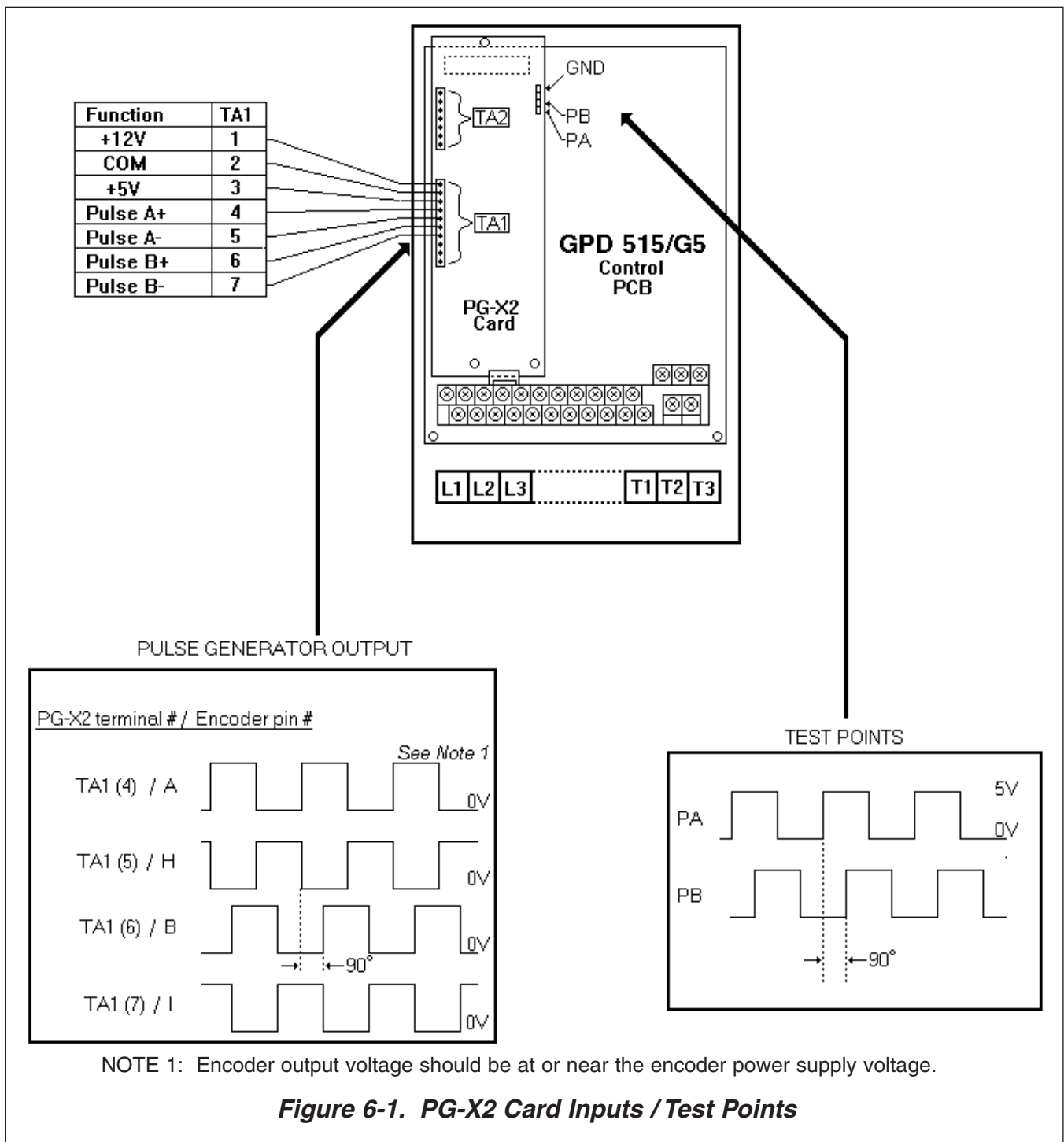

- Turn the motor shaft by hand. As Figure 6-1 shows, there should be pulses on both channels, 50% duty cycle, and they should be the inverse of each other (separated by 180 electrical degrees).
- If one or both channels do not have the correct pulses present (i.e. missing pulses, incorrect duty cycle, improper voltage, etc.), go to procedure C.

### C. Checking the Pulses at a VCM Motor

1. Remove power from L1, L2, & L3 and wait for the CHARGE light to go out.
2. Take apart the military style connector at the motor.
3. Connect the common of the scope to pin F.
4. Connect one channel of the scope to pin A. (If the scope is two channel, connect the second channel to pin H.)
5. Set the scope for 5V/div, 50ms/div, normal trigger, and rising edge trigger.
6. Apply power to the drive, but do **NOT** apply a run command.
7. Turn the motor shaft by hand. As Figure 6-1 shows, there should be pulses on both channels, 50% duty cycle, and they should be the inverse of each other (separated by 180 electrical degrees).
8. Disconnect the two scope channels, and reconnect them to pins B and I.
9. Turn the motor shaft by hand. As Figure 6-1 shows, there should be pulses on both channels, 50% duty cycle, and they should be the inverse of each other (separated by 180 electrical degrees).
10. If no pulses can be seen on any of the four pins (A, B, H, & I), check the power supply between pins D and F. If it is not at or near 12VDC, check the power supply back at the PG-X2 card on TA1 terminals 1 & 2. If the power supply is not good at TA1, replace the PG-X2 card.



# Appendix 1. LISTING OF PARAMETERS

The GPD 515/G5 control circuits use various parameters to select functions and characteristics of the drive. For methods of changing of parameter settings, see Section 4.

The following tables list all parameters in numerical order. For each parameter, reference paragraph(s) in Section 2 or 5 are listed (if applicable) where the features of the drive affected by that parameter are described.

**Table A1-1. Drive AX-XX Parameters**

PARAMETER NUMBER	FUNCTION NAME	DESCRIPTION	INCREMENT	SETTING RANGE	FACTORY SETTING	ACCESS LEVEL (See Note 2)				PARA. REF.
						0	1	2	3	
<b>A1-00</b>	Language Selection	0 : English 1 : Japanese 2 : German 3 : French 4 : Italian 5 : Spanish 6 : Portuguese	1	0 - 6	0 (See Note 1)	Q	Q	Q	Q	2.3
<b>A1-01</b>	Parameter Access Level	0 : Operation only 1 : User program 2 : Quick-start 3 : Basic 4 : Advanced	1	0 - 4	2	Q	Q	Q	Q	5.4 See Note 2
<b>A1-02</b>	Control Method Selection	0 : V/f control 1 : V/f with PG feedback 2 : Open loop vector 3 : Flux vector	1	0 - 3	2 (See Note 1)	Q	Q	Q	Q	2.2
<b>A1-03</b>	Initialize Parameters	0 : No initialize 1110 : User initialize 2220 : 2-wire initialize 3330 : 3-wire initialize	1	0000 - 9999	0000	Q	Q	Q	Q	5.37
<b>A1-04</b>	Enter Password		1	0000 - 9999	0000	Q	Q	Q	Q	
<b>A2-01 thru A2-32</b>	User Program Access Parameters	Select parameters to be available in User Program Access Level	1	b1-01 - o2-09	----	A	A	A	A	5.4

**NOTES:**

- Settings of these parameters will not be initialized by programming **A1-03** to " 1110 ", " 2220 ", or " 3330 ".
- Capability to view and set specific parameters is dependent upon the Access Level ( **A1-01** ) and Control Method ( **A1-02** ; 0 = V/f, 1 = V/f w/PG, 2 = Open Loop Vector, 3 = Flux Vector) the drive is programmed for. Each column represents the Access Level for a given Control Method: Q = Quick-start; B = Basic; A = Advanced; — = not available.

**Table A1-2. Drive bX-XX Parameters**

PARAMETER NUMBER	FUNCTION NAME	DESCRIPTION	INCREMENT	SETTING RANGE	FACTORY SETTING	ACCESS LEVEL (See Note 3)				PARA. REF.
						0	1	2	3	
<b>b1-01</b>	Reference Selection	0 : Digital Operator 1 : Terminal 2 : Serial communication 3 : Option PCB 4 : EWS	1	0 - 4	1	Q	Q	Q	Q	5.25 A, 5.28, 5.36
<b>b1-02</b>	Operation Method Selection	0 : Digital Operator 1 : Terminal 2 : Serial communication 3 : Option PCB 4 : EWS	1	0 - 4	1	Q	Q	Q	Q	5.25 A, 5.28
<b>b1-03</b>	Stopping Method Selection	0 : Ramp to stop 1 : Coast to stop 2 : DC injection to stop 3 : Coast with timer	1	0 - 3 (See Note 1)	0	Q	Q	Q	Q	5.10,2 5.40
<b>b1-04</b>	Reverse Operation Prohibit	0 : Enable reverse operation 1 : Disable reverse operation	1	0, 1	0	B	B	B	B	
<b>b1-05</b>	Zero-Speed Operation (level determined by <b>E1-09</b> )	0 : Run at frequency reference 1 : Stop 2 : Run at min. freq. ( <b>E1-09</b> ) 3 : Run at zero speed	1	0 - 3	0	—	—	—	A	5.50
<b>b1-06</b>	Logic Input Scan Rate	0 : 2ms – 2 scans 1 : 5ms – 2 scans	1	0, 1	1	A	A	A	A	
<b>b1-07</b>	Local/Remote Run Selection	0 : Cycle external Run 1 : Accept external Run	1	0, 1	0	A	A	A	A	5.32A
<b>b1-08</b>	Run Command Selection During Program	0 : Run command is disabled during program mode 1 : Run command enabled during program mode	1	0 - 1	0	A	A	A	A	5.26
<b>b2-01</b>	DC Injection Braking Start Frequency		0.1 Hz	0.0 - 10.0	0.5	B	B	B	B	5.10, 5.32
<b>b2-02</b>	DC Injection Braking Current		1 %	0 - 100	50	B	B	B	—	5.10
<b>b2-03</b>	DC Injection Braking Time at Start		0.01 sec	0.00 - 10.00	0.00	B	B	B	B	5.10
<b>b2-04</b>	DC Injection Braking Time at Stop		0.01 sec	0.00 - 10.00	0.00	B	B	B	B	5.10
<b>b2-08</b>	Field Compensation At Start	100% is no load current value at Min. frequency (E1-09).	1%	0 - 500	0	—	—	A	A	5.10B

**Table A1-2. Drive bX-XX Parameters – Continued**

PARAMETER NUMBER	FUNCTION NAME	DESCRIPTION	INCREMENT	SETTING RANGE	FACTORY SETTING	ACCESS LEVEL (See Note 3)				PARA. REF.
						0	1	2	3	
<b>b3-01</b>	Speed Search Selection	0 : Disabled 1 : Enabled	1	0, 1	0 (See Note 2)	A	A	A	A	5.32 D
<b>b3-02</b>	Speed Search Deactivation Current Level		1 %	0 - 200	100 (See Note 2)	A	—	A	—	5.32 D
<b>b3-03</b>	Speed Search Deceleration Time		0.1 sec	0.0 - 10.0	2.0	A	—	A	—	5.32 D
<b>b4-01</b>	Timer Function ON-Delay Time		0.1 sec	0.0 - 300.0	0.0	A	A	A	A	5.32 E
<b>b4-02</b>	Timer Function OFF-Delay Time		0.1 sec	0.0 - 300.0	0.0	A	A	A	A	5.32 E
<b>b5-01</b>	PID Control Mode Selection	0 : Disabled 1 : D=Feedback 2 : D=Feed forward 3 : Reference + PID (D=Feedback) 4 : Reference + PID (D=Feed Forward)	1	0 - 4	0	A	A	A	A	5.36
<b>b5-02</b>	PID Proportional Gain		0.01	0.00 - 25.00	1.00	A	A	A	A	5.36
<b>b5-03</b>	PID Integral Time		0.1 sec	0.0 - 360.0	1.0	A	A	A	A	5.36
<b>b5-04</b>	PID Integral Limit		0.1 %	0.0 - 100.0	100.0	A	A	A	A	5.36
<b>b5-05</b>	PID Differential Time		0.01 sec	0.00 - 10.00	0.00	A	A	A	A	5.36
<b>b5-06</b>	PID Output Limit		0.1 %	0.0 - 100.0	100.0	A	A	A	A	5.36
<b>b5-07</b>	PID Offset Adjustment		0.01 %	-100.0 - 100.0	0.0	A	A	A	A	5.36
<b>b5-08</b>	PID Primary Delay Time Constant		0.01 sec	0.00 - 10.00	0.00	A	A	A	A	5.36
<b>b5-09</b>	PID Output Selection	0 : Not Inverted 1 : Inverted	1	0, 1	0	A	A	A	A	5.36D

**Table A1-2. Drive bX-XX Parameters – Continued**

PARAMETER NUMBER	FUNCTION NAME	DESCRIPTION	INCREMENT	SETTING RANGE	FACTORY SETTING	ACCESS LEVEL (See Note 3)				PARA. REF.
						0	1	2	3	
<b>b5-10</b>	PID Output Gain		0.1	0.0 - 25.0	1.0	A	A	A	A	5.36D
<b>b5-11</b>	PID Output Reverse Selection	0 : If PID output tries to go negative, it will be limited to 0 (motor stops) 1 : PID output is allowed to go negative (motor runs in reverse)	1	0, 1	0	A	A	A	A	5.36D
<b>b5-12</b>	Feedback Loss Detection Selection (PID)	0 : Detection is disabled 1 : Detection is enabled - alarm only 2 : Detection is enabled - fault	1	0 - 2	0	A	A	A	A	5.36E
<b>b5-13</b>	Feedback Loss Detection Level (PID)		1%	0 - 100	0	A	A	A	A	5.36E
<b>b5-14</b>	Feedback Loss Detection Delay Time (PID)		0.1 sec	0.0 - 25.5	1.0	A	A	A	A	5.36E
<b>b6-01</b>	Dwell Frequency at Start		0.1 Hz	0.0 - 400.0	0.0	A	A	A	A	5.14
<b>b6-02</b>	Dwell Time at Start		0.1 sec	0.0 - 10.0	0.0	A	A	A	A	5.14
<b>b6-03</b>	Dwell Frequency at Stop		0.1 Hz	0.0 - 400.0	0.0	A	A	A	A	5.14
<b>b6-04</b>	Dwell Time at Stop		0.1 sec	0.0 - 10.0	0.0	A	A	A	A	5.14
<b>b7-01</b>	Droop Control Level		0.1 %	0.0 - 100.0	0.0	—	—	—	A	5.13
<b>b7-02</b>	Droop Control Delay Time		0.01 sec	0.03 - 2.00	0.05	—	—	—	A	5.13
<b>b8-01</b>	Energy-saving Gain		1 %	0 - 100	80	A	A	—	—	5.16A
<b>b8-02</b>	Energy-saving Frequency		0.1 Hz	0.0 - 400.0	0.0	A	A	—	—	5.16A
<b>b8-03</b>	Automatic Energy-saving Selection	0 : Disabled 1 : Enabled	1	0, 1	0	—	—	A	A	5.16B
<b>b8-04</b>	Automatic Energy-saving Gain		0.1	0.0 - 10.0	Note 2	—	—	A	A	5.16B

**Table A1-2. Drive bX-XX Parameters – Continued**

PARAMETER NUMBER	FUNCTION NAME	DESCRIPTION	INCREMENT	SETTING RANGE	FACTORY SETTING	ACCESS LEVEL (See Note 3)				PARA. REF.
						0	1	2	3	
<b>b8-05</b>	Automatic Energy-saving Time Constant		0.01 sec	0.0 - 10.0	Note 2	—	—	A	A	5.16B
<b>b9-01</b>	Zero-Servo Gain		1	0 - 100	5	—	—	—	A	5.49
<b>b9-02</b>	Zero-Servo Completion Width		1	0 - 16383	10	—	—	—	A	5.49

NOTES:

1. Setting range is only 0 and 1 when control method is set to Flux Vector control ( **A 1 - 0 2** = 3).
2. Will change with control method. See Appendix 3, Table A3-2.
3. Capability to view and set specific parameters is dependent upon the Access Level ( **A 1 - 0 1** ) and Control Method ( **A 1 - 0 2**; 0 = V/f, 1 - V/f w/PG, 2 = Open Loop Vector, 3 = Flux Vector) the drive is programmed for. Each column represents the Access Level for a given Control Method: Q = Quick-start; B = Basic; A = Advanced; — = not available.



**Table A1-3. Drive CX-XX Parameters**

PARAMETER NUMBER	FUNCTION NAME	DESCRIPTION	INCREMENT	SETTING RANGE	FACTORY SETTING	ACCESS LEVEL (See Note 3)				PARA. REF.								
						0	1	2	3									
<b>C1-01</b>	Acceleration Time 1		0.01 sec. or 0.1 sec.  (Dependent upon <b>C1-10</b> setting)	0.00 - 600.00 or 0.0 - 6000.0  (Dependent upon <b>C1-10</b> setting)	10.00 or 10.0  (Dependent upon <b>C1-10</b> setting)	Q	Q	Q	Q	5.2								
<b>C1-02</b>	Deceleration Time 1					Q	Q	Q	Q		5.2							
<b>C1-03</b>	Acceleration Time 2					B	B	B	B			5.2						
<b>C1-04</b>	Deceleration Time 2					B	B	B	B				5.2					
<b>C1-05</b>	Acceleration Time 3					A	A	A	A					5.2				
<b>C1-06</b>	Deceleration Time 3					A	A	A	A						5.2			
<b>C1-07</b>	Acceleration Time 4					A	A	A	A							5.2		
<b>C1-08</b>	Deceleration Time 4					A	A	A	A								5.2	
<b>C1-09</b>	Fast-Stop Decel. Time					B	B	B	B									5.2
<b>C1-10</b>	Accel/Decel Time Setting Unit	0 : 0.01 seconds 1 : 0.1 seconds				1	0, 1	1	A									
<b>C1-11</b>	Accel/Decel Time Switching Frequency		0.1 Hz	0.0 - 400.0	0.00	A	A	A	A	5.2								
<b>C2-01</b>	S-Curve Characteristic at Accel. Start		0.01 sec	0.0 - 2.50	0.20	A	A	A	A		5.3							
<b>C2-02</b>	S-Curve Characteristic at Accel. End		0.01 sec	0.0 - 2.50	0.20	A	A	A	A			5.3						
<b>C2-03</b>	S-Curve Characteristic at Decel. Start		0.01 sec	0.0 - 2.50	0.20	A	A	A	A				5.3					
<b>C2-04</b>	S-Curve Characteristic at Decel. End		0.01 sec	0.0 - 2.50	0.00	A	A	A	A					5.3				

**Table A1-3. Drive CX-XX Parameters – Continued**

PARAMETER NUMBER	FUNCTION NAME	DESCRIPTION	INCREMENT	SETTING RANGE	FACTORY SETTING	ACCESS LEVEL (See Note 3)				PARA. REF.
						0	1	2	3	
<b>C3-01</b>	Slip Compensation Gain		0.1	0.0 - 2.5	(See Note 1)	B	—	B	B	5.38
<b>C3-02</b>	Slip Compensation Primary Delay Time		1 ms	0 - 10000	(See Note 1)	A	—	A	—	5.38
<b>C3-03</b>	Slip Compensation Limit		1 %	0 - 250	200	A	—	A	—	5.38
<b>C3-04</b>	Slip Compensation Selection During Regeneration	0 : Disabled 1 : Enabled	1	0, 1	0	A	A	A	—	5.38
<b>C3-05</b>	Flux Select	0 : Slip Included - Flux is calculated after slip compensation is applied 1 : Slip Excluded - Flux is calculated before slip compensation is applied	1	0, 1	0	—	—	A	—	5.38
<b>C3-06</b>	Output Voltage Limit	0 : Disabled - Output voltage limit and slip compensation are disabled above base speed 1 : Enabled - Output voltage limit and slip compensation are enabled above base speed	1	0, 1	0	—	—	A	A	5.38
<b>C4-01</b>	Torque Compensation Gain		0.01	0.00 - 2.50	1.00	B	B	B	—	5.42
<b>C4-02</b>	Torque Compensation Time Constant		1 ms	0 - 10000	(See Note 1)	A	A	A	—	5.42
<b>C4-03</b>	Forward Torque Compensation At Start		0.1%	0.0 - 200.0	0.0	—	—	A	—	5.42
<b>C4-04</b>	Reverse Torque Compensation At Start		0.1%	-200.0 - 0.0	0.0	—	—	A	—	5.42
<b>C4-05</b>	Torque Compensation At Start Time Constant		1 ms	0 - 200	10	—	—	A	—	5.42

**Table A1-3. Drive CX-XX Parameters – Continued**

PARAMETER NUMBER	FUNCTION NAME	DESCRIPTION	INCREMENT	SETTING RANGE	FACTORY SETTING	ACCESS LEVEL (See Note 3)				PARA. REF.
						0	1	2	3	
<b>C5-01</b>	ASR Proportional Gain 1		0.01	0.00 - 300.00	(See Note 1)	—	B	—	B	5.7
<b>C5-02</b>	ASR Integral Time 1		0.001 sec	0.000 - 10.000	(See Note 1)	—	B	—	B	5.7
<b>C5-03</b>	ASR Proportional Gain 2		0.01	0.00 - 300.00	(See Note 1)	—	B	—	B	5.7
<b>C5-04</b>	ASR Integral Time 2		0.001 sec	0.000 - 10.000	(See Note 1)	—	B	—	B	5.7
<b>C5-05</b>	ASR Limit		0.1 %	0.0 - 20.0	5.0	—	A	—	—	
<b>C5-06</b>	ASR Primary Delay Time		0.001 sec	0.000 - 0.500	0.004	—	—	—	A	5.7
<b>C5-07</b>	ASR Switching Frequency		0.1 Hz	0.0 - 400.0	0.0	—	—	—	A	5.7
<b>C5-08</b>	ASR Integral Limit		1 %	0 - 400	400	—	—	—	A	
<b>C6-01</b>	Carrier Frequency Upper Limit		0.1 kHz	0.4 - 15.0 (See Note 2)	10.0 (See Note 2)	B	B	B	B	5.8
<b>C6-02</b>	Carrier Frequency Lower Limit		0.1 kHz	0.4 - 15.0 (See Note 2)	10.0 (See Note 2)	A	A	—	—	5.8
<b>C6-03</b>	Carrier Frequency Proportional Gain		1	00 - 99 (See Note 2)	00 (See Note 2)	A	A	—	—	5.8
<b>C7-01</b>	Hunting Prevention Selection	0 : Disabled 1 : Enabled	1	0, 1	1	A	A	—	—	5.23
<b>C7-02</b>	Hunting Prevention Gain		0.01	0.00 - 2.50	1.00	A	A	—	—	5.23

**Table A1-3. Drive CX-XX Parameters – Continued**

PARAMETER NUMBER	FUNCTION NAME	DESCRIPTION	INCREMENT	SETTING RANGE	FACTORY SETTING	ACCESS LEVEL (See Note 3)				PARA. REF.
						0	1	2	3	
<b>C8-08</b>	AFR Gain		0.01	0.00 - 10.00	1.00	—	—	A	—	5.6
<b>C8-09</b>	AFR Time		1 ms	0 - 2000	50	—	—	A	—	5.6
<b>C8-30</b>	Carrier Frequency During Auto-Tuning	0 : Fc = 2 kHz 1 : Fc = <b>C6-01</b> 2 : Fc = 5 kHz	1	0, 1	2	—	—	A	—	

NOTES:

1. Factory setting differs depending on the control method ( **A 1 - 0 2** ).
2. Setting range and factory setting differ depending on drive capacity and the control method.
3. Capability to view and set specific parameters is dependent upon the Access Level ( **A 1 - 0 1** ) and Control Method ( **A 1 - 0 2** ; 0 = V/f, 1 = V/f w/PG, 2 = Open Loop Vector, 3 = Flux Vector) the drive is programmed for. Each column represents the Access Level for a given Control Method: Q = Quick-start; B = Basic; A = Advanced; — = not available.

**Table A1-4. Drive dX-XX Parameters**

PARAMETER NUMBER	FUNCTION NAME	DESCRIPTION	INCREMENT	SETTING RANGE	FACTORY SETTING	ACCESS LEVEL (See Note 1)				PARA. REF.
						0	1	2	3	
<b>d1-01</b>	Frequency Reference 1		0.1 Hz	0.00 - 400.0	0.00	Q	Q	Q	Q	5.25 B
<b>d1-02</b>	Frequency Reference 2		0.1 Hz	0.00 - 400.0	0.00	Q	Q	Q	Q	5.25 B
<b>d1-03</b>	Frequency Reference 3		0.1 Hz	0.00 - 400.0	0.00	Q	Q	Q	Q	5.25 B
<b>d1-04</b>	Frequency Reference 4		0.1 Hz	0.00 - 400.0	0.00	Q	Q	Q	Q	5.25 B
<b>d1-05</b>	Frequency Reference 5		0.1 Hz	0.00 - 400.0	0.00	B	B	B	B	5.25 B
<b>d1-06</b>	Frequency Reference 6		0.1 Hz	0.00 - 400.0	0.00	B	B	B	B	5.25 B
<b>d1-07</b>	Frequency Reference 7		0.1 Hz	0.00 - 400.0	0.00	B	B	B	B	5.25 B
<b>d1-08</b>	Frequency Reference 8		0.1 Hz	0.00 - 400.0	0.00	B	B	B	B	5.25 B
<b>d1-09</b>	Jog Frequency Reference		0.1 Hz	0.00 - 400.0	6.00	Q	Q	Q	Q	5.24, 5.25 B
<b>d2-01</b>	Frequency Reference Upper Limit		0.1 %	0.0 - 110.0	100.0	B	B	B	B	5.22, 5.32 G
<b>d2-02</b>	Frequency Reference Lower Limit		0.1 %	0.0 - 109.0	0.0	B	B	B	B	5.22
<b>d3-01</b>	Critical Frequency Rejection 1		0.1 Hz	0.0 - 400.0	0.0	B	B	B	B	5.9
<b>d3-02</b>	Critical Frequency Rejection 2		0.1 Hz	0.0 - 400.0	0.0	B	B	B	B	5.9
<b>d3-03</b>	Critical Frequency Rejection 3		0.1 Hz	0.0 - 400.0	0.0	B	B	B	B	5.9
<b>d3-04</b>	Critical Frequency Rejection Width		0.1 Hz	0.0 - 20.0	1.0	B	B	B	B	5.9
<b>d4-01</b>	Frequency Reference Hold Function Selection	0 : Disabled 1 : Enabled	1	0, 1	0	A	A	A	A	5.21, 5.32 G

**Table A1-4. Drive dX-XX Parameters – Continued**

PARAMETER NUMBER	FUNCTION NAME	DESCRIPTION	INCREMENT	SETTING RANGE	FACTORY SETTING	ACCESS LEVEL (See Note 1)				PARA. REF.
						0	1	2	3	
<b>d4-02</b>	Trim Control Level		1 %	0 - 100	10	A	A	A	A	5.32 H
<b>d5-01</b>	Torque Control Selection	0 : Speed Control 1 : Torque Control	1	0, 1	0	—	—	—	A	5.43
<b>d5-02</b>	Torque Reference Delay Time		1 ms	0 - 1000	0	—	—	—	A	5.43
<b>d5-03</b>	Speed Limit Selection	1 : Analog input (term. 13 & 14) 2 : <b>d5-04</b> setting	1	1, 2	1	—	—	—	A	5.43
<b>d5-04</b>	Speed Limit		1 %	-120 - +120	0	—	—	—	A	5.43
<b>d5-05</b>	Speed Limit Bias		1 %	0 - 120	10	—	—	—	A	5.43
<b>d5-06</b>	Speed/Torque Control Switching Timer		1 ms	0 - 1000	0	—	—	—	A	5.43

NOTES:

1. Capability to view and set specific parameters is dependent upon the Access Level ( **A 1 - 0 1** ) and Control Method ( **A 1 - 0 2** ; 0 = V/f, 1 = V/f w/PG, 2 = Open Loop Vector, 3 = Flux Vector) the drive is programmed for. Each column represents the Access Level for a given Control Method: Q = Quick-start; B = Basic; A = Advanced; — = not available.

**Table A1-5. Drive EX-XX Parameters**

PARAMETER NUMBER	FUNCTION NAME	DESCRIPTION	INCREMENT	SETTING RANGE	FACTORY SETTING	ACCESS LEVEL (See Note 1)				PARA. REF.
						0	1	2	3	
E1-01	Input Voltage Setting		1 V	155 - 255 (230V ratings) 310 - 510 (460V ratings) 445 - 733 (600V ratings)	230 (230V ratings) 460 (460V ratings) 575 (600V ratings)	Q	Q	Q	Q	5.48
E1-02	Motor Selection	0 : General Purpose motor (TEFC) 1 : Blower Cooled motor (TENV or TEBC) 2 : Vector Motor	1	0 - 2	0	Q	Q	Q	Q	5.41
E1-03	V/f Pattern Selection	0 to E : 15 preset V/f patterns F : Custom pattern using E1-04 thru E1-10	1 H	0 - F	F	Q	Q	-	-	5.47
E1-04	Maximum Output Frequency		0.1 Hz	40.0 - 400.0	60.0	Q	Q	Q	Q	2.4, 5.48
E1-05	Maximum Voltage		0.1 V	0.0 - 255.0 (230V ratings) 0.0 - 510.0 (460V ratings) 0.0 - 733.1 (600V ratings)	230.0 (230V ratings) 460.0 (460V ratings) 575.0 (600V ratings)	Q	Q	Q	Q	2.4, 5.48
E1-06	Base Frequency		0.1 Hz	0.0 - 400.0	60.0	Q	Q	Q	Q	2.4, 5.48
E1-07	Mid. Output Frequency A		0.1 Hz	0.0 - 400.0	(See Note 1)	Q	Q	A	-	5.48
E1-08	Mid. Output Voltage A		0.1 V	0.0 - 255.0 (230V ratings) 0.0 - 510.0 (460V ratings) 0.0 - 733.1 (600V ratings)	(See Note 1) 12.6 (460V ratings) 25.3 (460V ratings) 36.3 (600V ratings)	Q	Q	A	-	5.48
E1-09	Min. Output Frequency		0.1 Hz	0.0 - 400.0	(See Note 1)	Q	Q	A	A	5.48
E1-10	Min. Output Voltage A		0.1 V	0.0 - 255.0 (230V ratings) 0.0 - 510.0 (460V ratings) 0.0 - 733.1 (600V ratings)	(See Note 1) 2.3 (460V ratings) 4.6 (460V ratings) 6.5 (600V ratings)	Q	Q	A	-	5.48
E1-11	Mid. Output Frequency B		0.1 Hz	0.0 - 400.0	0.0	A	A	A	A	5.48
E1-12	Mid. Output Voltage B		0.1 V	0.0 - 255.0 (230V ratings) 0.0 - 510.0 (460V ratings) 0.0 - 733.1 (600V ratings)	0.0	A	A	Q	Q	5.48
E1-13	Base Voltage		0.1 V	0.0 - 255.0 (230V ratings) 0.0 - 510.0 (460V ratings) 0.0 - 733.1 (600V ratings)	0.0	A	A	Q	Q	5.48

**Table A1-5. Drive EX-XX Parameters – Continued**

PARAMETER NUMBER	FUNCTION NAME	DESCRIPTION	INCREMENT	SETTING RANGE	FACTORY SETTING	ACCESS LEVEL (See Note 4)				PARA. REF.
						0	1	2	3	
E2-01	Motor Rated Current		(See Note 2)	0.00 - 1500.0	(See Note 3)	Q	Q	Q	Q	2.4, 5.41
E2-02	Motor Rated Slip		0.01 Hz	0.00 - 20.00	(See Note 3)	A	A	Q	Q	2.4
E2-03	Motor No-load Current		0.01 A	0.00 - 1500.0	(See Note 3)	A	A	Q	Q	2.4
E2-04	Number of Motor Poles		1 pole	2 - 48	4	—	Q	—	Q	2.4
E2-05	Motor Line-to-line Resistance		0.001 Ω	0.000 - 65.000	(See Note 3)	A	A	A	A	2.4
E2-06	Motor Leakage Inductance		0.1 %	0.0 - 40.0	(See Note 3)	—	—	A	A	2.4
E2-07	Motor Iron-core Saturation Coefficient 1		0.01	0.00 - 0.50	0.50	—	—	A	A	2.4
E2-08	Motor Iron-core Saturation Coefficient 2		0.01	0.50 - 0.75	0.75	—	—	A	A	2.4
E2-09	Motor Mechanical Loss		0.1 %	0.0 - 10.0	0.0	—	—	—	A	2.4
E2-10	Torque Compensation Iron Loss		1 W	0 - 65535	(See Note 3)	A	A	—	—	
E3-01	Control Method Selection (Motor 2)	0 : V/f control 1 : V/f with PG feedback 2 : Open loop vector 3 : Flux vector	1	0 - 3	2 (See Note 5)	Q	Q	Q	Q	5.45.1
E4-01	Maximum Output Frequency (Motor 2)		0.1 Hz	40.0 - 400.0	60.0	Q	Q	Q	Q	5.45.1
E4-02	Maximum Voltage (Motor 2)		0.1 V	0.0 - 255.0 (230V ratings) 0.0 - 510.0 (460V ratings) 0.0 - 733.1 (600V ratings)	230.0 (230V ratings) 460.0 (460V ratings) 575.0 (600V ratings)	Q	Q	Q	Q	5.45.1
E4-03	Base Frequency (Motor 2)		0.1 Hz	0.0 - 400.0	60.0	Q	Q	Q	Q	5.45.1
E4-04	Mid. Output Frequency (Motor 2)		0.1 Hz	0.0 - 400.0	(See Note 1)	Q	Q	Q	Q	5.45.1



**Table A1-5. Drive EX-XX Parameters – Continued**

PARAMETER NUMBER	FUNCTION NAME	DESCRIPTION	INCREMENT	SETTING RANGE	FACTORY SETTING	ACCESS LEVEL (See Note 4)				PARA. REF.
						0	1	2	3	
E4-05	Mid. Output Voltage (Motor 2)		0.1 Hz	0.0 - 255.0 (230V ratings) 0.0 - 510.0 (460V ratings) 0.0 - 733.1 (600V ratings)	(See Note 1) 12.6 (230V ratings) 25.3 (460V ratings) 36.3 (600V ratings)	Q	Q	Q	Q	5.45.1
E4-06	Min. Output Frequency (Motor 2)		0.1 Hz	0.0 - 400.0	(See Note 1)	Q	Q	Q	A	5.45.1
E4-07	Min. Output Voltage (Motor 2)		0.1 V	0.0 - 255.0 (230V ratings) 0.0 - 510.0 (460V ratings) 0.0 - 733.1 (600V ratings)	(See Note 1) 2.3 (230V ratings) 4.6 (460V ratings) 6.5 (600V ratings)	Q	Q	Q	Q	5.45.1
E5-01	Rated Current (Motor 2)		(See Note 2)	0.00 - 1500.0 (See Note 3)	(See Note 3)	Q	Q	Q	Q	5.45.1
E5-02	Rated Slip (Motor 2)		0.01 Hz	0.00 - 20.00	(See Note 3)	A	A	Q	Q	5.45.1
E5-03	No-load Current (Motor 2)		(See Note 2)	0.00 - 1500.0	(See Note 3)	A	A	Q	Q	5.45.1
E5-04	Number of Motor Poles (Motor 2)		2 poles	2 - 48	4	—	A	—	A	5.45.1
E5-05	Line-to-line Resistance (Motor 2)		0.001 Ω	0.000 - 65.000	(See Note 3)	A	A	A	A	5.45.1
E5-06	Leakage Inductance (Motor 2)		0.1%	0.0 - 40.0	(See Note 3)	—	—	A	A	5.45.1

- NOTES: 1. Factory setting differs depending on the selected Control Method ( **A 1 - 0 2** ).
2. Setting increment is 0.01A for models GPD515C-A003 thru -A033 (CIMR-G5M20P41F thru 27P51F), -B001 thru -B021 (40P41F thru 47P51F), and -C003 thru -C012 (51P51F thru 57P51F).  
Setting increment is 0.1A for models GPD515C-A049 thru -A300 (CIMR-G5M20111F thru 20750F), -B001 thru -B011 (40111F thru 43000F), and -C017 thru -C200 (50111F thru 51600F).
3. Factory setting differs depending on drive capacity.
4. Capability to view and set specific parameters is dependent upon the Access Level ( **A 1 - 0 1** ) and Control Method ( **A 1 - 0 2** ; 0 = V/f, 1 = V/f w/PG, 2 = Open Loop Vector, 3 = Flux Vector) the drive is programmed for. Each column represents the Access Level for a given Control Method: Q = Quick-start; B = Basic; A = Advanced; — = not available.
5. Settings of these parameters will not be initialized by programming **A 1 - 0 3** to "1110", "2220", or "3330".

**Table A1-6. Drive FX-XX Parameters**

PARAMETER NUMBER	FUNCTION NAME	DESCRIPTION	INCREMENT	SETTING RANGE	FACTORY SETTING	ACCESS LEVEL (See Note 2)				PARA. REF.
						0	1	2	3	
F1-01	Encoder (PG) Constant		1 ppr	0 - 60000	1024	—	Q	—	Q	2.2 B,D, 5.15 A
F1-02	Operation Selection at PG Open Circuit	0 : Ramp to stop 1 : Coast to stop 2 : Fast-stop 3 : Alarm only	1	0 - 3	1	—	B	—	B	5.15 B
F1-03	Operation Selection at Overspeed	0 : Ramp to stop 1 : Coast to stop 2 : Fast-stop 3 : Alarm only	1	0 - 3	1	—	B	—	B	5.15 C
F1-04	Operation Selection at Speed Deviation	0 : Ramp to stop 1 : Coast to stop 2 : Fast-stop 3 : Alarm only	1	0 - 3	3	—	B	—	B	5.15 D
F1-05	PG Rotation	0 : Counter-clockwise 1 : Clockwise	1	0, 1	0	—	B	—	B	5.15 E
F1-06	PG Division Rate (PG Pulse Monitor)	Effective only with control circuit board PG-B2	1	1 - 132	1	—	B	—	B	Separate Opt. Instr. Sheet
F1-07	Integral Value During Accel/Decel Selection	0 : Disabled 1 : Enable	1	0, 1	0	—	B	—	—	5.15 F
F1-08	Overspeed Detection Level		1 %	0 - 120	115	—	A	—	A	5.15 C
F1-09	Overspeed Detection Delay Time		0.1 sec	0.0 - 2.0	(See Note 1)	—	A	—	A	5.15 C
F1-10	Excessive Speed Deviation Detection Level		1 %	0 - 50	10	—	A	—	A	5.15 D
F1-11	Excessive Speed Deviation Detection Delay Time		0.1 sec	0.0 - 10.0	0.5	—	A	—	A	5.15 D
F1-12	Number of PG Gear Teeth 1		1	0 - 1000	0	—	A	—	—	5.15 G
F1-13	Number of PG Gear Teeth 2		1	0 - 1000	0	—	A	—	—	5.15 G
F1-14	PGo Detect Time		0.1 sec	0.0 - 10.0	2.0	—	A	—	A	5.15 B

**Table A1-6. Drive FX-XX Parameters – Continued**

PARAMETER NUMBER	FUNCTION NAME	DESCRIPTION	INCREMENT	SETTING RANGE	FACTORY SETTING	ACCESS LEVEL (See Note 2)				PARA. REF.
						0	1	2	3	
<b>F2-01</b>	AI-14 Bi-polar or Uni-polar Input Selection	0 : 3-channel individual 1 : 3-channel addition	1	0, 1	0	B	B	B	—	Separate Option Instr. Sheet
<b>F3-01</b>	DI-16 Digital Input Option	0 : BCD 1%      5 : BCD 0.01 Hz 1 : BCD 0.1 %    6 : BCD (5DG) 2 : BCD 0.01 %    0.01 Hz 3 : BCD 1 Hz      7 : Binary 4 : BCD 0.1 Hz	1	0 - 7	0	B	B	B	B	Separate Option Instr. Sheet
<b>F4-01</b>	AO-08 / AO-12 Channel 1 Monitor Selection		1	1 - 38	2	B	B	B	B	Separate Option Instr. Sheet
<b>F4-02</b>	AO-08 / AO-12 Channel 1 Gain		0.01	0.00 - 2.50	1.00	B	B	B	B	Separate Option Instr. Sheet
<b>F4-03</b>	AO-08 / AO-12 Channel 2 Monitor Selection		1	1 - 38	3	B	B	B	B	Separate Option Instr. Sheet
<b>F4-04</b>	AO-08 / AO-12 Channel 2 Gain		0.01	0.00 - 2.50	0.50	B	B	B	B	Separate Option Instr. Sheet
<b>F4-05</b>	AO-08 / AO-12 Channel 1 Bias		0.1%	-10.0 - 10.0	0.0	B	B	B	B	Separate Option Instr. Sheet
<b>F4-06</b>	AO-08 / AO-12 Channel 2 Bias		0.1%	-10.0 - 10.0	0.0	B	B	B	B	Separate Option Instr. Sheet
<b>F5-01</b>	DO-02 Channel 1 Output Selection		1	0 - 37	0	B	B	B	B	Separate Option Instr. Sheet
<b>F5-02</b>	DO-02 Channel 2 Output Selection		1	0 - 37	1	B	B	B	B	Separate Option Instr. Sheet
<b>F6-01</b>	DO-08 Output Mode Selection	0 : 8-channel individual 1 : Binary output	1	0, 1	0	B	B	B	B	Separate Option Instr. Sheet
<b>F7-01</b>	PO-36F Frequency Multiple Selection	0 : 1 x Output frequency 1 : 6 x Output frequency 2 : 10 x Output frequency 3 : 12 x Output frequency 4 : 36 x Output frequency	1	0 - 4	1	B	B	B	B	Separate Option Instr. Sheet

**Table A1-6. Drive FX-XX Parameters – Continued**

PARAMETER NUMBER	FUNCTION NAME	DESCRIPTION	INCREMENT	SETTING RANGE	FACTORY SETTING	ACCESS LEVEL (See Note 2)				PARA. REF.
						0	1	2	3	
<b>F8-01</b>	Communication Error (E-15) Detection Selection	0 : Rampt to Stop 1 : Coast to Stop 2 : Fast Stop 3 : Alarm Only	1	0, 1	1	B	B	B	—	
<b>F9-01</b>	Option External Fault (EFO) Selection	0 : Normally Open 1 : Normally Closed	1	0, 1	0	A	A	A	A	
<b>F9-02</b>	Option External Fault (EFO) Detection	0 : Always Detected 1 : Only During Run	1	0, 1	0	A	A	A	A	
<b>F9-03</b>	Option External Fault (EFO) Action	0 : Ramp to Stop 1 : Coast to Stop 2 : Fast Stop 3 : Alarm Only	1	0 - 3	1	A	A	A	A	
<b>F9-04</b>	Trace Sample Time		1	0 - 60,000	0	A	A	A	A	
<b>F9-05</b>	Torque Reference Limit Selection	0 : Disabled 1 : Enabled	1	0, 1	1	—	—	—	A	
<b>F9-06</b>	DP-RAM Communication (BUS) Fault Selection	0 : Ramp to Stop 1 : Coast to Stop 2 : Fast Stop 3 : Alarm Only	1	0 - 3	1	A	A	A	A	

NOTES:

1. Factory setting differs depending on the selected Control Method ( **A 1 - 0 2** ) - see Table A3-2.
2. Capability to view and set specific parameters is dependent upon the Access Level ( **A 1 - 0 1** ) and Control Method ( **A 1 - 0 2** ; 0 = V/f, 1 = V/f w/PG, 2 = Open Loop Vector, 3 = Flux Vector) the drive is programmed for. Each column represents the Access Level for a given Control Method: Q = Quick-start; B = Basic; A = Advanced; — = not available.

**Table A1-7. Drive HX-XX Parameters**

PARAMETER NUMBER	FUNCTION NAME	DESCRIPTION	INCREMENT	SETTING RANGE	FACTORY SETTING	ACCESS LEVEL (See Note 2)				PARA. REF.
						0	1	2	3	
H1-01	Multi-function Input (Terminal 3)		1	0 - 77	24	B	B	B	B	5.16, 5.25, 5.32
H1-02	Multi-function Input (Terminal 4)		1	0 - 77	14	B	B	B	B	5.16, 5.25, 5.32
H1-03	Multi-function Input (Terminal 5)		1	0 - 77	3 (0) (See Note 1)	B	B	B	B	5.16, 5.25, 5.32
H1-04	Multi-function Input (Terminal 6)		1	0 - 77	4 (3) (See Note 1)	B	B	B	B	5.16, 5.25, 5.32
H1-05	Multi-function Input (Terminal 7)		1	0 - 77	6 (4) (See Note 1)	B	B	B	B	5.16, 5.25, 5.32
H1-06	Multi-function Input (Terminal 8)		1	0 - 77	8 (6) (See Note 1)	B	B	B	B	5.16, 5.25, 5.32
H2-01	Multi-function Output (Term. 9 & 10)		1	0 - 37	0	B	B	B	B	5.33
H2-02	Multi-function Output (Term. 25-27)		1	0 - 37	1	B	B	B	B	5.33
H2-03	Multi-function Output (Term. 26-27)		1	0 - 37	2	B	B	B	B	5.33
H3-01	Auto Speed Reference Signal Level Selection (Terminal 13)	0 : 0 to 10 VDC 1 : ±10 VDC	1	0, 1	0	B	B	B	B	5.19
H3-02	Auto Speed Reference Signal Gain (Terminal 13)		0.1 %	0.0 - 1000.0	100.0	B	B	B	B	5.18
H3-03	Auto Speed Reference Signal Bias (Terminal 13)		0.1 %	-100.0 - +100.0	0.0	B	B	B	B	5.18

**Table A1-7. Drive HX-XX Parameters – Continued**

PARAMETER NUMBER	FUNCTION NAME	DESCRIPTION	INCREMENT	SETTING RANGE	FACTORY SETTING	ACCESS LEVEL (See Note 2)				PARA. REF.
						0	1	2	3	
H3-04	Multi-function Analog Input 1 Signal Level Selection (Terminal 16)	0 : 0 to 10 VDC 1 : ±10 VDC	1	0, 1	0	B	B	B	B	5.19
H3-05	Multi-function Analog Input 1 Selection (Terminal 16)		1	0 - 1F	0	B	B	B	B	5.30
H3-06	Multi-function Analog Input 1 Gain (Terminal 16)		0.1 %	0.0 - 1000.0	100.0	B	B	B	B	5.18
H3-07	Multi-function Analog Input 1 Bias (Terminal 16)		0.1 %	-100.0 - +100.0	0.0	B	B	B	B	5.18
H3-08	Multi-function Analog Input 2 Signal Level Selection (Terminal 14)	0 : 0 to 10 VDC 1 : ±10 VDC 2 : 4-20 mA	1	0 - 2	2	A	A	A	A	5.19
H3-09	Multi-function Analog Input 2 Selection (Terminal 14)		1	0 - 1F	1F	A	A	A	A	5.30
H3-10	Multi-function Analog Input 2 Gain (Terminal 14)		0.1 %	0.0 - 1000.0	100.0	A	A	A	A	5.18
H3-11	Multi-function Analog Input 2 Bias (Terminal 14)		0.1 %	-100.0 - +100.0	0.0	A	A	A	A	5.18
H3-12	Analog Input Filter Time Constant		0.01 sec	0.00 - 2.00	0.00	A	A	A	A	
H4-01	Multi-function Analog Monitor 1 Selection (Terminal 21)		1	1 - 38	2	B	B	B	B	5.31
H4-02	Multi-function Analog Monitor 1 Gain (Terminal 21)		0.01	0.00 - 2.50	1.00	B	B	B	B	5.31

**Table A1-7. Drive HX-XX Parameters – Continued**

PARAMETER NUMBER	FUNCTION NAME	DESCRIPTION	INCREMENT	SETTING RANGE	FACTORY SETTING	ACCESS LEVEL (See Note 2)				PARA. REF.
						0	1	2	3	
<b>H4-03</b>	Multi-function Analog Monitor 1 Bias (Terminal 21)		0.1 %	-10.0 - +10.0	0.0	B	B	B	B	5.31
<b>H4-04</b>	Multi-function Analog Monitor 2 Selection (Terminal 23)		1	1 - 38	3	B	B	B	B	5.31
<b>H4-05</b>	Multi-function Analog Monitor 2 Gain (Terminal 23)		0.01	0.00 - 2.50	0.50	B	B	B	B	5.31
<b>H4-06</b>	Multi-function Analog Monitor 2 Bias (Terminal 23)		0.1 %	-10.0 - +10.0	0.0	B	B	B	B	5.31
<b>H4-07</b>	Multi-function Analog Monitor Signal Level Selection (Term. 21 & 23)	0 : 0 to 10 VDC 1 : ±10 VDC	1	0, 1	0	B	B	B	B	5.31
<b>H5-01</b>	Serial Comm. Station Address		1	0 - 1F	1F	A	A	A	A	5.28
<b>H5-02</b>	Serial Comm. Baud Rate	0 : 1200 baud 1 : 2400 baud 2 : 4800 baud 3 : 9600 baud 4 : 19.2 kbaud	1	0 - 4	3	A	A	A	A	5.28
<b>H5-03</b>	Serial Comm. Parity Select	0 : No parity 1 : Even parity 2 : Odd parity	1	0 - 2	0	A	A	A	A	5.28
<b>H5-04</b>	Stopping Method After Serial Comm. Error	0 : Ramp to stop 1 : Coast to stop 2 : Fast-stop 3 : Alarm only	1	0 - 3	3	A	A	A	A	5.28
<b>H5-05</b>	Serial Comm. Fault Detect	0 : Disabled 1 : Enabled	1	0, 1	1	A	A	A	A	5.28

NOTES:

1. Factory settings in the parentheses are values obtained at a 3-wire initialization.
2. Capability to view and set specific parameters is dependent upon the Access Level ( **A 1 - 0 1** ) and Control Method ( **A 1 - 0 2** ; 0 = V/f, 1 = V/f w/PG, 2 = Open Loop Vector, 3 = Flux Vector) the drive is programmed for. Each column represents the Access Level for a given Control Method: Q = Quick-start; B = Basic; A = Advanced; — = not available.

**Table A1-8. Drive LX-XX Parameters**

PARAMETER NUMBER	FUNCTION NAME	DESCRIPTION	INCREMENT	SETTING RANGE	FACTORY SETTING	ACCESS LEVEL (See Note 4)				PARA. REF.
						0	1	2	3	
L1-01	Motor Overload Protection Selection	0 : Disabled 1 : Enabled (Coast to Stop)	1	0, 1	1	B	B	B	B	5.41
L1-02	Motor Overload Protection Time Constant		0.1 min	0.1 - 20.0	8.0	B	B	B	B	5.41
L2-01	Momentary Power Loss Detection Selection	0 : Disabled 1 : Power loss ride-thru 2 : CPU power active	1	0 - 2	0	B	B	B	B	5.29
L2-02	Momentary Power Loss Ride-thru Time		0.1 sec	0.0 - 2.0	(See Note 1)	B	B	B	B	5.29
L2-03	Momentary Power Loss Minimum Base Block Time		0.1 sec	0.1 - 5.0	(See Note 1)	B	B	B	B	5.32 D
L2-04	Momentary Power Loss Recovery Ramp Time		0.1 sec	0.0 - 5.0	(See Note 1)	A	A	A	A	5.32 D
L2-05	Undervoltage Detection Level		1 V sec	150 - 210 (230V ratings) 300 - 420 (460V ratings) 431 - 603 (600V ratings)	190 (230V ratings) 380 (460V ratings) 546 (600V ratings)	A	A	A	A	5.29
L2-06	KEB Frequency		0.1 %	0.0 - 100.0	0.0	A	A	A	A	
L3-01	Stall Prevention Selection During Accel	0 : Disabled 1 : General-purpose 2 : Intelligent (See Note 2)	1	0 - 2	1	B	B	B	—	5.39
L3-02	Stall Prevention Level During Accel		1 %	0 - 200	150	B	B	B	—	5.39
L3-03	Stall Prevention Level During Accel (CHP)		1 %	0 - 100	50	A	A	A	—	5.39
L3-04	Stall Prevention Selection During Decel	0 : Disabled 1 : General-purpose 2 : Intelligent (See Note 2) 3 : Stall Prevent w/Resistor	1	0 - 3	1	B	B	B	B	5.39



**Table A1-8. Drive LX-XX Parameters – Continued**

PARAMETER NUMBER	FUNCTION NAME	DESCRIPTION	INCREMENT	SETTING RANGE	FACTORY SETTING	ACCESS LEVEL (See Note 4)				PARA. REF.
						0	1	2	3	
L3-05	Stall Prevention Selection During Running	0 : Disabled 1 : Decel time 1 2 : Decel time 2	1	0 - 2	1	B	B	—	—	5.39
L3-06	Stall Prevention Level During Running		1 %	30 - 200	160	B	B	—	—	5.39
L4-01	Speed Coincidence Frequency		0.1 Hz	0.0 - 400.0	0.0	B	B	B	B	5.33
L4-02	Speed Coincidence Width		0.1 Hz	0.0 - 20.0	2.0	B	B	B	B	5.33
L4-03	Speed Coincidence Frequency (±)		0.1 Hz	-400.0 - +400.0	0.0	A	A	A	A	5.33
L4-04	Speed Coincidence Width (±)		0.1 Hz	0.0 - 20.0	2.0	A	A	A	A	5.33
L4-05	Frequency Reference Loss Detection Selection	0 : Stop 1 : Run at 80% of frequency reference	1	0, 1	0	A	A	A	A	5.20
L5-01	Number of Auto Restart Attempts		1 time	0 - 10	0	B	B	B	B	5.5
L5-02	Auto Restart Operation Selection	0 : No fault relay 1 : Fault relay active	1	0, 1	0	B	B	B	B	5.5
L6-01	Torque Detection Selection 1	0 : Disabled 1 : Detected during speed agree, and operation continues after detection 2 : Detected during running, and operation continues after detection 3 : Detected during speed agree, and drive faults 4 : Detected during running, and drive faults	1	0 - 4	0	B	B	B	B	5.44

**Table A1-8. Drive LX-XX Parameters – Continued**

PARAMETER NUMBER	FUNCTION NAME	DESCRIPTION	INCREMENT	SETTING RANGE	FACTORY SETTING	ACCESS LEVEL (See Note 4)				PARA. REF.
						0	1	2	3	
L6-02	Torque Detection Level 1		1 %	0 - 300	150	B	B	B	B	5.44
L6-03	Torque Detection Time 1		0.1 sec	0.0 - 10.0	0.1	B	B	B	B	5.44
L6-04	Torque Detection Selection 2	0 : Disabled 1 : Detected during speed agree, and operation continues after detection 2 : Detected during running, and operation continues after detection 3 : Detected during speed agree, and drive faults 4 : Detected during running, and drive faults	1	0 - 4	0	A	A	A	A	5.44
L6-05	Torque Detection Level 2		1 %	0 - 300	150	A	A	A	A	5.44
L6-06	Torque Detection Time 2		0.1 sec	0.0 - 10.0	0.1	A	A	A	A	5.44
L7-01	Forward Torque Limit		1 %	0 - 300	200	—	—	B	B	5.45
L7-02	Reverse Torque Limit		1 %	0 - 300	200	—	—	B	B	5.45
L7-03	Forward Regenerative Torque Limit		1 %	0 - 300	200	—	—	B	B	5.45
L7-04	Reverse Regenerative Torque Limit		1 %	0 - 300	200	—	—	B	B	5.45
L8-01	Internal Dynamic Braking Resistor Protection	0 : Not provided 1 : Provided	1	0, 1	0	B	B	B	B	5.27
L8-02	OH (Overheat) Protection Alarm Level		1 °C	50 - 130	(See Note 1)	A	A	A	A	5.27

**Table A1-8. Drive LX-XX Parameters – Continued**

PARAMETER NUMBER	FUNCTION NAME	DESCRIPTION	INCREMENT	SETTING RANGE	FACTORY SETTING	ACCESS LEVEL (See Note 4)				PARA. REF.
						0	1	2	3	
<b>L8-03</b>	Operation Selection After OH (Overheat) Pre-alarm	0 : Ramp to stop 1 : Coast to stop 2 : Fast-stop 3 : Alarm only	1	0 - 3	3	A	A	A	A	5.27
<b>L8-05</b>	Input Open-phase Protection Selection	0 : Disabled 1 : Enabled	1	0, 1	0	A	A	A	A	5.34
<b>L8-07</b>	Output Open-phase Protection Selection	0 : Disabled 1 : Enabled	1	0, 1	1	A	A	A	A	5.35
<b>L8-10</b>	Output Ground Fault Detection Selection	0 : Disabled 1 : Enabled	1	0, 1	1	A	A	A	A	5.27
<b>L8-17</b>	IGBT Protection at Low Frequency	0 : Conventional 1 : Lower carrier frequency when I > 100% and Fout < 10.0 Hz 2 : Short Term OL2 (2 seconds if Fout < 6.0 Hz and I > 175%) 3 : Limit current to 150%	1	0 - 3	1	A	A	A	—	5.27
<b>L8-19</b>	OL2 Selection at Low Speed	0 : Low frequency OL2 disabled 1 : Low frequency OL2 enabled	1	0, 1	0	A	A	A	A	5.27

NOTES:

1. Factory setting differs depending on drive capacity.
2. When Vector control ( **A 1 - 0 2** = 2 or 3) is selected, set value 2 (Intelligent) cannot be set.
3. Factory setting differs depending on the Control Method selected by ( **A 1 - 0 2** ).
4. Capability to view and set specific parameters is dependent upon the Access Level ( **A 1 - 0 1** ) and Control Method ( **A 1 - 0 2** ; 0 = V/f, 1 = V/f w/PG, 2 = Open Loop Vector, 3 = Flux Vector) the drive is programmed for. Each column represents the Access Level for a given Control Method: Q = Quick-start; B = Basic; A = Advanced; — = not available.

**Table A1-9. Drive oX-XX Parameters**

PARAMETER NUMBER	FUNCTION NAME	DESCRIPTION	INCREMENT	SETTING RANGE	FACTORY SETTING	ACCESS LEVEL (See Note 2)				PARA. REF.
						0	1	2	3	
<b>o1-01</b>	Monitor Selection		1	4 - 38	6	B	B	B	B	5.12
<b>o1-02</b>	Monitor Selection After Power-up	1 : Frequency reference 2 : Output frequency 3 : Output current 4 : Selected monitor	1	1 - 4	1	B	B	B	B	5.12
<b>o1-03</b>	Digital Operator Display Selection		1	0 - 39999	0	B	B	B	B	5.11
<b>o1-04</b>	Digital Operator Display Units	0 : Hz 1 : RPM	1	0, 1	0	—	—	—	B	5.11
<b>o1-05</b>	Parameter / Address Display Selection	0 : Parameter number 1 : MODBUS address	1	0, 1	0	A	A	A	A	5.11
<b>o2-01</b>	LOCAL/REMOTE Key Selection	0 : Disabled 1 : Enabled	1	0, 1	1	B	B	B	B	5.26
<b>o2-02</b>	STOP Key Function During Remote Run	0 : Disabled 1 : Enabled	1	0, 1	1	B	B	B	B	5.26
<b>o2-03</b>	User Parameter Default Value	0 : Disabled 1 : Set default 2 : Clear all	1	0 - 2	0	B	B	B	B	5.46
<b>o2-04</b>	kVA Selection (Drive Model No.)		1	0 - FF	(See Note 1)	B	B	B	B	Table A3-1
<b>o2-05</b>	Digital Operator "Motor Operated Pot"	0 : Drive accepts frequency command after ENTER is pressed 1 : Drive accepts frequency command immediately	1	0, 1	0	A	A	A	A	5.26
<b>o2-06</b>	Operation Selection When Digital Operator is Disconnected	0 : Disabled (operation continues) 1 : Enabled (motor coasts to stop and fault is displayed)	1	0, 1	1	A	A	A	A	5.26
<b>o2-07</b>	Elapsed Operating Hour Timer Set		1 hour	0 - 65535	—	A	A	A	A	5.26

**Table A1-9. Drive oX-XX Parameters – Continued**

PARAMETER NUMBER	FUNCTION NAME	DESCRIPTION	INCREMENT	SETTING RANGE	FACTORY SETTING	ACCESS LEVEL (See Note 2)				PARA. REF.
						0	1	2	3	
<b>o2-08</b>	Elapsed Operating Hour Timer Selection	0 : Timer active whenever power is applied to drive 1 : Timer active whenever drive is in "run" mode	1	0, 1	0	A	A	A	A	5.26
<b>o2-09</b>	Initial Mode Selection	0 : Japanese Spec. 1 : American Spec. 2 : European Spec.	1	0 - 2	1	A	A	A	A	

NOTES:

1. Not initialized. Factory setting differs depending on the drive capacity.
2. Capability to view and set specific parameters is dependent upon the Access Level ( **A 1 - 0 1** ) and Control Method ( **A 1 - 0 2**; 0 = V/f, 1 = V/f w/PG, 2 = Open Loop Vector, 3 = Flux Vector) the drive is programmed for. Each column represents the Access Level for a given Control Method: Q = Quick-start; B = Basic; A = Advanced; — = not available.

**Table A1-10. Drive UX-XX Parameters**

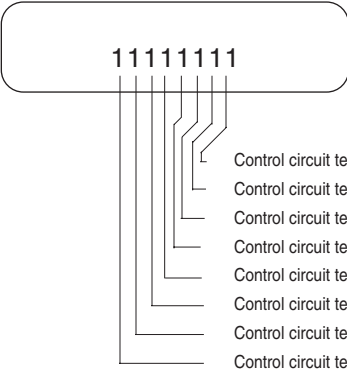
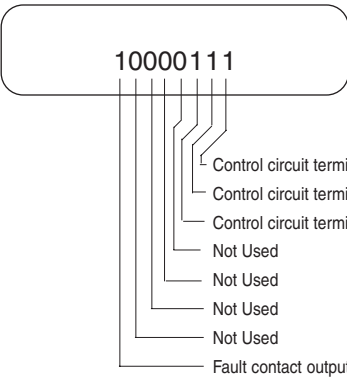
PARAMETER NUMBER	MONITOR ITEM	DESCRIPTION	DISPLAY UNIT	ANALOG MONITOR OUTPUT LEVEL	ACCESS LEVEL (See Note 3)			
					0	1	2	3
<b>U1-01</b>	Frequency Reference		(See Note 1)	10V / max. output freq. ( E1-04 )	○	○	○	○
<b>U1-02</b>	Output Frequency		(See Note 1)	10V / max. output freq. ( E1-04 )	○	○	○	○
<b>U1-03</b>	Output Current		(See Note 2)	10V / drive rated current	○	○	○	○
<b>U1-04</b> (4)	Control Method	0 : V/f control 1 : V/f with PG feedback 2 : Open loop vector 3 : Flux vector	—	—	○	○	○	○
<b>U1-05</b> (4)	Motor Speed		0.01 Hz	10V / max. output freq. ( E1-04 or E4-01 )	—	○	○	○
<b>U1-06</b>	Output Voltage		0.1 V	10V / 230V or 10V / 460V or 10V / 575V	○	○	○	○
<b>U1-07</b> (4)	DC Bus Voltage		0.1 V	10V / 400V or 10V / 800V or 10V / 1150V	○	○	○	○
<b>U1-08</b> (4)	Output Power		0.1 kW	10V / drive capacity (kW)	○	○	○	○
<b>U1-09</b> (4)	Torque Reference (internal)		0.1 %	10V / motor rated torque	—	—	○	○
<b>U1-10</b> (4)	Input Terminal Status	 <p>Control circuit terminal 1 : "Closed" Control circuit terminal 2 : "Closed" Control circuit terminal 3 : "Closed" Control circuit terminal 4 : "Closed" Control circuit terminal 5 : "Closed" Control circuit terminal 6 : "Closed" Control circuit terminal 7 : "Closed" Control circuit terminal 8 : "Closed"</p>	—	—	○	○	○	○
<b>U1-11</b> (4)	Output Terminal Status	 <p>Control circuit terminals 9-10 : "Closed" Control circuit terminal 25 : "Closed" Control circuit terminal 26 : "Closed" Not Used Not Used Not Used Not Used Fault contact output active</p>	—	—	○	○	○	○

**Table A1-10. Drive UX-XX Parameters – Continued**

PARAMETER NUMBER	MONITOR ITEM	DESCRIPTION	DISPLAY UNIT	ANALOG MONITOR OUTPUT LEVEL	ACCESS LEVEL (See Note 3)			
					0	1	2	3
<b>U1-12</b> (4)	Operation Status		—	—	O	O	O	O
<b>U1-13</b> (4)	Elapsed Operation Time		1 hour	—	O	O	O	O
<b>U1-14</b> (4)	Software No. (Flash ID No.)	EXAMPLE: 01114	—	—	O	O	O	O
<b>U1-15</b> (4)	Control Circuit Terminal 13 Input Voltage		0.1 %	10V / 10V	B	B	B	B
<b>U1-16</b> (4)	Control Circuit Terminal 14 Input Voltage		0.1 %	10V / 10V or 10V / 20mA	B	B	B	B
<b>U1-17</b> (4)	Control Circuit Terminal 16 Input Voltage		0.1 %	10V / 10V	B	B	B	B
<b>U1-18</b> (4)	Motor Secondary Current (Iq)		0.1 %	10V / motor rated primary current ( E2-01 )	B	B	B	B
<b>U1-19</b> (4)	Motor Exciting Current		0.1 %	10V / motor rated primary current ( E2-01 )	—	—	B	B
<b>U1-20</b> (4)	Output Frequency After Soft-start		0.01 Hz	10V / max. output freq. ( E1-04 )	A	A	A	A
<b>U1-21</b> (4)	Automatic Speed Regulator Input		0.01 %	10V / max. output freq. ( E1-04 )	—	A	—	A
<b>U1-22</b> (4)	Automatic Speed Regulator Output	Analog monitor output level becomes 10V / max output frequency with V/F control.	0.01 %	10V / motor rated primary current ( E2-01 )	—	A	—	A

**Table A1-10. Drive UX-XX Parameters – Continued**

PARAMETER NUMBER	MONITOR ITEM	DESCRIPTION	DISPLAY UNIT	ANALOG MONITOR OUTPUT LEVEL	ACCESS LEVEL (See Note 3)			
					0	1	2	3
<b>U1-23</b> (4)	Speed Deviation Regulator Input		0.01 %	10V / max. output freq. ( <b>E1-04</b> )	—	A	—	A
<b>U1-24</b> (4)	PID Feedback Amount		0.01 %	10V / max. output freq. ( <b>E1-04</b> )	A	A	A	A
<b>U1-25</b> (4)	DI-16H Input Status	Displays an input value according to the setting of <b>F3-01</b> .	—	—	A	A	A	A
<b>U1-26</b> (4)	Output Voltage Reference Vq		0.1 V	10V / 230V or 10V / 460V or 10V / 575V	—	—	A	A
<b>U1-27</b> (4)	Output Voltage Reference Vd		0.1 V	10V / 230V or 10V / 460V or 10V / 575V	—	—	A	A
<b>U1-28</b> (4)	CPU ID No.	EXAMPLE: <b>00110</b>	—	—	A	A	A	A
<b>U1-32</b> (4)	ACR (q-Axis) Output		0.1 %		—	—	A	A
<b>U1-33</b> (4)	ACR (d-Axis) Output		0.1 %		—	—	A	A
<b>U1-34</b> (4)	OPE Detected		—	—	A	A	A	A
<b>U1-35</b> (4)	Zero-Servo Pulse Count	Only available with Zero-Servo function in Flux Vector control.	1 pulse	—	—	—	—	A
<b>U1-36</b>	PID Input	Displays PID Error (Setpoint minus Feedback)	0.01%	10V / 100%	A	A	A	A
<b>U1-37</b>	PID Output	Displays PID Output (100% = <b>E1-04</b> )	0.01%	10V / 100%	A	A	A	A
<b>U1-38</b>	PID Setpoint		0.01%	10V / 100%	A	A	A	A
<b>U2-01</b>	Current Fault		—	—	O	O	O	O
<b>U2-02</b>	Last Fault		—	—	O	O	O	O
<b>U2-03</b>	Frequency Reference	At time of most recent fault	0.01 Hz	—	O	O	O	O
<b>U2-04</b>	Output Frequency	At time of most recent fault	0.01 Hz	—	O	O	O	O
<b>U2-05</b>	Output Current	At time of most recent fault	(See Note 2)	—	O	O	O	O

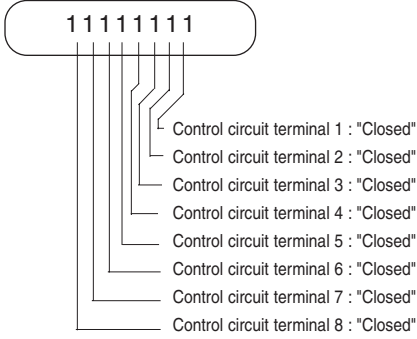
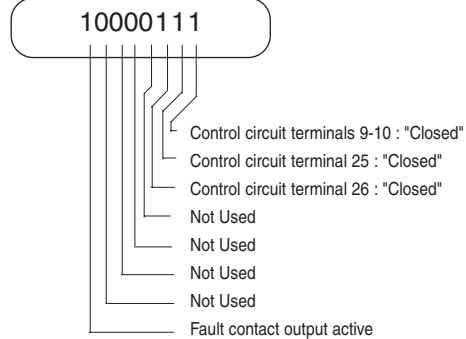
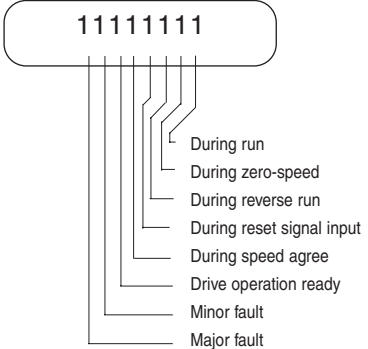

**Table A1-10. Drive UX-XX Parameters – Continued**

PARAMETER NUMBER	MONITOR ITEM	DESCRIPTION	DISPLAY UNIT	ANALOG MONITOR OUTPUT LEVEL	ACCESS LEVEL (See Note 3)			
					0	1	2	3
U2-06	Motor Speed	At time of most recent fault	0.01 Hz	—	○	○	○	○
U2-07	Output Voltage	At time of most recent fault	0.1 V	—	○	○	○	○
U2-08	DC Bus Voltage	At time of most recent fault	1 V	—	○	○	○	○
U2-09	Output kWatts	At time of most recent fault	0.1 kW	—	○	○	○	○
U2-10	Torque Reference	At time of most recent fault	0.1 %	—	—	—	—	○
U2-11	Input Terminal Status	At time of most recent fault 	—	—	○	○	○	○
U2-12	Output Terminal Status	At time of most recent fault 	—	—	○	○	○	○
U2-13	Inverter Status	At time of most recent fault 	—	—	○	○	○	○
U2-14	Elapsed Time	At time of most recent fault	1 hour	—	○	○	○	○
U3-01	Last Fault	Most recent fault	—	—	○	○	○	○
U3-02	Fault Message 2	2nd most recent fault	—	—	○	○	○	○

**Table A1-10. Drive UX-XX Parameters – Continued**

PARAMETER NUMBER	MONITOR ITEM	DESCRIPTION	DISPLAY UNIT	ANALOG MONITOR OUTPUT LEVEL	ACCESS LEVEL (See Note 3)			
					0	1	2	3
<b>U3-03</b>	Fault Message 3	3rd most recent fault	—	—	O	O	O	O
<b>U3-04</b>	Fault Message 4	4th most recent (oldest) fault	—	—	O	O	O	O
<b>U3-05</b>	Elapsed Time 1	Of most recent fault	1 hour	—	O	O	O	O
<b>U3-06</b>	Elapsed Time 2	Of 2nd most recent fault	1 hour	—	O	O	O	O
<b>U3-07</b>	Elapsed Time 3	Of 3rd most recent fault	1 hour	—	O	O	O	O
<b>U3-08</b>	Elapsed Time 4	Of oldest fault	1 hour	—	O	O	O	O

NOTES:

1. Display unit differs depending on setting of **o 1-03**.
2. Display unit = 0.01A for models GPD515C-A003 thru -A033 (CIMR-G5M20P41F thru 27P51F), -B001 thru -B021 (40P41F thru 47P51F), and -C003 thru -C012 (51P51F thru 57P51F).  
Display unit = 0.1A for models GPD515C-A049 thru -A300 (CIMR-G5M20111F thru 20750F), -B001 thru -B011 (40111F thru 43000F), and -C017 thru -C200 (50111F thru 51600F).
3. Capability to view and set specific parameters is dependent upon the Access Level (**A 1-01**) and Control Method (**A 1-02**; 0 = V/f, 1 = V/f w/PG, 2 = Open Loop Vector, 3 = Flux Vector) the drive is programmed for. Each column represents the Access Level for a given Control Method: Q = Quick-start; B = Basic; A = Advanced; — = not available.
4. Monitor items **U 1-04**, **U 1-05**, and **U 1-07** through **U 1-35** can only be viewed from within the **U 1** Monitor Parameter function (i.e. press “down arrow” key, then **DATA / ENTER**, then scroll up or down to view the desired monitor item). See paragraph 4.3, Digital Operator Menu Trees for more details.

**Table A1-11. Run Operative Parameters**

PARAMETER NUMBER	FUNCTION NAME	PARA. REF.
<b>A1-00</b>	Language Selection	2.3
<b>A1-01</b>	Parameter Access Level	Table A1-1
<b>b5-02</b>	Proportional Gain	5.36
<b>b5-03</b>	Integral Time	5.36
<b>b5-04</b>	Integral Value Limit	5.36
<b>b5-05</b>	Derivative Time	5.36
<b>b5-06</b>	PID Limit	5.36
<b>b5-07</b>	Offset	5.36
<b>b5-08</b>	Output Lag Filter Time	5.36
<b>C1-01</b>	Acceleration Time 1	5.2
<b>C1-02</b>	Deceleration Time 1	5.2
<b>C1-03</b>	Acceleration Time 2	5.2
<b>C1-04</b>	Deceleration Time 2	5.2
<b>C1-10</b>	Accel/Decel Time Setting Unit	5.2
<b>C3-01</b>	Slip Compensation Time	5.38
<b>C4-01</b>	Torque Compensation Gain	5.42
<b>C5-01</b>	ASR Proportional Gain 1	5.7
<b>C5-02</b>	ASR Integral Time 1	5.7
<b>C5-03</b>	ASR Proportional Gain 2	5.7
<b>C5-04</b>	ASR Integral Time 2	5.7
<b>d1-01</b>	Frequency Reference 1	5.23, 5.25 B
<b>d1-02</b>	Frequency Reference 2	5.23, 5.25 B
<b>d1-03</b>	Frequency Reference 3	5.23, 5.25 B
<b>d1-04</b>	Frequency Reference 4	5.23, 5.25 B
<b>d1-05</b>	Frequency Reference 5	5.23, 5.25 B
<b>d1-06</b>	Frequency Reference 6	5.23, 5.25 B
<b>d1-07</b>	Frequency Reference 7	5.23, 5.25 B
<b>d1-08</b>	Frequency Reference 8	5.23, 5.25 B
<b>d1-09</b>	Jog Frequency Reference	5.23, 5.25 B
<b>F4-02</b>	AO-08 / AO-12 Channel 1 Gain	Option Instr. Sheet
<b>F4-04</b>	AO-08 / AO-12 Channel 2 Gain	Option Instr. Sheet
<b>H3-02</b>	Auto Speed Reference Signal Gain (Term. 13)	5.18
<b>H3-03</b>	Auto Speed Reference Signal Bias (Term. 13)	5.18
<b>H3-06</b>	Multi-function Analog Input 1 Gain (Term. 16)	5.18
<b>H3-07</b>	Multi-function Analog Input 1 Bias (Term. 16)	5.18
<b>H3-10</b>	Multi-function Analog Input 2 Gain (Term. 14)	5.18
<b>H3-11</b>	Multi-function Analog Input 2 Bias (Term. 14)	5.18
<b>H4-02</b>	Multi-function Analog Monitor 1 Gain (Term. 21)	5.31
<b>H4-03</b>	Multi-function Analog Monitor 1 Bias (Term. 21)	5.31
<b>H4-05</b>	Multi-function Analog Monitor 2 Gain (Term. 23)	5.31
<b>H4-06</b>	Multi-function Analog Monitor 2 Bias (Term. 23)	5.31
<b>o1-01</b>	Monitor Selection	5.12
<b>o1-02</b>	Monitor Selection After Power-up	5.12

# Appendix 2. SPECIFICATIONS

**Table A2-1. Standard Specifications**

SECTION A. Input Voltage Related Specifications							
208 / 230V Class drive							
<b>Input Power</b>			Voltage : 3 Phase 200 / 208 / 220 / 230 VAC + 10%, - 15%				
			Frequency : 50 / 60 Hz ± 5%				
<b>Output Power</b>			Voltage : 0 - 230V (proportional to input voltage)				
			Frequency: 0 - 400 Hz (V/Hz pattern selectable)				
NEW DRIVE MODEL NO. CIMR-G5M	OLD DRIVE MODEL NO. GPD515C-	RATED kVA	NOMINAL HP	100% CONT. OUTPUT AMPS	RATED INPUT AMPS	RECOMMENDED MCCB RATING <sup>(1)</sup> (AMPS)	RECOMMENDED INPUT FUSING (AMPS) <sup>(2)</sup>
20P41F	A003	1.2	0.75	3.2	3.9	7	5.6
20P71F	A006	2.3	1 & 1.5	6	7.2	15	10
21P51F	A008	3.0	2	8	9.6	15	12
22P21F	A011	4.2	3	11	13.2	30	17.5
23P71F	A017	6.7	5	17.5	21	30	30
25P51F	A025	9.5	7.5	25	30	50	45
27P51F	A033	13	10	33	40	50	60
20111F	A049	19	15	49	59	75	90
20151F	A064	24	20	64	77	100	100
20181F	A080	30	25 & 30	80	88	150	125
20221F	A096	37	30	96	106	150	175
20300F	A130	50	40 & 50	130	143	250	200
20370F	A160	61	60	160	176	250	250
20550F	A224	85	75	224	247	400	400
20750F	A300	110	100	300	330	400	400
380 / 415 / 460V Class drive							
<b>Input Power</b>			Voltage : 3 Phase 380 / 400 / 415 / 440 / 460 VAC + 10%, - 15%				
			Frequency : 50 / 60 Hz ± 5%				
<b>Output Power</b>			Voltage : 0 - 460V (proportional to input voltage)				
			Frequency: 0 - 400 Hz (V/Hz pattern selectable)				
NEW DRIVE MODEL NO. CIMR-G5M	OLD DRIVE MODEL NO. GPD515C-	RATED kVA	NOMINAL HP	100% CONT. OUTPUT AMPS	RATED INPUT AMPS	RECOMMENDED MCCB RATING <sup>(1)</sup> (AMPS)	RECOMMENDED INPUT FUSING (AMPS) <sup>(2)</sup>
40P41F	B001	1.4	0.75	1.8	2.2	3	3
40P71F	B003	2.6	1 & 2	3.4	4.1	7	6
41P51F	B004	3.7	3	4.8	5.8	7	8
43P71F	B008	6.1	5	8	9.6	15	12
44P01F	B011	8.6	7.5	11	13.2	30	17.5
45P51F	B014	11	10	14	16.8	30	20
47P51F	B021	14	15	21	26	30	30
40111F	B027	21	20	27	33	50	45
40151F	B034	26	25	34	40	50	50
40181F	B041	31	30	41	46	75	70
40221F	B052	40	40	52	58	75	90
40301F	B065	50	50	65	72	100	100
40371F	B080	61	60	80	88	150	125
40451F	B096	73	75	96	106	150	150
40551F	B128	98	100	128	141	250	200
40750F	B165	130	125	165	182	250	250
41100F	B224	170	150	224	247	400	400
41600F	B302	230	200 & 250	302	330	400	400
41850F	B380	290	300	380	456	600	600
42200F	B450	340	300 & 350	450	540	800	400 <sup>(3)</sup>
43000F	B605	460	400 & 500	605	726	1000	450 <sup>(3)</sup>

- (1) Molded-case circuit breaker must be rated for at least 18,000 RMS symmetrical amperes interrupting capacity.
- (2) Fuses should be of the current-limiting time-delay type offering protection for semi-conductor devices.
- (3) Two fuses of this rating are required for each phase.

(table continued on next page)

**Table A2-1. Standard Specifications (Continued)**

SECTION A. Input Voltage Related							
600V Class drive							
Input Power			Voltage : 3 Phase 500/ 575/ 600 VAC +/- 10%				
			Frequency : 50 / 60 Hz ± 5%				
Output Power			Voltage : 0 - 575V (proportional to input voltage)				
			Frequency: 0 - 400 Hz (V/Hz pattern selectable)				
NEW DRIVE MODEL NO. CIMR-G5M	OLD DRIVE MODEL NO. GPD515C-	RATED kVA	NOMINAL HP	100% CONT. OUTPUT AMPS	RATED INPUT AMPS	RECOMMENDED MCCB RATING <sup>(1)</sup> (AMPS)	RECOMMENDED INPUT FUSING (AMPS) <sup>(2)</sup>
51P51F	C003	2	2	3.5	4.3	10	10
52P21F	C004	3	3	4.1	5.1	10	10
53P71F	C006	5	5	6.3	7.7	20	15
55P51F	C010	7.5	7.5	9.8	12.1	20	25
57P51F	C012	10	10	12.5	15.4	20	30
50111F	C017	15	15	17	21	30	40
50151F	C022	20	20	22	28	50	50
50181F	C027	25	25	27	33	60	60
50221F	C032	30	30	32	40	60	70
50301F	C041	40	40	41	51	100	100
50371F	C052	50	50	52	64	100	125
50451F	C062	60	60	62	76	100	156
50551F	C077	75	75	77	95	150	200
50751F	C099	100	100	99	122	225	250
50900F	C130	125	125	130	160	225	300
51100F	C172	150	150	172	211	300	400
51600F	C200	200	200	200	246	400	500

(1) Molded-case circuit breaker must be rated for at least 18,000 RMS symmetrical amperes interrupting capacity.

(2) Fuses should be of the current-limiting time-delay type offering protection for semi-conductor devices.

**Table A2-1. Standard Specifications (Continued)**

SECTION C. ALL drives			
Control Characteristics	Control Method		Sine-coded PWM (Digital flux vector)
	Frequency/Speed Control	Range	100:1 (including at stall) (1000:1 possible with PG)
		Precision	Digital ref.: $\pm 0.01\%$ ( $-10$ to $40^{\circ}\text{C}$ , $+14$ to $+140^{\circ}\text{F}$ ) Analog ref.: $\pm 0.1\%$ ( $25 \pm 10^{\circ}\text{C}$ , $77 \pm 50^{\circ}\text{F}$ )
	Frequency Control Range		0.1 to 400 Hz
	Speed Control Accuracy		$\pm 0.2\%$ ( $\pm 0.02\%$ with PG)
	Frequency/Speed Reference Setting Resolution		Digital Operator reference: 0.01 Hz (12 bits) (0.1 Hz @ 100 Hz and above) Analog reference: 0.03 Hz/60 Hz (11 bits)
	Starting Torque		150% / 1 Hz (150% / 0 RPM with PG)
	Output Frequency Resolution		0.01 Hz
	Auto Speed Reference Signal		$\pm 10$ VDC (20K Ohms), or 4-20mA (250 Ohms)
	Accel / Decel Time		0 to 6000 sec (resolution: 0.1 sec) (Accel / Decel times set independently, 4 steps available)
	Torque Limit		4 types available
	Braking Torque		Approximately 20%
	V/F Pattern Selection		15 Standard Patterns: 4 for general purpose; 4 for high starting torque; 4 for fans and pumps; 3 for constant horsepower. 1 Custom Pattern: defined by parameter settings.
Selectable Functions		Multi-step speed operation (9 steps max.), S-curve accel/decel, zero speed control, servo lock, arbitrary torque detection, etc.	
Protective Functions	Motor Overload Protection		Electronic thermal overload relay
	Instantaneous Overcurrent		Motor coasts to a stop at approximately 200% rated current.
	Fuse Blown Protection		Motor coasts to a stop by blown fuse.
	Overload		Motor coasts a stop after 60 sec. at 150% of rated output current.
	Overvoltage		Motor coasts to a stop if drive DC bus voltage exceeds 400 VDC (230V unit), or 800VDC (460V unit), or 1050VDC (600V unit).
	Undervoltage		Motor coasts to a stop if drive DC bus voltage drops to 190 VDC or below (230V unit), 380 VDC or below (460V unit), 546VDC or below (600V unit).
	Momentary Power Failure		Factory setting provides for motor to coast to a stop after momentary power failure of more than 15 ms. Can be reprogrammed to allow continuous operation (ride-through) during power failure of up to 2 seconds or longer (see Note 2).
	Heatsink Overheat		Thermistor

(table continued on next page)

**Table A2-1. Standard Specifications (Continued)**

<b>SECTION C. ALL drives (Continued)</b>		
Protective Functions (continued)	Stall Prevention	Stall prevention at acceleration/deceleration and constant speed operation.
	Ground Fault	Provided by electronic circuit.
	Power Charge Indication	"CHARGE" lamp remains lit until bus voltage drops below 50 V.
Environmental Conditions	Location	Indoor (protected from corrosive gases and dust)
	Ambient Temperature	-10 to 40°C (+14 to 104°F) for NEMA 1; -10 to 45°C (+14 to 113°F) for protected chassis
	Storage Temperature (Note 3)	-20 to 60°C (-4 to 140°F)
	Humidity	95% RH (no condensation)
	Vibration	1 G at less than 20 Hz, up to 0.2 G at 20 to 50 Hz
	Elevation	3300 ft (1000 m) or less
<b>SECTION D. All VCMs</b>		
Rated speed	1750 rpm (4 poles, 60Hz)	
Pulse Generator	1024 ppr	
Thermistor	Standard	
Load Connection	Direct coupling or belt drive	
Insulation Type	Class F	
Ambient Temperature	-20 to +40°C (-4 to +104°F)	
Location	Indoor	

## NOTES:

1. Overload capacity: 150% of rated for 60 sec.
2. See paragraph 5.29 for detailed information.
3. Temperature during shipping. Storing in this temperature for a long period may deteriorate main circuit capacitor.
4. 1HP motor VMB001C is an inverter-duty foot mount with C-Face.

# Appendix 3. CAPACITY & CONTROL METHOD RELATED PARAMETERS

Parameter **o2-04** (Drive Capacity Selection) is factory preset per the input voltage and output current ratings of the drive, although the drive displays the voltage and kW rating. This parameter setting determines the factory settings for the parameters listed in the table below. If the Control PCB has been replaced, the new board **MUST** have **o2-04** programmed to the appropriate set value **BEFORE** again operating the drive in the Drive mode.

**Table A3-1. Parameters Related to GPD 515 Capacity**

NEW DRIVE MODEL NO.	OLD DRIVE MODEL NO.	NOMINAL OUTPUT HP      AMPS		PARAMETER												
				o2-04	C6-01	C6-02	E2-01 & E5-01	E2-02 & E5-02	E2-03 & E5-03	E2-05 & E5-05	E2-06 & E5-06	L2-02	L2-03	L2-04	L8-02	E2-10
				(kHz)	(kHz)	(Amps)	(Hz)	(Amps)	(ohms)	(%)	(sec.)	(sec.)	(sec.)	(sec.)	(watts)	
<b>230V</b>																
20P41F	A003	0.75	3.2	0	15.0	15.0	1.90	2.90	1.20	9.842	18.2	0.7	0.5	0.3	95	14
20P71F	A006	1 & 1.5	6	1	15.0	15.0	3.30	2.50	1.80	5.156	13.8	1.0	0.5	0.3	95	26
21P51F	A008	2	8	2	15.0	15.0	6.20	2.60	2.80	1.997	18.5	1.0	0.5	0.3	95	53
22P21F	A011	3	11	3	15.0	15.0	8.50	2.90	3.00	1.601	18.4	1.0	0.5	0.3	95	77
23P71F	A017	5	17.5	4	15.0	15.0	14.00	2.73	4.50	0.771	19.6	2.0	0.5	0.3	95	112
25P51F	A025	7.5	25	5	15.0	15.0	19.60	1.50	5.10	0.399	18.2	2.0	0.7	0.3	95	172
27P51F	A033	10	33	6	15.0	15.0	26.60	1.30	8.00	0.288	15.5	2.0	0.7	0.3	95	262
20111F	A049	15	49	7	15.0	15.0	39.7	1.70	11.2	0.230	19.5	2.0	0.7	0.3	95	245
20151F	A064	20	64	8	15.0	15.0	53.0	1.60	15.2	0.138	17.2	2.0	0.7	0.3	95	272
20181F	A080	25 & 30	80	9	15.0	15.0	65.8	1.67	15.7	0.101	20.1	2.0	1.0	0.6	95	505
20221F	A096	30	96	A	10.0	10.0	77.2	1.70	18.5	0.079	19.5	2.0	1.0	0.6	95	538
20300F	A130	40 & 50	130	b	10.0	10.0	105.0	1.80	21.9	0.064	20.8	2.0	1.0	0.6	95	699
20370F	A160	60	160	C	10.0	10.0	131.0	1.33	38.2	0.039	18.8	2.0	1.0	0.6	95	823
20550F	A224	75	224	E	10.0	10.0	190.0	1.43	45.6	0.022	20.5	2.0	1.0	1.0	95	852
20750F	A300	100	300	F	10.0	10.0	260.0	1.39	72.0	0.023	20.0	2.0	1.0	1.0	95	960
<b>460V</b>																
40P41F	B001	0.75	1.8	20	10.0	10.0	1.00	2.90	0.60	38.198	18.2	1.0	0.5	0.3	95	14
40P71F	B003	1 & 2	3.4	21	10.0	10.0	1.60	2.60	0.80	22.459	14.3	1.0	0.5	0.3	95	26
41P51F	B004	3	4.8	22	10.0	10.0	3.10	2.50	1.40	10.100	18.3	1.0	0.5	0.3	95	53
43P71F	B008	5	8	24	10.0	10.0	7.00	2.70	2.30	3.333	19.3	2.0	0.5	0.3	95	130
44P01F	B011	7.5	11	25	10.0	10.0	7.00	2.70	2.30	3.333	19.3	2.0	0.7	0.3	95	130
45P51F	B014	10	14	26	10.0	10.0	9.80	1.50	2.60	1.595	18.2	2.0	0.7	0.3	95	193
47P51F	B021	15	21	27	10.0	10.0	13.30	1.30	4.00	1.152	15.5	2.0	0.7	0.3	95	263
40111F	B027	20	27	28	10.0	10.0	19.9	1.70	5.6	0.922	19.6	2.0	0.7	0.3	95	385
40151F	B034	25	34	29	10.0	10.0	26.5	1.60	7.6	0.550	17.2	2.0	0.7	0.3	95	440
40181F	B041	30	41	2A	10.0	10.0	32.9	1.67	7.8	0.403	20.1	2.0	1.0	0.6	95	508
40221F	B052	40	52	2b	8.0	8.0	38.6	1.70	9.2	0.316	23.5	2.0	1.0	0.6	95	586
40301F	B065	50	65	2C	8.0	8.0	52.3	1.80	10.9	0.269	20.7	2.0	1.0	0.6	95	750

(table continued on next page)



**Table A3-1. Parameters Related to GPD 515 Capacity**

NEW DRIVE MODEL NO.	OLD DRIVE MODEL NO.	NOMINAL OUTPUT HP AMPS		PARAMETER												
				o2-04	C6-01	C6-02	E2-01 & E5-01	E2-02 & E5-02	E2-03 & E5-03	E2-05 & E5-05	E2-06 & E5-06	L2-02	L2-03	L2-04	L8-02	E2-10
				(kHz)	(kHz)	(Amps)	(Hz)	(Amps)	(ohms)	(%)	(sec.)	(sec.)	(sec.)	(sec.)	(watts)	
CIMR-G5M	GPD515C-			<b>4 6 0 V – Continued</b>												
40371F	B080	60	80	2d	6.0	6.0	65.6	1.33	19.1	0.155	18.8	2.0	1.0	0.6	95	925
40451F	B096	75	96	2E	6.0	6.0	79.7	1.60	22.0	0.122	19.9	2.0	1.0	0.6	95	1125
40551F	B128	100	128	2F	6.0	6.0	95.0	1.46	24.0	0.088	20.0	2.0	1.0	1.0	100	1260
40750F	B165	125	165	30	6.0	6.0	130.0	1.39	36.0	0.092	20.0	2.0	1.0	1.0	95	1600
41100F	B224	150	224	32	5.0	5.0	190.0	1.40	49.0	0.046	20.0	2.0	2.0	1.0	110	2150
41600F	B302	200 & 250	302	34	5.0	5.0	270.0	1.35	70.0	0.029	20.0	2.0	2.0	1.0	100	2850
41850F	B380	300	380	35	2.0 *	2.0	310.0	1.30	81.0	0.025	20.0	2.0	2.0	1.0	95	3200
42200F	B450	300 & 350	450	36	2.0 *	2.0	370.0	1.30	96.0	0.020	20.0	2.0	2.0	1.0	95	3700
43000F	B605	400 & 500	605	37	2.0 *	2.0	500.0	1.25	130.0	0.014	20.0	2.0	2.0	1.0	95	4700

NOTES:

\* 2.5 kHz is maximum carrier frequency.

**Table A3-1. Parameters Related to GPD 515 Capacity**

NEW DRIVE MODEL NO.	OLD DRIVE MODEL NO.	NOMINAL OUTPUT HP AMPS		PARAMETER												
				o2-04	C6-01	C6-02	E2-01 & E5-01	E2-02 & E5-02	E2-03 & E5-03	E2-05 & E5-05	E2-06 & E5-06	L2-02	L2-03	L2-04	L8-02	E2-10
				(kHz)	(kHz)	(Amps)	(Hz)	(Amps)	(ohms)	(%)	(sec.)	(sec.)	(sec.)	(sec.)	(watts)	
				<b>6 0 0 V</b>												
51P51F	C003	2	3.5	42	10.0	10.0	2.70	2.50	0.90	13.720	18.3	1.0	0.5	0.3	95	53
52P21F	C004	3	4.1	43	10.0	10.0	3.90	3.00	1.20	8.825	18.7	1.0	0.5	0.3	95	77
53P71F	C006	5	6.3	44	10.0	10.0	6.10	2.70	1.90	4.939	19.3	2.0	0.5	0.3	95	130
55P51F	C010	7.5	9.8	45	10.0	10.0	9.00	1.50	2.70	2.601	18.2	2.0	0.5	0.3	95	193
57P51F	C012	10	12.5	46	10.0	10.0	11.00	1.30	3.30	1.446	15.5	2.0	0.5	0.3	95	263
50111F	C017	15	17	47	10.0	10.0	17.0	1.70	5.1	1.171	19.6	2.0	0.5	0.3	95	385
50151F	C022	20	22	48	10.0	10.0	22.0	1.60	6.6	0.896	17.2	2.0	0.5	0.3	95	440
50181F	C027	25	27	49	10.0	10.0	27.0	1.67	8.1	0.658	20.1	2.0	0.5	0.6	95	508
50221F	C032	30	32	4A	10.0	10.0	32.0	1.70	9.6	0.518	23.5	2.0	0.5	0.6	95	586
50301F	C041	40	41	4B	10.0	10.0	41.0	1.80	12.3	0.438	20.7	2.0	1.0	0.6	95	750
50371F	C052	50	52	4C	10.0	10.0	52.0	1.33	15.6	0.267	18.8	2.0	1.0	0.6	95	925
50451F	C062	60	62	4D	10.0	10.0	62.0	1.60	18.6	0.210	19.9	2.0	1.0	0.6	95	1125
50551F	C077	75	77	4E	10.0	10.0	77.0	1.46	23.1	0.150	20.0	2.0	1.0	1.5	95	1260
50751F	C099	100	99	4F	2.0	1.0	99.0	1.39	29.7	0.099	20.0	2.0	1.0	1.5	95	1600
50900F	C130	125	130	50	2.0	1.0	125.0	1.39	38.5	0.079	20.0	2.0	2.0	1.5	95	2150
51100F	C172	150	172	51	2.0	1.0	144.0	1.40	43.2	0.060	20.0	2.0	2.0	1.5	95	2150
51600F	C200	200	200	52	2.0	1.0	192.0	1.35	57.6	0.037	20.0	2.0	2.0	1.5	95	2850

NOTES:

\* 2.5 kHz is maximum carrier frequency.

**Table A3-2. Parameters Related to Control Method ( A1-02 )**

PARAMETER NUMBER	FUNCTION NAME	INCREMENT	SETTING RANGE	FACTORY SETTING			
				V/F	V/F with PG	Open Loop Vector	Flux Vector
				A1-02 = 0	A1-02 = 1	A1-02 = 2	A1-02 = 3
<b>b3-01</b>	Speed Search Selection	1	0, 1	0	1	0	1
<b>b3-02</b>	Speed Search Deactivation Current Level	1 %	0 - 200	150	—	100	—
<b>b8-04</b>	Automatic Energy-Saving Gain	0.1	0.0 - 10.0	—	—	0.7	1.0
<b>b8-05</b>	Automatic Energy-Saving Time Constant	0.01 sec	0.00 - 10.00	—	—	0.50	0.01
<b>C3-01</b>	Slip Compensation Gain	0.1	0.0 - 2.5	0.0	—	1.0	1.0
<b>C3-02</b>	Slip Compensation Primary Delay Time	1 ms	0 - 10000	2000	—	200	—
<b>C4-02</b>	Torque Compensation Time Constant	1 ms	0 - 10000	200	200	20	—
<b>C5-01</b>	ASR Proportional Gain 1	0.01	0.00 - 300.00	—	0.20	—	20.00
<b>C5-02</b>	ASR Integral Time 1	0.001 sec	0.000 - 10.000	—	0.200	—	0.500
<b>C5-03</b>	ASR Proportional Gain 2	0.01	0.00 - 300.00	—	0.02	—	20.00
<b>C5-04</b>	ASR Integral Time 2	0.001 sec	0.000 - 10.000	—	0.050	—	0.500
<b>E1-07, E4-04</b>	Mid. Output Frequency A	0.1 Hz	0.0 - 400.0	3.0	3.0	3.0	—
<b>E1-08, E4-05</b>	Mid. Output Voltage A	V	0.0 - 250.0 0.0 - 510.0 (1) 0.0 - 733.1 (2)	17.2 34.5 (1) 49.5 (2)	17.2 34.5(1) 49.5 (2)	12.6 25.3(1) 36.3 (2)	—
<b>E1-09, E4-06</b>	Min. Output Frequency	0.1 Hz	0.0 - 400.0	1.5	1.5	0.5	0.0
<b>E1-10, E4-07</b>	Min. Output Voltage	0.1 V	0.0 - 250.0 0.0 - 510.0 (1) 0.0 - 733.1 (2)	10.3 20.7(1) 29.6 (2)	10.3 20.7(1) 29.6 (2)	2.3 4.6(1) 6.5 (2)	—
<b>F1-09</b>	Overspeed Detection Delay Time	0.1 sec	0.0 - 2.0	—	1.0	—	0.0

NOTES:

1. Values are for 460V ratings.
2. Values are for 600V ratings.



## Appendix 4. GPD 515/G5 SPARE PARTS

### PROCEDURE FOR INSTALLING REPLACEMENT CONTROL PCB

1. Record all parameters that have been changed from their factory settings, by writing down all settings that appear under the “Modified Constants” menu.
2. Record the Control Method (“Initialize” menu, **A1-02**).
3. Record the drive’s kVA selection (**o2-04**). This parameter is available only when the Access Level is set to “Advanced” (**A1-01 = 4**).
4. Remove power, remove the old control board, and install the new control board.
5. Reapply power to the drive. An “**oPE01 KVA Selection**” fault may appear – if so, step 7 will correct it.
6. Set the Access Level to “Advanced” from the “Initialize” menu (**A1-01 = 4**).
7. Program the new control board for the correct drive size by setting parameter **o2-04** to the value that was recorded in step 3.
8. Set parameter **o2-09** to “American Spec” to ensure that all parameters are reset to the “American” values when the initialization is performed in step 10.
9. Set the new control board to the correct Control Method under the “Initialize” menu (**A1-02**).
10. Reset the drive from the “Initialize” menu using the “Init Parameters” function (**A1-03**). Entering “**2220**” will reset the drive for 2-wire control. Entering “**3330**” will reset the drive for 3-wire control. NOTE: After a successful initialization, the “Init Parameters” display will return to “**No Initialize**”.
11. Program all parameter settings with the data that was recorded in step 1.

New Drive Model No. CIMR-G5M	Old Drive Model No. GPD515C-	Power Module Part No. 5P30-					Transistor Module Part No. 5P30-							Diode Module Part No. 5P50-						
		0174	0175	0178	0154	0155	0156	0157	0180	0160	0161	0176	0177	0477	0478	0479	0490	0480	0481	0482
20P41F	A003	1																		
20P71F	A006		1																	
21P51F	A008		1																	
22P21F	A011			1																
23P71F	A017				1															
25P51F	A025				1															
27P51F	A033					1														
20111F	A049						3													
20151F	A064							3												
20181F	A080								3											
20221F	A096								3											
20300F	A130									6										
20370F	A160										6									6
20550F	A224											6								6
20750F	A300												12							6

No Diode Module in these Drive Model No's; diodes are contained in Power Module.

New Drive Model No. CIMR-G5M	Old Drive Model No. GPD515C-	Power PCB Part No. 5P90-									Gate Drive PCB Part No. 5P90-					Control PCB Part No. 5P90-0535
		0422	0423	0424	0425	0426	0427	0428	0429	0430	0410	0414	0415	0416	0417	
20P41F	A003	1														1
20P71F	A006		1													1
21P51F	A008			1												1
22P21F	A011				1											1
23P71F	A017					1										1
25P51F	A025						1									1
27P51F	A033							1								1
20111F	A049								1							1
20151F	A064									1						1
20181F	A080										1					1
20221F	A096										1					1
20300F	A130											1				1
20370F	A160												1			1
20550F	A224													1		1
20750F	A300													1		1

New Drive Model No. CIMR-G5M	Old Drive Model No. GPD515C-	Cooling Fan Part No. 5P16-						DC Bus Fuse Part No. 5P17-								Control Fuse Part No. 5P17-				
		0057	0058	0059	0061	0050	0062	0051	0504	0505	0488	0480	0481	0482	0483	0484	0485	0487	0500	0501
20P41F	A003							1											1	
20P71F	A006							1											1	
21P51F	A008								1										1	
22P21F	A011	1								1									1	
23P71F	A017	1									1								1	
25P51F	A025	1										1							1	
27P51F	A033	2										1							1	
20111F	A049		2										1						1	
20151F	A064		2											1					1	
20181F	A080			1	1										1				1	
20221F	A096			1	1										1				1	
20300F	A130					3	1									3				1
20370F	A160					3	1									3				1
20550F	A224					3	1									3				1
20750F	A300						1	3									3			1

**IMPORTANT**

Numbers represent total quantity used in one Drive. To determine adequate inventory of spare parts, Yaskawa suggests using listed value for quantities 2 and below. If listed value is greater than 2, factory suggests 1/3 of total listed.

New Drive Model No. CIMR-G5M	Old Drive Model No. GPD515C-	Power Module Part No. 5P30-				Transistor Module Part No. 5P30-								Xstr/Heatsink Assy Part No. 5P30-			Diode Module Part No. 5P50-										
		0171	0162	0163	0164	0165	0166	0167	0181	0150	0151	0152	0153	0288	0289	0290	0483	0484	0485	0486	0491	0492	0487	0488	0496		
40P41F	B001	1																								No Diode Module in these Drive Model No's; diodes are contained in Power Module.	
40P71F	B003	1																									
41P51F	B004	1																									
43P71F	B008		1																								
44P01F	B011		1																								
45P51F	B014			1													1										
47P51F	B021				1												1										
40111F	B027					3												1									
40151F	B034					3												1									
40181F	B041						3												1								
40221F	B052						3												1								
40301F	B065							3												1							
40371F	B080								3												1						
40451F	B096								3												1						
40551F	B128									6												6					
40750F	B165										6											6					
41100F	B224											12												6			
41600F	B302												12											6			
41850F	B380													3											6		
42200F	B450														3										6		
43000F	B605															3									9		

New Drive Model No. CIMR-G5M	Old Drive Model No. GPD515C-	Power PCB				Gate Drive PCB								Control PCB Part No. 5P90- 0535											
40P41F	B001																								1
40P71F	B003																								1
41P51F	B004																								1
43P71F	B008																								1
44P01F	B011																								1
45P51F	B014																								1
47P51F	B021																								1
40111F	B027																								1
40151F	B034																								1
40181F	B041																								1
40221F	B052																								1
40301F	B065																								1
40371F	B080																								1
40451F	B096																								1
40551F	B128																								1
40750F	B165																								1
41100F	B224																								1
41600F	B302																								1
41850F	B380																								1
42200F	B450																								1
43000F	B605																								1

**IMPORTANT**

Numbers represent total quantity used in one Drive. To determine adequate inventory of spare parts, Yaskawa suggests using listed value for quantities 2 and below. If listed value is greater than 2, factory suggests 1/3 of total listed.

New Drive Model No. CIMR-G5M	Old Drive Model No. GPD515C-	Cooling Fan Part No. 5P16-								DC Bus Fuse Part No. 5P17-									Control Fuse Part No. 5P17-															
		0057	0058	0059	0061	0060	0050	0062	0051	0064	0504	0488	0480	0489	0490	0491	0492	0477	0478	0479	0500	0503	0502											
40P41F	B001									1											1													
40P71F	B003									1											1													
41P51F	B004									1											1													
43P71F	B008	1									1										1													
44P01F	B011	1									1										1													
45P51F	B014	1										1									1													
47P51F	B021	2											1								1													
40111F	B027		2											1							1													
40151F	B034		2											1							1													
40181F	B041			1	1									1							1													
40221F	B052			1	1										1						1													
40301F	B065				1	2										1					1													
40371F	B080				1	2										1					1													
40451F	B096				1	2										1					1													
40551F	B128						3	1										3				1												
40750F	B165						3	1									3					1												
41100F	B224						3	1											3				1											
41600F	B302							1	3													3	1											
41850F	B380										3	No DC Bus Fuse in these Drive Model No's; fuses are contained in Transistor/Heatsink Assembly.																1						
42200F	B450										3																							1
43000F	B605										3																							1

**IMPORTANT**

Numbers represent total quantity used in one Drive. To determine adequate inventory of spare parts, Yaskawa suggests using listed value for quantities 2 and below. If listed value is greater than 2, factory suggests 1/3 of total listed.

New Drive Model No. CIMR-G5M	Old Drive Model No. GPD515C-	Power Module Part No. 5P30-					Transistor Module Part No. STR__					Diode Module							
		0179	0162	0163	0164	0165	1217	1219	1220	1221	1200	1201	Part No. 5P50-				Part No. SID3047		
													0483	0484	0485	0491		0492	0487
51P51F	C003	1																	
52P21F	C004	1																	
53P71F	C006		1																
55P51F	C010			1															
57P51F	C012				1														
50111F	C017					1									1				
50151F	C022						1								1				
50181F	C027							3								1			
50221F	C032							3								1			
50301F	C041								3							1			
50371F	C052									3						1			
50451F	C062									3							1		
50551F	C077										3							3	
50751F	C099										3								3
50900F	C130											6							
51100F	C172												6						
51600F	C200													6					

No Diode in these Drive Model Nos.; diodes are contained in Power Module.

New Drive Model No. CIMR-G5M	Old Drive Model No. GPD515C-	Power PCB Part No. ETP615__					Gate Drive PCB Part No. ETC615__						Control PCB
		860	870	880	890	900	900	910	920	930	940	960	5P90-0535
51P51F	C003	1											1
52P21F	C004	1											1
53P71F	C006		1										1
55P51F	C010			1									1
57P51F	C012				1								1
50111F	C017					1							1
50151F	C022						1						1
50181F	C027							1					1
50221F	C032							1					1
50301F	C041								1				1
50371F	C052								1				1
50451F	C062								1				1
50551F	C077									1			1
50751F	C099										1		1
50900F	C130											1	1
51100F	C172											1	1
51600F	C200											1	1

New Drive Model No. CIMR-G5M	Old Drive Model No. GPD515C-	Cooling Fan Part No. 5P16-			DC Bus Fuse Part No.									
		0057	0058	0059	FU2067	50208016	50208017	FU2068	50205052	50205053	50205054	50208018	50208019	50208020
51P51F	C003	1			1									
52P21F	C004	1			1									
53P71F	C006	1				1								
55P51F	C010	2				1								
57P51F	C012	2					1							
50111F	C017		2					1						
50151F	C022		2						1					
50181F	C027			1						1				
50221F	C032			1						1				
50301F	C041			2							1			
50371F	C052			2							1			
50451F	C062			2							1			
50551F	C077			2								1		
50751F	C099			2								1		
50900F	C130			2									1	
51100F	C172			2										1
51600F	C200			2										1

**IMPORTANT**

Numbers represent total quantity used in one Drive. To determine adequate inventory of spare parts, Yaskawa suggests using listed value for quantities 2 and below. If listed value is greater than 2, factory suggests 1/3 of total listed.





# Appendix 5. GPD 515/G5 DIMENSIONS

Table A5-1 lists dimensions for the drive in its standard enclosure. For information on other types of enclosures available, consult your Yaskawa representative.

**Table A5-1. Drive Size and Weight**

VOLTS	NEW DRIVE	OLD DRIVE	NOMINAL HP	ENCLOSURE TYPE	PHYSICAL DIMENSIONS (IN.)			MOUNTING DIM. (IN.)		WEIGHT (LB)	HEAT LOSS (Watts)			
	MODEL NO.	MODEL NO.			H	W	D	H1	W1		Heatsink Internal Total			
	CIMR-G5M	GPD515C-									Heatsink	Internal	Total	
230	20P41F	A003	0.75	NEMA 1	11.02	5.51	6.30	10.47	4.96	7	15	50	65	
	20P71F	A006	1 & 1.5		11.02	5.51	6.30	10.47	4.96	7	25	65	90	
	21P51F	A008	2		11.02	5.51	6.30	10.47	4.96	7	40	80	120	
	230	22P21F	A011	3	NEMA 1	11.02	5.51	7.09	10.47	4.96	10	80	60	140
		23P71F	A017	5		11.02	5.51	7.09	10.47	4.96	10	135	80	215
	30	25P51F	A025	7.5	NEMA 1	11.81	7.87	8.07	11.22	7.32	12	210	90	300
		27P51F	A033	10		11.81	7.87	8.07	11.22	7.32	13	235	110	725
	30	20111F	A049	15	NEMA 1	14.96	9.84	8.86	14.37	9.29	24	425	160	585
		20151F	A064	20		15.75	9.84	8.86	14.37	9.29	24	525	200	725
	30	20181F	A080	25 & 30	NEMA 1	24.02	12.99	11.22	17.13	10.83	71	655	230	885
		20221F	A096	30		26.57	12.99	11.22	17.13	10.83	71	830	280	1110
	30	20300F	A130	40 & 50	Protected Chassis	26.57	16.73	13.78	25.59	12.60	134	930	440	1370
		20370F	A160	60		26.57	16.73	13.78	25.59	12.60	137	1110	620	1730
	30	20550F	A224	75	Protected Chassis	31.50	18.70	13.78	30.51	14.57	176	1740	890	2630
20750F		A300	100	36.42		22.64	15.75	35.24	17.52	298	2050	1160	3210	
460	40P41F	B001	0.75	NEMA 1	11.02	5.51	6.30	10.47	4.96	7	10	50	60	
	40P71F	B003	1 & 2		11.02	5.51	6.30	10.47	4.96	7	20	65	85	
	41P51F	B004	3		11.02	5.51	7.09	10.47	4.96	9	30	80	110	
	460	43P71F	B008	5	NEMA 1	11.02	5.51	7.09	10.47	4.96	10	80	65	145
		44P01F	B011	7.5		11.02	5.51	7.09	10.47	4.96	10	120	80	200
		45P51F	B014	10		11.81	7.87	8.07	11.22	7.32	13	135	85	220
	460	47P51F	B021	15	NEMA 1	11.81	7.87	8.07	11.22	7.32	13	240	120	360
		40111F	B027	20		14.96	9.84	8.86	14.37	9.29	24	305	150	455
		40151F	B034	25		14.96	9.84	8.86	14.37	9.29	24	390	180	570
	460	40181F	B041	30	NEMA 1	24.02	12.99	11.22	17.13	10.83	68	465	195	660
		40221F	B052	40		24.02	12.99	11.22	17.13	10.83	68	620	260	880
		40301F	B065	50		30.91	12.99	11.22	24.02	10.83	106	705	315	1020
	460	40371F	B080	60	NEMA 1	30.91	12.99	11.22	24.02	10.83	106	875	370	1245
		40451F	B096	75		33.46	12.99	11.22	24.02	10.83	106	970	415	1385
460	40551F	B128	100	Protected Chassis	32.28	17.91	13.78	31.30	13.78	174	1110	710	1820	
	40750F	B165	125		32.28	17.91	13.78	31.30	13.78	176	1430	890	2320	
	41100F	B224	150		36.42	22.64	14.76	35.24	17.52	298	1870	1160	3030	
	41600F	B302	200 & 250		36.42	22.64	15.75	35.24	17.52	320	2670	1520	4190	
460	41850F	B380	300	Protected Chassis	57.09	37.40	17.13	55.12	*	794	3400	1510	4910	
	42200F	B450	350		57.09	37.40	17.13	55.12	*	794	4740	2110	6850	
	43000F	B605	400 & 500		62.99	37.80	17.91	61.02	*	926	6820	2910	9730	

**Table A5-1. Drive Size and Weight**

VOLTS	NEW DRIVE	OLD DRIVE	NOMINAL HP	ENCLOSURE TYPE	PHYSICAL DIMENSIONS (IN.)			MOUNTING DIM. (IN.)		WEIGHT (LB)	HEAT LOSS (Watts)		
	MODEL NO.	MODEL NO.			H	W	D	H1	W1		Heatsink Internal Total		
	CIMR-G5M	GPD515C-									Heatsink	Internal	Total
6 0 0	51P51F	C003	2	NEMA 1	11.02	5.51	7.08	10.47	4.96	9	35	55	90
	52P21F	C004	3	NEMA 1	11.02	5.51	7.08	10.47	4.96	9	45	60	105
	53P71F	C006	5	NEMA 1	11.81	7.87	8.07	11.22	7.32	13	65	75	140
	55P51F	C010	7.5	NEMA 1	11.81	7.87	8.07	11.22	7.32	14	100	105	205
	57P51F	C012	10	NEMA 1	11.81	7.87	8.07	11.22	7.32	14	130	90	220
	50111F	C017	15	NEMA 1	14.96	9.84	8.85	14.37	9.29	29	180	150	330
	50151F	C022	20	NEMA 1	14.96	9.84	8.85	14.37	9.29	29	250	210	460
	50181F	C027	25	NEMA 1	29.53	15.75	11.22	28.74	11.81	97	310	230	540
	50221F	C032	30	NEMA 1	29.53	15.75	11.22	28.74	11.81	97	380	340	720
	50301F	C041	40	NEMA 1	33.47	22.64	11.81	32.48	18.70	159	430	390	820
	50371F	C052	50	NEMA 1	33.47	22.64	11.81	32.48	18.70	159	680	540	1220
	50451F	C062	60	NEMA 1	33.47	22.64	11.81	32.48	18.70	159	900	750	1650
	50551F	C077	75	NEMA 1	41.34	22.64	12.80	40.35	18.70	198	1000	750	1750
	50751F	C099	100	NEMA 1	41.97	22.64	12.80	40.35	18.70	198	1100	1150	2250
	50900F	C130	125	Protected Chassis	49.21	22.64	12.99	48.23	18.70	267	1150	1200	2350
	51100F	C172	150		62.99	22.64	13.98	61.81	18.70	324	1400	1800	3200
	51600F	C200	200		62.99	22.64	13.98	61.81	18.70	335	1870	2830	4700

## Appendix 6. DYNAMIC BRAKING CONNECTIONS

**GENERAL.** Dynamic braking (DB) enables the motor to be brought to a smooth and rapid stop. This is achieved by dissipating the regenerative energy of the AC motor across the resistive components of the Dynamic Braking option. For further details on dynamic braking operation, see the instruction sheet shipped with dynamic braking components.

The GPD515C-A003 thru -A033 (CIMR-G5M20P41F thru 27P51F), -B001 thru -B034 (40P41F thru 40151F), and -C003 thru -C032 (51P51F thru 50221F) have an integral braking transistor and require the addition of a Remote Mount Resistor Unit or a Heat Sink Mount Resistor. All higher rated drives require the use of a Braking Transistor Unit *and* a Remote Mount Resistor Unit.

Remote Mount Resistor Units typically mount outside of an electrical enclosure. Braking Transistor Units mount inside of an electrical enclosure. Heat Sink Mount Resistors mount to the back of the drive, attaching directly to the heat sink.

Available dynamic braking components are listed in Table A6-1 through A6-4.

**Table A6-1. Dynamic Braking - 3% Duty Cycle - 230V**

Drive			Heat Sink Mount Resistor							
Rated Input	New Drive Model No. CIMR-G5M	Old Drive Model No. GPD515C-	Part No.	Qty Reqd	Resistance (Ohms) (Each)	Power (Watts) (Each)	Approx. Braking Torque (%)	Dimensions (Inches)		
								Height	Width	Depth
230 V	20P41F	A003	50185430	1	200	150	220	7.16	1.73	0.51
	20P71F	A006	50185430	1	200	150	220	7.16	1.73	0.51
	21P51F	A008	50185431	1	100	150	125	7.16	1.73	0.51
	22P21F	A011	50185432	1	70	150	120	7.16	1.73	0.51
	23P71F	A017	50185433	1	62	150	100	7.16	1.73	0.51
460 V	40P41F	B001	50185530	1	750	150	165	7.16	1.73	0.51
	40P71F	B003	50185531	1	400	150	120	7.16	1.73	0.51
	41P51F	B004	50185531	1	200	150	150	7.16	1.73	0.51

**Table A6-2. Dynamic Braking - 10% Duty Cycle - 230V**

Drive			Braking Transistor Unit						Remote Mount Resistor Unit							
Rated Input	New Drive Model No. CIMR-G5M	Old Drive Model No. GPD515C-	Part No. 46S03331-	Qty Reqd	Minimum Connectable Resistance Each (Ohms)	Dimensions (Inches)			Part No. 5P41-	Qty Reqd	Resistance (Ohms) (Each)	Power (Watts) (Each)	Approx Braking Torque (%)	Dimensions (Inches)		
						Height	Width	Depth						Height	Width	Depth
230V	20P41F	A003	--	--	48	--	--	--	0825	1	200	250	150	5.00	14.00	4.00
	20P71F	A006	--	--	48	--	--	--	0826	1	100	250	150	5.00	14.00	4.00
	21P51F	A008	--	--	16	--	--	--	0826	1	100	250	115	5.00	14.00	4.00
	22P21F	A011	--	--	16	--	--	--	0827	1	70	250	110	5.00	14.00	4.00
	23P71F	A017	--	--	16	--	--	--	0828	1	40	846	115	5.00	14.00	7.00
	25P51F	A025	--	--	9.6	--	--	--	0829	1	30	824	105	5.00	14.00	7.00
	27P51F	A033	--	--	9.6	--	--	--	0830	1	20	1260	115	5.00	14.00	10.00
	20111F	A049	0010	1	9.6	11.00	5.53	5.91	0831	1	13.6	1500	115	5.00	14.00	13.00
	20151F	A064	0020	1	6.3	11.00	5.53	5.91	0832	1	10	1920	115	5.00	14.00	13.00
	20181F	A080	0020	1	6.3	11.00	5.53	5.91	0833	1	8	2592	100	5.00	21.00	10.00
	20221F	A096	0020	2	6.3	11.00	5.53	5.91	0834	2	6.8	2760	150	5.00	21.00	10.00
	20300F	A130	0020	2	6.3	11.00	5.53	5.91	0834	2	6.8	2760	135	5.00	21.00	10.00
	20370F	A160	0020	2	6.3	11.00	5.53	5.91	0834	2	6.8	2760	115	5.00	21.00	10.00
	20550F	A224	0020	3	6.3	11.00	5.53	5.91	0834	3	6.8	2760	135	5.00	21.00	10.00
	20750F	A300	0020	3	6.3	11.00	5.53	5.91	0834	3	6.8	2760	105	5.00	21.00	10.00

**Table A6-3. Dynamic Braking - 10% Duty Cycle - 460V**

Drive			Braking Transistor Module						Remote Mount Resistor Unit							
Rated Input	New Drive Model No. CIMR-G5M	Old Drive Model No. GPD515C-	Part No. 46S03331-	Qty Reqd	Minimum Connectable Resistance Each (Ohms)	Dimensions (Inches)			Part No. 5P41-	Qty Reqd	Resistance (Ohms) (Each)	Power (Watts) (Each)	Approx Braking Torque (%)	Dimensions (Inches)		
						Height	Length	Depth						Height	Length	Depth
460 V	40P41F	B001	--	--	96	--	--	--	0835	1	750	600	150	5.00	14.00	7.00
	40P71F	B003	--	--	96	--	--	--	0836	1	400	500	115	5.00	14.00	4.00
	41P51F	B004	--	--	64	--	--	--	0837	1	250	500	125	5.00	14.00	4.00
	43P71F	B008	--	--	32	--	--	--	0838	1	150	500	125	5.00	14.00	4.00
	44P01F	B011	--	--	32	--	--	--	0839	1	100	975	125	5.00	14.00	7.00
	45P51F	B014	--	--	32	--	--	--	0840	1	75	1050	125	5.00	14.00	10.00
	47P51F	B021	--	--	32	--	--	--	0841	1	50	1600	125	5.00	14.00	13.00
	40111F	B027	--	--	20	--	--	--	0842	1	40	2050	120	5.00	21.00	10.00
	40151F	B034	--	--	20	--	--	--	0843	1	32	2340	120	5.00	21.00	10.00
	40181F	B041	0050	1	20	11.00	5.53	5.91	0844	1	27	3000	115	5.00	21.00	13.00
	40221F	B052	0060	1	12.7	11.00	5.53	5.91	0845	1	20	3850	120	5.00	21.00	13.00
	40301F	B065	0060	1	12.7	11.00	5.53	5.91	0846	1	16	5440	120	5.00	28.00	13.00
	40371F	B080	0060	1	12.7	11.00	5.53	5.91	0847	1	13.6	5715	115	5.00	28.00	13.00
	40451F	B096	0060	2	12.7	11.00	5.53	5.91	0845	2	20	3850	125	5.00	21.00	13.00
	40551F	B128	0060	2	12.7	11.00	5.53	5.91	0847	2	13.6	5715	135	5.00	28.00	13.00
	40750F	B165	0060	2	12.7	11.00	5.53	5.91	0847	2	13.6	5715	110	5.00	28.00	13.00
	41100F	B224	0090	1	3	14.50	10.63	7.25	0848	1	5.2	17,280	120	14.00	29.00	18.00
	41600F	B302	0090	1	3	14.50	10.63	7.25	0849	1	4	19,600	95	14.00	29.00	18.00
41850F	B380	0090	1	3	14.50	10.63	7.25	0849	1	4	19,600	80	14.00	29.00	18.00	
42200F	B450	0090	1	3	14.50	10.63	7.25	0849	1	4	19,600	70	14.00	29.00	18.00	
43000F	B605	0090	2	3	14.50	10.63	7.25	0849	2	4	19,600	95	14.00	29.00	18.00	
GPD506V-B041 thru GPD506V-B302 cannot be connected for Dynamic Braking.																
460 V	41850F	B380	0090	1	3	14.50	10.63	7.25	0849	1	4	19,600	80	14.00	29.00	18.00
	--	B506	0090	1	3	14.50	10.63	7.25	0849	1	4	19,600	70	14.00	29.00	18.00
	--	B675	0090	2	3	14.50	10.63	7.25	0849	2	4	19,600	95	14.00	29.00	18.00

**Table A6-4. Dynamic Braking - 10% Duty Cycle - 600V**

Drive			Braking Transistor Module						Remote Mount Resistor Unit							
Rated Input	New Drive Model No. CIMR-G5M	Old Drive Model No. GPD515C-	Part No. 46S03331-	Qty Reqd	Minimum Connectable Resistance Each (Ohms)	Dimensions (Inches)			Part No. 5P41-	Qty Reqd	Resistance (Ohms) (Each)	Power (Watts) (Each)	Approx Braking Torque (%)	Dimensions (Inches)		
						Height	Length	Depth						Height	Length	Depth
600V	51P51F	C003	--	--	150	--	--	--	0851	1	150	840	150	5.00	14.00	7.00
	52P21F	C004	--	--	150	--	--	--	0851	1	150	840	150	5.00	14.00	7.00
	53P71F	C006	--	--	130	--	--	--	0851	1	150	840	150	5.00	14.00	7.00
	55P51F	C010	--	--	90	--	--	--	0851	1	150	840	130	5.00	14.00	7.00
	57P51F	C012	--	--	65	--	--	--	0852	1	100	1400	145	5.00	14.00	10.00
	50111F	C017	--	--	44	--	--	--	0853	1	75	1680	130	5.00	14.00	13.00
	50151F	C022	--	--	32	--	--	--	0854	1	50	2520	145	5.00	21.00	10.00
	50181F	C027	--	--	26	--	--	--	0855	1	40	3000	145	5.00	21.00	10.00
	50221F	C032	--	--	26	--	--	--	0856	1	38	3248	130	5.00	21.00	13.00
	50301F	C041	0080	1	24	11.00	5.53	5.91	0857	1	33	3800	110	5.00	21.00	13.00
	50371F	C052	0080	1	24	11.00	5.53	5.91	0858	1	27	4464	110	5.00	28.00	13.00
	50451F	C062	0080	2	24	11.00	5.53	5.91	0858	2	27	4464	150	5.00	28.00	13.00
	50551F	C077	0080	2	24	11.00	5.53	5.91	0858	2	27	4464	145	5.00	28.00	13.00
	50751F	C099	0080	2	24	11.00	5.53	5.91	0858	2	27	4464	110	5.00	28.00	13.00
	50900F	C130	0080	3	24	11.00	5.53	5.91	0858	3	27	4464	130	5.00	28.00	13.00
	51100F	C172	0080	3	24	11.00	5.53	5.91	0858	3	27	4464	110	5.00	28.00	13.00
	51600F	C200	0080	4	24	11.00	5.53	5.91	0858	4	27	4464	110	5.00	28.00	13.00

## INSTALLATION

This option should only be installed by a **TECHNICALLY QUALIFIED INDIVIDUAL** who is familiar with this type of equipment and the hazards involved.

### WARNING

**Hazardous voltage can cause severe injury or death. Lock all power sources feeding the drive in the "OFF" position.**

### CAUTION

**Failure to follow these installation steps may cause equipment damage or personnel injury.**

### Preliminary Procedures

1. Disconnect all electrical power to the drive.
2. Remove drive front cover.
3. Use a voltmeter to verify that voltage is disconnected from incoming power terminals.

### Heat Sink Mount Resistor Installation

1. Remove the drive from its mounting for access to the rear of the heat sink.
2. Attach the Heat Sink Mount Resistor on the back of the drive's heat sink, as shown in Figure A6-1.
3. Reinstall the drive in its mounting position.
4. Connect the leads from the Heat Sink Mount Resistor to drive terminals according to Figure A6-2.
5. Proceed to "ADJUSTMENTS" on page A6-7.

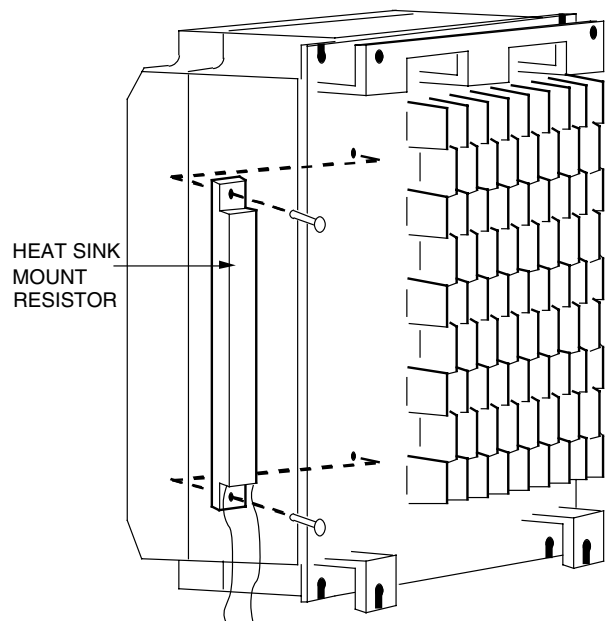

**Figure A6-1. Attaching Heat Sink Mount Resistor on Heat Sink**

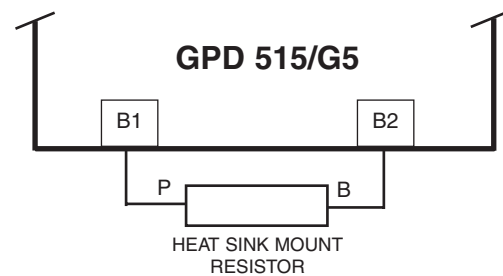

**Figure A6-2. Lead Connections For Heat Sink Mount Resistor**

**Remote Mount Resistor Unit Installation (for GPD515C-A003 thru -A033 [CIMR-G5M20P41F thru 27P51F], -B001 thru -B034 [40P41F thru 40151F], C003 thru C032 [51P51F thru 50221F])**

**IMPORTANT**

Since the Remote Mount Resistor Unit generates heat during dynamic braking operation, install it in a location away from other equipment.

1. Attach the Remote Mount Resistor Unit, maintaining a minimum 1.97 inch (50 mm) clearance on each side and a minimum 7.87 inch (200 mm) clearance on top.

2. Remove the Remote Mount Resistor Unit cover to access its terminal block. Connect the Remote Mount Resistor Unit to the drive and to external control circuitry according to the chart at right and Figure A6-3.

Terminals	<b>B, P</b>	<b>1, 2 *</b>
Lead Size (AWG)	12-10	18-14 *
Lead Type	600V ethylene propylene rubber insulated, or equivalent	
Terminal Screw	M4	

\* Power leads for the Remote Mount Resistor Unit generate high levels of electrical noise; these signal leads must be grouped separately.

3. Reinstall and secure Remote Mount Resistor Unit cover and drive front cover.
4. Proceed to "ADJUSTMENTS" on page A6-8.

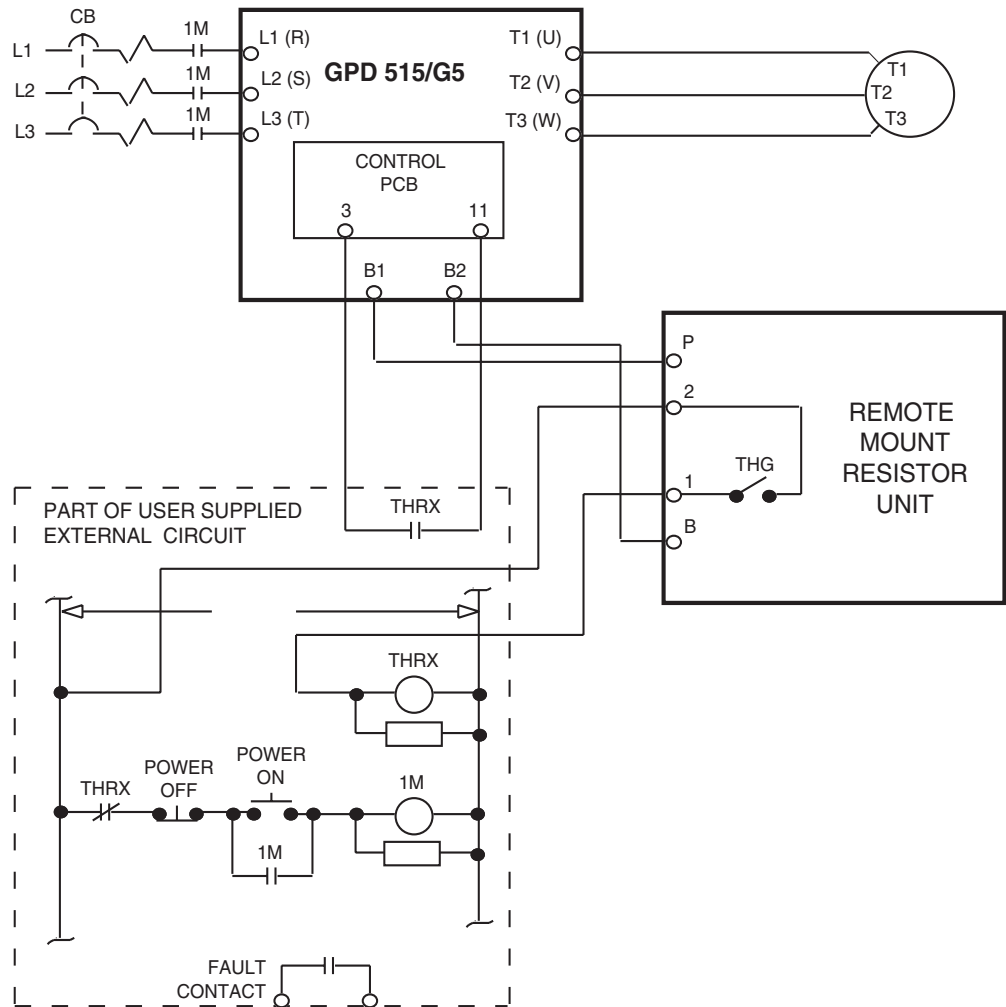

**Figure A6-3. Wiring Remote Mount Resistor Unit to Drive (GPD515C-A003 thru -A033 [CIMR-G5M20P41F thru 27P51F], -B001 thru -B034 [40P41F thru 40151F], and -C003 thru -C032 [51P51F thru 50221F])**

**Braking Transistor Unit(s) and Remote Mount Resistor Unit(s) Installation  
(for GPD515C-A049 [CIMR-G5M20111F] and above, -B041 [40181F] and  
above, C041 [50301F] and above)**

**IMPORTANT**

Since the Remote Mount Resistor Unit generates heat during dynamic braking operation, install it in a location away from other equipment.

Select mounting locations for the Braking Transistor Unit(s) and Remote Mount Resistor Unit(s) so that wiring between the drive and the (Master) Braking Transistor Unit, and between each Braking Transistor Unit and its associated Remote Mount Resistor Unit, is less than 33 feet (10 m).

1. Mount the Braking Transistor Unit(s) on a vertical surface. A Braking Transistor Unit requires a minimum 1.18 inches (30 mm) clearance on each side and a minimum 3.94 inches (100 mm) clearance top and bottom. Attach the Remote Mount Resistor Unit maintaining a minimum 1.97 inches (50 mm) clearance on each side and a minimum 7.87 inches (200 mm) clearance on top.
2. In each Braking Transistor Unit, set the nominal line voltage jumper plug to the correct setting for the installation; this is factory set at the 230V/460V/575V position. To access jumper plugs, remove plexiglass cover.
3. If multiple Braking Transistor Units are being installed, the unit closest to the drive should have the SLAVE/MASTER jumper plug on its PCB set to the "MASTER" position (factory setting); all others must have this jumper plug moved to the "SLAVE" position.
4. If a single Braking Transistor Unit and Remote Mount Resistor Unit are being installed, connect them to the drive and external control circuitry according to the chart below and Figure A6-4.

If two or more Braking Transistor Units and Remote Mount Resistor Units are being installed, connect them to the drive and to external circuitry according to the chart below and Figure A6-5.

UNIT	TERMINALS	LEAD SIZE (AWG)	LEAD TYPE	TERMINAL SCREWS
Remote Resistor Unit	B, P	12-10	600V ethylene propylene rubber insulated or equivalent	M5
	1, 2 *	18-14 *		M4
Braking Transistor Unit	P, Po, N, B	12-10	600V ethylene propylene rubber insulated, or equivalent	M4
	1, 2 *	18-14 *		

\* Power leads for the Remote Mount Resistor Unit generate high levels of electrical noise; these signal leads must be grouped separately.





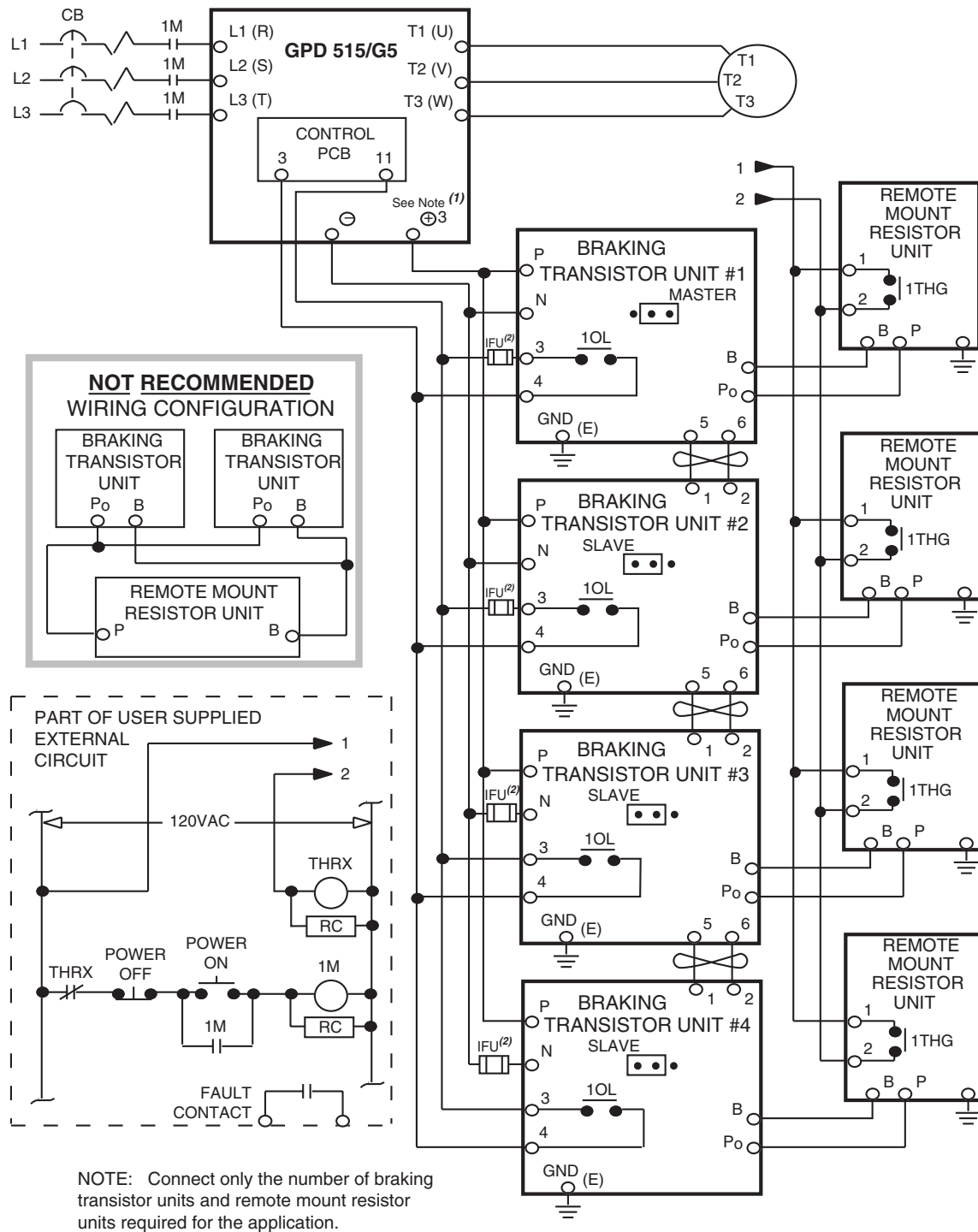
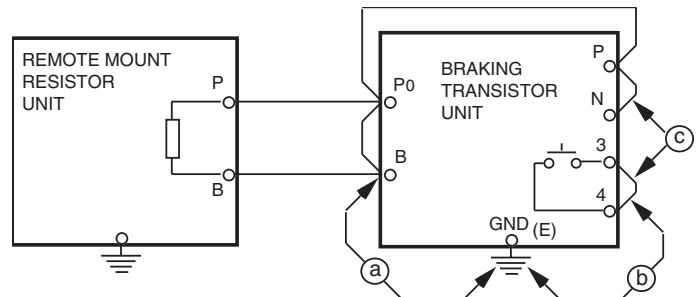

**Figure A6-5. Wiring Multiple Braking Transistor Units and Remote Mount Resistor Units to Drive (GPD515C-A130 thru -A300 [CIMR-G5M20300F thru 20750F], -B096 thru -B605 [40451F thru 43000F], and -C062<sup>(1)</sup> thru -C200<sup>(1)</sup> [50451F<sup>(1)</sup> thru 51600F<sup>(1)</sup>])**

<sup>(1)</sup> For 600V Units, use terminal ⊕ 1.

<sup>(2)</sup> Fuse required only if UL/CUL certification is needed. See separate instruction sheet 02Y00025-0393 for details.

6. **IMPORTANT:** After wiring, test insulation resistance of each Braking Transistor Unit/Remote Mount Resistor Unit with a 900V megger as follows:
  - a. Disconnect leads between the Braking Transistor Unit and the drive. If equipment with semiconductors is connected across terminals 1 & 2 of the Braking Transistor Unit, remove the wiring.
  - b. Connect common leads (jumpers) across Braking Transistor Unit terminals N, P, Po, and B, and across 3 & 4, as shown in Figure A6-6.
  - c. Measure the insulation resistance at points a, b, and c in Figure A6-6 with the megger.



**Figure A6-6. Megger Testing Set-up**

## ADJUSTMENTS

7. ALL drives: Program **L3-04** to " 0 ", to disable stall prevention during deceleration.
8. Only with Heat Sink Mount Resistor: Program **L8-01** to " 1 ", to enable overheat protection for the braking resistor.

## OPERATION CHECK

9. During dynamic braking operation, verify that the "BRAKE" lamp inside the Braking Unit is lit.
10. During dynamic braking operations, ensure that the required deceleration characteristic is obtained. If not, contact MagneTek for assistance.
11. Reinstall and secure covers on the Braking Transistor Units, Remote Mount Resistor Units, and the drive.



**During normal operation, the Braking Transistor Unit and the Remote Mount Resistor Unit enclosures must be kept closed, since high voltage is applied to the dynamic braking circuit.**

# INDEX

## - A -

Accel/Decel Time .....	5-3
Setting Unit .....	5-5
Acceleration	
Stall Prevention Level During .....	5-86
Stall Prevention. Limit During .....	5-86
Stall Prevention. Selection During .....	5-86
Time 1 .....	5-3
Time 2 .....	5-3
Time 3 .....	5-3
Time 4 .....	5-3
Access Level .....	5-7
Analog Inputs, Multi-function	
(Term. 14 & 16) .....	5-53
Analog Monitor Output, Multi-function	
(Term. 21-23) .....	5-57
Bias .....	5-57
Gain .....	5-57
Signal Level Selection .....	5-57
Output Selection .....	5-57
At Set Frequency (Output Signal) .....	5-73
Automatic Speed Regulator (ASR) .....	5-9
ASR Integral Reset .....	5-59
Integral Time 1 .....	5-9
Integral Time 2 .....	5-11
Proportional Gain 1 .....	5-9
Proportional Gain 2 .....	5-11
Output Lag Time .....	5-11
Auto Restart .....	5-7
Fault Contact Status During .....	5-8
No. of Attempts .....	5-7
Auto-Tuning, Running	
in Open Loop Vector Control .....	2-4
in Flux Vector Control .....	2-9
Auto-Tuning Faults & Corrective Actions .....	6-6
Auxiliary Input and Output	
Power Option Devices .....	1-11

## - B -

Base Block, External .....	5-63
Base Block Time, Min. ....	5-63
Basic Programming .....	4-8
Baud Rate, Ser. Comm.	
(MODBUS Control) .....	5-49
Bias, Frequency Reference .....	5-29
Braking, DC Injection .....	5-14
Current .....	5-15
Start Frequency .....	5-15, 5-103
Time at Start .....	5-14, 5-15
Time at Stop .....	5-15
Braking, Dynamic .....	A6-1

## - C -

Calculating Motor Parameters	
[for Initial Start-up] .....	2-20
Capacity Related Parameters .....	A3-1
Carrier Frequency .....	5-12
Lower Limit .....	5-12
Proportional Gain .....	5-12
Upper limit .....	5-12
Changing the Language on	
the Digital Operator .....	2-19
Checking Encoder Pulses	
[Troubleshooting] .....	6-29
Communication Error, Stop Method at	
(MODBUS Control) .....	A1-17
Conformance to European EMC	
Directive .....	1-13
Connections, Vector Control Motor .....	1-24
Blower Motor .....	1-26
Encoder Feedback (PG) .....	1-27
Motor Windings .....	1-24
Control Circuit	
Terminals .....	1-17
Terminal (13, 14) Input Voltage	
[Monitor Items] .....	A1-28
Wiring .....	1-15
Control Method [Monitor Item] .....	A1-27
Control Method Related Parameters .....	A3-3
Control Method Selection .....	2-2
CPU ID No. [Monitor Item] .....	A1-29
Critical Frequency Rejection .....	5-13
Current, DC Injection Braking .....	5-15
Current Meter (Analog Monitor) .....	5-57
Current, Motor Rated (FLA) .....	2-20, 5-90

## - D -

<b>DATA/ENTER</b> Key .....	4-1, 4-3
DC Bus Voltage [Monitor Item] .....	A1-27
Deactivation Time, Power Loss Ride-thru .....	5-50
Deceleration	
Stall Prevention Selection During .....	5-86
Time 1 .....	5-3
Time 2 .....	5-3
Time 3 .....	5-3
Time 4 .....	5-3
Deadband, Prohibited Frequency .....	5-13
Delay Time, Excessive Speed Deviation	
Detection (PG) .....	5-23
Derivative Time (PID) .....	5-80
Detection, Frequency (Output Signal) .....	5-73
Detection, Speed (Output Signal) .....	5-73
Diagnostics — <i>see Troubleshooting</i>	
Digital "Motor Operated Pot" .....	5-45
Digital Operator .....	4-1
Changing the Language on .....	2-19

Display Selection .....	5-17
Menu Trees .....	4-4
Mode Selection .....	4-9
Monitor Selection (At Power-up) .....	5-19
Test Run Using .....	2-24
Dimensions .....	A5-1
Diode and IGBT (Transistor) Module	
Resistance Test .....	6-27
Displaying Faults .....	6-7
"Down Arrow" Key .....	4-1, 4-3
<b>DRIVE</b> Indicator Lamp .....	4-1, 4-2
Droop .....	5-19
Dwell .....	5-20
Dynamic Braking .....	A6-1
Dynamic Braking Resistor	
Protection, Internal .....	5-46

## - E -

Elapsed Operation Time [Monitor Item] .....	A1-28
Elapsed Timer	
Selection .....	5-46
Setting .....	5-45
Encoder (PG) Constant .....	2-7, 2-15, 5-21
Encoder (PG) Parameters .....	5-21
Energy Saving Operation .....	5-27
Gain .....	5-27
Enclosure .....	A5-1
Environment .....	1-1, A2-3
<b>ESC</b> Key .....	4-1, 4-4
European EMC Directive,	
Conformance to .....	1-13
Excessive Speed Deviation	
Detection Delay Time .....	5-23
Detection Level .....	5-23
External Fault Inputs .....	5-28

## - F -

Fast-Stop Decel Time .....	5-3, 5-4
Fault Contact Status	
During Auto Restart .....	5-8
Fault Indication & Troubleshooting .....	6-1
Faults & Corrective Action, Auto-Tuning .....	6-6
FLA, Motor .....	2-20, 5-90
Flash ID No. [Monitor Item] .....	A1-28
Frequency	
Base .....	5-108
Carrier .....	5-12
Detection Output Signal .....	5-73
Max. Output .....	5-108
Meter (Analog Monitor) .....	5-57
Mid. Output .....	5-108
Min. Output .....	5-108
Prohibited .....	5-13

## INDEX – Continued

Frequency Detection Multi-  
function Output ..... 5-73  
 Frequency Reference 1 ..... 5-39  
 Frequency Reference 2 ..... 5-39  
 Frequency Reference 3 ..... 5-39  
 Frequency Reference 4 ..... 5-39  
 Frequency Reference  
 Bias ..... 5-29  
 Gain ..... 5-29  
 Input Signals (Auto/Manual) ..... 5-32  
 Jog ..... 5-36, 5-38  
 Limit, Lower ..... 5-34  
 Limit, Upper ..... 5-34  
 Loss Detection ..... 5-33  
 Retention ..... 5-33  
**FWD** Indicator Lamp ..... 4-1, 4-2  
**FWD/REV** Key ..... 4-1, 4-2

### - G -

Gain  
 Analog Monitor ..... 5-57  
 Energy Saving ..... 5-26  
 Frequency Reference ..... 5-29  
 Proportional (PID) ..... 5-80  
 Torque Compensation ..... 5-93  
 Zero-Servo ..... 5-110  
 Grounding ..... 1-11

### - H -

Hunting Prevention ..... 5-35

### - I -

Indicator Lamps ..... 4-1, 4-2  
 Initial Start-up ("Local" Control) ..... 2-1  
 Initialize Parameters (Reset Codes) ..... 5-83  
 Input and Output Power Option  
 Devices, Auxiliary ..... 1-11  
 Input Phase Loss Detection ..... 5-77  
 Input Selection  
 Analog, Multi-function ..... 5-53  
 Multi-function Terminals ..... 5-58  
 Input Terminal Status [Monitor Item] ..... A1-27  
 Input Voltage ..... A2-1  
 Inputs  
 Analog ..... 5-53  
 Frequency Reference ..... 5-31  
 Inspection (Receiving) ..... 1-1  
 Installation  
 Physical ..... 1-1  
 Electrical ..... 1-2  
 Integral Time (PID) ..... 5-80  
 Integral Value Limit (PID) ..... 5-80  
 Integral Reset, ASR (PID) ..... 5-82

Integral Value During Accel/  
Decel Selection (PG) ..... 5-24  
 Interconnection  
 2-wire Control ..... 1-20  
 3-wire Control ..... 1-22  
 Internal Dynamic Braking  
 Resistor Protection ..... 5-46

### - J -

Jog Frequency Reference ..... 5-35, 5-36  
**JOG** Key ..... 4-1, 4-2

### - K -

Keypad — *see* *Digital Operator*

### - L -

Lag Filter Time, Output (PID) ..... 5-81  
 Lamps, Indicator ..... 4-1, 4-2  
 LCD Display ..... 4-1  
 Limit, Integral Value (PID) ..... 5-80  
 Line-to-Line Resistance, Motor ..... A1-13  
 Listing of Parameters ..... A1-1  
**LOCAL/REMOTE** Key ..... 4-1  
 Selection ..... 5-44  
 Local/Remote Reference  
 Selection ..... 5-39  
 Lower Limit, Frequency Reference ..... 5-34

### - M -

Main Circuit  
 Block Diagrams ..... 1-8, 1-9, 1-10  
 Terminals ..... 1-3, 1-5  
 Input/Output Wiring ..... 1-2  
 Max. Output Frequency ..... 2-20, 5-108  
 Max. Voltage ..... 2-21, 5-108  
 Mechanical resonance — *see*  
*Critical Frequency Rejection*  
**MENU** Key ..... 4-1, 4-3  
 Menu Trees, Digital Operator ..... 4-5  
 Mid. Output Frequency ..... 5-108  
 Mid. Output Voltage ..... 5-108  
 Min. Base Block Time ..... 5-65  
 Min. Output Frequency ..... 5-108  
 Min. Output Voltage ..... 5-108  
 Miscellaneous Parameters ..... 5-44  
 Miscellaneous Protective Features ..... 5-46  
 MODBUS Control ..... 5-48  
 Operation Mode Selection ..... 5-48  
 Reference Selection ..... 5-48  
 Ser. Comm. Baud Rate ..... 5-48, 5-49  
 Ser. Comm. Parity Selection ..... 5-48, 5-49  
 Ser. Comm. Station Address ..... 5-48, 5-49  
 Stopping Method at Ser.  
 Comm. Error ..... A1-17

Mode Selection ..... 4-8  
 Model Numbers, Drive ..... xvii, A2-1,  
 A3-1, A5-1  
 Momentary Power Loss Ride-thru ..... 5-50  
 Deactivation Time ..... 5-50  
 Protection ..... 5-50  
 Monitor Selection (At Power-Up) ..... 5-19  
 Motor  
 Exciting Current [Monitor Item] ..... A1-28  
 Line-to-Line Resistance ..... A1-13  
 Mechanical Loss ..... A1-13  
 Overload Protection Selection ..... 5-90  
 No-Load Current (NLA) ..... 2-20, A1-13  
 Parameters, Calculating  
 [Initial Start-up] ..... 2-20  
 Rated Current (FLA) ..... 5-90, 2-20, A1-13  
 Rated Voltage ..... 2-20, A1-13  
 Secondary Current (Iq)  
 [Monitor Item] ..... A1-28  
 Selection (for OL Protection) ..... 5-90  
 Speed [Monitor Item] ..... A1-27  
 Stopping Method Selection ..... 5-14, 5-88  
 Switching — *see* *Speed Search*  
 Wiring ..... 1-2, 1-25  
 Mounting  
 Clearances ..... 1-1  
 Dimensions ..... A5-1  
 Location ..... 1-1, A2-4  
 Multi-function Analog Inputs  
 (Term. 14 & 16) ..... 5-53  
 Multi-function Input Terminals  
 (Term. 3-8) ..... 5-58  
 Multi-function Output Terminals  
 (Term. 9 & 10; 25-27) ..... 5-71  
 Multi-step Speed Operation ..... 5-40

### - N -

Number of PG Gear Teeth 1 ..... 5-25  
 Number of PG Gear Teeth 2 ..... 5-25

### - O -

Off-delay Timer ..... 5-66  
 Offset (PID) ..... 5-80  
 OH (Overheat) Protection Alarm Level ..... 5-46  
 OH Stopping Method Selection ..... 5-46  
 On-delay Timer ..... 5-66  
 Operation Method for Frequency  
 Reference Loss Detection ..... 5-33  
 Operation Mode Selection ..... 5-39  
 Operation Selection  
 at Overspeed (PG) ..... 5-22  
 at PG Open Circuit ..... 5-22  
 at Speed Deviation (PG) ..... 5-23  
 Operation Status [Monitor Item] ..... A1-28  
 Operator Detection Selection ..... 5-45

## INDEX – Continued

Operator Display (LCD) ..... 4-1  
Options — *see Peripheral Devices*  
Output, Analog Monitor ..... 5-57  
Output Current [Monitor Item] ..... A1-27  
Output Frequency  
    Max. .... 5-108, A1-12  
    Mid. .... 5-108, A1-12  
    Min. .... 5-108, A1-12  
    [Monitor Item] ..... A1-27  
Output Lag Filter Time (PID) ..... 5-81  
Output Phase Loss Detection ..... 5-77  
Output Power [Monitor Item] ..... A1-27  
Output Selection, Analog Monitor ..... 5-57  
Output Terminal Status [Monitor Item] ..... A1-27  
Output Voltage [Monitor Item] ..... A1-27  
Output Voltage Ref. (Vd) [Monitor Item] ..... A1-29  
Output Voltage Ref. (Vq) [Monitor Item] ..... A1-29  
Outputs  
    Analog Monitor ..... 5-57  
    Contact/Open Collector ..... 5-70  
Overload Prot. Selection, Motor ..... 5-90  
Overspeed Detection Level (PG) ..... 5-22  
Overtorque Detection  
    Function Selection ..... 5-98  
    Level ..... 5-98  
    Time ..... 5-98

**- P -**

Parameter Selection/Initialization  
    (Reset Codes) ..... 5-83  
Parameters  
    Factory Reset (Initialize) ..... 5-83  
    Listing of ..... A1-1  
    Quick Reference For ..... xiv  
    Programming ..... 4-10  
    Related to Capacity ..... A3-1  
    Related to Control Method ..... A3-3  
Parity Selection, Ser. Comm.  
    (MODBUS Control) ..... 5-49  
Peripheral devices  
    AC reactor ..... 1-12  
    Molded-case circuit breaker (MCCB) ..... A2-1  
    Noise filter ..... 1-12  
PG Open Circuit Detection Delay Time ..... 5-21  
PG Open Circuit, Operation Selection at ..... 5-21  
PG Rotation ..... 5-24  
PG Setup ..... 5-21  
Phase Loss Detection  
    Input ..... 5-77  
    Output ..... 5-77  
Physical Installation ..... 1-1  
PID Control ..... 5-78  
    Disable ..... 5-60  
    Feedback Amount [Monitor Item] ..... A1-29

Feedback Signal Selection ..... 5-79  
Integral Value Limit ..... 5-80  
Offset ..... 5-80  
Output Filter Lag Time ..... 5-81  
PID Limit ..... 5-80  
PID Selection ..... 5-78  
PID Settings  
    Derivative Time ..... 5-80  
    Integral Time ..... 5-80  
    Proportional Gain ..... 5-80  
Potentiometer (External Speed) ..... vii  
Power Loss Ride-thru Time ..... 5-51  
Power On and Preliminary Checks  
    (Initial Start-up) ..... 2-2  
Power Supply ..... 1-5, A2-1  
Power Voltage Selection in  
    460V GPD 515 ..... 2-1  
Pre-Operation Considerations ..... 2-27  
Preset Speeds — *see Multi-step Speeds*  
Programmable Features ..... 5-1  
Prohibited Frequency 1 ..... 5-13  
Prohibited Frequency 2 ..... 5-13  
Prohibited Frequency 3 ..... 5-13  
Prohibited Frequency 4 ..... 5-13  
Prohibited Frequency Deadband ..... 5-13  
Proportional Gain (PID) ..... 5-80  
Protection  
    Overcurrent, Instantaneous ..... A2-3  
    Overheat, Heatsink ..... A2-3  
    Overtorque ..... 5-98  
    Overvoltage ..... A2-3  
    Thermal Overload ..... 5-90  
    Undervoltage ..... A2-3  
PWM Frequency — *see Carrier Frequency*

## - R -

Rated Current, Motor ..... 2-20, 5-90  
Ratings ..... xvii, A2-1  
Receiving ..... 1-1  
Reference Selection (Local/Remote) ..... 5-39  
**REMOTE** Indicator Lamps ..... 4-1, 4-2  
Reset Codes ..... 5-83  
**RESET** Key ..... 4-1, 4-3  
Resistance, Motor Line-to-Line ..... A1-13  
**REV** Indicator Lamp ..... 4-1, 4-2  
Reverse Run Prohibit ..... A1-2  
Ride-thru, Momentary Power Loss ..... 5-51  
    Deactivation Time ..... 5-51  
"Right Arrow" Key ..... 4-1, 4-3  
Rotation, PG ..... 5-24  
**RUN** Indicator Lamp ..... 4-1, 4-2  
**RUN** Key ..... 4-1, 4-2  
Running  
    Forward ..... 2-24  
    Reverse ..... 2-24

Stall Prevention Level During ..... 5-87  
Stall Prevention Selection During ..... 5-87

## - S -

Sample/Hold Function ..... 5-67  
Scaling Display (Digital Operator) ..... 5-17  
S-Curve Characteristics ..... 5-6  
Shock Resistance — *see S-Curve*  
Skip Frequency — *see Prohibited Frequency*  
Slip Compensation ..... 5-84  
    Gain ..... 5-84  
    Limit ..... 5-84  
    Primary Delay Time ..... 5-84  
    Selection During Regeneration ..... 5-84  
Soft Start — *see S-Curve*  
Spare Parts ..... A4-1  
Specifications ..... A2-1  
Speed  
    Detection Output Signal ..... 5-74  
    Range ..... A2-1  
    Search ..... 5-64  
Speed Reference, Multiple (Multi-step  
    Speed Operation) ..... 5-39  
Speed Search Level ..... 5-64  
Stall Prevention  
    Level During Accel ..... 5-86  
    Level During Running ..... 5-87  
    Limit During Accel ..... 5-86  
    Selection During Accel ..... 5-86  
    Selection During Decel ..... 5-86  
    Selection During Running ..... 5-87  
Start-up, Initial ..... 2-1  
Start-up Procedure, Simplified ..... i  
Station Address, Ser. Comm.  
    (MODBUS Control) ..... 5-49  
**STOP** Indicator Lamp ..... 4-1, 4-2  
**STOP** Key ..... 4-1, 4-2  
    Function During Remote Run ..... 5-45  
Stop Method Sel. (OH) ..... A1-46  
Stopping Method ..... 5-14, 5-88  
Stopping Method at Comm. Error  
    (MODBUS Control) ..... 5-50  
Storage Function ..... 2-27  
Switching Frequency, Accel/Decel ..... 5-5

**- T -**

Temperature  
    Ambient ..... 1-1, A2-4  
    Storage ..... A2-4  
Terminals  
    Description ..... 1-6, 1-17  
    Functions ..... 1-6, 1-17  
    Screw Sizes ..... 1-3  
Test Run Using Digital Operator  
    ("Local" Control) ..... 2-24

**INDEX – Continued**

Thermal Overload Protection ..... 5-90  
 Motor OL Protection Selection ..... 5-90  
 Motor OL Protection Time Constant ..... 5-90  
 Motor Rated Current ..... 5-90  
 Motor Selection ..... 5-91  
 Torque Compensation ..... 5-93  
 Gain [K<sub>T</sub>] ..... 5-93  
 Time Constant ..... 5-93  
 Torque Control (Command) ..... 5-95  
 Selection ..... 5-95  
 Simplified Block Diagram ..... 5-97  
 Speed/Torque Control Selection Timer ..... 5-95  
 Speed Limit ..... 5-96  
 Speed Limit Selection ..... 5-96  
 Torque Reference Delay Time ..... 5-96  
 Torque Detection ..... 5-98  
 Overtorque Detection Level ..... 5-98  
 Overtorque Detection Time ..... 5-98  
 Selection ..... 5-98  
 Torque Limit ..... 5-101  
 Forward Torque Limit ..... 5-101  
 Forward Regenerative Torque Limit ..... 5-101  
 Reverse Torque Limit ..... 5-101  
 Reverse Regenerative Torque Limit ..... 5-101

Torque Reference (Internal) [Monitor Item] . A1-27  
 Trim Control ..... 5-69  
 ± Speed Limits ..... 5-69  
 Troubleshooting ..... 6-1  
 Flowcharts ..... 6-10

- U -

Up/Down Function ..... 5-68  
 Upper Limit, Freq. Ref. .... 5-34  
 "Up Arrow" Key ..... 4-1, 4-3  
 User Parameters ..... 5-106

- V -

V/f Pattern  
 Custom ..... 5-108  
 Standard ..... 5-106  
 Voltage  
 Input ..... 5-108, A2-1  
 Max. .... 5-108  
 Mid. Frequency ..... 5-108  
 Motor Rated ..... 2-5, 2-10

- W -

Weight ..... A5-1  
 Wiring  
 2-wire Control ..... 1-10b, 1-20  
 3-Wire Control ..... 1-10b, 1-22  
 Control Circuit ..... 1-15  
 Diagrams ..... 1-15, 1-23  
 Distances ..... 1-2, 1-15  
 Main Circuit Input/Output ..... 1-2  
 Encoder/PG-X2 Connections ..... 1-24

- Z -

Zero-Servo Control ..... 5-110  
 Zero-Servo Gain ..... 5-111  
 Zero-Servo Completion Width ..... 5-111  
 Zero Speed Control ..... 5-112  
 Zero Speed Operation ..... 5-112  
 Min. Output Frequency ..... 5-112





# GPD 515/G5 Drive



## **YASKAWA ELECTRIC AMERICA, INC.**

Drives Division 16555 W. Ryerson Rd., New Berlin, WI 53151, U.S.A.  
Phone: (800) YASKAWA (800-927-5292) Fax: (262) 782-3418  
Internet: <http://www.drives.com>

## **YASKAWA ELECTRIC AMERICA, INC.**

Chicago-Corporate Headquarters  
2121 Norman Drive South, Waukegan, IL 60085, U.S.A.  
Phone: (800) YASKAWA (800-927-5292) Fax: (847) 887-7310  
Internet: <http://www.yaskawa.com>

## **MOTOMAN INC.**

805 Liberty Lane, West Carrollton, OH 45449, U.S.A.  
Phone: (937) 847-6200 Fax: (937) 847-6277  
Internet: <http://www.motoman.com>

## **YASKAWA ELECTRIC CORPORATION**

New Pier Takeshiba South Tower, 1-16-1, Kaigan, Minatoku, Tokyo, 105-0022, Japan  
Phone: 81-3-5402-4511 Fax: 81-3-5402-4580  
Internet: <http://www.yaskawa.co.jp>

## **YASKAWA ELETRICO DO BRASIL COMERCIO LTDA.**

Avenida Fagundes Filho, 620 Bairro Saude Sao Paolo-SP, Brasil CEP: 04304-000  
Phone: 55-11-5071-2552 Fax: 55-11-5581-8795  
Internet: <http://www.yaskawa.com.br>

## **YASKAWA ELECTRIC EUROPE GmbH**

Am Kronberger Hang 2, 65824 Schwalbach, Germany  
Phone: 49-6196-569-300 Fax: 49-6196-888-301

## **MOTOMAN ROBOTICS AB**

Box 504 S38525, Torsas, Sweden  
Phone: 46-486-48800 Fax: 46-486-41410

## **MOTOMAN ROBOTEC GmbH**

Kammerfeldstrabe 1, 85391 Allershausen, Germany  
Phone: 49-8166-900 Fax: 49-8166-9039

## **YASKAWA ELECTRIC UK LTD.**

1 Hunt Hill Orchardton Woods Cumbernauld, G68 9LF, Scotland, United Kingdom  
Phone: 44-12-3673-5000 Fax: 44-12-3645-8182

## **YASKAWA ELECTRIC KOREA CORPORATION**

Paik Nam Bldg. 901 188-3, 1-Ga Euljiro, Joong-Gu, Seoul, Korea  
Phone: 82-2-776-7844 Fax: 82-2-753-2639

## **YASKAWA ELECTRIC (SINGAPORE) PTE. LTD.**

Head Office: 151 Lorong Chuan, #04-01, New Tech Park Singapore 556741, Singapore  
Phone: 65-282-3003 Fax: 65-289-3003

## **TAIPEI OFFICE (AND YATEC ENGINEERING CORPORATION)**

10F 146 Sung Chiang Road, Taipei, Taiwan  
Phone: 886-2-2563-0010 Fax: 886-2-2567-4677

## **YASKAWA JASON (HK) COMPANY LIMITED**

Rm. 2909-10, Hong Kong Plaza, 186-191 Connaught Road West, Hong Kong  
Phone: 852-2803-2385 Fax: 852-2547-5773

## **BEIJING OFFICE**

Room No. 301 Office Building of Beijing International Club,  
21 Jianguomanwai Avenue, Beijing 100020, China  
Phone: 86-10-6532-1850 Fax: 86-10-6532-1851

## **SHANGHAI OFFICE**

27 Hui He Road Shanghai 200437 China  
Phone: 86-21-6553-6600 Fax: 86-21-6531-4242

## **SHANGHAI YASKAWA-TONJI M & E CO., LTD.**

27 Hui He Road Shanghai 200437 China  
Phone: 86-21-6533-2828 Fax: 86-21-6553-6677

## **BEIJING YASKAWA BEIKE AUTOMATION ENGINEERING CO., LTD.**

30 Xue Yuan Road, Haidian, Beijing 100083 China  
Phone: 86-10-6232-9943 Fax: 86-10-6234-5002

## **SHOUGANG MOTOMAN ROBOT CO., LTD.**

7, Yongchang-North Street, Beijing Economic & Technological Development Area,  
Beijing 100076 China  
Phone: 86-10-6788-0551 Fax: 86-10-6788-2878

## **YEA, TAICHUNG OFFICE IN TAIWAN**

B1, 6F, No.51, Section 2, Kung-Yi Road, Taichung City, Taiwan, R.O.C.  
Phone: 886-4-2320-2227 Fax: 886-4-2320-2239