

G5 - HHP Drive Technical Manual



Compact High-Capacity Inverter Panels

400-V Class: 200-800 kW (320 to 1200kVA)

575-V Class: 300-1200 kW (400 to 1500kVA)

Preface

Thank you for purchasing the compact High-capacity VARISPEED-616G5 Inverter Panels with neurovector control.

This manual is designed to ensure correct and suitable application of the High-capacity VARISPEED-616G5 Inverter Panels. Read this manual before attempting to install, operate, maintain, or inspect an Inverter and keep this manual in a safe, convenient location for future reference. Be sure you understand all precautions and safety information before attempting application.

Safety Information

The following conventions are used to indicate precautions in this manual. Failure to heed precautions provided in this manual can result in serious or possibly even fatal injury or damage to the products or to related equipment and systems.

 **WARNING** Indicates precautions that, if not heeded, could possibly result in loss of life or serious injury.

 **CAUTION** Indicates precautions that, if not heeded, could result in relatively serious or minor injury, damage to the product, or faulty operation.

The warning symbols for ISO and JIS standards are different, as shown below.

ISO	JIS
	

The ISO symbol is used in this manual.

Both of these symbols appear on warning labels on Yaskawa products. Please abide by these warning labels regardless of which symbol is used.

Visual Aids

The following aids are used to indicate certain types of information for easier reference.



Indicates application examples.



Indicates supplemental information.



Indicates important information that should be memorized.

General Precautions

- The diagrams in this manual may be indicated without covers or safety shields to show details. Be sure to restore covers or shields before operating the Units and run the Units according to the instructions described in this manual.
- Any illustrations, photographs, or examples used in this manual are provided as examples only and may not apply to all products to which this manual is applicable.
- The products and specifications described in this manual or the content and presentation of the manual may be changed without notice to improve the product and/or the manual.
- When ordering a new copy of the manual due to damage or loss, contact your Yaskawa representatives or the nearest Yaskawa sales office and provide the manual number shown on the front cover.
- If nameplates become worn or damaged, order new ones from your Yaskawa representatives or the nearest Yaskawa sales office.

Safety Precautions

■ Confirmations upon Delivery

 CAUTION	Page
<ul style="list-style-type: none"> ● Never install an Inverter Panel that is damaged or missing components. Doing so can result in injury. 	2 - 2

■ Transportation

 CAUTION	Page
<ul style="list-style-type: none"> ● Crane operation must be performed only by an authorized person qualified to operate cranes. Otherwise, injury or damage caused by dropping lifted objects. 	2 - 4

■ Wiring

 WARNING	Page
<ul style="list-style-type: none"> ● Always turn OFF the input power supply before wiring terminals. Otherwise, an electric shock or fire can occur. 3 - 2 ● Wiring must be performed by an authorized person qualified in electrical work. Otherwise, an electric shock or fire can occur. 3 - 2 ● Be sure to ground the ground terminal. (400-V and 575-V Class Inverters: Ground to 10 Ω or less) Otherwise, an electric shock or fire can occur. 3 - 2 ● Always check the operation of any emergency stop circuits after they are wired. Otherwise, there is the possibility of injury. (Wiring is the responsibility of the user.) 3 - 2 ● Never touch the output terminals directly with your hands or allow the output lines to come into contact with the Inverter Panel casing. Never short the output circuits. Otherwise, electrical shock or grounding can occur. 3 - 2 	

 CAUTION	Page
<ul style="list-style-type: none"> ● Check to be sure that the voltage of the main AC power supply satisfies the rated voltage of the Inverter Panel. Injury or fire can occur if the voltage is not correct. 3 - 2 ● Do not perform voltage withstand tests on the Inverter Panel. Voltage withstand test can damage semiconductor elements and other components. 3 - 2 ● Connect Braking Resistor Units and Braking Units as shown in the I/O wiring examples. Otherwise, a fire can occur. 3 - 2 ● Tighten all terminal screws to the specified tightening torque. Otherwise, a fire may occur. 3 - 2 ● Do not connect AC power to output terminals U, V, and W. The internal Inverter Module will be damaged if voltage is applied to the output terminals. 3 - 2 	



CAUTION

- | | |
|---|-------|
| <ul style="list-style-type: none"> Do not connect phase-advancing capacitors or LC/RC noise filters to the output circuits.
The Inverter panel can be damaged or internal parts burnt if these devices are connected. | 3 - 2 |
| <ul style="list-style-type: none"> Do not connect electromagnetic switches or contactors to the output circuits.
If a load is connected while the Inverter Panel is operating, surge current will cause the overcurrent protection circuit to operate. | 3 - 2 |

■ Setting User Constants



CAUTION

- | | |
|---|----------------|
| <ul style="list-style-type: none"> Disconnect the load (machine, device) from the motor before autotuning.
The motor may turn, possibly resulting in injury or damage to equipment. Also, motor constants cannot be correctly set with the motor attached to a load. | Page
4 - 33 |
|---|----------------|

■ Trial Operation



WARNING

- | | |
|---|---------------|
| <ul style="list-style-type: none"> Check to be sure that the front door is closed before turning ON the power supply. Do not open the front door during operation.
An electric shock may occur if the front door is open when power is ON. | Page
5 - 2 |
| <ul style="list-style-type: none"> Do not come close to the machine when the fault reset function is used. If the alarm is cleared, the machine may start moving suddenly. Also, design the machine so that human safety is ensured even when it is restarted.
Injury may occur. | 5 - 2 |
| <ul style="list-style-type: none"> Provide a separate emergency stop switch; the Digital Operator STOP Key is valid only when its function is set.
Injury may occur. | 5 - 2 |
| <ul style="list-style-type: none"> Reset alarms only after confirming that the RUN signal is OFF. If an alarm is reset with the RUN signal turned ON, the machine may suddenly start.
Injury may occur. | 5 - 2 |



CAUTION

- | | |
|---|---------------|
| <ul style="list-style-type: none"> Don't touch the radiation fins (heat sink), braking resistor, or Braking Resistor Unit. These can become very hot.
Otherwise, a burn injury may occur. | Page
5 - 2 |
| <ul style="list-style-type: none"> Be sure that the motor and machine is within the applicable ranges before starting operation.
Otherwise, an injury may occur. | 5 - 2 |
| <ul style="list-style-type: none"> Provide a separate holding brake if necessary.
Otherwise, an injury may occur. | 5 - 2 |
| <ul style="list-style-type: none"> Don't check signals while the Inverter is running.
Otherwise, the equipment may be damaged. | 5 - 2 |
| <ul style="list-style-type: none"> Be careful when changing Inverter Panel settings. The Inverter Panel is factory set to suitable settings.
The equipment may be damaged if unsuitable settings are used. | 5 - 2 |

■ Maintenance and Inspection

 WARNING	
<ul style="list-style-type: none"> Do not touch the Inverter Panel terminals. Some of the terminals carry high voltages and are extremely dangerous. Touching the terminals can result in electric shock. 	Page 10 - 2
<ul style="list-style-type: none"> Always have the protective cover in place when power is being supplied to the Inverter. When attaching the cover, always turn OFF power to the Inverter through the MCCB. Doing so can result in electric shock. 	10 - 2
<ul style="list-style-type: none"> After turning OFF the main circuit power supply, wait until the CHARGE indicator light goes out before performance maintenance or inspections. The capacitor will remain charged and is dangerous. 	10 - 2
<ul style="list-style-type: none"> Maintenance, inspection, and replacement of parts must be performed only by authorized personnel. Remove all metal objects, such as watches and rings, before starting work. Always use grounded tools. Failure to heed these warning can result in electric shock. 	10 - 2
<ul style="list-style-type: none"> Before mounting or dismounting a Module, make sure that the main circuit and control power supply have been turned OFF. Not doing so can result in electric shock. 	10 - 6
<ul style="list-style-type: none"> Do not dismount a Module until the CHARGE lamp on the Module turns OFF after turning OFF the power supply. An electric shock may occur is the Module is dismounted while still charged. 	10 - 6
<ul style="list-style-type: none"> Use special lifts for mounting or dismounting a Module. Not doing so can result in injury. 	10 - 6
<ul style="list-style-type: none"> The Modules are heavy, and mounting or dismounting the Modules must be performed by three workers: One to operate the lift and two others for mounting and dismounting the Modules. Not doing so can result in injury 	10 - 6
<ul style="list-style-type: none"> Before disposing of a Module, open a hole in the heat sink attached to the Module to purge gas. Exposing the heat sink to a high temperature without opening a hole in the heat sink can result in explosion and injury. 	10 - 14

 CAUTION	
<ul style="list-style-type: none"> A CMOS IC is used in the control board. Handle the control board and CMOS IC carefully. The CMOS IC can be destroyed by static electricity if touched directly. The CMOS IC can be destroyed by static electricity if touched directly. 	Page 10 - 2
<ul style="list-style-type: none"> Do not change the wiring, or remove connectors or the Digital Operator, during operation. Performing this word during operation can result in personal injury. 	10 - 2

■ Others

 WARNING	
<ul style="list-style-type: none"> Do not attempt to modify or alter the Inverter. Alterations or modifications can result in electrical shock or injury. 	

Warning Label Contents and Position

There is a warning label on the Inverter in the position shown in the following illustration. Always heed the warnings given on this label.

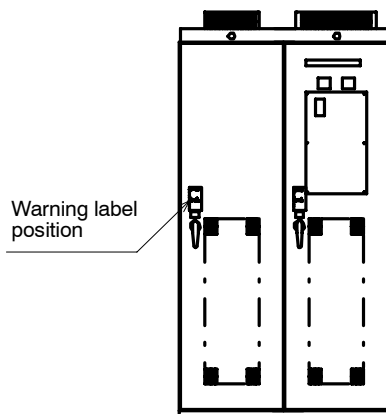

The illustration shows a 400-V class (200-kW) and a 575-V class (300-kW) Inverter.

Warning Label Contents

 危 険 

けが、感電のおそれがあります。

- 据え付け、運転の前には必ず取扱説明書を読んで、その指示に従ってください。

感電のおそれがあります。

- 通電中及び電源遮断後 5 分以内は、ドアを開けないでください。
- 確実に接地を行ってください。

May cause injury or electric shock.

- Please follow the instructions in the manual before installation or operation.
- Disconnect all power before opening the door of panel. Wait 5 minutes until DC Bus capacitors discharge.
- Use proper grounding techniques.

Definition of Terms

The following definitions are used in this manual unless otherwise specified.

Inverter: Inverter Panel

Module: Inverter Module or Converter Module

How to Change the Digital Operator Display from Japanese to English

If the Digital Operator displays messages in Japanese, change to the English mode using the following steps.

(This manual provides descriptions for the English mode.)

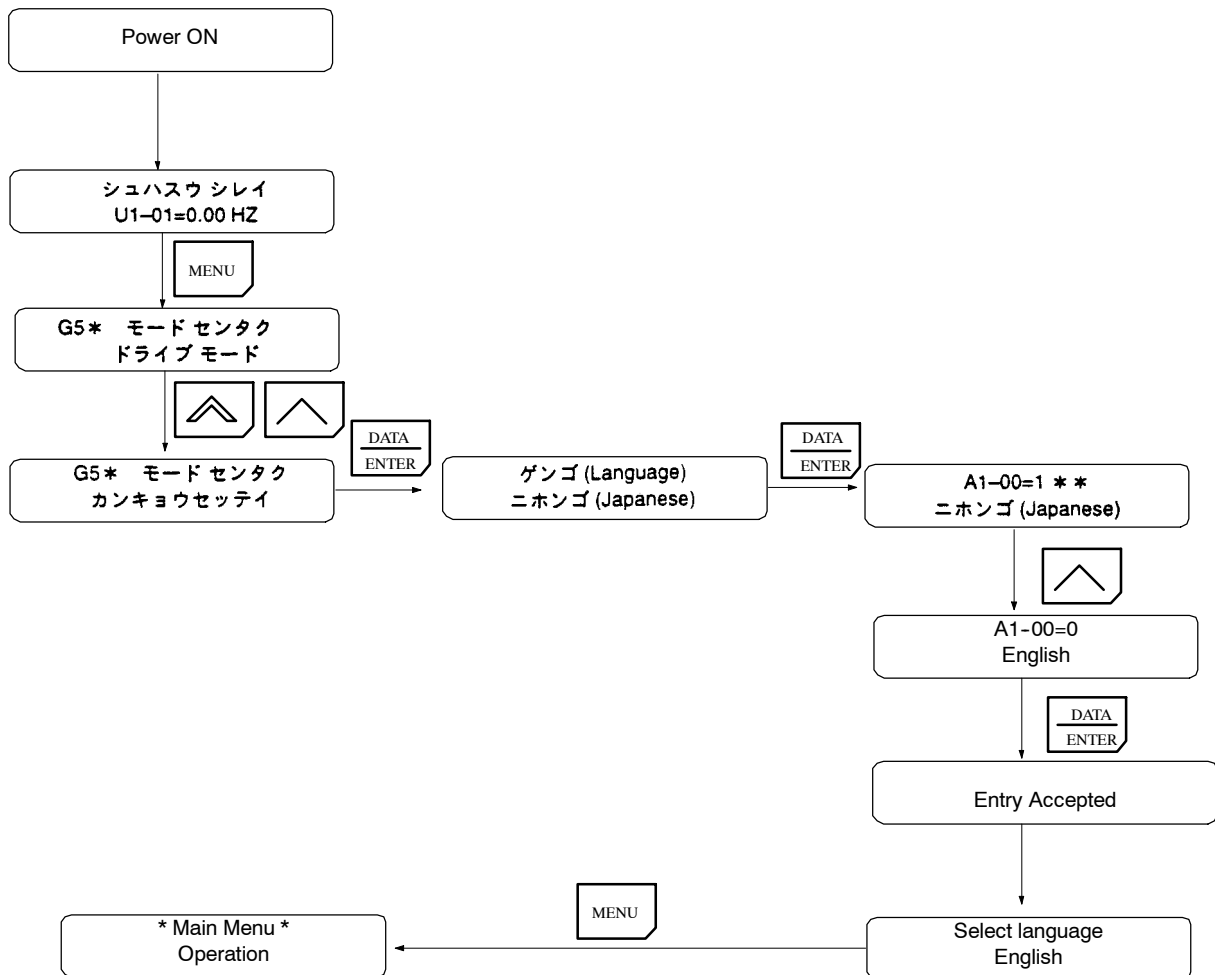

CONTENTS

1	Introduction	1
2	Handling Inverters	2
3	Wiring	3
4	Setting User Constants	4
5	Trial Operation	5
6	Basic Operation	6
7	Advanced Operation	7
8	User Constants	8
9	Troubleshooting	9
10	Maintenance and Inspection	10
11	Specifications	11
12	Appendix	12

Table of Contents

Preface	i
Safety Information	ii
Visual Aids	iii
General Precautions	iv
Safety Precautions	v
Warning Label Contents and Position	viii
Definition of Terms	viii
How to Change the Digital Operator Display from Japanese to English	ix
1 Introduction	1 - 1
1.1 Outline and Functions	1 - 2
1.1.1 Outline of Control Methods	1 - 2
1.1.2 Functions	1 - 2
1.2 Nomenclature	1 - 7
1.2.1 VS-616G5 Components	1 - 7
1.2.2 Digital Operator Components	1 - 8
2 Handling Inverters	2 - 1
2.1 Confirmations upon Delivery	2 - 2
2.1.1 Nameplate Information	2 - 2
2.2 Temporary Storage	2 - 3
2.2.1 Storage Location	2 - 3
2.2.2 Storage Method	2 - 3
2.3 Transportation	2 - 4
2.3.1 Precautions During Transportation	2 - 4
2.3.2 Lifting with Wires	2 - 4
2.3.3 Transporting on Rollers	2 - 5
2.4 External Dimensions and Mounting Dimensions	2 - 6
2.5 Checking and Controlling the Installation Site	2 - 10
2.5.1 Installation Site	2 - 10
2.5.2 Controlling the Ambient Temperature	2 - 10
2.5.3 Protecting the Inverter Panel from Foreign Matter	2 - 10
2.5.4 Floor Level	2 - 10
2.5.5 Inverter Panel Connections (Side-by-side Connection)	2 - 10
2.5.6 Tightening Anchor Bolts	2 - 11
2.6 Installation Orientation and Space	2 - 13
2.7 Removing/Attaching the Digital Operator	2 - 14
3 Wiring	3 - 1
3.1 Connection Diagram	3 - 3
3.2 Terminal Positions	3 - 5
3.3 Cable Sizes	3 - 7
3.4 Wiring Main Circuit Terminals	3 - 9
3.4.1 Main Circuit Terminal Functions	3 - 9

3.4.2	Main Circuit Configurations	3 - 10
3.4.3	Precautions for Wiring Main Circuit Power Input	3 - 10
3.5	Wiring Control Circuit Terminals	3 - 12
3.5.1	Control Circuit Terminal Functions	3 - 12
3.6	Wiring Check	3 - 13
3.7	Installing and Wiring PG Speed Control Cards	3 - 14
3.7.1	Installing a PG Speed Control Card	3 - 14
3.7.2	PG Speed Control Card Terminal Blocks	3 - 15
3.7.3	Wiring a PG Speed Control Card	3 - 17
3.7.4	Wiring PG Speed Control Card Terminal Blocks	3 - 22
3.7.5	Selecting the Number of PG (Encoder) Pulses	3 - 25
3.8	Grounding	3 - 27
3.8.1	Connection of Ground Bus Bar	3 - 27
3.8.2	Connection of Ground Cable for Control Signals	3 - 27
4	Setting User Constants	4 - 1
4.1	Using the Digital Operator	4 - 2
4.2	Modes	4 - 4
4.2.1	Inverter Modes	4 - 4
4.2.2	Switching Modes	4 - 5
4.2.3	User Constant Access Levels	4 - 6
4.2.4	Operation Mode	4 - 12
4.2.5	Initialize Mode	4 - 21
4.2.6	Programming Mode	4 - 29
4.2.7	Autotuning Mode	4 - 33
4.2.8	Modified Constants Mode	4 - 35
5	Trial Operation	5 - 1
5.1	Procedure	5 - 3
5.2	Trial Operation Procedures	5 - 4
5.2.1	Power ON	5 - 4
5.2.2	Checking the Display Status	5 - 4
5.2.3	Initializing Constants	5 - 4
5.2.4	Setting Input Voltage	5 - 5
5.2.5	Autotuning	5 - 10
5.2.6	No-load Operation	5 - 12
5.2.7	Loaded Operation	5 - 12
6	Basic Operation	6 - 1
6.1	Common Settings	6 - 2
6.1.1	Setting the Access Level and Control Method: A1-01, A1-02	6 - 2
6.1.2	Frequency Reference Settings: b1-01, H3-01, H3-08, H3-09	6 - 4
6.1.3	Frequency Reference from Digital Operator: b1-01, o1-03, d1-01 to d1-09	6 - 7
6.1.4	Run Source and Sequence Input Responsiveness: b1-02, b1-06, b1-07	6 - 9
6.1.5	Acceleration/Deceleration Times: C1-01 through C1-08, C1-09, C1-10, C1-11	6 - 10
6.1.6	Prohibiting Reverse Operation: b1-04	6 - 11
6.1.7	Selecting the Stopping Method: b1-03	6 - 12
6.1.8	Multi-function Input Settings: H1-01 through H1-06	6 - 13
6.2	Open-loop Vector Control	6 - 18
6.2.1	Autotuning	6 - 18
6.2.2	Autotuning Faults	6 - 19

6.3	V/f Control	6 - 21
6.3.1	Setting the Motor Constants: E1-01, E1-02, E2-01	6 - 21
6.3.2	V/f Pattern Selection: E1-03	6 - 22
6.4	Flux Vector Control	6 - 26
6.4.1	PG Speed Control Card Settings	6 - 26
6.4.2	Setting the Zero-speed Operation Constants	6 - 29
6.4.3	Autotuning	6 - 31
6.4.4	Speed Control (ASR) Structure	6 - 33
6.4.5	Speed Control (ASR) Gain	6 - 36
6.5	V/f Control with PG	6 - 39
6.5.1	Motor Constants: E1-01, E1-02, E2-01, E2-04	6 - 39
6.5.2	V/f Pattern Selection: E1-03	6 - 40
6.5.3	PG Speed Control Card Settings	6 - 41
6.5.4	Speed Control (ASR) Structure	6 - 43
6.5.5	Adjusting Speed Control (ASR) Gain	6 - 44
7	Advanced Operation	7 - 1
7.1	Open-loop Vector Control	7 - 2
7.1.1	Torque Limit Function	7 - 4
7.1.2	Adjusting Speed Feedback	7 - 5
7.1.3	Setting/Adjusting Motor Constants	7 - 6
7.2	Normal V/f Control	7 - 10
7.2.1	Energy-saving Control Function	7 - 12
7.2.2	Hunting-prevention Function	7 - 12
7.2.3	Setting Motor Constants	7 - 13
7.3	Flux Vector Control	7 - 15
7.3.1	Droop Control Function	7 - 17
7.3.2	Zero-servo Function	7 - 18
7.3.3	Torque Control	7 - 19
7.3.4	Speed/Torque Control Switching Function	7 - 26
7.3.5	Torque Limit Function	7 - 27
7.3.6	Setting/Adjusting Motor Constants	7 - 29
7.4	V/f Control with PG Feedback	7 - 33
7.4.1	Energy-saving Control Function	7 - 35
7.4.2	Hunting-prevention Function	7 - 35
7.4.3	Setting Motor Constants	7 - 36
7.5	Common Functions	7 - 38
7.5.1	Application Constants: b	7 - 41
7.5.2	Tuning Constants: C	7 - 50
7.5.3	Reference Constants: d	7 - 54
7.5.4	Option Constants: F	7 - 56
7.5.5	External Terminal Functions: H	7 - 62
7.5.6	Protective Functions: L	7 - 84
7.5.7	Operator Constants: o	7 - 99
8	User Constants	8 - 1
8.1	Initialize Mode Constants	8 - 3
8.2	Programming Mode Constants	8 - 4
8.2.1	Application Constants: b	8 - 4
8.2.2	Autotuning Constants: C	8 - 10
8.2.3	Reference Constants: d	8 - 16
8.2.4	Motor Constant Constants: E	8 - 19
8.2.5	Options Constants: F	8 - 23

8.2.6 Terminal Constants: H	8 - 26
8.2.7 Protection Constants: L	8 - 33
8.2.8 Operator Constants: o	8 - 39
8.2.9 Factory Settings that Change with the Control Method (A1-02)	8 - 41
8.2.10 Factory Settings that Change with the Inverter Capacity (o2-04)	8 - 42
9 Troubleshooting	9 - 1
9.1 Protective and Diagnostic Functions	9 - 2
9.1.1 Fault Detection	9 - 2
9.1.2 Minor Fault Detection	9 - 6
9.1.3 Operation Errors	9 - 8
9.2 Troubleshooting	9 - 9
9.2.1 If Constant Constants Cannot Be Set	9 - 9
9.2.2 If the Motor Does Not Operate	9 - 9
9.2.3 If the Direction of the Motor Rotation is Reversed	9 - 11
9.2.4 If the Motor Does Not Put Out Torque or If Acceleration is Slow	9 - 11
9.2.5 If the Motor Does Not Operate According to Reference	9 - 11
9.2.6 If the Slip Compensation Function Has Low Speed Precision	9 - 11
9.2.7 If There is Low Speed Control Accuracy at High-speed Rotation in Open-loop Vector Control Mode	9 - 12
9.2.8 If Motor Deceleration is Slow	9 - 12
9.2.9 If the Motor Overheats	9 - 12
9.2.10 If There is Noise When the Inverter is Started or From an AM Radio	9 - 13
9.2.11 If the Ground Fault Interrupter Operates When the Inverter is Run	9 - 13
9.2.12 If There is Mechanical Oscillation	9 - 13
9.2.13 If the Motor Rotates Even When Inverter Output is Stopped	9 - 14
9.2.14 If 0 V is Detected When the Fan is Started, or Fan Stalls	9 - 14
9.2.15 If Output Frequency Does Not Rise to Frequency Reference	9 - 14
10 Maintenance and Inspection	10 - 1
10.1 Maintenance and Inspection	10 - 3
10.1.1 Daily Inspection	10 - 3
10.1.2 Periodic Inspection	10 - 3
10.1.3 Periodic Maintenance of Parts	10 - 3
10.1.4 Replacement of In-panel Ventilation Fan Unit	10 - 4
10.1.5 Dismounting and Mounting the Module	10 - 6
11 Specifications	11 - 1
11.1 Standard Inverter Specifications	11 - 2
11.2 Specifications of Options and Peripheral Devices	11 - 4
11.2.1 Selection of MCCB and Ground Fault Interrupter	11 - 4
11.2.2 Module Draw-out Lift	11 - 4
11.2.3 Option Cards	11 - 6
12 Appendix	12 - 1
12.1 Inverter Application Precautions	12 - 2
12.1.1 Selection	12 - 2
12.1.2 Settings	12 - 2
12.1.3 Handling	12 - 2
12.2 Motor Application Precautions	12 - 3
12.2.1 Using the Inverter for an Existing Standard Motor	12 - 3
12.2.2 Power Transmission Mechanism (Speed Reducers, Belts, and Chains)	12 - 3
12.3 Peripheral Device Application Precautions	12 - 4

12.4 Wiring Examples	12 - 5
12.4.1 Using Two Braking Units in Parallel	12 - 5
12.4.2 Using a JVOP-95-□, -96-□ VS Operator	12 - 6
12.4.3 Using an Open-collector Transistor for Operation Signals	12 - 7
12.4.4 Using Open-collector, Contact Outputs	12 - 7
12.5 Function Block Diagram	12 - 8
12.6 Spare Parts Lists	12 - 10
12.7 User Constants	12 - 12

1

Introduction

This chapter provides an overview of the VS-616G5 Inverter and describes its functions and components.

1.1 Outline and Functions	1 - 2
1.1.1 Outline of Control Methods	1 - 2
1.1.2 Functions	1 - 2
1.2 Nomenclature	1 - 7
1.2.1 VS-616G5 Components	1 - 7
1.2.2 Digital Operator Components	1 - 8

1.1 Outline and Functions

The VS-616G5 Inverters provides full-current vector control based on advanced control logic. An autotuning function is included for easy vector control.

The Digital Operator provides a liquid crystal display that is 2 lines by 16 characters in size. User constant settings and monitor items are easily read in interactive operations in either Japanese or English. (The display language can be changed by setting a user constant.)

1.1.1 Outline of Control Methods

The VS-616G5 uses four control methods.

- Open-loop vector control (factory setting)
- Flux vector control
- V/f control without PG
- V/f control with PG feedback

PG stands for pulse generator (encoder).

Vector control is a method for removing interference with magnetic flux and torque, and controlling torque according to references.

Current vector control independently controls magnetic flux current and torque current by simultaneously controlling the motor primary current and phases. This ensures smooth rotation, high torque, and accurate speed/torque control at low speeds.

Vector control can be replaced by the conventional V/f control system. If the motor constants required for vector control are not known, the motor constants can be automatically set with autotuning.

The control methods are effective for the following applications:

- Open-loop vector control: General variable-speed drive.
- Flux vector control: Simple servodrive, high-precision speed control/torque control.
- V/f control without PG: Conventional Inverter control mode. Used for multi-drive operation (connecting multiple motors to one Inverter).
- V/f control with PG feedback: Simple speed feedback control. (For applications with the PG connected to the machine shaft rather than the motor shaft.)

The control characteristics for each mode are shown in Table 1.1.

Table 1.1 Control Method Characteristics

Characteristic	Vector Control		V/f Control	
	Open-loop	Flux Vector	Without PG	With PG feedback
Speed Control Range	1:100	1:1000	1:40	1:40
Speed Control Precision	±0.2 %	±0.02 %	±2 to 3 %	±0.03 %
Initial Drive	150% at 1 Hz	150% at 0 r/min	150% at 3 Hz	

1.1.2 Functions

■ Autotuning

Autotuning is effective for vector control. It solves problems in applicable motor restrictions and difficult constant settings. The motor constants are automatically set by entering a value from the motor's rating nameplate.

Autotuning allows flux vector control to operate accurately with virtually any normal AC induction motor, regardless of the supplier.

Always perform autotuning for motor unit separately before vector control operation.

■ Torque Control

Torque control is effective for flux vector control with PG. Torque is controlled by taking multi-function analog input signals as torque references. Torque control accuracy is ±5%. Switching is possible between torque control and speed control.

■ V/f Pattern Settings

V/f pattern settings are effective for V/f control. Select a V/f pattern according to the application from among the 15 preset V/f patterns. Custom V/f patterns can also be set.

■ Frequency References

The following five types of frequency references can be used to control the output frequency of the Inverter.

- Numeric input from the Digital Operator
- Voltage input within a range from 0 to 10 V
- Voltage input within a range from 0 to ± 10 V (with negative voltages, rotation is in the opposite direction from the run command.)
- Current input within a range from 4 to 20 mA
- Input from Option Card

Any of the above frequency references can be used by setting a constant.

A maximum of nine frequency references can be registered with the Inverter. With remote multi-step speed reference inputs, the Inverter can operate in multi-step speed operation with a maximum of nine speed steps.

■ PID Control

The Inverter has a PID control function for easy follow-up control. Follow-up control is a control method in which the Inverter varies the output frequency to match the feedback value from the sensor for a set target value.

Follow-up control can be applied to a variety of control operations, such as those listed below, depending on the contents detected by the sensor.

- Speed Control: With a speed sensor, such as a tachogenerator, the Inverter regulates the rotating speed of the motor regardless of the load of the motor or synchronizes the rotating speed of the motor with that of another motor.
- Pressure Control: With a pressure sensor, the Inverter performs constant pressure control.
- Flow-rate Control: By sensing the flow rate of a fluid, the Inverter performs precise flow-rate control.
- Temperature Control: With a temperature sensor, the Inverter performs temperature control by fan speed.

■ Zero-servo Control

Zero-servo control is effective with flux vector control. Even at a motor speed of zero (r/min), a torque of 150% of the motor's rated torque can be generated and the average servomotor holding power (stopping power) can be obtained.

■ Speed Control By Feedback

Speed control using feedback is effective with a PG. An optional PG Speed Control Card can be used to enable feedback control for speeds, thereby improving speed control accuracy.

■ Dwell Function

By holding the output frequency for a constant time during acceleration and deceleration, acceleration and deceleration can be performed without stepping out even when driving a motor with a large startup load.

■ Low Noise

The output transistor of the Inverter is an IGBT (insulated gate bipolar transistor). Using sine-wave PWM with a high-frequency carrier, the motor does not generate metallic noise.

■ Monitor Function

The following items can be monitored with the Digital Operator: Frequency reference, output frequency, output current, motor speed, output voltage reference, main-circuit DC voltage, output power, torque reference, status of input terminals, status of output terminals, operating status, total operating time, software number, speed deviation value, PID feedback value, fault status, fault history, etc.

All types of data can be monitored even with multi-function analog output.

■ Bilingual Digital Operator

The Digital Operator can display either English or Japanese. The Digital Operator's liquid crystal display provides a 16-character x 2-line display area.

Easy-to-read displays allow the advanced functions of the Inverter to be set in interactive operations to input constants, monitoring items, etc. Change the constant setting to select the English display.

■ Harmonic Countermeasures

All VS-616G5 Inverters incorporate a DC reactor in the Inverter Panel to easily handle high-frequency control guidelines.

■ User Constant Structure and Three Access Levels

The VS-616G5 has a number of user constants for setting various functions. These user constants are classified into a hierarchy to make them easier to use.

The levels are as follows from top to bottom: Modes, Groups, Functions, and Constants. The access levels for the user constants are shown in *Table 1.2*.

Table 1.2 Access Levels for User Constants

Level	Contents
Mode	Classified according to operation Operation: For operating the Inverter. (All kinds of monitoring are possible.) Initialize: For selecting the language displayed at the Digital Operator, setting access levels, initialization, and the control modes. Programming: For setting user constants for operation. Autotuning: For automatic calculation or setting motor constants. (Only under the vector control mode.) Modified constants: For referencing or changing user constants after shipping.
Groups	Classified by application.
Functions	Classified by function. (See user constants.)
Constants	Individual user constant settings.

The VS-616G5 allows the following three access levels to be set in order to further simplify setting user constants. (An access level is a range of user constants that can be referenced or set.)

Quick-Start	Reads/sets user constants required for trial operation. [Factory setting]
Basic	Reads/sets user constants that are commonly used.
Advanced	Reads/sets all the user constants that can be used.

In general, press the DATA/ENTER Key to move from an upper to a lower level. This varies somewhat, however, according to the access level, as shown in Fig. 1.1. For the Quick-Start access level, which has few user constants that can be set, pressing the DATA/ENTER Key jumps directly to the user constant level; whereas for the Advanced access level, which has many user constants, pressing the DATA/ENTER Key first leads to the Group level.

1

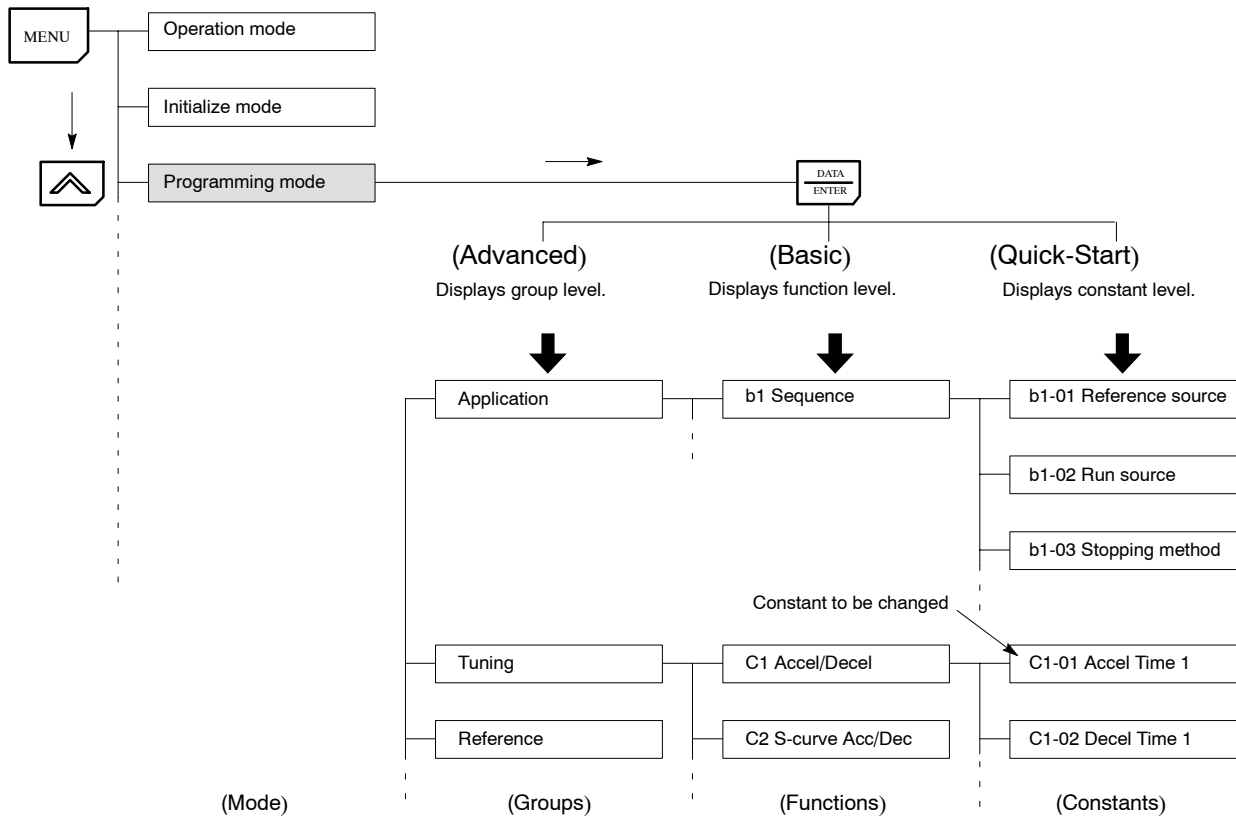

Fig 1.1 Access Level Structure

1.2 Nomenclature

This section provides the names of VS-616G5 components, and the components and functions of the Digital Operator.

1.2.1 VS-616G5 Components

The appearance of Inverter and the names of its components are shown in *Figure 1.2*.

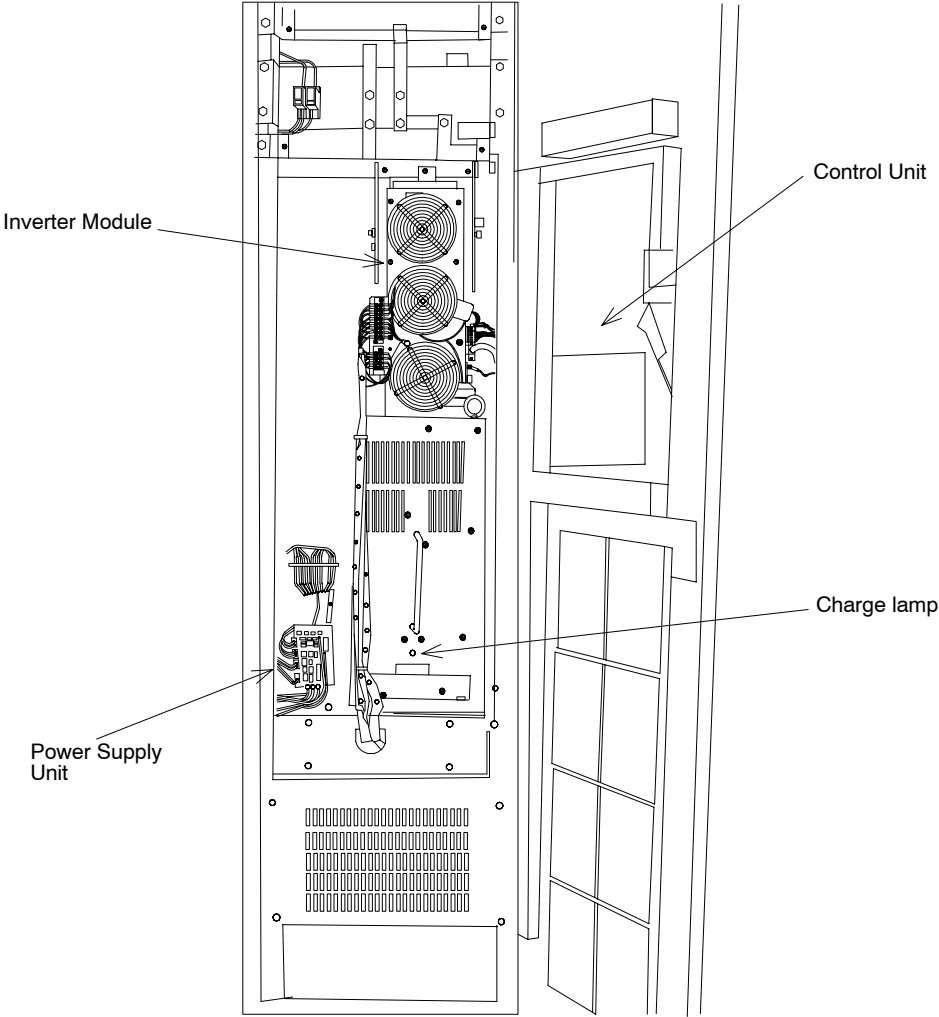

Fig 1.2 Appearance of VS-616G5, Model CIMR-G5A (400 V, 200 kW)

1.2.2 Digital Operator Components

This section describes the component names and functions of the Digital Operator. The component names and functions are shown in *Figure 1.3* and key functions are described in *Table 1.3*.

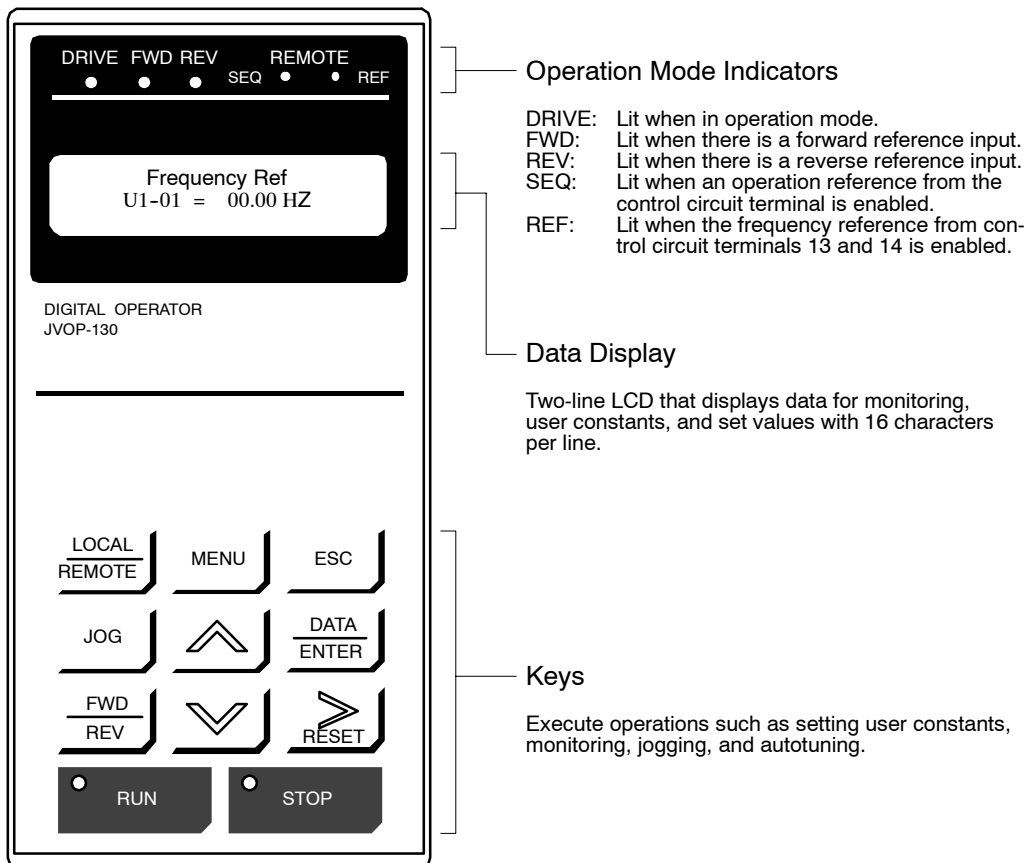









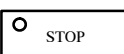

Fig 1.3 Digital Operator Component Names and Functions

1

Table 1.3 Key Functions

Key	Name	Function
	LOCAL/REMOTE Key	Switches between (LOCAL) operation via the Digital Operator and control circuit terminal (REMOTE) operation. This key can be enabled or disabled by setting a user constant (o2-01).
	MENU Key	Displays menus.
	ESC Key	Returns to the status before the DATA/ENTER Key was pressed.
	JOG Key	Enables jog operation when the VS-616G5 is being operated from the Digital Operator.
	FWD/REV Key	Selects the rotation direction of the motor when the VS-616G5 is being operated from the Digital Operator.
	RESET Key	Sets the number of digits for user constant settings. Also acts as the reset key when a fault has occurred.
	Increment Key	Selects menu items, groups, functions, and user constant names, and increments set values.
	Decrement Key	Selects menu items, groups, functions, and user constant names, and decrements set values.
	DATA/ENTER Key	Enters menu items, functions, constants, and set values after they are set.
	RUN Key	Starts the VS-616G5 operation when the VS-616G5 is in operation with the Digital Operator.
	STOP Key	Stops VS-616G5 operation. This key can be enabled or disabled by setting a user constant (o2-02) when operating from the control circuit terminal.

1

Note Except in diagrams, keys are referred to using the key names listed in the above table.

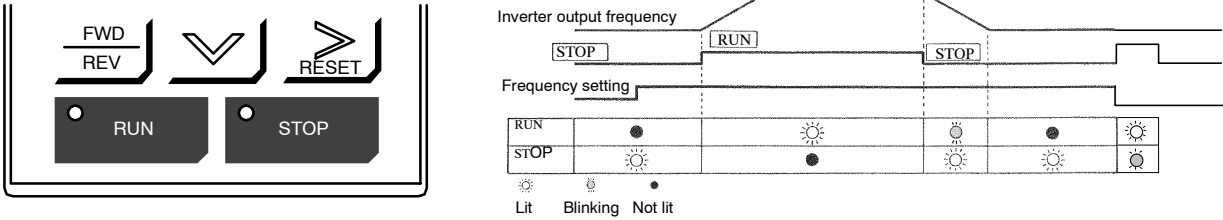

The RUN and STOP indicators light and blink to indicate operating status.

Fig 1.4 RUN and STOP Indicators

1

2

Handling Inverters

2

This chapter describes the checks required upon receiving a VS-616G5 Inverter and describes installation methods.

2.1	Confirmations upon Delivery	2 - 2
2.1.1	Nameplate Information	2 - 2
2.2	Temporary Storage	2 - 3
2.2.1	Storage Location	2 - 3
2.2.2	Storage Method	2 - 3
2.3	Transportation	2 - 4
2.3.1	Precautions During Transportation	2 - 4
2.3.2	Lifting with Wires	2 - 4
2.3.3	Transporting on Rollers	2 - 5
2.4	External Dimensions and Mounting Dimensions	2 - 6
2.5	Checking and Controlling the Installation Site	2 - 10
2.5.1	Installation Site	2 - 10
2.5.2	Controlling the Ambient Temperature	2 - 10
2.5.3	Protecting the Inverter Panel from Foreign Matter	2 - 10
2.5.4	Floor Level	2 - 10
2.5.5	Inverter Panel Connections (Side-by-side Connection)	2 - 10
2.5.6	Tightening Anchor Bolts	2 - 11
2.6	Installation Orientation and Space	2 - 13
2.7	Removing/Attaching the Digital Operator	2 - 14

2.1 Confirmations upon Delivery

⚠ CAUTION
<ul style="list-style-type: none"> Never install an Inverter Panel that is damaged or missing components. Doing so can result in injury.

Check the following items as soon as the Inverter is delivered.

Table 2.1 Checks

Item	Method
Has the correct model of Inverter been delivered?	Check the model number on the nameplate on the back of the front panel of the Inverter Panel (See 2.1.1).
Is the Inverter damaged in any way?	Inspect the entire exterior of the Inverter to see if there are any scratches or other damage resulting from shipping.
Are any screws or other components loose?	Use a screwdriver or other tools to check for tightness.

If you find any irregularities in the above items, contact the agency from which you purchased the Inverter or your Yaskawa representative immediately.

2.1.1 Nameplate Information

Example Nameplate

Standard domestic (Japan) Inverter: 3-phase, 400 VAC, 200 kW standards

	TRANSISTOR INVERTER	
Model number →	MODEL CIMR-G5A4200 SPEC 42008A	← Inverter specifications
	RATINGS	
Input specifications →	INPUT 380 - 460 V 385 A	
Output specifications →	OUTPUT 3PH 0 - 460 VAC 0 - 414 A	
Output capacity →	KVA	
Lot number →	CODE No. 71616-G5A42008A.	
Serial number →	SER No. MASS 800Kg DATA	← Mass
	YASKAWA ELECTRIC CORPORATION JAPAN	

Inverter Panel Model Numbers

CIMR - G5 A 4 2008 A

Inverter Panel VS-616G5

No.	Specification
A	Standard domestic model

No.	Voltage Class
4	AC input, 3-phase, 400 V
5	AC input, 3-phase, 575 V

Revision code (Specification code is entered for special specifications.)

No.	Protective structure
8	Enclosed self-standing structure

No.	Max. Motor Capacity
200	200 kW
400 to 800	400 kW to 800 kW

2.2 Temporary Storage

Observe the following precautions when storing the Inverter Panel for a period of time before installation.

2.2.1 Storage Location

Store the Inverter Panel under the following conditions.

- Indoors
- In a level and flat location
- In a well-ventilated location at a low temperature and low humidity
- In a locations not subject to vibration
- In a locations not subject to dust, harmful gases, or salt

2.2.2 Storage Method

Store the Inverter Panel in the following manner.

- Place the Inverter Panel on sleepers as shown below. (Do not place it directly on the floor.)
- Cover the Inverter Panel with the polyethylene cover that is attached at the time of shipment.

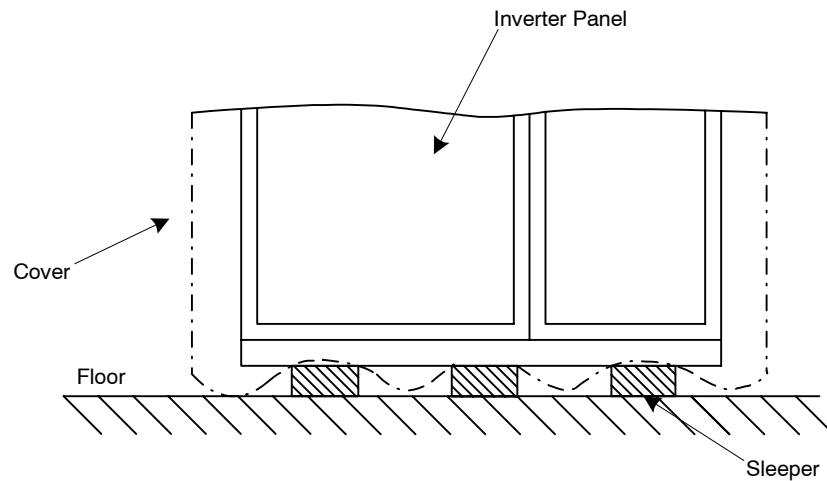

Fig 2.1 Storage Method

2.3 Transportation



CAUTION

- Crane operation must be performed only by an authorized person qualified to operate cranes. Otherwise, injury or damage caused by dropping lifted objects.

The Inverter Panel should be transported using either the lifting wires or rollers. Before transporting the Inverter Panel, make sure that the door and internal components are secured.

2.3.1 Precautions During Transportation

- Do not push or drag the Inverter Panel on concrete floors or floors other than ones which have embedded channel base or steel plates.
- Do not turn over or roll the Inverter Panel.
- Do not subject the Inverter Panel to vibration or shock exceeding 4.9 m/s^2 (0.5 G) during transportation.

2.3.2 Lifting with Wires

- When lifting the Inverter Panel, use wires with sufficient strength that withstand the mass.
- When using wires to lift the Inverter Panel, route wires so as to provide a lifting angle of 60° min., as shown in *Figure 2.2* below. If the lifting angle is less than this, allowable lifting loads will not be assured.
- Place each wire through the lifting hole provided in the lifting angle.
- Do not lift the Inverter Panel as shown in *Figure 2.3*.
- When lifting the Inverter Panel using a crane, first gradually lift the wires until they become taught. Lift the Inverter Panel only after making sure that the wires are taught. Lift the Inverter Panel up or down slowly. When placing the Inverter Panel on the floor, stop lowering it just before it reaches the floor and then slowly lower it on the floor to avoid any shock to the Inverter Panel.

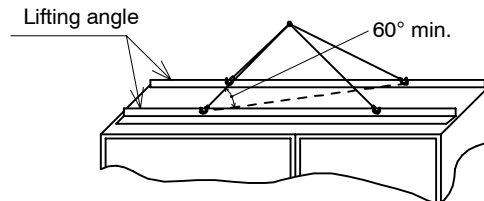

Fig 2.2 Wire Lifting

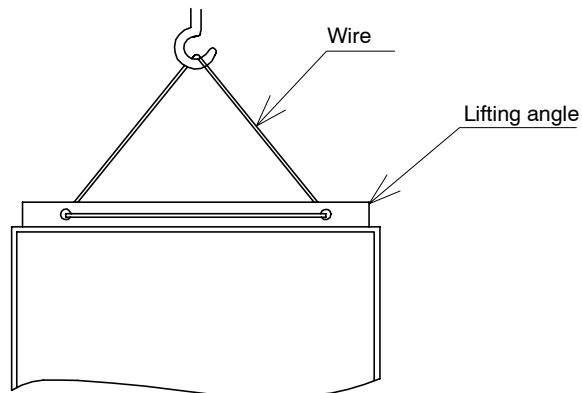

Fig 2.3 Bad Lifting Example

2.3.3 Transporting on Rollers

When transporting the Inverter Panel using rollers, carefully push the Inverter Panel so as not to distort the frame or damage the Inverter Panel surface.

- Use rollers equivalent to gas pipes with an approx. diameter of 30 to 50 mm. The length should be such that the rollers extend beyond the Inverter Panel on both sides by approx. 100 mm.
- When the Inverter Panel has been moved to a desired location, carefully lift the Inverter Panel with a lifting bar and remove the rollers. Insert the lifting bar at the four corners of the box as shown in *Figure 2.4*.

When inserting a lifting bar under the door, be careful not to damage the door with the lifting bar.

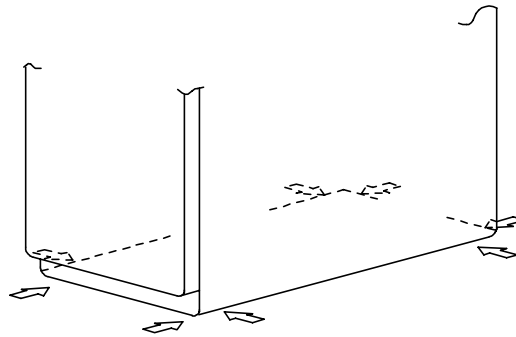
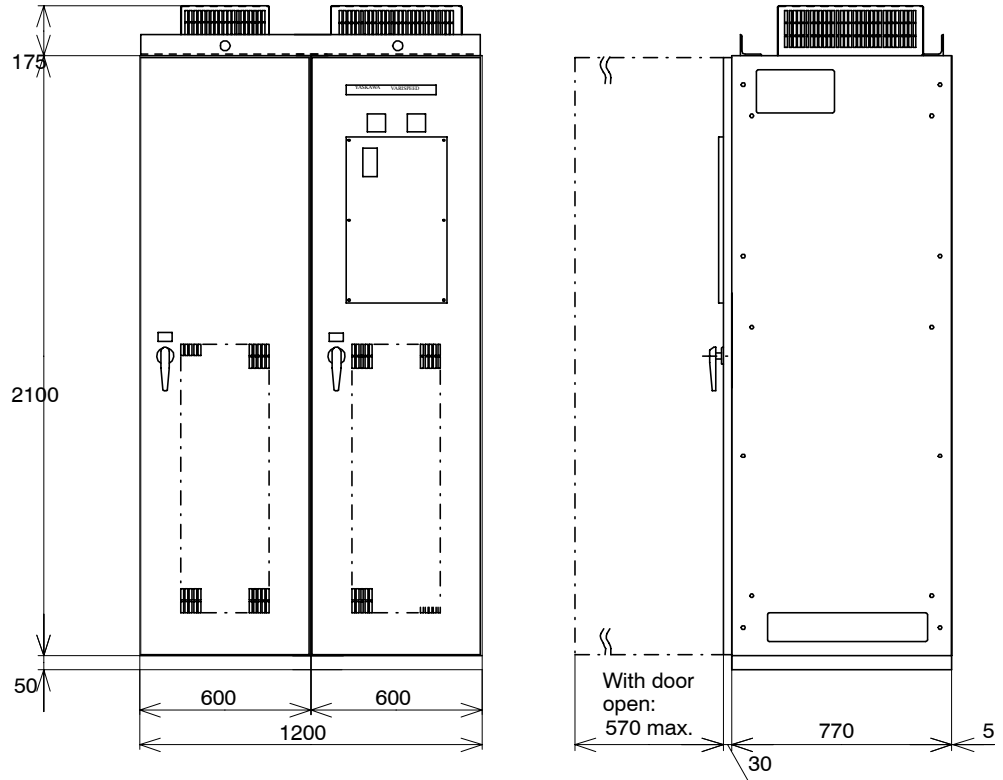

Fig 2.4 Lifting Bar Insertion Locations

2.4 External Dimensions and Mounting Dimensions

■ 400-V Class (200 kW) and 575-V Class (300 kW) Inverter Panels



Generated loss (W)	CIMR-G5A□	4200	5300
	Converter Module		1030
Inverter Module		3430	4410
Control Unit		50	50
Discharge Resistor		60	100
Control Power Transformer		80	80
DC Reactor		150	150
Coupling Reactor		-	-
	Total	4800	5820

2

■ 400-V Class (400 kW) and 575-V Class (600 kW) Inverter Panels

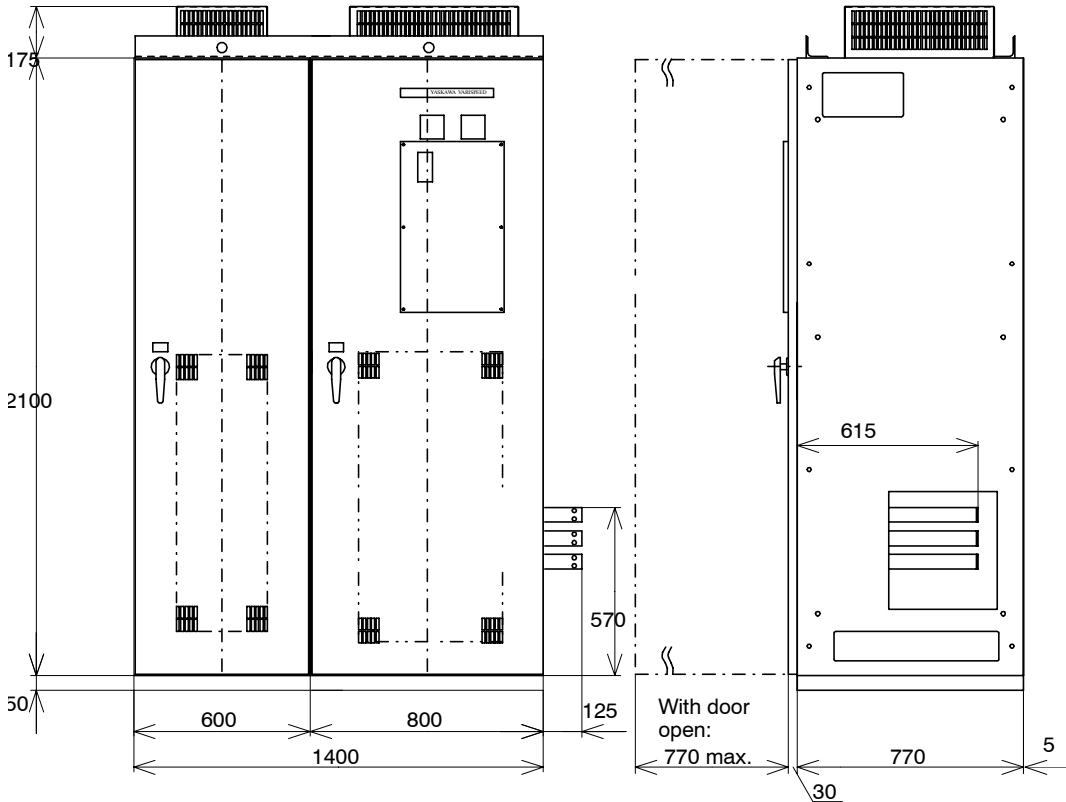

2

Generated loss (W)	CIMR-G5A□	4400	5600
	Converter Module		2060
Inverter Module		6860	8820
Control Unit		50	50
Discharge Resistor		120	200
Control Power Transformer		80	80
DC Reactor		370	370
Coupling Reactor		1480	1480
	Total	11020	13060

■ 400-V Class (600 kW) and 575-V Class (900 kW) Inverter Panels

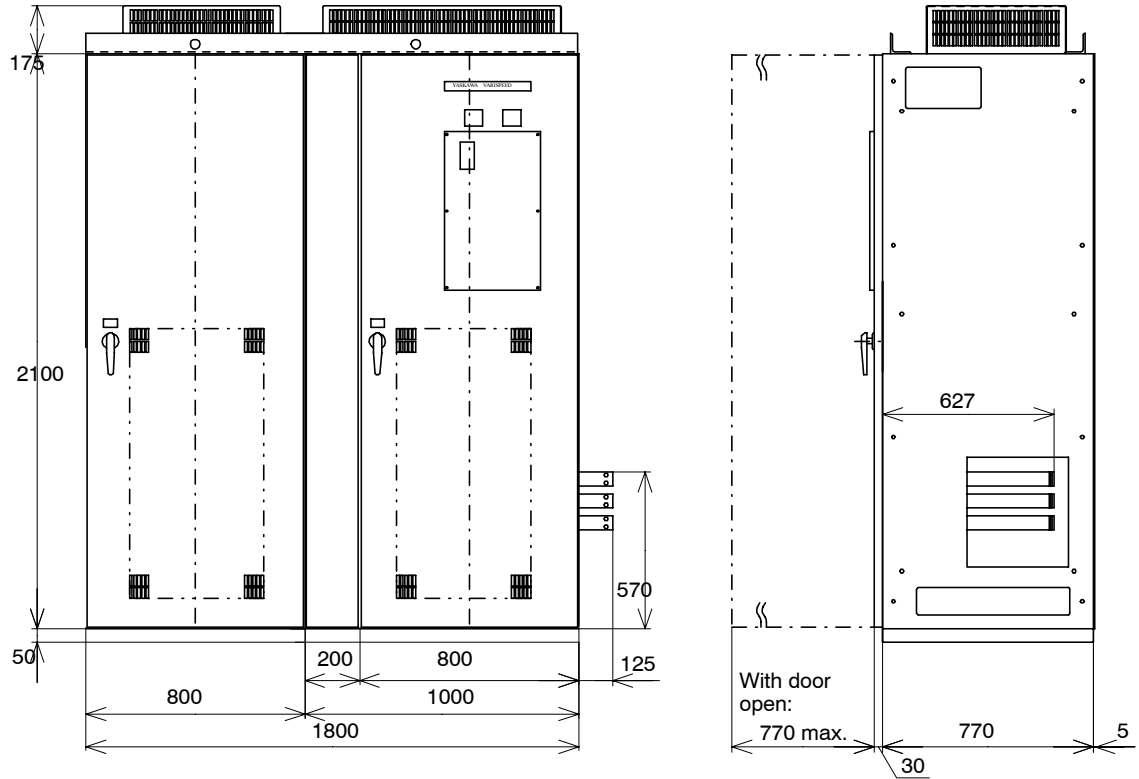

2

Generated loss (W)	CIMR-G5A□	4600	5900
	Converter Module		3090
Inverter Module		10290	13230
Control Unit		50	50
Discharge Resistor		180	300
Control Power Transformer		80	80
DC Reactor		700	700
Coupling Reactor		2220	2220
Total		16610	19670

■ 400-V Class (800 kW) and 575-V Class (1200 kW) Inverter Panels

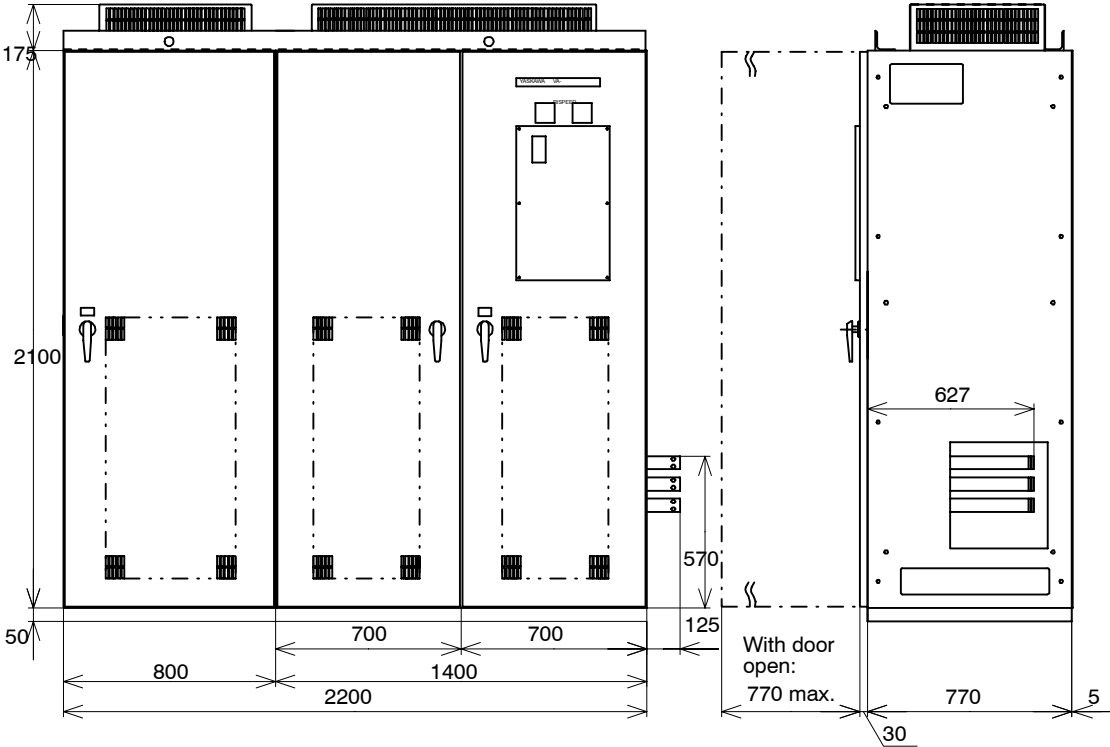

2

Generated loss (W)	CIMR-G5A□	4800	512C
	Converter Module		4120
Inverter Module		13720	17640
Control Unit		50	50
Discharge Resistor		240	400
Control Power Transformer		80	80
DC Reactor		740	740
Coupling Reactor		2960	2960
	Total	21910	25990

2.5 Checking and Controlling the Installation Site

Install the VS-616G5 in the installation site described below and maintain optimum conditions.

2.5.1 Installation Site

Install the Inverter Panel under the following conditions.

- Install the Inverter Panel at an altitude of 1,000 m or less.
- Install the Inverter Panel in a location with an ambient temperature ranging from -5 to 40 °C.
 - Do not expose the Inverter Panel to hot air currents.
 - Install the Inverter Panel in a well-ventilated location. If the Inverter Panel is located in a poorly ventilated location, ambient temperature will rise due to the Inverter panel or other heat sources.
- Install the Inverter Panel in a location free from harmful gasses or sea wind that may cause rust or corrosion.
- Install the Inverter Panel in a location free from dripping water or condensation. Observe the following precautions when installing the Inverter Panel indoors.
 - The building roof made of metal or glass may cause water condensation to drip on the Inverter Panel.
 - Water leakage from water pipes may drip on the Inverter Panel.
 - When installing the Inverter Panel in a concrete room, particularly in building underground, where concrete tends to keep moisture, the Inverter Panel may be affected by moisture. In such case, provide a space heater inside the Inverter Panel to constantly keep the in-panel temperature higher than the ambient temperature.
- Install the Inverter Panel in a clean location free from dust. Otherwise, contacts may malfunction or insulation destruction may occur.
- Install the Inverter Panel in a location free from excessive vibration or shock.
- Install the Inverter Panel in a location free from explosive or combustible gases.
- Install the Inverter Panel in a location where openings are provided for cleaning, inspection, and maintenance. (The Fire Protection Law specifies minimum openings in the front and back sides of the Inverter Panel.)

2.5.2 Controlling the Ambient Temperature

To enhance the reliability of operation, the Inverter Panel should be installed in an environment free from extreme temperature increases. If the Inverter Panel is installed in an enclosed environment, such as a box, use a cooling fan or air conditioner to maintain the internal air temperature below 40°C.

2.5.3 Protecting the Inverter Panel from Foreign Matter

Place a cover over the Inverter Panel during installation to shield it from metal powder produced by drilling.

Always remove the cover from the Inverter Panel after completing installation. Otherwise, ventilation will be reduced, causing the Inverter Panel to overheat.

2.5.4 Floor Level

The floor where the Inverter Panel is installed must be level to within ± 3 mm per square meter.

2.5.5 Inverter Panel Connections (Side-by-side Connection)

When connecting more than one Inverter Panel in a series, use connection bolts.

Tighten the four bolts along both the front side and back side. Tighten them carefully so that the front surfaces of each Inverter Panels are aligned with each other and so that all the connected Inverter Panels remain stable.

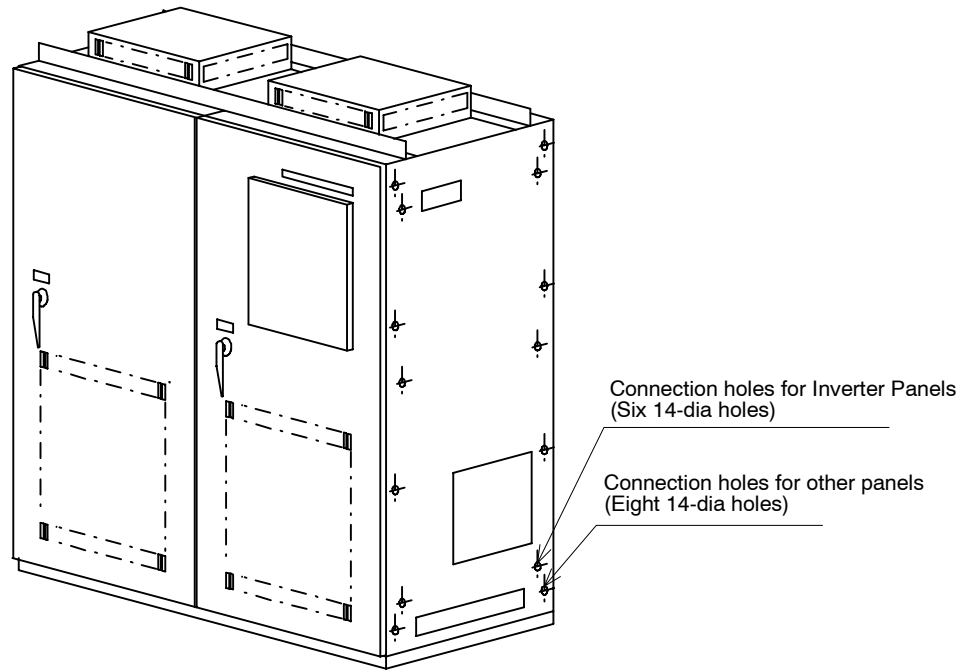

Fig 2.5 Inverter Panel Side-by-side Connection

The method for connecting Inverter Panels Side-by-side is different from the method for connecting an Inverter Panel with other panels.

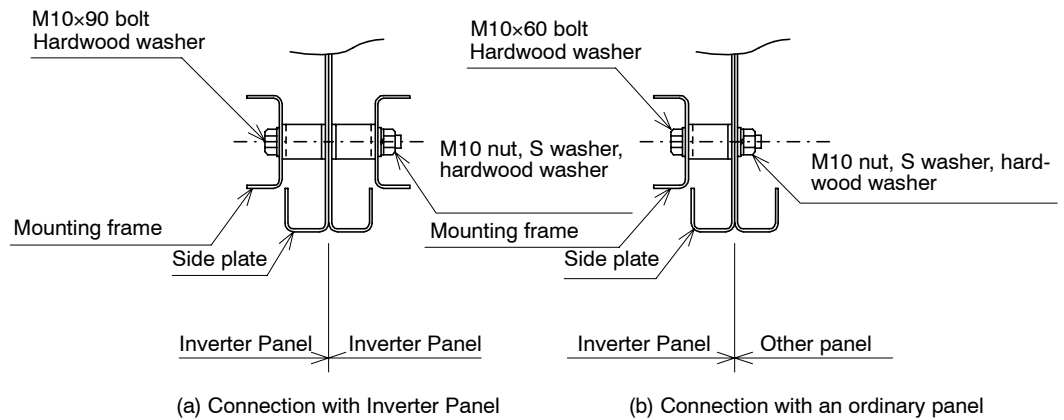

Fig 2.6 Side-by-side Connection Joint

2.5.6 Tightening Anchor Bolts

When the installation work described in 2.5.5, above, has been completed, secure the Inverter Panel with four anchor bolts. Perform the foundation work according to the external dimensions drawings provided by Yaskawa.

Handling Inverters

2.5.6 Tightening Anchor Bolts

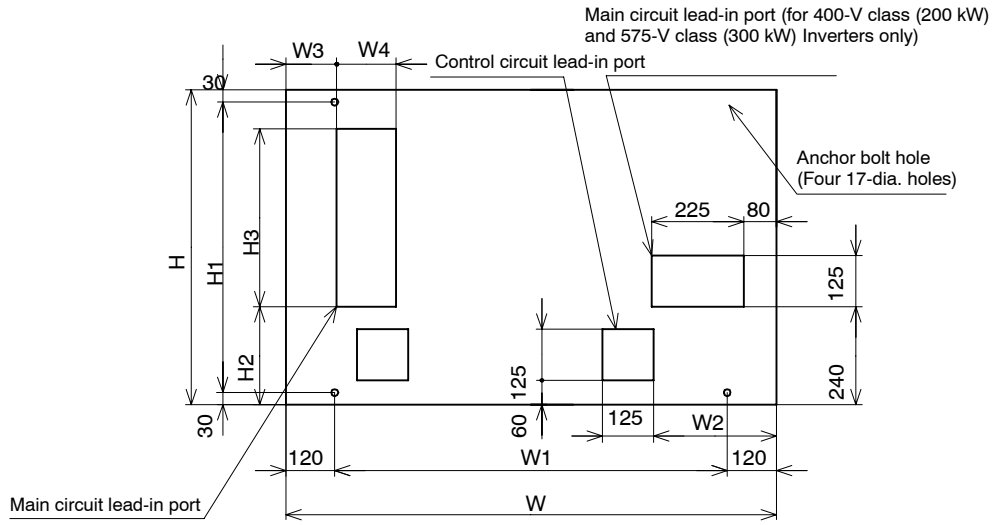

Fig 2.7 Tightening Anchor Bolts

Maximum motor capacity	W	W1	W2	W3	W4	H	H1	H2	H3
400 V, 200 kW 575 V, 300 kW	1200	960	300	125	145	770	710	240	435
400 V, 400 kW 575 V, 600 kW	1400	1160	500	125	125				
400 V, 600 kW 575 V, 900 kW	1800	1560	700	125	165				
400 V, 800 kW 575 V, 1200 kW	2400	1960	1100	115	160			95	580

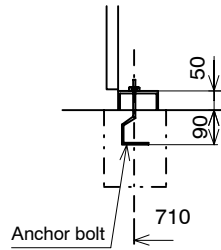

Fig 2.8 Details of Anchor Bolts

2

2.6 Installation Orientation and Space

Install the Inverter Panel so as not to reduce cooling effects. When installing the Inverter Panel, always provide the following installation space to allow normal heat dissipation.

■ 400-V Class (200 kW, 400 kW, 600 kW, and 800 kW) and 575-V Class (300 kW, 600 kW, 900 kW, and 1200 kW) Inverters

The following example shows examples for the 400-V class (400 kW) and 575-V class (600 kW) Inverters.

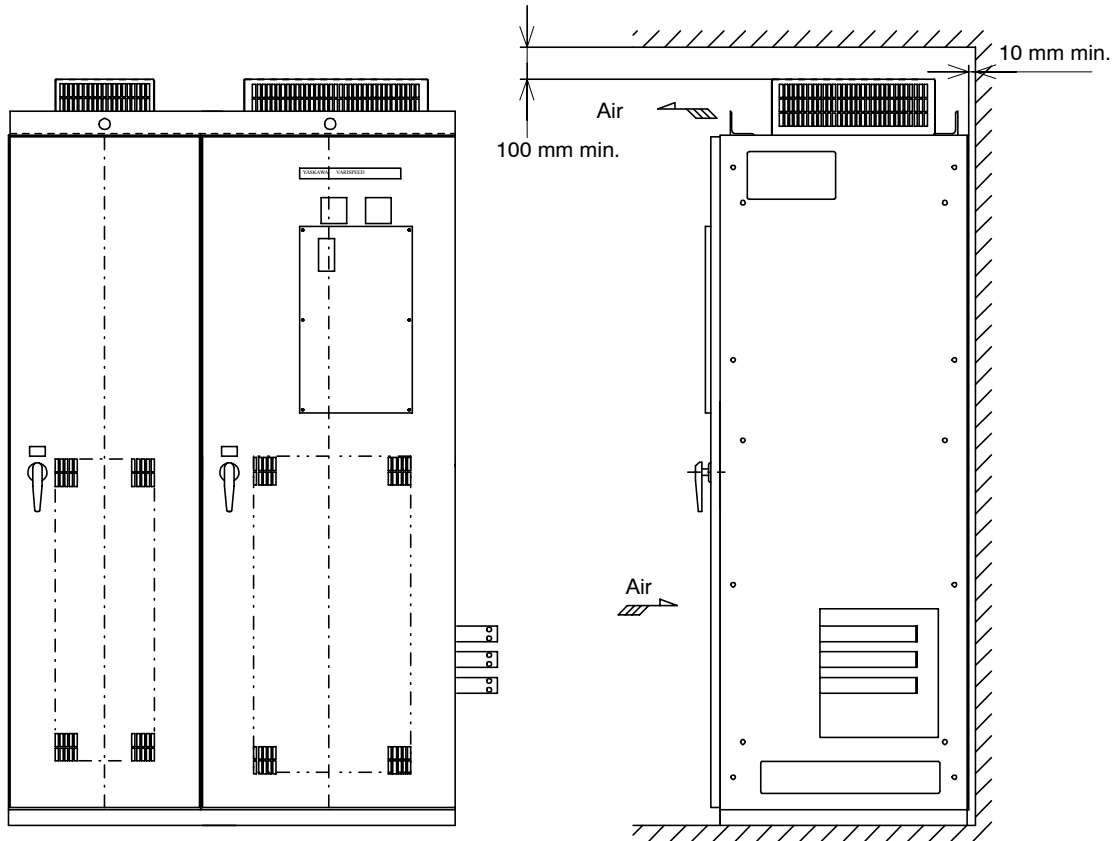

Fig 2.9 Installation Orientation and Space for VS-616G5 Inverters

2.7 Removing/Attaching the Digital Operator

Remove or attach the Digital Operator using the following procedure.

■ Removing the Digital Operator

Press the lever on the side of the Digital Operator in the direction of arrow 1 to unlock the Digital Operator, and lift the Digital Operator in the direction of arrow 2 to remove the Digital Operator as shown in the following illustration.

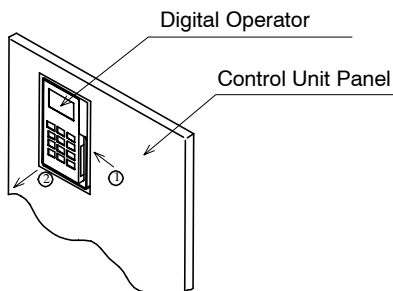

Fig 2.10 Removing the Digital Operator

■ Mounting the Digital Operator

1. Hook the Digital Operator at A (two locations) in the direction of arrow 1 as shown in the following illustration.
2. Press the Digital Operator in the direction of arrow 2 until it snaps in place at B (two locations).

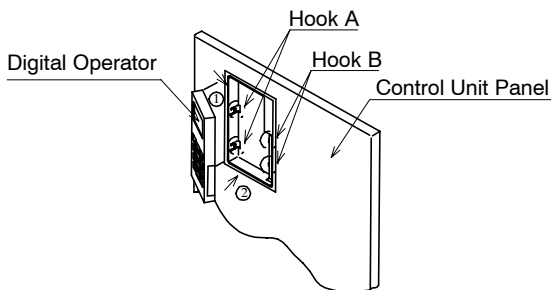

Fig 2.11 Mounting the Digital Operator

IMPORTANT

Do not remove or attach the Digital Operator using methods other than those described above, otherwise the Inverter Panel may break or malfunction due to imperfect contact.

3

Wiring

This chapter describes wiring terminals, main circuit terminal connections, main circuit terminal wiring specifications, control circuit terminals, and control circuit wiring specifications.

3.1	Connection Diagram	3 - 3
3.2	Terminal Positions	3 - 5
3.3	Cable Sizes	3 - 7
3.4	Wiring Main Circuit Terminals	3 - 9
3.4.1	Main Circuit Terminal Functions	3 - 9
3.4.2	Main Circuit Configurations	3 - 10
3.4.3	Precautions for Wiring Main Circuit Power Input	3 - 10
3.5	Wiring Control Circuit Terminals	3 - 12
3.5.1	Control Circuit Terminal Functions	3 - 12
3.6	Wiring Check	3 - 13
3.7	Installing and Wiring PG Speed Control Cards	3 - 14
3.7.1	Installing a PG Speed Control Card	3 - 14
3.7.2	PG Speed Control Card Terminal Blocks	3 - 15
3.7.3	Wiring a PG Speed Control Card	3 - 17
3.7.4	Wiring PG Speed Control Card Terminal Blocks	3 - 22
3.7.5	Selecting the Number of PG (Encoder) Pulses	3 - 25
3.8	Grounding	3 - 27
3.8.1	Connection of Ground Bus Bar	3 - 27
3.8.2	Connection of Ground Cable for Control Signals	3 - 27

 **WARNING**

- Always turn OFF the input power supply before wiring terminals.
Otherwise, an electric shock or fire can occur.
- Wiring must be performed by an authorized person qualified in electrical work.
Otherwise, an electric shock or fire can occur.
- Be sure to ground the ground terminal.
(400 V Class and 575 V Class Inverters: Ground to 10 Ω or less)
Otherwise, an electric shock or fire can occur.
- Always check the operation of any emergency stop circuits after they are wired.
Otherwise, there is the possibility of injury. (Wiring is the responsibility of the user.)
- Never touch the output terminals directly with your hands or allow the output lines to come into contact with the Inverter Panel case. Never short the output circuits.
Otherwise, electrical shock or grounding can occur.

 **CAUTION**

- Check to be sure that the voltage of the main AC power supply satisfies the rated voltage of the Inverter Panel.
Injury or fire can occur if the voltage is not correct.
- Do not perform voltage withstand tests on the Inverter Panel.
Voltage withstand test can damage semiconductor elements and other components.
- Connect Braking Resistor Units and Braking Units as shown in the I/O wiring examples.
Otherwise, a fire can occur.
- Tighten all terminal screws to the specified tightening torque.
Otherwise, a fire may occur.
- Do not connect AC power to output terminals U, V, and W.
The interior parts of the Inverter Module will be damaged if voltage is applied to the output terminals.
- Do not connect phase-advancing capacitors or LC/RC noise filters to the output circuits.
The internal Inverter Panel will be damaged if voltage is applied to the output terminals.
- Do not connect electromagnetic switches or contactors to the output circuits.
If a load is connected while the Inverter Panel is operating, surge current will cause the overcurrent protection circuit to operate.

3.1 Connection Diagram

The connection diagram of the VS-616G5 is shown in *Figure 3.1*.

When using the Digital Operator, the motor can be operated by wiring only the main circuits.

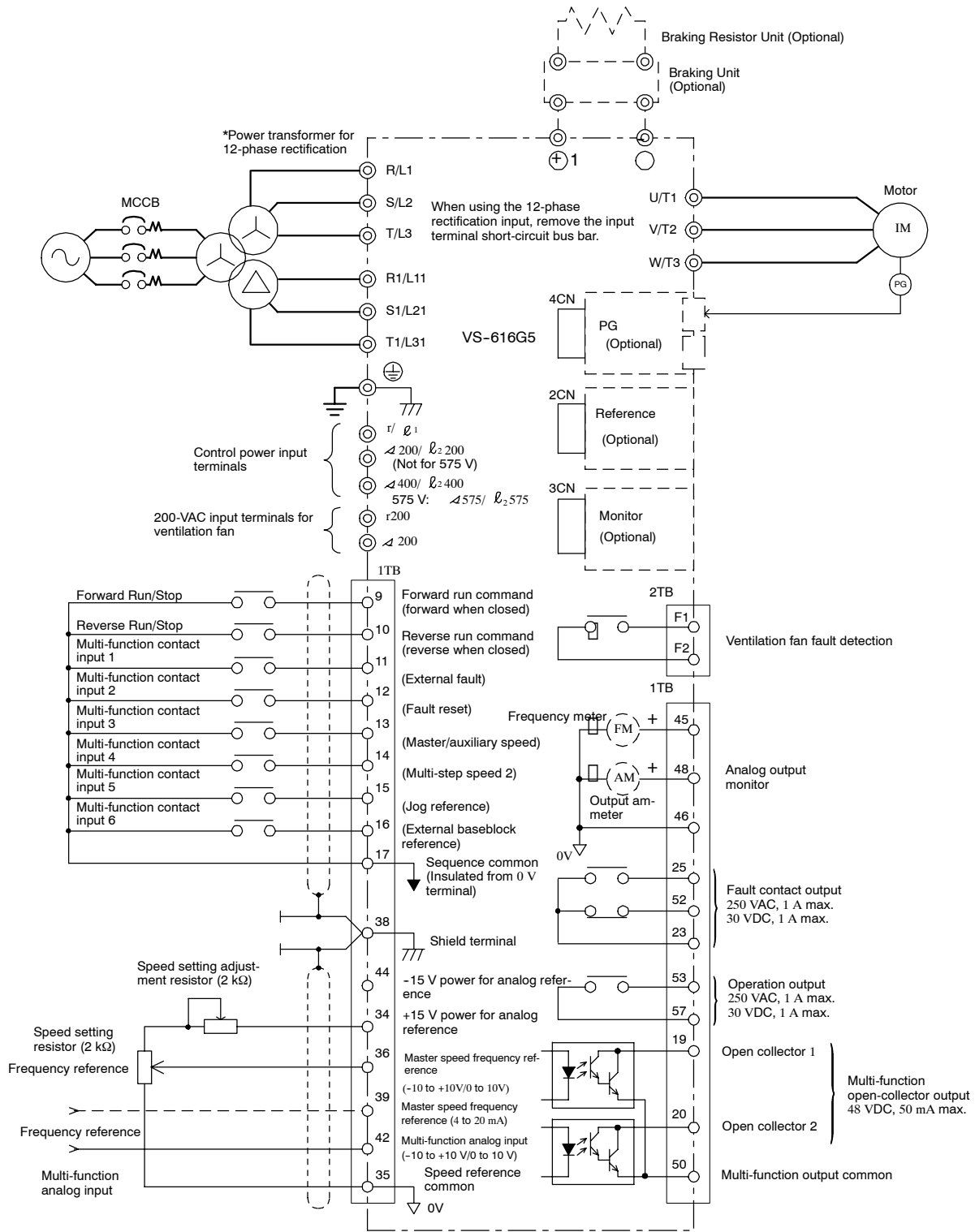

- Note**
- (1) Double circles indicate main circuit terminals and single circles indicate control circuit terminals.
 - (2) When using the 12-phase rectification, the user must prepare the transformer.

Fig 3.1 Connection Diagram (Model CIMR-G5A4200 Shown Above)

3.2 Terminal Positions

■ 400-V Class (200 kW) and 575-V Class (300 kW) Inverters

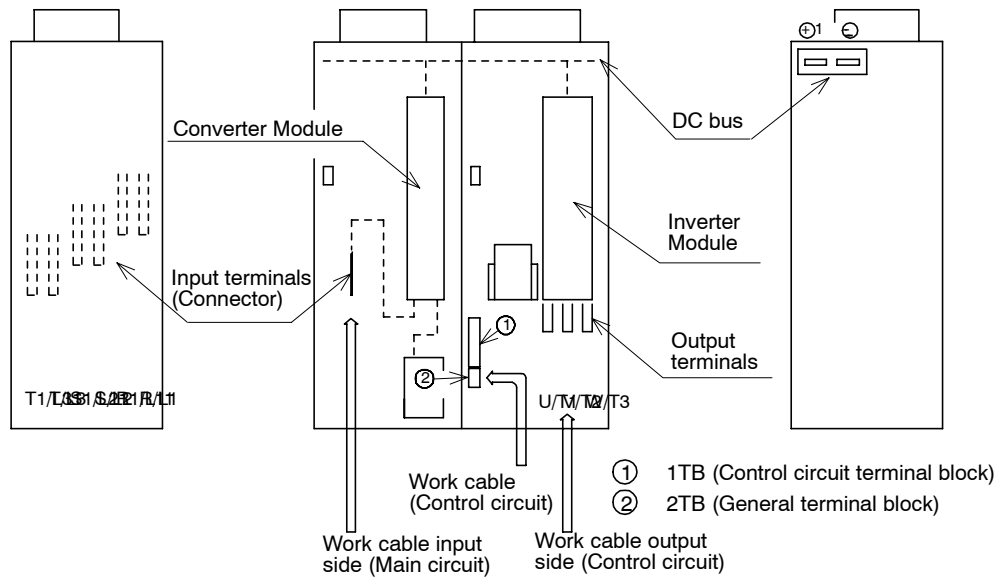

Connection cable: 325 mm² max.) (600-V CV cable, etc.) Connection cable: 325 mm² max.) (600 V CV cable, etc.)

Note The main circuit terminals on the output side are provided as bus bar terminals on the side surface. Connections are normally made to the output terminal block on the right side.

■ **400-V Class (400 kW, 600 kW, 800 kW) and 575-V Class (600 kW, 900 kW, 1200 kW) Inverters**

The following illustration is for 400-V class (400 kW) and 575-V class (600 kW) Inverters.

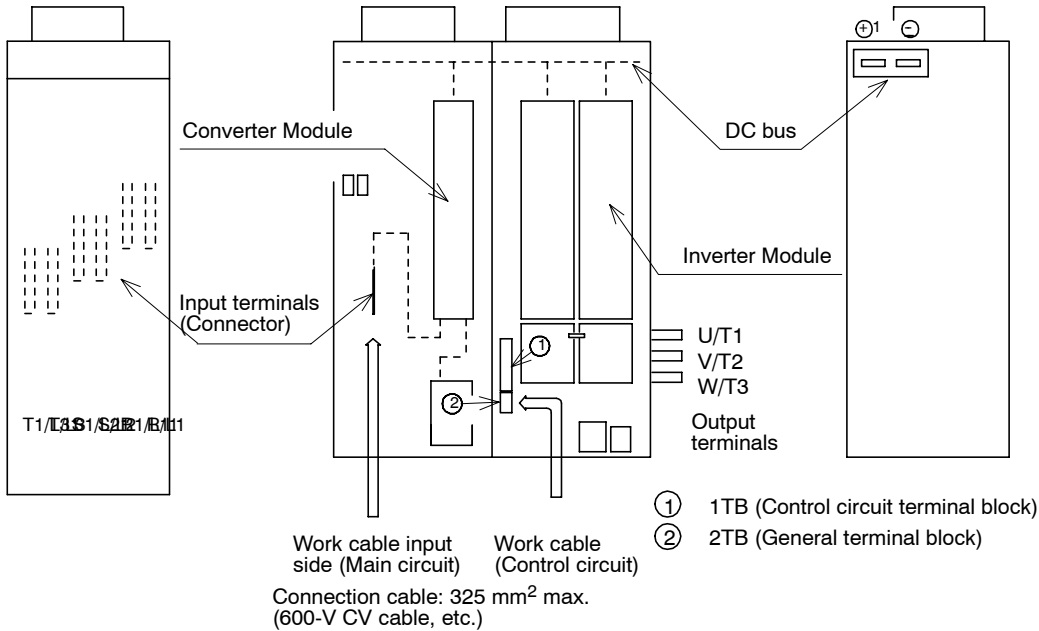

Note The main circuit terminals on the output side are provided as bus bar terminals on the side surface. Connections are normally made to the output terminal block on the right side.

3

3.3 Cable Sizes

■ Connection Cables

1TB (Control Circuit Terminal Block)

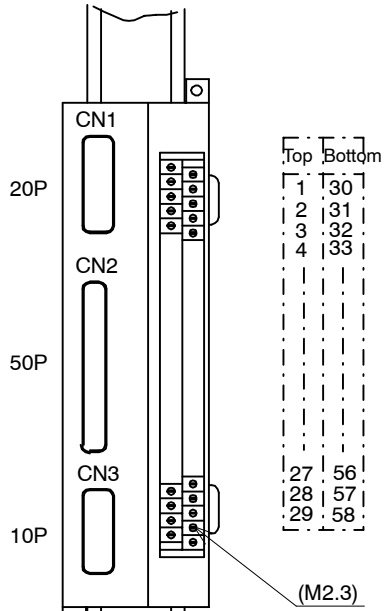

PS5D-INV-LA
Connection Cable Specifications

Applicable cable: 2 mm² max.
Charge current: 0.5 mA
End treatment: 7 mm

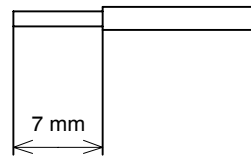

2TB (General Terminal Block)

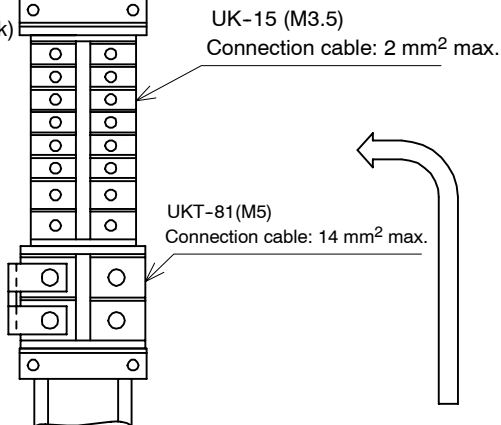

Fig 3.2 Connection Cables

■ Transmission Cables

When the Inverter Panels is designed to be applicable to transmission connection, the Inverter Panel is provided with transmission junction terminals.

Connect the transmission cables directly to the transmission junction terminals on the input side and output side.

Treat the transmission cables as low-current cables and separate them from high-power lines.

Terminal Block Arrangement

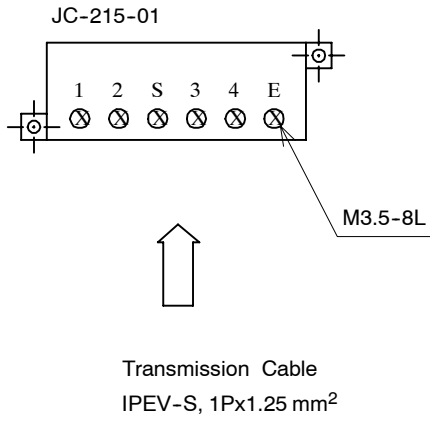

Fig 3.3 **Transmission Cable**

3

3.4 Wiring Main Circuit Terminals

3.4.1 Main Circuit Terminal Functions

Main circuit terminal functions are summarized according to terminal symbols in *Table 3.1*. Wire the terminals correctly for the desired purposes.

Table 3.1 Main Circuit Terminal Functions

Voltage Class	400-V Class	575-V Class
CIMR-G5A□	4200 to 4800	5300 to 512C
R/L1	Main Circuit Power Inputs (At the time of shipment, short-circuit bus bars are connected between R/L1 and R1/L11, S/L2 and S1/L21, and between T/L3 and T1/L31. Remove these short-circuit bus bars when applying 12-phase rectification.)	
S/L2		
T/L3		
R1/L11		
S1/L21		
T1/L31		
U/T1	Inverter Outputs	
V/T2		
W/T3		
⊕1	For connecting the Braking Unit	
⊖		
↙ 200/ℓ ₂ 200	Control Power Inputs (For Module fan power input)	-
↙ 400/ℓ ₂ 400		Control Power Inputs (For Module fan power input)
r/ℓ ₁		
↙ 575/ℓ ₂ 575	-	
r200	Power input to the Inverter Panel ventilation fan	
↙ 200		
⊕	Ground	

3.4.2 Main Circuit Configurations

The main circuit configuration of the CIMR-G5A4800 is shown below.

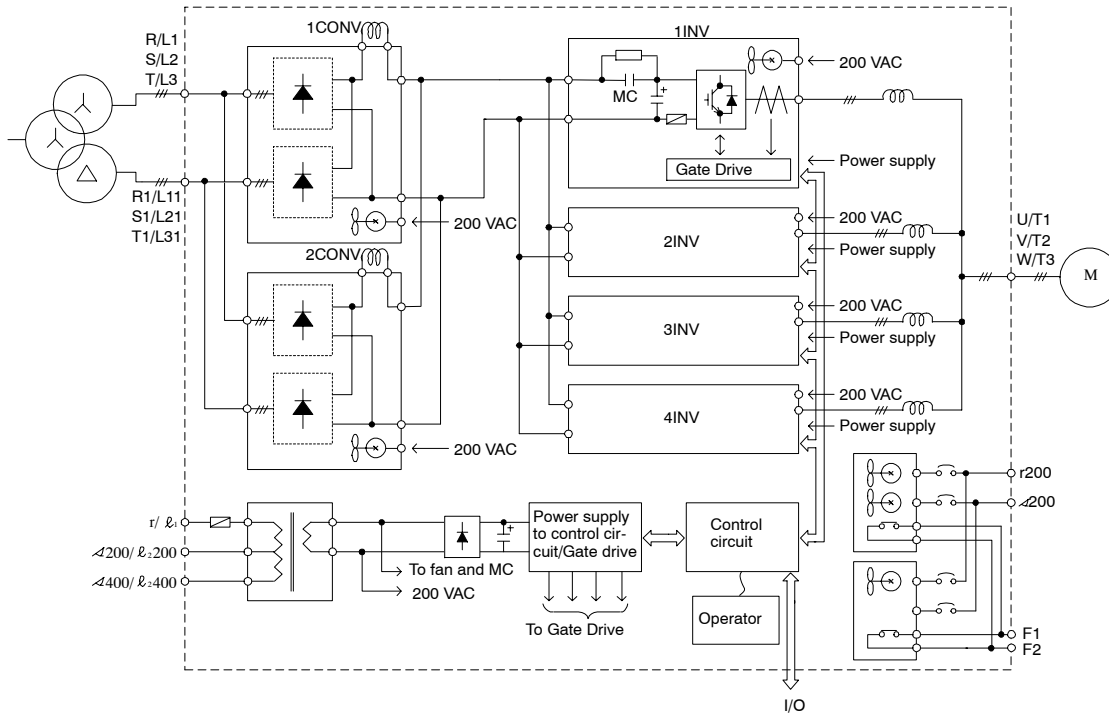

Fig 3.4 Main Circuit Configuration (CIMR-G5A4800)

3.4.3 Precautions for Wiring Main Circuit Power Input

At the time of shipment, short-circuit bus bars are provided between R/L1 and R1/L11, S/L2 and S1/L21, and between T/L3 and T1/L31 on the main circuit power input terminal. Remove these short-circuit bus bars when applying 12-phase rectification.

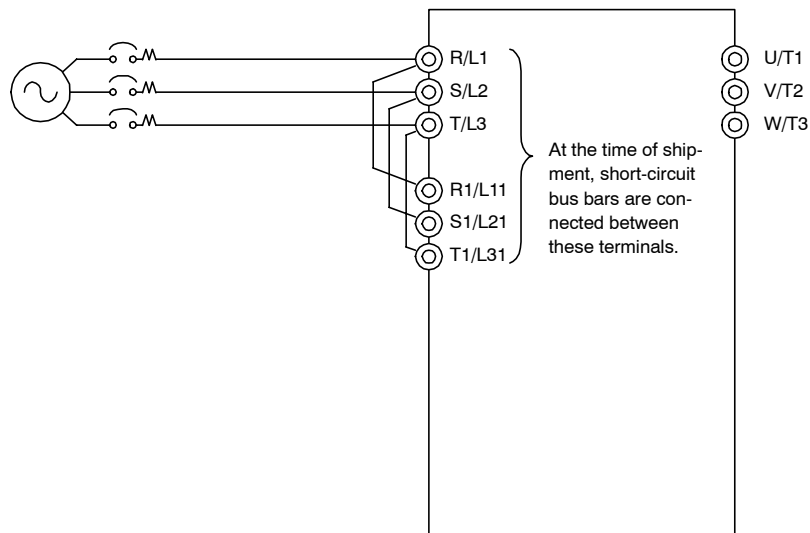

Fig 3.5 Short-circuit Bus Bar Connections

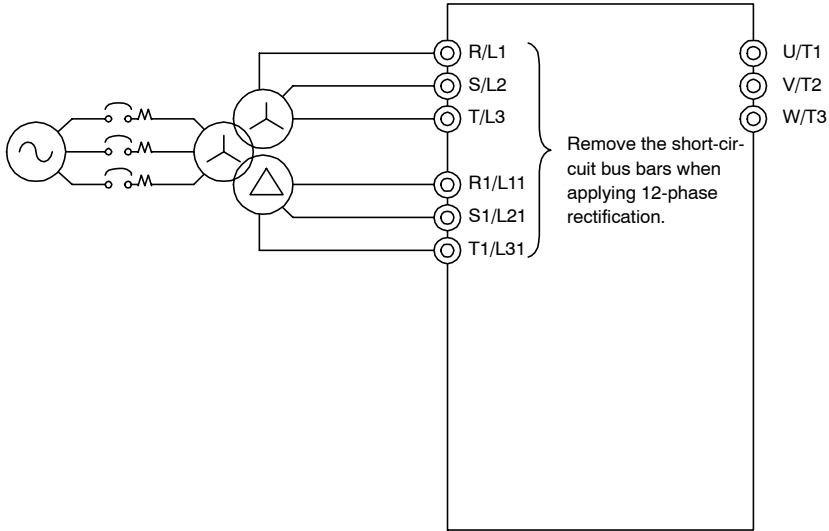

Fig 3.6 Wiring when Applying 12-phase Rectification

3.5 Wiring Control Circuit Terminals

3.5.1 Control Circuit Terminal Functions

The functions of the control circuit terminals are shown in *Table 3.2*. Use the appropriate terminals for the correct purposes.

Table 3.2 Control Circuit Terminals

External Terminal Code	Control PCB Terminal Code		Type	Signal Name	Function	Signal Level		
1TB	9	9CN	17	Forward run/stop command	Forward run when CLOSED; stopped when OPEN.	24 VDC, 8 mA Photocoupler isolation		
	10			18	Reverse run/stop command		Reverse run when CLOSED; stopped when OPEN.	
	11			19	External fault input		Fault when CLOSED; normal when OPEN.	Multi-function contact inputs (Command signals can be selected by setting H1-01 to H1-06.)
	12			20	Fault reset		Reset when CLOSED	
	13			21	Main/auxiliary switch		Auxiliary frequency reference when CLOSED.	
	14			22	Multi-step speed reference 2		Multi-step setting 2 when CLOSED.	
	15			23	Jog frequency reference		Jog run when CLOSED.	
	16			24	External baseblock		Inverter output stopped when CLOSED.	
	17			25	Sequence input common		-	
	34			1	Analog input signals		15 V power output	
44	10	-15 V power output	-15 V power supply for analog references	-15 V (Max. current: 20 mA)				
36	4	Master speed frequency reference	-10 to 10 V/-100% to 100%	-10 to +10 V (20 kΩ)				
39	6		0 to 10 V/0 to 100%	0 to 10 V (20 kΩ)				
42	8	Multi-function analog input	4 to 20 mA/0 to 100%	4 to 20 mA (250Ω)				
35	3		-10 to +10V/-100% to +100% 0 to 10V/0 to 100%	-10 to +10 V (20 kΩ)				
52	TB2	2	Fault output signal (Single-pole, double-throw contact)	Terminals 23 and 52 become open when output signal is faulty.		Dry contacts Contact capacity: 1 A max. at 250 VAC 1 A max. at 30 VDC		
25				3	Terminals 23 and 25 become closed when output signal is faulty.			
23			1	Running signal (1NO contact)	Operating when CLOSED.		Multi-function outputs	
53			4					
57			5					
19	10CN	10	Sequence output signals	Zero speed detection	Open-collector output 50 mA max. at 48 V*			
20				12		Speed agree detection	Within ±2 Hz of set frequency when CLOSED.	
50				18		Open-collector output common	-	
45	-	-	Shield strip connection	Frequency output	0 to 10 V/100% frequency	Multi-function analog monitor 1 (H4-01, H4-02)		
48				4	Current monitor		5 V/Inverter rated current	Multi-function analog monitor 2 (H4-04,H4-05)
46				3	Analog output common		-	
29	-	-	Shield strip connection	For shield connection				
38	-	-						
41	-	-						
47	-	-						
51	-	-						
58	-	-						

3

2TB	F1	-	-	Fan detection	For detecting faulty Inverter Panel ventilation fan	Detects faulty fan when the power supply to the fan is turned ON or the F1 and F2 terminals become closed when the power supply to the fan is turned OFF.	Dry contacts Contact capacity: 1 A max. at 250 VAC 1 A max. at 30 VDC
	F2	-	-				

* When driving an L load, such as a relay coil, always insert a flywheel diode as shown in *Figure 3.7*.

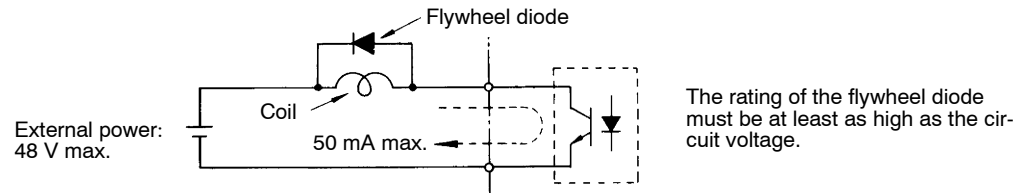

Fig 3.7 Flywheel Diode Connection

3.6 Wiring Check

Check all wiring after wiring has been completed. Do not perform a buzzer check on control circuits.

- Is all wiring correct?
- Have any wire clippings, screws, or other foreign material been left?
- Are all screws tight?
- Are any wire ends contacting other terminals?

3.7 Installing and Wiring PG Speed Control Cards

PG Speed Control Cards are used for executing speed control using a pulse generator (PG). There are four types of PG speed control, as shown below. Select the type that fits the application and control method.

PG-A2	A-phase (single) pulse input for open collector output or complementary outputs, for V/f control
PG-B2	A/B-phase pulse input for open collector output or complementary outputs, for vector control
PG-D2	A-phase (single) pulse input for line driver input, for V/f control
PG-X2	A/B/Z-phase pulse input for line driver input, for vector control

3.7.1 Installing a PG Speed Control Card

Use the following procedure to install a PG Speed Control Card.

1. Turn OFF the main-circuit power supply of the Inverter Panel.
2. Leave it OFF for at least five minutes before opening the front door of the Inverter Panel. Check to be sure that the CHARGE lamp is OFF.
3. After aligning to the Option-A connector on the control PCB located on the back of the front panel of the Inverter Panel, pass the spacer through the spacer hole at the Card. (Refer to A in the illustration.) Check to be sure that it is precisely aligned with the 4CN position, and snap it into the proper position. Be sure to press it in firmly until you hear it snap into place.

3

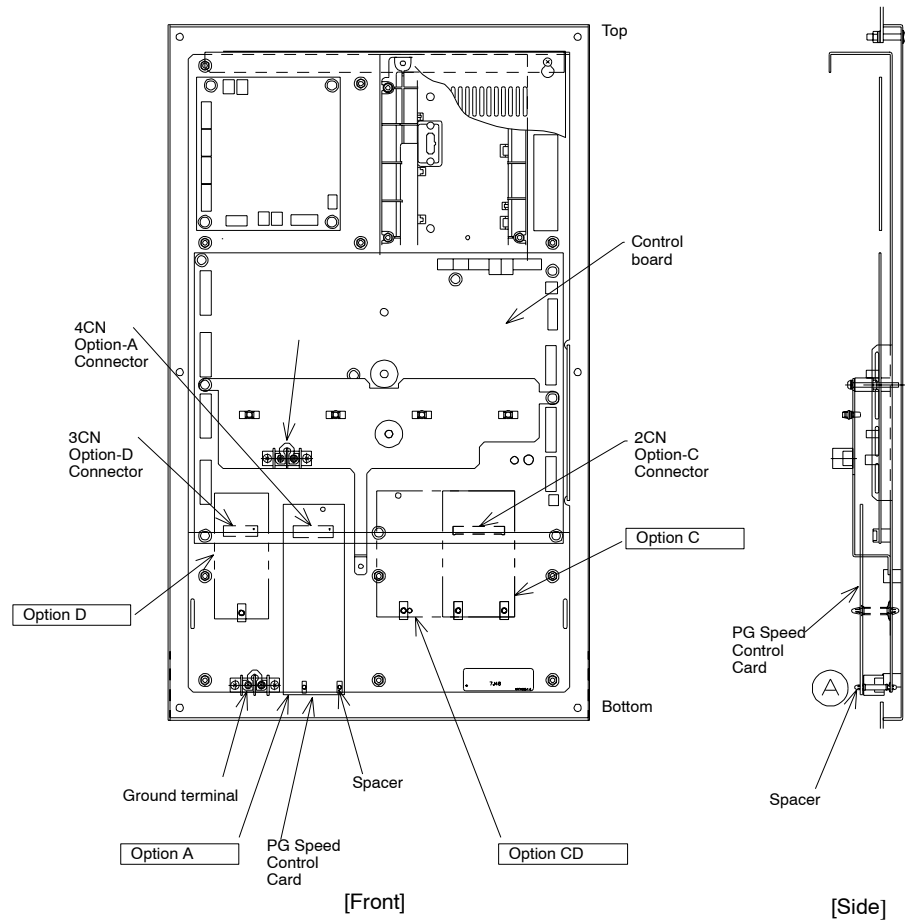

Fig 3.8 Installing a PG Speed Control Card

3.7.2 PG Speed Control Card Terminal Blocks

The terminal specifications for each PG Speed Control Card are given in the following tables.

■ PG-A2 (For V/f with PG Feedback Mode Only)

Table 3.3 PG-A2 Terminal Specifications

Terminal	No.	Contents	Specifications
TA1	1	Power supply for pulse generator	12 VDC ($\pm 5\%$), 200 mA max.
	2		0 VDC (GND for power supply)
	3	+12 V/open collector switching terminal	Terminal for switching between 12 V voltage input and open collector input. For open collector input, short across 3 and 4.
	4		
	5	Pulse input terminal	H: +4 to 12 V; L: +1 V max. (Maximum response frequency: 30 kHz)
	6		Pulse input common
	7	Pulse motor output terminal	12 VDC (+10%), 20 mA max.
	8		Pulse monitor output common
TA2	(E)	Shield connection terminal	-

■ PG-B2 (For Flux Vector Control Mode Only)

Table 3.4 PG-B2 Terminal Specifications

Terminal	No.	Contents	Specifications
TA1	1	Power supply for pulse generator	12 VDC ($\pm 5\%$), 200 mA max.
	2		0 VDC (GND for power supply)
	3	A-phase pulse input terminal	H: +8 to 12 V L: +1 V max. (Maximum response frequency: 30 kHz)
	4		Pulse input common
	5	B-phase pulse input terminal	H: +8 to 12 V L: +1 V max. (Maximum response frequency: 30 kHz)
	6		Pulse input common
TA2	1	A-phase monitor output terminal	Open collector output, 24 VDC, 30 mA max.
	2		A-phase monitor output common
	3	B-phase monitor output terminal	Open collector output, 24 VDC, 30 mA max.
	4		B-phase monitor output common
TA3	(E)	Shield connection terminal	-

■ PG-D2 (For V/f with PG Feedback Mode Only)

Table 3.5 PG-D2 Terminal Specifications

Terminal	No.	Contents	Specifications
TA1	1	Power supply for pulse generator	12 VDC ($\pm 5\%$), 200 mA max. (see note)
	2		0 VDC (GND for power supply)
	3		5 VDC ($\pm 5\%$), 200 mA max. (see note)
	4	Pulse input + terminal	Line driver input (RS-422 level input) Maximum response frequency: 300 kHz
	5	Pulse input - terminal	
	6	Common terminal	-
	7	Pulse monitor output + terminal	Line driver output (RS-422 level output)
	8	Pulse monitor output - terminal	
TA2	(E)	Shield connection terminal	-

Note 5 VDC and 12 VDC cannot be used at the same time.

■ **PG-X2 (For Flux Vector Control Mode Only)**

Table 3.6 PG-X2 Terminal Specifications

Terminal	No.	Contents	Specifications
TA1	1	Power supply for pulse generator	12 VDC ($\pm 5\%$), 200 mA max. (see note)
	2		0 VDC (GND for power supply)
	3		5 VDC ($\pm 5\%$), 200 mA max. (see note)
	4	A-phase + input terminal	Line driver input (RS-422 level input) Maximum response frequency: 300 kHz
	5	A-phase - input terminal	
	6	B-phase + input terminal	
	7	B-phase - input terminal	
	8	Z-phase + input terminal	
	9	Z-phase - input terminal	
	10	Common terminal	0 VDC (GND for power supply)
TA2	1	A-phase + output terminal	Line driver output (RS-422 level output)
	2	A-phase - output terminal	
	3	B-phase + output terminal	
	4	B-phase - output terminal	
	5	Z-phase + output terminal	
	6	Z-phase - output terminal	
	7	Control circuit common	Control circuit GND
TA3	(E)	Shield connection terminal	-

Note 5 VDC and 12 VDC cannot be used at the same time.

3.7.3 Wiring a PG Speed Control Card

Wiring examples are provided in the following illustrations for the PG Speed Control Cards.

■ PG-A2 (For V/f with PG Feedback Mode Only)

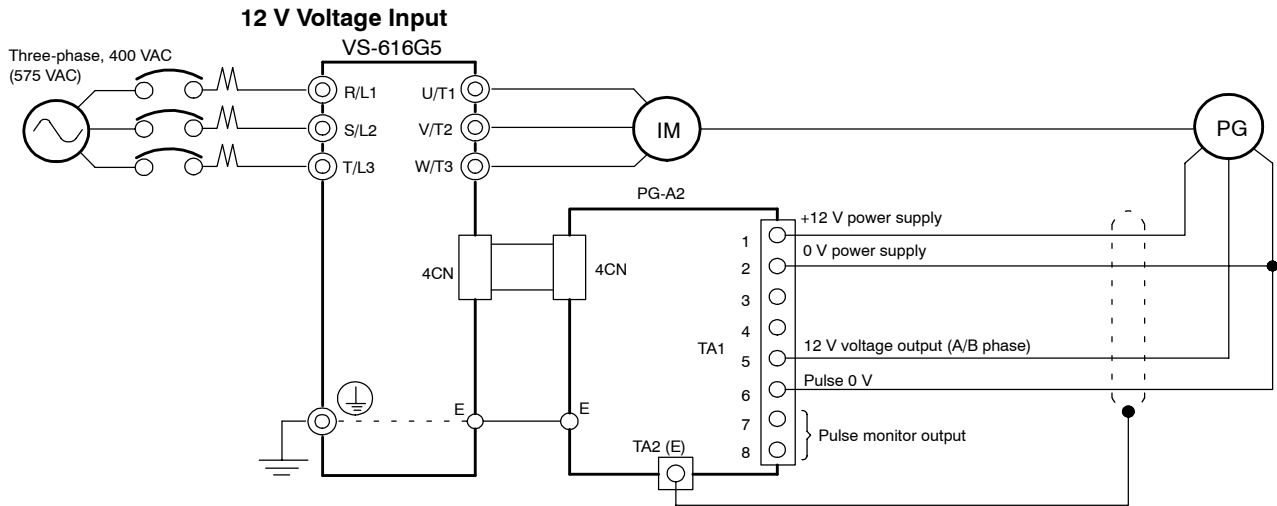
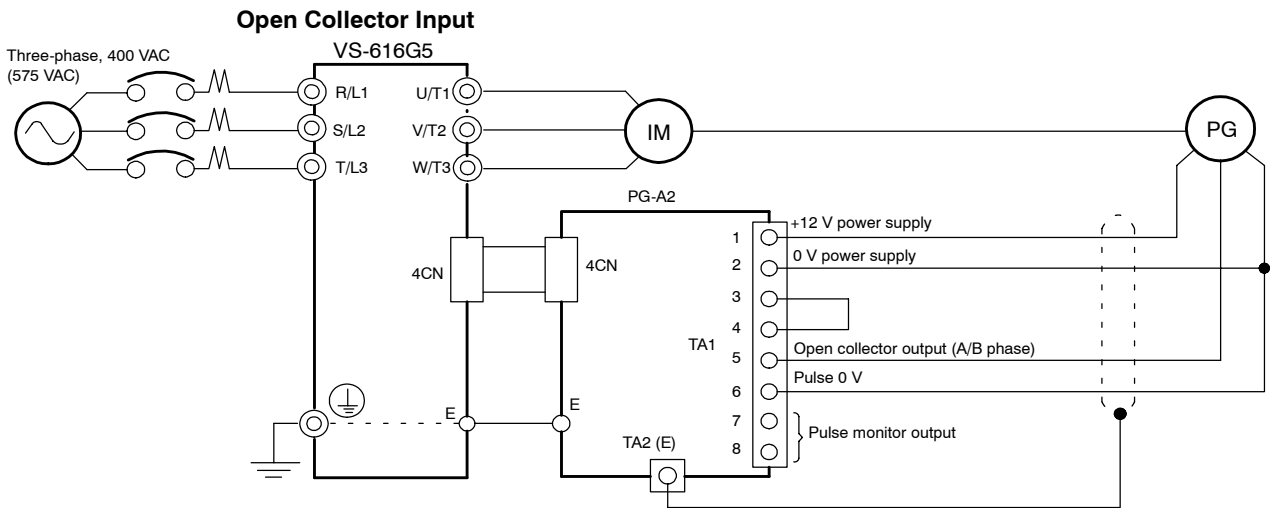

Fig 3.9 Wiring a 12 V Voltage Input



- Shielded twisted-pair wires must be used for signal lines.
- Do not use the pulse generator's power supply for anything other than the pulse generator (encoder). Using it for another purpose can cause malfunctions due to noise.
- The length of the pulse generator's wiring must not be more than 100 meters.

Fig 3.10 Wiring an Open-collector Input

3.7.3 Wiring a PG Speed Control Card

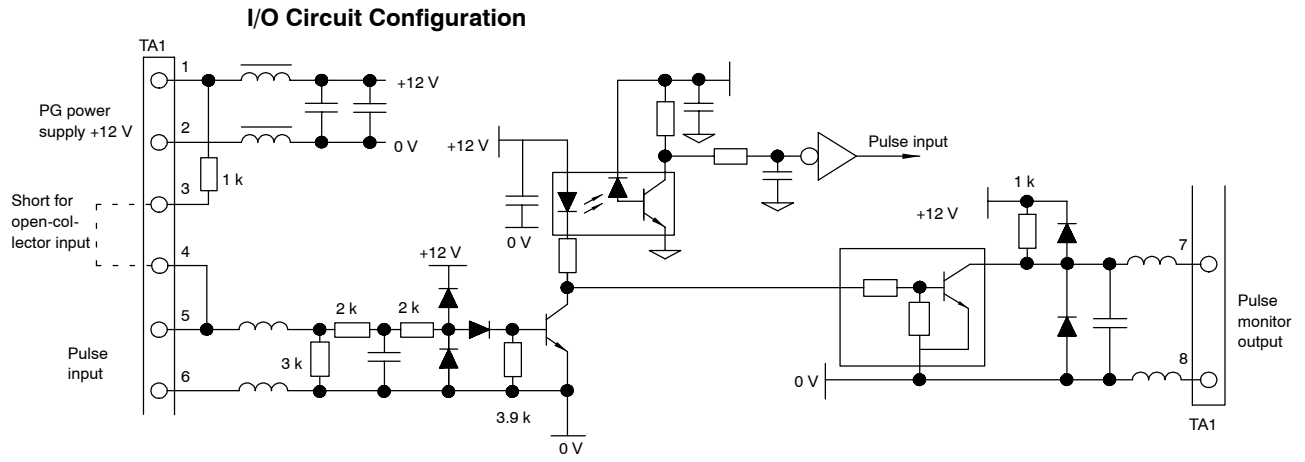
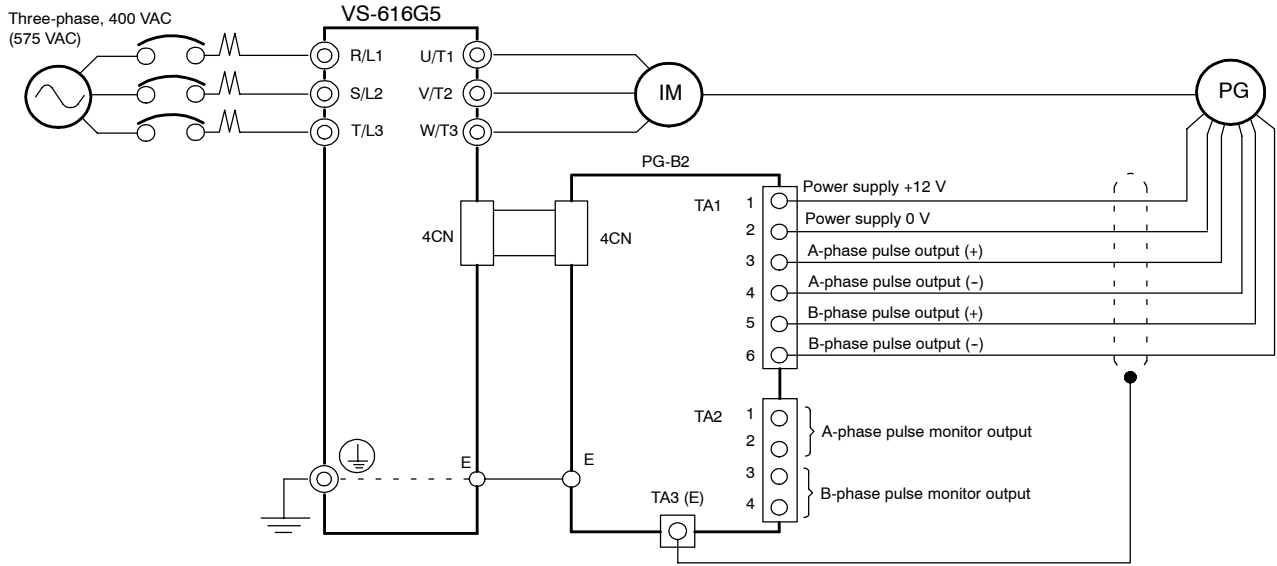

Fig 3.11 I/O Circuit Configuration of the PG-A2

3

■ PG-B2 (For Flux Vector Control Mode Only)



- Shielded twisted-pair wires must be used for signal lines.
- Do not use the pulse generator's power supply for anything other than the pulse generator (encoder). Using it for another purpose can cause malfunctions due to noise.
- The length of the pulse generator's wiring must not be more than 100 meters.
- The direction of rotation of the PC can be set in user constant F1-05. The factory preset is for forward rotation, A-phase advancement.

Fig 3.12 PG-B2 Wiring

I/O Circuit Configuration

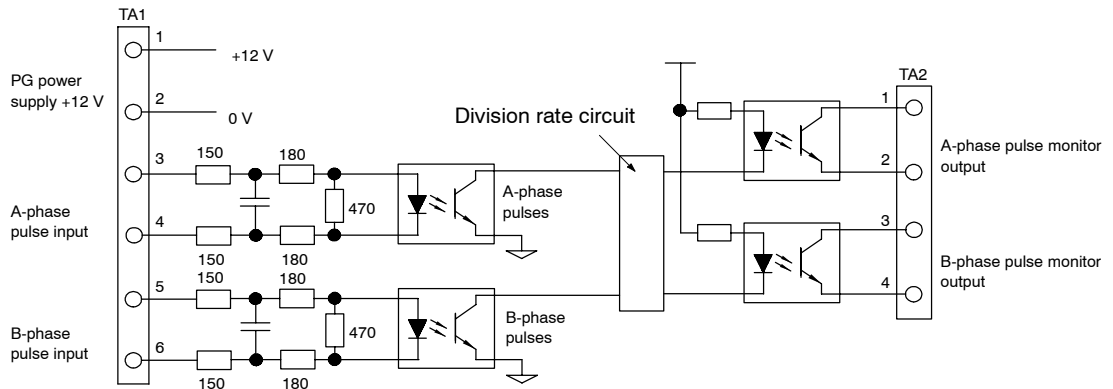

- When connecting to a voltage-output-type PG (encoder), select a PG that has an output impedance with a current of at least 12 mA to the input circuit photocoupler (diode).

Fig 3.13 I/O Circuit Configuration of the PG-B2

■ PG-D2 (For V/f with PG Feedback Mode Only)

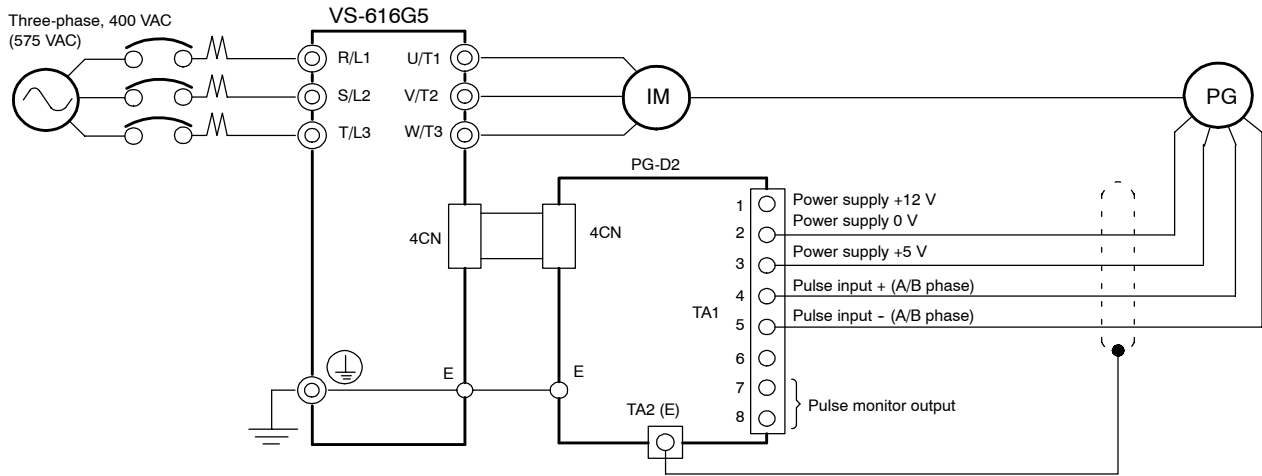

3

- Shielded twisted-pair wires must be used for signal lines.
- Do not use the pulse generator's power supply for anything other than the pulse generator (encoder). Using it for another purpose can cause malfunctions due to noise.
- The length of the pulse generator's wiring must not be more than 100 meters.

Fig 3.14 PG-D2 Wiring

■ PG-X2 (For Flux Vector Control Mode Only)

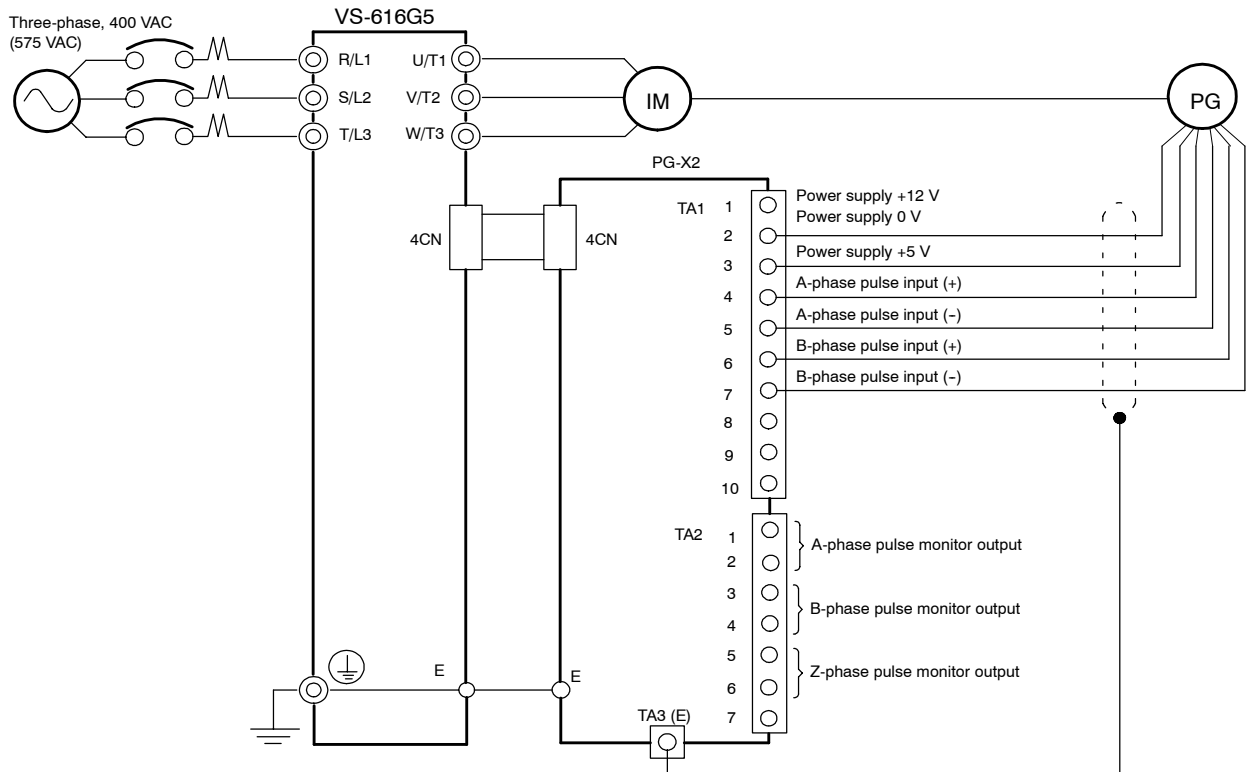

- Shielded, twisted-pair wire must be used for signal lines.
- Do not use the pulse generator's power supply for anything other than the pulse generator (encoder). Using it for another purpose can cause malfunctions due to noise.
- The length of the pulse generator's wiring must not be more than 100 meters.
- The direction of rotation of the PC can be set in user constant F1-05. The factory preset is for forward rotation, A-phase advancement.

Fig 3.15 PG-X2 Wiring

3.7.4 Wiring PG Speed Control Card Terminal Blocks

Use no more than 100 meters of wiring for PG (encoder) signal lines, and keep them separate from power lines.

Use shielded, twisted-pair wires for pulse inputs and pulse output monitor wires, and connect the shield to the shield connection terminal.

■ Wire Sizes (Same for All Models)

Terminal wire sizes are shown in *Table 3.7*.

Table 3.7 Wire Sizes

Terminal	Terminal Screws	Wire Thickness (mm ²)	Wire Type
Pulse generator power supply Pulse input terminal Pulse monitor output terminal	-	Stranded wire: 0.5 to 1.25 Single wire: 0.5 to 1.25	<ul style="list-style-type: none"> Shielded, twisted-pair wire Shielded, polyethylene-covered, vinyl sheath cable
Shield connection terminal	M3.5	0.5 to 2	

■ Solderless Terminals for Control Circuit Terminals

The use of solderless terminals for the control circuit terminals is recommended because solderless terminals are easy to connect securely.

Table 3.8 Straight Solderless Terminal Sizes

Wire Thickness	Model	d1	d2	Manufacturer
0.5 mm ²	A1 0.5-8 WH	1.00	2.60	Phoenix Contact
0.75mm ²	A1 0.75-8 GY	1.20	2.80	
1 mm ²	A1 1-8 RD	1.40	3.00	
1.5 mm ²	A1 1.5-8 BK	1.70	3.50	

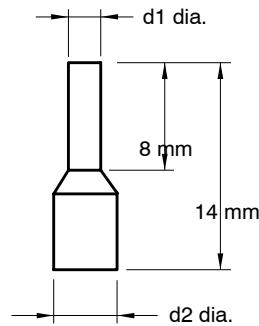

Fig 3.16 Straight Solderless Terminal Sizes

IMPORTANT

Do not solder wires with the control circuit terminals if wires are used instead of solderless terminals. Wires may not contact well with the control circuit terminals or the wires may be disconnected from the control circuit terminals due to oscillation if the wires are soldered.

■ **Closed-loop Connector Sizes and Tightening Torque**

The closed-loop connectors and tightening torques for various wire sizes are shown in *Table 3.9*.

Table 3.9 Closed-loop Connectors and Tightening Torques

Wire Thickness [mm ²]	Terminal Screws	Crimp Terminal Size	Tightening Torque (N•m)
0.5	M3.5	1.25 to 3.5	0.8
0.75		1.25 to 3.5	
1.25		1.25 to 3.5	
2		2 to 3.5	

■ **Wiring Method**

Use the following procedure to connect wires to the terminal block.

1. Loosen the terminal screws with a thin-slot screwdriver.
2. Insert the wires from underneath the terminal block.
3. Tighten the terminal screws firmly.

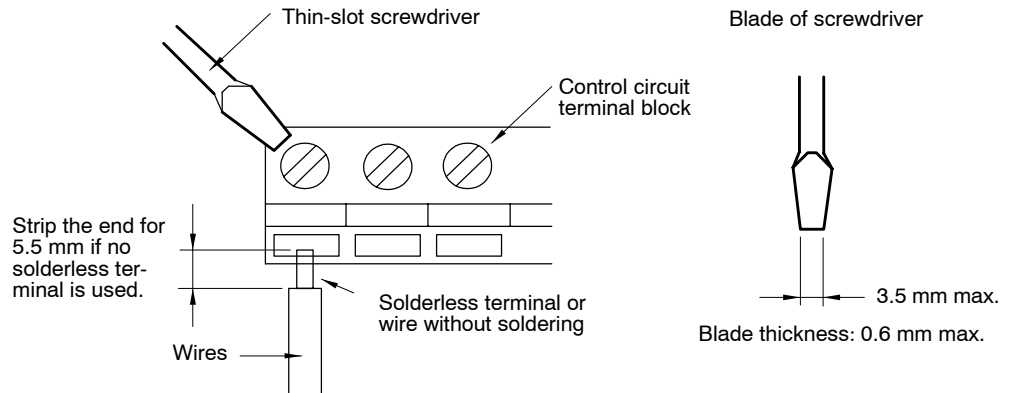

Fig 3.17 Connecting Wires to Terminal Block

IMPORTANT

Wiring Precautions

1. Separate PG Speed Control Card control circuit wiring (terminals TA1 and TA2) from main circuit wiring and other high-power lines.
2. Use twisted-pair or shielded twisted-pair cables to connect the PG to prevent operating faults. Process cable ends as shown in *Figure 3.18*. The maximum cable length is 100 m.

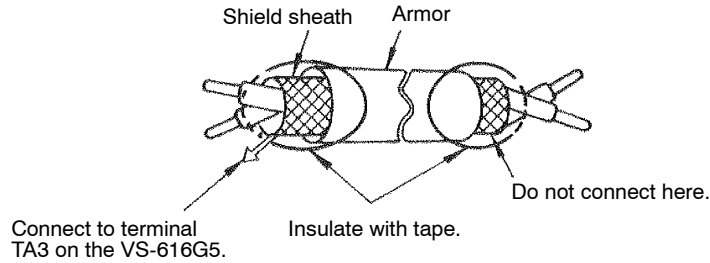

Fig 3.18 Processing the Ends of Twisted-pair Cables

3. Connect the shield to the ground terminal.
4. Do not solder the wires to the control circuit terminals. The wires may not contact well with the control circuit terminals if the wires are soldered.
5. The end of each wire connected to the control circuit terminals must be stripped for approximately 5.5 mm.

3.7.5 Selecting the Number of PG (Encoder) Pulses

■ PG-A2/PG-B2

The maximum response frequency is 32,767 Hz.

Use a PG that outputs a maximum frequency of approximately 20 kHz for the rotational speed of the motor.

$$\frac{\text{Motor speed at maximum frequency output (r/min)}}{60} \times \text{PG rating (p/rev)} = 20,000 \text{ Hz}$$

Some examples of PG output frequency (number of pulses) for the maximum frequency output are shown in Table 3.10.

Table 3.10 PG Pulse Selection Examples

Motor's Maximum Speed (r/min)	PG Rating (p/rev)	PG Output Frequency for Maximum Frequency Output (Hz)
1800	600	18,000
1500	800	20,000
1200	1000	20,000
900	1200	18,000

Note 1. The motor speed at maximum frequency output is expressed as the sync rotation speed.

2. The PG power supply is 12 V.

3. A separate power supply is required if the PG power supply capacity is greater than 200 mA. (If momentary power loss must be handled, use a backup capacitor or other method.)

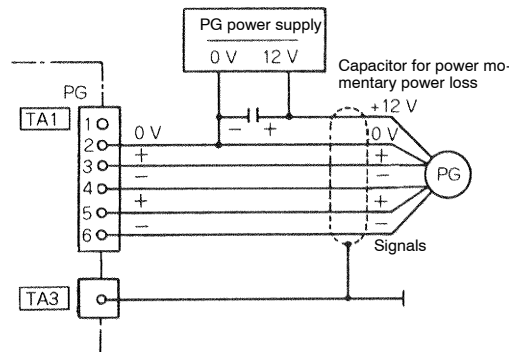

Fig 3.19 PG-B2 Connection Example

■ PG-D2/PG-X2

Both 12V and 15V are available as PG power supply. Verify the PG power supply specifications before connection.

The maximum response frequency is 300 kHz.

Use the following equation to computer the output frequency of the PG (f_{PG}).

$$f_{PG} \text{ (Hz)} = \frac{\text{Motor speed at maximum frequency output (r/min)}}{60} \times \text{PG rating (p/rev)}$$

A separate power supply is required if the PG power supply capacity is greater than 200 mA. (If momentary power loss must be handled, use a backup capacitor or other method.)

3.7.5 Selecting the Number of PG (Encoder) Pulses

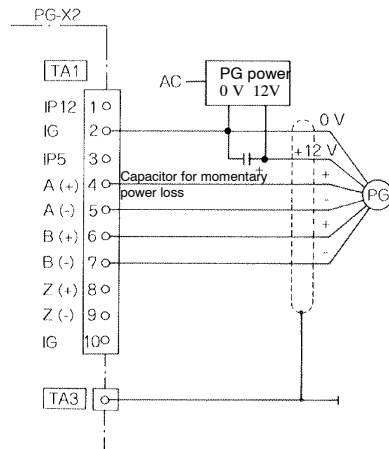

Fig 3.20 PG-X2 Connection Example

3.8 Grounding

3.8.1 Connection of Ground Bus Bar

When connecting the Inverter Panel side-by-side with an I/O terminal panel or general panel, firmly secure the bus bar connector or cable between the ground bus bars with bolts as shown in *Figure 3.21*.

To avoid any troubles or accidents that might be caused by a rise in voltage to ground due to current leakage, make sure that the bus bar is grounded before applying power.

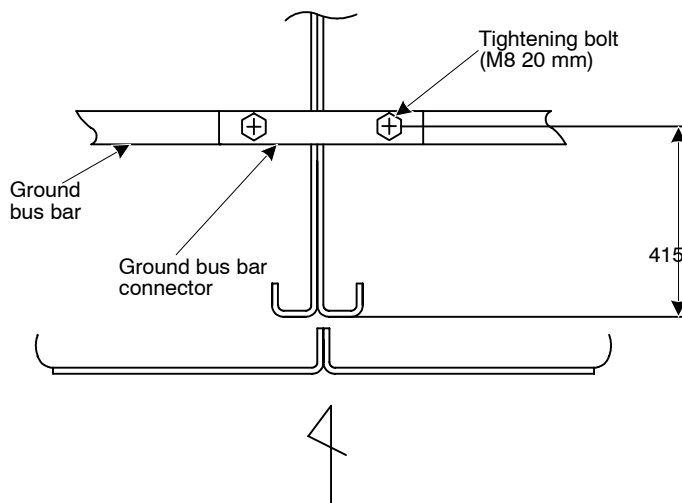

Fig 3.21 Ground Bus Bar Connection for 400-V (600 kW) Inverters Connected Side-by-side

3.8.2 Connection of Ground Cable for Control Signals

Separate the ground cable for control signals from the ground bus bar and apply a class-3 ground (100 Ω or less).

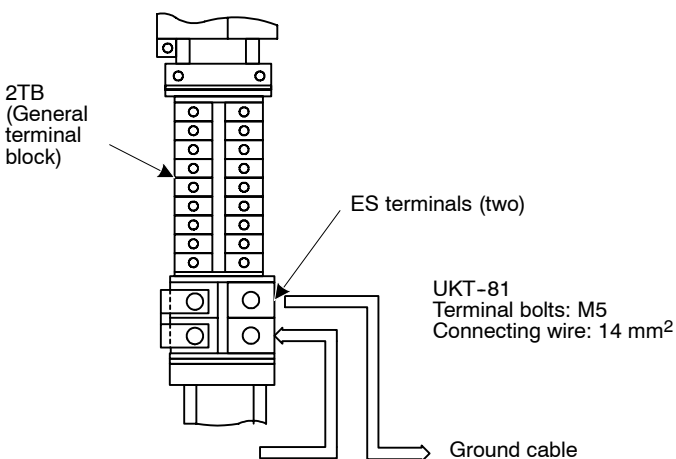

Fig 3.22 Connection of Ground Cable for Control Signals

4

Setting User Constants

This chapter describes setting user constants using the Digital Operator.

4.1 Using the Digital Operator	4 - 2
4.2 Modes	4 - 4
4.2.1 Inverter Modes	4 - 4
4.2.2 Switching Modes	4 - 5
4.2.3 User Constant Access Levels	4 - 6
4.2.4 Operation Mode	4 - 12
4.2.5 Initialize Mode	4 - 21
4.2.6 Programming Mode	4 - 29
4.2.7 Autotuning Mode	4 - 33
4.2.8 Modified Constants Mode	4 - 35

4.1 Using the Digital Operator

This section describes the component names and functions of the Digital Operator. The component names and functions are shown in *Figure 4.1* and Key functions are described in *Table 4.1*.

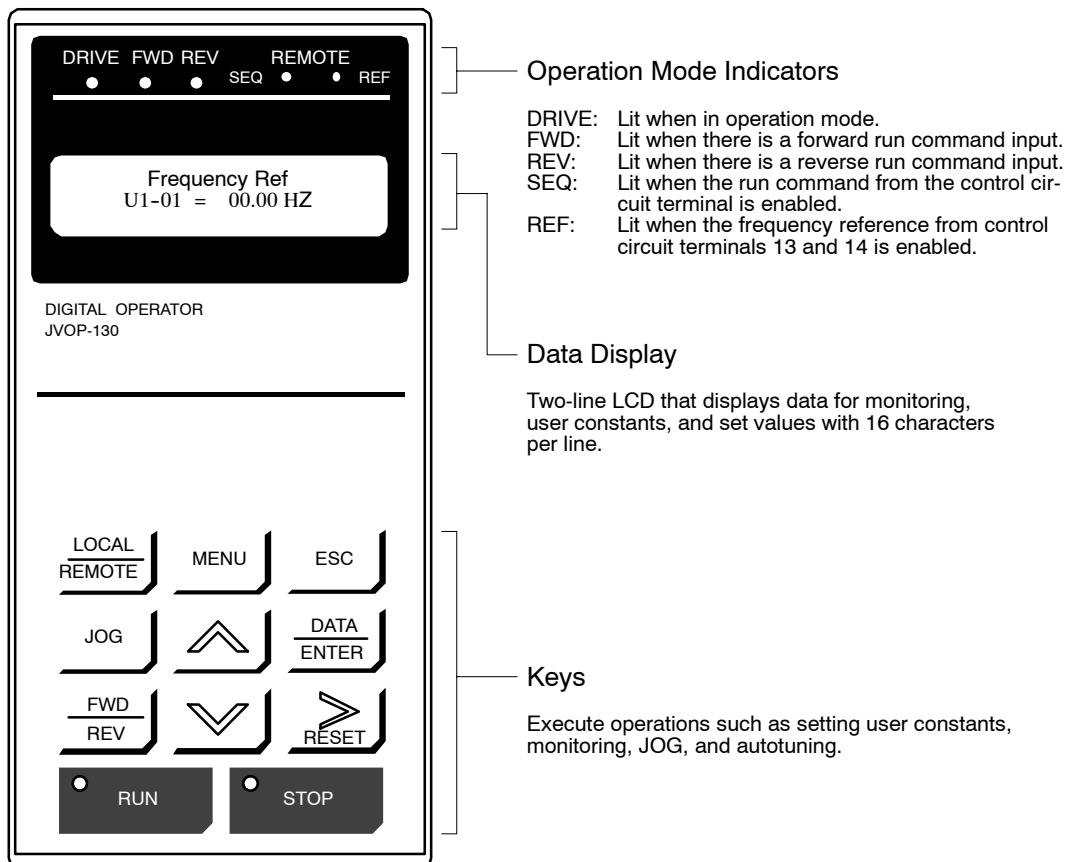









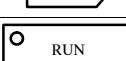
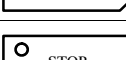

Fig 4.1 Digital Operator Component Names and Functions

4

Table 4.1 Key Functions

Key	Name	Function
	LOCAL/REMOTE Key	Switches between operation (LOCAL) via the Digital Operator and control circuit terminal (REMOTE) operation. This Key can be enabled or disabled by setting a user constant (o2-01).
	MENU Key	Displays menus.
	ESC Key	Returns to the status before the DATA/ENTER Key was pressed.
	JOG Key	Enables jog operation when the VS-616G5 is being operated from the Digital Operator.
	FWD/REV Key	Selects the rotation direction of the motor when the VS-616G5 is being operated from the Digital Operator.
	RESET Key	Sets the number of digits for user constant settings. Also acts as the reset Key when a fault has occurred.
	Increment Key	Selects menu items, groups, functions, and user constant names, and increments set values.
	Decrement Key	Selects menu items, groups, functions, and user constant names, and decrements set values.
	DATA/ENTER Key	Enters menu items, functions, constants, and set values after they are set.
	RUN Key	Starts the VS-616G5 operation when the VS-616G5 is in operation with the Digital Operator.
	STOP Key	Stops VS-616G5 operation. This Key can be enabled or disabled by setting a user constant (o2-02) when operating from the control circuit terminal.

Note Except in diagrams, Keys are referred to using the Key names listed in the above table.

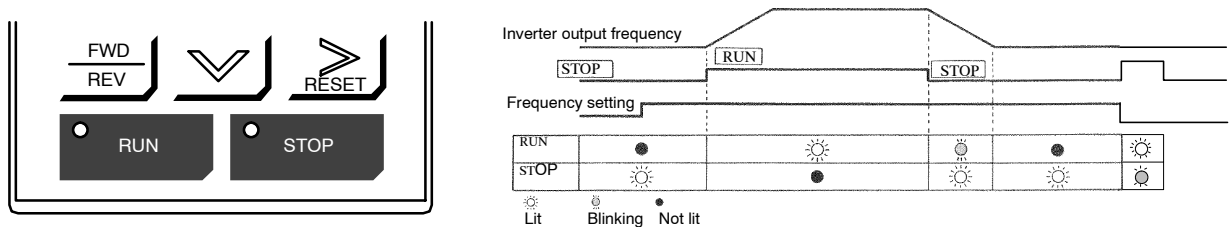

The RUN and STOP indicators light and blink to indicate operating status.

Fig 4.2 RUN and STOP Indicators

4.2 Modes

This section describes the VS-616G5's monitor modes, switching between modes, and accessing/setting user constants.

4.2.1 Inverter Modes

The VS-616G5 Inverter's user constants and monitoring functions have been organized in groups called modes that make it easier to read and set user constants.

The VS-616G5 is equipped with 5 modes, as shown in the *Table 4.2*.

Table 4.2 Modes

Mode	Primary function(s)
Operation mode	The Inverter can be run in this mode. Use this mode when monitoring values such as frequency references or output current, displaying fault information, or displaying the fault history.
Initialize mode	Use this mode when selecting the language displayed on the Digital Operator, selecting the access level for reading/setting user constants, selecting the control mode, or initializing the user constants.
Programming mode	Use this mode when reading/setting the user constants required for operation. The program-mode functions are subdivided into the following groups: <ul style="list-style-type: none"> • Application: Operation mode selection, DC control, speed search, etc. • Tuning: Acceleration/deceleration times, S-curve characteristics, carrier frequencies, etc. • Reference: Settings related to frequency control • Motor: V/f characteristics and motor constants • Option: Settings for Optional Cards • Terminal: Settings for sequential I/O and analog I/O • Protection: Settings for the motor and inverter protection functions • Operator: Selects the Digital Operator's display and Key functions
Autotuning mode	(Usable only with in vector control mode) Use this mode when running a motor with unknown motor constants in the vector control mode. The motor constants are calculated and set automatically. Perform autotuning for motor unit separately before vector control operation.
Modified constants mode (See note)	Use this mode to read/set user constants that have been changed from their factory-set values.

Note Always perform autotuning for motor unit separately before vector control operation.

4.2.2 Switching Modes

Once the Inverter has been put into operation mode by pressing the Menu Key, the Increment and Decrement Keys can be pressed to switch to other modes. Press the DATA/ENTER Key to read/set the user constants in each mode.

Press the ESC Key to return to the mode display from the user constant display.

Press the DATA/ENTER Key twice to write a constant and then press the ESC Key to return to the mode display. This is the most Basic operation, so you should remember it.

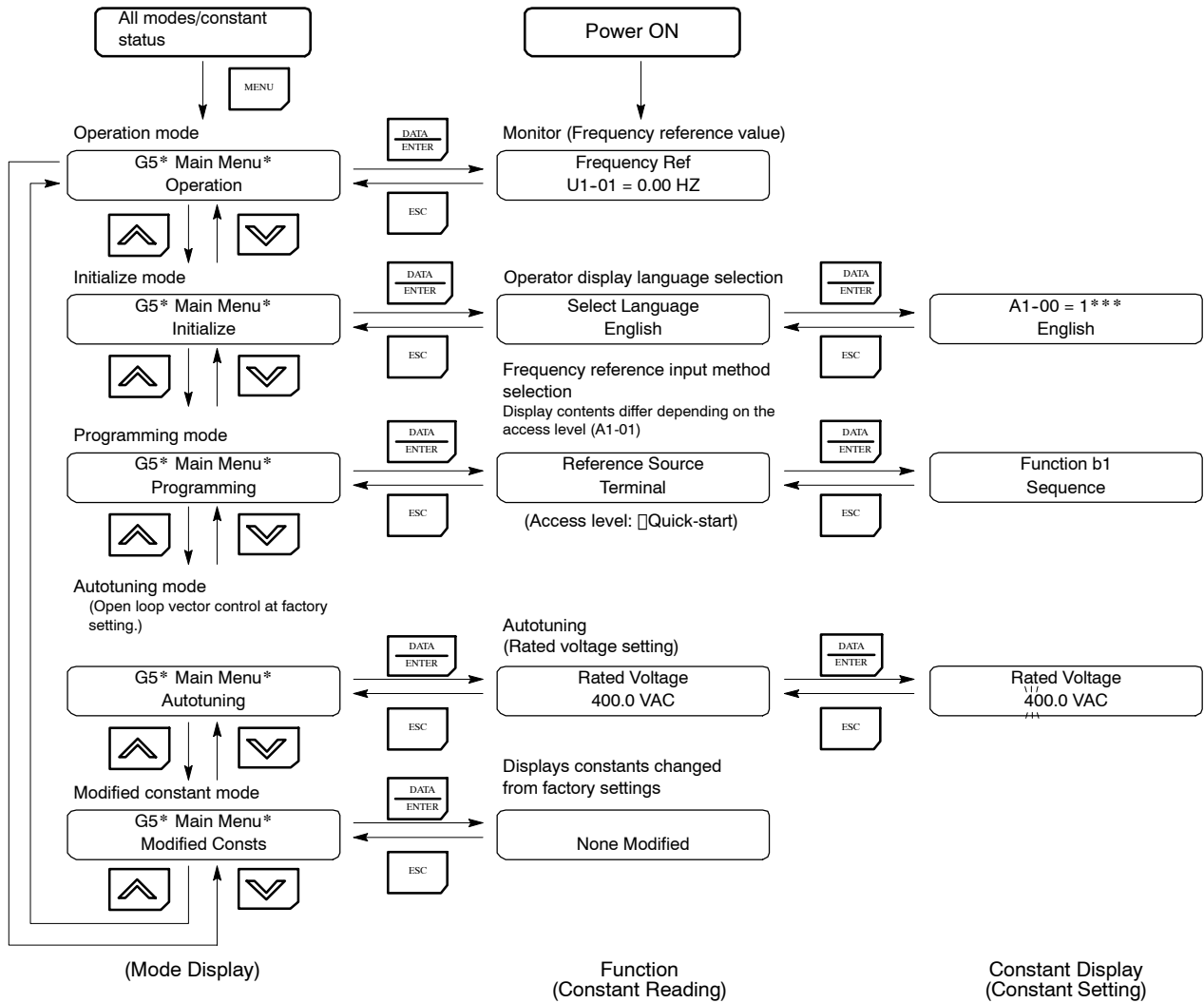

Fig 4.3 Mode Transitions

4.2.3 User Constant Access Levels







The VS-616G5 has three access levels which divide the various user constants based on their applications, as shown below. The access level restricts which user constants can be set or displayed.

Quick-start	Allows reading/setting of user constants required for simple operation. (factory preset)
Basic	Allows reading/setting of Basic user constants.
Advanced	Allows reading/setting of all user constants.

Set the access level in initialize mode with user constant A1-01.

■ Changing the Access Level from Quick-start to Basic

The Inverter is set at the factory to start in the Quick-start access level. Use the following procedure to change from the Quick-start level to the Basic level.

Step	Key Sequence	Digital Operator Display	Remarks
1		G5* Main Menu* Operation	
2		G5* Main Menu* Initialize	
3		Select Language English	
4		Access Level QUICK-START	
5		A1-01 = 2*** QUICK-START	
6		A1-01 = 3 Basic	
7		Entry Accepted Access Level Basic	

As shown above, Quick-start has changed to Basic.

4

These seven steps can be illustrated as when in *Figure 4.4*.

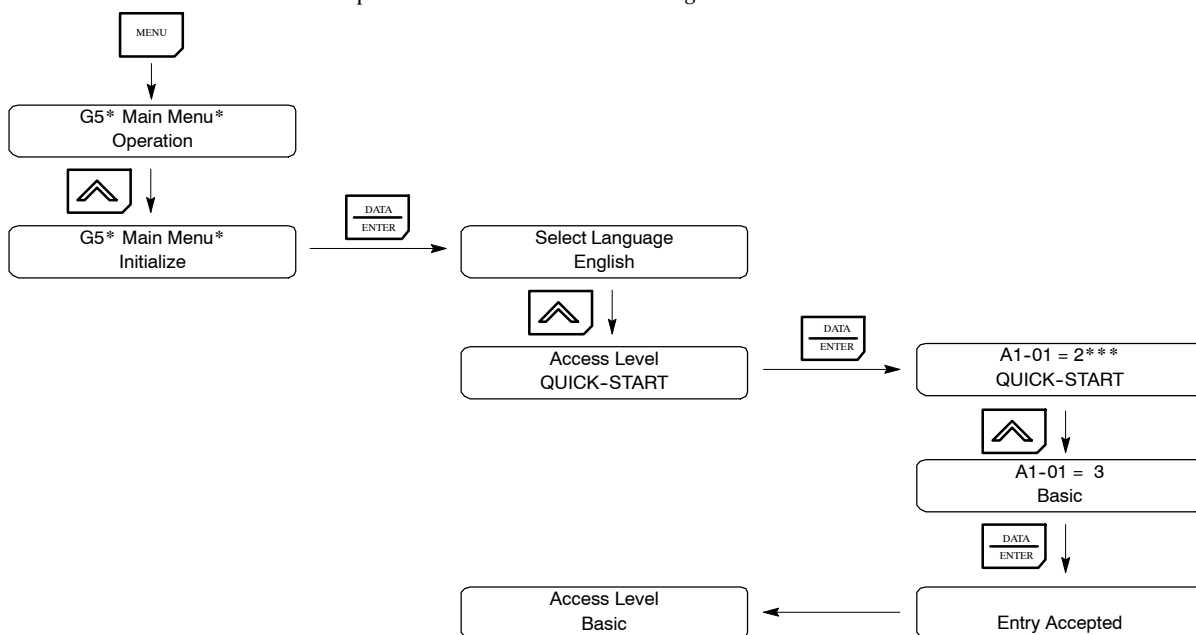

Fig 4.4 Changing Quick-start to Basic

■ Setting User Constants in Each Access Level

The displayed access level will change when programming mode is selected. The display will not change for access levels in operation mode, initialize mode, autotuning mode, and modified constants mode.

This section provides the procedure to change the acceleration time to 20.0 s in each access level. The acceleration time (C1-01) is a user constant in programming mode.

Setting User Constants

4.2.3 User Constant Access Levels

If the new user constant setting is not written to the Unit by pressing the DATA/ENTER Key within one minute after starting the procedure, the display will automatically revert to the original user constant setting. In this case, the procedure must be started again.

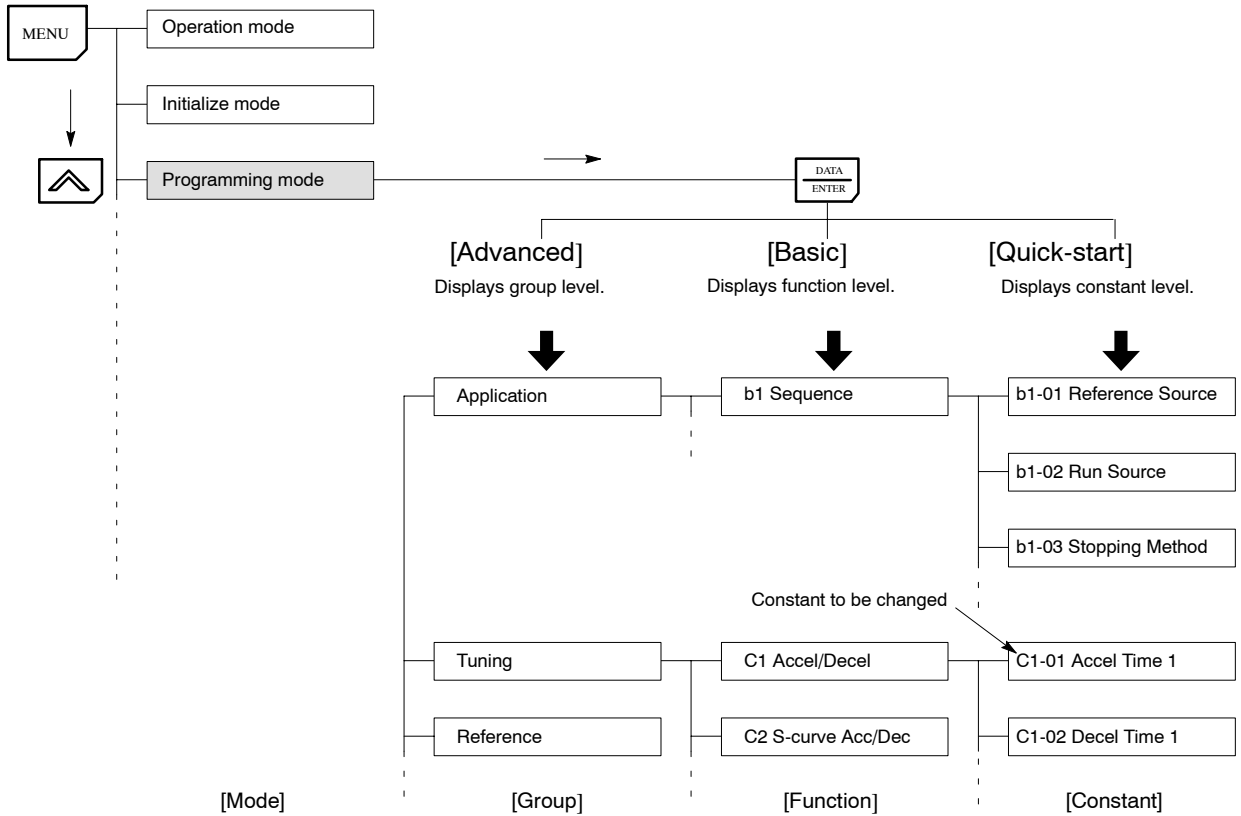











4

Fig 4.5 Constant Access Levels

EXAMPLE Setting a User Constant in the Quick-start Access Level

The user constant level will be displayed when the DATA/ENTER Key is pressed at the programming mode display.

Use the following display to set the acceleration time to 20.0 s.

Step	Key Sequence	Digital Operator Display	Remarks
1		G5* Main Menu * Operation	
2	 Press twice.	G5* Main Menu * Programming	
3		Reference source Terminals	Changed to constant setting level.
4		Run Source Terminals	
5		Stopping Method Ramp to Stop	
6		Accel Time 1 C1-01 = 10.0 Sec	
7		Accel Time 1 0010.0 Sec	Selects the user constant so that the leading 0 blinks. The digit that is blinking can be changed.
8	 Press twice.	Accel Time 1 0010.0 Sec	Blinking digit moves 2 places to the right.
9		Accel Time 1 0020.0 Sec	Changes 1 to 2.
10		Entry Accepted Accel Time 1 C1-01 = 20.0 Sec	After approx. 3 seconds, the Operator display is as shown on the left.

The acceleration time has been set to 20.0 seconds.

Step	Key Sequence	Digital Operator Display	Remarks
11		G5* Main Menu * Programming	

Returns to programming mode display.











Setting User Constants

4.2.3 User Constant Access Levels

◀EXAMPLE▶ Setting a User Constant in the Basic Access Level

The function level will be displayed when the DATA/ENTER Key is pressed at the programming mode display.











Use the following display to set the acceleration time to 20.0 s.

Step	Key Sequence	Digital Operator Display	Remarks
1		G5* Main Menu * Operation	
2	 Press twice.	G5* Main Menu * Programming	
3		Function b1 Sequence	Changed to constant reading (function) level.
4		Function b2 DC Braking	
5		Function C1 Accel/Decel	
6		Accel Time 1 C1-01 = 10.0 Sec	Changed to constant setting level,.
7		Accel Time 1 0010.0 Sec /11	Selects the user constant so that the leading 0 blinks. The blinking digit can be changed.
8	 Press twice.	Accel Time 1 0010.0 Sec /11	Blinking digit moves 2 places to the right and the "1" blinks.
9		Accel Time 1 0020.0 Sec /11	Changes 1 to 2.
10		Entry Accepted	Writes-in the new setting.
		Accel Time 1 C1-01 = 20.0 Sec	The Operator display is as shown on the left.
11		Function C1 Accel/Decel	

Returns to "Function C1 Accel/Decel" display.

EXAMPLE Setting a User Constant in the Advanced Access Level

The group level will be displayed when the DATA/ENTER Key is pressed at the programming mode display. Use the following procedure to set a constant.

Step	Key Sequence	Digital Operator Display	Remarks
1		G5* Main Menu * Operation	
2	 Press twice.	G5* Main Menu * Programming	
3		Group b Application	
4		Group C Tuning	
5		Function C1 Accel/Decel	Changed to constant reading (function) level.
6		Accel Time 1 C1-01 = 10.0 Sec	
7		Accel Time 1 0010.0 Sec 11	Selects the user constant so that the leading 0 blinks. The blinking digit can be changed.
8	 Press twice.	Accel Time 1 0010.0 Sec 11	Blinking digit moves 2 places to the right and the "1" blinks.
9		Accel Time 1 0020.0 Sec 11	Changes 1 to 2.
10		Entry Accepted	Writes-in the new setting, 20.0 s.
		Accel Time 1 C1-01 = 20.0 Sec	After a few seconds, the Operator display is as shown on the left.
11		Function C1 Accel/Decel	

The constant setting in Advanced level (acceleration time change from 10.0 to 20.0 s) has been completed.

4.2.4 Operation Mode

Operation mode is the mode in which the Inverter can be operated.

Many user constants can't be changed when the Inverter is operating. Refer to *User Constant List* for details.

The following monitor displays are possible in operation mode: The frequency reference, output frequency, output current, and output voltage, as well as fault information and the fault history.

IMPORTANT

When running the Inverter, press the MENU Key first to enter the operation mode and then press the DATA/ENTER Key from the operation mode display to bring up the monitor display.

Run commands can't be received from any other display. Once the Inverter is running, it can be switched to other modes.

■ Operations in Operation Mode

Key operations in operation mode are shown in *Figure 4.6*.

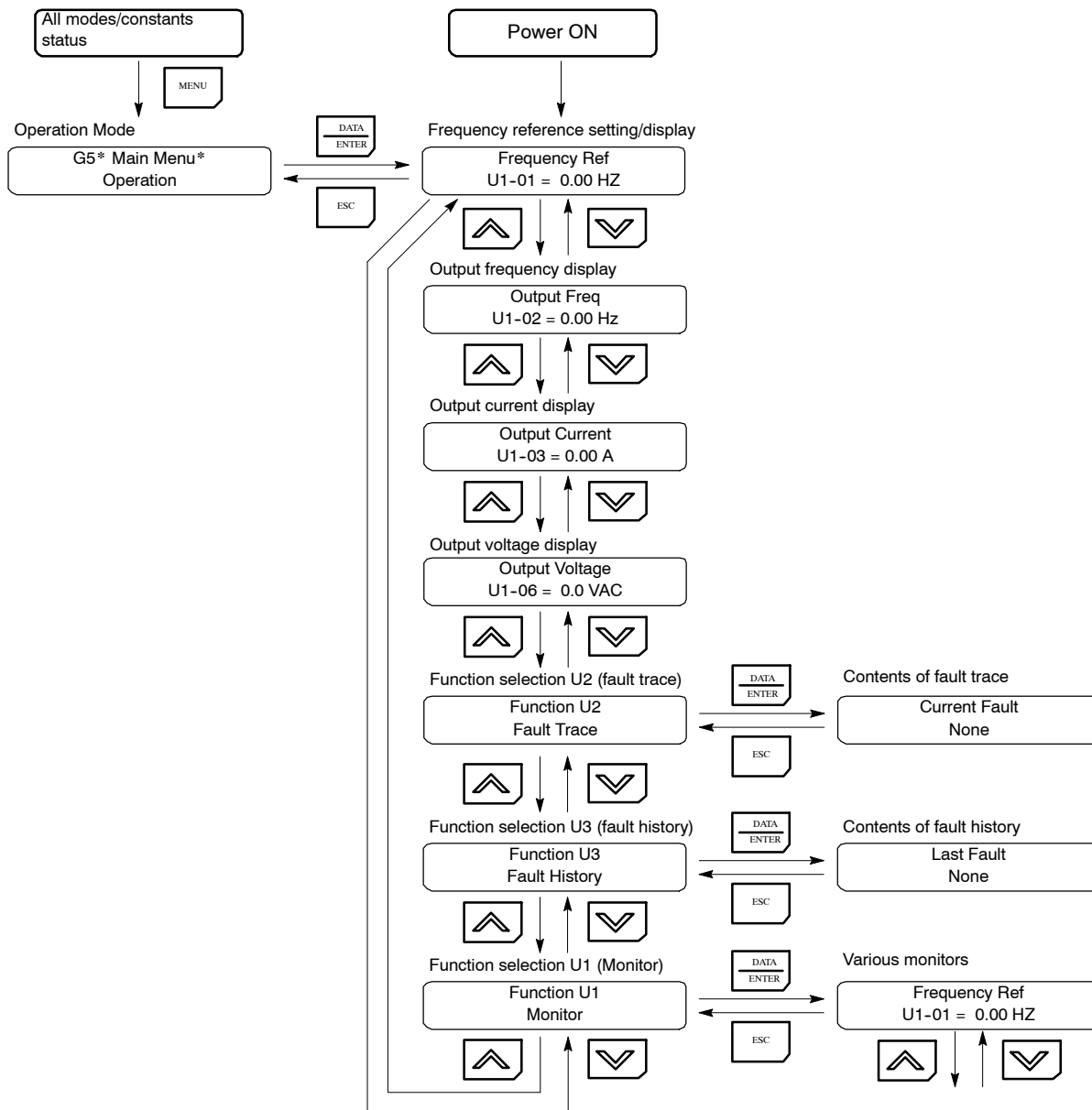

Fig 4.6 Operations in Operation Mode

■ **Conditions for Monitoring**

Table 4.3 shows the items that can be monitored in operation mode.

The “Valid access levels” column in the table indicates whether an item can be monitored in a particular access level and control method. The codes in this column have the following meanings.

Q	Items that can be monitored in all access levels (Quick-Start, Basic, and Advanced).
B	Items that can be monitored in the Advanced and Basic access levels.
A	Items that can be monitored only in the Advanced access level.
x	Items that cannot be monitored in the control mode shown.

The output signal levels for multi-function analog outputs shown in the table are for a gain of 100.0 and a bias of 0.00.

Table 4.3 Constants Monitored in Operation Mode

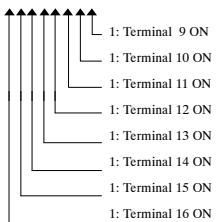
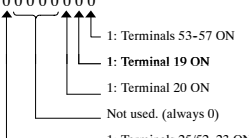
Function	Constant No.	Name Digital Operator Display	Function	Output Signal Levels for Multi-function Analog Outputs	Min. Unit	Valid Access Levels			
						V/f	V/f w/ PG	Open-loop Vector	Flux Vector
Status Monitor	U1-01	Frequency reference	Monitors/sets the frequency reference value.	10 V: Max. frequency (0 to ±10 V possible)	0.01 Hz	Q	Q	Q	Q
		Frequency Ref	The display units can be set with user constant o1-03.						
	U1-02	Output frequency	Monitors the output frequency.	10 V: Max. frequency (0 to ±10 V possible)	0.01 Hz	Q	Q	Q	Q
		Output Freq	The display units can be set with user constant o1-03.						
	U1-03	Output current	Monitors the output current.	10 V: Rated current (0 to +10 V output)	0.1 A	Q	Q	Q	Q
		Output Current							
	U1-04	Control method	Shows which control mode is set.	Can't be output.	-	Q	Q	Q	Q
		Control Method							
	U1-05	Motor speed	Monitors the motor speed.	10 V: Max. frequency (0 to ±10 V possible)	0.01 Hz	X	Q	Q	Q
		Motor Speed							
	U1-06	Output voltage	Monitors the Inverter's internal output voltage reference value.	10 V: 400 (575) VAC (0 to +10 V output)	0.1 V	Q	Q	Q	Q
		Output Voltage							
	U1-07	DC bus voltage	Monitors the DC voltage of the Inverter's internal main circuit.	10 V: 500 (1040) VDC (0 to +10 V output)	1 V	Q	Q	Q	Q
		DC Bus Voltage							
U1-08	Output power	Monitors the output power. (This is an internally detected value.)	10 V: Max. motor capacity (0 to ±10 V possible)	0.1 kW	Q	Q	Q	Q	
	Output kWatts								
U1-09	Torque reference	Monitors the internal torque reference value when vector control is used.	10 V: Rated torque (0 to ±10 V possible)	0.1 %	X	X	Q	Q	
	Torque Reference								
U1-10	Input terminal status	Shows input ON/OFF status. U1-10 = 0 0 0 0 0 0 0 0 	Can't be output.	-	Q	Q	Q	Q	
	Input Term Sts								
U1-11	Output terminal status	Shows output ON/OFF status. U1-11 = 0 0 0 0 0 0 0 0 	Can't be output.	-	Q	Q	Q	Q	
	Output Term Sts								

4

Function	Constant No.	Name	Function	Output Signal Levels for Multi-function Analog Outputs	Min. Unit	Valid Access Levels			
		Digital Operator Display				V/f	V/f w/ PG	Open-loop Vector	Flux Vector
Status Monitor	U1-12	Operation status	Inverter operating status. U1-12 = 00000000 	Can't be output.	-	Q	Q	Q	Q
		Int Ctl Sts 1							
	U1-13	Cumulative operation time	Monitors the Inverter's elapsed operating time. The initial value and running/power-on time selection can be set with user constants o2-07 and o2-08.	Can't be output.	1 hr	Q	Q	Q	Q
		Elapsed Time							
	U1-14	Software No.	Manufacturer's ID number	Can't be output.	-	Q	Q	Q	Q
		FLASH ID							
	U1-15	Terminal 13 input voltage level	Monitors the input voltage of the frequency reference (voltage). An input of 10 V corresponds to 100%.	10 V: 100% (10 V) (0 to ±10 V possible)	0.1 %	B	B	B	B
		Term 13 Level							
	U1-16	Terminal 14 input current level	Monitors the input current of the frequency reference (current). An input of 20 mA corresponds to 100%.	20 mA: 100% (20 mA) (0 to +10 V output)	0.1 %	B	B	B	B
		Term 14 Level							
	U1-17	Terminal 16 input voltage level	Monitors the input voltage of the multi-function analog input. An input of 10 V corresponds to 100%.	10 V: 100% (10 V) (0 to ±10 V possible)	0.1 %	B	B	B	B
		Term 16 Level							
	U1-18	Motor secondary current (Iq)	Monitors the calculated value of the motor's secondary current (Iq). The motor's rated secondary current corresponds to 100%.	10 V: Rated secondary current (0 to +10 V output)	0.1 %	B	B	B	B
		Mot SEC Current							
	U1-19	Motor exciting current (Id)	Monitors the calculated value of the motor's excitation current (Id). The motor's rated secondary current corresponds to 100%.	10 V: Rated secondary current (0 to +10 V output)	0.1 %	X	X	B	B
		Mot EXC Current							
	U1-20	Output frequency after soft-start	Monitors the output frequency after a soft start. The display shows the frequency without the correction from compensation functions such as slip compensation.	10 V: Max. frequency (0 to ±10 V possible)	0.01 Hz	A	A	A	A
		SFS Output							
	U1-21	ASR input	Monitors the input to the speed control loop. The max. frequency corresponds to 100%.	10 V: Max. frequency (0 to ±10 V possible)	0.01 %	X	A	X	A
		ASR Input							
U1-22	ASR output	Monitors the output from the speed control loop. The motor's rated secondary current corresponds to 100%.	10 V: Rated secondary current (0 to ±10 V possible)	0.01 %	X	A	X	A	
	ASR Output								
U1-23	Speed deviation	Monitors the speed deviation within the speed control loop. The max. frequency corresponds to 100%.	10 V: Max. frequency (0 to ±10 V possible)	0.01 %	X	A	X	A	
	Speed Deviation								

Setting User Constants

4.2.4 Operation Mode

Function	Constant No.	Name	Function	Output Signal Levels for Multi-function Analog Outputs	Min. Unit	Valid Access Levels			
		Digital Operator Display				V/f	V/f w/ PG	Open-loop Vector	Flux Vector
Status Monitor	U1-24	PID feedback value	Monitors the feedback value when PID control is used.	10 V: Max. frequency (0 to ±10 V possible)	0.01 %	A	A	A	A
		PID Feedback	The input for the max. frequency corresponds to 100%.						
	U1-25	DI-16H2 input status	Monitors the reference value from a VS-616G5-DI16H2 Digital Reference Card.	Can't be output.	-	A	A	A	A
		DI-16 Reference	The value will be displayed in binary or BCD depending on user constant F3-01.						
	U1-26	Output voltage reference (Vq)	Monitors the Inverter's internal voltage reference value for the motor's secondary current control.	10 V: 400 (575) VAC (0 to ±10 V possible)	0.1 V	X	X	A	A
		Voltage Ref (Vq)							
	U1-27	Output voltage reference (Vd)	Monitors the Inverter's internal voltage reference value for the motor's excitation current control.	10 V: 400 (575) VAC (0 to ±10 V possible)	0.1 V	X	X	A	A
		Voltage Ref (Vd)							
	U1-28	Software No. (CPU)	Manufacturer's CPU software ID number	Can't be output.	0.1 V	A	A	A	A
		CPU ID							
	U1-32	ACR output of q axis	Monitors current control output value for motor's secondary current.	10 V: 100%	0.1 %	X	X	A	A
		ACR (q) Output							
	U1-33	ACR output of d axis	Monitors current control output value for motor's excitation current.	10 V: 100%	0.1 %	X	X	A	A
		ACR (d) Output							
U1-34	OPE fault constant	Shows the first constant number where an OPE fault is detected.	Can't be output.	-	A	A	A	A	
	OPE Detected								
U1-35	Zero servo movement pulses	Shows the number of PG pulses for the movement range at the stop point for a zero servo times 4.	Can't be output.	1	X	X	X	A	
	Zero Servo Pulse								

Table 4.3 Constants Monitored in Operation Mode (Continued)

Function	Constant No.	Name	Function	Output Signal Levels for Multi-function Analog Outputs	Min. Units	Valid Access Levels																																																									
		Digital Operator Display				V/f	V/f w/ PG	Open-loop Vector	Flux Vector																																																						
Fault trace (See note.)	U2-01	Current fault	Information on the current fault	Can't be output.	-	Q	Q	Q	Q																																																						
		Current Fault																																																													
	U2-02	Last fault	Information on the last fault							-	Q	Q	Q	Q	Q																																																
		Last Fault																																																													
	U2-03	Frequency reference at fault	Frequency reference value when the "last fault" occurred.													0.01 Hz	Q	Q	Q	Q	Q																																										
		Frequency Ref																																																													
	U2-04	Output frequency at fault	Output frequency when the "last fault" occurred.																			0.01 Hz	Q	Q	Q	Q	Q																																				
		Output Freq																																																													
	U2-05	Output current at fault	Output current when the "last fault" occurred.																									0.1 A	Q	Q	Q	Q	Q																														
		Output Current																																																													
	U2-06	Motor speed at fault	Motor speed when the "last fault" occurred.																															0.01 Hz	X	Q	Q	Q	Q																								
		Motor Speed																																																													
	U2-07	Output voltage reference at fault	Output voltage when the "last fault" occurred.																																					0.1 V	Q	Q	Q	Q	Q																		
		Output Voltage																																																													
	U2-08	DC bus voltage at fault	The main circuit DC voltage when the "last fault" occurred.																																											1 V	Q	Q	Q	Q	Q												
		DC Bus Voltage																																																													
	U2-09	Output power at fault	Output power when the "last fault" occurred.																																																	0.1 kW	Q	Q	Q	Q	Q						
		Output kWatts																																																													
	U2-10	Torque reference at fault	Torque reference when the "last fault" occurred. (The rated torque = 100%.)																																																							0.1 %	X	X	Q	Q	Q
		Torque Reference																																																													
U2-11	Input terminal status at fault	Input terminal status when the "last fault" occurred. (Same format as U1-10.)	-	Q	Q	Q	Q	Q																																																							
	Input Term Sts																																																														
U2-12	Output terminal status at fault	Output terminal status when the "last fault" occurred. (Same format as U1-11.)							-	Q	Q	Q	Q	Q																																																	
	Output Term Sts																																																														
U2-13	Operation status at fault	Inverter operating status when the "last fault" occurred. (Same format as U1-12.)													-	Q	Q	Q	Q	Q																																											
	Inverter status																																																														
U2-14	Cumulative operation time at fault	Elapsed operating or power-on time when the "last fault" occurred.																			1 hr	Q	Q	Q	Q	Q																																					
	Elapsed time																																																														

Note When faults CPF00, 01, 02, 03, UV1 and UV2 occur, a fault trace is not performed.

Setting User Constants

4.2.4 Operation Mode

Function	Constant No.	Name	Function	Output Signal Levels for Multi-function Analog Outputs	Min. Units	Valid Access Levels			
		Digital Operator Display				V/f	V/f w/ PG	Open Loop Vector	Flux Vector
Fault history (See note.)	U3-01	Most recent fault	Information on the last fault.	Can't be output.	-	Q	Q	Q	Q
		Last Fault				Q	Q	Q	Q
	U3-02	Second most recent fault	Information on the 2 nd to last fault.		-	Q	Q	Q	Q
		Fault Message 2				Q	Q	Q	Q
	U3-03	Third most recent fault	Information on the 3 rd to last fault.		-	Q	Q	Q	Q
		Fault Message 3				Q	Q	Q	Q
	U3-04	Fourth/oldest fault	Information on the 4 th to last fault.		-	Q	Q	Q	Q
		Fault Message 4				Q	Q	Q	Q
	U3-05	Cumulative operation time at fault	Elapsed running or power-on time when the last fault occurred.		1 hr	Q	Q	Q	Q
		Elapsed Time 1				Q	Q	Q	Q
	U3-06	Accumulated time of second fault	Elapsed running or power-on time when the 2 nd to last fault occurred.		1 hr	Q	Q	Q	Q
		Elapsed Time 2				Q	Q	Q	Q
	U3-07	Accumulated time of third fault	Elapsed running or power-on time when the 3 rd to last fault occurred.		1 hr	Q	Q	Q	Q
		Elapsed Time 3				Q	Q	Q	Q
	U3-08	Accumulated time of fourth/oldest fault	Elapsed running or power-on time when the 4 th to last fault occurred.		1 hr	Q	Q	Q	Q
		Elapsed Time 4				Q	Q	Q	Q

Note Faults CPF00, 01, 02, 03, UV1 and UV2 are not recorded in the fault history.

■ Monitoring at Startup

In operation mode, the frequency reference, output frequency, output current, and output voltage can be monitored immediately if the factory presets are being used. One of these four values, the output voltage, can be changed to a different monitor item. When an item other than the output voltage is to be monitored, set that value in user constant o1-01 (Monitor selection). Refer to the example procedure given later in this manual.

When the power is turned ON, the frequency reference will appear in the Unit's data display if the factor presets are being used. Any one of the four values monitored at startup (frequency reference, output frequency, output current, or the value set in user constant o1-01) can be selected to appear when the power is turned ON.

The value that appears at startup is determined by user constant o1-02 (Monitor selection after power up).

User constants o1-01 and o1-02 can be changed in the Basic or Advanced access levels. These user constants can be changed during operation.

■ Monitor Displays

The following notation is used in this manual when describing user constants.

User Constant Number	Display Name	Change during Operation	Setting Range	Unit	Factory Setting	Valid Access Levels			
						V/f Control	V/f with PG	Open Loop Vector	Flux Vector
o1-01	Monitor selection	○	4 to 28	-	6	B	B	B	B

Use the last two digits from the *UI Monitor* list (U1-09) to select a value. For example, the torque reference is U1-09, so input 9 to select the torque reference.

Change during Operation	Indicates whether or not the constant can be changed during operation.	
	○	Can be changed during operation.
	X	Cannot be changed during operation.
Setting Range	The setting range for the constant.	
Units	The unit used to set the constant ("-" indicates that no unit is used).	
Factory Setting	The value preset at the factory. (There are different factory settings for each control method, i.e., if the control method is changed, the factory setting can also change.)	

Valid Access Levels	Indicates the control methods and access levels under which the constant can be accessed and set.	
	Q	Items that can be monitored in all access levels (Quick-Start, Basic, and Advanced).
	B	Items that can be monitored in the Advanced and Basic access levels.
	A	Items that can be monitored only in the Advanced access level.
X	Items that cannot be monitored in the control mode shown.	

User Constant Number	Name	Change during Operation	Setting Range	Unit	Factory Setting	Valid Access Levels			
						V/f Control	V/f with PG	Open Loop Vector	Flux Vector
o1-02	Monitor selection after power up	○	1 to 4	-	1	B	B	B	B

Use constant o1-02 to indicate which value will be displayed when the Inverter is started. Refer to the following table.

Monitor Display Contents at Startup

Setting	Contents
1	Indicates the frequency reference at startup.
2	Indicates the output frequency at startup.
3	Indicates the output current at startup.
4	Indicates the value set in user constant o1-01 at startup.

EXAMPLE Changing Monitor Display to Output Power at Startup in Basic Access Level

Change the access level to Basic if it is not already set there. Refer to *Figure 4.4* for the procedure to change from the Quick-start to Basic access level.







Use the following procedure to change the display from the output voltage to the output power.

Step	Key Sequence	Digital Operator Display	Remarks
1		G5* Main Menu* Operation	
2	 Press twice.	G5* Main Menu* Programming	
3		Function b1 Sequence	Changed to constant reading (function) level.
4	 Press twice.	Function o1 Monitor Select	
5		User Monitor Sel Output Voltage	Changed to constant setting level.
6		o1-01 = 6*** Output Voltage	
7	 Press twice.	o1-01 = 8 Output kWatts	
8		Entry Accepted	Writes-in the new setting.
		User Monitor Sel Output kWatts	After a few seconds, the Operator display is as shown on the left.

Output power has been set in place of output voltage.

◀EXAMPLE▶ Changing Monitor Display to Output Current at Startup in Basic Access Level

Use the following procedure to change user constant o1-02 so that the output current is displayed at startup. (The procedure continues from the end of the previous example.)

Step	Key Sequence	Digital Operator Display	Remarks
1	—	User Monitor Sel Output kWatts	Check the display. Writes-in the new setting. After a few seconds, the Operator display is as shown on the left.
2		Power-On Monitor Frequency Ref	
3		o1-02 = 1*** Frequency Ref	
4	 Press twice.	o1-02 = 3 Output Current	
5		Entry Accepted	
		Power-On Monitor Output Current	
6		Function o1 Monitor Select	
7		G5* Main Menu* Programming	

Output current has been set in monitor selection after power ON.

4.2.5 Initialize Mode

The initialize mode is used to select the language displayed by the Unit, the access level, and the control method; it is also used to initialize the Unit's user constants. The structure of the initialize mode is shown in *Figure 4.7*.

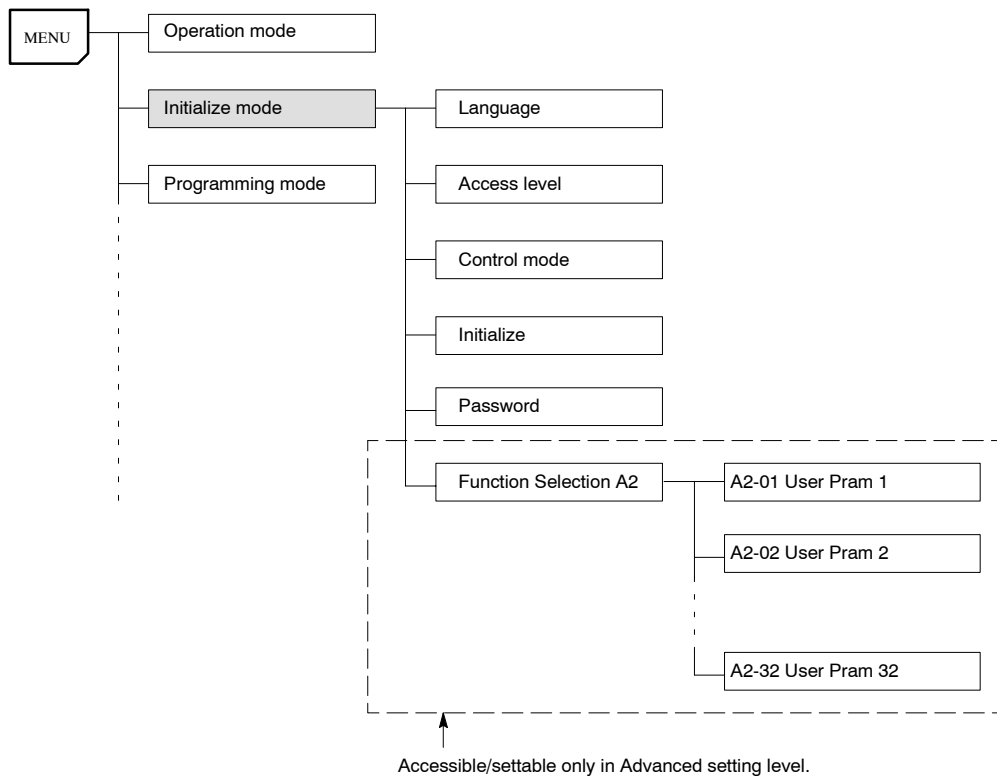

Fig 4.7 Structure of Initialize Mode User Constants

■ **Selecting the Display Language: A1-00**

- Use constant A1-00 to select the language displayed by the Inverter. A value of 0 sets English and a value of 1 sets Japanese.
- This user constant is not returned to the factory setting when constants are initialized. It must be manually reset to the factory setting.

User Constant Number	Name	Change during Operation	Setting Range	Unit	Factory Setting	Valid Access Levels			
						V/f Control	V/f with PG	Open Loop Vector	Flux Vector
A1-00	Language selection for Digital Operator display	○	0 (English), 1 (Japanese)	-	1 (Japanese)	Q	Q	Q	Q

◀ **EXAMPLE** ▶ **Changing the Language to English**

Use the following procedure to change the display language from Japanese to English.

Step	Key Sequence	Digital Operator Display	Remarks
1	MENU		Changed to constant setting level.
2	▲		
3	DATA ENTER	ゲンゴ (Language) ニホンゴ (Japanese)	
4	DATA ENTER	A1-00=1 * * ニホンゴ (Japanese)	
5	▲	A1-00 = 0 English	
6	DATA ENTER	Entry Accepted	
		Select Language English	After a few seconds, the Operator display is as shown on the left.

The display language has been set to English.

■ **Setting the Access Level: A1-01**

- Use constant A1-01 to select the user constant access level. This level determines which user constants can be changed and displayed.
- The user constants that can be displayed and changed also depend upon the control method being used.

User Constant Number	Name	Change during Operation	Setting Range	Unit	Factory Setting	Valid Access Levels			
						V/f Control	V/f with PG	Open Loop Vector	Flux Vector
A1-01	Constant access level	○	0 to 4	-	2 (Q)	Q	Q	Q	Q

Access Level Settings

Setting	Function	
0	Operation Only	This setting allows the operation mode and initialize mode to be changed or displayed. Use this setting to prevent user constant settings from being changed.
1	User Program	This setting allows only the user-selected constants (up to 32) to be changed or displayed. Select the desired user constants in A2-01 through A2-32.
2	Quick-start	This setting allows the user constants required to start the Inverter (about 25) to be changed or displayed.

Setting	Function	
3	Basic	This setting allows the commonly used user constants to be changed or displayed.
4	Advanced	This setting allows all user constants to be changed or displayed.

■ **Setting the Control Method: A1-02**

- Use constant A1-02 to select one of the four control methods.
- This user constant is not returned to the factory setting when constants are initialized. It must be manually reset to the factory setting.







User Constant Number	Name	Change during Operation	Setting Range	Unit	Factory Setting	Valid Access Levels			
						V/f Control	V/f with PG	Open Loop Vector	Flux Vector
A1-02	Control method selection	X	0 to 3	-	2 (Open Loop Vector)	Q	Q	Q	Q

Control Method Settings

Setting	Function
0	V/f control without pulse generator (normal V/f control).
1	V/f control with PG feedback (V/f control using a PG Speed Control Card).
2	Open-loop vector control (Vector control using the Inverter internal speed information).
3	Flux vector control (Vector control using a PG Speed Control Card).

◀ **EXAMPLE** ▶ **Changing the Control Method to Flux Vector**

Use the following procedure to change the control method to select flux vector.

Step	Key Sequence	Digital Operator Display	Remarks
1		G5* Main Menu * Operation	Changed to constant setting level.
2		G5* Main Menu * Initialize	
3		Select language English	
4	 Press twice.	Control Method Open Loop	
5		A1-02 = 2 *** Open Loop	
6		A1-02 = 3 Flux Vector	
7		Entry Accepted	
		Control Method Flux Vector	After a few seconds, the Operator display is as shown on the left.

The control method has been changed to flux vector.

4

Table 4.4 Control Method Characteristics

Characteristic	V/f Control without PG	V/f Control with PG	Open Loop Vector Control	Flux Vector Control
Basic Control Method	Voltage/frequency control (open loop)	Voltage/frequency control with speed compensation	Current vector control without PG	Current vector control with PG
Speed Detector	Not required	Required (pulse generator)	Not required	Required (pulse generator)
Optional Speed Detectors	Not required	PG-A2 or PG-D2	Not required	PG-B2 or PG-X2
Speed Control Range	1:40	1:40	1:100	1:1000
Starting Torque	150%/3 Hz	150%/3 Hz	150%/1 Hz	150 %/0 r/min
Speed Control Accuracy	±2 to 3%	±0.03%	±0.2%	±0.02%
Torque Limit	Not possible	Not possible	Possible	Possible
Torque Control	Not possible	Not possible	Not possible	Possible
Example Applications	<ul style="list-style-type: none"> Multiple motor drives. Replacing existing motor for which motor constants are not known. When autotuning is not possible. 	<ul style="list-style-type: none"> Simple speed feedback control. When a pulse generator is attached to the machine axis. 	<ul style="list-style-type: none"> Variable speed drive applications. 	<ul style="list-style-type: none"> Simple servo drives. Precision speed control. Torque control.

■ Initializing User Constants: A1-03

- Use constant A1-03 to initialize the user constants.
- When initialized, the user constants will return to their factory-preset values. You should normally record the setting of any constants that are changed from the factory presets.

User Constant Number	Name	Change during Operation	Setting Range	Unit	Factory Setting	Valid Access Levels			
						V/f Control	V/f with PG	Open Loop Vector	Flux Vector
A1-03	Initialize	X	0, 1110, 2220, 3330	-	0	Q	Q	Q	Q

Settings to Initialize User Constants

Setting	Function
0	Returns to the Initialize Display without initializing any user constants.
1110	Initializes the user constants to the user settings.
2220	2-wire sequential initialization (Initializes the user constants to the factory settings.)
3330	3-wire sequential initialization

Initializing to User Settings

This function initializes the user constants to values that have been recorded as user settings.

To record the user settings, change the user constants to the desired values and then set user constant o2-03 (User constant initial value) to 1. Once user settings are recorded, the o2-03 value will be automatically reset to 0. (The 1110 function will be disabled when user constant o2-03 is set to 0.)

- Example of Wiring for 2-wire Sequential Operation

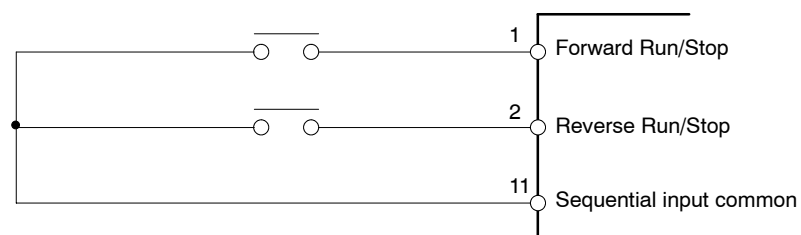

Fig 4.8 Example of Wiring for 2-wire Sequential Operation

- Example of Wiring for 3-wire Sequential Operation

The default settings of the multi-function inputs are different from the default settings of the 2-wire sequence.
 When setting a 3-wire sequence, the operation can be started and stopped with an automatically resetting pushbutton switch.

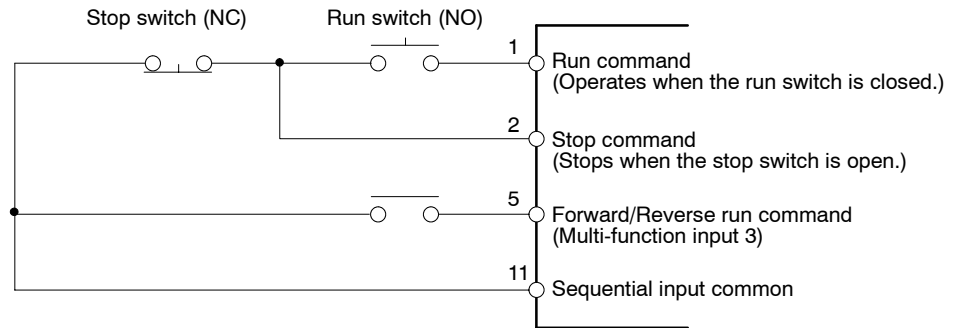

Fig 4.9 Example of Wiring for 3-wire Sequential Operation

EXAMPLE Initializing for 2-wire Sequential Operation

Use the following procedure to initialize user constants to the factory settings.

Step	Key Sequence	Digital Operator Display	Remarks
1	MENU	G5* Main Menu * Operation	
2	▲	G5* Main Menu * Initialize	
3	DATA ENTER	Select Language English	
4	▲	Init Parameters No Initialize	
5	Press 3 times. DATA ENTER	A1-03 = 0*** No Initialize	
6	▲	A1-03 = 2220 2-wire Initial	
7	DATA ENTER	Entry Accepted	Writes-in the new setting.
		Init Parameters No Initialize	After a few seconds, the Operator display is as shown on the left.

The initialization has been completed for a 2-wire sequence.











■ Passwords: A1-04, A1-05

- Use constants A1-04 and A1-05 to write-protect the initialize-mode user constants.
- User constants A1-01 through A1-03 and A2-01 through A2-32 can be displayed but not changed if the contents of A1-04 and A1-05 are not the same.
- To write-protect the initialize-mode user constants, set the password in A1-05 after inputting the desired values in A1-01 through A1-03 and A2-01 through A2-32. User constant A1-05 can be displayed by displaying A1-04 and pressing the Menu Key while pressing the Reset Key. (A1-05 can't be displayed with the usual Key sequences.)
- It will be possible to change the initialize-mode user constants again when the same password is written to A1-04 and A1-05.

User Constant Number	Name	Change during Operation	Setting Range	Unit	Factory Setting	Valid Access Levels			
						V/f Control	V/f with PG	Open Loop Vector	Flux Vector
A1-04	Password 1	X	0 to 9999	-	0	Q	Q	Q	Q
A1-05	Password 2	X	0 to 9999	-	0	Q	Q	Q	Q

◀EXAMPLE▶ Setting the Password to 1000

Use the following procedure to set the password to 1000.

Step	Key Sequence	Digital Operator Display	Remarks
1		G5* Main Menu* Operation	
2		G5* Main Menu* Initialize	
3		Select Language English	
4	 Press 4 times.	Enter Password A1-04 = 0	
5	 Hold RESET.	Select Password A1-05 = 0	
	 And press MENU.		
6		Select Password 0000	The first digit will blink. The blinking digit can be changed.
7		Select Password 1000	The value of the digit will increment each time the Increment Key is pressed and then stop at 9. Press the Decrement Key to decrease the value.
8		Entry Accepted	Writes-in the new setting.
		Select Password A1-05 = 1000	After a few seconds, the Operator display is as shown on the left.
9		Enter Password A1-04 = 0	

The password has been set to 1000.

To enable changing user constants, set the same password in A1-05 = 0.

■ Setting User Constants: A2-01 to A2-32

- User constants A2-01 through A2-32 specify the constants that can be displayed and changed when the access level (A1-01) is set to 1 (user programs).
- User constants A2-01 through A2-32 can be changed only in the Advanced access level and cannot be changed during operation.















Setting User Constants

4.2.5 Initialize Mode

- The following restrictions apply to setting/displaying user constants when the access level is set to the user program access level.

Operation	The Quick-start level user constants can be displayed.
Initialize	The Quick-start level user constants can be displayed or set.
Programming	Only the user constants specified in A2-01 through A2-32 can be displayed or set.
Autotuning	The user constants cannot be displayed.
Modified constants	The user constants cannot be displayed.

◀EXAMPLE▶ Setting C1-08 (Deceleration Time 4) in A2-01 to Define it as a User Constant

Step	Key Sequence	Digital Operator Display	Remarks
1		G5* Main Menu * Operation	
2		G5* Main Menu * Initialize	
3		Select Language English	
4		Function A2 User Constants	
5		User Param 1 A2-01 = -----	
6		User Param 1 -----	The first digit blinks.
7	 Press twice.	User Param 1 C1-01 / / \	
8	 Press twice.	User Param 1 C1-01 / / \	Writes-in set value 0000.
9	 Press 7 times.	User Param 1 C1-08 / / \ \	
10		Entry Accepted	Writes-in the new setting.
		User Param 1 A2-01 = C1-08	After a few seconds, the Operator display is as shown on the left.
11		Function A2 User Constants	
12	 Press twice.	Access Level Advanced	
13		A1-01 = 4*** Advanced	
14	 Press twice.	A1-01 = 1 User Program	The user program access level can be set only after one or more constants are set as user constants in A2-01 to A2-32. If no constants are set, the user program access level will not be displayed for A1-01.

Step	Key Sequence	Digital Operator Display	Remarks
15	DATA ENTER	Entry Accepted A1-01 = □4*** Advanced	Writes-in the new setting. (If the DATA/ENTER Key is not pressed within one minute, the Operator display will return as shown on the left. In this case, repeat from step 14.)
16	ESC	Access Level User Program G5* Main Menu * Initialize	After a few seconds, the Operator display is as shown on the left.

The access level has been set to the user program access level.

Figure 4.10 shows the structure of the user constants.

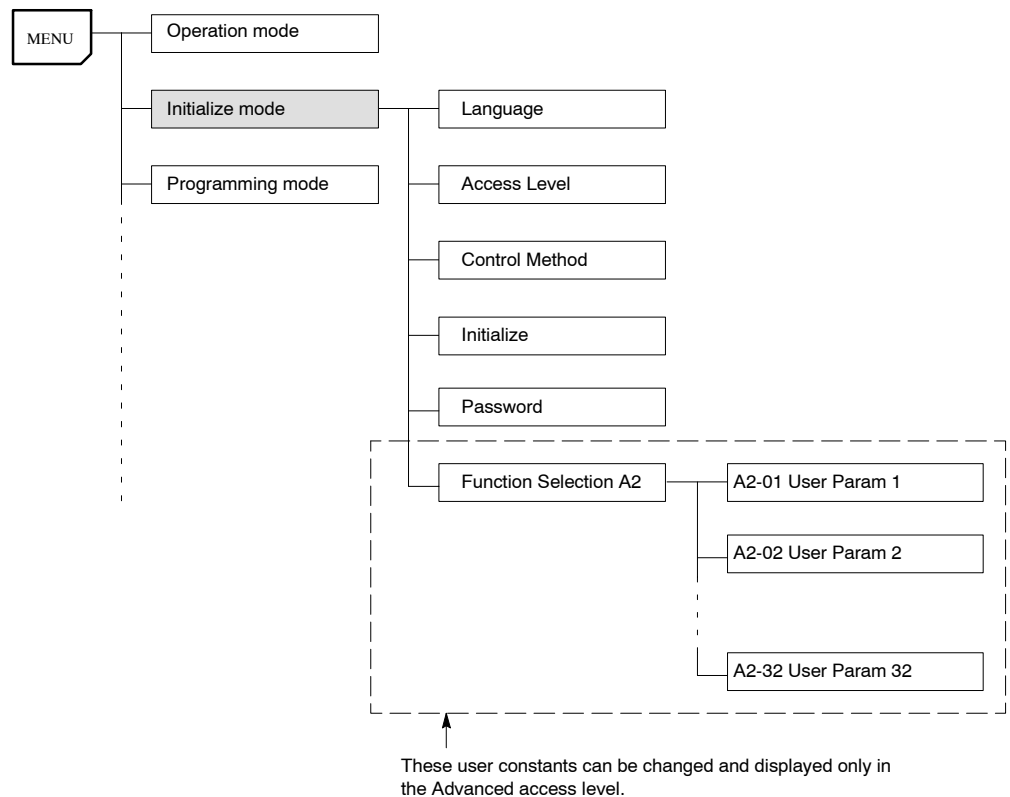

Fig 4.10 Structure of User Constants

4.2.6 Programming Mode

The Inverter user constants can be set in programming mode. The user constants which can be changed and displayed depend on the access level and control method that are being used. Refer to the following table to determine if a user constant can be changed.

The groups of constants in programming mode and their functions are shown in Table 4.5.

Table 4.5 Programming Mode Constant Groups

Group	Function	Display	Comments	Control Method					
				V/f	V/f w/PG	Open-loop Vector	Flux Vector		
b	Application	b1	Operating modes	Sequence	Settings such as the reference input method	○	○	○	○
		b2	DC braking	DC Braking	DC braking function settings	○	○	○	○
		b3	Speed searching	Speed Search	Speed search function settings	○	○	○	○
		b4	Timer functions	Delay Timers	Timer function settings	○	○	○	○
		b5	PID control	PID Control	PID control settings	○	○	○	○
		b6	Dwell functions	Reference Dwell	Accel/decel time dwell function settings	○	○	○	○
		b7	Droop control	Droop Control	Droop control (speed drop) settings	X	X	X	○
		b8	Energy-saving control	Energy Saving	Terminal input energy-saving control settings	○	○	X	X
		b9	Zero servo	Zero Servo	Stop in the position loop	X	X	X	○
C	Tuning	C1	Acceleration/deceleration times	Accel/Decel	Acceleration/deceleration time settings	○	○	○	○
		C2	S-curve acceleration/deceleration	S-Curve Acc/Dec	S-curve characteristics for accel/decel times	○	○	○	○
		C3	Slip compensation	Motor-Slip Comp	Slip compensation function settings	○	○	○	○
		C4	Torque compensation	Torque Comp	Torque compensation function settings	○	○	○	X
		C5	Speed control	ASR Tuning	Speed control loop user constant settings	X	○	X	○
		C6	Carrier frequencies	Carrier Freq	Carrier frequency settings	○	○	○	○
		C7	Hunting prevention functions	Hunting Prev	Hunting prevention function for V/f control	○	○	X	X
		C8	Factory tuning constants	Factory Tuning	Adjustment for open-loop vector control	X	X	○	X
d	Reference	d1	Frequency references	Preset Reference	Operator frequency reference settings	○	○	○	○
		d2	Frequency upper/lower limits	Reference Limits	Frequency upper and lower limit settings	○	○	○	○
		d3	Jump frequencies	Jump Frequencies	Prohibited frequency settings	○	○	○	○
		d4	Reference frequency hold function	Sequence	Hold for analog frequency reference	○	○	○	○
		d5	Torque control	Torque Control	User constant settings for torque control	X	X	X	○
E	Motor	E1	V/f characteristics	V/f Pattern	Sets the motor V/f characteristics.	○	○	○	○
		E2	Motor constants	Motor Setup	Sets the motor constants.	○	○	○	○
		E3	Motor 2 control method	Motor 2 Ctl Meth	Sets the control methods for motor 2.	○	○	○	○
		E4	V/f Characteristics 2	V/F pattern 2	Sets the V/f characteristics for motor 2.	○	○	○	○
		E5	Motor 2 constants	Motor 2 Setup	Sets the motor constants for motor 2.	○	○	○	○

4

Group	Function		Display	Comments	Control Method			
					V/f	V/f w/PG	Open-loop Vector	Flux Vector
F Options	F1	PG speed control card settings	PG Option Setup	User constant settings for a PG Card	X	○	X	○
	F2	Analog Reference Card AI	AI-14 Setup	User constant settings for an Analog Reference Card	○	○	○	○
	F3	Digital Reference Card DI	DI-08, 16 Setup	User constant settings for a Digital Reference Card	○	○	○	○
	F4	Analog Monitor Card AO	AO-08, 12 Setup	User constant settings for an Analog Monitor Card	○	○	○	○
	F5	Digital Output Card DO	DO-02C	User constant settings for a Digital Output Card	○	○	○	○
	F6	Digital Output Card DO	DO-08	User constant settings for a Digital Output Card	○	○	○	○
	F7	Pulse Monitor Card PO	PO-36F Setup	User constant settings for a Pulse Monitor Card	○	○	○	○
	F8	SI-F/SI-G Transmission Card	SI-F/G	User constant settings for a Transmission Card	○	○	○	○
	F9	CP-916B Transmission Card	DDS/SI-B	User constant settings for a Transmission Card	○	○	○	○
H Terminal	H1	Multi-function inputs	Digital Inputs	Function selection for multi-function inputs	○	○	○	○
	H2	Multi-function outputs	Digital Outputs	Function selection for multi-function outputs	○	○	○	○
	H3	Analog inputs	Analog Inputs	Function selection for analog inputs	○	○	○	○
	H4	Multi-function analog outputs	Analog Outputs	Function selection for analog outputs	○	○	○	○
	H5	MEMOBUS communications	Serial Com Setup	MEMOBUS communications settings	○	○	○	○
L Protection	L1	Motor protection functions	Motor Overload	Overload protection settings and selection	○	○	○	○
	L2	Momentary power loss ride-through	PwrLoss Ridethru	Selects the power-loss processing method.	○	○	○	○
	L3	Stall prevention	Stall Prevention	Stall prevention settings and selection	○	○	○	○
	L4	Frequency detection	Ref Detection	Frequency detection settings and selection	○	○	○	○
	L5	Fault restart	Fault Restart	Fault restart function settings	○	○	○	○
	L6	Overtorque detection	Torque Detection	Overtorque detection settings and selection	○	○	○	○
	L7	Torque limits	Torque Limit	Torque limit settings (vector control only)	X	X	○	○
	L8	Hardware protection	Hdwe Protection	Overheating and phase loss protection settings	○	○	○	○
o Operator	o1	Display/Monitor settings	Monitor Select	Selects the display and setting methods.	○	○	○	○
	o2	Function settings	Key Selections	Key function selection and other user constants	○	○	○	○

Figure 4.11 shows the difference in the display structure for the various access levels.

Setting User Constants

4.2.6 Programming Mode

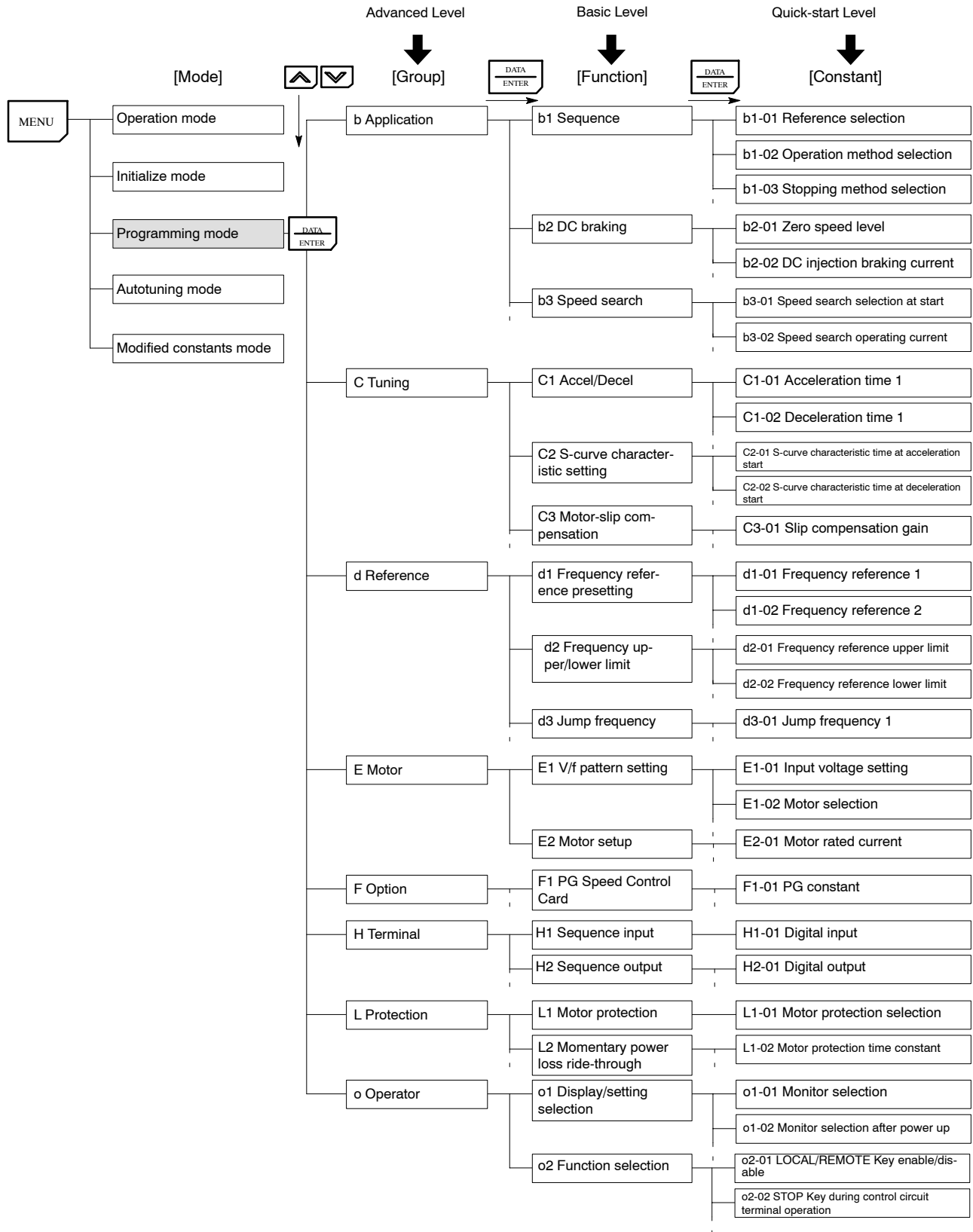

Fig 4.11 Display Structures for Different Access Levels

4.2.7 Autotuning Mode

⚠ CAUTION

- Disconnect the load (machine, device) from the motor before autotuning.
The motor may turn, possibly resulting in injury or damage to equipment. Also, motor constants cannot be correctly set with the motor attached to a load.

Autotuning automatically tunes and sets the required motor constants when operating in the open-loop or flux vector control modes. Always perform autotuning before starting operation.











When the rated voltage, rated current, rated frequency, and number of poles listed on the motor nameplate have been input and the RUN Key is pressed, the motor constants calculated from these values will be written to E1-04 through E2-09 automatically.

When motor cannot be disconnected from the load, motor constants can be set by calculation. Contact your Yaskawa representatives for details.

The autotuning mode won't be displayed if V/f control has been selected. Refer to *Setting the Control Method: A1-02* under 4.2.5 *Initialize Mode*.



The Inverter's autotuning function automatically determines the motor constants, while a servo system's autotuning function determines the size of a load, so these autotuning functions are fundamentally different.

◀EXAMPLE▶ Autotuning Procedure





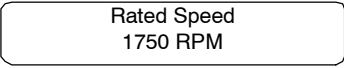

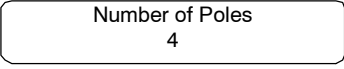

Step	Key Sequence	Digital Operator Display	Remarks
1		G5* Main Menu * Operation	
2	 press 3 times.	G5* Main Menu * Autotuning	
3		Rated Voltage (see note) 400.0 VAC	
4		Rated Voltage 400.0 VAC 	The leading digit blinks. When Increment Key is pressed, blinking value increases. When Decrement Key is pressed, blinking value decreases.
5		Rated Voltage 400.0 VAC 	The digit to be set moves to the right and blinks. Follow the above procedures as outlined in step 4.
6		Entry Accepted	After selecting values for steps 4 and 5, press DATA/ENTER Key. The Operator display is as shown on the left. The value is written-in.
		Rated Voltage 400.0 VAC	After a few seconds, the Operator display is as shown on the left.
7		Rated Current 370 A	
8			Press the keys as in steps 4, 5, 6 of rated voltage setting.
9		Rated Frequency 60.0 HZ	
10			Press the keys as in steps 4, 5, 6 of rated voltage setting.

Setting User Constants

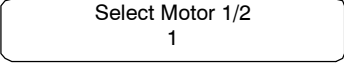
4.2.7 Autotuning Mode

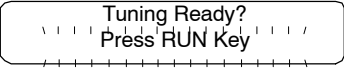
Step	Key Sequence	Digital Operator Display	Remarks
11			
12			Press the keys as in steps 4, 5, 6 of rated voltage setting.

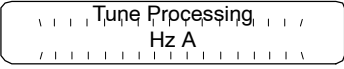
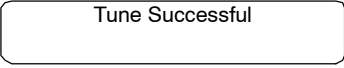
Note Rated voltage for vector control motors is approx. 10 to 20% lower than general-purpose motors. Verify motor voltage listed on the nameplate or the test report before use.

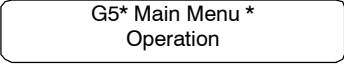
Step	Key Sequence	Digital Operator Display	Remarks
13			
14			Press the keys as in steps 4, 5, 6 of rated voltage setting.
15			
16			Press the keys as in steps 4, 5, 6 of rated voltage setting. Leave the setting at 1 to set the value for motor 1 (the motor contacts normally used.) Select "2" to store the autotuning results for motor 2.
17			
18		 	Autotuning starts and the motor rotates for approx. one minute. Then the motor stops automatically.
19			

Returns to the operation mode display.

IMPORTANT

- (1) If a fault occurs during autotuning, refer to *Table 5.1 Troubleshooting Autotuning Faults*.
- (2) Autotuning may not be possible depending on the motor type. For such motors, obtain the electric constants calculated based on Steinmetz's constant.

4.2.8 Modified Constants Mode











The modified constants mode is used to change or display user constants that have been changed from their factory-preset values.

When any user constants have been changed in programming mode (b1-01 through o2-08), press the DATA/ENTER Key in modified constants mode to display these user constants. (The initialize mode user constants won't be displayed.)

EXAMPLE Changing Frequency Reference 1 to 30.00 in Modified Constants Mode

In the following example, user constants C1-01 (Acceleration time 1) and d1-01 (Frequency reference 1) have been changed from their factory settings.

The settings for these two user constants are displayed, and the setting for d1-01 is changed from 60.00 Hz to 30.00 Hz while C1-01 is set to 20.0 seconds.

Step	Key Sequence	Digital Operator Display	Remarks
1		G5* Main Menu * Operation	
2		G5* Main Menu * Modified Consts	
3		Accel Time 1 C1-01 = 20.0 Sec	
4		Frequency Ref 1 d1-01 = 60.00 HZ	
5		Frequency Ref 1 060.00 HZ	
6		Frequency Ref 1 060.00 HZ	Blinking digit moves 1 place to the right.
7	 press 3 times.	Frequency Ref 1 030.00HZ	
8		Entry Accepted	30.00 Hz is written-in.
		Frequency Ref 1 d1-01 = 30.00 HZ	After a few seconds, the Operator display is as shown on the left.
9		G5* Main Menu * Modified Consts	Preset reference 1 is changed to 30.00 Hz in the modified constants mode.
10		G5* Main Menu * Operation	

Returns to the operation mode display.

5

Trial Operation

This chapter describes the preparations and Digital Operator procedures for trial operation of the VS-616G5 and provides an example of trial operation.

5.1 Procedure	5 - 3
5.2 Trial Operation Procedures	5 - 4
5.2.1 Power ON	5 - 4
5.2.2 Checking the Display Status	5 - 4
5.2.3 Initializing Constants	5 - 4
5.2.4 Setting Input Voltage	5 - 5
5.2.5 Autotuning	5 - 10
5.2.6 No-load Operation	5 - 12
5.2.7 Loaded Operation	5 - 12

 **WARNING**

- Check to be sure that the front door is closed before turning ON the power supply. Do not open the front door during operation.
An electric shock may occur if the door is open with the power turned ON.
- Do not come close to the machine when the fault reset function is used. If the alarmed is cleared, the machine may start moving suddenly. Also, design the machine so that human safety is ensured even when it is restarted.
Injury may occur.
- Provide a separate emergency stop switch; the Digital Operator's STOP Key is valid only when its function is set.
Injury may occur.
- Reset alarms only after confirming that the RUN signal is OFF. If an alarm is reset with the RUN signal turned ON, the machine may suddenly start.
Injury may occur.

 **CAUTION**

- Don't touch the radiation fins (heat sink), braking resistor, or Braking Resistor Unit. These can become very hot.
Otherwise, a burn injury may occur.
- Be sure that the motor and machine is within the applicable ranges before starting operation.
Otherwise, an injury may occur.
- Provide a separate holding brake if necessary.
Otherwise, an injury may occur.
- Don't check signals while the Inverter is running.
Otherwise, the equipment may be damaged.
- Be careful when changing Inverter Panel settings. The Inverter Panel is factory set to suitable settings.
The equipment may be damaged if unsuitable settings are used.

5.1 Procedure

Perform trial operation according to the following operational flow.

Item	Contents	Page
Installation and Mounting ↓	Install the Inverter according to the installation conditions. • Ensure that the installation conditions are met.	2 - 1
Wiring and Connection ↓	Connect to the power supply and peripheral devices. • Select peripheral devices which meet the specifications and wire correctly.	3 - 1
Power ON ↓	Carrying out the following pre-connection checks before turning ON the power supply: • Always ensure that a power supply of the correct voltage is used and that the power input terminals (R, S, T) are wired correctly. □400-V class: 3-phase 380 to 460 VAC, 50/60 Hz □575-V class: 3-phase 500 to 600 VAC, 50/60 Hz • Make sure that the Motor output terminals (U, V, W) and the Motor are connected correctly. • Make sure that the control circuit terminals and the control device are wired correctly. Make sure that all control circuit terminals are turned OFF. • When using a PG Speed Control Card, ensure that it is wired correctly. • Set the motor to no-load status, (not connected to the mechanical system). Having conducted the above checks, connect the power supply.	5 - 4
Check the Display Status ↓ *1	Check to be sure that there are no faults in the Inverter. • If the display at the time the power is connected is normal, it will read as follows: Data Display: Frequency Ref • When an fault has occurred, the details of the fault will be displayed. In that case, refer to <i>Section 9 Maintenance Operations</i> .	5 - 4
Setting the Input Voltage ↓	Set the Inverter input voltage (E1-01) to the correct voltage.	5 - 5
Set the Motor ↓	Set the proper motor protection (E1-02).	5 - 10
Autotuning ↓ *2	Execute autotuning in the open-loop vector control mode. • When autotuning is executed, motor constants are set automatically. • When motor constants cannot be set using autotuning, input each constant for the motor.	5 - 10
No-load Operation ↓	Start the no-load motor using the Digital Operator. • Set the frequency reference using the Digital Operator and start the motor using key sequences.	5 - 12
Actual Load Operation ↓	Connect the mechanical system and operate using the Digital Operator. • When there are no difficulties using the no-load operation, connect the mechanical system to the motor and operate using the Digital Operator.	5 - 12
Operation	Basic Operation: Operation based on the basic settings required to start and stop the Inverter.	6 - 1
	Advanced Operation: Operation which uses PID control or other functions. • For operation within standard constants select "Basic Operation." • To use the various applied functions such as, direct current control braking, speed search, timer, S-curve acceleration/deceleration, slip compensation, torque compensation, droop control, zero-servo, and torque control, select "Advanced Operation" in combination with "Basic Operation."	7 - 1
		--

* It is sometimes necessary to initialize constants after checking the display status.

Initializing Constants	Initialize the constants. • Check the Inverter capacity setting (kVA) in o2-04 before replacing the controller PCB with a spare.	5 - 4
------------------------	---	-------

*2 When motor cannot be disconnected from the load, motor constants can be set by calculations. Contact your Yaskawa representatives for details.

5.2 Trial Operation Procedures

5.2.1 Power ON

■ Checkpoints before Turning ON the Power Supply

- Check that the power supply is of the correct voltage.
400-V class: 3-phase 380 to 460 VAC, 50/60 Hz
575-V class: 3-phase 500 to 600 VAC, 50/60 Hz
- Make sure that the control power matches with the control power voltage jumper.
- Make sure that the motor output terminals (U, V, W) and the motor are connected correctly.
- Make sure that the Inverter control circuit terminal and the control device are wired correctly.
- Set all Inverter control circuit terminals to OFF.
- When using a PG Speed Control Card, make sure that it is wired correctly.
- Make sure that the motor is not connected to the mechanical system (no-load status)

5.2.2 Checking the Display Status

If the Digital Operator's display at the time the power is connected is normal, it will read as follows:

[Normal]

Frequency Ref
U1-01 = 0.00 HZ

The frequency reference monitor is displayed in the data display section.

When an fault has occurred, the details of the fault will be displayed instead of the above display. In that case, refer to *Chapter 9 Maintenance Operations*. The following display is an example of a fault display.

[Fault]







UV
Under Voltage



The display will differ depending on the type of fault.

5.2.3 Initializing Constants

- When replacing the controller PCB, check the Inverter capacity (kVA) in o2-04 first and then initialize constants to the factory settings. There is no need to initialize constants the first time trial operation is performed after purchasing the Inverter.
- To initialize the constants, set "2220" in A1-03 (Initialize).
- After initialization, the access level is set to Quick-start (A1-01). The following table shows the setting method for Quick-start.

Use the following procedure to initialize constants.

Step	Key Sequence	Digital Operator Display	Remarks
1		Frequency Ref U1-01 = 0.00 HZ	Displays operation mode.
2		G5* Main Menu* Operation	
3		G5* Main Menu* Initialize	Displays initialize mode.
4	 Press 3 times.	Select Language English	Puts the Inverter in initialize mode.
5		Initialize Select	Displays the Initialize display.
6		A1-03 = 0*** Select	Displays the constant setting for A1-03.
		A1-03 = 2220 2-wire Initial	Initializes for a 2-wire sequence.

Step	Key Sequence	Digital Operator Display	Remarks
7		Entry Accepted	Writes the set values. "Entry Accepted" is displayed for approximately 0.5 seconds.
8		Initialize Select	Returns to the Initialize display.
		G5* Main Menu* Initialize	Returns to the initialize mode display.

5.2.4 Setting Input Voltage

Set the input voltage of the Inverter (E1-01) according to the power supply voltage.









■ Input Voltage: E1-01

Set the input voltage.

User Constant Number	Name	Change during Operation	Setting Range	Unit	Factory Setting	Valid Access Levels			
						V/f Control	V/f with PG	Open Loop Vector	Flux Vector
E1-01	Input voltage setting	X	360 to 460 (460 to 690)*	VAC	400 (600)*	Q	Q	Q	Q

* Values in parentheses are for 575-V class Inverters.

Use the following procedure to set a 400-V class Inverter to an input voltage of 440 V.

Step	Key Sequence	Digital Operator Display	Remarks
1		*Main Menu* Initialize	Displays initialize mode.
		Main Menu Programming	Displays programming mode.
2		Frequency Ref Terminal	Puts the Unit in programming mode.
3		Input Voltage E1-01 = 400 VAC	Displays the input voltage setting display.
Press 10 times.			
4		Input Voltage 400 VAC /1\	The leading digit will blink
5		Input Voltage 400 VAC /1\	The 2nd digit will blink.
6		Input Voltage 440 VAC /1\	Set to "4"
Press 4 times.			
7		Entry Accepted	The set value is overwritten. "Entry Accepted" is displayed for approximately 0.5 seconds.
8		Input Voltage E1-01 = 230 VAC	Returns to the input voltage display. Check that the data has been updated.
		Main Menu Programming	Returns to the programming mode display.

■ Setting the Control Power Supply Voltage Jumper

Set the voltage of the power supply to the control circuit and the fan.

The factory-set voltage is 400 V for the 400-V Class and 575 V for the 575-V Class Inverters. When applying voltage other than these settings, use the following procedure to change the jumper setting.

1. Turn OFF the power supply and wait for at least five minutes.

5.2.4 Setting Input Voltage

2. Open the front door of the Inverter Panel.
3. Insert the jumper at the position that corresponds to the control power supply voltage supplied to the Inverter Panel. *Figure 5.1* and *Figure 5.2* indicate the jumper location and *Figure 5.3* indicates jumper arrangement.
4. Close the front door of the Inverter Panel.

400-V Class (200 kW) and 575-V Class (300 kW) Inverter Panels

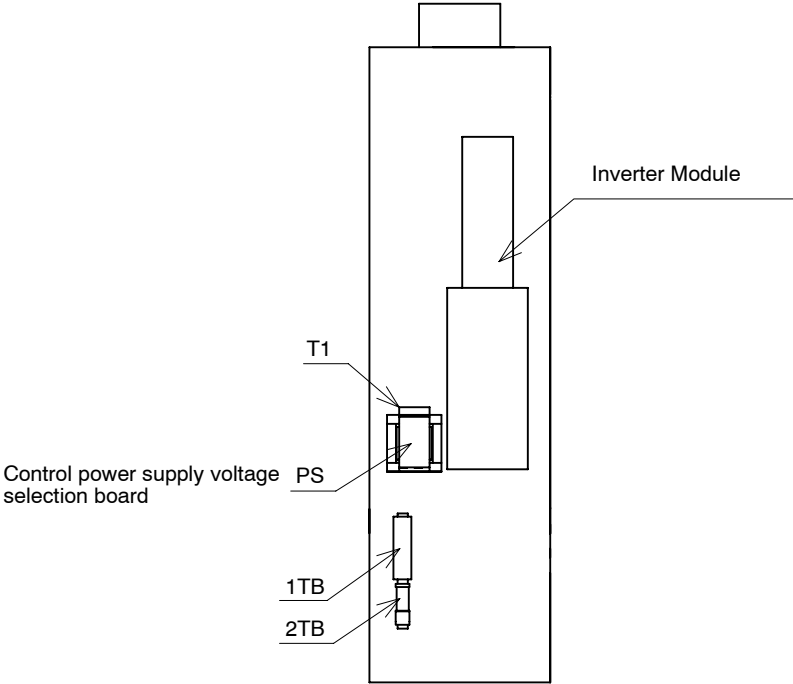

Fig 5.1 Selection of Control Power Supply Voltage for 400-V Class (200 kW) and 575-V Class (300 kW) Inverter Panels

400-V Class (400 kW, 600 kW, 800 kW) and 575-V Class (600 kW, 900 kW, 1200 kW) Inverter Panels

The following figures show an example for a 400-V class, 400-kW and a 575-V class, 600-kW Inverter Panel.

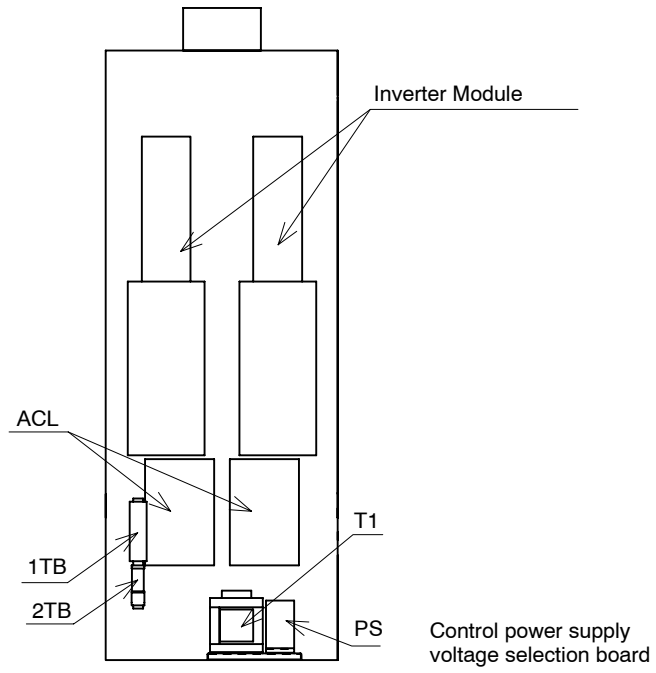
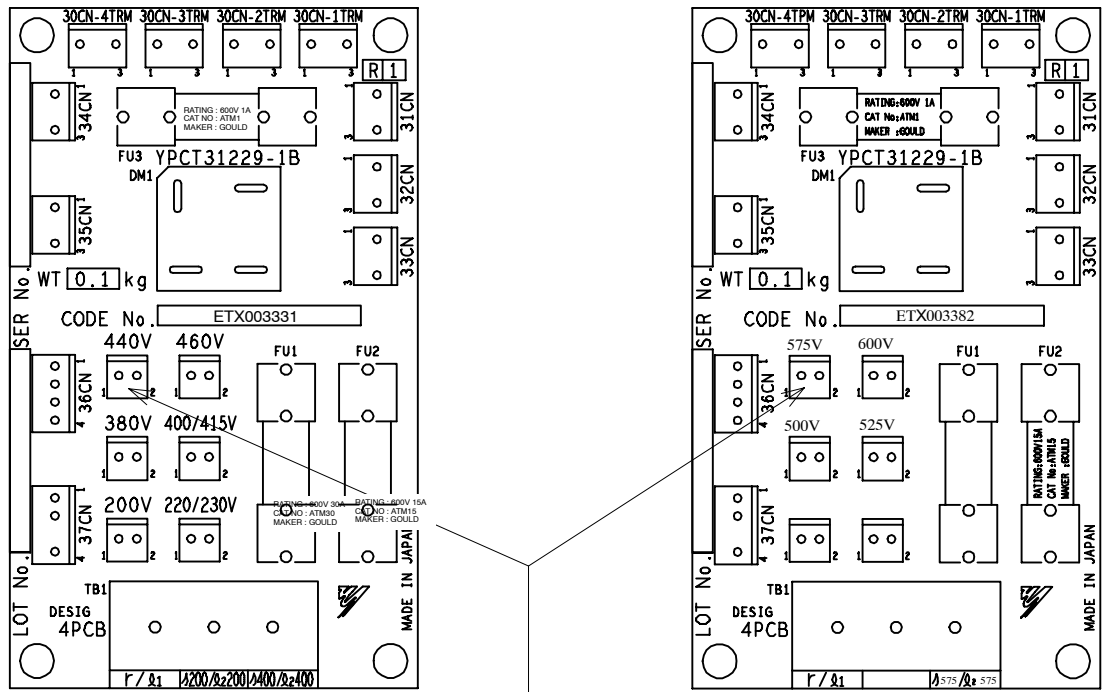

Fig 5.2 Selection of Control Power Supply Voltage for 400-V Class (400 kW, 600 kW, 800 kW) and 575-V Class (600 kW, 900 kW, 1200 kW) Inverter Panels

5



(a) 400-V Class Inverter Panel

(b) 575-V Class Inverter Panel

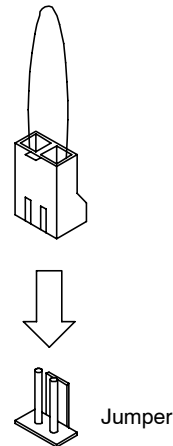

Fig 5.3 Selection of Control Power Supply Voltage

■ Motor Selection (Motor Overheating Protection): E1-02

Set the type of motor being used with the motor selection constant (E1-02). This setting is a reference for the motor overheat protection.

User Constant Number	Name	Change during Operation	Setting Range	Unit	Factory Setting	Valid Access Levels			
						V/f Control	V/f with PG	Open Loop Vector	Flux Vector
E1-02	Motor selection (motor overheating protection)	x	0, 1	-	0	Q	Q	Q	Q









• E1-02 Settings

Setting	Function
0	Standard motor (general-purpose motor)
1	Special motor (inverter-exclusive motor)

5.2.5 Autotuning

■ Autotuning Operation

Use the following procedure to autotune the motor constants, i.e., set them automatically.

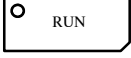
Step	Key Sequence	Digital Operator Display	Remarks
1		G5* Main Menu * Programming	Displays programming mode.
		G5* Main Menu* Auto-Tuning	Displays autotuning mode.
2		Rated Voltage 400.0 VAC	Displays the rated voltage.*
3		Rated Current 370 A	Displays the rated current.*
4		Rated Frequency 60.0 HZ	Displays the rated frequency.*
5		Rated Speed 1750 RPM	Displays the rated speed.*
6		Number of Poles 4	Displays the number of poles.*
7		Select Motor 1/2 1	Displays the motor selection. (Leave set at "1" for motor 1 (the normally used motor constants).)
8		Tuning Ready ? Press RUN key	Displays a confirmation prompt for the start of the autotuning function. (The lower line will blink.)
9		Tune Proceeding HZ A	Starts the autotuning function. (The upper line will blink.)





Step	Key Sequence	Digital Operator Display	Remarks
10		Tune Successful	Indicates the completion of autotuning.
		G5* Main Menu* Operation	Returns to the operation mode display.

* When the values displayed and the motor rated values differ, set each value separately.

Rated voltage for vector control motors is approx. 10 to 20% lower than general-purpose motors. Always verify motor voltage listed on the nameplate or test report before use.

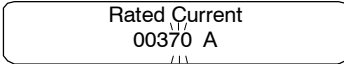
The following example procedure changes the motor rated current to 380 A.

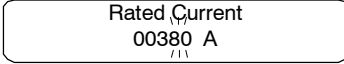
Step	Key Sequence	Digital Operator Display	Remarks
1		Rated Current 370 A	Displays the rated current.
		Rated Current 00370 A	When changing the set values, press the DATA/ENTER Key and the digit to change will blink.

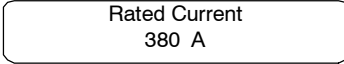
Step	Key Sequence	Digital Operator Display	Remarks
2	 Press 3 times		Select the digit to be changed.
3	 Press 3 times		Set to 00380 A.
4		 	Press the DATA/ENTER Key to overwrite the set values. "Entry Accepted" will be displayed for approximately 0.5 seconds. Returns to the rated current display.

- When autotuning has been executed correctly, the constants (E1-04 to E2-09) will be automatically written.
- Use the following troubleshooting procedure if a fault occurs during autotuning.

■ Troubleshooting Autotuning Faults

The displays and countermeasures for autotuning faults are shown below in *Table 5.1*. If one of these faults is detected, it will be displayed on the Operator and the motor will coast to a stop. The fault contact and alarm contact outputs will not function. When a fault occurs, "Tune Aborted" will be displayed and the messages shown in the following table will blink.

Table 5.1 Troubleshooting Autotuning Faults

Display Message	Fault	Description	Countermeasure
Data Invalid	Motor data fault	Motor data error for autotuning.	<ul style="list-style-type: none"> • Check the input data. • Check the Inverter and motor capacities.
Resistance	Line resistance fault	Autotuning was not completed within a set time.	<ul style="list-style-type: none"> • Check the input data. • Check the motor wiring.
No-load Current	No-load current fault		
Saturation -1	Saturated core coefficient 1 fault		
Saturation -2	Saturated core coefficient 2 fault		
Rated Slip	Rated slip fault		
Accelerate	Acceleration fault	The motor did not accelerate within a set time.	<ul style="list-style-type: none"> • Increase the acceleration time (C1-01). • Increase the torque limits (L7-01, -02) if these have been decreased. • Disconnect the motor from the machine if it has been connected.
PG Direction	Motor direction fault	There is a contact fault between the Inverter, PG (phase A and B), and motor (phases U, V, and W)	<ul style="list-style-type: none"> • Check the PG wiring. • Check the motor wiring. • Check the PG direction and constant F1-05.
Motor speed	Motor speed fault	The torque reference was too large (100%) during autotuning.	<ul style="list-style-type: none"> • Disconnect the motor from the machine if it has been connected. • Increase the acceleration time (C1-01). • Check the input data (particularly the number of PG pulses).
ALARM: Over Load (Displayed after completion of autotuning)	Tuning overload fault	The torque reference was over 20% during autotuning.	Check the input data (particularly the number of PG pulses) if the motor is being autotuned separately.
Tune Aborted Minor Fault:	Minor fault	A minor Inverter fault occurred.	Check the minor fault indicated in the boxes in the display shown at the left.
Tune Aborted V/f Over Setting (Displayed after completion of autotuning)	V/f Over Setting	Torque reference exceeded 100%, and no-load current exceeded 70%.	<ul style="list-style-type: none"> • Check the setting. • Disconnect the motor from the load.

- Fault displays can be cleared by pressing the MENU Key.

- All set constants (motor constants) will be initialized if a fault occurs. Reset the constants from the beginning when before starting autotuning again.

■ **Unsuccessful Autotuning**

When autotuning has not been executed correctly, “Tune Aborted” will be displayed. If this happens, input the motor constants (E1-04 to E2-09) obtained from Steinbetz’s constant. For input details, refer to Technical Document EZZ0007798.







5.2.6 No-load Operation

The section describes trial operation in which the motor is operated from the Digital Operator with the motor in the no-load state (with the motor not connected to the mechanical system).

■ **Setting the Frequency Reference**

Set the frequency reference on the frequency reference monitor in the operation mode.

The following is an operation example with the frequency reference set to 10 Hz.

Step	Key Sequence	Digital Operator Display	Remarks
1		G5* Main Menu* Operation	Displays operation mode.
		Frequency Ref U1-01 = 0.00 HZ	Puts the Unit in operation mode and displays the frequency reference.
2		Frequency Ref U1-01 = 0.00 HZ	Switches operation to the Digital Operator. (SEQ, REF and LED indicators turn OFF.)
3		Frequency Ref 000.00 HZ	Sets the frequency reference.
4		Frequency Ref 000.00HZ	The tens digit blinks.
5		Frequency Ref 010.00HZ	Set to 010.00 Hz.
6		Entry Accepted	The set values are overwritten.
		Frequency Ref 010.00 HZ	Returns to the frequency reference display.

■ **Operation Using the Digital Operator**

- Press the RUN Key. The motor will start to rotate. (forward rotation)
- Press the FWD/REV Key. The motor will rotate in the reverse direction.
- Press the Stop Key. The motor will stop. (The RUN Key indicator will keep blinking until the motor stops.)
- The frequency reference can be changed, even during operation. When this is done, the frequency reference is changed as soon as the DATA/ENTER Key is pressed to input the set values.
- If the Jog Key is pressed when the Inverter is stopped, it will rotate by the jog frequency (Factory setting: 6.0 Hz) only while the Key is being pressed.

■ **Checking the Operating Status**

- After changing the frequency reference or the rotation direction, check that there is no oscillation or abnormal sound from the motor.
- Check that no faults have occurred in the Inverter during operation.

5.2.7 Loaded Operation

After checking the operation under the no-load conditions, connect the load mechanical system and perform trial operation with an actual load.

■ **Connecting the Load System**

- After confirming that the motor has stopped completely, connect the mechanical system.

- Be sure to tighten all the screws when securing the motor shaft to the mechanical system.

■ Operation using the Digital Operator

- Use the Digital Operator in the same way as in no-load operation.
- If fault occurs during operation, make sure the STOP Key on the Digital Operator is easily accessible.
- At first, set the frequency reference to a low speed of one tenth the normal operating speed.

■ Checking Operating Status

- Having checked that the operating direction is correct and that the machine is operating smoothly at slow speed, increase the frequency reference.
- After changing the frequency reference or the rotation direction, check that there is no oscillation or abnormal sound from the motor. Check the monitor display to ensure that the U1-03 (output current) is not excessive.

6

Basic Operation

This chapter explains the basic settings required to operate and stop the VS-616G5. The user constants described here will be sufficient for simple Inverter.

Even when your application requires special functions, such as torque control or PID control, make these basic settings first and then go to the explanations of those special functions in chapter 7 *Advanced Operation*.

6.1	Common Settings	6 - 2
6.1.1	Setting the Access Level and Control Method: A1-01, A1-02	6 - 2
6.1.2	Frequency Reference Settings: b1-01, H3-01, H3-08, H3-09	6 - 4
6.1.3	Frequency Reference from Digital Operator: b1-01, o1-03, d1-01 to d1-09	6 - 7
6.1.4	Run Source and Sequence Input Responsiveness: b1-02, b1-06, b1-07	6 - 9
6.1.5	Acceleration/Deceleration Times: C1-01 through C1-08, C1-09, C1-10, C1-11	6 - 10
6.1.6	Prohibiting Reverse Operation: b1-04	6 - 11
6.1.7	Selecting the Stopping Method: b1-03	6 - 12
6.1.8	Multi-function Input Settings: H1-01 through H1-06	6 - 13
6.2	Open-loop Vector Control	6 - 18
6.2.1	Autotuning	6 - 18
6.2.2	Autotuning Faults	6 - 19
6.3	V/f Control	6 - 21
6.3.1	Setting the Motor Constants: E1-01, E1-02, E2-01	6 - 21
6.3.2	V/f Pattern Selection: E1-03	6 - 22
6.4	Flux Vector Control	6 - 26
6.4.1	PG Speed Control Card Settings	6 - 26
6.4.2	Setting the Zero-speed Operation Constants	6 - 29
6.4.3	Autotuning	6 - 31
6.4.4	Speed Control (ASR) Structure	6 - 33
6.4.5	Speed Control (ASR) Gain	6 - 36
6.5	V/f Control with PG	6 - 39
6.5.1	Motor Constants: E1-01, E1-02, E2-01, E2-04	6 - 39
6.5.2	V/f Pattern Selection: E1-03	6 - 40
6.5.3	PG Speed Control Card Settings	6 - 41
6.5.4	Speed Control (ASR) Structure	6 - 43
6.5.5	Adjusting Speed Control (ASR) Gain	6 - 44

6.1 Common Settings

This section describes the constants that are used with all of the control methods.

6.1.1 Setting the Access Level and Control Method: A1-01, A1-02

■ Constant Access Level: A1-01

- Select the constant access level. This level determines which constants can be accessed and changed.

User Constant Number	Name	Change during Operation	Setting Range	Unit	Factory Setting	Valid Access Levels			
						V/f Control	V/f with PG	Open Loop Vector	Flux Vector
A1-01	Constant access level	○	0 to 4	-	2 (Q)	Q	Q	Q	Q







- Access Level Settings

Setting	Name	Function
0	Operation Only	Allows the operation mode and initialize mode to be displayed or changed. Use this setting to prevent constant settings from being changed.
1	User Program	Allows only the user-selected constants (up to 32) to be displayed or changed. Set the desired constants as “User Parameters” in constants A2-01 through A2-32.
2	Quick-Start	Allows the constants required to start the Inverter (about 25) to be displayed or changed.
3	Basic	Allows the commonly used constants to be displayed or changed.
4	Advanced	Allows all constants to be displayed or changed.

- The control method setting also affects which constants can be displayed and changed. Refer to *Chapter 8 User Constant Lists*.
- The constants required for basic operation can be displayed and changed in the Basic level, but this section also describes constants that can be set only in the Advanced level, so set the access level to Advanced.

Changing the Access Level

The following procedure shows how to change from Quick-Start to Advanced.

Step	Key Sequence	Digital Operator Display	Remarks
1		G5* Main Menu * Operation	Displays operation mode.
2		G5* Main Menu * Initialize	Displays initialize mode.
3		Select Language English	Puts the Unit in initialize mode. (Select Language display)
4		Access Level Quick-Start	Displays the Access Level (A1-01).
5		A1-01 = 2 *** Quick-Start	Displays the constant setting for A1-01.
6	 Depress Twice.	A1-01 = 4 Advanced	Displays Advanced.
7		Entry Accepted	Writes the new setting.
		Access Level Advanced	Returns to the Access Level display.

■ Control Method: A1-02

- Select one of the four control methods.
- This constant is not initialized by the initialize operation.

User Constant Number	Name	Change during Operation	Setting Range	Unit	Factory Setting	Valid Access Levels			
						V/f Control	V/f with PG	Open Loop Vector	Flux Vector
A1-02	Control method selection	x	0 to 3	-	2 Open Loop Vector	Q	Q	Q	Q

- Control Method Settings

Setting	Control Method	Function
0	V/f control	Normal V/f control
1	V/f control with PG feedback	V/f control using a PG Speed Control Card
2	Open loop vector control	Vector control using the Inverter's internal speed information
3	Flux vector control	Vector control using a PG Speed Control Card

- The characteristics of each control method are shown in *Table 6.1*.

Table 6.1 Control Method Characteristics

Characteristic	V/f Control	V/f Control w/PG Feedback	Open Loop Vector	Flux Vector
Basic control method	Voltage/frequency control (open loop)	Voltage/frequency control with speed compensation	Current vector control without PG	Current vector control with PG
Speed detector	Not required	Required (pulse generator)	Not required	Required (pulse generator)
Optional speed detectors	Not required	PG-A2 or PG-D2	Not required	PG-B2 or PG-X2
Speed control range	1:40	1:40	1:100	1:1000
Starting torque	150%/3 Hz	150%/3 Hz	150%/1 Hz	150%/0 r/min
Speed control accuracy	± 2 to 3%	± 0.03%	± 0.2%	± 0.02%
Torque limit	Not possible	Not possible	Possible	Possible
Torque control	Not possible	Not possible	Not possible	Possible
Example applications	<ul style="list-style-type: none"> • Multiple motor drives. • Replacing existing motor for which motor constants are not known. • When autotuning is not possible. 	<ul style="list-style-type: none"> • Simple speed feedback control. • When a pulse generator is attached to the machine axis. 	<ul style="list-style-type: none"> • Variable speed drive applications. 	<ul style="list-style-type: none"> • Simple servo drives. • Precision speed control. • Torque control.

- Vector control has a greater starting torque and more precise speed control than V/f control, so use of vector control is recommended whenever possible.
Use V/f control in the following types of applications:
 - When several motors are being operated
 - When special motors, such as submersible motors or spindle motors, are being used (situations in which auto-tuning cannot be used)
 - When operation is being coordinated with an older V/f control inverter control system

6.1.2 Frequency Reference Settings: b1-01, H3-01, H3-08, H3-09

These settings are required when inputting analog voltage or current signals from the control circuit terminals.

■ Frequency Reference Selection: b1-01

- Constant b1-01 is used to select the reference source.

User Constant Number	Name	Change during Operation	Setting Range	Unit	Factory Setting	Valid Access Levels			
						V/f Control	V/f with PG	Open Loop Vector	Flux Vector
b1-01	Reference selection	X	0 to 3	-	1	Q	Q	Q	Q

- Settings

Setting	Reference source
0	Digital Operator
1	Control circuit terminals (analog inputs)
2	Transmission
3	Optional Card

- The frequency reference is input from the control circuit terminals (external terminals), so set b1-01 to 1.

■ Frequency Reference (Voltage), Terminal 36 Signal Level: H3-01

User Constant Number	Name	Change during Operation	Setting Range	Unit	Factory Setting	Valid Access Levels			
						V/f Control	V/f with PG	Open Loop Vector	Flux Vector
H3-01	Signal level selection (terminal 36)	X	0, 1	-	0	B	B	B	B

- The frequency reference (voltage) is valid when constant b1-01 has been set to 1.
- Set the voltage range for the frequency reference (voltage) signal.
- Settings

Setting	Function
0	0 to 10 VDC input [11-bit + polarity (positive/negative) input]
1	-10 to 10 VDC input (A negative voltage is a reference for reverse rotation.)

■ Frequency Reference (Current), Terminal 39 Signal Level: H3-09, H3-08

- Set terminal 39 to a frequency reference with constant H3-09 to use terminal 39 as the frequency reference terminal.
- The frequency reference setting is 1F.

Function Selection: H3-09

User Constant Number	Name	Change during Operation	Setting Range	Unit	Factory Setting	Valid Access Levels			
						V/f Control	V/f with PG	Open Loop Vector	Flux Vector
H3-09	Multi-function analog input (terminal 39)	X	1 to 1F	-	1F	A	A	A	A

- After setting constant H3-09, set terminal 39 signal level with H3-08.

Signal Level: H3-08

- The frequency reference (current) is valid when constant b1-01 has been set to 1.
- Set the signal level for the frequency reference (current).

User Constant Number	Name	Change during Operation	Setting Range	Unit	Factory Setting	Valid Access Levels			
						V/f Control	V/f with PG	Open Loop Vector	Flux Vector
H3-08	Signal level selection (terminal 39)	x	0 to 2	-	2	A	A	A	A

- Settings

Setting	Function
0	0 to 10 VDC input [10-bit input]
1	-10 to 10 VDC input (A negative voltage is a reference for reverse rotation.)
2	4 to 20 mA input

- When the terminal is being used as a voltage input terminal (setting 0 or 1), jumper J1 must be disconnected on the control board. (See Figure 6.1.) The terminal's input resistor will be destroyed if the terminal is used for a voltage input with jumper J1 connected.
- When frequency references are being input simultaneously from both the voltage terminal 36 and the current terminal 39, the final reference value will be the sum of the two references that are input.
- To switch the frequency reference input between the voltage terminal 36 and the current terminal 39, set a value of 1F in any one of the multi-function inputs (H1-01 through H1-06). The voltage terminal 36 will be used when this multi-function input is OFF and the current terminal 39 will be used when this multi-function input is ON.
- If a 0 to ± 10 VDC input is set, H3-01 must also be set to a 0 to ± 10 VDC input.

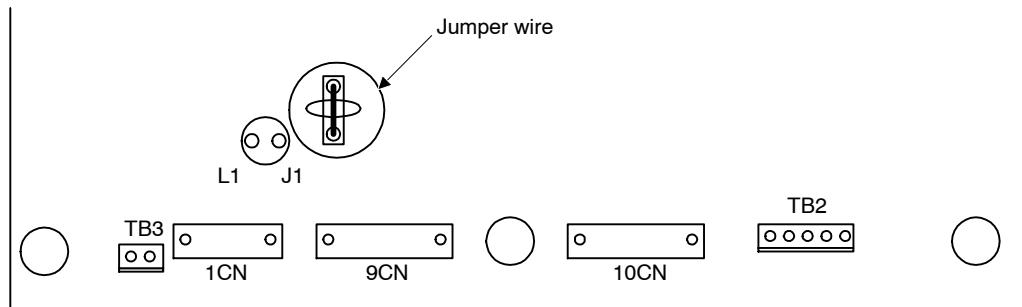

Fig 6.1 Jumper Wire Location on Control Board

Function and Signal Level for Multi-function Analog Input (Terminal 42): H3-04, H3-05

- This function is useful when switching between two analog inputs. The input is from terminal 42.
- When using the multi-function input (terminal 42) as the frequency reference terminal, first set the multi-function analog input function to "Auxiliary Reference" by setting constant H3-05 to 0.

Function for Multi-function Analog Input, Terminal 16: H3-05

User Constant Number	Name	Change during Operation	Setting Range	Unit	Factory Setting	Valid Access Levels			
						V/f Control	V/f with PG	Open Loop Vector	Flux Vector
H3-05	Multi-function analog input (terminal 42)	x	0 to 1F	-	0	B	B	B	B

- The auxiliary reference is factory-preset to 0.
- After setting H3-05 to 0, set any one of the multi-function inputs (H1-01 through H1-06) to a value of 3 (multi-step speed reference 1).
- When a multi-function analog input has been set to "Auxiliary Reference," it is treated as frequency reference 2 during multi-step speed operation, so it can't be used unless the multi-step speed reference 1 has been set.

Signal Level for Multi-function Analog Input, Terminal 42: H3-04

- Set the signal level for the multi-function analog input.

User Constant Number	Name	Change during Operation	Setting Range	Unit	Factory Setting	Valid Access Levels			
						V/f Control	V/f with PG	Open Loop Vector	Flux Vector
H3-04	Signal level selection (terminal 42)	x	0, 1	-	0	B	B	B	B

- Settings

Setting	Function
0	0 to 10 VDC input [11-bit + polarity (positive/negative) input]
1	-10 to 10 VDC input (A negative voltage is a reference for reverse rotation.)

■ Adjusting Analog Inputs: H3-02, H3-03, H3-06, H3-07, H3-10, H3-11, H3-12

- There are three constants used to adjust the analog inputs: The gain, bias (both set separately for each input), and filter time constant (a single value for all of the inputs).
 - The gain and bias can be adjusted separately for each analog input (terminals 36, 39, and 42).
 - Gain: Set the frequency corresponding to a 10 V (20 mA) input as a percentage of the maximum frequency. (The maximum output frequency set in E1-04 is 100%.)
 - Bias: Set the frequency corresponding to a 0 V (4 mA) input as a percentage of the maximum frequency. (The maximum output frequency set in E1-04 is 100%.)
 - Set the gains and biases for terminals 13, 14, and 16 as follows:

User Constant Number	Name	Change during Operation	Setting Range	Unit	Factory Setting	Valid Access Levels			
						V/f Control	V/f with PG	Open Loop Vector	Flux Vector
H3-02	Gain for terminal 36	○	0.0 to 1000.0	%	100.0	B	B	B	B
H3-03	Bias for terminal 36	○	-100.0 to 100.0	%	0.0	B	B	B	B
H3-10	Gain for terminal 39	○	0.0 to 1000.0	%	100.0	A	A	A	A
H3-11	Bias for terminal 39	○	-100.0 to 100.0	%	0.0	A	A	A	A
H3-06	Gain for terminal 42*	○	0.0 to 1000.0	%	100.0	B	B	B	B
H3-07	Bias for terminal 42*	○	-100.0 to 100.0	%	0.0	B	B	B	B

* The settings for terminal 42 are valid only when the multi-function analog input has been selected. The gain and bias set here will be disregarded if a frequency reference is selected and the values set for terminal 36 will be used.

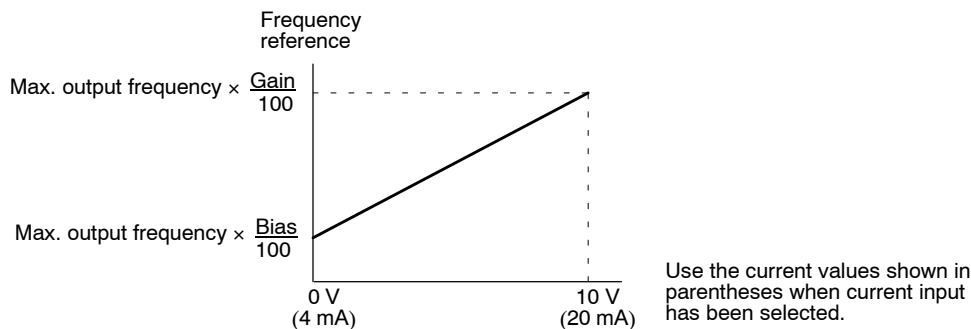

Fig 6.2 Gain and Bias Chart

6

Analog Input Filter Time Constant: H3-12

- A primary delay digital filter can be set for all three analog inputs (frequency reference (voltage), frequency reference (current), and multi-function analog input)

User Constant Number	Name	Change during Operation	Setting Range	Unit	Factory Setting	Valid Access Levels			
						V/f Control	V/f with PG	Open Loop Vector	Flux Vector
H3-12	Analog input filter time constant	X	0.00 to 2.00	s	0.00	A	A	A	A

- This setting is effective when there are sudden changes or noise in the analog input signal.
- Responsiveness decreases as the setting increases.

6.1.3 Frequency Reference from Digital Operator: b1-01, o1-03, d1-01 to d1-09**■ Frequency Reference Source: b1-01**

- Select the reference source.

User Constant Number	Name	Change during Operation	Setting Range	Unit	Factory Setting	Valid Access Levels			
						V/f Control	V/f with PG	Open Loop Vector	Flux Vector
b1-01	Reference selection	X	0 to 3	-	1	Q	Q	Q	Q

- Settings

Setting	Reference source
0	Digital Operator
1	Control circuit terminals (analog inputs)
2	Transmission
3	Optional Card

- The frequency reference is input from the Digital Operator, so set b1-01 to 0.

■ Frequency Unit for Reference Setting and Monitoring: o1-03

User Constant Number	Name	Change during Operation	Setting Range	Unit	Factory Setting	Valid Access Levels			
						V/f Control	V/f with PG	Open Loop Vector	Flux Vector
o1-03	Frequency unit for reference setting and monitor	X	0 to 39999	-	0	B	B	B	B

- Settings

Setting	Function
0	0.01 Hz units
1	0.01% units (The maximum frequency is 100%.)
2 to 39	r/min units (Set the number of poles.) r/min = 120 X frequency reference (Hz)/o1-03 (o1-03 sets the motor poles.)
40 to 39999	Decimal point is set according to the 5th digit value of o1-03. 5th digit = 0: Displays □□□□ 5th digit = 1: Displays □□□.□ 5th digit = 2: Displays □□.□□ 5th digit = 3: Displays □.□□□ Setting values of 100% frequency are set according to the first to fourth digits of o1-03 [Example 1] When the setting value (100% speed) is 200.0, o1-03 is set to 12000. When o1-03 is set to 12000, 100% speed displays 200.0. 60% speed displays 120.0. [Example 2] When the setting value (100% speed) is 65.00, o1-03 is set to 26500. When o1-03 is set to 26500, 60% speed displays 39.00.

6.1.3 Frequency Reference from Digital Operator: b1-01, o1-03, d1-01 to d1-09

- When the 40 to 39,999 range is used, any unit can be set for the reference frequency. For example, the frequency reference can be displayed or set in units such as mm/s or m/min to coincide with the linear operating speed of the machine.

■ Preset Frequency Reference Values: d1-01 through d1-09

User Constant Number	Name	Change during Operation	Setting Range	Unit	Factory Setting	Valid Access Levels			
						V/f Control	V/f with PG	Open Loop Vector	Flux Vector
d1-01	Frequency reference 1	○	0 to 150.00	o1-03	0.00 Hz	Q	Q	Q	Q
d1-02	Frequency reference 2	○	0 to 150.00	o1-03	0.00 Hz	Q	Q	Q	Q
d1-03	Frequency reference 3	○	0 to 150.00	o1-03	0.00 Hz	Q	Q	Q	Q
d1-04	Frequency reference 4	○	0 to 150.00	o1-03	0.00 Hz	Q	Q	Q	Q
d1-05	Frequency reference 5	○	0 to 150.00	o1-03	0.00 Hz	B	B	B	B
d1-06	Frequency reference 6	○	0 to 150.00	o1-03	0.00 Hz	B	B	B	B
d1-07	Frequency reference 7	○	0 to 150.00	o1-03	0.00 Hz	B	B	B	B
d1-08	Frequency reference 8	○	0 to 150.00	o1-03	0.00 Hz	B	B	B	B
d1-09	Jog frequency reference	○	0 to 150.00	o1-03	6.00 Hz	Q	Q	Q	Q

- The units for these values are set in o1-03.
- The frequency reference default value and set value will change when o1-03 is changed. For example, if preset reference 1 is set to 6.00 Hz and o1-03 is changed to 1 (0.01% units), the setting for preset reference 1 will become 10.00%.
- When using preset references 2 through 8, be sure to set multi-step speed references 1, 2, and 3 in the multi-function inputs (H1-01 through H1-06) as required.
- When using the jog function, set the jog frequency reference in constant d1-09. When jogging from an external terminal, set the multi-function inputs (H1-01 through H1-06) to “Jog Frequency Reference,” “Forward Jog,” or “Reverse Jog” as required.
- The multi-function input setting is unnecessary when jogging from the Operator.

6.1.4 Run Source and Sequence Input Responsiveness: b1-02, b1-06, b1-07

■ Run Source: b1-02

User Constant Number	Name	Change during Operation	Setting Range	Unit	Factory Setting	Valid Access Levels			
						V/f Control	V/f with PG	Open Loop Vector	Flux Vector
b1-02	Operation method selection	x	0 to 3	-	1	Q	Q	Q	Q

- Constant b1-02 is used to select the source of the run command.
- When a control circuit terminal (external terminal) is set, the Unit operates with 2-wire forward run/stop and reverse run/stop control. (When the Unit has been initialized for a 3-wire control or a multi-function input is set to 0 (3-wire sequence), the Unit operates with 3-wire run, stop and forward/reverse controls.)
- Settings

Setting	Run source
0	Digital Operator
1	Control circuit terminals (external terminals)
2	Transmission
3	Optional Card

■ Sequence Input Responsiveness (Reading Twice): b1-06

User Constant Number	Name	Change during Operation	Setting Range	Unit	Factory Setting	Valid Access Levels			
						V/f Control	V/f with PG	Open Loop Vector	Flux Vector
b1-06	Read sequence input twice	x	0, 1	-	1	A	A	A	A

- Set the responsiveness of the control inputs (forward/reverse run and multi-function inputs)
- Settings

Setting	Function
0	Two scans every 2 ms (Use when connecting transistor outputs.)
1	Two scans every 5 ms (Use when connecting contact outputs or switches.)

- Set the responsiveness to match the type of control inputs being used. Use a setting of 1 if there is one or more contact inputs.

■ Operation after Switching to Remote Mode: b1-07

User Constant Number	Name	Change during Operation	Setting Range	Unit	Factory Setting	Valid Access Levels			
						V/f Control	V/f with PG	Open Loop Vector	Flux Vector
b1-07	Operation selection after switching to remote mode	x	0, 1	-	0	A	A	A	A

- Set the interlock operation to be used after switching from local mode (operation from Digital Operator) to remote mode (operation according to control circuit terminal).
- Settings

Setting	Function
0	No operation even if RUN signal is ON after switching to remote mode. (Operation will start if the RUN signal turns OFF and then back ON after switching to remote mode.)
1	Operate according to the RUN signal after switching to remote mode.

6.1.5 Acceleration/Deceleration Times: C1-01 through C1-08, C1-09, C1-10, C1-11

This section describes setting the acceleration times, deceleration times, and emergency stop time.

■ Acceleration/Deceleration Time Unit: C1-10

User Constant Number	Name	Change during Operation	Setting Range	Unit	Factory Setting	Valid Access Levels			
						V/f Control	V/f with PG	Open Loop Vector	Flux Vector
C1-10	Accel/decel time setting unit	X	0, 1	-	1	A	A	A	A

- Settings

Setting	Function
0	Sets the acceleration/deceleration time unit to 0.01 seconds.
1	Sets the acceleration/deceleration time unit to 0.1 seconds.

- Set “0” to set more precise acceleration and deceleration times. (This will reduce the setting range.)

■ Acceleration/Deceleration Times: C1-01 through C1-08

- Set individual acceleration and deceleration times.
 - An acceleration time is the time required to go from 0% to 100% of the maximum output frequency.
 - A deceleration time is the time required to go from 100% to 0% of the maximum output frequency.
- Four acceleration times and four deceleration times can be set. When using acceleration/deceleration times 2 through 4, set multi-function inputs (H1-01 through H1-06) to the acceleration/deceleration time selectors 1 and 2.

User Constant Number	Name	Change during Operation	Setting Range	Unit	Factory Setting	Valid Access Levels			
						V/f Control	V/f with PG	Open Loop Vector	Flux Vector
C1-01	Acceleration time 1	○	0.0 to 6000.0	s	10.0	Q	Q	Q	Q
C1-02	Deceleration time 1	○	0.0 to 6000.0	s	10.0	Q	Q	Q	Q
C1-03	Acceleration time 2	○	0.0 to 6000.0	s	10.0	B	B	B	B
C1-04	Deceleration time 2	○	0.0 to 6000.0	s	10.0	B	B	B	B
C1-05	Acceleration time 3	X	0.0 to 6000.0	s	10.0	A	A	A	A
C1-06	Deceleration time 3	X	0.0 to 6000.0	s	10.0	A	A	A	A
C1-07	Acceleration time 4	X	0.0 to 6000.0	s	10.0	A	A	A	A
C1-08	Deceleration time 4	X	0.0 to 6000.0	s	10.0	A	A	A	A

- The setting range for the acceleration/deceleration times depends on the setting in C1-10 (acceleration/deceleration time unit). The table shows the setting range when the factory setting is used for C1-10.
- If C1-10 is set to “0” (0.01 s) the setting range will be 0.00 to 600.00 s.

■ Emergency Stop Time: C1-09

- Sets the deceleration time that will be used when an emergency stop signal is input or a fault is detected. The deceleration time is the time required to go from 100% to 0% of the maximum output frequency.
- When using an emergency stop input, set a multi-function input (H1-01 through H1-06) to for an emergency stop.
- The emergency stop time is effective for the following faults. Set a stopping method for each.
 - Inverter overheating (OH) pre-alarm: Set in L8-03.
 - Pulse generator faults: Set in F1-02 through F1-04.

User Constant Number	Name	Change during Operation	Setting Range	Unit	Factory Setting	Valid Access Levels			
						V/f Control	V/f with PG	Open Loop Vector	Flux Vector
C1-09	Emergency stop time	○	0.0 to 6000.0	s	10.0	B	B	B	B

- The setting range for the emergency stop deceleration time depends upon the setting in C1-10 (acceleration/deceleration time unit). The table shows the setting range when the factory setting is used for C1-10.
- If C1-10 is set to "0" (0.01 s) the setting range will be 0.00 to 600.00 s.

■ Acceleration/Deceleration Time Switching Frequency: C1-11

- When an acceleration/deceleration time switching frequency is set, the acceleration and deceleration times will be changed automatically as the frequency passes the set level.
- If the acceleration/deceleration time selectors 1 and 2 are input via the multi-function inputs, they will have priority.

User Constant Number	Name	Change during Operation	Setting Range	Unit	Factory Setting	Valid Access Levels			
						V/f Control	V/f with PG	Open Loop Vector	Flux Vector
C1-11	Accel/decel time switching frequency	x	0.0 to 150.0	Hz	0.0	A	A	A	A

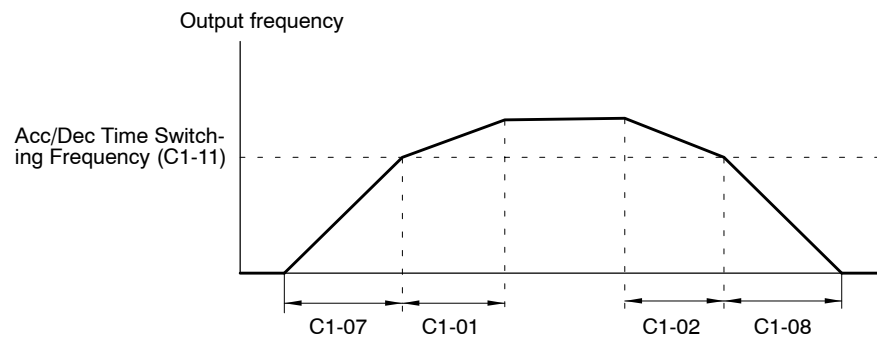

Acceleration/Deceleration Times 1 (C1-01 and C1-02) are used when the output frequency \geq C1-11
Acceleration/Deceleration Times 4 (C1-07 and C1-08) are used when the output frequency $<$ C1-11

Fig 6.3 Acceleration/Deceleration Time Switching Frequency

6.1.6 Prohibiting Reverse Operation: b1-04

- Set whether or not to operate the motor in reverse when a reverse reference is input.
- Set this constant to "1" to disable reverse operation when necessary.

User Constant Number	Name	Change during Operation	Setting Range	Unit	Factory Setting	Valid Access Levels			
						V/f Control	V/f with PG	Open Loop Vector	Flux Vector
b1-04	Prohibition of reverse operation	x	0, 1	-	0	B	B	B	B

- Settings

Setting	Function
0	Allows reverse operation.
1	Prohibits reverse operation.

6.1.7 Selecting the Stopping Method: b1-03

- Set the stopping method used when a stop command is input.

User Constant Number	Name	Change during Operation	Setting Range	Unit	Factory Setting	Valid Access Levels			
						V/f Control	V/f with PG	Open Loop Vector	Flux Vector
b1-03	Stopping method selection	x	0 to 3	-	0	Q	Q	Q	Q

- Only settings 0 and 1 can be used with flux vector control.
- Settings

Setting	Function
0	Deceleration to stop
1	Coast to stop
2	DC braking stop: Stops faster than coast to stop, without regenerative operation.
3	Coast to stop with timer: Run commands are disregarded during deceleration time.

- The following diagrams show the operation of each stopping method.
 - Deceleration to Stop (b1-03 = 0)

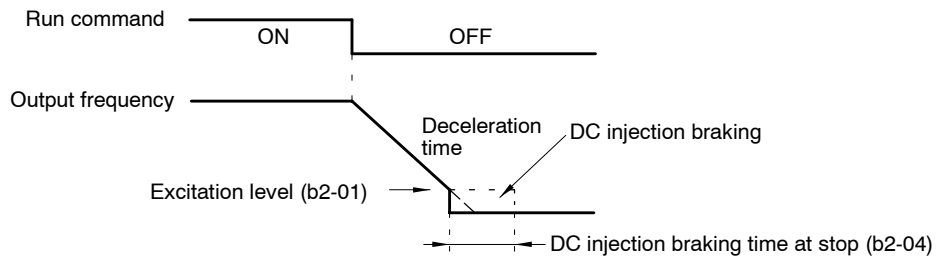

Decelerates to a stop at a rate set with the selected deceleration time.

Fig 6.4 Deceleration to Stop

6

- Coast to Stop (b1-03 = 1)

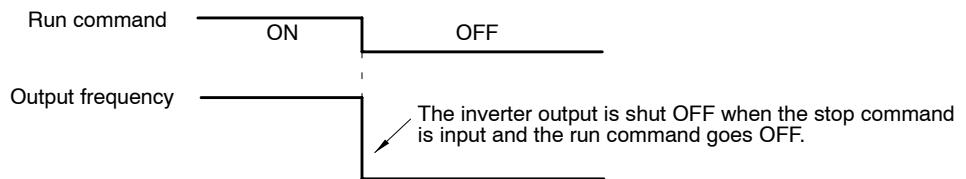

After the stop command is input, run commands are disregarded until the minimum baseblock time (L2-03) has elapsed.

Fig 6.5 Coast to Stop

- DC Injection Braking Stop (b1-03 = 2)

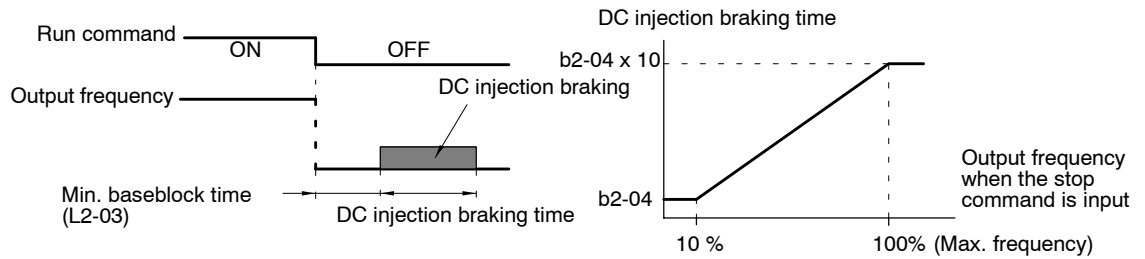

After the stop command is input and the minimum baseblock time (L2-03) has elapsed, DC injection braking is applied and the motor stopped. The DC injection braking time depends upon the output frequency when the stop command is input and the "DC injection braking time at stop" setting in b2-04, as shown in Figure 6.6.

Fig 6.6 DC Injection Braking Stop

IMPORTANT

Lengthen the minimum baseblock time (L2-03) when an overcurrent (OC) occurs during stopping. When the power to an induction motor is turned OFF, the counter-electromotive force generated by the residual magnetic field in the motor can cause an overcurrent to be detected when DC injection braking is applied.

- Coast to Stop with Timer (b1-03 = 3)

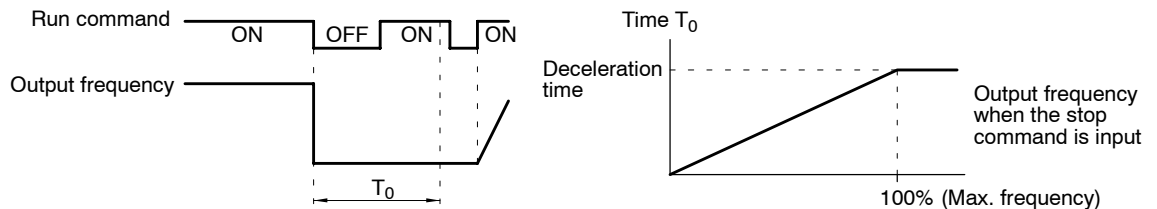

After the stop command is input, run commands are disregarded until the time T_0 has elapsed. The time T_0 depends upon the output frequency when the stop command is input and the deceleration time.

Fig 6.7 Coast to Stop with Timer

6.1.8 Multi-function Input Settings: H1-01 through H1-06

- Set the functions for terminals 11 to 16. Set the functions of the multi-function inputs according to the application.

User Constant Number	Name	Change during Operation	Setting Range	Unit	Factory Setting	Valid Access Levels			
						V/f Control	V/f with PG	Open Loop Vector	Flux Vector
H1-01	Multi-function input 1 (terminal 11)	x	0 to 77	-	24	B	B	B	B
H1-02	Multi-function input 2 (terminal 12)	x	0 to 77	-	14	B	B	B	B
H1-03	Multi-function input 3 (terminal 13)	x	0 to 77	-	3 (0)	B	B	B	B
H1-04	Multi-function input 4 (terminal 14)	x	0 to 77	-	4 (3)	B	B	B	B
H1-05	Multi-function input 5 (terminal 15)	x	0 to 77	-	6 (4)	B	B	B	B
H1-06	Multi-function input 6 (terminal 16)	x	0 to 77	-	8 (6)	B	B	B	B

- The default settings in parentheses are the default values when the Unit is initialized for 3-wire sequence control.

- The constant settings that are used most often are explained below. Refer to chapter 7 *Advanced Operation* or the constant tables for details on the other settings.
 - 3-wire sequence (forward/reverse run command): Set “0”
 - Multi-step speed references 1 to 3 and jog command: Set “3” to “6”
 - Acceleration/Deceleration Time Selectors 1 and 2: Set “7” and “1A”
 - Emergency Stop: Set “15”
 - FORWARD and REVERSE JOG References: Set “12” and “13”
 - Terminal 36/39 Switch: Set “1F”

■ **3-wire Sequence (Forward/Reverse Run Commands): “0”**

- When a value of “0” is set for any one of the multi-function inputs (H1-01 through H1-06), 3-wire sequence control is used and the multi-function input terminal for which “0” was set becomes the forward/reverse run command terminal.
- When the Unit is initialized for 3-wire sequence control with A1-03, multi-function input 3 (terminal 13) becomes the input terminal for the forward/reverse run command.

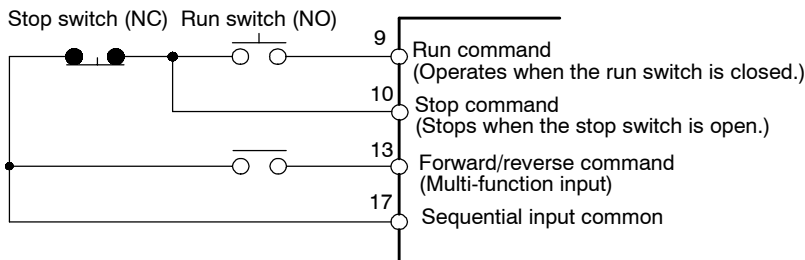

Fig 6.8 3-wire Sequence Wiring Example

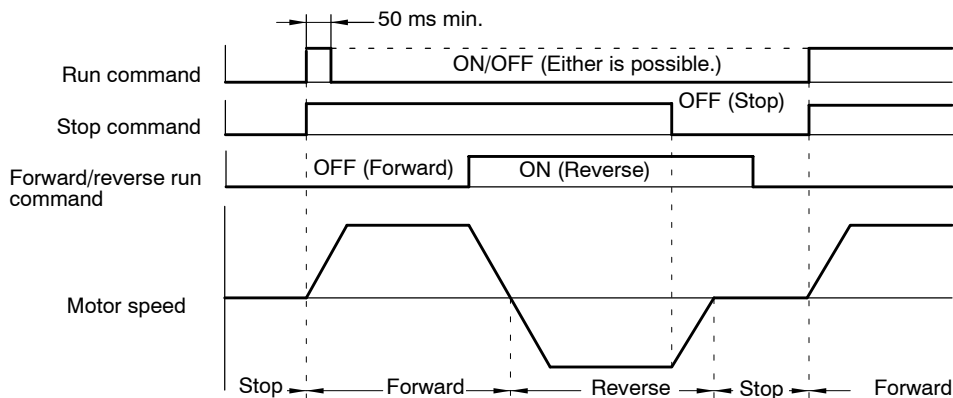

Fig 6.9 Timing Chart for 3-wire Sequence

■ **Multi-step Speed References 1 through 3 and JOG Reference: “3” to “6”**

- Eight frequency references and one jog frequency reference can be used.
- Set the multi-step speed references 1, 2, and 3 and the JOG reference for the multi-function inputs, and change the status of these inputs to switch between the 9 frequency references.

Terminal	Constant	Setting	Function
13	H1-03	3	Multi-step speed reference 1 (Also used for master-speed/auxiliary-speed switching when an auxiliary reference is set for the multi-function analog input in H3-05.)
14	H1-04	4	Multi-step speed reference 2
15	H1-05	5	Multi-step speed reference 3
16	H1-06	6	JOG reference (This setting has higher priority than the multi-step speed reference.)

- The following table shows which frequency is selected by each possible combination of multi-step speed and JOG reference settings.

Terminal 13 Multi-step speed reference 1	Terminal 14 Multi-step speed reference 2	Terminal 15 Multi-step speed reference 3	Terminal 16 JOG reference	Selected frequency
OFF	OFF	OFF	OFF	Reference 1: d1-01 (master speed frequency)
ON	OFF	OFF	OFF	Reference 2: d1-02 (auxiliary speed frequency)
OFF	ON	OFF	OFF	Reference 3: d1-03
ON	ON	OFF	OFF	Reference 4: d1-04
OFF	OFF	ON	OFF	Reference 5: d1-05
ON	OFF	ON	OFF	Reference 6: d1-06
OFF	ON	ON	OFF	Reference 7: d1-07
ON	ON	ON	OFF	Reference 8: d1-08
-	-	-	ON	Jog frequency: d1-09

Selecting 1-step and 2-step Frequency References

- To use the master frequency (analog terminal 36 or 39), set b1-01 to 1.
- To use frequency reference 1 (d1-01), set b1-01 to 0.
- To use the auxiliary frequency reference (analog terminal 42), use the factory setting.
- To use frequency reference 2 (d1-02), set H3-05 to 1F.

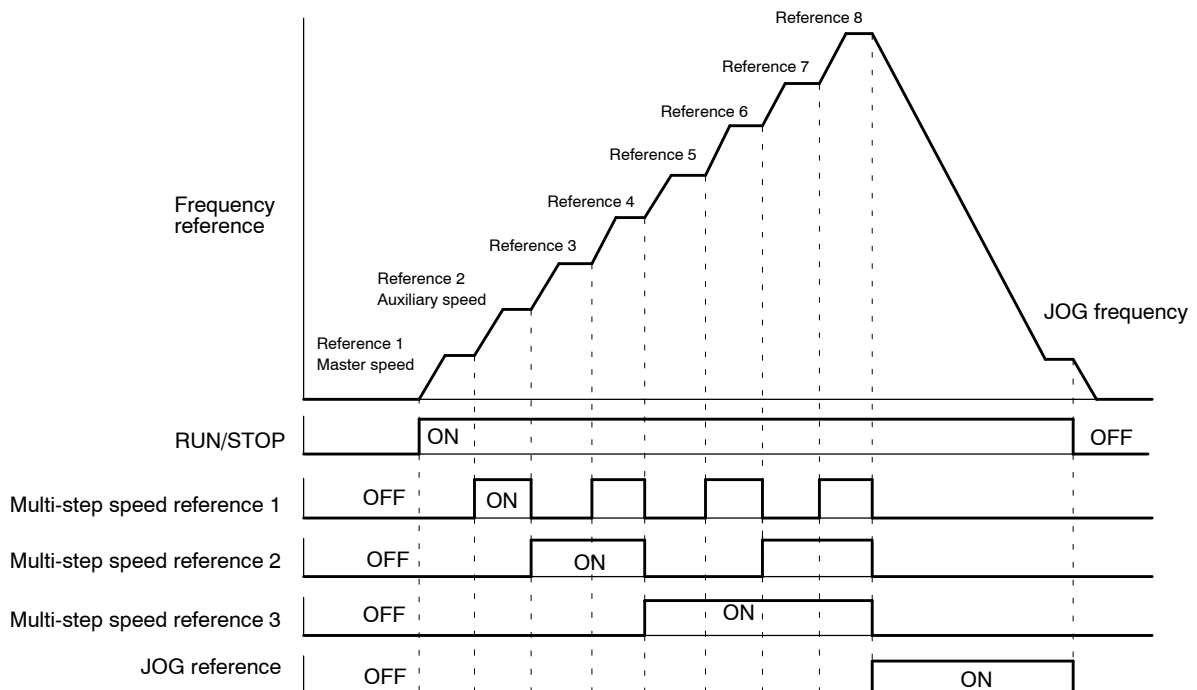
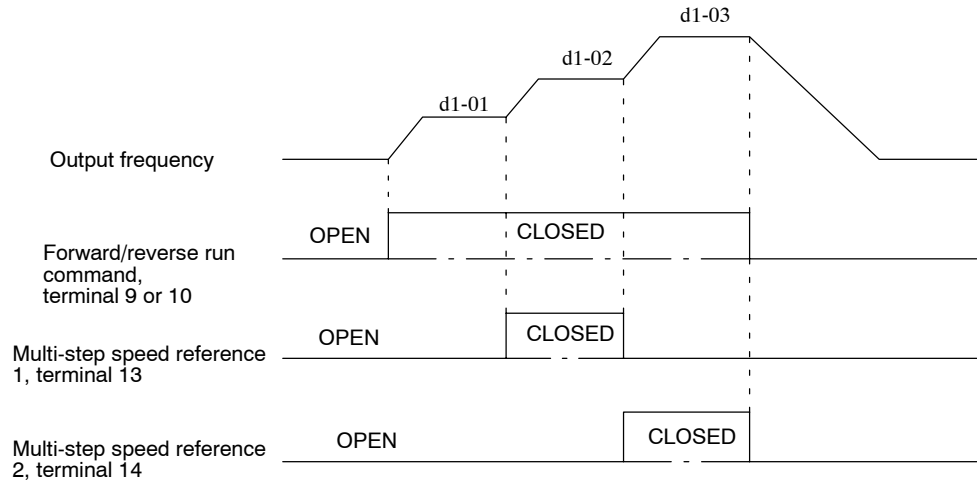

Fig 6.10 Timing Chart for Multi-step Speed and JOG References

Three-step Speed Operation Example

The following example shows three-step speed operation with frequencies set at Inverter constants.

- Sequence



- Connections

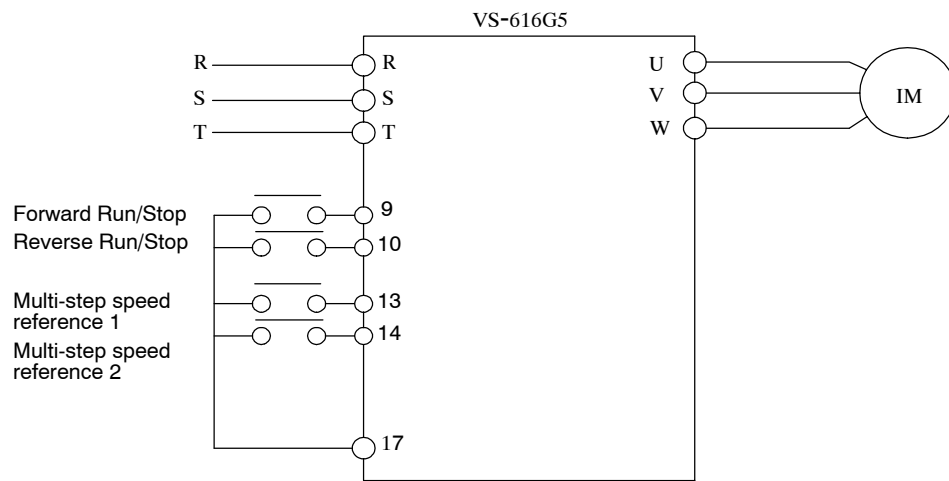

- User Constant Settings

Constant No.	Name	Setting
A1-01	Constant access level	3: Basic (B)
b1-01	Reference selection	0: Operator
d1-01	Frequency reference 1	**Hz (frequency setting)
d1-02	Frequency reference 2	**Hz (frequency setting)
d1-03	Frequency reference 3	**Hz (frequency setting)
H1-03	Multi-function input (terminal 13)	3: Multi-step speed reference 1 (factory setting)
H1-04	Multi-function input (terminal 14)	4: Multi-step speed reference 2 (factory setting)
H3-05	Multi-function input (terminal 42)	1F: Not used

Terminal 14 would not be needed if 2-step speed operation were required.

■ Acceleration/Deceleration Time Selectors 1 and 2: “7” and “1A”

- Four acceleration times and four deceleration times can be set. The multi-function inputs can be set as acceleration/deceleration time selectors 1 and 2 to switch between these acceleration and deceleration times.

Setting	Function
7	Acceleration/Deceleration time selector 1
1A	Acceleration/Deceleration time selector 2

- The following table shows which acceleration and deceleration times are selected by each possible combination of acceleration/deceleration time selectors 1 and 2. The acceleration and deceleration times can be changed while the Inverter is operating.

Accel/Decel Time Selector 1	Accel/Decel Time Selector 2	Acceleration Time	Deceleration Time
OFF or not set	OFF or not set	Acceleration time 1 (C1-01)	Deceleration time 1 (C1-02)
ON	OFF or not set	Acceleration time 2 (C1-03)	Deceleration time 2 (C1-04)
OFF or not set	ON	Acceleration time 3 (C1-05)	Deceleration time 3 (C1-06)
ON	ON	Acceleration time 4 (C1-07)	Deceleration time 4 (C1-08)

■ Emergency Stop: “15”

- When the multi-function input that is set as an emergency stop is turned ON, the motor will decelerate to a stop at the rate set with the deceleration time in C1-09 (emergency stop time).
- To clear the emergency stop, turn OFF the run command, turn OFF the emergency stop input, and then turn ON the run command again.

■ Forward and Reverse Jog Commands: “12” and “13”

The jogging can be performed in forward or reverse.

Setting	Function
12	Forward jog command: Runs forward at the jog frequency (d1-09).
13	Reverse jog command: Runs in reverse at the jog frequency (d1-09).

- The forward jog and reverse jog commands have priority over other frequency reference commands.
- The inverter will stop operation with the stopping method set in b1-03 if the forward jog and reverse jog commands are both ON for more than 500 ms.
- Turn ON either the forward jog command or the reverse jog command, not both.
- These jog commands can operate the Inverter independently. It isn't necessary for a forward/reverse run command to be input.

■ Terminal 36/39 Switch: “1F”

- When this function is set for a multi-function input, that input terminal can be used to switch between terminal 36 and terminal 39.

OFF	The analog input from terminal 36 is used as the master-speed frequency reference.
ON	The analog input from terminal 39 is used as the master speed frequency reference.

- When terminal 39 is used as the frequency reference, set “1F” (frequency reference) in constant H3-09; this constant is the function selector for frequency reference (current) terminal 39. A setting fault (OPE03) will occur if this function is selected without setting “1F” in H3-09.
- When H3-09 is set to “1F” (frequency reference) but none of the multi-function inputs is set to “1F” (terminal 36/39 switch), the sum of the inputs from terminals 36 and 39 will be used as the master-speed frequency reference.

6.2 Open-loop Vector Control

Open-loop vector control is vector control without a pulse generator input. Autotuning is the only setting for basic operation with open-loop vector control.

Always perform autotuning for motor unit separately before vector control operation.

To operate with the greatest speed precision near the rated speed, select a motor with a rated voltage that is at least 40 V below the Inverter's input power supply voltage for 400-V Class Inverters and 60 V below for 575-V Class Inverters. When the input voltage is the same as the rated voltage, the voltage limit may be applied and vector control won't be established.

6.2.1 Autotuning

CAUTION

- Do not connect a load to the motor when performing autotuning. Doing so may result in personal injury or equipment damage.

When motor cannot be disconnected from the load, motor constants can be set by calculation. Contact your YASKAWA representatives for details.

■ Precautions before Autotuning

- The Inverter's autotuning function automatically determines the motor constants while a servo system's autotuning function determines the size of a load, so these autotuning functions are fundamentally different.
- If a load is connected when autotuning is performed, not only will incorrect motor constants be recorded, but the motor may operate erratically or unexpectedly. Disconnect the load before autotuning.
- The motor shaft will rotate when autotuning is performed. Confirm safety before starting autotuning.
- When motor cannot be disconnected from the load, motor constants can be set by calculation. Contact your YASKAWA representatives for details.

■ Inverter Input Voltage Setting: E1-01

- Set the Inverter input voltage (E1-01) to match the power supply voltage.

User Constant Number	Name	Change during Operation	Setting Range	Unit	Factory Setting	Valid Access Levels			
						V/f Control	V/f with PG	Open Loop Vector	Flux Vector
E1-01	Input voltage setting	x	360 to 460(460 to 690)	VAC	400 (600)	Q	Q	Q	Q

- The voltage settings shown in parentheses are the values for the 575-V class. This setting is used as the reference value for functions such as the protection functions.

■ Required Constant Settings

- Enter autotuning mode and make the following constant settings:
 - Rated Voltage
Set the rated voltage (VAC) shown on the motor nameplate.
 - Rated Current
Set the rated current (A) shown on the motor nameplate.
 - Rated Frequency
Set the rated frequency (Hz) shown on the motor nameplate.
 - Rated Speed
Set the rated speed (r/min) shown on the motor nameplate.
 - Number of Poles
Set the number of poles.
 - Motor Selection
Select motor 1 or motor 2. (Normally select motor 1.)
- The following message will appear when the constants have been set:

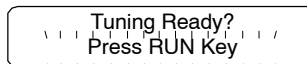

The "Press RUN Key" message will blink.

3. At this point, it is still possible to change the constant settings by pressing the Increment and Decrement Keys to display the desired constant.
4. Press the STOP Key to cancel autotuning, and then press the MENU Key and DATA/ENTER Key. The operation mode display will appear.
 - * Rated voltage for vector control motors is approx. 10 to 20% lower than general-purpose motors. Always verify motor voltage listed on the nameplate or test report before use.

■ Performing Autotuning

- Autotuning will start if the RUN Key is pressed when the “Tuning Ready?” message is being displayed.
- The motor will operate during autotuning, so be sure that it is safe for the motor to operate before pressing the RUN Key.
- The following message will be displayed when the RUN Key is pressed:

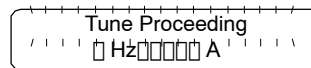

The “Tune Proceeding” message will blink.

- Autotuning takes up to 1.5 minutes. The message “Tune Successful” will be displayed when autotuning has been completed.
- If autotuning has been completed successfully, press the MENU Key and proceed to the next operation.
- If a fault occurred during autotuning, refer to 6.2.2 *Autotuning Faults* for details on correcting the cause of the fault and perform autotuning again.

6.2.2 Autotuning Faults

- One of the fault messages in the following table will be displayed if a fault occurs during autotuning and the motor will stop. In this case, determine the cause of the fault, correct it, and perform autotuning again.
- The fault display can be cleared by pressing the MENU Key.
- The motor constants will revert to their default settings if a fault occurs. Set these constants again before starting autotuning again.

Table 6.2 Troubleshooting Autotuning Faults for Open-loop Vector Control

Fault Display	Probable Cause		Remedy
Data Invalid (Motor data fault)	There was a fault in the data set during autotuning.	There was a fault in the relationship between the rated frequency, rated speed, and number of poles.	Change the settings to conform to the following equation: Rated speed < 120 × Motor frequency/Number of poles
ALARM: Over Load (Excessive tuning load)	The effective load factor exceeded 20% during autotuning.	A load is connected to the motor.	Remove the load.
		There was a setting fault during autotuning.	Check the rated current setting. Change if necessary.
Motor speed (Motor speed fault)	The torque reference value exceeded 100% during autotuning.	There is a motor bearing problem.	Turn the Inverter off and rotate the motor by hand. Replace the motor if it doesn't turn smoothly.
		There is a broken/disconnected motor power wire.	Check and replace wiring components if necessary.
Accelerate (Acceleration fault)	The motor doesn't accelerate within the prescribed time.	A load is connected to the motor.	Remove the load.
		The torque limit function is operating.	Initialize the torque limit constants (H7-01 to H7-04).
		The acceleration time is too short.	Increase acceleration time 1 (C1-01).
Rated Slip (Rated slip fault)	The rated slip setting can't be tuned within the prescribed time.	A load is connected to the motor.	Remove the load.

Basic Operation

6.2.2 Autotuning Faults

Fault Display	Probable Cause		Remedy
Saturation -1 (Iron core saturation coefficient 1 fault)	The core-saturation coefficients can't be tuned within the prescribed time.	The rated current setting isn't correct.	Check and change the setting if necessary.
Saturation -2 (Iron core saturation coefficient 2 fault)		There is a broken/disconnected motor power wire.	Check and replace wiring components if necessary.
Resistance (Line-to-line resistance fault)	The motor terminal resistance or no-load current setting can't be tuned within the prescribed time.	The rated current setting isn't correct.	Check and change the setting if necessary.
No-load Current (No-load current fault)		There is a broken/disconnected motor power wire.	Check and replace wiring components if necessary.
Tune Aborted Minor Fault: □□□	---	A minor Inverter fault occurred.	Check the minor fault indicated in the boxes in the display shown at the left.
Tune Aborted V/f Over Setting (Displayed after the completion of autotuning)	Torque reference exceeded 100%, and no-load current exceeded 70%.	Rated voltage and rated frequency settings are not correct.	Check the setting and correct any problems.
		The load is connected to the motor.	Disconnect the motor from the load..

6.3 V/f Control

With V/f control, the user must set the Inverter input voltage, motor selection, rated current, and V/f pattern.

6.3.1 Setting the Motor Constants: E1-01, E1-02, E2-01

■ Inverter Input Voltage: E1-01

- Set the Inverter input voltage (E1-01) to match the power supply voltage.

User Constant Number	Name	Change during Operation	Setting Range	Unit	Factory Setting	Valid Access Levels			
						V/f Control	V/f with PG	Open Loop Vector	Flux Vector
E1-01	Input voltage setting	x	360 to 460 (460 to 690)	VAC	400 (600)	Q	Q	Q	Q

- The voltage settings shown in parentheses are for 575-V class Inverters.
- This setting is used as a reference value for functions such as the protection functions.

■ Motor Selection and Rated Current: E1-02, E2-01

Motor Selection (Motor Overheating Protection): E1-02

- Set the type of motor being used. This setting is a reference for overheating protection functions.

User Constant Number	Name	Change during Operation	Setting Range	Unit	Factory Setting	Valid Access Levels			
						V/f Control	V/f with PG	Open Loop Vector	Flux Vector
E1-02	Motor selection (motor overheating protection)	x	0, 1	-	0	Q	Q	Q	Q

- Settings

Setting	Function
0	Standard motor (general-purpose motor)
1	Special motor (inverter-exclusive motor)

Motor Rated Current (Electronic Thermal Reference Current): E2-01

- Set the rated current (A) shown on the motor nameplate.

User Constant Number	Name	Change during Operation	Setting Range	Unit	Factory Setting	Valid Access Levels			
						V/f Control	V/f with PG	Open Loop Vector	Flux Vector
E2-01	Motor rated current (electronic thermal reference current)	x	10% to 200% (of rated current)*1	A	*2	Q	Q	Q	Q

* 1. The setting range is 10) to 200% of the Inverter rated output current.

* 2. The factory setting depends upon the Inverter capacity. Refer to pages 8 - 42.

6.3.2 V/f Pattern Selection: E1-03

User Constant Number	Name	Change during Operation	Setting Range	Unit	Factory Setting	Valid Access Levels			
						V/f Control	V/f with PG	Open Loop Vector	Flux Vector
E1-03	V/f pattern selection	x	0 to F	-	F	Q	Q	x	x

- The V/f pattern can be set to any of the following:
 - One of 15 preset patterns (settings 0 through E)
 - A custom user-set pattern (setting F)
- The factory setting for E1-03 is “F” (user-defined V/f pattern), but the default contents of this setting are the same as setting “1.”

■ Selecting a Preset V/f Pattern: E1-03 = “0” through “E”

- Refer to the following table to set one of the 15 preset patterns.

Characteristics	Applications	Setting	Specifications
Fixed torque	These patterns are for general-purpose applications. Use these patterns when the load torque is to remain constant for any rotational speed, such as in straight-line conveyors.	0	50 Hz
		1	60 Hz
		2	60 Hz, Voltage saturation at 50 Hz
		3	72 Hz, Voltage saturation at 60 Hz
Variable torque	Use these patterns when there is a quadratic or cubic relationship between the rotational speed and load, such as in fans or pumps.	4	50 Hz, cubic
		5	50 Hz, quadratic
		6	60 Hz, cubic
		7	60 Hz, quadratic
High starting torque*	Select a high starting torque V/f pattern only in the following cases: <ul style="list-style-type: none"> • The wiring distance between the Inverter and motor is relatively large (greater than 150 m). • A large torque is required at startup (such as for heavy axis loads). • An AC or DC reactor is connected to the Inverter’s input or output. • A motor less than the maximum applicable motor is being used. 	8	50 Hz, low starting torque
		9	50 Hz, high starting torque
		A	60 Hz, low starting torque
		b	60 Hz, high starting torque
High-speed operation	These patterns are for applications that must rotate at frequencies greater than 60 Hz. A fixed voltage is applied at frequencies greater than 60 Hz.	C	90 Hz, Voltage saturation at 60 Hz
		d	120 Hz, Voltage saturation at 60 Hz
		E	150 Hz, Voltage saturation at 60 Hz

* Normally it isn’t necessary to use these patterns because starting torque is ensured by automatic torque boost functions.

- The constant settings for E1-04 through E1-10 will be changed automatically when one of these patterns is selected.
- The characteristics for these patterns are shown in the diagrams on the following page.

V/f Patterns: 200 to 1200 kW

- Fixed Torque Characteristics (Settings 0 to 3)

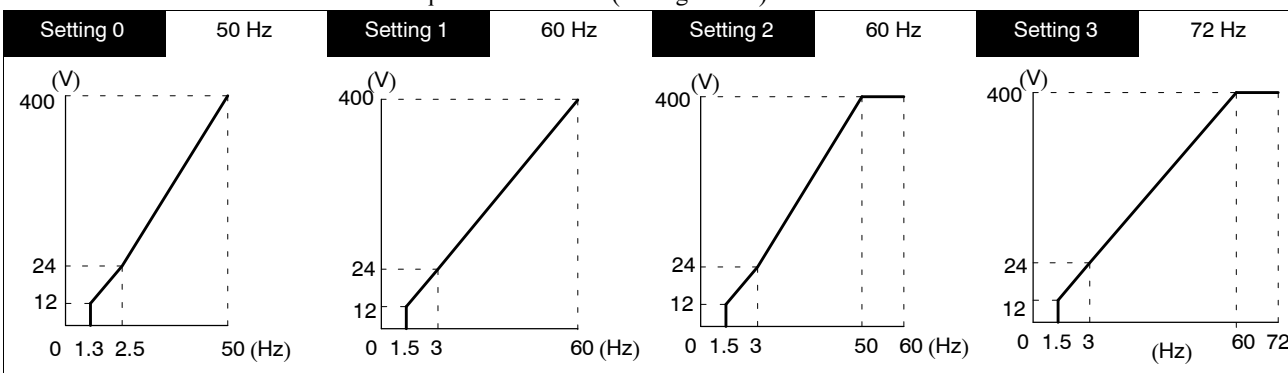

- Variable Torque Characteristics (Settings 4 to 7)

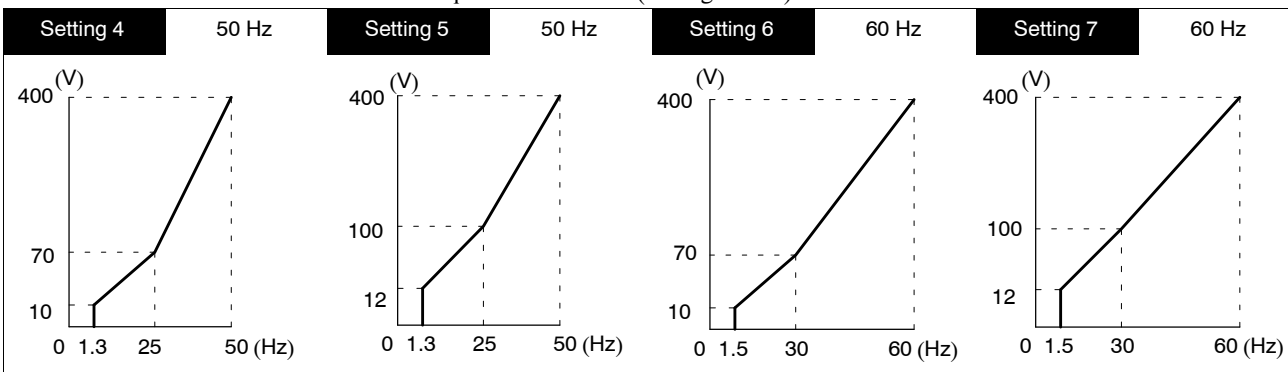

- High Starting Torque Characteristics (Settings 8 to b)

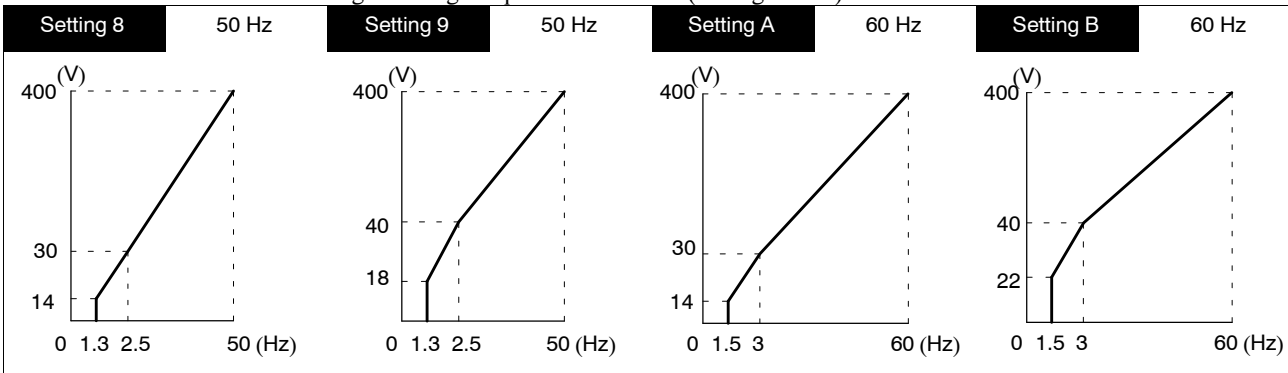

- High-speed Operation (Settings C to E)

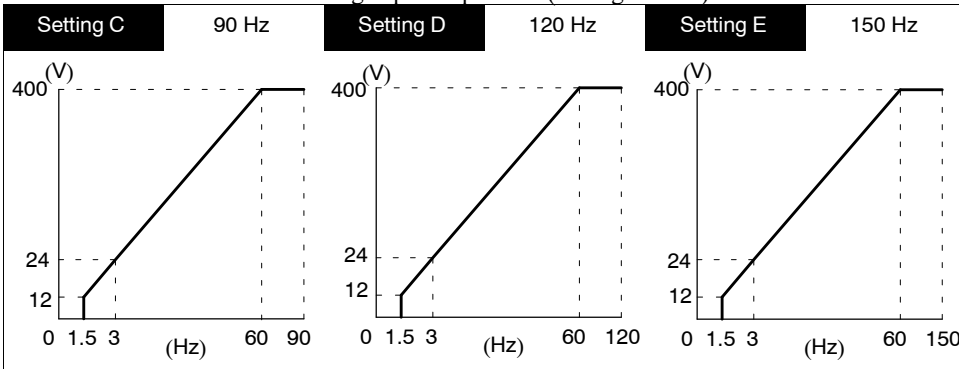

The voltages above are for 400-V Class Inverters. Multiply the voltages by approx. 1.5 for 575-V Class Inverters.

■ **Setting a User-defined V/f Pattern: E1-03 = “F”**

- Constants E1-04 through E1-10 can be set by the user when E1-03 has been set to “F.” These constants are read-only when E1-03 isn’t set to “F.”
- When making the V/f characteristics a straight line, set the same value in E1-07 (middle output frequency) and E1-09 (minimum output frequency). In this case, constant E1-08 (middle output frequency voltage) will be disregarded.
- The user constant numbers for motor 2 are given in parentheses.

Settings for E1-04 to E1-10 (E4-01 to E4-07) and E1-13

User Constant Number	Name	Change during Operation	Setting Range	Unit	Factory Setting	Valid Access Levels			
						V/f Control	V/f with PG	Open Loop Vector	Flux Vector
E1-04 (E4-01)	Max. output frequency (FMAX)	X	50.0 to 150.0	Hz	60.0	Q	Q	Q	Q
E1-05 (E4-02)	Max. voltage (VMAX)	X	0.0 to 510.0 ^{*1}	VAC	400.0 ^{*1}	Q	Q	Q	Q
E1-06 (E4-03)	Base frequency (FA)	X	0.0 to 150.0	Hz	60.0	Q	Q	Q	Q
E1-07 (E4-04)	Mid. output frequency (FB)	X	0.0 to 150.0	Hz	3.0 ^{*2}	Q	Q	A	X
E1-08 (E4-05)	Mid. output frequency voltage (VC)	X	0.0 to 510.0 ^{*1}	VAC	24.0 ^{*1, *2}	Q	Q	A	X
E1-09 (E4-06)	Min. output frequency (FMIN)	X	0.0 to 150.0	Hz	1.5 ^{*2}	Q	Q	Q	A
E1-10 (E4-07)	Min. output frequency voltage (VMIN)	X	0.0 to 510.0 ^{*1}	VAC	12.0 ^{*1, *2}	Q	Q	A	X
E1-13	Base voltage (VBASE)	X	0.0 to 510.0	VAC	0.0 ^{*3}	A	A	Q	Q

* 1. These values are for 400-V Class Inverters; multiply the values by approx. 1.5 for 575-V Class Inverters.

* 2. The factory setting depends on the Inverter capacity. The factory settings shown in the table are for 400-V Class, 200 to 800 kW Inverters. (See page 8 - 41.) Refer to the graphs for “Setting: 1” on page 6 - 23.

* 3. If E1-13 is set to 0.0, E1-13 will be set to the same value as E1-05 following autotuning and does not need to be set.

- The factory settings for E1-07 through E1-10 will be set according to the control method whenever the control method is changed. The factory settings shown in the table are for V/f control. See page 8 - 41.)
- The four frequency settings must satisfy the following formula:
 $E1-04 (F_{MAX}) \geq E1-06 (F_A) > E1-07 (F_B) \geq E1-09 (F_{MIN})$

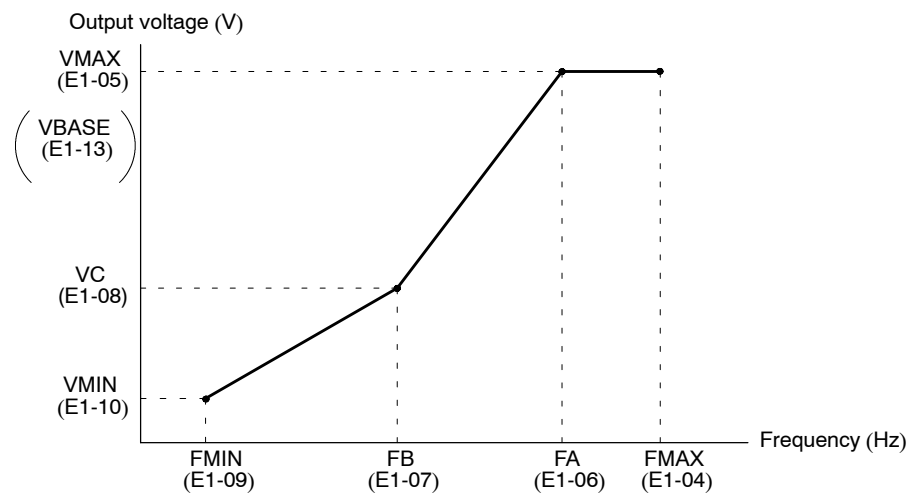

Fig 6.11 User-defined V/f Pattern

6.4 Flux Vector Control

With flux vector control (vector control with PG), make the settings for the PG Speed Control Card, select the zero-speed operation method, set the various autotuning constants, and then adjust the gain of the speed control loop.

Always perform auto-tuning for motor unit separately before vector control operation. Vector control is not effective without autotuning.

To ensure high-accuracy torque/speed control, use a motor specifically designed for vector control with an integrated PG.

When setting up a PG (encoder), connect it directly to the motor shaft. If the PG is connected to the motor via gearing or belts, responses can be delayed by backlash or torsion; the delayed responses can generate oscillation and make control impossible.

6.4.1 PG Speed Control Card Settings

■ Available PG Speed Control Cards

- There are 4 models of PG Speed Control Cards, but only 2 models can be used with vector control.
 - PG-B2: Phase-A/Phase-B pulse inputs, complementary output
 - PG-X2: Phase-A/Phase-B/Phase-Z pulse inputs, line drivers
- Select the Card according to the application and install it in the Inverter as described in *3.7 Installing and Wiring PG Speed Control Cards*.

■ PG Constant: F1-01

- Set the PG (pulse generator or encoder) constant in pulses/revolution.
- Set the number of phase-A or phase-B pulses in one motor revolution.

User Constant Number	Name	Change during Operation	Setting Range	Unit	Factory Setting	Valid Access Levels			
						V/f Control	V/f with PG	Open Loop Vector	Flux Vector
F1-01	PG constant	X	0 to 60000	p/r	600	X	Q	X	Q

■ PG Rotation Direction: F1-05

- This constant is used to coordinate the PG’s rotation direction with the motor’s rotation direction. The setting for the standard applicable Yaskawa PG (made by Thermtac) is an advanced phase A for forward rotation.
- Generally, phase A leads when the PG rotates in the clockwise direction (looking from the input axis). When a forward reference is output, the motor rotates in the counterclockwise direction (looking from the output axis).
- Set whether phase A or phase B leads when the motor operates in the forward direction.

User Constant Number	Name	Change during Operation	Setting Range	Unit	Factory Setting	Valid Access Levels			
						V/f Control	V/f with PG	Open Loop Vector	Flux Vector
F1-05	PG rotation	X	0, 1	-	0	X	B	X	B

- Settings

Setting	Function
0	Phase A leads with forward rotation. (Phase B leads with reverse rotation.)
1	Phase B leads with forward rotation. (Phase A leads with reverse rotation.)

6

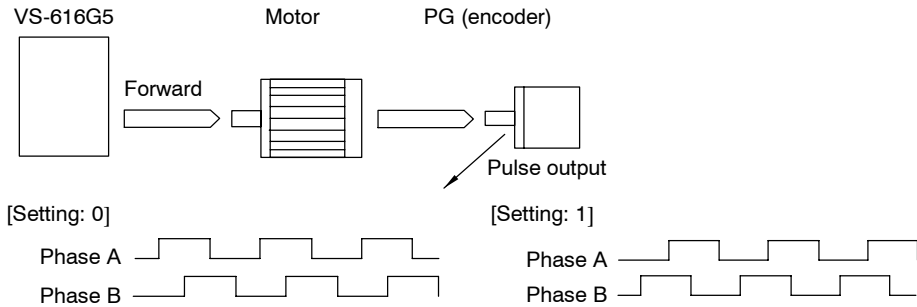

- Forward rotation in a typical motor (applicable Yaskawa PG: made by Thermtac):

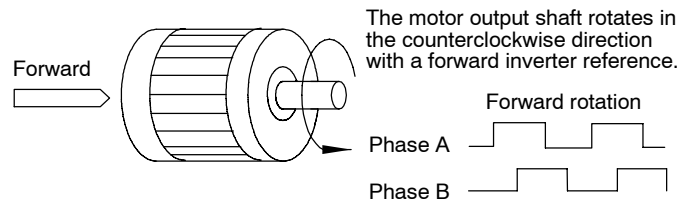

- Phase A leading in a typical PG:

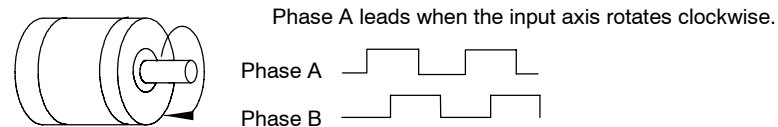

Fig 6.12 PG Rotation Direction Setting

■ **PG Pulse Output Monitor Division Rate: F1-06**

- This constant is effective only when a PG-B2 PG Control Card is used.
- It sets the division ratio used when the pulse monitor output is connected to a pulse input device.

User Constant Number	Name	Change during Operation	Setting Range	Unit	Factory Setting	Valid Access Levels			
						V/f Control	V/f with PG	Open Loop Vector	Flux Vector
F1-06	PG division rate (PG pulse monitor)	x	1 to 132	-	1	x	B	x	B

- The first digit in the setting (0 or 1) is n and the second two digits (01 to 32) are m. The division ratio is calculated from n and m with the following equation:

$$\text{Division ratio} = (1+n)/m \quad \text{Setting Ranges} \quad n: 0, 1 \quad m: 1 \text{ to } 32$$

$$F1-06 = \begin{matrix} \square & \square & \square \\ n & & m \end{matrix}$$

- Possible division rate settings are as follows: $1/32 \leq F1-06 \leq 1$. For example, if the division rate is 1/2 (a setting of “2”), the monitor output will be half of the number of pulses output from the PG.

■ **Fault Detection Functions: F1-02 to F1-04, F1-08 to F1-11, F1-14**

PG Disconnection Stopping Method: F1-02, F1-14

- Sets the PG open-circuit detection time and stopping method that is used when a break is detected in the PG cable (PGO).

User Constant Number	Name	Change during Operation	Setting Range	Unit	Factory Setting	Valid Access Levels			
						V/f Control	V/f with PG	Open Loop Vector	Flux Vector
F1-02	Operation selection at PG open circuit	x	0 to 3	-	1	x	B	x	B
F1-14	PG open-circuit detection time	x	0.0 to 10.0	s	2.0	x	A	x	A

6.4.1 PG Speed Control Card Settings

- Settings

Setting	Function
0	Deceleration to stop using deceleration time 1 (C1-02).
1	Coast to stop
2	Emergency stop using the emergency-stop time (C1-09).
3	Continue operation (PGO is displayed, and continues operation.)

Overspeed Settings: F1-03, F1-08, F1-09

- Overspeed refers to an excessive motor speed.
- Set the conditions (level and time) for detecting overspeed and the stopping method that is used when an overspeed is detected.

User Constant Number	Name	Change during Operation	Setting Range	Unit	Factory Setting	Valid Access Levels			
						V/f Control	V/f with PG	Open Loop Vector	Flux Vector
F1-03	Operation selection at overspeed	x	0 to 3	-	1	x	B	x	B
F1-08	Overspeed detection level	x	0 to 120	%	115	x	A	x	A
F1-09	Overspeed detection delay time	x	0.0 to 2.0	s	0.0	x	A	x	A

- Settings

Setting	Function
0	Deceleration to stop using deceleration time 1 (C1-02).
1	Coast to stop
2	Emergency stop using the emergency-stop time (C1-09).
3	Continue operation (PGO is displayed, and continues operation..)

- F1-08 and F1-09 Settings
Constant F1-08 sets the overspeed detection level as a percentage of the maximum output frequency. Constant F1-09 sets the length of time in seconds that the motor speed must exceed the overspeed detection level in order to generate an overspeed fault.

PG Speed Deviation Settings: F1-04, F1-10, F1-11

- PG speed deviation refers to the difference between the actual motor speed and the reference speed.
- These constants set the conditions (level and time) for detecting PG speed deviation and the stopping method that is used when a PG speed deviation is detected.

User Constant Number	Name	Change during Operation	Setting Range	Unit	Factory Setting	Valid Access Levels			
						V/f Control	V/f with PG	Open Loop Vector	Flux Vector
F1-04	Operation selection at deviation	x	0 to 3	-	3	x	B	x	B
F1-10	Excessive speed deviation detection level	x	0 to 50	%	10	x	A	x	A
F1-11	Excessive speed deviation detection delay time	x	0.0 to 10.0	s	0.5	x	A	x	A

- Settings (F1-04)

Setting	Function
0	Deceleration to stop using deceleration time 1 (C1-02).
1	Coast to stop
2	Emergency stop using the emergency-stop time (C1-09).
3	Continue operation (Displays “DEV” and continues control.)

- F1-10 and F1-11 Settings
Constant F1-10 sets the PG speed deviation detection level as a percentage of the maximum output frequency. Constant F1-11 sets the length of time in seconds that the difference between the motor speed and reference speed must exceed the PG speed deviation detection level in order to detect a PG speed deviation (DEV).

6.4.2 Setting the Zero-speed Operation Constants

- With flux vector control, operation is possible even when the frequency reference is zero (below the minimum output frequency).
- Set the operation methods for the minimum output frequency.

■ Stopping Method Selection: b1-03

- Set the stopping method used when a stop command is input.

User Constant Number	Name	Change during Operation	Setting Range	Unit	Factory Setting	Valid Access Levels			
						V/f Control	V/f with PG	Open Loop Vector	Flux Vector
b1-03	Stopping method selection	X	0 to 3	-	0	Q	Q	Q	Q

- Settings

Setting	Function
0	Deceleration to stop
1	Coast to stop
2	DC injection braking stop (This setting can't be made with flux vector control.)
3	Coast to stop with timer (This setting can't be made with flux vector control.)

■ Zero-speed Operation: b1-05 and Minimum Output Frequency: E1-09

- Set the operation method used when the frequency reference is below the minimum output frequency.

User Constant Number	Name	Change during Operation	Setting Range	Unit	Factory Setting	Valid Access Levels			
						V/f Control	V/f with PG	Open Loop Vector	Flux Vector
b1-05	Operation selection for setting of E1-09 or less	X	0 to 3	-	0	X	X	X	A

- Settings

Setting	Function
0	Operate according to the frequency reference. (E1-09 is invalid.)
1	Interrupt the output. (Coast when the frequency reference is below E1-09.)
2	Operate at E1-09 frequency. (Output the frequency set in E1-09.)
3	Zero-speed operation (Zero reference value when the frequency reference is below E1-09.)

Minimum Output Frequency (FMIN): E1-09

- Set the minimum output frequency according to the requirements of the application.

User Constant Number	Name	Change during Operation	Setting Range	Unit	Factory Setting	Valid Access Levels			
						V/f Control	V/f with PG	Open Loop Vector	Flux Vector
E1-09	Min. output frequency	X	0.0 to 150.0	Hz	0.0	Q	Q	Q	A

■ Initial Excitation Settings: b2-01, b2-03, b2-04

- Set the zero speed level, DC injection braking time at startup, and the DC injection braking time when stopping.

Basic Operation

6.4.2 Setting the Zero-speed Operation Constants

User Constant Number	Name	Change during Operation	Setting Range	Unit	Factory Setting	Valid Access Levels			
						V/f Control	V/f with PG	Open Loop Vector	Flux Vector
b2-01	Zero speed level (DC injection braking starting frequency)	x	0.0 to 10.0	Hz	0.5	B	B	B	B
b2-03	DC injection braking time at start	x	0.00 to 10.00	s	0.00	B	B	B	B
b2-04	DC injection braking time at stop	x	0.00 to 10.00	s	0.50	B	B	B	B

- With flux vector control, the DC injection braking function is replaced by the initial excitation function and zero speed function.
- The timing of the initial excitation function depends on the zero-speed operation method selected in b1-05 (zero-speed operation), as shown in *Figure 6.13*.
- The initial excitation function stops a motor that is rotating because of inertia.

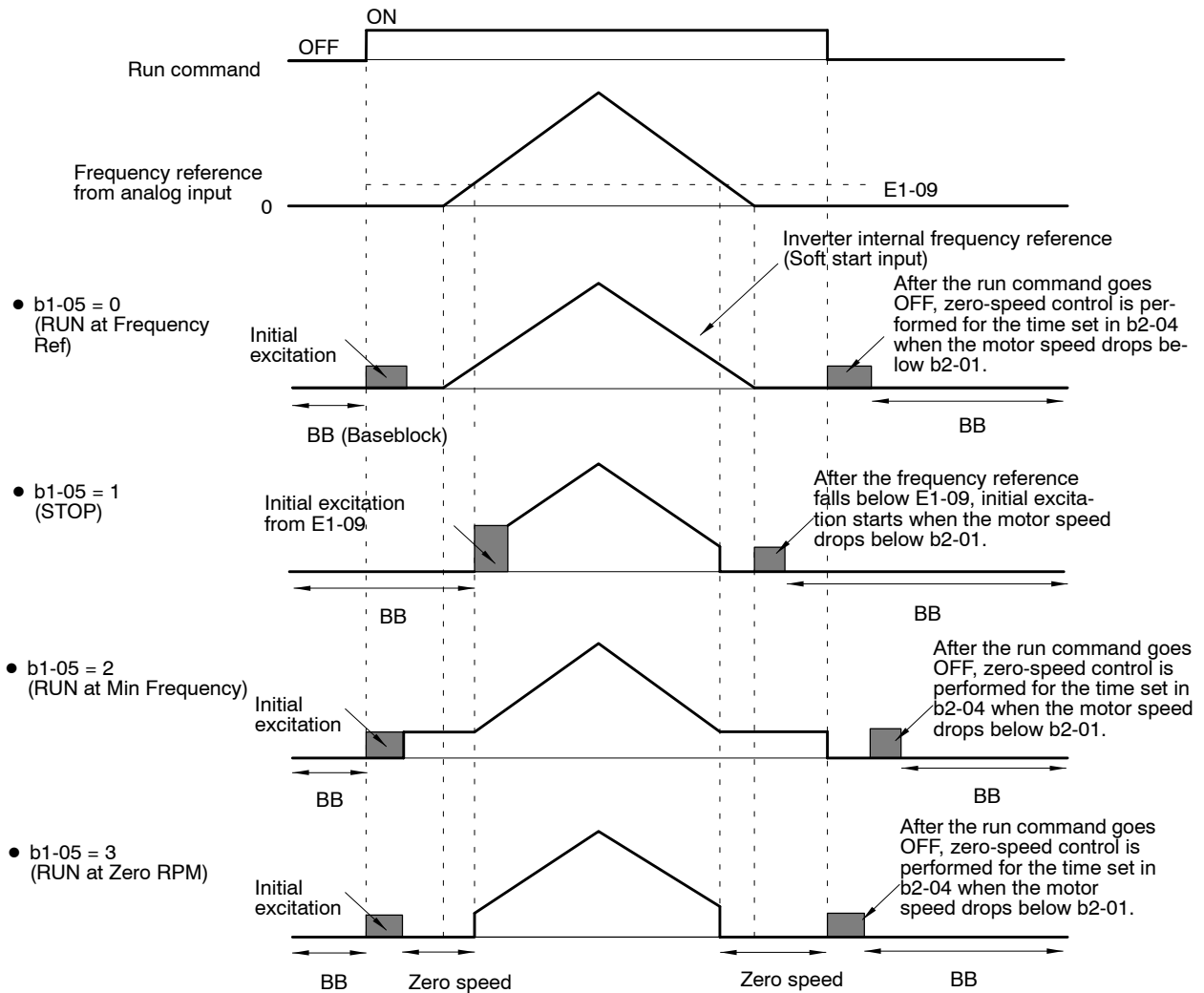

Fig 6.13 Settings for Initial Excitation and Zero-speed Control

- Initial excitation is started from b2-01 (zero speed level) when decelerating. A setting of b2-01 < E1-09 is valid only with flux vector control.
- The current level for the initial excitation function is set in E2-03 (motor no-load current).
- The DC injection braking current (b2-02) isn't used with flux vector control and can't be set.

6.4.3 Autotuning

! CAUTION

- Do not connect a load to the motor when performing autotuning. Doing so may result in personal injury or equipment damage.

When motor cannot be disconnected from the load, motor constants can be set by calculation. Contact your YASKAWA representatives for details.

■ Precautions Before Autotuning

- The Inverter's autotuning function automatically determines the motor constants while a servo system's autotuning function determines the size of a load, so these autotuning functions are fundamentally different.
- If a load is connected when autotuning is performed, not only will incorrect motor constants be recorded, but the motor may operate erratically or unexpectedly. Disconnect the load before autotuning.
- The motor shaft will rotate when autotuning is performed. Confirm safety before starting autotuning.
- When motor cannot be disconnected from the load, motor constants can be set by calculation. Contact your YASKAWA representatives for details.

■ Inverter Input Voltage Setting: E1-01

- Set the Inverter input voltage to match the power supply voltage.

User Constant Number	Name	Change during Operation	Setting Range	Unit	Factory Setting	Valid Access Levels			
						V/f Control	V/f with PG	Open Loop Vector	Flux Vector
E1-01	Input voltage setting	x	360 to 460 (460 to 690)	VAC	400 (600)	Q	Q	Q	Q

- The voltage settings shown in parentheses are for 575-V class Inverters.
- This setting is used as the reference value for functions such as the protection functions.

■ Required Constant Settings

1. Enter autotuning mode and make the following constant settings:

- Rated Voltage *
Set the rated voltage (VAC) shown on the motor nameplate.
- Rated Current
Set the rated current (A) shown on the motor nameplate.
- Rated Frequency
Set the rated frequency (Hz) shown on the motor nameplate.
- Rated Speed
Set the rated speed (r/min) shown on the motor nameplate.
- Number of Poles
Set the number of poles.
- Motor Selection
Select motor 1 or motor 2. (Normally select motor 1.).
- PG Pulses/Rev:
Set the number of A-phase or B-phase pulses per revolution.

2. The following message will appear when the constants have been set:

Tuning Ready?
 Press RUN key

The "Press RUN Key" message will blink.

3. At this point, it is still possible to change the constant settings by pressing the Increment and Decrement Keys to display the desired constant.
4. Press the STOP Key to cancel autotuning, and then press the MENU Key and DATA/ENTER Key. The operation mode display will appear.

* Rated voltage for vector control motors is approx. 10 to 20% lower than general-purpose motors. Always verify motor voltage listed on the nameplate or test report before use.

■ Performing Autotuning

- Autotuning will start if the Run Key is pressed when the “Tuning Ready?” message is being displayed.
- The motor will operate during autotuning, so be sure that it is safe for the motor to operate before pressing the Run Key.
- The following message will be displayed when the Run Key is pressed:

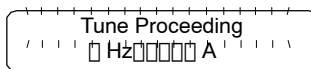

The “Tune Proceeding” message will blink.

- Autotuning takes up to 1.5 minutes. The message “Tune Successful” will be displayed when autotuning is completed.
- If autotuning has been completed successfully, press the Menu Key and proceed to the next operation.
- If a fault occurred during autotuning, refer to *Table 6.3 Autotuning Faults* for details on correcting the cause of the fault and perform autotuning again.

■ Autotuning Faults

- One of the fault messages in the following table will be displayed if a fault occurs during autotuning and the motor will stop. In this case, determine the cause of the fault, correct it, and perform autotuning again.
- The fault display can be cleared by pressing the MENU Key.
- The motor constants will revert to their default settings if a fault occurs. Set these constants again before starting autotuning again.

Table 6.3 Troubleshooting Autotuning Faults for Open-loop Vector Control

Fault Display	Probable Cause		Remedy
Data Invalid (Motor data fault)	There was a fault in the data set during autotuning.	There was a fault in the relationship between the rated frequency, rated speed, and number of poles.	Change the settings to conform to the following equation: Rated speed < 120 × Motor frequency/Number of poles
ALARM: Over Load (Excessive tuning load)	The effective load factor exceeded 20% during autotuning.	A load is connected to the motor shaft.	Remove the load.
		There was a setting fault during autotuning.	Check the rated current setting. Change if necessary.
Motor speed (Motor speed fault)	The torque reference value exceeded 100% during autotuning.	There is a motor bearing problem.	Turn the Inverter off and rotate the motor by hand. Replace the motor if it doesn't turn smoothly.
		There is a broken/disconnected motor power wire.	Check and replace wiring components if necessary.
Accelerate (Acceleration fault)	The motor doesn't accelerate within the prescribed time.	A load is connected to the motor shaft.	Remove the load.
		The torque limit function is operating.	Initialize the torque limit constants (H7-01 to H7-04).
		The acceleration time is too short.	Increase acceleration time 1 (C1-01).
Rated Slip (Rated slip fault)	The rated slip setting can't be tuned within the prescribed time.	A load is connected to the motor shaft.	Remove the load.
Saturation -1 (Iron core saturation coefficient 1 fault)	The core-saturation coefficients can't be tuned within the prescribed time.	The rated current setting isn't correct.	Check and change the setting if necessary.
Saturation -2 (Iron core saturation coefficient 2 fault)		There is a broken/disconnected motor power wire.	Check and replace wiring components if necessary.
Resistance (Line-to-line resistance fault)	The motor terminal resistance or no-load current setting can't be tuned within the prescribed time.	The rated current setting isn't correct.	Check and change the setting if necessary.
No-load Current (No-load current fault)		There is a broken/disconnected motor power wire.	Check and replace wiring components if necessary.

6

Fault Display	Probable Cause		Remedy
Motor Direction Fault (Motor direction fault)	--	There is a faulty connection between the Inverter and PC (A or B phase) or the Inverter and Motor (U, V, or W phase).	<ul style="list-style-type: none"> Check the PG wiring. Check the motor wiring. Check the PG rotation direction and constant F1-05.
PG Circuit Fault PGO: PG break detected)	Pulses aren't being input from the PG even though a rotation output is being sent to the motor.	<ul style="list-style-type: none"> The cable to the PG is broken/disconnected. The PG's power supply is broken/disconnected. 	Check the wiring and correct any problems.
Tune Aborted Minor Fault: □□□	---	A minor Inverter fault occurred.	Check the minor fault indicated in the boxes in the display shown at the left.
Tune Aborted V/f Over Setting (Displayed after completion of autotuning)	Torque reference exceeded 100%, and no-load current exceeded 70%.	Rated voltage and rated frequency settings are not correct.	Check the setting and correct any problems.
		The load is connected to the motor.	Disconnect the motor from the load.

6.4.4 Speed Control (ASR) Structure

- The following block diagram shows the structure of the speed control.

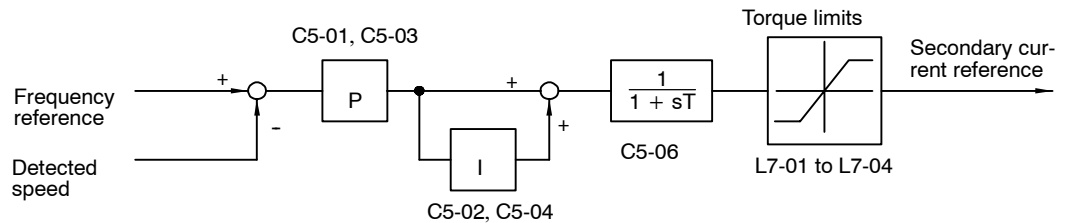

In vector flux control, the ASR's P gain is the maximum frequency standard.

Fig 6.14 Speed Control Structure

■ Gain Settings: C5-01, C5-02

- Set the proportional gain and the integral time of the speed control (ASR).

User Constant Number	Name	Change during Operation	Setting Range	Unit	Factory Setting	Valid Access Levels			
						V/f Control	V/f with PG	Open Loop Vector	Flux Vector
C5-01	ASR proportional (P) gain 1	○	0.00 to 300.00	Multiple	20.00	x	B	x	B
C5-02	ASR integral (I) time 1	○	0.000 to 10.000	s	0.500	x	B	x	B

■ Low-speed Gain Settings: C5-03, C5-04, C5-07

- Use these constants to set different proportional gain and integral time settings for low-speed operation. Constant C5-03 sets the low-speed proportional gain of the speed loop (ASR), and C5-04 sets the low-speed integral time.
- Set constant C5-07 to the frequency at which to switch to the low-speed ASR proportional gain and integral time.

User Constant Number	Name	Change during Operation	Setting Range	Unit	Factory Setting	Valid Access Levels			
						V/f Control	V/f with PG	Open Loop Vector	Flux Vector
C5-03	ASR proportional (P) gain 2	○	0.00 to 300.00	Multiple	20.00	x	B	x	B
C5-04	ASR integral (I) time 2	○	0.000 to 10.000	s	0.500	x	B	x	B
C5-07	ASR switching frequency	○	0.0 to 150.0	Hz	0.0	x	x	x	A

• Figure 6.15 shows how the proportional gain and integral time approach the ASR proportional gain 2 and ASR integral time 2 linearly.

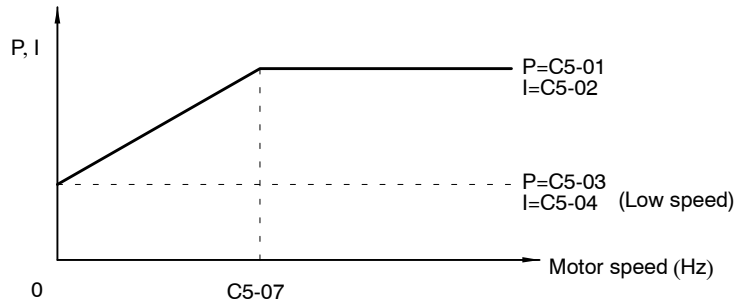

If C5-07 is set to 0.0, ASR proportional gain 1 and ASR integral time 1 are used for the proportional gain and integral time at all frequencies.

Fig 6.15 Gain Settings at Low Frequencies

■ Multi-function Input Settings: H1-01 (Terminal 11) to H1-06 (Terminal 16)

ASR Integral Reset Setting: "E"

- When one of the multi-function inputs is set to "E," the input can be used to switch the speed control loop between P control and PI control.
- P control (integral reset) is used when the multi-function input is ON.

ASR Proportional Gain Switch Setting: "77"

- When one of the multi-function inputs is set to "77," the input can be used to switch between proportional gain 1 and proportional gain 2.
- Proportional gain 2 (C5-03) is used when the multi-function input is ON. This input has higher priority than the ASR switching frequency set in C5-07.

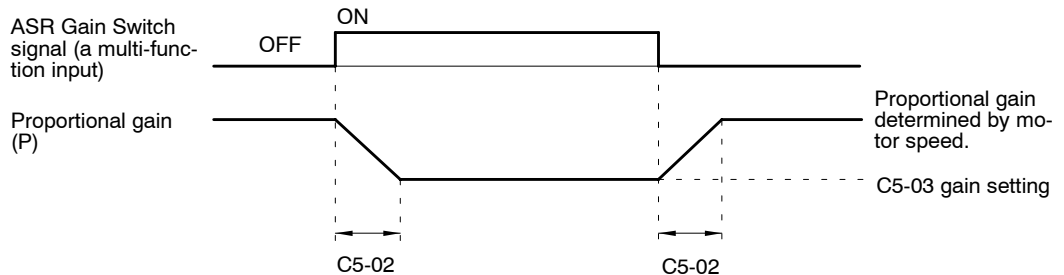

The gain is changed linearly in integral time 1 (C5-02). The integral time setting isn't switched.

Fig 6.16 ASR Proportional Gain Switch

■ Speed Control (ASR) Responsiveness: C5-06

User Constant Number	Name	Change during Operation	Setting Range	Unit	Factory Setting	Valid Access Levels			
						V/f Control	V/f with PG	Open Loop Vector	Flux Vector
C5-06	ASR primary delay time	X	0.000 to 0.500	s	0.004	X	X	X	A

- Normally it isn't necessary to make this adjustment.
- Constant C5-06 can be used when adjusting the gain doesn't remove motor oscillation, or adjusting the gain removes oscillation but results in poor responsiveness.
- A high C5-06 setting lowers the responsiveness of the speed control, but makes it difficult for oscillation to occur.

6.4.5 Speed Control (ASR) Gain

■ Gain Adjustment Procedure

Use the following procedure to adjust the gain with the mechanical system and actual load connected.

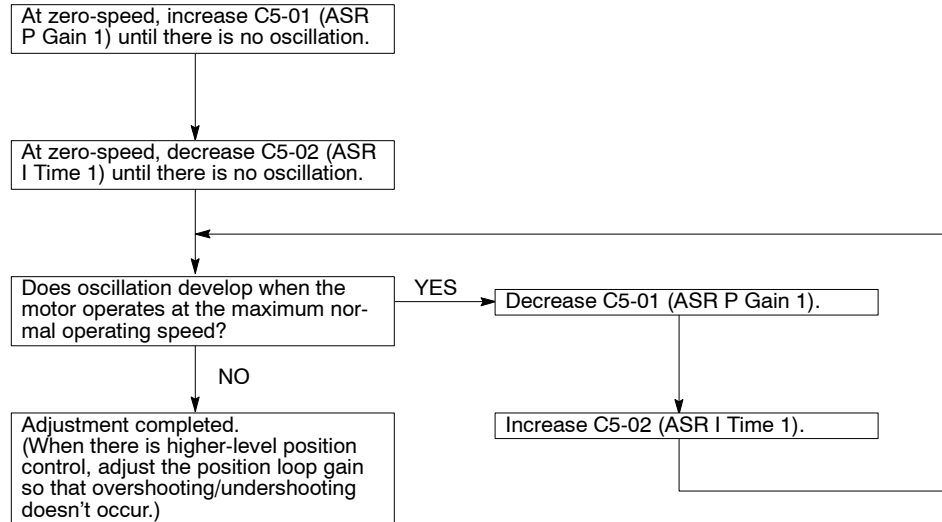

Fig 6.17 Gain Adjustment Procedure

■ Fine Adjustments

- When you want even finer gain adjustment, adjust the gain while observing the speed waveform.
- Constant settings like those shown in the following table will be necessary to monitor the speed waveform.

Constant	Setting	Explanation
H4-01 Analog output selection (terminal 45)	2	Settings that allow multi-function analog output 1 to be used to monitor the output frequency.
H4-02 Analog output gain (terminal 45)	1.00	
H4-03 Analog output bias (terminal 45)	0.0	
H4-04 Analog output selection (terminal 48)	5	Settings that allow multi-function analog output 2 to be used to monitor the motor speed.
H4-05 Analog output gain (terminal 48)	1.00	
H4-06 Analog output bias (terminal 48)	0.0	
H4-07 Analog output level selection	1	This setting allows a 0 to ±10 V signal range to be monitored.

- The multi-function analog outputs have the following functions with these constant settings.
 - Multi-function analog output 1 (terminal 45): Outputs Inverter's output frequency (0 to ±10 V).
 - Multi-function analog output 2 (terminal 48): Outputs actual motor speed (0 to ±10 V).
 Terminal 46 is the multi-function analog output common.
- We recommend monitoring both the output frequency and the motor speed to monitor the response delay or deviations from the reference value, as shown in the following diagram.

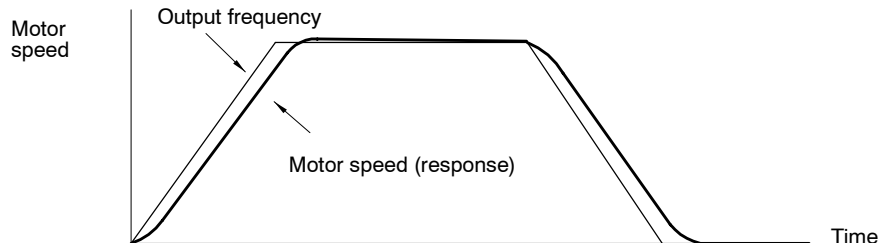

Fig 6.18 Example Monitor Waveforms

Adjusting ASR Proportional Gain 1 (C5-01)

- This gain setting adjusts the responsiveness of the speed control (ASR).
- The responsiveness is increased when this setting is increased. Usually this setting is higher for larger loads. Oscillation will occur if this setting is increased too much.
- The following diagram shows the type of changes that can occur in the response when the ASR proportional gain is changed.

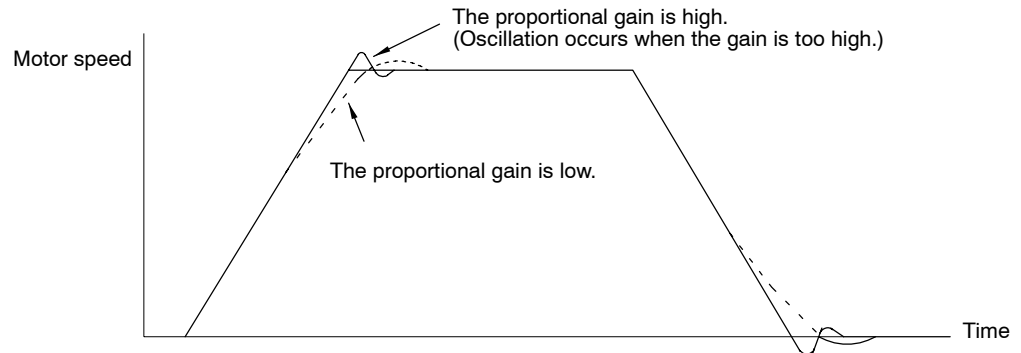

Fig 6.19 Responsiveness for Proportional Gain

Adjusting ASR Integral Time 1 (C5-02)

- This constant sets the speed control (ASR) integral time.
- Lengthening the integral time lowers the responsiveness, and weakens the resistance to external influences. Oscillation will occur if this setting is too short.
- The following diagram shows the type of changes that can occur in the response when the ASR integral time is changed.

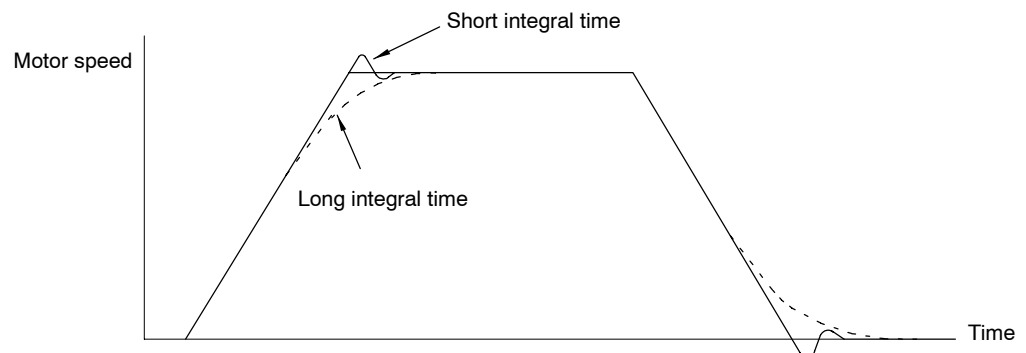

Fig 6.20 Responsiveness for Integral Time

■ Different Gain Settings for Low-speed and High-speed

Switch between low-speed and high-speed gain when oscillation occurs because of resonance with the mechanical system at low speed or high speed.

Setting the Gain Switching Frequency (C5-07)

- Set the switching frequency to about 80% of the motor operating frequency or the frequency at which oscillation occurs.

Low-speed Gain Adjustments (C5-03, C5-04)

- Connect the actual load and adjust these constants at zero-speed. Increase ASR proportional gain 2 (C5-03) until there is no oscillation.
- Decrease ASR integral time 2 (C5-04) until there is no oscillation.

High-speed Gain Adjustments (C5-01, C5-02)

- Adjust these constants at normal operating speed. Increase ASR proportional gain 1 (C5-01) until there is no oscillation.
- Decrease ASR integral time 1 (C5-02) until there is no oscillation.
- Refer to *Fine Adjustments* on page 6 - 36 for details on making fine adjustments of high-speed operation.

6.5 V/f Control with PG

With V/f control with a PG, the user must set the motor constants, V/f pattern, and PG Control Card settings, and then adjust the speed control gain.

6.5.1 Motor Constants: E1-01, E1-02, E2-01, E2-04

■ Inverter Input Voltage Setting: E1-01

- Set the Inverter's input voltage to match the power supply voltage.

User Constant Number	Name	Change during Operation	Setting Range	Unit	Factory Setting	Valid Access Levels			
						V/f Control	V/f with PG	Open Loop Vector	Flux Vector
E1-01	Input voltage setting	X	360 to 460 (460 to 690)	VA C	400 (600)	Q	Q	Q	Q

- The voltage settings shown in parentheses are for the 575-V class Inverters.
- This setting is used as the reference value for functions such as the protection functions.

■ Motor Selection: E1-02, E2-01, E2-04

Motor Selection (Motor Overheating Protection): E1-02

- Set the type of motor being used with the motor selection constant (E1-02). This setting is a reference for overheating protection functions.

User Constant Number	Name	Change during Operation	Setting Range	Unit	Factory Setting	Valid Access Levels			
						V/f Control	V/f with PG	Open Loop Vector	Flux Vector
E1-02	Motor selection (motor overheating protection)	X	0, 1	-	0	Q	Q	Q	Q

- Settings

Setting	Function
0	Standard motor (general-purpose motor)
1	Special motor (inverter-exclusive motor)

Motor Rated Current (Electronic Thermal Reference Current): E2-01

- Set the rated current (A) shown on the motor nameplate.

User Constant Number	Name	Change during Operation	Setting Range	Unit	Factory Setting	Valid Access Levels			
						V/f Control	V/f with PG	Open Loop Vector	Flux Vector
E2-01	Motor rated current (electronic thermal reference current)	X	10% to 200% (of rated current)*1	A	*2	Q	Q	Q	Q

* 1. The setting range is 10% to 200% of the Inverter rated output current.

* 2. The factory setting depends upon the type of Inverter. Refer to pages 8 - 42.

Number of Motor of Poles: E2-04

- Set constant (E2-04) to the number of poles shown on the motor nameplate.

User Constant Number	Name	Change during Operation	Setting Range	Unit	Factory Setting	Valid Access Levels			
						V/f Control	V/f with PG	Open Loop Vector	Flux Vector
E2-04	Number of motor poles	X	2 to 48	-	4	X	Q	X	Q

6.5.2 V/f Pattern Selection: E1-03

- The V/f pattern can be set to any of the following:
 - One of 15 preset patterns (settings 0 through E)
 - A custom user-set pattern (setting F)
- The factory setting for E1-03 is “F” (user-defined V/f pattern), but the default contents of this setting are the same as setting “1.”

User Constant Number	Name	Change during Operation	Setting Range	Unit	Factory Setting	Valid Access Levels			
						V/f Control	V/f with PG	Open Loop Vector	Flux Vector
E1-03	V/f pattern selection	X	0 to F	-	F	Q	Q	X	X

■ Selecting a Preset V/f Pattern: E1-03 = “0” through “E”

- Refer to the following table when selecting one of the 15 preset patterns.

Characteristics	Applications	Setting	Specifications
Fixed torque	These patterns are for general-purpose applications. Use these patterns when the load torque is to remain constant for any rotational speed, such as in straight-line conveyors.	0	50 Hz
		1	60 Hz
		2	60 Hz, Voltage saturation at 50 Hz
		3	72 Hz, Voltage saturation at 60 Hz
Variable torque	Use these patterns when there is a quadratic or cubic relationship between the rotational speed and load, such as in fans or pumps.	4	50 Hz, cubic
		5	50 Hz, quadratic
		6	60 Hz, cubic
		7	60 Hz, quadratic
High starting torque *	Select a high starting torque V/f pattern only in the following cases: <ul style="list-style-type: none"> • The wiring distance between the Inverter and motor is relatively large (greater than 150 m). • A large torque is required at startup (such as heavy axis loads). • An AC or DC reactor is connected to the Inverter’s input or output. • A motor less than the maximum applicable motor is being used. 	8	50 Hz, low starting torque
		9	50 Hz, high starting torque
		A	60 Hz, low starting torque
		b	60 Hz, high starting torque
High-speed operations	These patterns are for applications that must rotate at frequencies greater than 60 Hz. A fixed voltage is applied at frequencies greater than 60 Hz.	C	90 Hz, Voltage saturation at 60 Hz
		d	120 Hz, Voltage saturation at 60 Hz
		E	150 Hz, Voltage saturation at 60 Hz

* Normally it isn’t necessary to use these patterns because starting torque is ensured by automatic torque boost functions.

- The constant settings for E1-04 through E1-10 will be changed automatically when one of these patterns is selected.
- The characteristics for these patterns are shown in the diagrams on page 6 - 23.

■ Setting a User-defined V/f Pattern: E1-03 = “F”

- Constants E1-04 through E1-10 can be set by the user when E1-03 has been set to “F.”
- Refer to page 6 - 24 for details on setting these constants.

6.5.3 PG Speed Control Card Settings

■ Available PG Speed Control Cards

- There are 4 models of PG Speed Control Cards, but only 2 models can be used with vector control.
 - PG-A2: Phase-A/Phase-B pulse inputs, complementary output
 - PG-D2: Phase-A/Phase-B/Phase-Z pulse inputs, line drivers
- Select the Card according to the application and install it in the Inverter as described in 3.7 *Installing and Wiring PG Speed Control Cards*.

■ Setting the PG Pulse Number: F1-01

- Set the PG (pulse generator or encoder) pulse number in pulses/revolution.
- Set the number of phase A or phase B pulses in one motor revolution.

User Constant Number	Name	Change during Operation	Setting Range	Unit	Factory Setting	Valid Access Levels			
						V/f Control	V/f with PG	Open Loop Vector	Flux Vector
F1-01	PG constant	X	0 to 60000	p/r	600	X	Q	X	Q

■ Setting the Number of PG Gear Teeth: F1-12, F1-13

- When “V/f control with PG feedback” is used, the motor can be operated even if there are gears between the motor and PG because the responsiveness is lower than it is with vector control.
- Set the number of teeth on the gears if there are gears between the motor and PG.
- The motor speed will be calculated within the Inverter using the following equation:

$$\text{Motor speed (r/min)} = \frac{\text{Number of pulses input from the PG} \times 60}{\text{Number of PG pulses (F1-01)}} \times \frac{\text{Number of gear teeth 2 (F1-13)}}{\text{Number of gear teeth 1 (F1-12)}}$$

User Constant Number	Name	Change during Operation	Setting Range	Unit	Factory Setting	Valid Access Levels			
						V/f Control	V/f with PG	Open Loop Vector	Flux Vector
F1-12	Number of PG gear teeth 1	X	0 to 1000	-	0	X	A	X	X
F1-13	Number of PG gear teeth 2	X	0 to 1000	-	0	X	A	X	X

- A gear ratio of 1 (F1-12 = F1-13 = 1) will be used if either of these constants is set to 0.

■ Selecting Integral Operation During Acceleration/Deceleration: F1-07

- When “V/f control with PG feedback” is used, integral control during acceleration and deceleration can be enabled or disabled with F1-07.
- Set F1-07 to “1” (integral control enabled) if you want to keep the motor speed as close to the frequency reference as possible during acceleration and deceleration. Set F1-07 to “0” (integral control disabled) if you want to prevent the occurrence of overshooting/undershooting.

User Constant Number	Name	Change during Operation	Setting Range	Unit	Factory Setting	Valid Access Levels			
						V/f Control	V/f with PG	Open Loop Vector	Flux Vector
F1-07	Integral value during accel/decel enable/disable	X	0, 1	-	0	X	B	X	X

- Settings

Setting	Function
0	Disabled (The integral function isn't used while accelerating or decelerating; it is used at constant speeds.)
1	Enabled (The integral function is used at all times.)

■ **Setting and Adjusting the Fault Detection Functions**

PG Disconnection Stopping Method: F1-02, F1-14

- This constant sets the stopping method that is used when the signal from the PG is lost.

User Constant Number	Name	Change during Operation	Setting Range	Unit	Factory Setting	Valid Access Levels			
						V/f Control	V/f with PG	Open Loop Vector	Flux Vector
F1-02	Operation selection at PG open circuit	x	0 to 3	-	1	x	B	x	B
F1-14	PG open-circuit detection time	x	0.0 to 10.0	s	2.0	x	A	x	A

- Settings

Setting	Function
0	Deceleration to stop using deceleration time 1 (C1-02).
1	Coast to stop
2	Emergency stop using the emergency-stop time (C1-09).
3	Continue operation (Display “PGO” and continue operation with V/f control.)

Overspeed Settings: F1-03, F1-08, F1-09

- Overspeed refers to an excessive motor speed.
- Set the conditions (level and time) for detecting overspeed and the stopping method that is used when an overspeed is detected.

User Constant Number	Name	Change during Operation	Setting Range	Unit	Factory Setting	Valid Access Levels			
						V/f Control	V/f with PG	Open Loop Vector	Flux Vector
F1-03	Operation selection at overspeed	x	0 to 3	-	1	x	B	x	B
F1-08	Overspeed detection level	x	0 to 120	%	115	x	A	x	A
F1-09	Overspeed detection delay time	x	0.0 to 2.0	s	1.0	x	A	x	A

- Settings

Setting	Function
0	Deceleration to stop using deceleration time 1 (C1-02).
1	Coast to stop
2	Emergency stop using the emergency-stop time (C1-09).
3	Continue operation (Display “OS” and continue control.)

- F1-08 and F1-09 Settings
Constant F1-08 sets the overspeed detection level as a percentage of the maximum output frequency. Constant F1-09 sets the length of time in seconds that the motor speed must exceed the overspeed detection level in order to generate an overspeed fault.

PG Speed Deviation Settings: F1-04, F1-10, F1-11

- PG speed deviation refers to the difference between the actual motor speed and the reference speed.
- These constants set the conditions (level and time) for detecting PG speed deviation and the stopping method that is used when a PG speed deviation is detected.

User Constant Number	Name	Change during Operation	Setting Range	Unit	Factory Setting	Valid Access Levels			
						V/f Control	V/f with PG	Open Loop Vector	Flux Vector
F1-04	Operation selection at deviation	x	0 to 3	-	3	x	B	x	B
F1-10	Excessive speed deviation detection level	x	0 to 50	%	10	x	A	x	A
F1-11	Excessive speed deviation detection delay time	x	0.0 to 10.0	s	0.5	x	A	x	A

- Settings

Setting	Function
0	Deceleration to stop using deceleration time 1 (C1-02).
1	Coast to stop
2	Emergency stop using the emergency-stop time (C1-09).
3	Continue operation (Display “DEV” and continue control.)

- F1-10 and F1-11 Settings

Constant F1-10 sets the PG speed deviation detection level as a percentage of the maximum output frequency. Constant F1-11 sets the length of time in seconds that the difference between the motor speed and reference speed must exceed the PG speed deviation detection level in order to detect a PG speed deviation (DEV).

6.5.4 Speed Control (ASR) Structure

- The following block diagram shows the structure of the speed control.

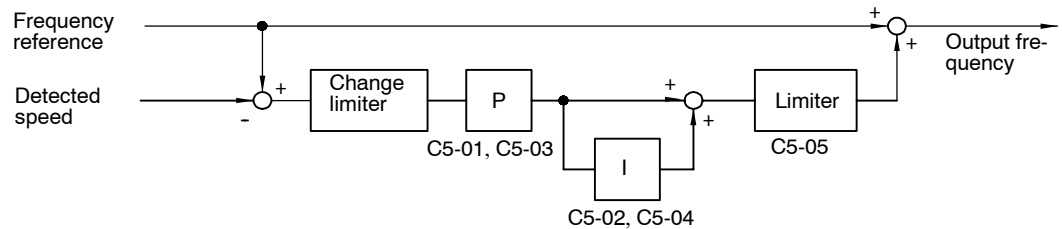

Fig 6.21 Speed Control Structure

Gain Settings

- When using “V/f control with PG feedback,” set the gain at the minimum output frequency and maximum output frequency.

Max. Output Frequency Gain Settings: C5-01□C5-02

- Set the proportional gain (C5-01) and the integral time (C5-02) of the speed control (ASR).

User Constant Number	Name	Change during Operation	Setting Range	Unit	Factory Setting	Valid Access Levels			
						V/f Control	V/f with PG	Open Loop Vector	Flux Vector
C5-01	ASR proportional (P) gain 1	○	0.00 to 300.00	Multiple	0.20	X	B	X	B
C5-02	ASR integral (I) time 1	○	0.000 to 10.000	s	0.200	X	B	X	B

Min. Output Frequency Gain Settings: C5-03□C5-04

- Set ASR proportional gain 2 (C5-03) and ASR integral time 2 (C5-04) for the minimum output frequency.

User Constant Number	Name	Change during Operation	Setting Range	Unit	Factory Setting	Valid Access Levels			
						V/f Control	V/f with PG	Open Loop Vector	Flux Vector
C5-03	ASR proportional (P) gain 2	○	0.00 to 300.00	Multiple	0.02	X	B	X	B
C5-04	ASR integral (I) time 2	○	0.000 to 10.000	s	0.050	X	B	X	B

- Figure 6.22 shows how the proportional gain and integral time are calculated from constants C5-01 through C5-04.

6.5.5 Adjusting Speed Control (ASR) Gain

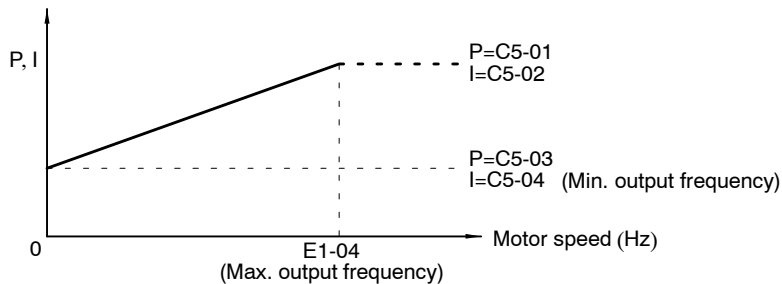

Fig 6.22 Minimum Output Frequency Gain Settings

■ Multi-function Input Settings: H1-01 (Terminal 11) to H1-06 (Terminal 16)

V/f Mode Select Setting: “D”

- When one of the multi-function inputs is set to “D,” the input can be used to enable and disable the speed control.
- The speed control is disabled (normal V/f control) when the multi-function input is ON.

ASR Integral Reset Setting: “E”

- When one of the multi-function inputs is set to “E,” the input can be used to switch the speed control between P control and PI control.
- P control (integral reset) is used when the multi-function input is ON.

6.5.5 Adjusting Speed Control (ASR) Gain

Use the following procedure to adjust the gain with the mechanical system and actual load connected.

■ Gain Adjustments at Minimum Output Frequency

1. Operate the motor at the minimum output frequency.
2. Increase C5-03 (ASR proportional gain 2) to a level where there is no oscillation.
3. Decrease C5-04 (ASR integral time 2) to a level where there is no oscillation.
4. Monitor the Inverter’s output current and verify that it is less than 50% of the Inverter rated current. If the output current exceeds 50% of the Inverter’s rated current, decrease C5-03 and increase C5-04.

■ Gain Adjustments at Maximum Output Frequency

1. Operate the motor at the maximum output frequency.
2. Increase C5-01 (ASR proportional gain 1) to a level where there is no oscillation.
3. Decrease C5-02 (ASR integral time 1) to a level where there is no oscillation.

■ Gain Adjustments for Integral Control during Acceleration/Deceleration

- Enable integral operation during acceleration and deceleration (with F1-07) when you want the motor speed to closely follow the frequency reference during acceleration and deceleration. Integral operation causes the speed to reach the target speed as fast as possible, but may result in overshooting or under-shooting.
1. Set F1-07 to “1” to enable integral operation at all times.
 2. Make the constant settings shown below in order to observe the speed waveform while making fine adjustments to the gain.

Constant	Setting	Explanation
H4-01 Analog output selection (terminal 45)	2	Settings that allow multi-function analog output 1 to be used to monitor the output frequency.
H4-02 Analog output gain (terminal 45)	1.00	
H4-03 Analog output bias (terminal 45)	0.0	

6

Constant	Setting	Explanation
H4-04 Analog output selection (terminal 48)	5	Settings that allow multi-function analog output 2 to be used to monitor the motor speed.
H4-05 Analog output gain (terminal 48)	1.00	
H4-06 Analog output bias (terminal 48)	0.0	
H4-07 Analog output level selection	1	This setting allows a 0 to ± 10 V signal range to be monitored.

The multi-function analog outputs have the following functions with these constant settings.

- Multi-function analog output 1 (terminal 45): Outputs Inverter's output frequency (0 to ± 10 V).
- Multi-function analog output 2 (terminal 48): Outputs the actual motor speed (0 to ± 10 V).

Terminal 46 is the multi-function analog output common.

We recommend monitoring both the output frequency and the motor speed to monitor the response delay or deviations from the reference value, as shown in the following diagram.

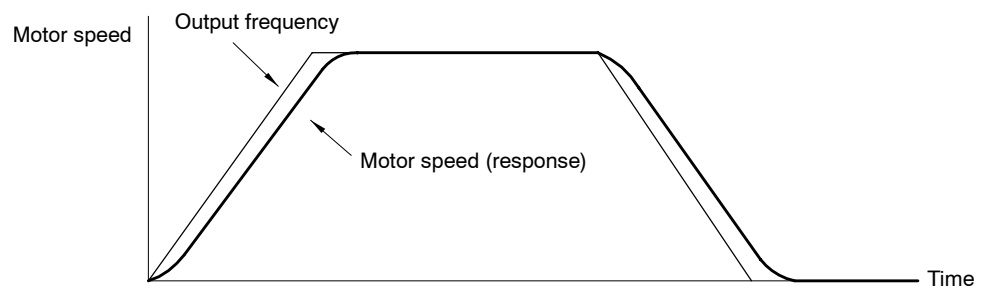

Fig 6.23 Example Monitor Waveforms

3. Give acceleration/deceleration commands and adjust the gain while observing the waveform.

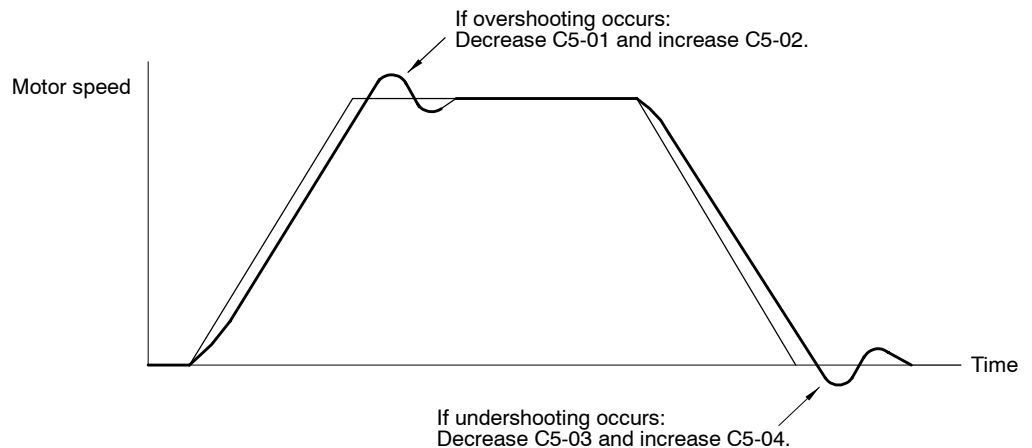

Fig 6.24 Gain Adjustments

6.5.5 Adjusting Speed Control (ASR) Gain

4. If the overshooting or undershooting can't be eliminated by adjusting the gain, decrease the ASR limit (C5-05) to lower the frequency reference compensation limit.

User Constant Number	Name	Change during Operation	Setting Range	Unit	Factory Setting	Valid Access Levels			
						V/f Control	V/f with PG	Open Loop Vector	Flux Vector
C5-05	ASR limit	X	0.0 to 20.0	%	5.0	X	A	X	X

- Since C5-05 can't be changed during operation, stop the Inverter's operation and then decrease the ASR limit by 0.5 (%).
- Perform step 3 again after the setting has been changed.
- The ASR limit is the frequency limit for compensation by speed control. Set this frequency limit as a percentage of the maximum output frequency.
- If the frequency limit is lowered too much, the motor speed might not reach the target speed. Verify that the target speed is reached during normal operation.

7

Advanced Operation

This chapter describes the user constants used for specific control methods in VS-616G5 application.

7.1 Open-loop Vector Control	7 - 2
7.1.1 Torque Limit Function	7 - 4
7.1.2 Adjusting Speed Feedback	7 - 5
7.1.3 Setting/Adjusting Motor Constants	7 - 6
7.2 Normal V/f Control	7 - 10
7.2.1 Energy-saving Control Function	7 - 12
7.2.2 Hunting-prevention Function	7 - 12
7.2.3 Setting Motor Constants	7 - 13
7.3 Flux Vector Control	7 - 15
7.3.1 Droop Control Function	7 - 17
7.3.2 Zero-servo Function	7 - 18
7.3.3 Torque Control	7 - 19
7.3.4 Speed/Torque Control Switching Function	7 - 26
7.3.5 Torque Limit Function	7 - 27
7.3.6 Setting/Adjusting Motor Constants	7 - 29
7.4 V/f Control with PG Feedback	7 - 33
7.4.1 Energy-saving Control Function	7 - 35
7.4.2 Hunting-prevention Function	7 - 35
7.4.3 Setting Motor Constants	7 - 36
7.5 Common Functions	7 - 38
7.5.1 Application Constants: b	7 - 41
7.5.2 Tuning Constants: C	7 - 50
7.5.3 Reference Constants: d	7 - 54
7.5.4 Option Constants: F	7 - 56
7.5.5 External Terminal Functions: H	7 - 62
7.5.6 Protective Functions: L	7 - 84
7.5.7 Operator Constants: o	7 - 99

7.1 Open-loop Vector Control

The functions that can be used with open-loop vector control are listed in *Table 7.1*. Details on functions that are specific to open-loop vector control (i.e. those marked with a *) are provided in the following table.

Table 7.1 Open-loop Vector Control Functions

Group	Function	Comments	Control Method			
			V/f	V/f w/PG	Open-loop Vector	Flux Vector
b Application	b1 Sequence	Settings such as the reference input method	○	○	○	○
	b2 DC Injection Braking	DC injection braking function settings	○	○	○	○
	b3 Speed Search	Speed search function settings	○	○	○	○
	b4 Delay Timers	Timer function settings	○	○	○	○
	b5 PID Control	PID control settings	○	○	○	○
	b6 Dwell Functions	Acceleration/deceleration time dwell function settings	○	○	○	○
	b7 Droop Control	Not used. (Can't be set.)	X	X	X	○
	b8 Energy Saving	Not used. (Can't be set.)	○	○	X	X
	b9 Zero Servo	Not used. (Can't be set.)	X	X	X	○
C Tuning	C1 Accel/Decel	Acceleration/deceleration time settings	○	○	○	○
	C2 S-Curve Acc/Dec	S-curve characteristics for acceleration/deceleration times	○	○	○	○
	C3 Motor-Slip Compensation	Slip compensation function settings	○	○	○	○
	C4 Torque Compensation	Torque compensation function settings	○	○	○	X
	C5 Speed Controls	Not used. (Can't be set.)	X	○	X	○
	C6 Carrier Frequency	Carrier frequency settings	○	○	○	○
	C7 Hunting Prevention	Not used. (Can't be set.)	○	○	X	X
	C8 Factory Tuning	* Adjustment for open-loop vector control	X	X	○	○
d Reference	d1 Preset Reference	Frequency reference settings (when using Operator)	○	○	○	○
	d2 Reference Limits	Frequency upper and lower limit settings	○	○	○	○
	d3 Jump Frequencies	Prohibited frequency settings	○	○	○	○
	d4 Reference Frequency Hold Function	Up/Down, Accel/Decel stop hold frequency setting	○	○	○	○
	d5 Torque Control	Not used. (Can't be set.)	X	X	X	○
E Motor	E1 V/f Pattern	* Motor constant settings	○	○	○	○
	E2 Motor Setup	(Motor constants are set by the autotuning function.)	○	○	○	○
	E3 Motor 2 Control Methods	Control method settings for motor 2.	○	○	○	○
	E4 Motor 2 V/f Characteristics	V/f characteristics settings for motor 2.	○	○	○	○
	E5 Motor 2 Motor Constants	Motor constant settings for motor 2.	○	○	○	○
F Options	F1 PG speed control card settings	User constant settings for a PG Card	X	○	X	○
	F2 Analog Reference Card AI	User constant settings for an Analog Reference Card	○	○	○	○
	F3 Digital Reference Card DI	User constant settings for a Digital Reference Card	○	○	○	○
	F4 Analog Monitor Card AO	User constant settings for an Analog Monitor Card	○	○	○	○
	F5 Digital Output Card DO	User constant settings for a Digital Output Card	○	○	○	○
	F6 Digital Output Card DO	User constant settings for a Digital Output Card	○	○	○	○
	F7 Pulse Monitor Card PO	User constant settings for a Pulse Monitor Card	○	○	○	○
	F8 SI-F/SI-G Transmission Card	User constant settings for a Transmission Card	○	○	○	○
	F9 CP-916B Transmission Card	User constant settings for a Transmission Card	○	○	○	○

7

Group	Function	Comments	Control Method				
			V/f	V/f w/PG	Open-loop Vector	Flux Vector	
H	Terminal	H1 Multi-function Inputs	Function selection for multi-function inputs	<input type="radio"/>	<input type="radio"/>	<input type="radio"/>	<input type="radio"/>
		H2 Multi-function Outputs	Function selection for multi-function outputs	<input type="radio"/>	<input type="radio"/>	<input type="radio"/>	<input type="radio"/>
		H3 Analog Inputs	Function selection for analog inputs	<input type="radio"/>	<input type="radio"/>	<input type="radio"/>	<input type="radio"/>
		H4 Multi-function Analog Outputs	Function selection for analog outputs	<input type="radio"/>	<input type="radio"/>	<input type="radio"/>	<input type="radio"/>
		H5 MEMOBUS Communications	MEMOBUS communications settings	<input type="radio"/>	<input type="radio"/>	<input type="radio"/>	<input type="radio"/>
L	Protection	L1 Motor Protection Functions	Sets thermal functions that protect the motor.	<input type="radio"/>	<input type="radio"/>	<input type="radio"/>	<input type="radio"/>
L	Protection	L2 Power Loss Ridethru	Selects the power-loss processing method.	<input type="radio"/>	<input type="radio"/>	<input type="radio"/>	<input type="radio"/>
L	Protection	L3 Stall Prevention	Accel/Decel stall prevention settings and selection	<input type="radio"/>	<input type="radio"/>	<input type="radio"/>	<input type="radio"/>
L	Protection	L4 Reference Detection	Frequency detection settings and selection	<input type="radio"/>	<input type="radio"/>	<input type="radio"/>	<input type="radio"/>
L	Protection	L5 Fault Restart	Fault restart function settings	<input type="radio"/>	<input type="radio"/>	<input type="radio"/>	<input type="radio"/>
L	Protection	L6 Torque Detection	Sets overtorque detection functions 1 and 2 (by torque)	<input type="radio"/>	<input type="radio"/>	<input type="radio"/>	<input type="radio"/>
L	Protection	L7 Torque Limit	* Four-quadrant individual torque limit settings	<input checked="" type="radio"/>	<input checked="" type="radio"/>	<input type="radio"/>	<input type="radio"/>
L	Protection	L8 Hardware Protection	Hardware overheating and open-phase protection settings	<input type="radio"/>	<input type="radio"/>	<input type="radio"/>	<input type="radio"/>
o	Operator	o1 Monitor Select	Selects the Operator's display and setting methods.	<input type="radio"/>	<input type="radio"/>	<input type="radio"/>	<input type="radio"/>
o	Operator	o2 Key Selections	Operator's key function selection and other constants	<input type="radio"/>	<input type="radio"/>	<input type="radio"/>	<input type="radio"/>

7.1.1 Torque Limit Function

With open-loop vector control, torque limits can be applied at an arbitrary value because the torque output by the motor is calculated internally.

The torque limit function is useful when the load cannot sustain a torque above a certain level or to maintain the regenerative torque above a certain level. The two ways to apply torque limits are listed below. (The lower torque limit will be used if both of these methods are set.)

- Setting a torque limit with the constants
- Limiting torque with the analog inputs

IMPORTANT

The accuracy of the torque limit is $\pm 5\%$ for output frequencies above 10 Hz, but the accuracy is lower for output frequencies below 10 Hz. Use flux vector control if you want to apply a torque limit at low-speed (below 10 Hz) or to run the motor in a direction reverse to the designated running direction.

■ Torque Limits: L7-01 through L7-04

Torque limits can be set separately for the 4 ways that torque can be applied: forward torque, reverse torque, forward regenerative torque, and reverse regenerative torque.

User Constant Number	Name	Change during Operation	Setting Range	Unit	Factory Setting	Valid Access Levels			
						V/f Control	V/f with PG	Open Loop Vector	Flux Vector
L7-01	Forward torque limit	X	0 to 300	%	200	X	X	B	B
L7-02	Reverse torque limit	X	0 to 300	%	200	X	X	B	B
L7-03	Forward regenerative torque limit	X	0 to 300	%	200	X	X	B	B
L7-04	Reverse regenerative torque limit	X	0 to 300	%	200	X	X	B	B

Figure 7.1 shows the relationship between each constant and the output torque.

When the torque limit function is used, the torque limits have priority and motor speed control and compensation will be disregarded, so the acceleration/deceleration times might be lengthened and motor speed might be reduced.

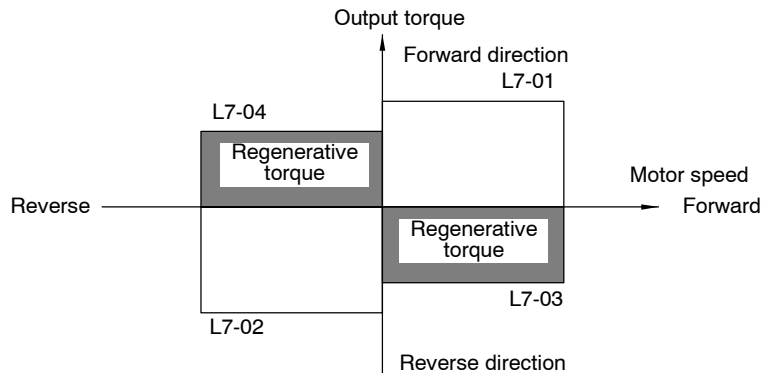

Fig 7.1 Torque Limit Function

■ Limiting Torque with Analog Inputs: H3-05, H3-09

The following two analog inputs that can be used to limit torque.

Multi-function analog input, terminal 42

Frequency reference (current), terminal 39

Use either or both of these inputs as needed with constants H3-05 and H3-09.

User Constant Number	Name	Change during Operation	Setting Range	Unit	Factory Setting	Valid Access Levels			
						V/f Control	V/f with PG	Open Loop Vector	Flux Vector
H3-05	Multi-function analog input (terminal 42)	X	0 to 1F	-	0	B	B	B	B
H3-09	Multi-function analog input (terminal 39)	X	1 to 1F	-	1F	A	A	A	A

- Settings

Setting	Name
10	Forward Torque Limit
11	Reverse Torque Limit
12	Regenerative Torque Limit
15	Forward/Reverse Torque Limit

- The above table shows only those settings related to the torque limit function.
- Set the analog input terminal's signal level, gain, and bias to match the actual input signal.
- The factory settings for the input terminal's signal level are as follows:
 - Terminal 42: 0 to 10 V (A 10 V input limits the torque to 100% of the motor's rated torque.)
 - Terminal 39: 4 to 20 mA (A 20 mA input limits the torque to 100% of the motor's rated torque.)

Figure 7.2 shows the relationship between the output torque and each torque limit.

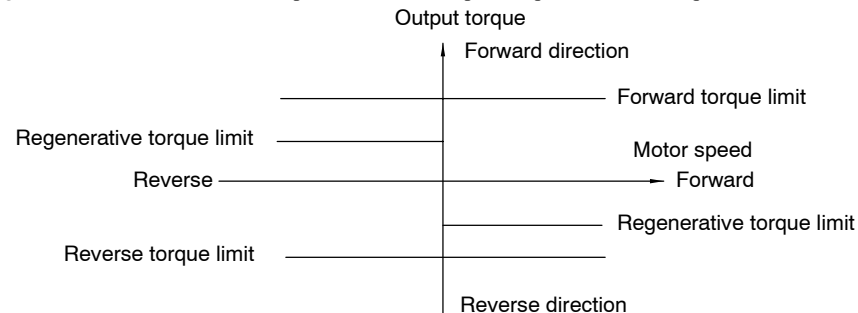

Fig 7.2 Limiting Torque with Analog Inputs

- When the forward torque limit has been set, the analog input signal acts as the limit value for torque generated in the forward direction. The torque limit input is effective when torque is generated in the forward direction even if the motor is operating in reverse (regenerative torque).
- The torque limit is 100% of the motor's rated torque when the analog input is at its maximum value (10 V or 20 mA). To increase the torque limit above 100%, set the input terminal's gain above 100%. For example, a gain of 150.0% would result in a torque limit of 150% of the motor's rated torque with a 10 V or 20 mA analog input.
 - Gain for multi-function analog input, terminal 42: H3-06
 - Gain for frequency reference (current), terminal 39: H3-10

7.1.2 Adjusting Speed Feedback

With open-loop vector control, internal Inverter data is used to calculate the feedback value. The gain of this automatic frequency regulator (AFR) operation can be fine-tuned according to motor response. (Normally it isn't necessary to change the default setting.)

■ Speed Feedback Detection Control (AFR) Gain: C8-08

User Constant Number	Name	Change during Operation	Setting Range	Unit	Factory Setting	Valid Access Levels			
						V/f Control	V/f with PG	Open Loop Vector	Flux Vector
C8-08	AFR gain	X	0.00 to 10.00	Multiple	1.00	X	X	A	X

- Normally it isn't necessary to change this setting.

- Fine-tune the gain when motor operation is unstable causing hunting to occur or torque/speed responsiveness is low.
 - When hunting occurs, increase the gain by 0.05 increments while checking the motor responsiveness.
 - When responsiveness is low, decrease the gain by 0.05 increments while checking the motor responsiveness.

7.1.3 Setting/Adjusting Motor Constants

■ Adjusting the V/f Pattern: E1-04 through E1-10, E1-13

Normally it isn't necessary to adjust the V/f pattern with open-loop vector control. Adjust the V/f pattern when you want to change the maximum output frequency setting or decrease the Inverter's output voltage or when stalls are occurring during no-load operation.

To increase the motor's rated speed, increase the maximum output frequency in E1-04 in programming mode after autotuning.

It is possible to make user-defined V/f pattern settings (E1-04 through E1-10) in open-loop vector control mode. (The preset V/f patterns cannot be selected.)

User Constant Number	Name	Change during Operation	Setting Range	Unit	Factory Setting	Valid Access Levels			
						V/f Control	V/f with PG	Open Loop Vector	Flux Vector
E1-04	Max. output frequency	x	50.0 to 150.0	Hz	60.0	Q	Q	Q	Q
E1-05	Max. voltage	x	0.0 to $\frac{510.0}{*1}$	VAC	400.0 ^{*1}	Q	Q	Q	Q
E1-06	Base frequency	x	0.0 to 150.0	Hz	150.0	Q	Q	Q	Q
E1-07	Mid. output frequency	x	0.0 to 150.0	Hz	3.0 ^{*2}	Q	Q	A	x
E1-08	Mid. output frequency voltage	x	0.0 to $\frac{510.0}{*1}$	VAC	$\frac{22.0}{*1, *2}$	Q	Q	A	x
E1-09	Min. output frequency	x	0.0 to 150.0	Hz	0.5	Q	Q	Q	A
E1-10	Min. output frequency voltage	x	0.0 to $\frac{510.0}{*1}$	VAC	$\frac{4.0}{*1, *2}$	Q	Q	A	x
E1-13	Base voltage	x	0.0 to 510.0	VAC	0.0	A	A	Q	Q

* 1. These voltages are for 400-V Class Inverters; multiply the voltage by approx. 1.5 for 575-V Class Inverters.

* 2. The default setting depends on the Inverter's capacity. The default settings shown in the table are for 400-V Class, 200 to 800 kW Inverters. (See page 8 - 42.)

Note 1. The default settings for E1-07 through E1-10 depend on the control method. The default settings shown in the table are for open-loop vector control. (See page 8 - 41.)

2. The four frequency settings must satisfy the following formula:

$$E1-04 (F_{MAX}) \geq E1-06 (F_A) > E1-07 (F_B) \geq E1-09 (F_{MIN})$$

3. When making the V/f characteristics a straight line, set the same value in E1-07 (middle output frequency) and E1-09 (minimum output frequency). In this case, constant E1-08 (middle output frequency voltage) will be disregarded.

4. If E1-13 is set to 0.0, the same value as in E1-13 will be set for E1-05. It does not normally need to be set separately.

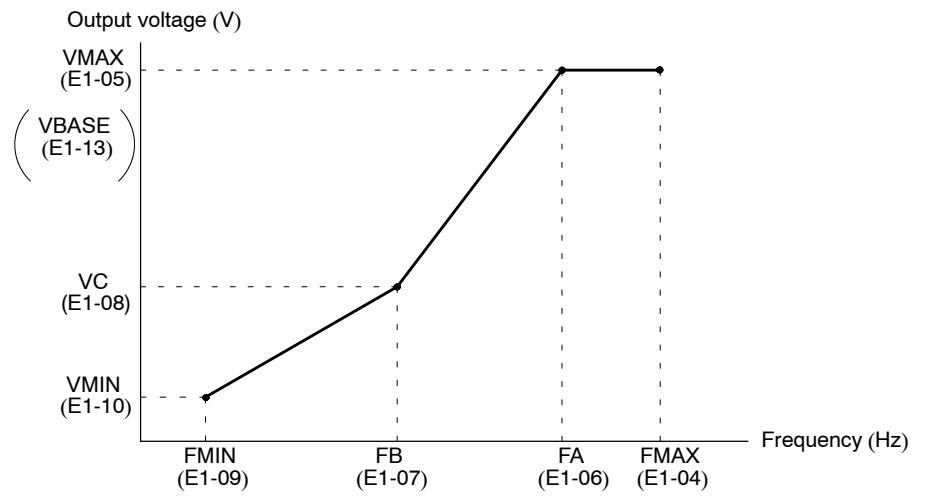

Fig 7.3 User-defined V/f Pattern

Adjusting Output Voltage: VC (E1-08), VMIN (E1-10)

Adjust the output voltage when you want to output more torque at low speed, such as in an elevator, or when torque isn't really necessary and you want to reduce the output voltage to save energy.

Adjustment range: 400-V class Inverters: Initial value ±0 to 2 V
 575-V class Inverters: Initial value ±0 to 4 V

- When generating more torque, gradually increase the voltage but do not exceed 100% of the motor's rated current.
- When saving energy, decrease the voltage but do not cause stalling.

Setting the Maximum Output Frequency

The maximum output frequency can be set from 50.0 to 150.0 Hz. Set this constant in accordance with the motor's maximum rotational speed.

■ **Setting Motor Constants: E2-01 through E2-03 (E5-01 through E5-03), E2-05 through E2-08 (E5-05, E5-06)**

- The motor constants (function E2) will all be set automatically when autotuning is performed, so it normally isn't necessary to set them manually. Set these constants manually if autotuning can't be completed properly.
- User constant numbers for motor 2 are given in parentheses.

Motor Rated Current: E2-01

User Constant Number	Name	Change during Operation	Setting Range	Unit	Factory Setting	Valid Access Levels			
						V/f Control	V/f with PG	Open Loop Vector	Flux Vector
E2-01 (E5-01)	Motor rated current	x	37.0 to 740.0	A	370.0	Q	Q	Q	Q

- The setting range is 10% to 200% of the Inverter rated output current. The default setting depends upon the Inverter capacity. (The table shows the default setting for 400-V class, 200 kW Inverters.) (See page 8 - 42.)
- Set the rated current (A) shown on the motor nameplate.

Motor Rated Slip: E2-02

User Constant Number	Name	Change during Operation	Setting Range	Unit	Factory Setting	Valid Access Levels			
						V/f Control	V/f with PG	Open Loop Vector	Flux Vector
E2-02 (E5-02)	Motor rated slip	x	0.00 to 20.00	Hz	1.30	A	A	Q	Q

- The default setting depends upon the Inverter capacity. (The table shows the default settings for 400-V class, 200 kW Inverters.)
- Calculate the rated slip (E2-02) from the value shown on the motor nameplate with the following equation and set this value.

$$\text{Rated slip} = \text{rated frequency (Hz)} - \text{rated speed (r/min)} \times \text{number of poles}/120$$

Motor No-load Current: E2-03

User Constant Number	Name	Change during Operation	Setting Range	Unit	Factory Setting	Valid Access Levels			
						V/f Control	V/f with PG	Open Loop Vector	Flux Vector
E2-03 (E5-03)	Motor no-load current	x	0.00 to 2000.0	A	96.0	A	A	Q	Q

- The default setting depends upon the Inverter capacity. (The table shows the default settings for 400-V class, 200 kW Inverters.)
- Set the no-load current (E2-03) at the rated voltage and rated frequency. Normally this value isn't shown on the motor nameplate, so it might be necessary to contact the motor manufacturer.

Motor Line-to-line Resistance: E2-05

User Constant Number	Name	Change during Operation	Setting Range	Unit	Factory Setting	Valid Access Levels			
						V/f Control	V/f with PG	Open Loop Vector	Flux Vector
E2-05 (E5-05)	Motor line-to-line resistance	x	0.000 to 65.000	Ω	0.020	A	A	A	A

- The default setting depends upon the Inverter capacity.
(The table shows the default settings for 400-V class, 200 kW Inverters.)
- Set the motor terminal resistance (U-V, V-W, and W-U) in constant E2-05. Normally this value isn't shown on the motor nameplate, so it might be necessary to contact the motor manufacturer for the terminal resistance at the insulation class temperature. Use the following equations to calculate the resistance value from the terminal resistance of a test report.
 - E-class insulation: Terminal resistance at 75°C in the test report (Ω) x 0.92
 - B-class insulation: Terminal resistance at 75°C in the test report (Ω) x 0.92
 - F-class insulation: Terminal resistance at 115°C in the test report (Ω) x 0.87

Motor Leakage Inductance: E2-06

User Constant Number	Name	Change during Operation	Setting Range	Unit	Factory Setting	Valid Access Levels			
						V/f Control	V/f with PG	Open Loop Vector	Flux Vector
E2-06 (E5-06)	Motor leak inductance	x	0.0 to 30.0	%	5.0	x	x	A	A

- The default setting depends upon the Inverter capacity.
(The table shows the default settings for 400-V class, 200 kW Inverters.)
- Set the voltage drop (caused by the motor's leakage inductance) as a percentage of the motor's rated voltage in constant E2-06.
- This constant does not normally required setting because the Inverter automatically compensates during operation.
- Normally this value isn't shown on the motor nameplate, so it might be necessary to contact the motor manufacturer. It is also acceptable to set the loss (caused by the motor's leakage inductance) as a percentage.

Motor Iron-core Saturation Coefficients 1, 2: E2-07, E2-08

User Constant Number	Name	Change during Operation	Setting Range	Unit	Factory Setting	Valid Access Levels			
						V/f Control	V/f with PG	Open Loop Vector	Flux Vector
E2-07	Motor iron-core saturation coefficient 1	x	0.00 to 0.50	-	0.50	x	x	A	A
E2-08	Motor iron-core saturation coefficient 2	x	0.00 to 0.75	-	0.75	x	x	A	A

- Constants E2-07 and E2-08 are not required when using the motor at or below the rated frequency.
- Set these constants when operating at a frequency higher than the motor's rated frequency. Set the following values:
 - Motor iron-core saturation coefficient 1: Core-saturation coefficient when magnetic flux is 50%.
 - Motor iron-core saturation coefficient 2: Core-saturation coefficient when magnetic flux is 75%.
- Normally these values aren't shown on the motor nameplate, so it might be necessary to contact the motor manufacturer. Operation will be possible with the factory-preset values.

7.2 Normal V/f Control

The functions that can be used with normal vector control are listed in *Table 7.2*. Details on functions that are specific to normal vector control (i.e. those marked with a *) are provided in the following table.

Table 7.2 Normal V/f Control Functions

Group	Function	Comments	Control Method			
			V/f	V/f w/PG	Open-loop Vector	Flux Vector
b Application	b1 Sequence	Settings such as the reference input method	○	○	○	○
	b2 DC Injection Braking	DC injection braking function settings	○	○	○	○
	b3 Speed Search	Speed search function settings	○	○	○	○
	b4 Delay Timers	Timer function settings	○	○	○	○
	b5 PID Control	PID control settings	○	○	○	○
	b6 Dwell Functions	Acceleration/deceleration time dwell function settings	○	○	○	○
	b7 Droop Control	Not used. (Can't be set.)	X	X	X	○
	b8 Energy Saving	* Multi-function input: Energy-saving control settings	○	○	X	X
	b9 Zero Servo	Not used. (Can't be set.)	X	X	X	○
C Tuning	C1 Accel/Decel	Acceleration/deceleration time settings	○	○	○	○
	C2 S-Curve Acc/Dec	S-curve characteristics for accel/decel times	○	○	○	○
	C3 Motor-Slip Compensation	Slip compensation function settings	○	○	○	○
	C4 Torque Compensation	Torque compensation function settings	○	○	○	X
	C5 Speed Controls	Not used. (Can't be set.)	X	○	X	○
	C6 Carrier Frequency	Carrier frequency settings	○	○	○	○
	C7 Hunting Prevention	* Hunting prevention function settings	○	○	X	X
	C8 Factory Tuning	Not used. (Can't be set.)	X	X	○	X
d Reference	d1 Preset Reference	Frequency reference settings (when using Operator)	○	○	○	○
	d2 Reference Limits	Frequency upper and lower limit settings	○	○	○	○
	d3 Jump Frequencies	Prohibited frequency settings	○	○	○	○
	d4 Reference Frequency Hold Function	Up/Down, Accel/Decel stop hold frequency setting	○	○	○	○
	d5 Torque Control	Not used. (Can't be set.)	X	X	X	○
E Motor	E1 V/f Pattern	* Motor constant settings (Motor constants set manually.)	○	○	○	○
	E2 Motor Setup		○	○	○	○
	E3 Motor 2 Control Methods	Control method settings for motor 2.	○	○	○	○
	E4 Motor 2 V/f Characteristics	V/f characteristics settings for motor 2.	○	○	○	○
	E5 Motor 2 Motor Constants	Motor constant settings for motor 2.	○	○	○	○
F Options	F1 PG speed control card settings	Not used. (Can't be set.)	X	○	X	○
	F2 Analog Reference Card AI	User constant settings for an Analog Reference Card	○	○	○	○
	F3 Digital Reference Card DI	User constant settings for a Digital Reference Card	○	○	○	○
	F4 Analog Monitor Card AO	User constant settings for an Analog Monitor Card	○	○	○	○
	F5 Digital Output Card DO	User constant settings for a Digital Output Card	○	○	○	○
	F6 Digital Output Card DO	User constant settings for a Digital Output Card	○	○	○	○
	F7 Pulse Monitor Card PO	User constant settings for a Pulse Monitor Card	○	○	○	○
	F8 SI-F/SI-G Transmission Card	User constant settings for a Transmission Card	○	○	○	○
	F9 CP-916B Transmission Card	User constant settings for a Transmission Card	○	○	○	○

Group	Function	Comments	Control Method				
			V/f	V/f w/PG	Open-loop Vector	Flux Vector	
H Terminal	H1	Multi-function Inputs	Function selection for multi-function inputs	<input type="radio"/>	<input type="radio"/>	<input type="radio"/>	<input type="radio"/>
	H2	Multi-function Outputs	Function selection for multi-function outputs	<input type="radio"/>	<input type="radio"/>	<input type="radio"/>	<input type="radio"/>
	H3	Analog Inputs	Function selection for analog inputs	<input type="radio"/>	<input type="radio"/>	<input type="radio"/>	<input type="radio"/>
	H4	Multi-function Analog Outputs	Function selection for analog outputs	<input type="radio"/>	<input type="radio"/>	<input type="radio"/>	<input type="radio"/>
	H5	MEMOBUS Communications	MEMOBUS communications settings	-	-	-	-
L Protection	L1	Motor Overload	Sets electrical/thermal functions that protect the motor.	<input type="radio"/>	<input type="radio"/>	<input type="radio"/>	<input type="radio"/>
	L2	Power Loss Ridethru	Selects the power-loss processing method.	<input type="radio"/>	<input type="radio"/>	<input type="radio"/>	<input type="radio"/>
	L3	Stall Prevention	Accel/Decel/Run stall prevention settings and selection	<input type="radio"/>	<input type="radio"/>	<input type="radio"/>	<input type="radio"/>
	L4	Ref Detection	Frequency detection settings	<input type="radio"/>	<input type="radio"/>	<input type="radio"/>	<input type="radio"/>
	L5	Fault Restart	Fault restart function settings	<input type="radio"/>	<input type="radio"/>	<input type="radio"/>	<input type="radio"/>
	L6	Torque Detection	Sets overtorque detection functions 1 and 2 (by current)	<input type="radio"/>	<input type="radio"/>	<input type="radio"/>	<input type="radio"/>
	L7	Torque Limit	Not used. (Can't be set.)	X	X	<input type="radio"/>	<input type="radio"/>
	L8	Hardware Protection	Hardware overheating and open-phase protection settings	<input type="radio"/>	<input type="radio"/>	<input type="radio"/>	<input type="radio"/>
o Operator	o1	Monitor Select	Selects the Operator's display and setting methods.	<input type="radio"/>	<input type="radio"/>	<input type="radio"/>	<input type="radio"/>
	o2	Key Selections	Operator's key function selection and other constants	<input type="radio"/>	<input type="radio"/>	<input type="radio"/>	<input type="radio"/>

7.2.1 Energy-saving Control Function

The energy-saving control function is enabled when the energy-saving command (setting 63) has been set in a multi-function input (H1-01 through H1-06). Inputting the energy-saving command while there is a light load causes the Inverter's output voltage to be reduced and saves energy. Turn OFF the energy-saving command when a normal load is added.

■ Energy-saving Gain: b8-01

User Constant Number	Name	Change during Operation	Setting Range	Unit	Factory Setting	Valid Access Levels			
						V/f Control	V/f with PG	Open Loop Vector	Flux Vector
b8-01	Energy-saving gain	x	0 to 100	%	80	A	A	x	x

- Constant b8-01 determines the Inverter's output voltage when the energy-saving command is input. Set this value as a percentage of the V/f pattern's voltage.
- Constant L2-04 (the voltage recovery time) determines the rate at which the output voltage is changed when the energy-saving command is turned ON or OFF.

■ Energy-saving Frequency: b8-02

User Constant Number	Name	Change during Operation	Setting Range	Unit	Factory Setting	Valid Access Levels			
						V/f Control	V/f with PG	Open Loop Vector	Flux Vector
b8-02	Energy-saving frequency	x	0.0 to 150.0	Hz	0.0	A	A	x	x

- Constant b8-02 determines the lower limit frequency for the energy-saving function.
- The energy-saving command is enabled only when the frequency reference is above the energy-saving frequency and the motor speed is within the "speed agree" range.
A time chart for energy-saving operation is shown below.

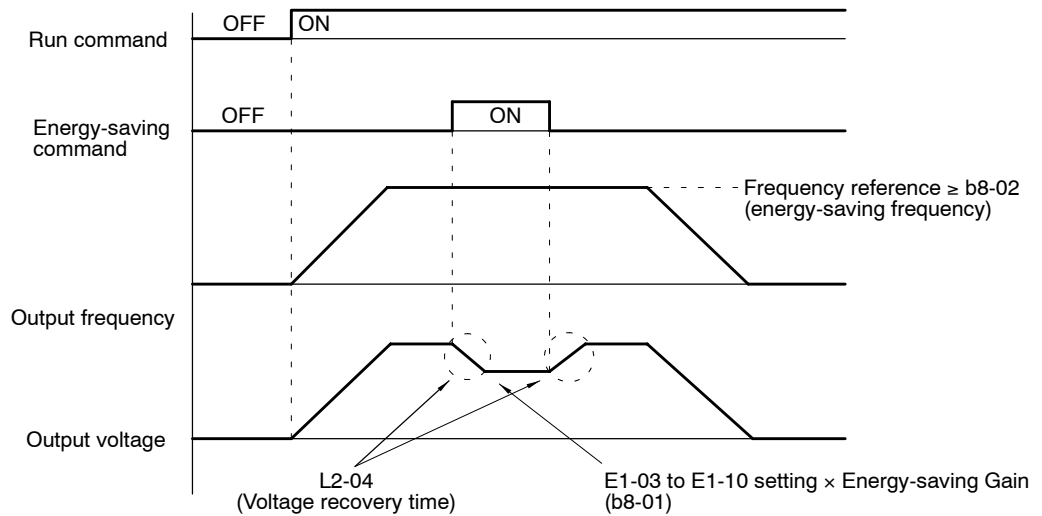

Fig 7.4 Time Chart for Energy-saving Operation

7.2.2 Hunting-prevention Function

The hunting-prevention function suppresses hunting when the motor is operating with a light load. This function is valid with V/f control and V/f with PG feedback control.

■ Hunting Prevention Selection: C7-01

User Constant Number	Name	Change during Operation	Setting Range	Unit	Factory Setting	Valid Access Levels			
						V/f Control	V/f with PG	Open Loop Vector	Flux Vector
C7-01	Hunting prevention selection	x	0, 1	-	1	A	A	x	x

- Settings

Setting	Function
0	Disables the hunting-prevention function.
1	Enables the hunting-prevention function.

■ Hunting Prevention Gain: C7-02

User Constant Number	Name	Change during Operation	Setting Range	Unit	Factory Setting	Valid Access Levels			
						V/f Control	V/f with PG	Open Loop Vector	Flux Vector
C7-02	Hunting prevention gain	x	0.00 to 2.50	Multiple	1.00	A	A	x	x

Normally it isn't necessary to change these constants. Adjust these constants as follows if hunting occurs with a light load.

- Increase the setting in C7-02 if oscillation occurs when operating with a light load. (If the setting is increased too much, the current can fall to the point where stalling occurs.)
- Decrease the setting in C7-02 if stalling occurs.
- Disable the hunting-prevention function (C7-01 = 0) if high responsiveness is more important than suppressing oscillation.

7.2.3 Setting Motor Constants

■ Motor Rated Slip: E2-02

User Constant Number	Name	Change during Operation	Setting Range	Unit	Factory Setting	Valid Access Levels			
						V/f Control	V/f with PG	Open Loop Vector	Flux Vector
E2-02	Motor rated slip	x	0.00 to 20.00	Hz	1.30	A	A	Q	Q

- This setting is used as a reference value for the torque compensation function.
- The default setting depends upon the Inverter capacity. (The table shows the default settings for 400-V class, 200 kW Inverters.) (See page 8 - 42.)
- Calculate the rated slip (E2-02) from the value shown on the motor nameplate with the following equation and set this value.

$$\text{Rated slip} = \text{rated frequency (Hz)} - \text{rated speed (r/min)} \times \text{number of poles}/120$$

■ Motor No-load Current: E2-03

User Constant Number	Name	Change during Operation	Setting Range	Unit	Factory Setting	Valid Access Levels			
						V/f Control	V/f with PG	Open Loop Vector	Flux Vector
E2-03	Motor no-load current	x	0.00 to 2000.0	A	96.0	A	A	Q	Q

- This setting is used as a reference value for the torque compensation function.
- The default setting depends upon the Inverter capacity. (The table shows the default settings for 400-V class, 200 kW Inverters.) (See page 8 - 42.)
- Set the no-load current (E2-03) at the rated voltage and rated frequency. Normally this value isn't shown on the motor nameplate, so it might be necessary to contact the motor manufacturer.

■ **Motor Line-to-line Resistance: E2-05**

User Constant Number	Name	Change during Operation	Setting Range	Unit	Factory Setting	Valid Access Levels			
						V/f Control	V/f with PG	Open Loop Vector	Flux Vector
E2-05	Motor line-to-line resistance	x	0.000 to 65.000	Ω	0.020	A	A	A	A

- This setting is used as a reference value for the torque compensation function.
- The default setting depends upon the Inverter capacity. (The table shows the default settings for 400-V class, 200 kW Inverters.) (See page 8 - 42.)
- Set the motor's terminal resistance (U-V, V-W, and W-U). Normally this value isn't shown on the motor nameplate, so it might be necessary to contact the motor manufacturer.

7.3 Flux Vector Control

The functions that can be used with flux vector control are listed in *Table 7.3*. Details on functions that are specific to flux vector control (i.e. those marked with a *) are provided in the following table.

Table 7.3 Flux Vector Control Functions

Group	Function	Comments	Control Method			
			V/f	V/f w/PG	Open-loop Vector	Flux Vector
b Application	b1 Sequence	Settings such as the reference input method	<input type="radio"/>	<input type="radio"/>	<input type="radio"/>	<input type="radio"/>
	b2 DC Injection Braking	DC injection braking function settings	<input type="radio"/>	<input type="radio"/>	<input type="radio"/>	<input type="radio"/>
	b3 Speed Search	Speed search function settings	<input type="radio"/>	<input type="radio"/>	<input type="radio"/>	<input type="radio"/>
	b4 Delay Timers	Timer function settings	<input type="radio"/>	<input type="radio"/>	<input type="radio"/>	<input type="radio"/>
	b5 PID Control	PID control settings	<input type="radio"/>	<input type="radio"/>	<input type="radio"/>	<input type="radio"/>
	b6 Dwell Functions Hold	Acceleration/deceleration time dwell function settings	<input type="radio"/>	<input type="radio"/>	<input type="radio"/>	<input type="radio"/>
	b7 Droop Control	* Droop Control function settings	<input checked="" type="radio"/>	<input checked="" type="radio"/>	<input checked="" type="radio"/>	<input type="radio"/>
	b8 Energy Saving	Not used. (Can't be set.)	<input type="radio"/>	<input type="radio"/>	<input checked="" type="radio"/>	<input checked="" type="radio"/>
	b9 Zero Servo	* Zero-servo function settings	<input checked="" type="radio"/>	<input checked="" type="radio"/>	<input checked="" type="radio"/>	<input type="radio"/>
C Tuning	C1 Accel/Decel	Acceleration/deceleration time settings	<input type="radio"/>	<input type="radio"/>	<input type="radio"/>	<input type="radio"/>
	C2 S-Curve Acc/Dec	S-curve characteristics for accel/decel times	<input type="radio"/>	<input type="radio"/>	<input type="radio"/>	<input type="radio"/>
	C3 Motor-Slip Compensation	* Motor temperature compensation function adjustment	<input type="radio"/>	<input type="radio"/>	<input type="radio"/>	<input type="radio"/>
	C4 Torque Compensation	Not used. (Can't be set.)	<input type="radio"/>	<input type="radio"/>	<input type="radio"/>	<input checked="" type="radio"/>
	C5 Speed Controls	Speed control loop adjustment	<input checked="" type="radio"/>	<input type="radio"/>	<input checked="" type="radio"/>	<input type="radio"/>
	C6 Carrier Frequency	Carrier frequency settings	<input type="radio"/>	<input type="radio"/>	<input type="radio"/>	<input type="radio"/>
	C7 Hunting Prevention	Not used. (Can't be set.)	<input type="radio"/>	<input type="radio"/>	<input checked="" type="radio"/>	<input checked="" type="radio"/>
	C8 Factory Tuning	Not used. (Can't be set.)	<input checked="" type="radio"/>	<input checked="" type="radio"/>	<input type="radio"/>	<input checked="" type="radio"/>
d Reference	d1 Preset Reference	Frequency reference settings (when using Operator)	<input type="radio"/>	<input type="radio"/>	<input type="radio"/>	<input type="radio"/>
	d2 Reference Limits	Frequency upper and lower limit settings	<input type="radio"/>	<input type="radio"/>	<input type="radio"/>	<input type="radio"/>
	d3 Jump Frequencies	Prohibited frequency settings	<input type="radio"/>	<input type="radio"/>	<input type="radio"/>	<input type="radio"/>
	d4 Reference frequency hold function	Up/Down, Accel/Decel stop hold frequency setting	<input type="radio"/>	<input type="radio"/>	<input type="radio"/>	<input type="radio"/>
	d5 Torque Control	* Torque control settings and adjustment	<input checked="" type="radio"/>	<input checked="" type="radio"/>	<input checked="" type="radio"/>	<input type="radio"/>
E Motor	E1 V/f Pattern	* Motor constant settings (Motor constants set automatically with autotuning.)	<input type="radio"/>	<input type="radio"/>	<input type="radio"/>	<input type="radio"/>
	E2 Motor Setup		<input type="radio"/>	<input type="radio"/>	<input type="radio"/>	<input type="radio"/>
	E3 Motor 2 Control Methods	Control method settings for motor 2.	<input type="radio"/>	<input type="radio"/>	<input type="radio"/>	<input type="radio"/>
	E4 Motor 2 V/f Characteristics	V/f characteristics settings for motor 2.	<input type="radio"/>	<input type="radio"/>	<input type="radio"/>	<input type="radio"/>
	E5 Motor 2 Motor Constants	Motor constant settings for motor 2.	<input type="radio"/>	<input type="radio"/>	<input type="radio"/>	<input type="radio"/>
F Options	F1 PG Speed Control Card Settings	Constant settings for a PG Speed Control Card	<input checked="" type="radio"/>	<input type="radio"/>	<input checked="" type="radio"/>	<input type="radio"/>
	F2 Analog Reference Card AI	User constant settings for an Analog Reference Card	<input type="radio"/>	<input type="radio"/>	<input type="radio"/>	<input type="radio"/>
	F3 Digital Reference Card DI	User constant settings for a Digital Reference Card	<input type="radio"/>	<input type="radio"/>	<input type="radio"/>	<input type="radio"/>
	F4 Analog Monitor Card AO	User constant settings for an Analog Monitor Card	<input type="radio"/>	<input type="radio"/>	<input type="radio"/>	<input type="radio"/>
	F5 Digital Output Card DO	User constant settings for a Digital Output Card	<input type="radio"/>	<input type="radio"/>	<input type="radio"/>	<input type="radio"/>
	F6 Digital Output Card DO	User constant settings for a Digital Output Card	<input type="radio"/>	<input type="radio"/>	<input type="radio"/>	<input type="radio"/>
	F7 Pulse Monitor Card PO	User constant settings for a Pulse Monitor Card	<input type="radio"/>	<input type="radio"/>	<input type="radio"/>	<input type="radio"/>
	F8 SI-F/SI-G Transmission Card	User constant settings for a Transmission Card	<input type="radio"/>	<input type="radio"/>	<input type="radio"/>	<input type="radio"/>
	F9 CP-916B Transmission Card	User constant settings for a Transmission Card	<input type="radio"/>	<input type="radio"/>	<input type="radio"/>	<input type="radio"/>

Group	Function	Comments	Control Method				
			V/f	V/f w/PG	Open-loop Vector	Flux Vector	
H	Terminal	H1 Multi-function Inputs	Function selection for multi-function inputs	<input type="radio"/>	<input type="radio"/>	<input type="radio"/>	<input type="radio"/>
		H2 Multi-function Outputs	Function selection for multi-function outputs	<input type="radio"/>	<input type="radio"/>	<input type="radio"/>	<input type="radio"/>
		H3 Analog Inputs	Function selection for analog inputs	<input type="radio"/>	<input type="radio"/>	<input type="radio"/>	<input type="radio"/>
		H4 Multi-function Analog Outputs	Function selection for analog outputs	<input type="radio"/>	<input type="radio"/>	<input type="radio"/>	<input type="radio"/>
		H5 MEMOBUS Communications	MEMOBUS communications settings	<input type="radio"/>	<input type="radio"/>	<input type="radio"/>	<input type="radio"/>
L	Protection	L1 Motor Overload	Sets electrical/thermal functions that protect the motor.	<input type="radio"/>	<input type="radio"/>	<input type="radio"/>	<input type="radio"/>
		L2 Power Loss Ridethru	Selects the power-loss processing method.	<input type="radio"/>	<input type="radio"/>	<input type="radio"/>	<input type="radio"/>
		L3 Stall Prevention	Accel/Decel stall prevention settings and selection	<input type="radio"/>	<input type="radio"/>	<input type="radio"/>	<input type="radio"/>
		L4 Reference Detection	Frequency detection settings and selection	<input type="radio"/>	<input type="radio"/>	<input type="radio"/>	<input type="radio"/>
		L5 Fault Restart	Fault restart function settings	<input type="radio"/>	<input type="radio"/>	<input type="radio"/>	<input type="radio"/>
		L6 Torque Detection	Sets overtorque detection functions 1 and 2 (by current)	<input type="radio"/>	<input type="radio"/>	<input type="radio"/>	<input type="radio"/>
		L7 Torque Limit	* Torque limit function settings	<input checked="" type="radio"/>	<input checked="" type="radio"/>	<input type="radio"/>	<input type="radio"/>
		L8 Hardware Protection	Hardware overheating and open-phase protection settings	<input type="radio"/>	<input type="radio"/>	<input type="radio"/>	<input type="radio"/>
o	Operator	o1 Monitor Select	Selects the Operator's display and setting methods.	<input type="radio"/>	<input type="radio"/>	<input type="radio"/>	<input type="radio"/>
		o2 Key Selections	Operator's key function selection and other constants	<input type="radio"/>	<input type="radio"/>	<input type="radio"/>	<input type="radio"/>

7.3.1 Droop Control Function

Droop control is a function that allows the user to set the amount of motor slip. When a single load is operated with two motors (such as in a crane conveyor), a high-resistance motor is normally used, as shown in Figure 7.5.

If droop control is used, a high-resistance motor characteristics can be set for a general-purpose motor. Also, it is easy to make adjustments while watching the load balance because the amount of slip can be set arbitrarily.

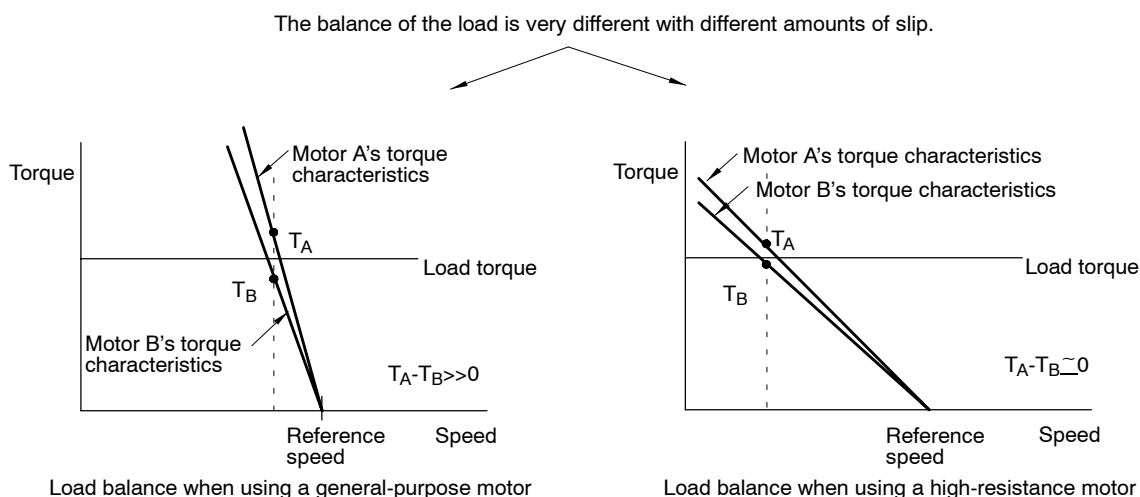

Fig 7.5 Droop Control Function

■ Droop Control Gain: b7-01

User Constant Number	Name	Change during Operation	Setting Range	Unit	Factory Setting	Valid Access Levels			
						V/f Control	V/f with PG	Open Loop Vector	Flux Vector
b7-01	Droop control gain	x	0.0 to 100.0	%	0.0	x	x	x	A

- Set the amount of slip as the percentage of slip when the maximum output frequency is input and the rated torque is generated.
- Droop control is disabled if b7-01 is set to 0.0.

■ Droop Control Delay Time: b7-02

User Constant Number	Name	Change during Operation	Setting Range	Unit	Factory Setting	Valid Access Levels			
						V/f Control	V/f with PG	Open Loop Vector	Flux Vector
b7-02	Droop control delay time	x	0.03 to 2.00	s	0.05	x	x	x	A

- Constant b7-02 is used to adjust the responsiveness of droop control.
- Increase this setting if oscillation or hunting occur.

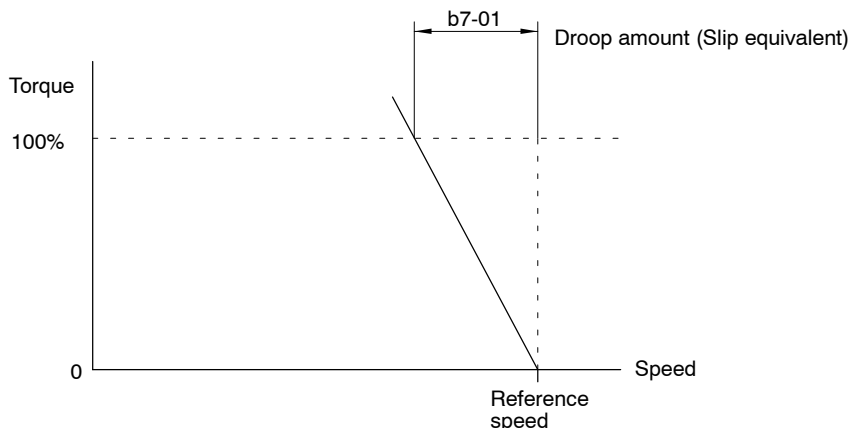

Fig 7.6 Droop Control Gain

7.3.2 Zero-servo Function

The zero-servo function is enabled when one of the multi-function inputs (H1-01 to H1-06) is set to 72 (zero servo command). If the zero servo command is ON when the frequency (speed) reference falls below the zero speed level (b2-01), a position control loop is formed and the motor is stopped. (The motor will not rotate even if there is an offset in the analog command input.)

■ Zero-servo Settings: b9-01, b9-02

User Constant Number	Name	Change during Operation	Setting Range	Unit	Factory Setting	Valid Access Levels			
						V/f Control	V/f with PG	Open Loop Vector	Flux Vector
b9-01	Zero-servo gain	X	0 to 100	-	5	X	X	X	A
b9-02	Zero-servo completion width	X	0 to 16383	Pulses	10	X	X	X	A

A time chart for the zero servo function is given in *Figure 7.7*.

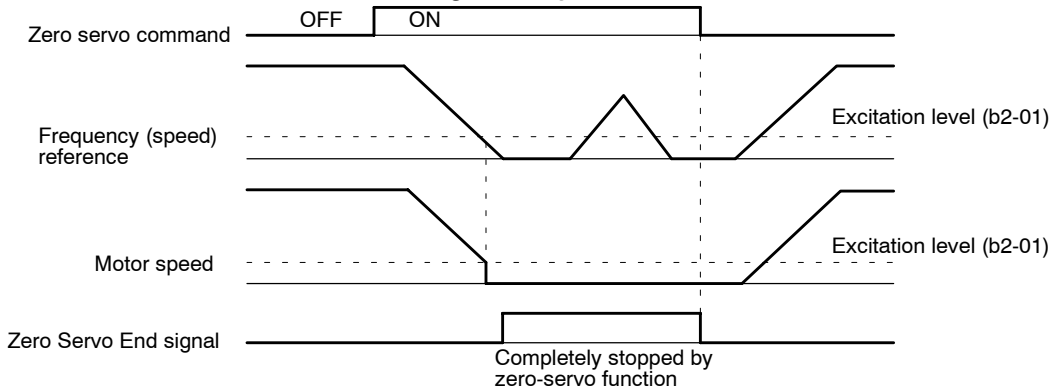
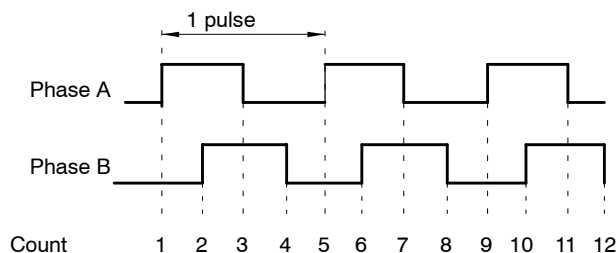

Fig 7.7 Time Chart for Zero Servo

- Assign the zero servo command (setting 72) to one of the multi-function inputs (H1-01 to H1-06).
- The zero-servo status is entered when the frequency (speed) reference falls below the zero-speed level (b2-01).
- Be sure to leave the run command input ON. If the run command is turned OFF, the output will be interrupted and the zero-servo function will become ineffective.
- Adjust the holding strength of the zero-servo with constant b9-01 (Zero Servo Gain). Increasing this setting increases the holding strength, although oscillation will occur if the setting is too high. (Adjust the holding strength after adjusting the speed control (ASR) gain.)

- To output the zero-servo status externally, assign the Zero Servo End signal (setting 33) to one of the multi-function outputs (H2-01 to H2-03). The setting in b9-02 (Zero-servo Completion Width) is enabled when one of the multi-function outputs has been set to 33.
- The Zero Servo End signal remains ON as long as the position is within this range (starting position \pm Zero-servo Completion Width).
- Set the Zero-servo Completion Width to four times the number of pulses from the PG (pulse generator or encoder), as shown in *Figure 7.8*.
For example, when a 600 p/r encoder is being used, the number of pulses would be 2,400 p/r after multiplying by four.
- The Zero Servo End signal will go OFF when the zero servo command is turned OFF.
- Do not lock the servo for extended periods of time at 100% when using the zero servo function. Extended periods of servo lock can be achieved by ensuring that the current during the servolock is 50% or less or by increasing the Inverter capacity.



Factor of 4: By counting the rising and falling edges of phase A this method has four times the resolution of the PG.

Fig 7.8 Pulse Count Factored by 4

7.3.3 Torque Control

■ Torque Control Function Settings: d5-01

With flux vector control, the motor's output torque can be controlled by a torque reference from an analog input.

User Constant Number	Name	Change during Operation	Setting Range	Unit	Factory Setting	Valid Access Levels			
						V/f Control	V/f with PG	Open Loop Vector	Flux Vector
d5-01	Torque control selection	x	0, 1	-	0	x	x	x	A

- Settings

Setting	Function
0	Speed control (controlled by C5-01 to C5-07)
1	Torque control

- Set constant d5-01 to "1" to select torque control.
- *Figure 7.9* shows the operation of torque control.

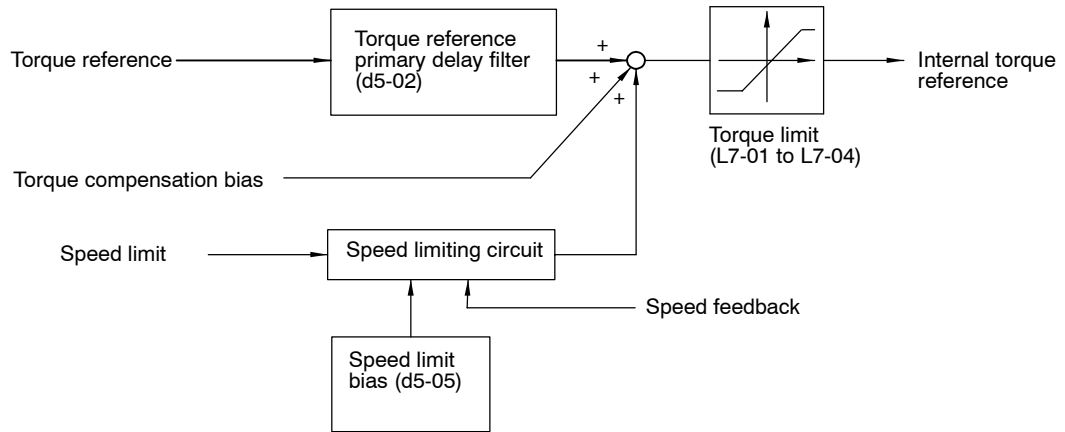

Fig 7.9 Torque Control Block Diagram

■ Torque Reference Settings: H3-04, H3-05, H3-08, H3-09

- Set the multi-function analog input terminal 42 (H3-05) or 39 (H3-09) to torque reference (a setting of 13). The torque reference value cannot be set with the Digital Operator.

User Constant Number	Name	Change during Operation	Setting Range	Unit	Factory Setting	Valid Access Levels			
						V/f Control	V/f with PG	Open Loop Vector	Flux Vector
H3-05	Multi-function analog input (terminal 42)	x	0 to 1F	-	0	B	B	B	B
H3-09	Multi-function analog input (terminal 39)	x	1 to 1F	-	1F	A	A	A	A

- Next, set the signal level for the analog input terminal that was set to torque reference.

User Constant Number	Name	Change during Operation	Setting Range	Unit	Factory Setting	Valid Access Levels			
						V/f Control	V/f with PG	Open Loop Vector	Flux Vector
H3-04	Signal level selection (terminal 42)	x	0, 1	-	0	B	B	B	B
H3-08	Signal level selection (terminal 39)	x	0 to 2	-	2	A	A	A	A

- Signal Level Settings

Setting	Function
0	0 to +10 V input (When H3-08 is being set, be sure to disconnect jumper wire J1.)
1	0 to ±10 V input (When H3-08 is being set, be sure to disconnect jumper wire J1.)
2	4 to 20 mA input (H3-08 only)

- Set the proper signal level for the torque reference that you want to input.
- The direction of the torque that is output is determined by the sign (polarity) of the signal that was input. It is not determined by the direction of the run command (forward/reverse).
 - +Voltage (or current): Forward torque reference (generally counterclockwise; axis side)
 - -Voltage: Reverse torque reference (generally clockwise; axis side)

Since the polarity of the voltage input determines the direction, only forward torque references can be input when the “0 to +10 V” or “4 to 20 mA” signal level has been selected. If you want to input reverse torque references, be sure to select the “0 to ±10 V” signal level.

- When supplying a voltage input to the frequency reference current input (terminal 39) (a setting of 0 or 1), be sure to disconnect jumper wire J1 on the control board. (See Figure 7.10.) If the jumper wire isn't disconnected, the input resistor will be destroyed.

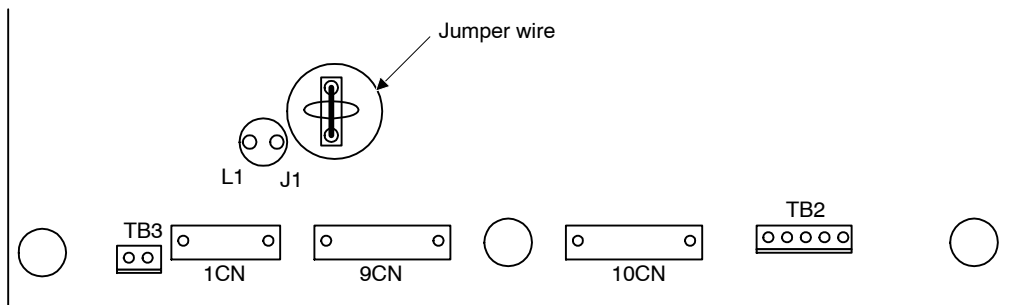

Fig 7.10 Jumper Wire Mounting Location on Control Board

■ Speed Limit Function Settings: d5-03, H3-01, d5-04, d5-05

- This setting selects the speed limit function used when torque control is performed. With torque control, the motor sometimes rotates at high speed with no load or a light load. The speed limit function keeps the motor speed from exceeding the specified limit in these cases.
- If the speed limit is exceeded during torque control operation, a suppressing torque (proportional to the divergence from the speed limit) is added to the torque reference. (The suppressing torque is applied opposite to the motor rotation.)
- There are two ways to set the motor speed limit: a constant setting or an analog input value.

Speed Limit Selection: d5-03

User Constant Number	Name	Change during Operation	Setting Range	Unit	Factory Setting	Valid Access Levels			
						V/f Control	V/f with PG	Open Loop Vector	Flux Vector
d5-03	Speed limit selection	X	1, 2	-	1	X	X	X	A

- Settings

Setting	Function
1	The speed limit is set from one of the analog frequency reference terminals (36 or 39).
2	The speed limit is set to the value in constant d5-04.

Speed Limit Selection Settings: d5-03, H3-01, d5-04

- Limit with Analog Input (d5-03 = 1)
 - The speed limit value is set by the input voltage (H3-01) to frequency reference (voltage) terminal 36.
 - When frequency reference (current) terminal 39 has been set to frequency reference by setting constant H3-09 to 1F, this terminal is also used as an input terminal for the speed limit. In this case, the actual speed limit value is the sum of the voltage input value at terminal 13 and the current input value at terminal 39.
 - The polarity of the speed limit signal and the direction of the run command determine the direction in which the speed is limited.
 - +Voltage input: Forward rotation; Speed is limited in the forward direction. Reverse rotation; Speed is limited in the reverse direction.
 - Voltage input: Forward rotation; Speed is limited in the reverse direction. Reverse rotation; Speed is limited in the forward direction.
 - The speed limit value is zero for rotation opposite to the speed limit direction. For example, when a +voltage is being input and the forward rotation command is ON, the effective range of the torque control is from zero to the speed limit value in the forward direction (when constant d5-05, the speed limit bias, is set to 0).

7.3.3 Torque Control

User Constant Number	Name	Change during Operation	Setting Range	Unit	Factory Setting	Valid Access Levels			
						V/f Control	V/f with PG	Open Loop Vector	Flux Vector
H3-01	Signal level selection (terminal 36)	x	0, 1	-	0	B	B	B	B

- Setting (See page 6 - 4.)

Setting	Function
0	0 to 10 VDC input
1	-10 to 10 VDC input (A negative voltage is a command for rotation in the opposite direction.)

- Set the signal level to match the speed limit voltage being input.
- Limit with Constant Setting (d5-03 = 2)

User Constant Number	Name	Change during Operation	Setting Range	Unit	Factory Setting	Valid Access Levels			
						V/f Control	V/f with PG	Open Loop Vector	Flux Vector
d5-04	Speed limit	x	-120 to +120	%	0	x	x	x	A

- Set the speed limit as a percentage of the maximum frequency. (The max. frequency is 100%.) The sign of the constant setting and the direction of the run command determine the direction in which the speed is limited.
 - Setting +: Forward rotation; Speed is limited in the forward direction.
Reverse rotation; Speed is limited in the reverse direction.
 - Setting -: Forward rotation; Speed is limited in the reverse direction.
Reverse rotation; Speed is limited in the forward direction.
- The speed limit value is zero for rotation opposite to the speed limit direction. For example, when a positive value is set in d5-04 and the forward rotation command is ON, the effective range of the torque control is from zero to the speed limit value in the forward direction (when constant d5-05, the speed limit bias, is set to 0).

Speed Limit Bias Setting: d5-05

User Constant Number	Name	Change during Operation	Setting Range	Unit	Factory Setting	Valid Access Levels			
						V/f Control	V/f with PG	Open Loop Vector	Flux Vector
d5-05	Speed limit bias	X	0 to 120	%	10	X	X	X	A

- The speed limit bias can be used to add margins to the speed limit.
- When the speed limit bias is used, it is possible to set the same speed limit value in both the forward and reverse directions.
- Set the speed limit bias as a percentage of the maximum output frequency. (The max. frequency is 100%.)
For example, the following settings establish speed limits of 50% of the maximum output frequency in both the forward and reverse directions.
 - Speed limit setting: Zero (with d5-04 as the speed limit: d5-03 = 2, d5-04 = 0)
 - Speed limit bias setting: 50% (d5-05 = 50)
- When a forward speed limit and a speed limit bias have been set, the speed range of the torque control is from the “-speed limit bias setting” to the “speed limit setting + speed limit bias setting.”
In effect, the speed limit range is extended by the speed limit bias in both the forward and reverse directions.

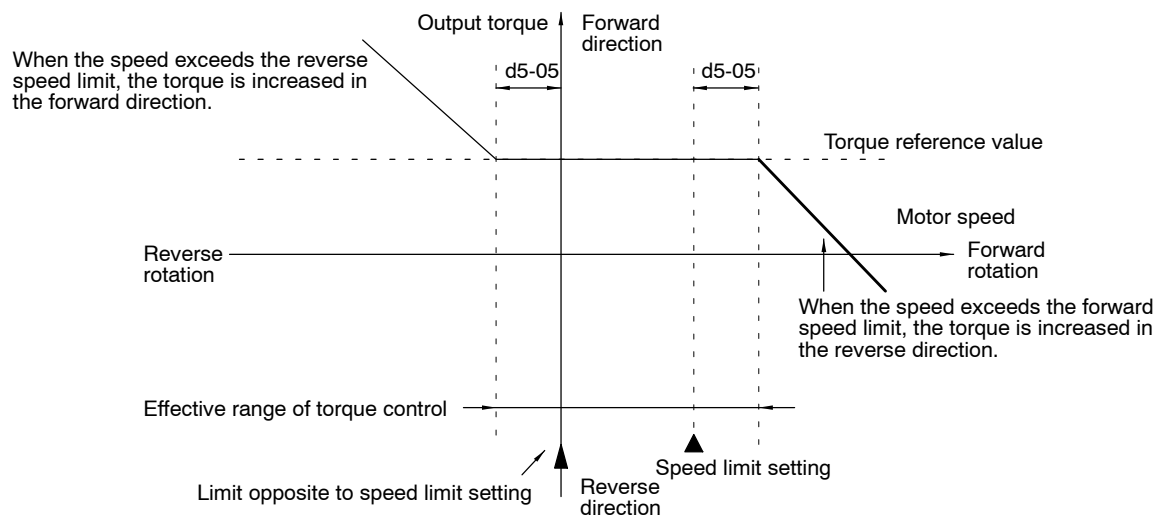

Fig 7.11 Speed Limit Bias Settings

Operation

The following operation will be performed if the torque reference is greater than 0 and the speed limit is greater than 0 (winder operation).

- If $(-1 \times \text{speed limit bias (d5-05)}) < \text{motor speed} < (\text{speed limit} + \text{d5-05})$, the torque will be controlled according to the set torque reference.
- If the motor speed $> (\text{speed limit} + \text{d5-05})$, the speed limit circuit will output a negative torque reference to prevent the motor speed from increasing.
- If the motor speed $< (-1 \times \text{d5-05})$, the speed limit circuit will output a positive torque reference to prevent the speed from increasing in the reverse direction.

Thus, if the torque reference is greater than 0 and the speed limit is greater than 0, the torque will be controlled within the following limits:

$$(-1 \times \text{d5-05}) < \text{motor speed} < (\text{speed limit} + \text{d5-05})$$

7.3.3 Torque Control

The relationships between the torque reference, speed limits, and motor speed are shown in the following diagram.

	Winding Operation		Rewinding Operation	
Configuration				
Normal Rotation Direction	Forward	Reverse	Forward	Reverse
Torque Reference Polarity (TREF)	⊕	⊖	⊖	⊕
Speed Limit Polarity (SLIM)	⊕	⊖	⊕	⊖
Generated Torque				

■ Torque Reference Adjustment: d5-02, H3-02 to H3-11

Primary Delay Time Constant for Torque Reference Filter: d5-02

- The time constant of the primary filter in the torque reference section can be adjusted.
- This constant is used to eliminate noise in the torque reference signal and adjust the responsiveness to the host controller.

User Constant Number	Name	Change during Operation	Setting Range	Unit	Factory Setting	Valid Access Levels			
						V/f Control	V/f with PG	Open Loop Vector	Flux Vector
d5-02	Torque reference delay time	x	0 to 1000	ms	0	x	x	x	A

- Set the torque reference filter primary delay time constant in ms units.
- Increase the time constant setting if oscillation occurs during torque control operation.

Setting the Torque Compensation Bias: H3-05, -04, -08, -09

- Set multi-function analog input (terminal 42) or frequency reference current input (terminal 39) to torque compensation (setting 14). When the amount of torque loss at the load is input to one of these terminals, it is added to the torque reference to compensate for the loss.

User Constant Number	Name	Change during Operation	Setting Range	Unit	Factory Setting	Valid Access Levels			
						V/f Control	V/f with PG	Open Loop Vector	Flux Vector
H3-05	Multi-function analog input (terminal 42)	x	0 to 1F	-	0	B	B	B	B
H3-09	Multi-function analog input (terminal 39)	x	1 to 1F	-	1F	A	A	A	A

- The functions of H3-05 and H3-09 are listed in *Table 7.12*.
- Set torque compensation (setting 14) for the input terminal that isn't set to torque reference (setting 13).

User Constant Number	Name	Change during Operation	Setting Range	Unit	Factory Setting	Valid Access Levels			
						V/f Control	V/f with PG	Open Loop Vector	Flux Vector
H3-04	Signal level selection (terminal 42)	X	0, 1	-	0	B	B	B	B
H3-08	Signal level selection (terminal 39)	X	0 to 2	-	2	A	A	A	A

- Settings

Setting	Function
0	0 to +10 V input (When H3-08 is being set, be sure to disconnect jumper wire J1.)
1	0 to ±10 V input (When H3-08 is being set, be sure to disconnect jumper wire J1.)
2	4 to 20 mA input (H3-08 only)

- Set the proper signal level for the torque compensation bias that you want to input.
- The direction of the torque compensation bias is determined by the sign (polarity) of the signal that is input. It is not determined by the direction of the run command (forward/reverse).
 - +Voltage (or current): Forward torque compensation (generally counter-clockwise; axis side)
 - -Voltage: Reverse torque compensation (generally clockwise; axis side)

Since the polarity of the voltage input determines the direction, only forward torque compensation can be input when the “0 to +10 V” or “4 to 20 mA” signal level has been selected. If you want to input reverse torque compensation, be sure to select the “0 to ±10 V” signal level.

- When supplying a voltage input to the frequency reference current input (terminal 39), be sure to disconnect jumper wire J1 on the control board. If the jumper wire isn't disconnected, the input resistor will be destroyed. Refer to *Figure 7.10* for a diagram of the control board.

Adjusting the Gain/Bias of the Analog Inputs: H3-02, -03, -06, -07, -10, -11

- Adjust the gain and bias for the frequency reference (voltage), frequency reference (current), and multi-function analog inputs according to the input specifications for each input.

User Constant Number	Name	Change during Operation	Setting Range	Unit	Factory Setting	Valid Access Levels			
						V/f Control	V/f with PG	Open Loop Vector	Flux Vector
H3-02	Gain (terminal 36)	○	0.0 to 1000.0	%	100.0	B	B	B	B
H3-03	Bias (terminal 36)	○	-100.0 to +100.0	%	0.0	B	B	B	B
H3-06	Gain (terminal 42)	○	0.0 to 1000.0	%	100.0	B	B	B	B
H3-07	Bias (terminal 42)	○	-100.0 to +100.0	%	0.0	B	B	B	B
H3-10	Gain (terminal 39)	○	0.0 to 1000.0	%	100.0	A	A	A	A
H3-11	Bias (terminal 39)	○	-100.0 to +100.0	%	0.0	A	A	A	A

- Adjust the gain so that the maximum signal level corresponds to the maximum frequency or the motor's rated torque, as follows.
 - When the input terminal is used for frequency reference:
 - A 10 V (20 mA) input indicates a frequency reference that is 100% of the max. output frequency.
 - When the input terminal is used for torque reference:
 - A 10 V (20 mA) input indicates a torque reference that is 100% of the motor's rated torque.
 - When the input terminal is used for torque compensation:
 - A 10 V (20 mA) input indicates a torque compensation that is 100% of the motor's rated torque.
- Adjust the bias so that the minimum signal level corresponds to the maximum frequency or the motor's rated torque, as follows.
 - When the input terminal is used for frequency reference:
 - A 0 V (4 mA) input indicates a frequency reference that is 100% of the max. output frequency.

7.3.4 Speed/Torque Control Switching Function

- When the input terminal is used for torque reference:
A 0 V (4 mA) input indicates a torque reference that is 100% of the motor’s rated torque.
- When the input terminal is used for torque compensation:
A 0 V (4 mA) input indicates a torque compensation that is 100% of the motor’s rated torque.

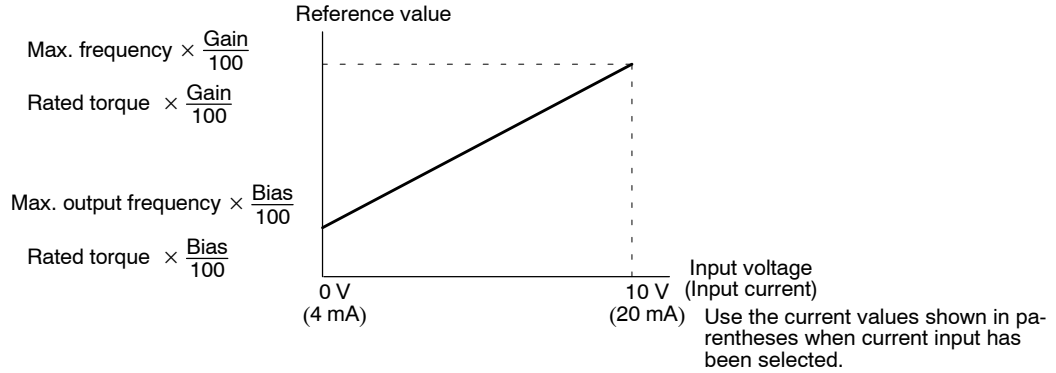

Fig 7.12 Analog Input Gain and Bias Settings

7.3.4 Speed/Torque Control Switching Function

It is possible to switch between speed control and torque control when one of the multi-function inputs (H1-01 to H1-06) is set to 71 (Speed/Torque Control Change). Speed control is performed when the input is OFF and torque control is performed when the input is ON.

■ Torque Control Function Settings: d5-01

User Constant Number	Name	Change during Operation	Setting Range	Unit	Factory Setting	Valid Access Levels			
						V/f Control	V/f with PG	Open Loop Vector	Flux Vector
d5-01	Torque control selection	x	0, 1	-	0	x	x	x	A

- Settings

Setting	Function
0	Speed control (controlled by C5-01 to C5-07)
1	Torque control

- Set constant d5-01 to 0 (speed control) when using the speed/torque control switching function.

■ Setting the Speed/Torque Control Switching Timer: d5-06

User Constant Number	Name	Change during Operation	Setting Range	Unit	Factory Setting	Valid Access Levels			
						V/f Control	V/f with PG	Open Loop Vector	Flux Vector
d5-06	Speed/torque control switching timer	x	0 to 1000	ms	0	x	x	x	A

- This setting specifies the delay (0 to 1,000 ms) between a change in the multi-function input (ON → OFF or OFF → ON) and the corresponding change in the control mode. The timer setting is effective only when 71 (Speed/Torque Control Change) has been set in one of the multi-function inputs (H1-01 to H1-06).
- During the timer delay, the value of the 3 analog inputs will retain the values they had when the ON/OFF status of speed/torque control switching signal was changed. Use this delay to make any preparations for the change in the control mode.

■ Frequency Reference and Speed Limit

The frequency reference (during speed control) is set with b1-01 (Reference Selection). The speed limit (during torque control) is set with d5-03 (Speed Limit Selection). It is possible to assign the frequency reference and speed limit functions to the same analog input terminal (36 or 39).

■ Torque Reference and Torque Limit

If the torque reference has been assigned to a multi-function analog input or the frequency reference (current) terminal, the input function changes when the control mode is switched between torque control and speed control.

- During speed control: The analog input terminal is used as the torque limit input.
- During torque control: The analog input terminal is used as the torque reference input.

Either the absolute value of the torque limit input or the torque limit constant setting (L7-01 to L7-04), whichever is smaller, will be used for the torque limit. Refer to 7.3.5 *Torque Limit Function*.

■ Stopping Method

- When the run command is turned OFF during speed control, the motor is decelerated to a stop. When the run command is turned OFF during torque control, the control mode is automatically switched to speed control and the motor is decelerated to a stop.
- When A1-02 is set to 3 (flux vector control), the speed/torque change command can be set for a multi-function input (a setting of 71) to switch between speed and torque control during operation. An example is shown below.
- Settings

Terminal No.	User Constant No.	Factor Setting	Setting	Function
16	H1-06	8	71	Speed/torque control change
36	b1-01	1	1	Frequency source (terminals 36, 39)
	d5-03	1	1	Speed limit (terminals 36, 39)
42	H3-05	1	13	Torque reference/torque limit

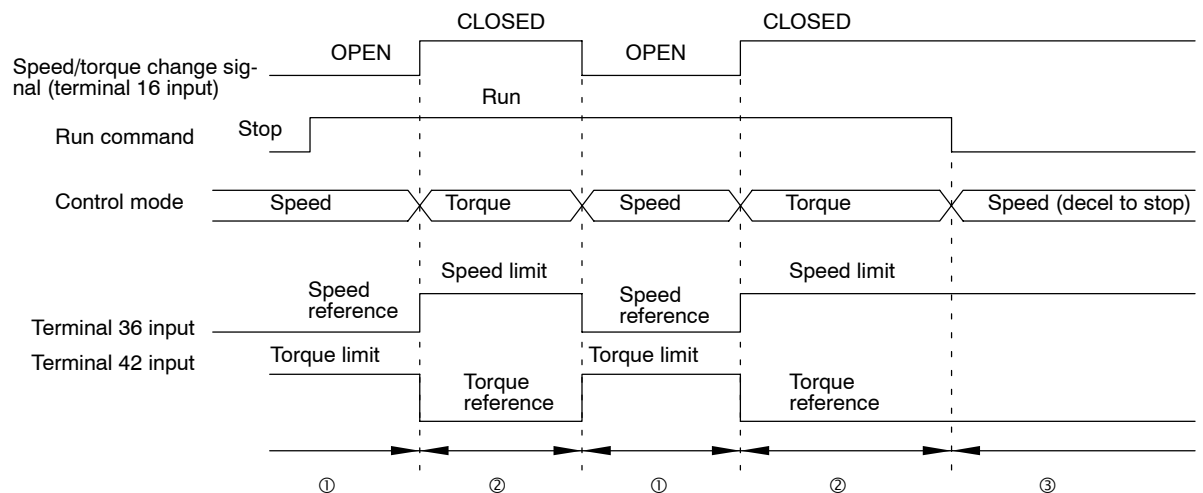

Fig 7.13 Switching between Speed and Torque Control

7.3.5 Torque Limit Function

With flux vector control, the torque limit can be applied at an arbitrary value because the torque output by the motor is calculated internally. The torque limit function is useful when the load cannot sustain a torque above a certain level or regenerative torque above a certain level.

The two ways to apply a torque limit are listed below.

- Setting torque limits with the constants
- Limiting torque with the analog inputs

The lower torque limit will be used if both of these methods are set. The accuracy of the torque limit is $\pm 5\%$ at all frequencies.

■ Setting a Torque Limit with Constants: L7-01 to L7-04

- Torque limits can be set separately for the 4 ways that torque can be applied: forward torque, reverse torque, forward regenerative torque, and reverse regenerative torque.

User Constant Number	Name	Change during Operation	Setting Range	Unit	Factory Setting	Valid Access Levels			
						V/f Control	V/f with PG	Open Loop Vector	Flux Vector
L7-01	Forward torque limit	x	0 to 300	%	200	x	x	B	B
L7-02	Reverse torque limit	x	0 to 300	%	200	x	x	B	B
L7-03	Forward regenerative torque limit	x	0 to 300	%	200	x	x	B	B
L7-04	Reverse regenerative torque limit	x	0 to 300	%	200	x	x	B	B

- Figure 7.14 shows the relationship between each constant and the output torque.

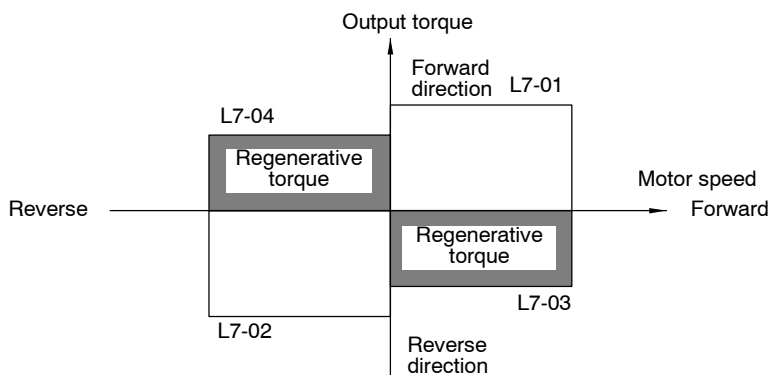

Fig 7.14 Torque Limit Function

- When the torque limit function is used, the torque control has priority and motor speed control and compensation will be disregarded, so the acceleration/deceleration times might be lengthened and motor speed might be reduced.

■ Limiting Torque with Analog Inputs: H3-05, H3-09

The following two analog inputs that can be used to limit torque. Use either or both of these inputs as needed with constants H3-05 and H3-09.

- Multi-function analog input terminal 42
- Frequency reference (current) terminal 39

User Constant Number	Name	Change during Operation	Setting Range	Unit	Factory Setting	Valid Access Levels			
						V/f Control	V/f with PG	Open Loop Vector	Flux Vector
H3-05	Multi-function analog input (terminal 42)	x	0 to 1F	-	0	B	B	B	B
H3-09	Multi-function analog input (terminal 39)	x	1 to 1F	-	1F	A	A	A	A

- Settings

Setting	Name
10	Forward Torque Limit
11	Reverse Torque Limit
12	Regenerative Torque Limit
13	Torque reference (The input limits torque in both the forward and reverse directions during speed control.)
15	Forward/Reverse Torque Limit (Limits torque in both the forward and reverse directions.)

- The above table shows only those settings related to the torque limit function.
- Set the analog input terminal’s signal level, gain, and bias to match the actual input signal.

- The factory default settings for the input terminal's signal level are as follows:
 - Terminal 42: 0 to +10 V (A 10 V input limits the torque to 100% of the motor's rated torque.)
 - Terminal 39: 4 to 20 mA (A 20 mA input limits the torque to 100% of the motor's rated torque.)

Figure 7.15 shows the relationship between the output torque and each torque limit.

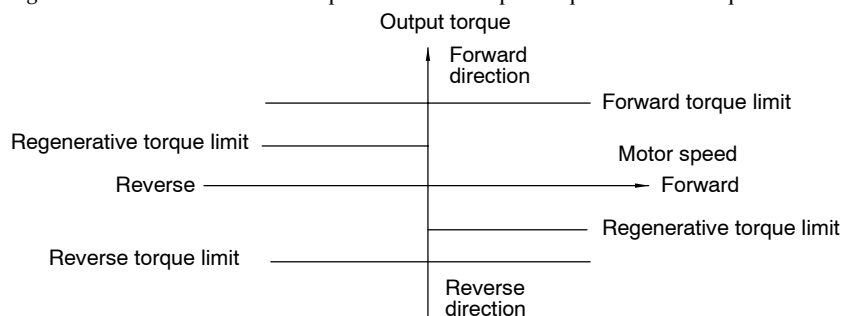

Fig 7.15 Limiting Torque via Analog Inputs

- When the forward torque limit has been set, the analog input signal acts as the limit value for torque generated in the forward direction. The torque limit input is effective when torque is generated in the forward direction even if the motor is operating in reverse (regenerative torque).
- The torque limit is 100% of the motor's rated torque when the analog input is at its maximum value (10 V or 20 mA). To increase the torque limit above 100%, set the input terminal's gain above 100%. For example, a gain of 150.0% would result in a torque limit of 150% of the motor's rated torque with a 10 V or 20 mA analog input.

7.3.6 Setting/Adjusting Motor Constants

■ Adjusting the V/f Pattern: E1-04 to E1-07, E1-13

- Normally it isn't necessary to adjust the V/f pattern with flux vector control. Adjust the V/f pattern when you want to change the maximum output frequency, maximum voltage, base frequency, or minimum output frequency settings.

User Constant Number	Name	Change during Operation	Setting Range	Unit	Factory Setting	Valid Access Levels			
						V/f Control	V/f with PG	Open Loop Vector	Flux Vector
E1-04	Max. output frequency	x	50.0 to 150.0	Hz	60.0	Q	Q	Q	Q
E1-05	Max. voltage	x	0.0 to 510.0*1	VAC	400.0*1	Q	Q	Q	Q
E1-06	Base frequency	x	0.0 to 150.0	Hz	60.0	Q	Q	Q	Q
E1-09	Min. output frequency	x	0.0 to 150.0	Hz	0.0	Q	Q	Q	A
E1-13	Base voltage	x	0.0 to 510.0	VAC	0.0*2	A	A	Q	Q

* 1. These voltages are for the 400-V Class Inverters; multiply the voltage by approx. 1.5 for 575-V Class Inverters.

* 2. If E1-13 is set to 0.0, the same value as in E1-13 will be set for E1-05. It does not normally need to be set separately.

Note 1. The default setting for E1-09 depends on the control method. The default settings shown in the table are for flux vector control.

2. The three frequency settings must satisfy the following equation:

$$E1-04 (F_{MAX}) \geq E1-06 (F_A) > E1-09 (F_{MIN})$$

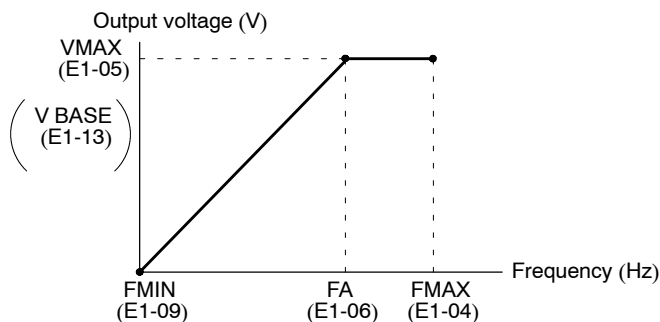

Fig 7.16 V/f Pattern Adjustment

Units for V/f Pattern Settings: o1-04

The units used for V/f pattern frequency settings can be changed when flux vector control has been selected.

User Constant Number	Name	Change during Operation	Setting Range	Unit	Factory Setting	Valid Access Levels			
						V/f Control	V/f with PG	Open Loop Vector	Flux Vector
o1-04	Frequency units of constant setting	x	0, 1	-	0	x	x	x	B

- Display Unit Settings

Setting	Function
0	Units: Hz
1	Units: r/min

- The setting units for constants E1-04, E1-06, and E1-09 can be changed.
- The unit for other frequencies will not change.
- Constant o1-04 is specific to flux vector control.

Setting Motor Constants: E2-01 to E2-09

The motor constants (function E2) will all be set automatically when autotuning is performed. Set these constants manually if autotuning can't be completed properly.

Motor Rated Current: E2-01

User Constant Number	Name	Change during Operation	Setting Range	Unit	Factory Setting	Valid Access Levels			
						V/f Control	V/f with PG	Open Loop Vector	Flux Vector
E2-01	Motor rated current	x	37.0 to 740.0	A	370	Q	Q	Q	Q

- The setting range is 10% to 200% of the Inverter rated output current. The default setting depends upon the Inverter capacity. (The table shows the default setting for 400-V class, 200 kW Inverters.) See page 8 - 42.)
- Set the rated current (A) shown on the motor nameplate.

Motor Rated Slip: E2-02

User Constant Number	Name	Change during Operation	Setting Range	Unit	Factory Setting	Valid Access Levels			
						V/f Control	V/f with PG	Open Loop Vector	Flux Vector
E2-02	Motor rated slip	x	0.00 to 20.00	Hz	1.3	A	A	Q	Q

- The default setting depends upon the Inverter capacity. (The table shows the default settings for 400-V class, 200 kW Inverters.) (See page 8 - 42.)
- Calculate the rated slip (E2-02) from the value shown on the motor nameplate with the following equation and set this value.

$$\text{Rated slip} = \frac{\text{rated frequency (Hz)} - \text{rated speed (r/min)} \times \text{number of poles}}{120}$$

Motor No-load Current: E2-03

User Constant Number	Name	Change during Operation	Setting Range	Unit	Factory Setting	Valid Access Levels			
						V/f Control	V/f with PG	Open Loop Vector	Flux Vector
E2-03	Motor no-load current	x	0.00 to 2000.0	A	96.0	A	A	Q	Q

- The default setting depends upon the Inverter capacity. (The table shows the default settings for 400-V class, 200 kW Inverters.) (See page 8 - 42.)
- Set the no-load current (E2-03) at the rated voltage and rated frequency. Normally this value isn't shown on the motor nameplate, so it might be necessary to contact the motor manufacturer.

Number of Motor Poles: E2-04

User Constant Number	Name	Change during Operation	Setting Range	Unit	Factory Setting	Valid Access Levels			
						V/f Control	V/f with PG	Open Loop Vector	Flux Vector
E2-04	Number of motor poles	x	2 to 48	-	4	x	Q	x	Q

- Set the number of poles (E2-04) shown on the motor nameplate.

Motor Line-to-line Resistance: E2-05

User Constant Number	Name	Change during Operation	Setting Range	Unit	Factory Setting	Valid Access Levels			
						V/f Control	V/f with PG	Open Loop Vector	Flux Vector
E2-05	Motor line-to-line resistance	x	0.000 to 65.000	Ω	0.020	A	A	A	A

- The default setting depends upon the Inverter capacity. (The table shows the default settings for 400-V class, 200 kW Inverters.) (See page 8 - 42.)
- Set the motor terminal resistance (U-V, V-W, and W-U) in constant E2-05.
- Normally this value isn't shown on the motor nameplate, so it might be necessary to contact the motor manufacturer for the terminal resistance at the insulation class temperature. Use the following equations to calculate the resistance value from the terminal resistance of a test report.
 - E-class insulation: Terminal resistance at 75°C in the test report (Ω) x 0.92
 - B-class insulation: Terminal resistance at 75°C in the test report (Ω) x 0.92
 - F-class insulation: Terminal resistance at 115°C in the test report (Ω) x 0.87

Motor Leak Inductance: E2-06

User Constant Number	Name	Change during Operation	Setting Range	Unit	Factory Setting	Valid Access Levels			
						V/f Control	V/f with PG	Open Loop Vector	Flux Vector
E2-06	Motor leak inductance	x	0.0 to 30.0	%	5.0	x	x	A	A

- The default setting depends upon the Inverter capacity. (The table shows the default settings for 400-V class, 200 kW Inverters.) (See page 8 - 42.)
- Set the voltage drop (caused by the motor's leakage inductance) as a percentage of the motor's rated voltage in constant E2-06.
- This constant does not normally require setting because the Inverter automatically compensates during operation.
- Normally this value isn't shown on the motor nameplate, so it might be necessary to contact the motor manufacturer. It is also acceptable to set the loss (caused by the motor's leakage inductance) as a percentage.

Motor Iron-core Saturation Coefficients 1, 2: E2-07, E2-08

User Constant Number	Name	Change during Operation	Setting Range	Unit	Factory Setting	Valid Access Levels			
						V/f Control	V/f with PG	Open Loop Vector	Flux Vector
E2-07	Motor iron-core saturation coefficient 1	X	0.00 to 0.50	-	0.50	X	X	A	A
E2-08	Motor iron-core saturation coefficient 2	X	0.00 to 0.75	-	0.75	X	X	A	A

- Constants E2-07 and E2-08 are not required when using the motor at or below the rated frequency.
- Set these constants when operating at a frequency higher than the motor’s rated frequency. Set the following values:
 - Motor iron-core saturation coefficient 1: Iron-core saturation coefficient when magnetic flux is 50%.
 - Motor iron-core saturation coefficient 2: Iron-core saturation coefficient when magnetic flux is 75%.
- Normally these values aren’t shown on the motor nameplate, so it might be necessary to contact the motor manufacturer. Operation will be possible with the factory-preset values.

Motor Mechanical Loss: E2-09

User Constant Number	Name	Change during Operation	Setting Range	Unit	Factory Setting	Valid Access Levels			
						V/f Control	V/f with PG	Open Loop Vector	Flux Vector
E2-09	Motor mechanical loss	X	0.0 to 10.0	%	0.0	X	X	X	A

- Normally it isn’t necessary to change this setting in the following cases:
 - There is a large torque loss to the motor’s bearings
 - There is a large torque loss to a fan or pump
- Set the mechanical loss as a percentage of the motor’s rated output power (W). Constant E2-09 is used to compensate for torque lost mechanically in the motor.

■ **Setting the Slip Compensation Gain: C3-01**

User Constant Number	Name	Change during Operation	Setting Range	Unit	Factory Setting	Valid Access Levels			
						V/f Control	V/f with PG	Open Loop Vector	Flux Vector
C3-01	Slip compensation gain	X	0.0 to 2.5	Multiple	1.0	B	X	B	B

- Normally it isn’t necessary to change this setting.
- With flux vector control, constant C3-01 sets the motor’s temperature compensation gain. Adjust the setting when a torque limit or torque control is being used and the output torque varies with the ambient temperature.
- This constant can be adjusted when the motor’s output torque changes at higher temperatures when torque control or limits are used. The larger the setting, the larger the compensation will be.

7.4 V/f Control with PG Feedback

The functions that can be used with V/f control with PG feedback are listed in *Table 7.4*. Details on functions that are specific to V/f control with PG feedback (i.e. those marked with a *) are provided in the following table.

Table 7.4 V/f Control with PG Feedback

Group	Function	Comments	Control Method			
			V/f	V/f w/PG	Open-loop Vector	Flux Vector
b Application	b1 Sequence	Settings such as the reference input method	<input type="radio"/>	<input type="radio"/>	<input type="radio"/>	<input type="radio"/>
	b2 DC Injection Braking	DC injection braking function settings	<input type="radio"/>	<input type="radio"/>	<input type="radio"/>	<input type="radio"/>
	b3 Speed Search	Speed search function settings	<input type="radio"/>	<input type="radio"/>	<input type="radio"/>	<input type="radio"/>
	b4 Delay Timers	Timer function settings	<input type="radio"/>	<input type="radio"/>	<input type="radio"/>	<input type="radio"/>
	b5 PID Control	PID control settings	<input type="radio"/>	<input type="radio"/>	<input type="radio"/>	<input type="radio"/>
	b6 Dwell Functions	Acceleration/deceleration time dwell function settings	<input type="radio"/>	<input type="radio"/>	<input type="radio"/>	<input type="radio"/>
	b7 Droop Control	Not used. (Can't be set.)	X	X	X	<input type="radio"/>
	b8 Energy Saving	* Multi-function input: Sets energy-saving control by energy saving reference.	<input type="radio"/>	<input type="radio"/>	X	X
	b9 Zero Servo	Not used. (Can't be set.)	X	X	X	<input type="radio"/>
C Tuning	C1 Accel/Decel	Acceleration/deceleration time settings	<input type="radio"/>	<input type="radio"/>	<input type="radio"/>	<input type="radio"/>
	C2 S-Curve Acc/Dec	S-curve characteristics for accel/decel times	<input type="radio"/>	<input type="radio"/>	<input type="radio"/>	<input type="radio"/>
	C3 Motor-Slip Compensation	Slip compensation function settings	<input type="radio"/>	<input type="radio"/>	<input type="radio"/>	<input type="radio"/>
	C4 Torque Compensation	Torque compensation function settings	<input type="radio"/>	<input type="radio"/>	<input type="radio"/>	X
	C5 Speed Controls	Speed control adjustment	X	<input type="radio"/>	X	<input type="radio"/>
	C6 Carrier Frequency	Carrier frequency settings	<input type="radio"/>	<input type="radio"/>	<input type="radio"/>	<input type="radio"/>
	C7 Hunting Prevention	* Hunting prevention settings	<input type="radio"/>	<input type="radio"/>	X	X
	C8 Factory Tuning	Not used. (Can't be set.)	X	X	<input type="radio"/>	X
d Reference	d1 Preset Reference	Frequency reference settings (when using Operator)	<input type="radio"/>	<input type="radio"/>	<input type="radio"/>	<input type="radio"/>
	d2 Reference Limits	Frequency upper and lower limit settings	<input type="radio"/>	<input type="radio"/>	<input type="radio"/>	<input type="radio"/>
	d3 Prohibited Frequencies	Prohibited frequency settings	<input type="radio"/>	<input type="radio"/>	<input type="radio"/>	<input type="radio"/>
	d4 Reference frequency hold function	Up/Down, Accel/Decel stop hold frequency setting	<input type="radio"/>	<input type="radio"/>	<input type="radio"/>	<input type="radio"/>
	d5 Torque Control	Not used. (Can't be set.)	X	X	X	<input type="radio"/>
E Motor	E1 V/f Pattern	* Motor constant settings (Motor constants are set manually.)	<input type="radio"/>	<input type="radio"/>	<input type="radio"/>	<input type="radio"/>
	E2 Motor Setup		<input type="radio"/>	<input type="radio"/>	<input type="radio"/>	<input type="radio"/>
	E3 Motor 2 Control Methods	Control method settings for motor 2.	<input type="radio"/>	<input type="radio"/>	<input type="radio"/>	<input type="radio"/>
	E4 Motor 2 V/f Characteristics	V/f characteristics settings for motor 2.	<input type="radio"/>	<input type="radio"/>	<input type="radio"/>	<input type="radio"/>
	E5 Motor 2 Motor Constants	Motor constant settings for motor 2.	<input type="radio"/>	<input type="radio"/>	<input type="radio"/>	<input type="radio"/>
F Options	F1 PG Speed Control Card Settings	Constant settings for a PG Speed Control Card	X	<input type="radio"/>	X	<input type="radio"/>
	F2 Analog Reference Card AI	User constant settings for an Analog Reference Card	<input type="radio"/>	<input type="radio"/>	<input type="radio"/>	<input type="radio"/>
	F3 Digital Reference Card DI	User constant settings for a Digital Reference Card	<input type="radio"/>	<input type="radio"/>	<input type="radio"/>	<input type="radio"/>
	F4 Analog Monitor Card AO	User constant settings for an Analog Monitor Card	<input type="radio"/>	<input type="radio"/>	<input type="radio"/>	<input type="radio"/>
	F5 Digital Output Card DO	User constant settings for a Digital Output Card	<input type="radio"/>	<input type="radio"/>	<input type="radio"/>	<input type="radio"/>
	F6 Digital Output Card DO	User constant settings for a Digital Output Card	<input type="radio"/>	<input type="radio"/>	<input type="radio"/>	<input type="radio"/>
	F7 Pulse Monitor Card PO	User constant settings for a Pulse Monitor Card	<input type="radio"/>	<input type="radio"/>	<input type="radio"/>	<input type="radio"/>
	F8 SI-F/SI-G Transmission Card	User constant settings for a Transmission Card	<input type="radio"/>	<input type="radio"/>	<input type="radio"/>	<input type="radio"/>
	F9 CP-916B Transmission Card	User constant settings for a Transmission Card	<input type="radio"/>	<input type="radio"/>	<input type="radio"/>	<input type="radio"/>

Group	Function	Comments	Control Method			
			V/f	V/f w/PG	Open-loop Vector	Flux Vector
H Terminal	H1 Multi-function Inputs	Function selection for multi-function inputs	<input type="radio"/>	<input type="radio"/>	<input type="radio"/>	<input type="radio"/>
	H2 Multi-function Outputs	Function selection for multi-function outputs	<input type="radio"/>	<input type="radio"/>	<input type="radio"/>	<input type="radio"/>
	H3 Analog Inputs	Function selection for analog inputs	<input type="radio"/>	<input type="radio"/>	<input type="radio"/>	<input type="radio"/>
	H4 Multi-function Analog Outputs	Function selection for analog outputs	<input type="radio"/>	<input type="radio"/>	<input type="radio"/>	<input type="radio"/>
	H5 MEMOBUS Communications	MEMOBUS communications settings	<input type="radio"/>	<input type="radio"/>	<input type="radio"/>	<input type="radio"/>
L Protection	L1 Motor Overload	Sets electrical/thermal functions that protect the motor.	<input type="radio"/>	<input type="radio"/>	<input type="radio"/>	<input type="radio"/>
	L2 Power Loss Ridethru	Selects the power-loss processing method.	<input type="radio"/>	<input type="radio"/>	<input type="radio"/>	<input type="radio"/>
	L3 Stall Prevention	Accel/Decel stall prevention settings and selection	<input type="radio"/>	<input type="radio"/>	<input type="radio"/>	<input type="radio"/>
	L4 Reference Detection	Frequency detection settings and selection	<input type="radio"/>	<input type="radio"/>	<input type="radio"/>	<input type="radio"/>
	L5 Fault Restart	Fault restart function settings	<input type="radio"/>	<input type="radio"/>	<input type="radio"/>	<input type="radio"/>
	L6 Torque Detection	Sets overtorque detection functions 1 and 2	<input type="radio"/>	<input type="radio"/>	<input type="radio"/>	<input type="radio"/>
	L7 Torque Limit	Not used. (Can't be set.)	<input type="radio"/>	<input type="radio"/>	<input type="radio"/>	<input type="radio"/>
	L8 Hardware Protection	Hardware overheating and open-phase protection settings	<input type="radio"/>	<input type="radio"/>	<input type="radio"/>	<input type="radio"/>
o Operator	o1 Monitor Select	Selects the Operator's display and setting methods.	<input checked="" type="radio"/>	<input checked="" type="radio"/>	<input type="radio"/>	<input type="radio"/>
	o2 Key Selections	Operator's key function selection and other constants	<input type="radio"/>	<input type="radio"/>	<input type="radio"/>	<input type="radio"/>

7.4.1 Energy-saving Control Function

The energy-saving control function is enabled when the energy-saving command (setting 63) has been set in a multi-function input (H1-01 through H1-06). Inputting the energy-saving command while there is a light load causes the Inverter's output voltage to be reduced and saves energy. Turn OFF the energy-saving command when a normal load is added.

■ Energy-saving Gain: b8-01

User Constant Number	Name	Change during Operation	Setting Range	Unit	Factory Setting	Valid Access Levels			
						V/f Control	V/f with PG	Open Loop Vector	Flux Vector
b8-01	Energy-saving gain	x	0 to 100	%	80	A	A	x	x

- Constant b8-01 determines the Inverter's output voltage when the energy-saving command is input. Set this value as a percentage of the V/f pattern's voltage.
- Constant L2-04 (the voltage recovery time) determines the rate at which the output voltage is changed when the energy-saving command is turned ON or OFF.

■ Energy-saving Frequency: b8-02

User Constant Number	Name	Change during Operation	Setting Range	Unit	Factory Setting	Valid Access Levels			
						V/f Control	V/f with PG	Open Loop Vector	Flux Vector
b8-02	Energy-saving frequency	x	0.0 to 150.0	Hz	0.0	A	A	x	x

- Constant b8-02 determines the lower limit frequency for the energy-saving function.
 - The energy-saving command is enabled only when the frequency reference is above the energy-saving frequency and the motor speed is within the "speed agree" range.
- A time chart for energy-saving operation is shown below.

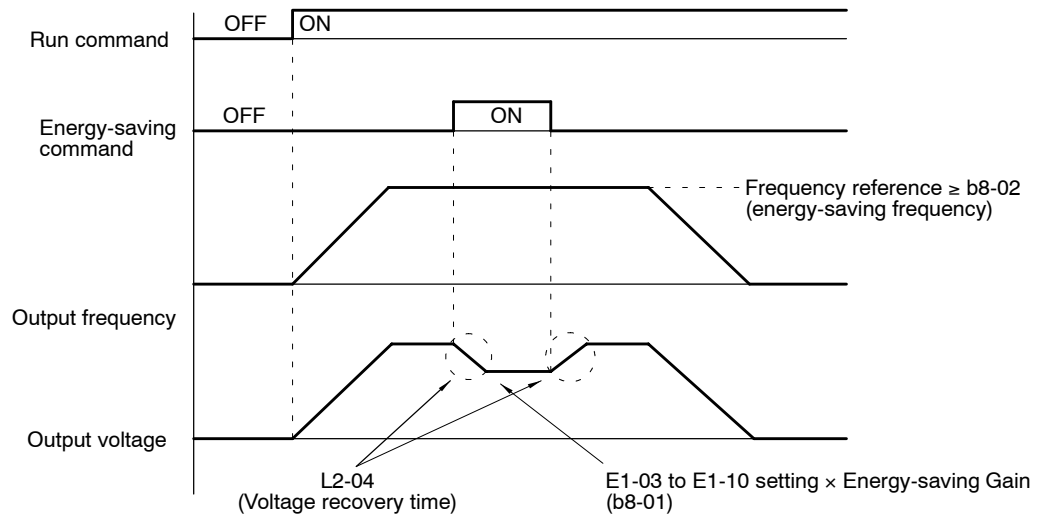

Fig 7.17 Time Chart for Energy-saving Operation

7.4.2 Hunting-prevention Function

The hunting-prevention function suppresses hunting when the motor is operating with a light load. This function is valid with V/f control and V/f with PG feedback control.

■ Hunting Prevention Selection: C7-01

User Constant Number	Name	Change during Operation	Setting Range	Unit	Factory Setting	Valid Access Levels			
						V/f Control	V/f with PG	Open Loop Vector	Flux Vector
C7-01	Hunting prevention selection	x	0, 1	-	1	A	A	x	x

- Settings

Setting	Function
0	Disables the hunting-prevention function.
1	Enables the hunting-prevention function.

■ Hunting Prevention Gain: C7-02

User Constant Number	Name	Change during Operation	Setting Range	Unit	Factory Setting	Valid Access Levels			
						V/f Control	V/f with PG	Open Loop Vector	Flux Vector
C7-02	Hunting prevention gain	x	0.00 to 2.50	Multiple	1.00	A	A	x	x

- Normally it isn't necessary to change these constants. Adjust these constants as follows if hunting occurs with a light load.
 - Increase the setting in C7-02 if oscillation occurs when operating with a light load. (If the setting is increased too much, the current can fall to the point where stalling occurs.)
 - Decrease the setting in C7-02 if stalling occurs.
 - Disable the hunting-prevention function (C7-01 = 0) if high responsiveness is more important than suppressing oscillation.

7.4.3 Setting Motor Constants

■ Motor Rated Slip: E2-02

User Constant Number	Name	Change during Operation	Setting Range	Unit	Factory Setting	Valid Access Levels			
						V/f Control	V/f with PG	Open Loop Vector	Flux Vector
E2-02	Motor rated slip	x	0.00 to 20.00	Hz	1.30	A	A	Q	Q

- These settings are used as reference values for the motor slip compensation function.
- The default setting depends upon the Inverter capacity. (The table shows the default settings for 400-V class, 200 kW Inverters.) (See page 8 - 42.)
- Calculate the rated slip (E2-02) from the value shown on the motor nameplate with the following equation and set this value.

$$\text{Rated slip} = \text{rated frequency (Hz)} - \text{rated speed (r/min)} \times \text{number of poles}/120$$

■ Motor No-load Current: E2-03

User Constant Number	Name	Change during Operation	Setting Range	Unit	Factory Setting	Valid Access Levels			
						V/f Control	V/f with PG	Open Loop Vector	Flux Vector
E2-03	Motor no-load current	x	0.00 to 2000.0	A	96.0	A	A	Q	Q

- These settings are used as reference values for the motor slip compensation function.
- The default setting depends upon the Inverter capacity. (The table shows the default settings for 400-V class, 200 kW Inverters.) (See page 8 - 42.)
- Set the no-load current (E2-03) at the rated voltage and rated frequency. Normally this value isn't shown on the motor nameplate, so it might be necessary to contact the motor manufacturer.

■ Motor Line-to-line Resistance: E2-05

User Constant Number	Name	Change during Operation	Setting Range	Unit	Factory Setting	Valid Access Levels			
						V/f Control	V/f with PG	Open Loop Vector	Flux Vector
E2-05	Motor line-to-line resistance	x	0.000 to 65.000	x	0.020	A	A	A	A

- This setting is used as a reference value for the torque compensation function.
- The default setting depends upon the Inverter capacity.
(The table shows the default settings for 400-V class, 200 kW Inverters.) (See page 8 - 42.)
- Set the motor's terminal resistance (U-V, V-W, and W-U). Normally this value isn't shown on the motor nameplate, so it might be necessary to contact the motor manufacturer.

7.5 Common Functions

The functions that can be used for all control methods are listed in *Table 7.5*. Details on functions marked with a * are provided in the following table.

Table 7.5 Functions Used with All Control Methods

Group	Function	Comments	Control Method			
			V/f	V/f w/PG	Open-loop Vector	Flux Vector
b Application	b1 Sequence	Settings such as the reference input method	○	○	○	○
	b2 DC Injection Braking	* DC injection braking function settings	○	○	○	○
	b3 Speed Search	* Speed search function settings	○	○	○	○
	b4 Delay Timers	* Timer function settings	○	○	○	○
	b5 PID Control	* PID control settings	○	○	○	○
	b6 Dwell Functions	* Acceleration/deceleration time dwell function settings	○	○	○	○
	b7 Droop Control	Droop control settings	X	X	X	○
	b8 Energy Saving	Multi-function input: Sets energy-saving control by energy saving reference.	○	○	X	X
	b9 Zero Servo	Zero servo settings	X	X	X	○
C Tuning	C1 Accel/Decel	Acceleration/deceleration time settings	○	○	○	○
	C2 S-Curve Acc/Dec	* S-curve characteristics for acceleration/deceleration times	○	○	○	○
	C3 Motor-Slip Compensation	* Slip compensation function settings	○	○	○	○
	C4 Torque Compensation	* Torque compensation function settings	○	○	○	X
	C5 Speed Controls	Speed control tuning	X	○	X	○
	C6 Carrier Frequency	* Carrier frequency settings	○	○	○	○
	C7 Hunting Prevention	Hunting prevention settings	○	○	X	X
	C8 Factory Tuning	Adjustment for open-loop vector control	X	X	○	X
d Reference	d1 Preset Reference	Frequency reference settings (when using Operator)	○	○	○	○
	d2 Reference Limits	* Frequency upper and lower limit settings	○	○	○	○
	d3 Prohibited Frequencies	* Prohibited frequency settings	○	○	○	○
	d4 Reference Frequency Hold Functions	* Up/Down, Accel/Decel stop hold frequency setting	○	○	○	○
	d5 Torque Control	Torque control settings and tuning	X	X	X	○
E Motor	E1 V/f Pattern	Motor constant settings	○	○	○	○
	E2 Motor Setup		○	○	○	○
	E3 Motor 2 Control Methods	Control method settings for motor 2.	○	○	○	○
	E4 Motor 2 V/f Characteristics	V/f characteristics settings for motor 2.	○	○	○	○
	E5 Motor 2 Motor Constants	Motor constant setting for motor 2.	○	○	○	○
F Options	F1 PG Speed Control Card Settings	Constant settings for a PG Speed Control Card	X	○	X	○
	F2 Analog Reference Card AI	* User constant settings for an Analog Reference Card	○	○	○	○
	F3 Digital Reference Card DI	* User constant settings for a Digital Reference Card	○	○	○	○
	F4 Analog Monitor Card AO	* User constant settings for an Analog Monitor Card	○	○	○	○
	F5 Digital Output Card DO	User constant settings for a Digital Output Card	○	○	○	○
	F6 Digital Output Card DO	User constant settings for a Digital Output Card	○	○	○	○
	F7 Pulse Monitor Card PO	* User constant settings for a Pulse Monitor Card	○	○	○	○
	F8 SI-F/SI-G Transmission Card	User constant settings for a Transmission Card	○	○	○	○
	F9 CP-916B Transmission Card	User constant settings for a Transmission Card	○	○	○	○

Group	Function	Comments	Control Method						
			V/f	V/f w/PG	Open-loop Vector	Flux Vector			
H Terminal	H1	Multi-function Inputs	* Function selection for multi-function inputs			<input type="radio"/>	<input type="radio"/>	<input type="radio"/>	<input type="radio"/>
	H2	Multi-function Outputs	* Function selection for multi-function outputs			<input type="radio"/>	<input type="radio"/>	<input type="radio"/>	<input type="radio"/>
	H3	Analog Inputs	* Function selection for analog inputs			<input type="radio"/>	<input type="radio"/>	<input type="radio"/>	<input type="radio"/>
	H4	Multi-function Analog Outputs	* Function selection for analog outputs			<input type="radio"/>	<input type="radio"/>	<input type="radio"/>	<input type="radio"/>
	H5	MEMOBUS Communications	MEMOBUS communications settings			-	-	-	-

Group	Function	Comments	Control Method			
			V/f	V/f w/PG	Open-loop Vector	Flux Vector
L Protection	L1	Motor Overload	* Sets electrical/thermal functions that protect the motor.			
	L2	Power Loss Rides thru	* Selects the power-loss processing method.			
	L3	Stall Prevention	* Accel/Decel stall prevention settings and selection			
	L4	Reference Detection	* Frequency detection settings and selection			
	L5	Fault Restart	* Fault restart function settings			
	L6	Torque Detection	* Sets overtorque detection functions 1 and 2			
	L7	Torque Limit	Torque limit settings			
	L8	Hardware Protection	* Hardware overheating and open-phase protection settings			
o Operator	o1	Monitor Select	* Selects the Operator display and setting methods.			
	o2	Key Selections	* Operator key function selection and other constants			

7.5.1 Application Constants: b

■ DC Injection Braking: b2-01 to b2-04

- The DC injection braking function decelerates by applying a DC current to the motor. This happens in the following two cases
 - DC Injection Braking Time at Start: Effective for temporarily stopping and then restarting, without regenerative processing, a motor coasting by inertia.
 - DC Injection Braking Time at Stop: Used to prevent coasting by inertia when the motor is not completely stopped by normal deceleration when there is a large load. The stopping time can be shortened by lengthening the DC injection braking time or increasing the DC injection braking current.

User Constant Number	Name	Change during Operation	Setting Range	Unit	Factory Setting	Valid Access Levels			
						V/f Control	V/f with PG	Open Loop Vector	Flux Vector
b2-01	Zero speed level (DC injection braking starting frequency)	X	0.0 to 10.0	Hz	0.5	B	B	B	B
b2-02	DC injection braking current	X	0 to 100	%	50	B	B	B	X
b2-03	DC injection braking time at start	X	0.00 to 10.00	s	0.00	B	B	B	B
b2-04	DC injection braking time at stop	X	0.00 to 10.00	s	0.50	B	B	B	B

- For the zero speed level (b2-01), set the frequency for beginning DC injection braking for deceleration. If the excitation level is lower than the minimum output frequency (E1-09), the DC injection braking will begin from the minimum output frequency.
- In flux vector control mode, DC injection braking becomes the initial excitation starting frequency at the time of deceleration. In that case, braking starts from the excitation level regardless of the minimum output frequency setting.
- The excitation level is also used as the operating frequency for the zero servo function (for flux vector control only).
- For the DC injection braking current (b2-02), set the value for the current that is output at the time of DC injection braking. DC injection braking current is set as a percentage of Inverter rated output current, with the Inverter rated output current taken as 100%.
- For the DC injection braking time at start (b2-03), set the DC injection braking operating time for when the motor is started.
- For the DC injection braking time at stop (b2-04), set the DC injection braking operating time for when the motor is stopped.
- *Figure 7.18* provides a timing chart of DC injection braking (initial excitation).

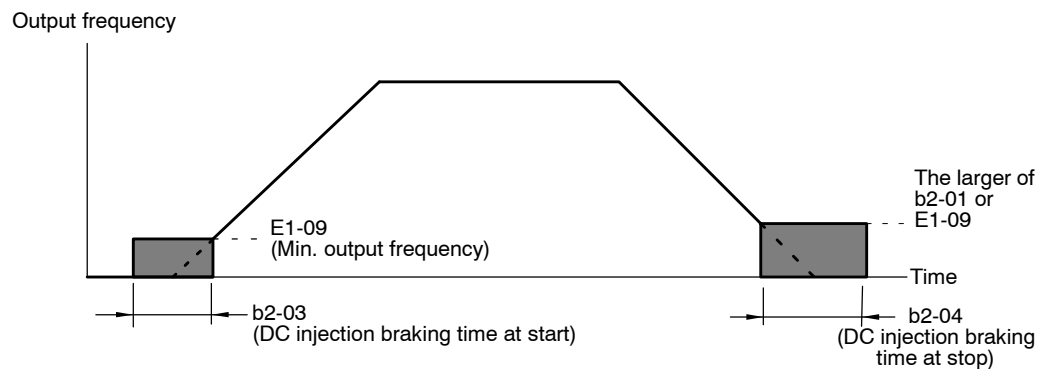

Fig 7.18 DC Injection Braking Timing Chart

■ **Speed Search: b3-01 to b3-03**

The speed search function finds the speed of a coasting motor and starts up smoothly from that speed. It is effective in situations such as switching from a commercial power supply.

Speed Search Selection at Start: b3-01

User Constant Number	Name	Change during Operation	Setting Range	Unit	Factory Setting	Valid Access Levels			
						V/f Control	V/f with PG	Open Loop Vector	Flux Vector
b3-01	Speed search selection at start	x	0, 1	-	0 *	A	A	A	A

* When the control method is switched, the factory setting changes as follows:
V/f control: 0; V/f with PG: 1; open-loop vector 0; flux vector: 1

• **Settings**

Setting	Contents
0	Speed search disabled: Motor starts from minimum output frequency.
1	Speed search enabled: Speed search is performed from maximum output frequency and motor is started. (In control methods with PG, i.e., V/f with PG feedback and flux vector, motor starts from the motor speed.)

- Set “1” to use the speed search function. A speed search is performed each time the run command is input.
- To use speed search freely in control methods without PG, i.e., V/f control and open-loop vector control, set the multi-function contact input selection (H1-01 to H1-06) to 61 or 62 (external search command). (See para 7.5.5.)

Speed Search Operating Current, Speed Search Deceleration Time, and Min. Baseblock Time: b3-02, b3-03, L2-03

User Constant Number	Name	Change during Operation	Setting Range	Unit	Factory Setting	Valid Access Levels			
						V/f Control	V/f with PG	Open Loop Vector	Flux Vector
b3-02	Speed search operating current	x	0 to 200	%	100 (150) *1	A	x	A	x
b3-03	Speed search deceleration time	x	0.1 to 10.0	s	2.0	A	x	A	x
L2-03	Min. baseblock time	x	0.0 to 0.5	s	0.5 *2	B	B	B	B

* 1. The factory setting for V/f control is 150%.

* 2. The factory setting varies depending on the Inverter capacity. The values shown in the table are for 400-V class Inverters of 200 kW.

- For the speed search operating current (b3-02), set the operating current for the speed search. If restarting is not possible with the setting, then lower the setting.
- Set the speed search operating current as a percentage of the Inverter’s rated output current, with the Inverter’s rated output current taken as 100%.
- For the speed search deceleration time (b3-03), set the output frequency deceleration time for while the speed search is being performed. Set the time required to decelerate from the maximum output frequency to 0 Hz.
- When the speed search and DC injection braking are set, set the minimum baseblock time (L2-03). For the minimum baseblock time, set the time to wait for the motor’s residual voltage to dissipate. If an over-current is detected when starting a speed search or DC injection braking, raise the setting to prevent a fault from occurring.

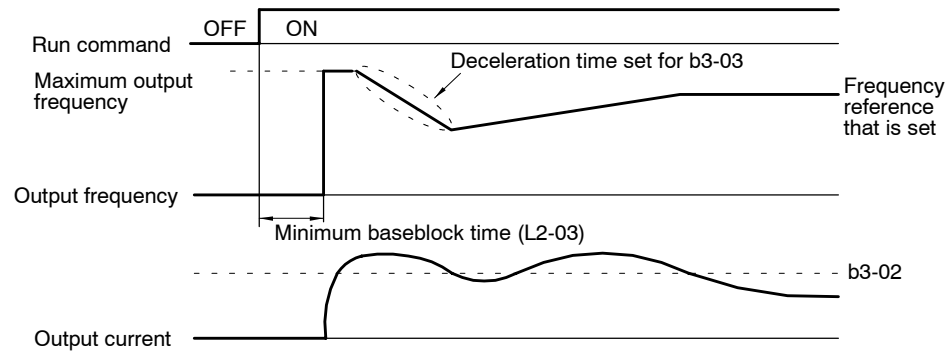

Fig 7.19 Speed Search Timing Chart

■ Timer Functions: b4-01, b4-02

- The timer functions are enabled when the timer function input (setting: 18) and the timer function output (setting: 12) are set for the multi-function input and multi-function output respectively.
- These inputs and outputs serve as general-purpose I/O. Chattering of sensors, switches, and so on, can be prevented by setting a delay time.

User Constant Number	Name	Change during Operation	Setting Range	Unit	Factory Setting	Valid Access Levels			
						V/f Control	V/f with PG	Open Loop Vector	Flux Vector
b4-01	Timer function ON-delay time	X	0.0 to 300.0	s	0.0	A	A	A	A
b4-02	Timer function OFF-delay time	X	0.0 to 300.0	s	0.0	A	A	A	A

- When the timer function input ON time is longer than the value set for b4-01 (timer function ON-delay time), the timer function output turns ON.
- When the timer function input OFF time is longer than the value set for b4-02 (timer function OFF-delay time), the timer function output turns OFF. An operation example of the timer function is shown in *Figure 7.20*.

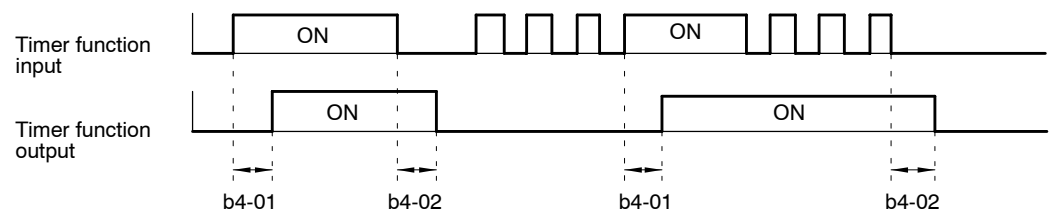

Fig 7.20 Operation Example of Timer Function

■ PID Control Settings: b5-01 to b5-08

The PID control function is a control system that matches a feedback value (i.e., a detected value) to the set target value. Combining proportional (P), integral (I), and derivative (D) control makes control possible even for a mechanical system with dead time.

This section explains the PID control applications and operations, along with the constant settings and tuning procedure.

PID Control Applications

Table 7.6 shows examples of PID control applications using the Inverter.

Table 7.6 PID Control Applications

Application	Control contents	Sensors used (example)
Speed control	<ul style="list-style-type: none"> Speeds are matched to target values as speed information in a mechanical system. Speed information for another mechanical system is input as target values, and synchronized control is executed by feeding back actual speeds. 	Tachogenerator
Pressure control	Pressure information is returned as feedback for stable pressure control.	Pressure sensor
Flow control	Flow information is returned as feedback for accurate flow control.	Flow sensor
Temperature control	Temperature information is returned as feedback to control temperature by turning a fan.	<ul style="list-style-type: none"> Thermocouple Thermistor

PID Control Operations

In order to distinguish the separate PID control operations (i.e., proportional, integral, and derivative), *Figure 7.21* shows the changes in the control input (i.e., the output frequency) when the deviation between the target value and the feedback is held constant.

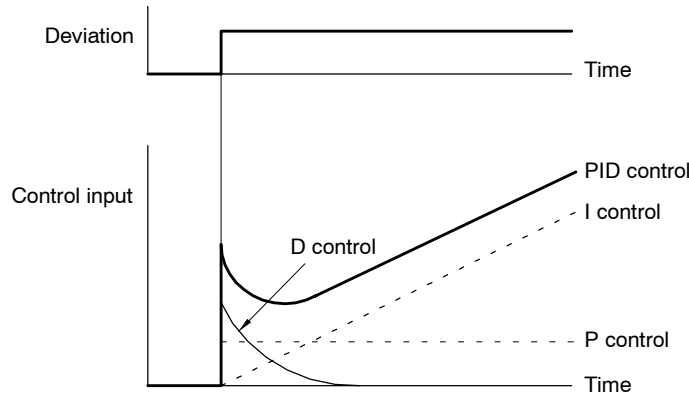

Fig 7.21 PID Control Operations

- P Control: A control input proportional to the deviation is output. The deviation cannot be zeroed by P control alone.
- I Control: A control input which is an integral of the deviation is output. This is effective for matching the feedback to the target value. Sudden changes, however, cannot be followed.
- D Control: A control input which is an integral of the deviation is output. Quick response to sudden changes is possible.
- PID Control: Optimum control is achieved by combining the best features of P, I, and D control.

Types of PID Control

Two types of PID control are possible with the Inverter: Measured-value derivative PID control and basic PID control. The type that is normally used is measured-value derivative PID control.

- Measured-value Derivative PID Control: With measured-value derivative PID control, the feedback value is differentiated for PID control. Response is possible with respect to changes both in target values and the control object.

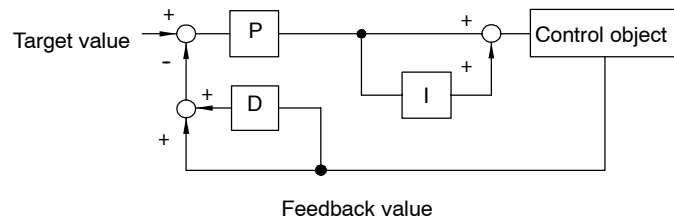

- **Basic PID Control:** This is the basic form of PID control. When the D control response is adjusted to follow changes in the control object, overshooting and undershooting can occur with changes in the target value.

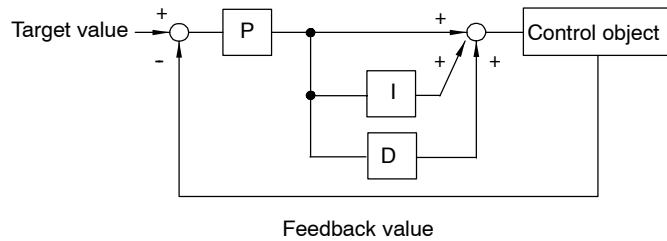

Inverter's PID Control Function

Figure 7.22 is a block diagram of the Inverter's internal PID control.

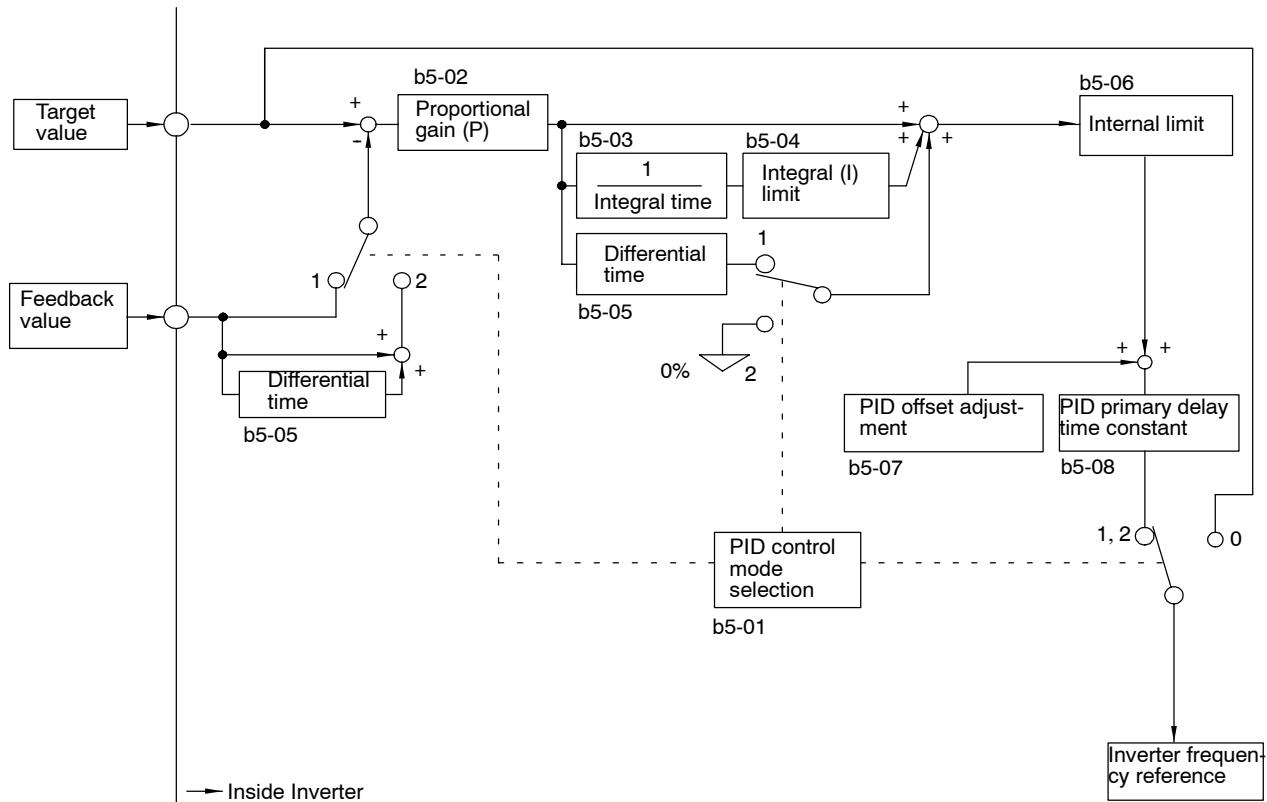

Fig 7.22 Block Diagram for PID Control in Inverter

PID Control Settings

- PID Control Mode Selection: b5-01

User Constant Number	Name	Change during Operation	Setting Range	Unit	Factory Setting	Valid Access Levels			
						V/f Control	V/f with PG	Open Loop Vector	Flux Vector
b5-01	PID control mode selection	x	0 to 2	-	0	A	A	A	A

- Settings

Setting	Contents
0	PID control disabled
1	PID control enabled, deviation signal is subject to derivative control.
2	PID control enabled, feedback signal is subject to derivative control.

- To enable PID control, set either “1” or “2.” (Normally “2” is used, for measured-value derivative PID control).
- When PID control is enabled, the target value input is determined by constant b1-01 (reference selection).
- When target value input is set to b1-01=0 (digital operator), setting value becomes o1-03 (% unit), and the target value should be input by percent. (When switching speed reference, 100% becomes the max. frequency reference value.)
- The feedback value is input from a multi-function analog input terminal or frequency reference (current) terminal. Set PID feedback (setting: B) for either the constant H3-05 (multi-function analog input, terminal 42), or constant H3-09 (multi-function analog input, terminal 39) function selection. (See Table 7.11.) Adjust the amount of feedback by setting the gain and bias of the analog inputs that are used.
- Proportional gain (P), Integral (I) Time, and Differential (D) Time: b5-02, b5-03, b5-05
 - Adjust the responsiveness of the PID control by means of the proportional gain (P), integral time (I), and derivative time (D).

User Constant Number	Name	Change during Operation	Setting Range	Unit	Factory Setting	Valid Access Levels			
						V/f Control	V/f with PG	Open Loop Vector	Flux Vector
b5-02	Proportional gain (P)	○	0.00 to 25.00	Multiple	1.00	A	A	A	A
b5-03	Integral (I) time	○	0.0 to 360.0	s	1.0	A	A	A	A
b5-05	Differential (D) time	○	0.00 to 10.00	s	0.00	A	A	A	A

- Optimize the responsiveness by adjusting it while operating an actual load (mechanical system). (Refer to *Adjusting PID Control* on page 7 - 47.) Any control (P, I, or D) that is set to zero (0.0, 0.00) will not operate.
- Integral (I) Limit: b5-04

User Constant Number	Name	Change during Operation	Setting Range	Unit	Factory Setting	Valid Access Levels			
						V/f Control	V/f with PG	Open Loop Vector	Flux Vector
b5-04	Integral (I) limit	○	0.0 to 100.0	%	100.0	A	A	A	A

- This constant prevents the calculated value of the integral control in the PID control from exceeding the fixed amount.
- There is normally no need to change the setting.
- Reduce the setting if there is a risk of load damage, or of the motor going out of step, by the Inverter’s response when the load suddenly changes. If the setting is reduced too much, the target value and the feedback value will not match.
- Set this constant as a percentage of the maximum output frequency, with the maximum frequency taken as 100%.
- PID Limit: b5-06

User Constant Number	Name	Change during Operation	Setting Range	Unit	Factory Setting	Valid Access Levels			
						V/f Control	V/f with PG	Open Loop Vector	Flux Vector
b5-06	PID limit	○	0.0 to 100.0	%	100.0	A	A	A	A

- Constant b5-06 prevents the frequency reference after PID control from exceeding the fixed amount.
- Set this constant as a percentage of the maximum output frequency, with the maximum frequency taken as 100%.
- PID Offset Adjustment: b5-07

User Constant Number	Name	Change during Operation	Setting Range	Unit	Factory Setting	Valid Access Levels			
						V/f Control	V/f with PG	Open Loop Vector	Flux Vector
b5-07	PID offset adjustment	○	-100.0 to 100.0	%	0.0	A	A	A	A

- Constant b5-07 adjusts the PID control offset.
- If both the target value and the feedback value are set to zero, adjust the Inverter's output frequency to zero.
- PID Primary Delay Time Constant: b5-08

User Constant Number	Name	Change during Operation	Setting Range	Unit	Factory Setting	Valid Access Levels			
						V/f Control	V/f with PG	Open Loop Vector	Flux Vector
b5-08	PID primary delay time constant	○	0.00 to 10.00	s	0.00	A	A	A	A

- Constant b5-08 is the low-pass filter setting for PID control outputs.
- There is normally no need to change the setting.
- If the viscous friction of the mechanical system is high, or if the rigidity is low, causing the mechanical system to oscillate, increase the setting so that it is higher than the oscillation frequency period. This will decrease the responsiveness, but it will prevent the oscillation.

Adjusting PID Control

Use the following procedure to activate PID control and then adjust it while monitoring the response.

1. Enable PID control (set b5-01 to 2 or 1).
2. Increase the proportional gain P in b5-02 as far as possible without creating oscillation.
3. Reduce the integral time I in b5-03 as far as possible without creating oscillation.
4. Increase the differential time (D) in b5-05 as far as possible without creating oscillation.

Making Fine Adjustments

First set the individual PID control constants, and then make fine adjustments.

- Reducing Overshooting
If overshooting occurs, shorten the derivative time (D) and lengthen the integral time (I).

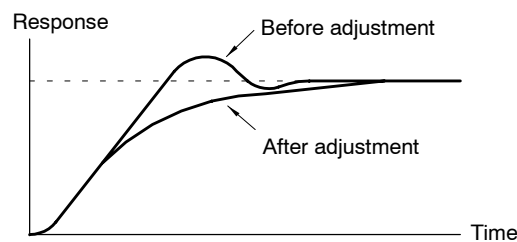

- Rapidly Stabilizing Control Status
To rapidly stabilize the control conditions even when overshooting occurs, shorten the integral time (I) and lengthen the derivative time (D).

Advanced Operation

7.5.1 Application Constants: b

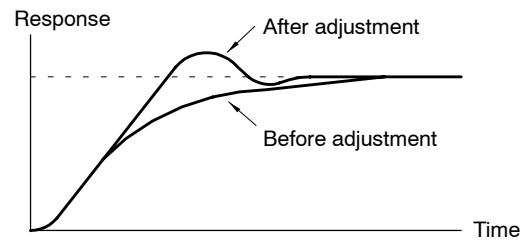

- Reducing Long-cycle Oscillation

If oscillation occurs with a longer cycle than the integral time (I) setting, it means that integral operation is strong. The oscillation will be reduced as the integral time (I) is lengthened.

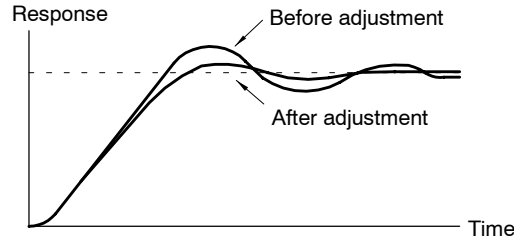

- Reducing Short-cycle Oscillation

If the oscillation cycle is short and oscillation occurs with a cycle approximately the same as the derivative time (D) setting, it means that the derivative operation is strong. The oscillation will be reduced as the derivative time (D) is shortened.

If oscillation cannot be reduced even by setting the derivative time (D) to “0.00” (no derivative control), then either lower the proportional gain (P) or raise the PID primary delay time constant.

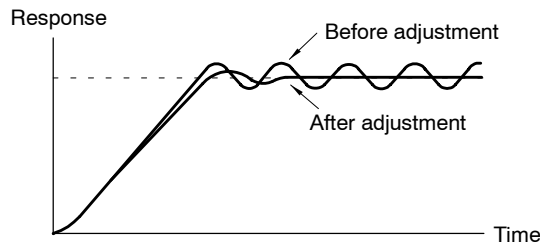

■ Dwell Functions: b6-01 to b6-04

- The dwell functions are used to temporarily hold the output frequency when starting or stopping a motor with a heavy load. This helps to prevent stalling.

User Constant Number	Name	Change during Operation	Setting Range	Unit	Factory Setting	Valid Access Levels			
						V/f Control	V/f with PG	Open Loop Vector	Flux Vector
b6-01	Dwell frequency at start	X	0.0 to 150.0	Hz	0.0	A	A	A	A
b6-02	Dwell time at start	X	0.0 to 10.0	s	0.0	A	A	A	A
b6-03	Dwell frequency at stop	X	0.0 to 150.0	Hz	0.0	A	A	A	A
b6-04	Dwell time at stop	X	0.0 to 10.0	s	0.0	A	A	A	A

- The relation between these constants is shown in *Figure 7.23*.

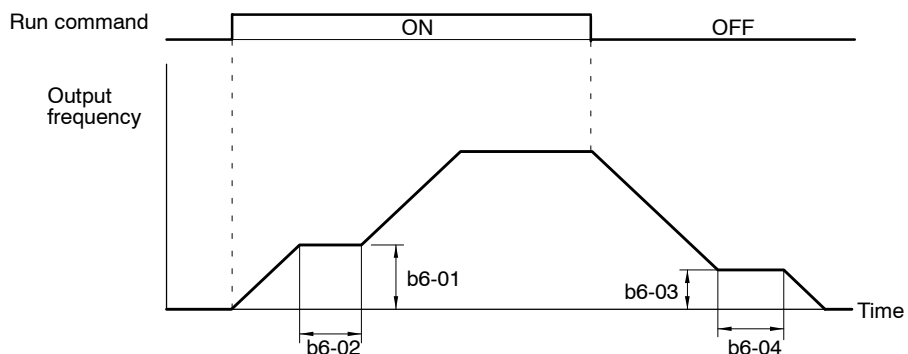

Fig 7.23 Timing Chart for Dwell Functions

7.5.2 Tuning Constants: C

■ S-curve Characteristic Function: C2-01 to C2-04

- Using the S-curve characteristic function for acceleration and deceleration can reduce shock to the machinery when stopping and starting.
- With the Inverter, S-curve characteristic times can be set respectively for beginning acceleration, ending acceleration, beginning deceleration, and ending deceleration.

User Constant Number	Name	Change during Operation	Setting Range	Unit	Factory Setting	Valid Access Levels			
						V/f Control	V/f with PG	Open Loop Vector	Flux Vector
C2-01	S-curve characteristic time at acceleration start	X	0.00 to 2.50	s	0.20	A	A	A	A
C2-02	S-curve characteristic time at acceleration end	X	0.00 to 2.50	s	0.20	A	A	A	A
C2-03	S-curve characteristic time at deceleration start	X	0.00 to 2.50	s	0.20	A	A	A	A
C2-04	S-curve characteristic time at deceleration end	X	0.00 to 2.50	s	0.00	A	A	A	A

- The relation between these constants is shown in *Figure 7.24*.

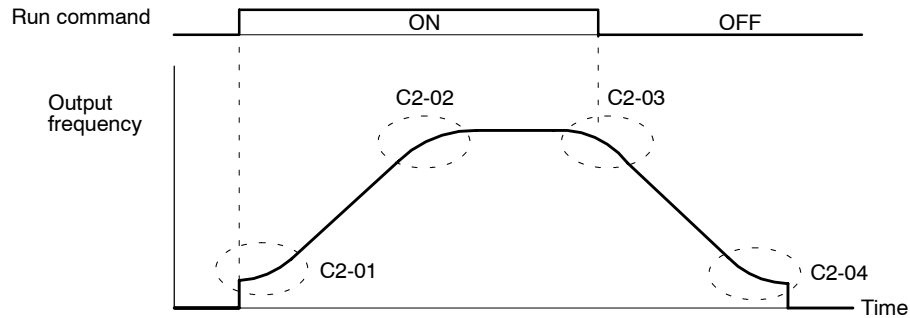

Fig 7.24 Setting S-curve Characteristics

- When the S-curve characteristic time is set, the acceleration and deceleration times will be lengthened as follows:
 - Acceleration time = Selected acceleration time + (S-curve at beginning of acceleration + S-curve at end of acceleration) / 2
 - Deceleration time = Selected deceleration time + (S-curve at beginning of deceleration + S-curve at end of deceleration) / 2

■ Motor Slip Compensation: C3-01 to C3-04

- The motor slip compensation function calculates the motor torque according to the output current, and sets gain to compensate for output frequency.
 - This function is used to improve speed accuracy when operating with a load. It is mainly effective with V/f control (without PG).

Slip Compensation Gain: C3-01

User Constant Number	Name	Change during Operation	Setting Range	Unit	Factory Setting	Valid Access Levels			
						V/f Control	V/f with PG	Open Loop Vector	Flux Vector
C3-01	Slip compensation gain	○	0.0 to 2.5	Multiple	1.0 *	B	X	B	B

* When the control method is switched, the factory setting changes as follows:
 V/f control: 0.0; V/f with PG: 1.0; open-loop vector 0; flux vector: 1.0

- When “1.0” is set, this function compensates for the rated slip that has been set, by the rated torque output.
- With flux vector control, this becomes the gain to compensate for slip caused by motor temperature variation. (Refer to *Slip Compensation Gain: C3-01* under 7.3.6.)

Motor Slip Compensation Gain Adjustment Procedure

1. Correctly set the motor rated slip (constant E2-02) and the motor no-load current (constant E2-03).
 - The motor rated slip can be calculated by means of the following equation, using the numbers that are shown on the motor nameplate.
Motor rated slip = $\frac{\text{Motor rated frequency (Hz)} - \text{rated speed (r/min)} \times \text{motor (No. of poles)} / 120}{\text{Motor rated frequency (Hz)}}$
 - Set the values at the rated voltage and rated frequency for the motor no-load current. With vector control, the motor rated slip is automatically set by autotuning.
2. Set the slip compensation gain (constant C3-01 to “1.0.” (If it is set to “0.0,” slip compensation will be disabled.)
3. Operate with a load, measure the speed, and adjust the slip compensation gain (in increments of 0.1).
 - If the speed is lower than the target value, increase the slip compensation gain.
 - If the speed is higher than the target value, decrease the slip compensation gain.

Slip Compensation Primary Delay Time: C3-02

User Constant Number	Name	Change during Operation	Setting Range	Unit	Factory Setting	Valid Access Levels			
						V/f Control	V/f with PG	Open Loop Vector	Flux Vector
C3-02	Slip compensation primary delay time	x	0 to 10000	ms	200 *	A	x	A	x

* When the control method is switched, the values change as follows:
V/f control: 2,000; open-loop vector: 200

- This constant does not normally need to be set. Adjust the slip compensation primary delay time if the motor slip compensation responsiveness is low, or if the speeds are unstable.
 - If responsiveness is low, lower the setting.
 - If speeds are unstable, raise the setting.

Slip Compensation Limit: C3-03

User Constant Number	Name	Change during Operation	Setting Range	Unit	Factory Setting	Valid Access Levels			
						V/f Control	V/f with PG	Open Loop Vector	Flux Vector
C3-03	Slip compensation limit	x	0 to 250	%	200	A	x	A	x

- Constant C3-03 sets the slip compensation limit as a percentage of motor rated slip (E2-02), with the motor rated slip taken as 100%.
- If the speed is lower than the target value and does not change even when the slip compensation gain is adjusted, it is possible that the slip compensation limit has been reached. Raise the limit and then check again. Make sure, however, that the value of the sum of the reference frequency and the slip compensation limit does not exceed the speed capacity of the machinery.
- The limit is as shown in *Figure 7.25* in the constant torque and constant output areas.

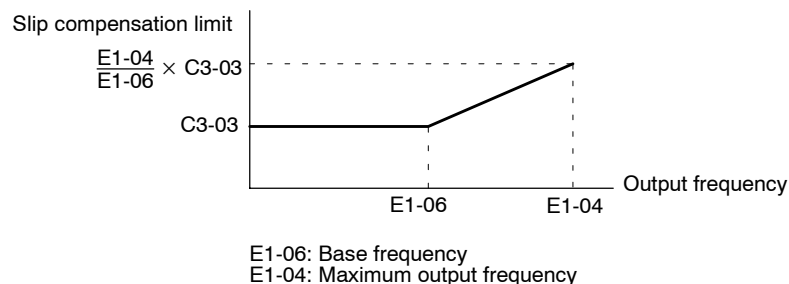

Fig 7.25 Slip Compensation Limit

Slip Compensation Selection During Regeneration: C3-04

User Constant Number	Name	Change during Operation	Setting Range	Unit	Factory Setting	Valid Access Levels			
						V/f Control	V/f with PG	Open Loop Vector	Flux Vector
C3-04	Slip compensation selection during regeneration	x	0, 1	-	0	A	A	A	x

- Settings

Setting	Contents
0	Slip compensation disabled during regeneration
1	Slip compensation enabled during regeneration

- Constant C3-04 enables or disables slip compensation during regeneration.
- The amount of regeneration is momentarily increased when this function is used, so some control option (e.g., Braking resistor, Braking Resistor Unit, Braking Unit) may be required.

■ Torque Compensation Function: C4-01, C4-02

The torque compensation function detects increases in the motor load, and increases the output torque to compensate.

Torque Compensation Gain: C4-01

User Constant Number	Name	Change during Operation	Setting Range	Unit	Factory Setting	Valid Access Levels			
						V/f Control	V/f with PG	Open Loop Vector	Flux Vector
C4-01	Torque compensation gain	x	0.00 to 2.50	Multiple	1.00	B	B	B	x

- This constant can be changed during operation, but normally no adjustments are required. Make adjustments in the following cases under the V/f control mode:
 - If the wiring distance between the Inverter and the motor is long, raise the setting.
 - If the motor capacity is less than the Inverter capacity (the maximum application motor capacity), raise the setting.
 - If the motor generates excessive oscillation, lower the setting.
- Set the torque compensation gain so that the output current at low-speed rotation does not exceed 50% of the Inverter's rated output current.
- Do not adjust the setting of this constant for open-loop vector control.

Torque Compensation Time Constant: C4-02

User Constant Number	Name	Change during Operation	Setting Range	Unit	Factory Setting	Valid Access Levels			
						V/f Control	V/f with PG	Open Loop Vector	Flux Vector
C4-02	Torque compensation time constant	x	0 to 10000	ms	20 *	A	A	A	x

* When the control method is switched, the factory setting changes as follows:
 V/f control: 200; V/f with PG: 200; open-loop vector: 20

- The torque compensation time constant does not normally need to be adjusted, but make adjustments in the following cases:
 - If the motor generates excessive oscillation, raise the setting.
 - If motor responsiveness is low, lower the setting.

■ Carrier Frequency: C6-01 to C6-03

- The carrier frequency characteristics differ according to the control method.
 - V/f control and V/f with PG feedback control: Carrier frequency variable setting possible.
 - Open-loop vector control and flux vector control: Constant frequency (The carrier frequency upper limit only is set.)
- The carrier frequency does not normally need to be adjusted.

User Constant Number	Name	Change during Operation	Setting Range	Unit	Factory Setting	Valid Access Levels			
						V/f Control	V/f with PG	Open Loop Vector	Flux Vector
C6-01	Carrier frequency upper limit	x	2.0	kHz	2.0 *	B	B	B	B
C6-02	Carrier frequency lower limit	x	0.4 to 2.0	kHz	2.0 *	A	A	x	x
C6-03	Carrier frequency proportional gain	x	00 to 99	Multiple	00	A	A	x	x

* The setting range and the factory setting vary according to the Inverter capacity. The table shows a value of 400-V class, 200 kW. (See page 8 - 42.)

- In the vector control modes, the carrier frequency is determined by the carrier frequency upper limit (constant C6-01). In the V/f control modes (both with and without PG), the carrier frequency can be changed in response to the output frequency by setting the carrier frequency lower limit (constant C6-02) and the carrier frequency proportional gain (constant C6-03).

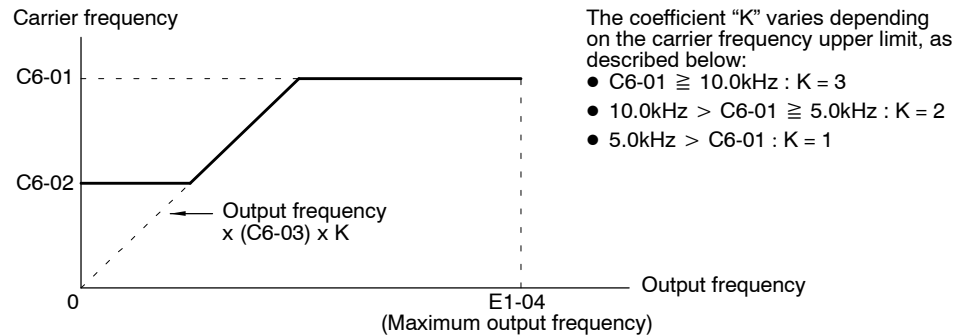

Fig 7.26 Setting the Carrier Frequency

- To make the carrier frequency constant, either set the same value for constants C6-01 and C6-02 or set the carrier frequency proportional gain (constant C6-03) to "0" (i.e., fix at upper limit value). The following settings will generate a constant setting fault (OPE11):
 - Carrier frequency upper limit (C6-01) > 5.0 kHz and carrier frequency lower limit (C6-02) \leq 5.0 kHz
 - Carrier frequency proportional gain (C6-03) > 6 and (C6-01) < C6-02
- If the lower limit is set higher than the upper limit, the lower limit will be disregarded and carrier frequency will be fixed at the upper limit.

7.5.3 Reference Constants: d

■ Frequency Reference Function: d2-01, d2-02

- The frequency reference function sets the output frequency upper and lower limits.
- When the frequency reference is zero and a run command is input, the motor operates at the frequency reference lower limit (d2-02). The motor will not operate, however, if the lower limit is set lower than the minimum output frequency (E1-09).

User Constant Number	Name	Change during Operation	Setting Range	Unit	Factory Setting	Valid Access Levels			
						V/f Control	V/f with PG	Open Loop Vector	Flux Vector
d2-01	Frequency reference upper limit	x	0.0 to 110.0	%	100.0	B	B	B	B
d2-02	Frequency reference lower limit	x	0.0 to 109.0	%	0.0	B	B	B	B

- The frequency reference upper and lower limits are set as a percentage of the maximum output frequency (E1-04), in increments of 1%.
- The upper and lower limits of the frequency reference are shown in *Figure 7.27*.

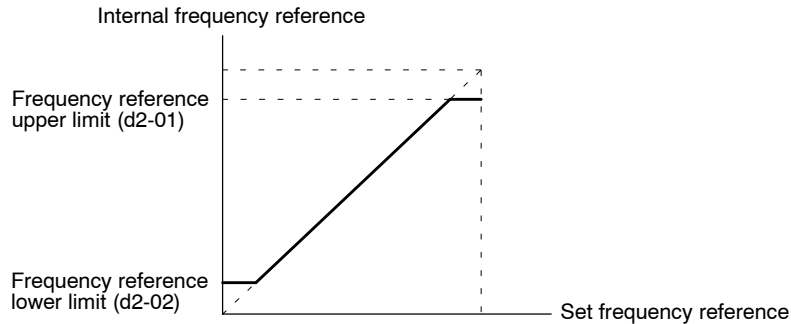

Fig 7.27 Upper and Lower Limits of the Frequency Reference

■ Prohibited Frequencies (Jump Frequencies): d3-01 to d3-04

- This function allows the prohibition or “jumping” of certain frequencies within the Inverter’s output frequency range so that the motor can operate without resonant oscillations caused by some machine systems.
- It is also used for deadband control.

User Constant Number	Name	Change during Operation	Setting Range	Unit	Factory Setting	Valid Access Levels			
						V/f Control	V/f with PG	Open Loop Vector	Flux Vector
d3-01	Jump frequency 1	x	0.0 to 150.0	Hz	0.0	B	B	B	B
d3-02	Jump frequency 2	x	0.0 to 150.0	Hz	0.0	B	B	B	B
d3-03	Jump frequency 3	x	0.0 to 150.0	Hz	0.0	B	B	B	B
d3-04	Jump frequency width	x	0.0 to 20.0	Hz	1.0	B	B	B	B

- To disable this function, set the jump frequency references (d3-01 to d3-03) to 0.0 Hz.
- For d3-01 to d3-03, set the center values of the frequencies to be jumped. Be sure to set the jump frequency so that $d3-03 \leq d3-02 \leq d3-01$.
- For d3-04, set the jump frequency bandwidth. The jump frequency \pm the jump frequency bandwidth becomes the jump frequency range.
- Operation is prohibited within the jump frequency range, but changes during acceleration and deceleration are smooth with no jumps.
- The relation between the internal frequency reference and the set frequency references is shown in *Figure 7.28*.

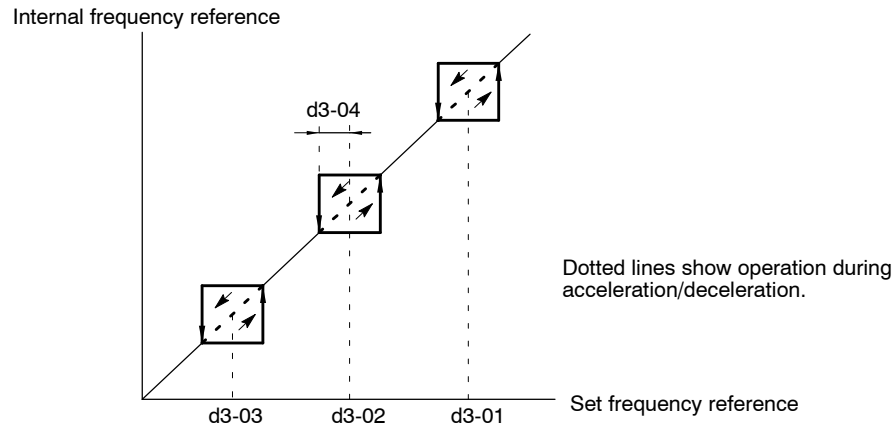

Fig 7.28 Setting Prohibited Frequencies

■ Hold Reference Memory Selection: d4-01

- Constant d4-01 is enabled by making either of the following settings for the multi-function inputs (H1-01 to H1-06).
 - Acceleration/deceleration ramp hold (setting: A)
 - Up command (setting: 10)/down command (setting: 11)
- When hold status is established by these external signals, specify whether or not the output frequency is to be retained.
- When this function is enabled, operation is re-started after power-up using the frequency reference value that was retained.

User Constant Number	Name	Change during Operation	Setting Range	Unit	Factory Setting	Valid Access Levels			
						V/f Control	V/f with PG	Open Loop Vector	Flux Vector
d4-01	Frequency reference hold function selection	x	0, 1	-	0	A	A	A	A

- Settings

Setting	Description
0	Disabled. Restart after operation stoppage or power-up begins at zero.
1	Enabled. Restart after operation stoppage or power-up begins at the held frequency reference.

- For information regarding the acceleration/deceleration stop (hold) command and the up/down command, refer to the description of *Multi-function Inputs (H1)*.

■ Trim Control Level: d4-02

- The trim control level is valid when the trim control increase command (setting: 1C) or trim control decrease command (setting: 1D) is set for a multi-function input (H1-01 to H1-06).
- If the trim control increase command is ON when a frequency reference is input on the analog input, the trim control level will be added to the analog frequency reference and then output as the output frequency. If the trim control decrease command is ON, the frequency reference will be decreased by the trim control level.

User Constant Number	Name	Change during Operation	Setting Range	Unit	Factory Setting	Valid Access Levels			
						V/f Control	V/f with PG	Open Loop Vector	Flux Vector
d4-02	+ - Speed limits	x	0 to 100	%	25	A	A	A	A

- Set the trim control level as a percentage of the maximum output frequency.
- If the frequency reference minus the trim control level is less than zero, the output frequency will be zero.
- Refer to the description of *Multi-function Inputs (H1)* for details on the trim control increase and trim control decrease commands.

7.5.4 Option Constants: F

■ Installing Option Cards

A maximum of three Option Cards can be installed in the Inverter. The installation location of each is determined by the type of Card. Be sure to install the Cards in their correct locations. Constants of the Option Cards can be referred or set with the access level Basic.

Table 7.7 Option Card Specifications

Type of card	Model	Specifications	Location
Analog Reference Card	AI-14U	14-bit analog, 2 inputs (voltage/current)	C
	AI-14B	14-bits analog, 3 inputs	C
Digital Reference Card	DI-08	8-bit digital input (BCD/binary)	C
	DI-16H2	16-bit digital input (BCD/binary)	C
PG Speed Control Card	PG-A2	Open-collector/complementary, single input	A
	PG-B2	Complementary, A/B-phase input	A
	PG-D2	Line-driver, single input	A
	PG-X2	Line-driver, A/B-phase input	A
Analog Monitor Card	AO-08	8-bit analog output, 2 channels	D
	AO-12	12-bit analog output, 2 channels	D
Pulse Monitor Card	PO-36F	Pulse frequency output	D

Installation Procedure

Use the following procedure to install a PG Speed Control Card.

1. Turn OFF the main-circuit power supply of the Inverter Panel.
2. Leave it OFF for at least five minutes before opening the front panel of the Inverter Panel. Check to be sure that the CHARGE lamp is OFF.

3. After aligning to the Option-A connector on the control PCB located on the back of the front door of the Inverter Panel, pass the spacer through the spacer hole at the Card. (Refer to A in the illustration.) Check to be sure that it is precisely aligned with the 4CN position, and snap it into the proper position. Be sure to press it in firmly until you hear it snap into place.

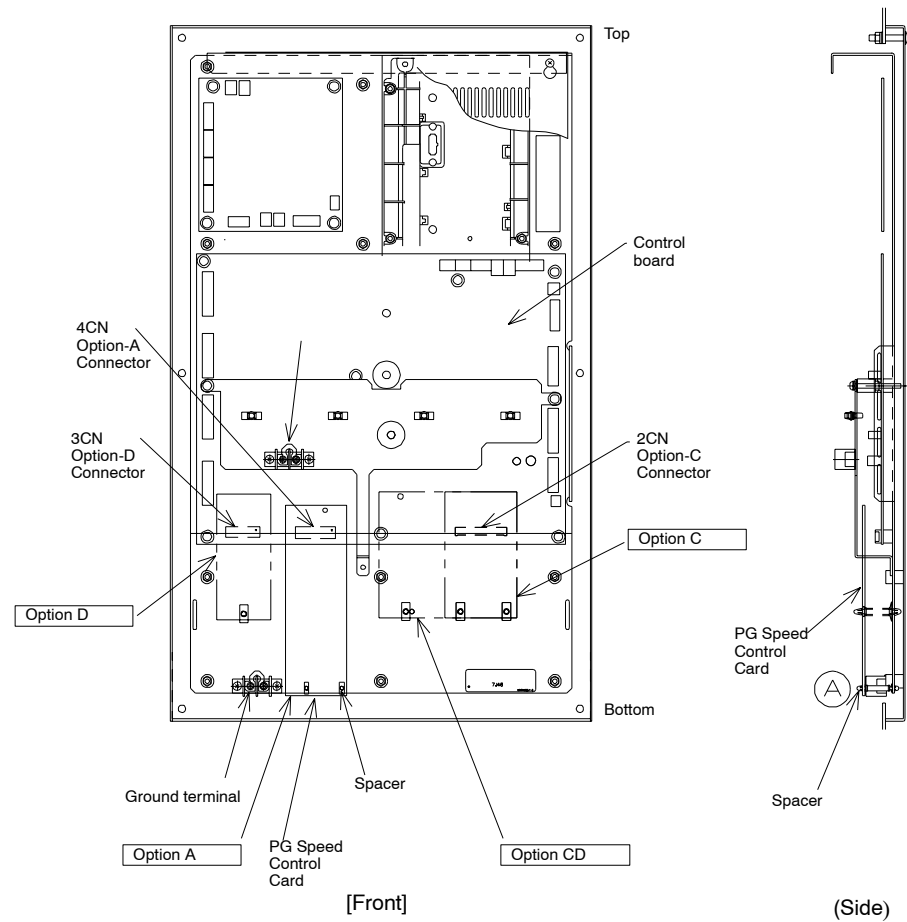

Fig 7.29 Installing a PG Speed Control Card

■ **Analog Reference Card: F2-01**

- When using a AI-14B/A1-14U Analog Reference Card, set constant b1-01 (reference selection) to “3” (option).
- When using a AI-14B, set the function for channels 1 to 3 with constant F2-01. (There are no constants to set for AI-14U.)

User Constant Number	Name	Change during Operation	Setting Range	Unit	Factory Setting	Valid Access Levels			
						V/f Control	V/f with PG	Open Loop Vector	Flux Vector
F2-01	Bi-polar or uni-polar input selection	x	0, 1	-	0	B	B	B	B

- Settings

Setting	Description
0	3-channel individual input (CH1: terminal 36; CH2: terminal 39; CH3: terminal 42) (b1-01 = 1)
1	3-channel additional input (Sum of CH1 to CH3 is used as the frequency reference value.) (b1-01 = 3)

- Constant b1-01 (reference selection) must be set to “1” (external terminal), when 3-channel individual input (setting: 0) is set.
- When using a AI-14B and setting 3-channel individual input, the multi-function inputs cannot be set to the Option/Inverter selection function (setting: 2).

■ **Digital Reference Card: F3-01**

- When using a DI-08 or DI-16H2 Digital Reference Card, set constant b1-01 (reference selection) to “3” (option) and set the input method with constant F3-01.

User Constant Number	Name	Change during Operation	Setting Range	Unit	Factory Setting	Valid Access Levels			
						V/f Control	V/f with PG	Open Loop Vector	Flux Vector
F3-01	Digital input option	x	0 to 7	-	0	B	B	B	B

- Settings

Setting	Description
0	BCD 1% unit
1	BCD 0.1% unit
2	BCD 0.01% unit
3	BCD 1 Hz unit
4	BCD 0.1 Hz unit
5	BCD 0.01 Hz unit
6	BCD special setting (5-digit input) (Only when DI-16H2 is used.)
7	Binary input (Setting is displayed in decimal notation.)

- The maximum frequency (100% speed) reference will be used when the binary input is set (setting: 7) and all bits are “1.”
 - DI-08: Maximum output frequency reference (255/100%).
 - DI-16H2: Maximum output frequency reference (16 bits: 30000/100%, 12 bits: 4095/100%).
- Setting 6, BCD special setting (5-digit input), is valid only when the DI-16H2 is used. Using this setting, a frequency from 0.00 to 399.98 Hz can be set in BCD. The data input method is different from that for settings of 1 to 5.

Setting: 1 to 5	Sign	8×10^3	4×10^3	2×10^3	1×10^3	...	8×10^0	4×10^0	2×10^0	1×10^0	
Setting: 6		2×10^4	1×10^4	8×10^3	4×10^3	2×10^3	...	1×10^1	8×10^0	4×10^0	2×10^0

- The sign bit is used as a data bit, so only positive (plus) data can be set.
- The second digit below the decimal point is set by bits 8×10^0 , 4×10^0 , and 2×10^0 , so the settings are made in units of 0.02 Hz. (If these three bits are “111,” “110,” and “101,” they will be recognized as “9.”)

■ Analog Monitor Card: F4-01 to F4-04

- When using an AO-08 or AO-12 Analog Monitor Card, set the monitor items and gain with the following constants.

User Constant Number	Name	Change during Operation	Setting Range	Unit	Factory Setting	Valid Access Levels			
						V/f Control	V/f with PG	Open Loop Vector	Flux Vector
F4-01	Channel 1 monitor selection	X	1 to 35	-	2	B	B	B	B
F4-02	Channel 1 gain	○	0.00 to 2.50	Multiple	1.00	B	B	B	B
F4-03	Channel 2 monitor selection	X	1 to 35	-	3	B	B	B	B
F4-04	Channel 2 gain	○	0.00 to 2.50	Multiple	0.50	B	B	B	B

- For the output monitor selections (F4-01, F4-03), set the numbers for the right side of the “U1” constants in the *Table 4.3*. The setting range is 1 to 35, but the following numbers cannot be set: 4, 10, 11, 12, 13, 14, 25, and 28 to 35.
- When the AO-12 is used, outputs of 0 to ± 10 V are possible. For that, set constant H4-07 (multi-function analog output signal level selection) to “1” (0 to ± 10 V outputs). There are some monitor items. However, that can only use outputs of 0 to +10 V even if constant H4-07 is set to “1.”
- When the AO-08 is used, only outputs of 0 to +10 V are possible regardless of the constant H4-07 setting.

■ DO-02 Digital Output Card Settings: F5-01, F5-02

- Set the output selections in the following constants when using a DO-02 Digital Output Card.

User Constant Number	Name	Change during Operation	Setting Range	Unit	Factory Setting	Valid Access Levels			
						V/f Control	V/f with PG	Open Loop Vector	Flux Vector
F5-01	Channel 1 output selection	X	00 to 37	-	0	B	B	B	B
F5-02	Channel 2 output selection	X	00 to 37	-	1	B	B	B	B

- Set the values from *Table 7.10*.

■ **DO-08 Digital Output Card Settings: F6-01**

- Set the output mode in the following constants when using a DO-08 Digital Output Card.

User Constant Number	Name	Change during Operation	Setting Range	Unit	Factory Setting	Valid Access Levels			
						V/f Control	V/f with PG	Open Loop Vector	Flux Vector
F6-01	Output mode selection	x	0, 1	-	0	B	B	B	B

- The items output from the DO-08 will be as follows according to the setting of F6-01.

Setting	Terminal	Output
0: 8 channels of individual outputs	TD5-TD11	Overcurrent (SC, OC, GF)
	TD6-TD11	Overvoltage (OV)
	TD7-TD11	Inverter overload (OL2)
	TD8-TD11	Fuse blown (PUF)
	TD9-TD11	Overspeed (OS)
	TD10-TD11	Inverter overheat (OH1) or motor overload (OL1)
	TD1-TD2	Zero speed detection
	TD3-TD4	Speed agree
1: Binary code output	TD5-TD11	Bit 0
	TD6-TD11	Bit 1
	TD7-TD11	Bit 2
	TD8-TD11	Bit 3
	TD9-TD11	Zero speed detection
	TD10-TD11	Speed agree
	TD1-TD2	Running
	TD3-TD4	Minor fault

Coded Outputs

Bit 3210	Meaning	Bit 3210	Meaning
0000	No fault	1000	External fault (EF x x)
0001	Overcurrent (SC, OC, GF)	1001	Controller fault (CPFx x)
0010	Overvoltage (OV)	1010	Motor overload (OL1)
0011	Inverter overload (OL2)	1011	Not used
0100	Inverter overheat (OH, OH1)	1100	Power loss (UV1, UV2, UV3)
0101	Overspeed (OS)	1101	Excessive speed deviation (DEV)
0110	Fuse blown(PUF)	1110	PG disconnected (PGO)
0111	Braking Resistor Unit overheat (RH) Braking Transistor fault (RR)	1111	Not used.

■ Pulse Monitor Card: F7-01

- When using a PO-36F Pulse Monitor Card, set the output pulse in constant F7-01.

User Constant Number	Name	Change during Operation	Setting Range	Unit	Factory Setting	Valid Access Levels			
						V/f Control	V/f with PG	Open Loop Vector	Flux Vector
F7-01	Frequency multiple selection	x	0 to 4	-	1	B	B	B	B

- Settings

Setting	Description	
0	1F	1 x Inverter output frequency
1	6F	6 x Inverter output frequency
2	10F	10 x Inverter output frequency
3	12F	12 x Inverter output frequency
4	36F	36 x Inverter output frequency

- “F” indicates the output frequency (Hz). For example, if “0” (1F) is set, when the output frequency is 60 Hz there will be an output of 60 pulses per second. (Duty 50%)

7.5.5 External Terminal Functions: H

This section describes the settings for the external terminal functions.

■ Multi-function Input Settings: H1

The settings and functions for the multi-function inputs are listed in *Table 7.8*.

Table 7.8 Multi-function Input Functions

Setting value	Function	Control Method			
		V/f	V/f w/ PG	Open loop Vector	Flux vector
0	3-wire sequence (Forward/Reverse run command)	○	○	○	○
1	Local/Remote selection (ON: Operator, OFF: Constant setting)	○	○	○	○
2	Option/Inverter selection (ON: Option card)	○	○	○	○
3	Multi-step speed reference 1 When H3-05 is set to "0," this function is combined with "Master/auxiliary speed switch."	○	○	○	○
4	Multi-step speed reference 2	○	○	○	○
5	Multi-step speed reference 3	○	○	○	○
6	Jog frequency reference (higher priority than multi-step speed reference)	○	○	○	○
7	Accel/Decel time 1	○	○	○	○
8	External baseblock NO (NO contact: Baseblock at ON)	○	○	○	○
9	External baseblock NC (NC contact: Baseblock at OFF)	○	○	○	○
A	Accel/Decel ramp hold (ON: Accel/decel stopped, frequency on hold)	○	○	○	○
B	OH2 alarm signal input (ON: OH2 will be displayed)	○	○	○	○
C	Multi-function analog input selection (ON: Enable)	○	○	○	○
D	No V/f control with PG (ON: Speed feedback control disabled,) (normal V/f control)	x	○	x	x
E	Speed control integral reset (ON: Integral control disabled)	x	○	x	○
F	Not used. (Do not input this setting.)	-	-	-	-
10	Up command (Always set with the down command)	○	○	○	○
11	Down command (Always set with the up command)	○	○	○	○
12	FJOG command (ON: Forward run at jog frequency d1-09)	○	○	○	○
13	RJOG command (ON: Reverse run at jog frequency d1-09)	○	○	○	○
14	Fault reset (Reset when turned ON)	○	○	○	○
15	Emergency stop (ON: Deceleration to stop in emergency stop time C1-09)	○	○	○	○
16	Motor switch command (Motor 2 selection)	○	-	○	-
18	Timer function input (Functions are set with b4-01, b4-02 and the timer function is set at the same time)	○	○	○	○
19	PID control disable (ON: PID control disabled)	○	○	○	○
1A	Accel/Decel time 2	○	○	○	○
1B	Constants write enable (ON: All constants can be written-in. OFF: All constants other than frequency monitor are write protected.)	○	○	○	○
1C	Trim control increase (ON: d4-02 frequencies are added to analog frequency references.)	○	○	○	○
1D	Trim control decrease (ON: d4-02 frequencies are subtracted from analog frequency references.)	○	○	○	○
1E	Analog frequency reference sample/hold	○	○	○	○
1F	Frequency reference terminal 36/39 selection (ON: selects terminal 39)	○	○	○	○
20 ~ 2F	External fault (Desired settings possible) Input mode: NO contact/NC contact, Detection mode: Normal/during operation Stopping method: Deceleration to stop, coast to stop, emergency stop or continue operation.	○	○	○	○

Setting value	Function	Control Method			
		V/f	V/f w/ PG	Open loop Vector	Flux vector
30	PID control integral reset (ON: Reset)	○	○	○	○
60	DC injection braking command (ON: Performs DC injection braking)	○	○	○	○
61	External speed search command 1: Maximum output frequency (ON: speed search)	○	×	○	×
62	External speed search command 2: Set frequency (ON: speed search)	○	×	×	×
63	Energy-saving command (ON: Energy-saving control set for b8-01, b8-02)	○	○	×	×
64	External speed search command 3	○	○	○	○
65	KEB (deceleration at momentary power loss) command (NO contact)	○	○	○	○
66	KEB (deceleration at momentary power loss) command (NO contact)	○	○	○	○
71	Speed/torque control change (ON: Torque control)	×	×	×	○
72	Zero-servo command (ON: Zero-servo)	×	×	×	○
77	Speed control (ASR) proportional gain switch (ON: C5-03)	×	×	×	○

Constant Settings

User Constant Number	Name	Change during Operation	Setting Range	Unit	Factory Setting	Valid Access Levels			
						V/f Control	V/f with PG	Open Loop Vector	Flux Vector
H1-01	Multi-function input 1 (terminal 11)	×	0 to 77	-	24	B	B	B	B
H1-02	Multi-function input 2 (terminal 12)	×	0 to 77	-	14	B	B	B	B
H1-03	Multi-function input 3 (terminal 13)	×	0 to 77	-	3 (0)	B	B	B	B
H1-04	Multi-function input 4 (terminal 14)	×	0 to 77	-	4 (3)	B	B	B	B
H1-05	Multi-function input 5 (terminal 15)	×	0 to 77	-	6 (4)	B	B	B	B
H1-06	Multi-function input 5 (terminal 16)	×	0 to 77	-	8 (6)	B	B	B	B

- The factory settings in parentheses are for when the Unit is initialized for 3-wire control.
- The following table shows the settings and section references for some common functions.

Function	Setting	Section
3-wire sequence (forward/reverse run command)	0	6.1.8
Multi-step speed references 1 to 3 and jog frequency reference	3 to 6	6.1.8
Accel/Decel time 1 and 2	7, 1A	6.1.8
Emergency stop	15	6.1.8
FJOG/RJOG commands	12, 13	6.1.8
Terminal 36/39 switch	1F	6.1.8
Timer function input	18	7.5.1
Energy-saving command	63	7.2.1, 7.4.1

Local/Remote Selection (Setting: 1)

OFF	Operate with the frequency reference and run command specified in b1-01 (the frequency reference source) and b1-02 (run source).
ON	Operate with the frequency reference and run command set at the Digital Operator.

- With this setting, the multi-function input selects the input method for the frequency reference and run command.
- The input method can be switched only when the Inverter is stopped.
- The Digital Operator LOCAL/REMOTE Key is disabled when this function has been set in a multi-function input.

Option Card/Inverter Selection (Setting: 2)

OFF	The Inverter frequency reference is enabled.
ON	The Option Card frequency reference is enabled.

- With this setting, the multi-function input enables the frequency reference input from the Inverter itself or the one from Option Card. The frequency reference input can be switched only when the Inverter is stopped.
- Be sure that b1-01 (the frequency reference source selector) has been set to 0 (Operator) or 1 (external terminal). Only the frequency reference from the Option Card will be enabled if b1-01 is set to 3 (Option PCB).
- Setting 2 can't be selected if the AI-14B is being used and constant F2-01 (AI-14 Input Selector) is set to 0.

External Baseblock NO (Setting: 8)

OFF	Normal operation
ON	Baseblock

External Baseblock NC (Setting: 9)

OFF	Baseblock
ON	Normal operation

- With either of these settings, the multi-function input controls baseblock operation.
- Baseblock is an interruption of the Inverter output. The motor coasts while the baseblock command is being input.
- The output frequency is retained internally, so the same frequency will be output again when the baseblock command is cleared. The output frequency will change in a step pattern when the output resumes, so take some safety precaution such as turning OFF the run command – especially if the baseblock command was input when the motor was operating at high speed. (When the run command is turned OFF, the internally retained output frequency is reset to zero.)
- After a baseblock command is cleared, the voltage will be restored in the voltage recovery time set in L2-04.

7

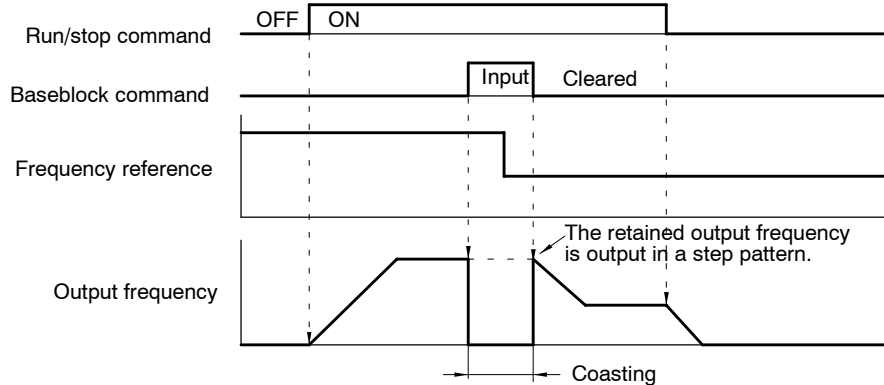

Fig 7.30 Baseblock Command

Acceleration/Deceleration Ramp Hold (Setting: A)

OFF	Normal operation or restart acceleration/deceleration.
ON	Pause acceleration/deceleration and maintain the present frequency.

- With this setting, the multi-function input pauses acceleration or deceleration and maintains (holds) the output frequency.
- Acceleration/deceleration is restarted when the acceleration/deceleration ramp hold input is turned OFF.
- The motor will be stopped if a stop command is input while the acceleration/deceleration ramp hold input is ON.
- When constant d4-01 (the frequency reference hold function selector) is set to 1, the held frequency will be stored in memory. This stored frequency will be retained even after a power loss and the motor will be restarted at this frequency when a run command is input again.

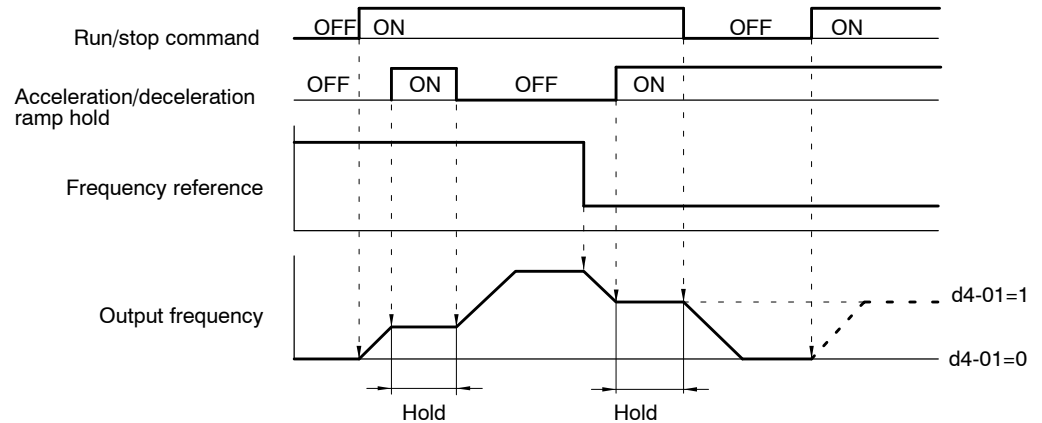

Fig 7.31 Acceleration/Deceleration Ramp Hold

- When d4-01 is set to 1, the held output frequency will be retained. To operate at this frequency even after the Inverter is stopped, input the run command with the acceleration/deceleration ramp hold input ON.
- When d4-01 is set to 0, the output frequency will be held at zero if the run command is input with the acceleration/deceleration ramp hold input ON.

OH2 Alarm Signal (Setting: B)

OFF	Normal operation
ON	Normal operation (The warning message “OH2” will be displayed on the Digital Operator.)

- The message “OH2” will be displayed on the Digital Operator while the multi-function input is ON and the display will revert to its previous status when the input is turned OFF. (It isn’t necessary to reset the alarm.) The Inverter will continue operation without detecting a fault.
- With this setting, a temperature sensor can be connected to the multi-function input to display a warning message when the temperature rises too high.

Multi-function Analog Input Selection (Setting: C)

OFF	Disables the multi-function analog input (terminal 16).
ON	Enables the multi-function analog input (terminal 16).

- With this setting, the multi-function input can be used to enable or disable the multi-function analog input.
- Turning the input OFF has the same effect as setting H3-05 (the multi-function analog input selector for terminal 42) to 1F.

No V/f Control with PG (Setting: D)

OFF	V/f control with PG feedback (enables speed control with speed feedback)
ON	Normal V/f control (disables speed feedback control.)

- With this setting, the multi-function input can be used to switch “V/f control with PG feedback” to “Normal V/f control.” It is possible to switch between these control methods during operation.

Speed Control Integral Reset (Setting: E)

OFF	Operates with PI-control speed control loop.
ON	Operates with P-control speed control loop. (The speed control integral values are reset by the integral time constant.)

- This function is valid only for V/f control with PG feedback when constant F1-07 is set to 0. (Setting F1-07 to 0 disables integral operation during acceleration/deceleration.)
- It is possible to switch between these speed control modes during operation.

Up and Down Commands (Settings: 10 and 11)

Up command	ON	OFF	ON	OFF
Down command	OFF	ON	ON	OFF
Operation	Acceleration	Deceleration	Hold	Hold

- With these settings, the multi-function inputs can be used to control the Inverter's output frequency.
- When using this function, be sure to set both the up command (setting 10) and the down command (setting 11) for 2 multi-function inputs. An OPE03 option fault will occur if only one of these commands is set or if an acceleration/deceleration ramp hold input (setting A) is set at the same time.
- Be sure to set constant b1-02 (the run command source selector) to 1 (external terminal). The up/down function won't operate with any other b1-02 setting.
- The frequency up/down commands operate according to the normal acceleration/deceleration times in C1-01 to C1-08.
- The upper and lower limits for the output frequency with the up/down commands are determined by the following settings:
 - Upper limit = Maximum output frequency (E1-04) X Reference upper limit (d2-01) / 100
 - Lower limit = Maximum output frequency (E1-04) X Reference lower limit (d2-02) / 100
- When frequency reference (voltage) terminal 36 or frequency reference (current) terminal 39 is being used as a frequency reference input, the greatest frequency value becomes the lower limit.
- When the up/down function is being used, the output frequency will be accelerated to the lower limit if a run command is input.
- When the up/down function and jog frequency reference are both assigned to multi-function inputs, an ON jog frequency reference input has the highest priority.
- Multi-step speed references 1 to 8 are all disabled when the up/down function has been set.
- The output frequency held by the up/down function will be stored in memory if d4-01 (the frequency reference hold function selector) is set to 1. This output frequency will be retained even after a power loss, and operation will be restarted at this frequency the next time that a run command is input. The stored output frequency will be cleared from memory if the up or down command is turned ON while the run command is OFF (see "Reference frequency reset" in *Figure 7.32*).

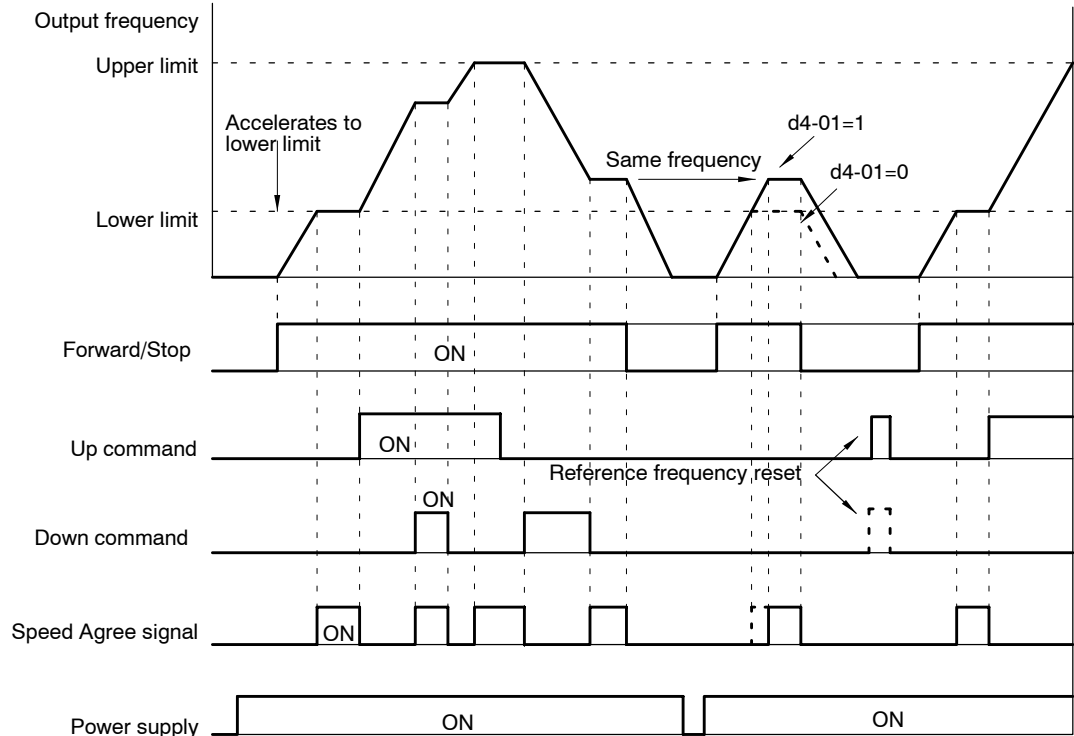

The Speed Agree signal remains ON while the run command is ON and the motor is not accelerating or decelerating.

Fig 7.32 Timing Chart for Up and Down Commands

Fault Reset (Setting: 14)

OFF	Normal operation
ON	Resets faults when input goes from OFF to ON. (Normal operation when no fault has occurred.)

- With this setting, the multi-function input resets faults that have occurred.
- When a fault has occurred, be sure to find out what kind of fault occurred, take steps to correct the cause of the fault, and restart the Inverter. It is possible to damage the Inverter by repeatedly resetting a fault without correcting the cause.
- To resume operation after a fault has occurred, turn the run command OFF, turn the fault reset input from ON to OFF, and then turn the run command ON again. A fault cannot be reset while the run command is ON.
- If a fault hasn't occurred, turning the fault reset ON and OFF will have no effect on operation.

Motor Switch Command (Motor 2 Selection, Setting: 16)

- CLOSED: Motor 2 constants used.

Operation

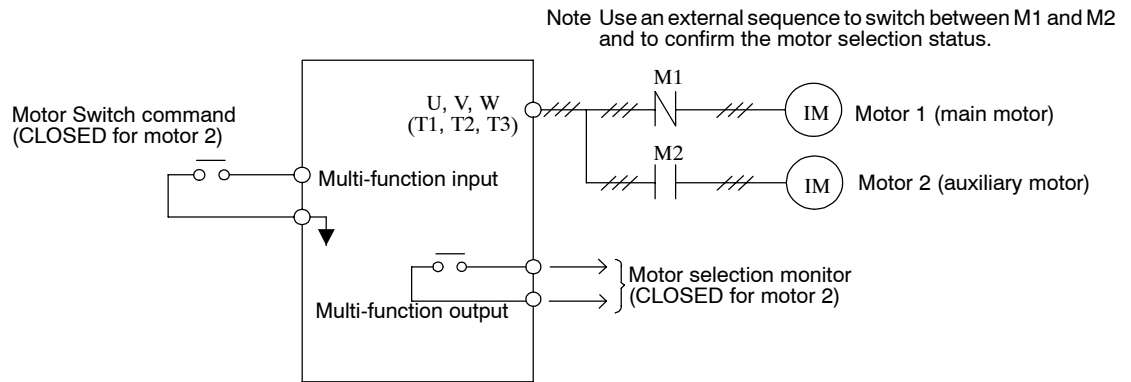

Note Use an external sequence to switch between M1 and M2 and to confirm the motor selection status.

- The control method, V/f characteristics, and motor constants recorded in the Inverter can be switched by setting “16” (motor switch command) for a constant from H1-01 to 06 (multi-function inputs), and then inputting a signal while the motor is stopped.
- The current motor selection can be monitored at a multi-function output terminal by setting “1C” (motor selection monitor) for a constant from H2-01 to 03 (multi-function outputs).
- Set the Basic (3) or Advanced (4) access level in the initialize setting A1-01 (access level).
- The constants being used will be changed as shown in the following table for the motor switch command.

Motor Switch command	OPEN (motor 1)	CLOSED (motor 2)
Control method	A1-02 (control method in initialize settings)	E3-01 (motor 2 control method)
V/f characteristics	E1-04 to 13 (V/f characteristics)	E4-01 to 07 (motor 2 V/f characteristics)
Motor constants	E2-01 to 09 (motor constants)	E5-01 to 06 (motor 2 motor constants)
Motor selection monitor	OPEN	CLOSED

- The timing chart for switching between motor 1 and motor 2 is shown below.

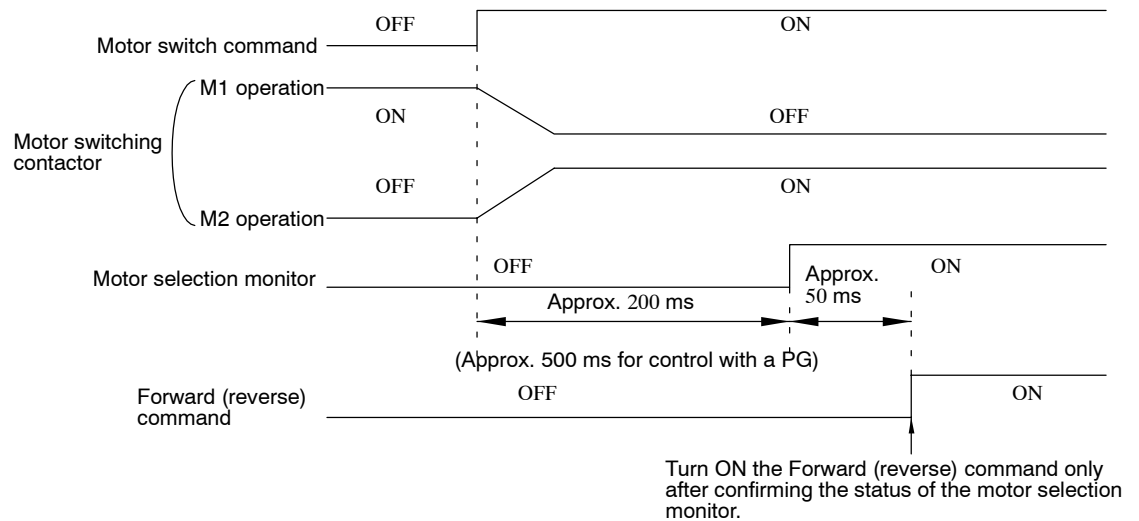

Fig 7.33 Timing Chart for Switching from Motor 1 to Motor 2

PID Control Disable (Setting: 19)

OFF	Enables PID control.
ON	Disables PID control. (Normal Inverter control)

- With this setting, the multi-function input switches between PID control and normal Inverter control. This function can be used to perform trial operation or jog operation with normal inverter control (open-loop control) and then switch to PID control (closed-loop control using feedback) after adjusting the system. The PID disable function can also be used to switch to open-loop control when there is a problem with the feedback value.

Constants Write Enable (Setting: 1B)

OFF	Write-protects all constants except for frequency monitor.
ON	Allows constants specified in Initialize mode to be changed.

- With this setting, the multi-function input can be used to write-protect the Operator constants. When the input is OFF, the Operation mode frequency can be monitored and the frequency can be changed but other changes are prohibited.

Trim Control Increase and Decrease (Settings: 1C and 1D)

Trim Control Increase	ON	OFF	ON	OFF
Trim Control Decrease	OFF	ON	ON	OFF
Output frequency	Reference frequency + trim control level (d4-02)	Reference frequency - trim control level (d4-02)	Reference frequency	Reference frequency

- The trim control increase function adds the level in d4-02 to the analog frequency reference.
- The trim control decrease function subtracts the level in d4-02 to the analog frequency reference.
- These functions are effective when the frequency reference is input from an analog input. These functions must both be set at the same time or an OPE03 fault will occur. The analog frequency reference won't be changed when both the trim control increase and decrease inputs are ON. The output frequency will be zero when the trim control decrease input is ON and the result of the subtraction is less than zero.

Analog Frequency Reference Sample/Hold (Setting: 1E)

- The analog input value will become the frequency reference 100 ms after the multi-function input closes.

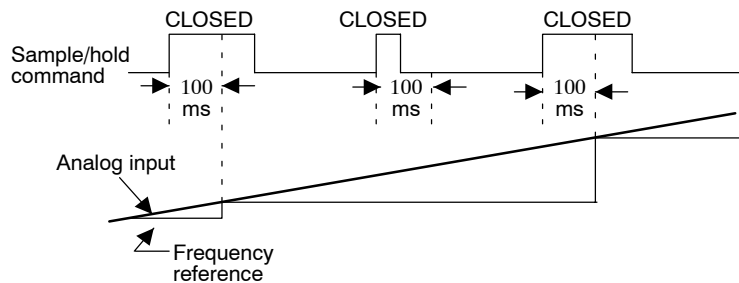

Fig 7.34 Analog Frequency Reference Sample/Hold

- The analog frequency reference sample/hold function is valid only for terminals 36, 39, and 42 or for the analog inputs from the AI-14U or AI-14B.
- An OPE03 fault will occur if two or more of the following signals turn ON at the same time: acceleration/deceleration ramp hold command (0A), up/down commands (10 or 11), trim control increase/decrease commands (1C or 1D), and the analog frequency reference sample/hold command.

External Faults (Settings: 20 to 2F)

- With this setting, the multi-function input can be used to stop the Inverter or output an alarm when a malfunction or fault occurs in a peripheral device.
- There are 16 external fault inputs available with all 16 combinations of the following variables. Select the setting with the desired combination.
 - Input level: Normally open or normally closed

- Detection method: Always or During operation only
- Operation selection: Deceleration to stop, Coast to stop, Emergency stop, or Continue operation

Table 7.9 External Fault Settings

Setting	Input level		Detection method		Operation selection			
	NO contact	NC contact	Always	During operation	Deceleration to stop (Fault)	Coast to stop (Fault)	Emergency stop (Fault)	Continue operation (Alarm)
20	<input type="radio"/>		<input type="radio"/>		<input type="radio"/>			
21		<input type="radio"/>	<input type="radio"/>		<input type="radio"/>			
22	<input type="radio"/>			<input type="radio"/>	<input type="radio"/>			
23		<input type="radio"/>		<input type="radio"/>	<input type="radio"/>			
24	<input type="radio"/>		<input type="radio"/>			<input type="radio"/>		
25		<input type="radio"/>	<input type="radio"/>			<input type="radio"/>		
26	<input type="radio"/>			<input type="radio"/>		<input type="radio"/>		
27		<input type="radio"/>		<input type="radio"/>		<input type="radio"/>		
28	<input type="radio"/>		<input type="radio"/>				<input type="radio"/>	
29		<input type="radio"/>	<input type="radio"/>				<input type="radio"/>	
2A	<input type="radio"/>			<input type="radio"/>			<input type="radio"/>	
2B		<input type="radio"/>		<input type="radio"/>			<input type="radio"/>	
2C	<input type="radio"/>		<input type="radio"/>					<input type="radio"/>
2D		<input type="radio"/>	<input type="radio"/>					<input type="radio"/>
2E	<input type="radio"/>			<input type="radio"/>				<input type="radio"/>
2F		<input type="radio"/>		<input type="radio"/>				<input type="radio"/>

- For the input level, select whether you want a fault to be detected when the input signal is ON (normally open input) or OFF (normally closed input).
- For the detection method, select whether you want faults to be detected any time that the Inverter is ON or only during operation.
- For the operation selection, select the processing method that you want to be performed when a fault has been detected.
 - Deceleration to stop: A fault is output and the output stopped in the selected deceleration time.
 - Coast to stop: A fault is output and the Inverter output is cut off.
 - Emergency stop: A fault is output and the output stopped in the emergency stop time (C1-09).
 - Continue operation: An alarm is output and operation continues.
- When an alarm is going to be output externally, be sure to set one of the multi-function outputs (H2-01, 02, and 03) to alarm (setting 10).
- An external fault setting cannot be set in more than one multi-function input.
- Unlike other constant settings, the external fault settings have an input procedure, as shown in the following diagrams.

Setting Procedure

1. When setting an external fault function, press the Enter Key when “External Fault” is displayed to bring up the “Input Level” display.

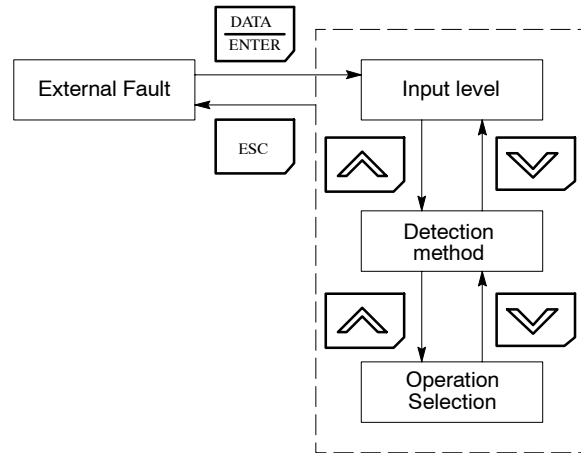

Fig 7.35 Setting Procedure for External Fault Function

2. Press the Increment Key to switch displays as follows:
“Detection Method” → “Operation Selection” → “Input Method”
3. Press the Enter Key at the desired constant to select that constant.

At this point, the Increment and Decrement Keys can be pressed to scroll to the available settings for the selected constant. Press the Enter Key to select the displayed constant setting.
(Press the Escape Key to cancel the operation without changing the constant setting.)

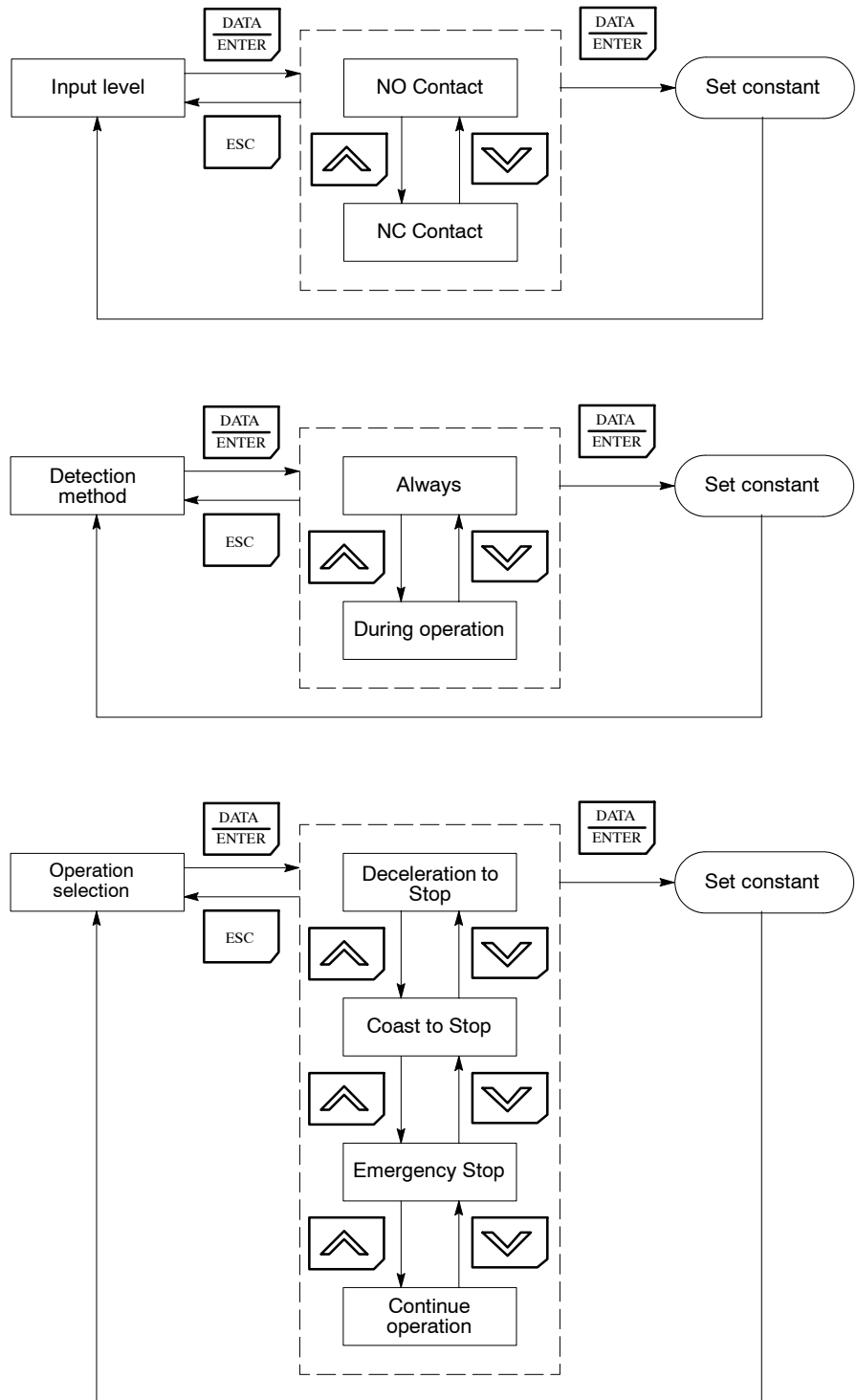

Fig 7.36 Procedure to Change Constant Settings

DC Injection Braking Command (Setting: 60)

OFF	Normal operation
ON	Applies DC injection braking if the Inverter is stopped. (Applies initial excitation when flux vector control is being used.)

- DC injection braking is used to prevent the motor from rotating due to inertia or external forces when the Inverter is stopped.
- DC injection braking is performed if the DC injection braking input is ON while the Inverter is stopped.
- If a run command or jog command (jog, forward jog, or reverse jog) is input, the DC injection braking will be cleared and motor operation will be started.

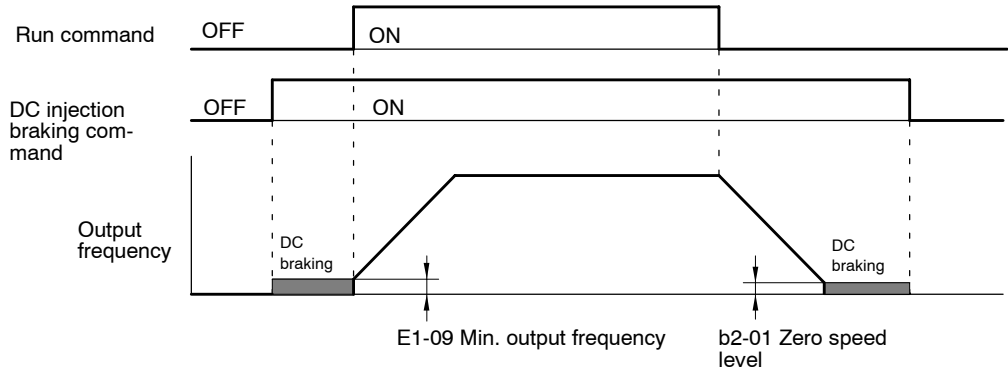

Fig 7.37 Timing Chart for DC Injection Braking Command

External Speed Search 1 (Settings: 61)

OFF	Normal operation
ON	Starts a speed search from the maximum output frequency.

External Speed Search 2 (Settings: 62)

OFF	Normal operation
ON	Starts a speed search from the set frequency (from the current reference frequency when the external search command turn ON).

- Either one of the external search functions can be set, but not both.
- The speed search function can be used to operate the motor without tripping when switching operation from a commercial power supply and the Inverter or starting a coasting motor.
- The speed search will begin after the minimum baseblock time (L2-03) has elapsed when the run command is input after the external search command has been turned ON.

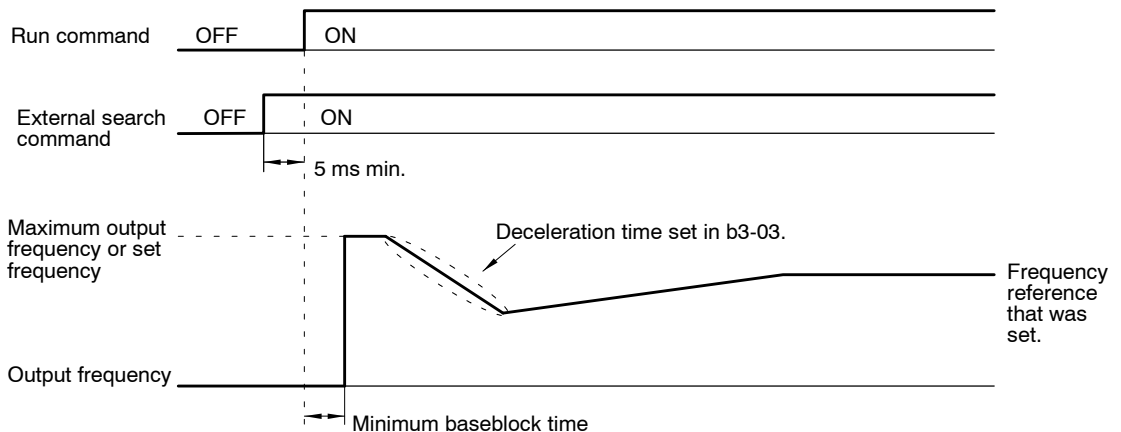

Fig 7.38 Timing Chart for the External Search Command

Speed/Torque Control Change (Setting: 71)

OFF	Speed control
ON	Torque control

- With this setting, the multi-function input can be used to switch between speed and torque control. Refer to 7.3.4 *Speed/Torque Control Switching Function* for more details.

Zero-servo Command (Setting: 72)

OFF	Normal operation
ON	Zero-servo when the frequency (speed) reference falls below the zero-speed level in b2-01.

- With this setting, the multi-function input controls the zero-servo function (b9-01 and b9-02).
- When the zero-servo command is ON, a position control loop is formed and the motor is completely stopped when the frequency (speed) reference falls below the excitation level set in b2-01. Refer to 7.3.2 *Zero-servo Function* for more details.

Speed Control (ASR) Proportional Gain Switch (Setting: 77)

OFF	The gain is set according to the values in C5-01, C5-03, and C5-07.
ON	The gain is set to the value in C5-03 (ASR proportional gain 2).

- With this setting, the multi-function input switches the proportional gain used in speed control (ASR). The integral time is not changed.
- Refer to 6.4.4 *Speed Control (ASR) Structure* for more details on constants C5-01, C5-03, and C5-07.

■ Multi-function Output Settings: H2

The settings and functions for the multi-function outputs are listed in *Table 7.10*.

Table 7.10 Multi-function Output Functions

Setting value	Function	Control Methods			
		V/f	V/f w/ PG	Open loop Vector	Flux vector
0	During run □ON: run command is ON or voltage is being output)	○	○	○	○
1	Zero-speed	○	○	○	○
2	Frequency agree 1: (Detection width L4-02)	○	○	○	○
3	Desired frequency agree 1 (ON: Output frequency = ±L4-01, detection width in L4-02)	○	○	○	○
4	Frequency (Four) detection 1 (ON: +L4-01 ≥ output frequency ≥ -L4-01, detection width in L4-02)	○	○	○	○
5	Frequency (Four) detection 2 (ON: Output frequency ≥ +L4-01 or output frequency ≤ -L4-01, detection width in L4-02)	○	○	○	○
6	Inverter operation ready READY: After initialization, no faults	○	○	○	○
7	During DC bus undervoltage (UV) detection	○	○	○	○
8	During baseblock (ON: during baseblock)	○	○	○	○
9	Frequency reference selection (ON: Frequency reference from Operator)	○	○	○	○
A	Run command selection (ON: Run command from Operator)	○	○	○	○
B	Overtorque detection 1 NO (NO contact: Overtorque detection at ON)	○	○	○	○
C	Loss of frequency reference (Effective when operation selection is “1” for L4-05 frequency reference missing)	○	○	○	○
D	Braking resistor fault (ON: Resistor overheat or braking transistor fault)	○	○	○	○
E	Fault (ON: Faults other than CPF00, CPF01 have occurred.)	○	○	○	○
F	Not used. (Do not set.)	-	-	-	-
10	Minor fault (ON: Alarm displayed)	○	○	○	○
11	Fault reset command active	○	○	○	○
12	Timer function output	○	○	○	○
13	Frequency agree 2 (Detection width: L4-04)	○	○	○	○
14	Desired frequency agree 2 (ON: Output frequency = L4-03, detection width in L4-04)	○	○	○	○
15	Frequency detection 3 (ON: Output frequency ≤ -L4-03, detection width in L4-04)	○	○	○	○
16	Frequency detection 4 (ON: Output frequency ≥ -L4-03, detection width in L4-04)	○	○	○	○
17	Overtorque detection 1 NC (NC Contact: Ttorque detection at OFF)	○	○	○	○
18	Overtorque detection 2 NO (NO Contact: Torque detection at ON)	○	○	○	○
19	Overtorque detection 2 NC (NC Contact: Torque detection at OFF)	○	○	○	○
1A	During reverse run (ON: During reverse run)	○	○	○	○
1B	During baseblock 2 (OFF: During baseblock)	○	○	○	○
1C	Motor selection (Motor under selection)	-	-	-	-
1D	Regenerating (ON: Regenerating)				○
1E	Restart enabled (ON: Restart enabled)	○	○	○	○
1F	Motor overload (OL1) pre-alarm (ON: 90% or more of the detection level)	○	○	○	○
20	Inverter overheat (OH) pre-alarm (ON: Temperature exceeds L8-02 setting)	○	○	○	○
30	During torque limit (current limit) (ON: During torque limit)	x	x	○	○
31	During speed limit. (ON: During speed limit)	x	x	x	○
33	Zero-servo end (ON: Zero-servo function completed)	x	x	x	○
37	During run 2 (ON: Frequency output, OFF: Base block, DC injection braking, initial excitation, operation stop.	○	○	○	○

7

Constant Settings

User Constant Number	Name	Change during Operation	Setting Range	Unit	Factory Setting	Valid Access Levels			
						V/f Control	V/f with PG	Open Loop Vector	Flux Vector
H2-01	Multi-function input (terminal 53-57)	x	0 to 37	-	0	B	B	B	B
H2-02	Multi-function input (terminal 19)	x	0 to 37	-	1	B	B	B	B
H2-03	Multi-function input (terminal 20)	x	0 to 37	-	2	B	B	B	B

- The following table shows the settings and section references for functions that are described in more detail in this chapter.

Function	Setting	Section
Frequency Agree 1	2	<i>Frequency Detection Settings: L4-01 to L4-05 in 7.5.6</i>
Desired Frequency Agree 1	3	
Frequency Detection 1	4	
Frequency Detection 2	5	
Overtorque Detection 1 (NO)	B	<i>Overtorque Detection Settings: L6-01 to L6-06 in 7.5.6</i>
Loss of Frequency Reference	C	<i>Timer Functions: b4-01, b4-02 in 7.5.1</i>
Timer Function Output	12	
Frequency Agree 2	13	<i>Frequency Detection Settings: L4-01 to L4-05 in 7.5.6</i>
Desired Frequency Agree 2	14	
Frequency Detection 3	15	
Frequency Detection 4	16	
Overtorque Detection 1 (NC)	17	<i>Overtorque Detection Settings: L6-01 to L6-06 in 7.5.6</i>
Overtorque Detection 2 (NO)	18	
Overtorque Detection 2 (NC)	19	

- Refer to *Table 7.10 Multi-function Output Functions* for information on the following functions.

Function	Setting
Inverter Operation Ready	6
DC Bus Undervoltage	7
During Baseblock	8
Frequency Reference Selection	9
Run Command Selection	A
Braking Resistor Fault	D
Fault	E
Minor Fault	10
Fault Reset Command Active	11
During Reverse Run	1A
During Baseblock 2	1B
Regenerating	1D
Restart Enabled	1E
During Torque Limit (Current Limit)	30
During Speed Limit	31

During Run (Setting: 0)

OFF	The run command is OFF and there is not output voltage.
ON	The run command is ON or a voltage is being output.

During Run 2 (Setting: 37)

OFF	The Inverter is not outputting a frequency. (Baseblock, DC injection braking, initial excitation, or stopped)
ON	The Inverter is outputting a frequency.

- These outputs can be used to indicate the Inverter’s operating status.

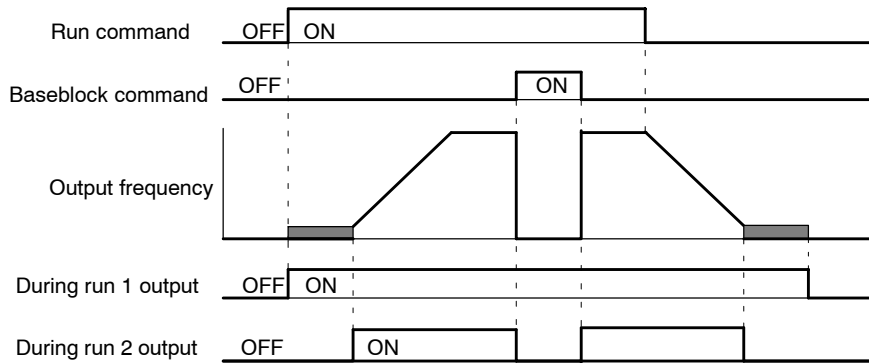

Fig 7.39 Timing Chart for “During RUN” Output

Zero-speed (Setting: 1)

OFF	The output frequency is greater than the minimum output frequency (E1-09). (With flux vector control, motor speed is greater than the zero speed level (b2-01).)
ON	The output frequency is less than the minimum output frequency (E1-09). (With flux vector control, motor speed is less than the zero speed level (b2-01).)

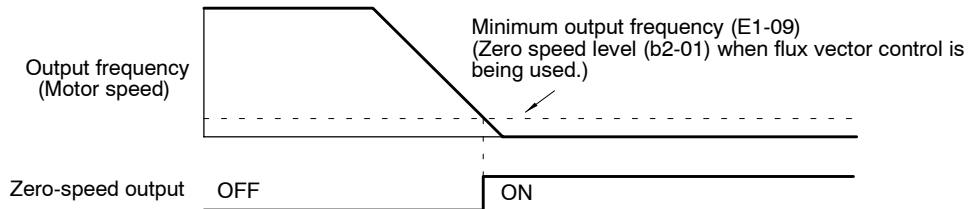

Fig 7.40 Timing Chart for Zero-speed

Motor Overload (OL1) Pre-alarm (Setting: 1F)

OFF	The motor protection function’s electronic thermal value is less than 90% of the detection level.
ON	The motor protection function’s electronic thermal value is greater than 90% of the detection level.

- This output function is valid when the motor overload protection function is enabled (L1-01 =1).
- This output can be used to warn of overheating before the protection function itself operates.

Inverter Overheat (OH) Pre-alarm (Setting: 20)

OFF	The cooling fin temperature is less than the “OH Pre-Alarm Level” set in L8-02.
ON	The cooling fin temperature exceeds the “OH Pre-Alarm Level” set in L8-02.

- This output function indicates that the temperature of the cooling fins reaches the temperature set in L8-02 (the Inverter overheating alarm detection level).

Zero-servo End (Setting: 33)

OFF	The zero-servo command isn't being input or zero-servo position control hasn't been completed.
ON	The position has been brought within the zero servo completion width (b9-02) after the zero-servo command was input.

- This output function indicates that zero-servo position control has been completed.
- The output is turned ON after the zero-servo command is input and the difference between the zero-servo operation starting position and the current position is within the zero servo completion width (b9-02).

■ Multi-function Analog Input/Frequency Reference (Current): H3-05, H3-09

Constant Settings

User Constant Number	Name	Change during Operation	Setting Range	Unit	Factory Setting	Valid Access Levels			
						V/f Control	V/f with PG	Open Loop Vector	Flux Vector
H3-05	Multi-function analog input (terminal 42)	X	0 to 1F	-	0	B	B	B	B
H3-09	Multi-function analog input (terminal 39)	X	0 to 1F	-	1F	A	A	A	A

Table 7.11 Multi-function Input/Frequency Reference (Voltage) Function

Setting	Function	Equivalent of 100% Input (10 V or 20 mA)	Control Method			
			V/f	V/f w/ PG	Open-loop Vector	Flux Vector
0	Auxiliary frequency reference (H3-05)	Maximum output frequency	○	○	○	○
1	Frequency gain	Frequency reference (voltage) command value	○	○	○	○
2	Frequency bias	Maximum output frequency (added to H3-03)	○	○	○	○
4	Voltage bias	Motor rated voltage (E1-05)	○	○	X	X
5	Accel/Decel change (reduction coefficient)	Accel/Decel times (C1-01 to C1-08)	○	○	○	○
6	DC injection braking current	Inverter rated output current	○	○	○	X
7	Overtorque detection level	Motor rated torque	○	○	○	○
8	Stall prevention level during run	Inverter rated output current	○	○	X	X
9	Frequency reference lower limit level	Maximum output frequency	○	○	○	○
A	Jump frequency	Maximum output frequency	○	○	○	○
B	PID feedback	Maximum output frequency	○	○	○	○
10	Forward side torque limit	Motor rated torque	X	X	○	○
11	Reverse side torque limit	Motor rated torque	X	X	○	○
12	Regeneration for torque limit	Motor rated torque	X	X	○	○
13	Torque reference/torque limit for speed control	Motor rated torque	X	X	X	○
14	Torque compensation bias	Motor rated torque	X	X	X	○
15	Forward/reverse torque limit	Motor rated torque	X	X	○	○
1F	Disable analog input (H3-05)	--	○	○	○	○
	Frequency Reference (H3-09)	Maximum output frequency				

- The analog input signal level, gain, and bias are set with the following constants.

Terminal 42 signal level selector	H3-04 (0 to +10 V or 0 to ±10 V)
Terminal 42 input gain	H3-06
Terminal 42 input bias	H3-07
Terminal 39 signal level selector	H3-08 (0 to +10 V, 0 to ±10 V, or 4 to 20 mA)

Advanced Operation

7.5.5 External Terminal Functions: H

Terminal 39 input gain	H3-10
Terminal 39 input bias	H3-11

- When a voltage input is being input to terminal 39, be sure to disconnect jumper wire J1 on the control PC board.
- The input resistance will be destroyed if a voltage input is used without disconnecting the jumper wire. (Refer to *Torque Reference Settings: H3-04, H3-05, H3-08, H3-09* in 7.3.3.)
- Set the time constant in constant H3-12 when adding a primary delay filter to an analog input. This filter time constant applies to all three of the analog inputs.

Analog Input Characteristics

- Analog input characteristics for a gain of 100.0% and a bias of 0.0% are shown for setting examples in *Table 7.12*.
- To set over 100% for a 10 V input (e.g., 300%/10 V), set the gain to 300% in H3-06 for terminal 42 and H3-10 for terminal 39.

Table 7.12 Analog Input Characteristics

<ul style="list-style-type: none"> • Auxiliary Frequency Reference (Setting: 0) • Frequency Bias (Setting: 2) • PID Feedback (Setting: B) • Frequency reference (H3-09 setting: 1F) 	<ul style="list-style-type: none"> • Frequency Gain (Setting: 1) • Output Voltage Bias (Setting: 4) • DC Injection Braking Current (Setting: 6) 	<ul style="list-style-type: none"> • Acceleration/Deceleration Time Gain (Setting: 5)
	<p>When set to “1,” the setting of H3-02 will be added to achieve the final gain.</p>	<p>Acceleration/deceleration time gain between 1 and 10 V.</p> $= \frac{10V}{\text{Input voltage (V)}} \times 10(\%)$
<ul style="list-style-type: none"> • DC Injection Braking Current (Setting: 6) • Overtorque Detection Level (Setting: 7) 	<ul style="list-style-type: none"> • Stall Prevention Level (Setting: 8) 	<ul style="list-style-type: none"> • Output Frequency Lower Limit (Setting: 9) • Jump Frequency (Setting: A)
<p>Only the overtorque detection 1 output can be used when “7” is set to use overtorque detection for a multi-function output.</p>		

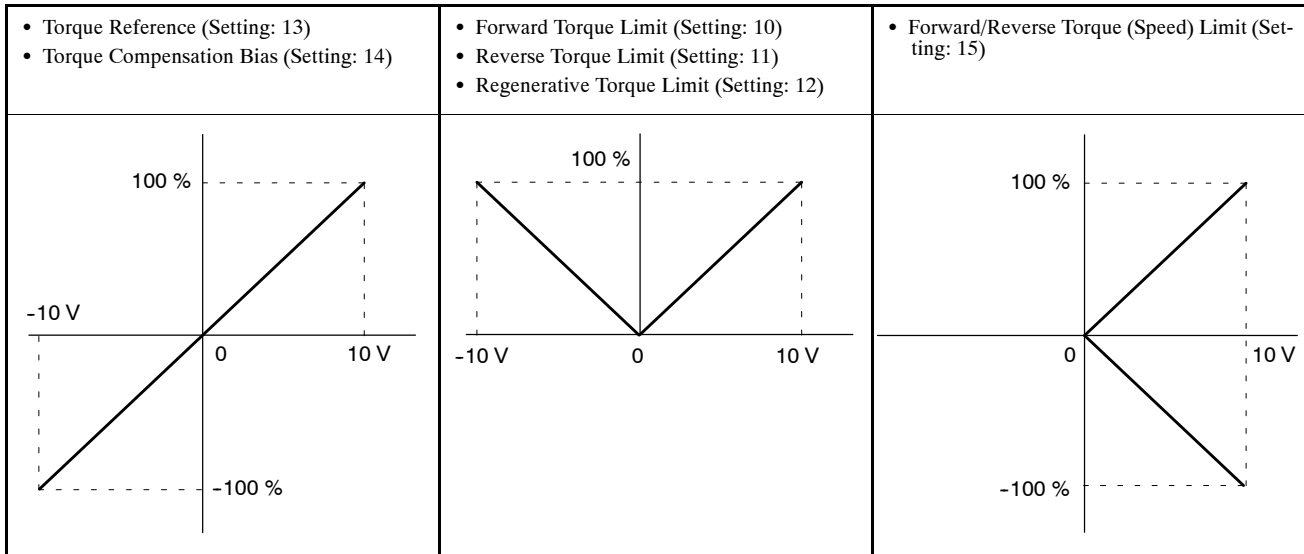

■ Multi-function Analog Output Settings: H4-01 to H4-07

Function Selection Constants: H4-01, H4-04

User Constant Number	Name	Change during Operation	Setting Range	Unit	Factory Setting	Valid Access Levels			
						V/f Control	V/f with PG	Open Loop Vector	Flux Vector
H4-01	Monitor selection (terminal 45)	x	1 to 35	-	2	B	B	B	B
H4-04	Monitor selection (terminal 48)	x	1 to 35	-	3	B	B	B	B

- The multi-function outputs can be set to monitor any of the U1 Inverter status items by setting the last two digits of the constant number (U1-□□). Refer to page 4 - 14 for a table listing all of these U1 settings.
- Settings 4, 10, 11, 12, 13, 14, 25, 28 and 34 can't be set and settings 29, 30, and 31 aren't used.

Adjusting the Monitor Output: H4-02, -03, -05, -06

User Constant Number	Name	Change during Operation	Setting Range	Unit	Factory Setting	Valid Access Levels			
						V/f Control	V/f with PG	Open Loop Vector	Flux Vector
H4-02	Gain (terminal 45)	○	0.00 to 2.50	Multiple	1.00	B	B	B	B
H4-03	Bias (terminal 45)	○	-10.0 to +10.0	%	0.0	B	B	B	B
H4-05	Gain (terminal 48)	○	0.00 to 2.50	Multiple	0.50	B	B	B	B
H4-06	Bias (terminal 48)	○	-10.0 to +10.0	%	0.0	B	B	B	B

- For the output gain, set what multiple of 10 V will correspond to a 100% output of the monitored item.
- For the output bias, set the amount that the output characteristic will be shifted vertically. Set this amount as a percentage, with 10 V corresponding to 100%.

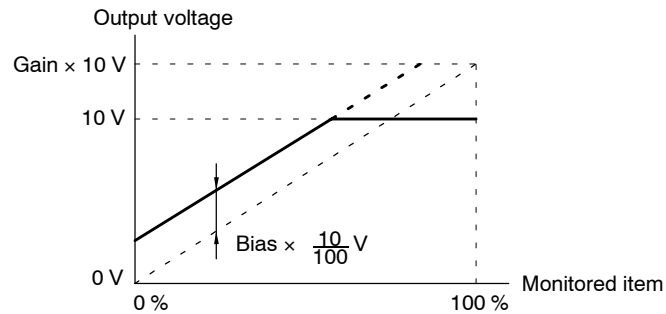

Fig 7.41 Monitor Output Adjustments

Multi-function Analog Output Signal Level: H4-07

User Constant Number	Name	Change during Operation	Setting Range	Unit	Factory Setting	Valid Access Levels			
						V/f Control	V/f with PG	Open Loop Vector	Flux Vector
H4-07	Analog output signal level selection	x	0, 1	-	0	B	B	B	B

- Settings

Setting	Function
0	0 to +10 V (Absolute value output)
1	0 to ± 10 V

- This signal level setting applies to analog outputs 1 and 2 (terminals 45 and 48).
- When the 0 to ± 10 V signal level is used to output speed values (frequency reference, output frequency, or motor speed), positive voltage indicates Inverter output in the forward direction and negative voltage indicates Inverter output in the reverse direction. (Assuming a bias setting of 0.0.)
- There are some monitor items that are limited to the 0 to +10 V signal range even when the 0 to ± 10 V signal level has been selected. Refer to *Table 4.3 Status Monitor Items* for details.

MEMOBUS Communications Settings: H5-01 to H5-05

Station Node Address: H5-01

- Set the Inverter node address.

User Constant Number	Name	Change during Operation	Setting Range	Unit	Factory Setting	Valid Access Levels			
						V/f Control	V/f with PG	Open Loop Vector	Flux Vector
H5-01	Station address	x	0 to 20	-	1F	A	A	A	A

Baud Rate: H5-02

- Set the baud rate for MEMOBUS communications.

User Constant Number	Name	Change during Operation	Setting Range	Unit	Factory Setting	Valid Access Levels			
						V/f Control	V/f with PG	Open Loop Vector	Flux Vector
H5-02	Communication speed selection	x	0 to 3	-	3	A	A	A	A

- Settings

Setting	Baud Rate
0	1200 bps
1	2400 bps;
2	4800 bps
3	9600 bps

Communication Parity: H5-03

- Set the parity for MEMOBUS communications.

User Constant Number	Name	Change during Operation	Setting Range	Unit	Factory Setting	Valid Access Levels			
						V/f Control	V/f with PG	Open Loop Vector	Flux Vector
H5-03	Communication parity selection	x	0 to 2	-	0	A	A	A	A

- Settings

Setting	Function
0	No parity
1	Even parity
2	Odd parity

Stopping Method after Communications Error: H5-04

- Set the stopping method to used after a communications error is detected.

User Constant Number	Name	Change during Operation	Setting Range	Unit	Factory Setting	Valid Access Levels			
						V/f Control	V/f with PG	Open Loop Vector	Flux Vector
H5-04	Stopping method after communication error	x	0 to 3	-	3	A	A	A	A

- Settings

Setting	Function
0	Deceleration to stop (deceleration time:C1-02)
1	Coast to stop
2	Emergency stop (deceleration time:C1-09)
3	Continue operation (display only)

Communications Error Detection: H5-05

- Set whether or not to detect a communications timeout as a communications error.

User Constant Number	Name	Change during Operation	Setting Range	Unit	Factory Setting	Valid Access Levels			
						V/f Control	V/f with PG	Open Loop Vector	Flux Vector
H5-05	Communication error detection selection	x	0, 1	-	1	A	A	A	A

- Settings

Setting	Function
0	Do not detect as communications error.
1	Detect as communications error.

7.5.6 Protective Functions: L

■ **Motor Protection Settings: L1-01, L1-02**

Motor Protection Selection: L1-01

User Constant Number	Name	Change during Operation	Setting Range	Unit	Factory Setting	Valid Access Levels			
						V/f Control	V/f with PG	Open Loop Vector	Flux Vector
L1-01	Motor protection selection	x	0, 1	-	1	B	B	B	B

- Settings

Setting	Function
0	Disabled.
1	Enabled.

- This setting enables or disables the motor overload protection function.
- The rated current setting (E2-01) is used as a basis for overload detection.
- Disable the motor protection function (setting 0) when two or more motors are connected to a single Inverter. Use another method to provide overload protection separately to each motor, such as connecting a thermal overload relay to the power line of each motor.
- The motor protection function may not protect a motor when the power supply is turned ON and OFF frequently, because the thermal value is reset each time that the power is turned OFF.
- If the Overload OL1 alarm (1F) is set in one of the multi-function outputs (H2-01 to H2-03), the output will be turned ON when the electronic thermal value reaches 90% of the overload detection level.

Motor Protection Time Constant: L1-02

User Constant Number	Name	Change during Operation	Setting Range	Unit	Factory Setting	Valid Access Levels			
						V/f Control	V/f with PG	Open Loop Vector	Flux Vector
L1-02	Motor protection time constant	X	0.1 to 5.0	Minutes	1.0	B	B	B	B

- Normally it isn't necessary to change this setting. (The factory setting is a 150%, 1 minute capacity.)
- Set the electronic thermal protection operation time if a 150% overload is applied after operating continuously at the motor's rated current (hot start).
- When the motor's overload capacity level is known, set the hot-start overload resistance level for the motor, but be sure to allow some margin for safety.
- Decrease this setting when you want to detect an overload more quickly.

Electronic Thermal Time Characteristics

In this example, L1-02 is set to 1 minute, the motor is operating at 60 Hz, and general-purpose motor characteristics are used.

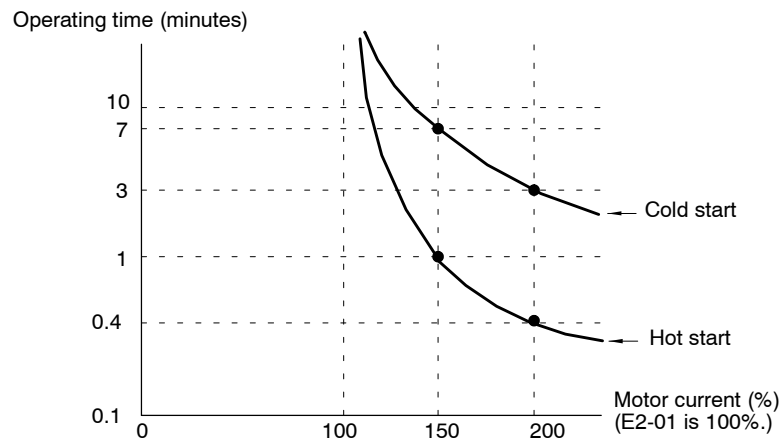

Fig 7.42 Motor Protection Operating Time

■ Momentary Power Loss Settings: L2-01 to L2-06

Momentary Power Loss Detection: L2-01

User Constant Number	Name	Change during Operation	Setting Range	Unit	Factory Setting	Valid Access Levels			
						V/f Control	V/f with PG	Open Loop Vector	Flux Vector
L2-01	Momentary power loss detection	X	0 to 2	-	0	B	B	B	B

- Settings

7.5.6 Protective Functions: L

Setting	Function
0	Disabled. (An undervoltage fault is detected when there is a momentary power loss.)
1	Enabled. (Restarts if power is restored within the L2-02 time. An under-voltage fault is detected for a longer power loss.)
2	Enabled during CPU operation. (Restarts if power is restored while the CPU is operating. An undervoltage fault is not detected.)

- This constant specifies the processing that is performed when a momentary power loss occurs.
- When power loss ridethru is enabled (setting 1 or 2), operation will be restarted after a speed search if the power is restored within the allowed time interval.
- When power loss ridethru is disabled (setting 0), an undervoltage fault will be detected if power is interrupted for more than 15 ms.

Momentary Power Loss Ridethru Time: L2-02

User Constant Number	Name	Change during Operation	Setting Range	Unit	Factory Setting	Valid Access Levels			
						V/f Control	V/f with PG	Open Loop Vector	Flux Vector
L2-02	Momentary power loss ridethru time	x	0.0 to 2.0	s	1.0	B	B	B	B

- The factory setting depends on the Inverter capacity. The factory setting shown in the table is for a 400-V class, 200 kW Inverter. (See page 8 - 42.)
- This setting is valid only when constant L2-01 is set to 1. Set the power loss ridethru time in seconds.

Minimum Baseblock Time: L2-03

User Constant Number	Name	Change during Operation	Setting Range	Unit	Factory Setting	Valid Access Levels			
						V/f Control	V/f with PG	Open Loop Vector	Flux Vector
L2-03	Min. baseblock time	X	0.0 to 25.5	s	10.0	B	B	B	B

- The factory setting depends on the Inverter capacity. The factory setting shown in the table is for a 400-V class, 200 kW Inverter. (See page 8 - 42.)
- This setting is used with the speed search and DC injection braking functions.
- Set the time required for the leakage voltage to dissipate. Increase the setting if an overcurrent (OC) occurs when the speed search or DC injection braking function starts.
- This setting is valid for speed searches performed after a momentary power loss and regular speed searches.

Voltage Recovery Time: L2-04

User Constant Number	Name	Change during Operation	Setting Range	Unit	Factory Setting	Valid Access Levels			
						V/f Control	V/f with PG	Open Loop Vector	Flux Vector
L2-04	Voltage recovery time	X	0.0 to 5.0	s	0.3	A	A	A	A

- Set the time allowed for the normal voltage to be restored after completion of the speed search. For a 400-V class Inverter, this is the time in seconds for voltage to be restored from 0 VAC to 400 VAC. For a 575-V class Inverter, this is the time in seconds for voltage to be restored from 0 VAC to 575 VAC.
- This setting is valid for speed searches after a momentary power loss, regular speed searches, the voltage changes with energy-saving control, and the voltage changes with baseblock clearing.

Undervoltage Detection Level: L2-05

User Constant Number	Name	Change during Operation	Setting Range	Unit	Factory Setting	Valid Access Levels			
						V/f Control	V/f with PG	Open Loop Vector	Flux Vector
L2-05	Undervoltage detection level	X	300 to 420 (430 to 600)	VDC	380 (570)	A	A	A	A

- The values in parentheses are for 575-V class Inverters. (See page 8 - 43.)
- Normally it isn't necessary to change this setting.
- Use this constant when you want to add an AC reactor and lower the main circuit undervoltage detection level. Be sure to set a main circuit DC voltage value (V) that will detect a main circuit undervoltage.

KEB Deceleration Rate: L2-06**IMPORTANT**

Although L2-06 is displayed on the Digital Operator, it cannot be set.

User Constant Number	Name	Change during Operation	Setting Range	Unit	Factory Setting	Valid Access Levels			
						V/f Control	V/f with PG	Open Loop Vector	Flux Vector
L2-06	KEB deceleration rate	X	0.0 to 100.0	0.1	0.0	A	A	A	A

- The KEB function restores the operating conditions for momentary power loss by applying a frequency deceleration to create inertia energy when a power loss occurs, and thus avoid the power loss.
- This function is normally used with film lines and other applications where multiple Inverters are connected to the main DC line. Synchronous deceleration for power loss prevents the line from stopping as the result of speed fluctuations.
- The KEB operation is performed using a KEB command (setting of 65 or 66) for a multi-function input.
- Applicable Capacities: 400-V class Inverters: 0.4 to 18.5 kW.

Operation

- L2-06 = 0

The motor is automatically accelerated based on the emergency stop time (C1-09) so that the DC main-line voltage does not go below the UV level. The momentary power loss ride-through time (L2-02) is not used.

- L2-06 ≠ 0
 The motor is decelerated to the KEB frequency level using the momentary power loss ride-thru time (L2-02) and then is accelerated to the original frequency reference using acceleration time 1 (C1-01). The KEB frequency level is calculated from the KEB frequency rate using the following equation.
 KEB frequency level = Output frequency before power loss [1 - (setting of L2-06)/100)]%

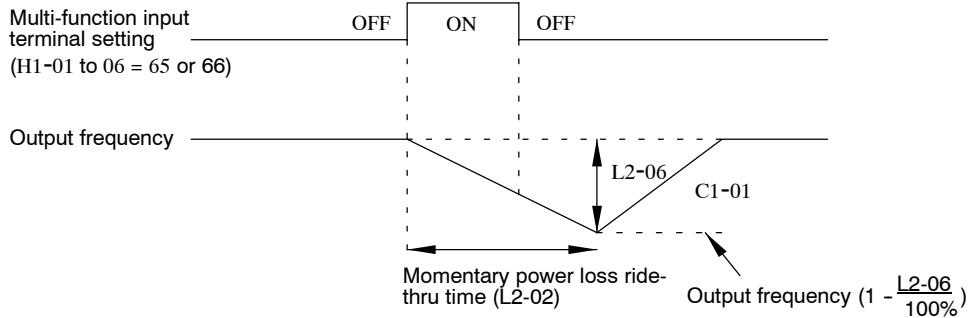

■ Stall Prevention Function Settings: L3-01 to L3-06

- A stall occurs if the rotor cannot keep up with the rotating magnetic field on the motor stator side when a large load is applied to the motor or a sudden acceleration/deceleration is performed.
- In the Inverter, stall prevention functions can be set independently for accelerating, running, and decelerating. (Some functions are restricted depending on the control method.)

Stall Prevention Selection During Acceleration: L3-01

User Constant Number	Name	Change during Operation	Setting Range	Unit	Factory Setting	Valid Access Levels			
						V/f Control	V/f with PG	Open Loop Vector	Flux Vector
L3-01	Stall prevention selection during accel	x	0 to 2	-	1	B	B	B	x

- Settings

Setting	Function
0	Disabled. (Accelerate according to the settings. Stalls may occur with large loads.)
1	Enabled. (Stop acceleration if L3-02 setting is exceeded. Accelerate again when current recovers.)
2	Optimum acceleration (Adjust acceleration so that the L3-02 isn't exceeded by much. Disregard the acceleration time setting.)

- When setting 1 (enabled) is selected, acceleration is stopped if the motor current exceeds the acceleration stall prevention level. Acceleration is started again when the current falls below this level. The acceleration time can be longer than the setting depending on the load.
- When setting 2 (optimum acceleration) is selected, acceleration is performed using the acceleration stall prevention level as a basis. In this case, the acceleration time is disregarded.

Stall Prevention Level During Acceleration: L3-02

User Constant Number	Name	Change during Operation	Setting Range	Unit	Factory Setting	Valid Access Levels			
						V/f Control	V/f with PG	Open Loop Vector	Flux Vector
L3-02	Stall prevention level during accel	x	0 to 200	%	150	B	B	B	x

- This setting is valid when L3-01 is set to 1 or 2.
- Normally it isn't necessary to change this setting.
- Decrease this setting when the motor capacity is small compared to the Inverter capacity or stalling occurs when the motor is operated with the factory setting. The standard target setting is 2 to 3 times the motor's rated current. (Set this current value as a percentage of the Inverter's rated current, i.e., 100% corresponds to the Inverter's rated current.)

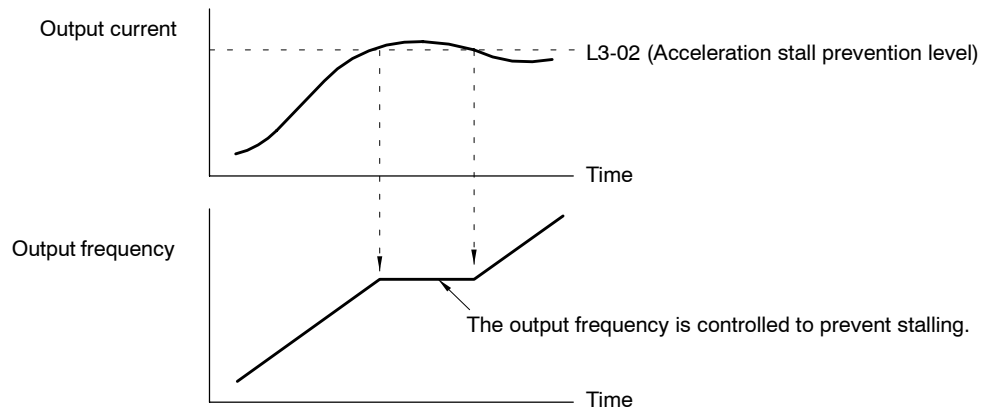
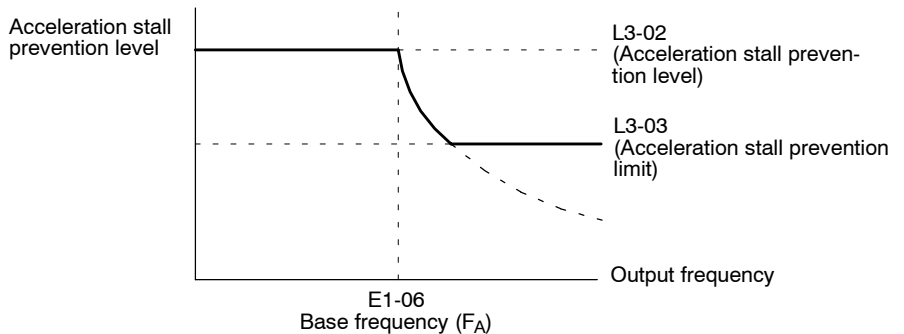

Fig 7.43 Acceleration Stall Prevention Function: L3-01 = 1

Stall Prevention Limit During Acceleration: L3-03

User Constant Number	Name	Change during Operation	Setting Range	Unit	Factory Setting	Valid Access Levels			
						V/f Control	V/f with PG	Open Loop Vector	Flux Vector
L3-03	Stall prevention limit during accel	x	0 to 100	%	50	A	A	A	x

- Normally it isn't necessary to change this setting.
- Set this constant when a high-speed motor is being used in the high-speed range (the high frequency range above the base frequency).
- The standard target setting is the motor's rated current. Set this current value as a percentage of the Inverter's rated current, i.e., 100% corresponds to the Inverter's rated current.



Note When the motor is used in the high-speed range, the acceleration stall prevention level is automatically lowered to provide smoother acceleration. The acceleration stall prevention limit (L3-03) limits how much the acceleration stall prevention level is lowered so that it isn't lowered any more than necessary.

Fig 7.44 Stall Prevention Limit During Acceleration

Stall Prevention Selection During Decel: L3-04

User Constant Number	Name	Change during Operation	Setting Range	Unit	Factory Setting	Valid Access Levels			
						V/f Control	V/f with PG	Open Loop Vector	Flux Vector
L3-04	Stall prevention selection during decel	X	0 to 2	-	1	B	B	B	B

• Settings

Setting	Function
0	Disabled. (Decelerate according to the settings. Main circuit overvoltage may occur if the deceleration time is too short.)
1	Enabled. (Stops deceleration if the main circuit voltage exceeds the overvoltage level. Decelerate again when voltage recovers.)
2	Optimum deceleration. (Decelerate as fast as possible judging from the main circuit voltage. Disregard the deceleration time setting.)

- When setting 1 (enabled) is selected, the deceleration time is extended automatically so that a main circuit overvoltage doesn't occur.
- Always select setting 0 when a braking option (Braking Resistor, Braking Resistor Unit, or Braking Unit) is being used. If setting 1 or 2 is selected, the braking option won't be used and the deceleration time can't be shortened.
- L3-04 cannot be set to 2 for vector control modes.

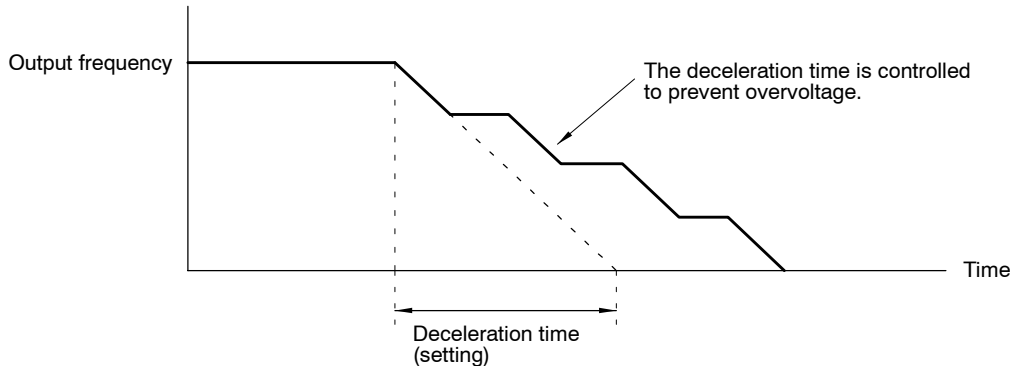

Fig 7.45 Deceleration Stall Prevention Function: L3-04 = 1

Stall Prevention Selection During Running: L3-05

User Constant Number	Name	Change during Operation	Setting Range	Unit	Factory Setting	Valid Access Levels			
						V/f Control	V/f with PG	Open Loop Vector	Flux Vector
L3-05	Stall prevention selection during running	X	0 to 2	-	1	B	B	X	X

• Settings

Setting	Function
0	Disabled. (Run according to the settings. Stalls may occur with large loads.)
1	Enabled - deceleration time 1. (Use deceleration time in C1-02 for stall prevention function.)
2	Enabled - deceleration time 2. (Use deceleration time in C1-04 for stall prevention function.)

- When setting 1 or 2 (enabled) is selected, deceleration is started if the current of the stall prevention level during operation continues for more than 100 ms. The motor is accelerated back to the reference frequency again when the current falls below this level.

Stall Prevention Level During Running: L3-06

User Constant Number	Name	Change during Operation	Setting Range	Unit	Factory Setting	Valid Access Levels			
						V/f Control	V/f with PG	Open Loop Vector	Flux Vector
L3-06	Stall prevention level during running	x	30 to 200	%	160	B	B	x	x

- This setting is valid when L3-05 is set to 1 or 2.
- Normally it isn't necessary to change this setting.
- Decrease this setting when the motor capacity is small compared to the Inverter capacity or stalling occurs when the motor is operated with the factory setting. (Set this current value as a percentage of the Inverter's rated current, i.e., 100% corresponds to the Inverter's rated current.)

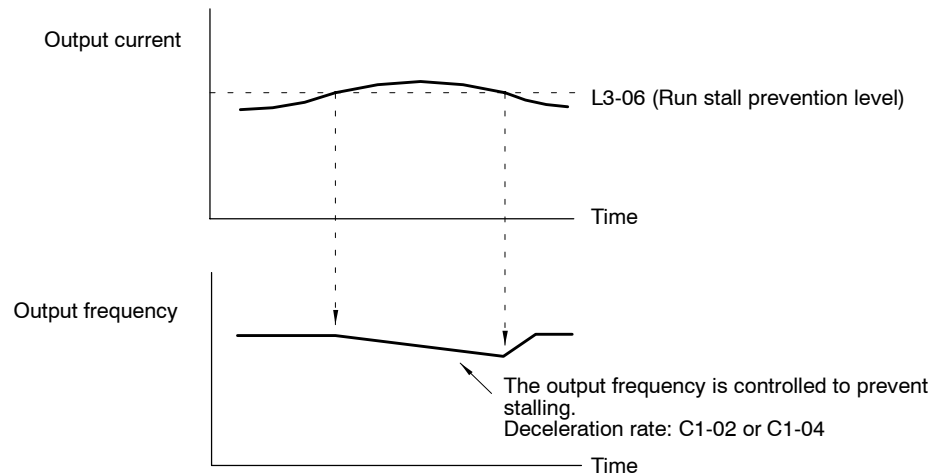

Fig 7.46 Run Stall Prevention Function: L3-05 = 1 or 2

■ Frequency Detection Settings: L4-01 to L4-05

User Constant Number	Name	Change during Operation	Setting Range	Unit	Factory Setting	Valid Access Levels			
						V/f Control	V/f with PG	Open Loop Vector	Flux Vector
L4-01	Speed agree detection level	x	0.0 to 150.0	Hz	0.0	B	B	B	B
L4-02	Speed agree detection width	x	0.0 to 20.0	Hz	2.0	B	B	B	B
L4-03	Speed agree detection level (+/-)	x	-150.0 to +150.0	Hz	0.0	A	A	A	A
L4-04	Speed agree detection width (+/-)	x	0.0 to 20.0	Hz	2.0	A	A	A	A

- Set these constants when outputting one of the frequency agree or frequency detection signals from a multi-function output. *Table 7.13* shows the relationship between these constants and the output signals.
- Motor speed is detected at Flux Vector Control.

Table 7.13 Constants and Output Signals

Constant	Related output settings	Constant function
Speed Agree Level (Absolute value)	Fref/Set Agree 1 Frequency Detection 1 Frequency Detection 2	Set the frequency (or motor speed) that you want to detect in Hz. The set speed is an absolute value, so the speed is detected in forward or reverse.
Speed Agree Width (Absolute value)	Fref/Fout Agree 1 Fref/Set Agree 1 Frequency Detection 1 Frequency Detection 2	Set the frequency (or motor speed) detection range in Hz.
Speed Agree Level +/- (Signed value)	Fref/Set Agree 2 Frequency Detection 3 Frequency Detection 4	Set the frequency (or motor speed) that you want to detect in Hz. Set positive values for forward, negative values for reverse.
Speed Agree Width +/- (Signed value)	Fref/Fout Agree 2 Fref/Set Agree 2 Frequency Detection 3 Frequency Detection 4	Set the frequency(or motor speed) detection range in Hz.

- Set the corresponding setting in the multi-function output (H2-01, H2-02, or H2-03) to output the desired Fref/Fout Agree signal, Fref/Set Agree signal, or Frequency Detection signal.

Function	Setting
Fref/Fout Agree 1	2
Fref/Set Agree 1	3
Frequency Detection 1	4
Frequency Detection 2	5
Fref/Fout Agree 2	13
Fref/Set Agree 2	14
Frequency Detection 3	15
Frequency Detection 4	16

Frequency Detection Operation: L4-05

User Constant Number	Name	Change during Operation	Setting Range	Unit	Factory Setting	Valid Access Levels			
						V/f Control	V/f with PG	Open Loop Vector	Flux Vector
L4-05	Operation when frequency reference is missing	x	0, 1	-	0	A	A	A	A

- The frequency reference is considered lost when the frequency reference voltage drops by 90% for more than 400 ms.
- Settings

Setting	Function
0	Stop. (Operate according to the frequency reference value.)
1	Continue operation at 80% speed. (Continue operation with a speed that is 80% of the value when the frequency reference was lost.)

• Timing Chart for Frequency Detection Operation

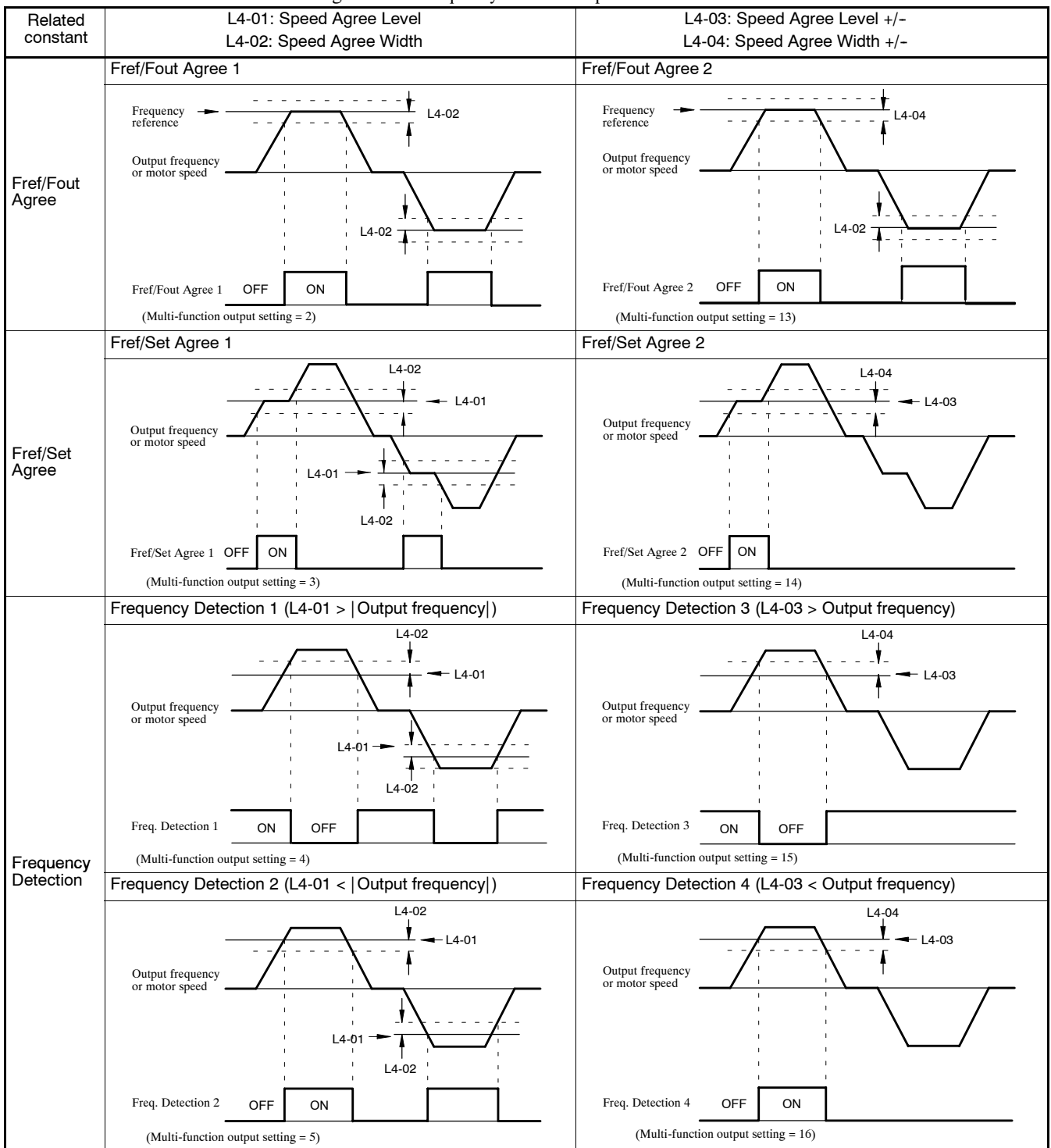

■ **Fault Restart Settings: L5-01, L5-02**

Number of Auto Restart Attempts: L5-01

User Constant Number	Name	Change during Operation	Setting Range	Unit	Factory Setting	Valid Access Levels			
						V/f Control	V/f with PG	Open Loop Vector	Flux Vector
L5-01	Number of auto restart attempts	x	0 to 10	---	0	B	B	B	B

IMPORTANT

- The Inverter might be damaged when using the fault restart function too frequently.
- Understanding that the Inverter might be damaged, be sure to take the following precautions:
Always set up a molded-case circuit breaker (MCCB).
Set up a sequence that will stop peripheral equipment when an Inverter fault occurs.

- The fault restart function automatically restarts the Inverter even when an internal fault occurs during Inverter operation. Use this function only when continuing operation is more important than possibly damaging the Inverter.
- The fault restart function is effective with the following faults. With other faults, the protective operations will engage immediately without attempting to restart operation.
 - OC (Overcurrent)
 - GF (Ground fault)
 - PUF (Fuse blown)
 - OV (Main circuit overvoltage)
 - UV1 (Main circuit undervoltage)
 - PF (Main circuit voltage fault)
 - LF (Output open-phase)
 - RF (Braking resistor overheated)
 - RR (Braking transistor fault)
 - OL1 (Motor overload)
 - OL2 (Inverter overload)
 - OL3 (Overtorque)
 - OL4 (Overtorque)
- The fault restart count is cleared in the following cases:
 - When operation is normal for 10 minutes after a fault restart is performed.
 - When the fault reset input is received after the protection operation has been activated and the fault confirmed.
 - When the power is turned OFF and then ON again.
- When one of the multi-function outputs (H2-01, H2-02, or H2-03) is set to 1E (Restart Enabled), the output will be ON while the fault restart function is in progress.

Auto Restart Operation Selection: L5-02

User Constant Number	Name	Change during Operation	Setting Range	Unit	Factory Setting	Valid Access Levels			
						V/f Control	V/f with PG	Open Loop Vector	Flux Vector
L5-02	Auto restart operation selection	x	0, 1	-	0	B	B	B	B

- Settings

Setting	Function
0	Do not output fault restart. (The fault contact does not operate.)
1	Output fault restart. (The fault contact operates.)

■ Overtorque Detection Settings: L6-01 to L6-06

User Constant Number	Name	Change during Operation	Setting Range	Unit	Factory Setting	Valid Access Levels			
						V/f Control	V/f with PG	Open Loop Vector	Flux Vector
L6-01	Torque detection selection 1	x	0 to 4	-	0	B	B	B	B
L6-02	Torque detection level 1	x	0 to 300	%	150	B	B	B	B
L6-03	Torque detection time 1	x	0.0 to 10.0	s	0.1	B	B	B	B
L6-04	Torque detection selection 2	x	0 to 4	-	0	A	A	A	A
L6-05	Torque detection level 2	x	0 to 300	%	150	A	A	A	A
L6-06	Torque detection time 2	x	0.0 to 10.0	s	0.1	A	A	A	A

- The overtorque detection function detects an excessive mechanical load from an increase in the output current (or output torque).
- The settings in the torque detection selection constants (L6-01 and L6-04) determine whether overtorque conditions will be detected and what kind of processing will be performed if a overtorque condition is detected.

• L6-01/L6-04 Settings

Setting	Function	Display	
0	Overtorque detection disabled	Overtorque detection 1	Overtorque output 2
1	Detect only during speed agree. Continue operation even after detection. (Minor fault)	“OL3” blinks	“OL4” blinks
2	Detect overtorque at any time. Continue operation even after detection. (Minor fault)	“OL3” blinks	“OL4” blinks
3	Detect only during speed agree. Stop output after detection. (Fault)	“OL3” lights	“OL4” lights
4	Detect overtorque at any time. Stop output after detection. (Fault)	“OL3” lights	“OL4” lights

- When overtorque detection is enabled, be sure to set the overtorque detection level (L6-02 or L6-05) and the overtorque detection time (L6-02 or L6-05). An overtorque condition is detected when the current exceeds the overtorque detection level for longer than the overtorque detection time.
- The overtorque detection level settings depend on the control method:
 - Open-loop or flux vector control: Set as a percentage of the motor rated torque.
 - Normal V/f or V/f with PG feedback control: Set as a percentage of the Inverter rated current.
- Any of the following functions can be set in a multi-function output (H2-01, H2-02, or H2-03) to indicate fact that an overtorque condition has been detected.
 - Setting B: Overtorque detection 1 (NO)
 - Setting 17: Overtorque detection 1 (NC)
 - Setting 18: Overtorque detection 2 (NO)
 - Setting 19: Overtorque detection 2 (NC)

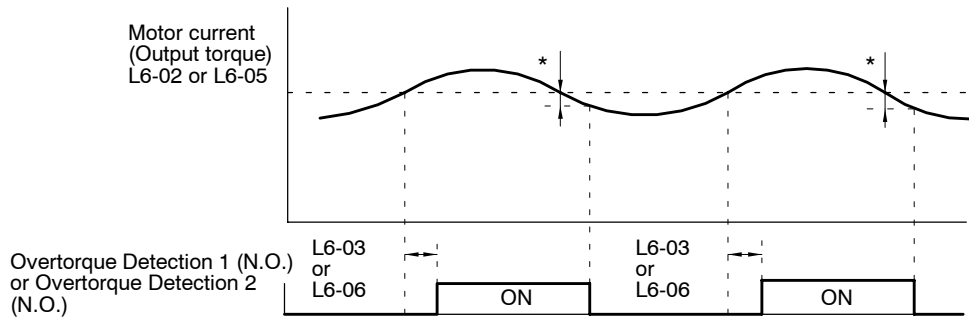

* The overtorque detection is cleared when the current drops about 5% of the Inverter's rated current (or the motor's rated torque).

Fig 7.47 Timing Chart for Overtorque Detection

■ Hardware Protection Settings: L8-01 to L8-03, L8-05, L8-07

Protection Selection for Internal DB Resistor: L8-01

IMPORTANT

Always set to 0 when using a Large-capacity Slim Type Inverter.

User Constant Number	Name	Change during Operation	Setting Range	Unit	Factory Setting	Valid Access Levels			
						V/f Control	V/f with PG	Open Loop Vector	Flux Vector
L8-01	Protect selection for internal DB resistor	X	0, 1	-	0	B	B	B	B

- Settings

Setting	Function
0	Disabled. (Select 0 when a braking resistor isn't being used or a Braking Resistor Unit is being used.)
1	Enabled. (Protects the braking resistor from overheating.)

Inverter Overheating (OH) Pre-alarm Settings: L8-02, L8-03

User Constant Number	Name	Change during Operation	Setting Range	Unit	Factory Setting	Valid Access Levels			
						V/f Control	V/f with PG	Open Loop Vector	Flux Vector
L8-02	Overheat pre-alarm level	x	50 to 110	°C	95	A	A	A	A
L8-03	Operation selection after overheat pre-alarm	x	0 to 3	-	3	A	A	A	A

- Constant L8-02 specifies the detection temperature in °C for the Inverter overheat (OH) pre-alarm function. An overheat pre-alarm occurs when the temperature of the cooling fins reaches this level.
- Constant L8-03 specifies the processing that will be performed when an overheat pre-alarm occurs. Apart from this setting, cooling fin overheating (OH1) is detected as a protection function at 105°C.
- Settings

Setting	Function
0	Decelerates to a stop in the deceleration time set in C1-09. (Protection operation: Fault contacts operate)
1	Coast to stop. (Protection operation: Fault contacts operate)
2	Emergency stop in the emergency-stop time set in C1-09. (Protection operation: Fault contacts operate)
3	Continues operation. (Alarm: Monitor display only.)

Input Open-phase Protection Selection: L8-05

User Constant Number	Name	Change during Operation	Setting Range	Unit	Factory Setting	Valid Access Levels			
						V/f Control	V/f with PG	Open Loop Vector	Flux Vector
L8-05	Input open-phase protection selection	x	0, 1	-	0	A	A	A	A

- This function detects changes in the main circuit DC voltage which indicate a power supply open-phase, large imbalance in the power supply voltage, or deterioration of the main circuit capacitor.
- Settings

Setting	Function
0	Disabled.
1	Enabled. (Detects input power supply open-phase, 3-phase imbalance, or deterioration of the main circuit capacitor.)

Output Open-phase Protection Selection: L8-07

- This function detects an Inverter output open-phase.

User Constant Number	Name	Change during Operation	Setting Range	Unit	Factory Setting	Valid Access Levels			
						V/f Control	V/f with PG	Open Loop Vector	Flux Vector
L8-07	Output open-phase protection selection	x	0, 1	-	0	A	A	A	A

- Settings

Setting	Function
0	Disabled.
1	Enabled. (Detects an output open-phase at under 10% of the Inverter's rated output current.)

- False open-phase detections may occur or detection may not work when the motor capacity is small compared to the Inverter capacity. In this case, disable the detection function by setting L8-07 to 0.

7.5.7 Operator Constants: o

■ Operator Display Selection: o1-01 to o1-05

Constant Number Display Selection: o1-01

User Constant Number	Name	Change during Operation	Setting Range	Unit	Factory Setting	Valid Access Levels			
						V/f Control	V/f with PG	Open Loop Vector	Flux Vector
o1-01	Constant No. display selection	○	4 to 35	-	6	B	B	B	B

- In operation mode, the frequency reference, output frequency, output current, and output voltage can be monitored immediately if the factory settings are being used. One of these four values, the output voltage, can be changed to a different value.
- When you want to monitor a value other than the output voltage, set that number in constant o1-01.
- Use the last two digits from the “U1 Monitor” list (U1-□□) to select a value. Refer to Table 4.3.

Monitor Selection After Power Up: o1-02

User Constant Number	Name	Change during Operation	Setting Range	Unit	Factory Setting	Valid Access Levels			
						V/f Control	V/f with PG	Open Loop Vector	Flux Vector
o1-02	Monitor selection after power up	○	1 to 4	-	1	B	B	B	B

- When the power is turned on, the frequency reference will appear in the Unit’s data display if the factory settings are being used.
- Any one of the four values monitored at startup (frequency reference, output frequency, output current, or the value set in constant o1-01) can be selected to appear when the power is turned ON.
- Change the setting of constant o1-02 to display an item other than the frequency reference at startup.
- Settings

Setting	Function
1	The frequency reference is displayed at start-up.
2	The output frequency is displayed at start-up.
3	The output current is displayed at start-up.
4	The value set in constant o1-01 is displayed at start-up.

Frequency Units of Reference Setting and Monitor: o1-03

- Set the unit for frequency setting and monitoring.

User Constant Number	Name	Change during Operation	Setting Range	Unit	Factory Setting	Valid Access Levels			
						V/f Control	V/f with PG	Open Loop Vector	Flux Vector
o1-03	Frequency units of reference setting and monitor	X	0 to 39999	-	0	B	B	B	B

- Settings

Setting	Unit
0	0.01 Hz
1	0.01%

Setting	Unit
2 to 39	r/min (0 to 3999) r/min = 120 x frequency reference(Hz)/o1-03 (number of motor poles)
40 to 39999	Use the 5th digit of o1-03 to specify the decimal point. 5th digit = 0: □□□□ 5th digit = 1: □□□.□ 5th digit = 2: □□.□□ 5th digit = 3: □.□□□ The 1st to 4th digits of o1-03 determine the frequency setting Ex 1: To set the 100% speed to 200.0, set o1-03 to 12000. 200.0 will be displayed for 100%, 120 will be displayed for 60%. Ex 2: To set the 100% speed to 65.00, set o1-03 to 26500. 65.00 will be displayed for 100%, 39.00 will be displayed for 60%.

Frequency Units of Constant Setting: o1-04

- This constant can be used to change the setting unit for V/f control constants to r/min.

User Constant Number	Name	Change during Operation	Setting Range	Unit	Factory Setting	Valid Access Levels			
						V/f Control	V/f with PG	Open Loop Vector	Flux Vector
o1-04	Frequency units of constant setting	x	0, 1	-	0	x	x	x	B

- Settings

Setting	Unit
0	Unit of setting: Hz
1	Unit of setting: r/min

Constant Number Display Selection: o1-05

User Constant Number	Name	Change during Operation	Setting Range	Unit	Factory Setting	Valid Access Levels			
						V/f Control	V/f with PG	Open Loop Vector	Flux Vector
o1-05	Constant No. display selection	x	0, 1	-	0	A	A	A	A

- Settings

Setting	Function
0	Display constant number
1	Display constant number (address) set for MEMOBUS communications

Key Function Settings/Other Settings: o2-01 to o2-08

LOCAL/REMOTE Key Enable/Disable: o2-01

User Constant Number	Name	Change during Operation	Setting Range	Unit	Factory Setting	Valid Access Levels			
						V/f Control	V/f with PG	Open Loop Vector	Flux Vector
o2-01	LOCAL/REMOTE key enable/disable	x	0, 1	-	1	B	B	B	B

- This constant enables or disables the LOCAL/REMOTE Key (the Operation Mode Selector Key) on the Digital Operator.
- Settings

Setting	Function
0	Disabled. (Cannot change between local and remote.)
1	Enabled. (Pressing the LOCAL/REMOTE Key switches control of operation between the Operator and the sources specified in constants b1-01 and b1-02.)

STOP Key During Control Circuit Terminal Operation: o2-02

User Constant Number	Name	Change during Operation	Setting Range	Unit	Factory Setting	Valid Access Levels			
						V/f Control	V/f with PG	Open Loop Vector	Flux Vector
o2-02	STOP Key during control circuit terminal operation	X	0, 1	-	1	B	B	B	B

- This constant enables or disables the STOP on the Digital Operator
- Settings

Setting	Function
0	Disabled. (The STOP Key is disabled when the run command is input from an external terminal.)
1	Enabled. (The STOP Key is enabled at all times during operation.)

User Constant Initial Value: o2-03

User Constant Number	Name	Change during Operation	Setting Range	Unit	Factory Setting	Valid Access Levels			
						V/f Control	V/f with PG	Open Loop Vector	Flux Vector
o2-03	User constant initial value	X	0 to 2	-	0	B	B	B	B

- This constant is used to record or clear the user constant defaults.
- Once the user defaults have been recorded, constant A1-03 can be used to initialize the Inverter constants to these defaults.
- Settings

Setting	Function
0	No change. (Retain current settings.)
1	Record user defaults. (Record the current constant settings as user defaults.)
2	Clear user defaults. (Clear the recorded user defaults.)

- The Digital Operation display will return to 0 after the settings have been made.

kVA Selection: o2-04

User Constant Number	Name	Change during Operation	Setting Range	Unit	Factory Setting	Valid Access Levels			
						V/f Control	V/f with PG	Open Loop Vector	Flux Vector
o2-04	kVA selection	X	0 to FF	-	0	B	B	B	B

- The setting range and factory setting depend on the Inverter capacity. The settings shown in the table are for a 400-V class, 200 kW Inverter. (See page 8 - 42.)
- Do not change this constant setting; it is used by the manufacturer to identify the Inverter model.
- Use this setting only the the control PC board has been replaced.

Frequency Reference Setting Method Selection: o2-05

User Constant Number	Name	Change during Operation	Setting Range	Unit	Factory Setting	Valid Access Levels			
						V/f Control	V/f with PG	Open Loop Vector	Flux Vector
o2-05	Frequency reference setting method selection	X	0, 1	-	0	A	A	A	A

- This constant determines whether it is necessary to press the Enter Key when changing the frequency reference with the Digital Operator's frequency reference monitor; it cannot be changed during operation.
- When o2-05 is set to 1 (DATA/ENTER Key input not required.), the frequency reference changes simultaneously with the Digital Operator's value.

- Settings

Setting	Function
0	DATA/ENTER Key input required.
1	DATA/ENTER Key input not required.

Operation Selection when Digital Operator is Disconnected: o2-06

User Constant Number	Name	Change during Operation	Setting Range	Unit	Factory Setting	Valid Access Levels			
						V/f Control	V/f with PG	Open Loop Vector	Flux Vector
o2-06	Operation selection when digital operator is disconnected	x	0, 1	-	0	A	A	A	A

- This constant specifies whether to stop operation when the Digital Operator is disconnected.

- Settings

Setting	Function
0	Disable Operator detection. (Continue operation when the Digital Operator is disconnected.)
1	Enable Operator detection. (Detect an OPR fault when the Digital Operator is disconnected, stop the Inverter output, and operate the fault contact.)

Cumulative Operation Time Settings: o2-07, o2-08

User Constant Number	Name	Change during Operation	Setting Range	Unit	Factory Setting	Valid Access Levels			
						V/f Control	V/f with PG	Open Loop Vector	Flux Vector
o2-07	Cumulative operation time setting	x	0 to 65535	h	0	A	A	A	A
o2-08	Cumulative operation time selection	x	0, 1	-	0	A	A	A	A

- Set the initial elapsed time in constant o2-07. The elapsed operating time will start from this value.
- Constant o2-08 determines whether the elapsed operating time is the time that the Inverter is on or the time that the Inverter is running.

- Settings

Setting	Function
0	Inverter power-on time. (Counts the elapsed time from start-up until power is turned off.)
1	Inverter running time. (Counts the elapsed time that there is an Inverter output.)

8

User Constants

This chapter lists all user constants that can be used in the Programming and Initialize modes.

8.1 Initialize Mode Constants	8 - 3
8.2 Programming Mode Constants	8 - 4
8.2.1 Application Constants: b	8 - 4
8.2.2 Autotuning Constants: C	8 - 10
8.2.3 Reference Constants: d	8 - 16
8.2.4 Motor Constant Constants: E	8 - 19
8.2.5 Options Constants: F	8 - 23
8.2.6 Terminal Constants: H	8 - 26
8.2.7 Protection Constants: L	8 - 33
8.2.8 Operator Constants: o	8 - 39
8.2.9 Factory Settings that Change with the Control Method (A1-02)	8 - 41
8.2.10 Factory Settings that Change with the Inverter Capacity (o2-04)	8 - 42

■ User Constant Descriptions

Constant Number	Name	Description	Setting Range	Factory Setting	Change during Operation	Control Methods				Page
	Display					V/f	V/f with PG	Open Loop Vector	Flux Vector	
A1-00	Language selection for digital operator display	Used to select the language displayed on the Digital Operator 0: English 1: Japanese **This constant is not changed by the initialize operation.	0.1	1	○	Q	Q	Q	Q	4 - 22
	Select Language									

- Constant Number: The constant number.
- Name: The constant name.
- Display: The constant name displayed on the Digital Operator.
- Description: Details of the constant function or setting value.
- Setting Range: The constant setting range.
- Factory Setting: The factory setting value (each control method has its own factory setting. Therefore the factory setting changes when the control method is changed.)
□ See page 8 - 41 for factory settings by control method.
- Change during Operation: Indicates whether or not the constant can be changed while in the Inverter is in operation.
○ . . Changes possible during operation.
X . . . Changes not possible during operation.
- Control Method: Indicates which control methods and which access levels can be set and referenced.
Q . . Items which can be set and referenced on all access levels; Quick-Start, Basic, and Advanced.
B . . . Items which can be set and referenced in Advanced and Basic.
A . . . Items which can be set and referenced in Advanced only.
X . . . Items which cannot be set or referenced in that control method.
- Page: Reference page for more detailed information on the constant.

8.1 Initialize Mode Constants

Constant Number	Name	Description	Setting Range	Factory Setting	Change during Operation	Control Methods				Page
	Display					V/f	V/f with PG	Open Loop Vector	Flux Vector	
A1-00	Language selection for digital operator display	Used to select the language displayed on the Digital Operator 0: English 1: Japanese	0, 1	1	○	Q	Q	Q	Q	4 - 22
	Select Language	※※This constant is not initialized by the initialize operation.								
A1-01	Constant access level	Used to set the constant access level (set/read.) 0: Monitoring only (Displays only Operation mode and Initialize mode)	0 to 4	2	○	Q	Q	Q	Q	4 - 22
	Access Level	1: Used to select user constant (Constants A2-01 to A2-32 only can be set/read.) 2: Quick-Start : Q 3: Basic : B 4: Basic : A								
A1-02	User setting constant	Used to select the control method for the Inverter 0: V/f control 1: V/f with PG feedback 2: Open loop vector 3: Flux vector	0 to 3	2	x	Q	Q	Q	Q	4 - 24
	User Param 1 to 32	※※This constant is not initialized by the initialize operation.								
A1-03	Initialize	Used to initialize the constants using the specified method. 0: No initializing 1110: Initializes using the User constants	0 to 3330	0	x	Q	Q	Q	Q	4 - 25
	Init Constants	2220: Initializes using a two-wire sequence. (Initializes to the factory setting.) 3330: Initializes using a three-wire sequence.								
A1-04	Password 1	Password input when a password has been set in A1-05. This function write-protects some constants of the Initialize mode.	0 to 9999	0	x	Q	Q	Q	Q	4 - 27
	Enter Password	※※If the password is changed, A1-01 to A1-03 and A2-01 to A2-32 constants can no longer be changed. (Programming mode constants can be changed.)								
A1-05	Password 2	Used to set a four digit number as the password.	0 to 9999	0	x	Q	Q	Q	Q	4 - 27
	Select Password	※※This constant is not usually displayed. When the password (A1-04) is displayed, hold down the Reset/Select Key and press the Menu Key and the password will be displayed.								
A2-01 to A2-32	User setting constant	Used to set the constant numbers that can be set/read. Maximum 32.	b1-01 to o2-08	--	x	A	A	A	A	4 - 27
	User Param 1 to 32	※※Effective when the access level (A1-01) is set to User Program (1). Constants set in constants A2-01 to A2-32 can be set/read in the Programming mode.								

8.2 Programming Mode Constants

8.2.1 Application Constants: b

■ Operation Mode Selections: b1

Constant Number	Name	Description	Setting Range	Factory Setting	Change during Operation	Control Methods				Page
	Display					V/f	V/f with PG	Open Loop Vector	Flux Vector	
b1-01	Reference selection	Used to set the input method for the frequency reference. 0: Digital Operator 1: Control circuit terminals (analog inputs). 2: Transmission 3: Option Card	0 to 3	1	x	Q	Q	Q	Q	6 - 4 6 - 7
	Reference Source									
b1-02	Operation method selection	Used to set the source of the run command. 0: Digital Operator 1: Control circuit terminals (sequence inputs). 2: Transmission 3: Option Card	0 to 3	1	x	Q	Q	Q	Q	6 - 9
	Run Source									
b1-03	Stopping method selection	Used to set the stopping method used when a stop command is input. 0: Ramp to stop 1: Coast to stop. 2: DC injection braking stop: (Stops faster than coast to stop, no regenerative operation.) 3: Coast to stop with timer: Run commands are disregarded during deceleration. **Only settings 0 and 1 can be used with flux vector control.	0 to 3	0	x	Q	Q	Q	Q	6 - 12
	Stopping Method									
b1-04	Prohibition of reverse operation	0: Reverse enabled 1: Reverse disabled	0, 1	0	x	B	B	B	B	6 - 11
	Reverse Oper									
b1-05	Operation selection for setting of E1-09 or less	Used to set the method of operation when the frequency reference input is less than the minimum output frequency (E1-09). 0: Run at frequency reference (E1-09 not effective). 1: STOP (Frequencies below E1-09 in the coast to stop state.) 2: Run at min. frequency. (E1-09) 3: Run at zero speed (Frequencies below E1-09 are zero) *This function is only available in with flux vector control.	0 to 3	0	x	x	x	x	A	6 - 29
	Zero-Speed Oper									
b1-06	Read sequence input twice	Used to set the responsiveness of the control inputs (forward/reverse and multi-function inputs.) 0: Two scans every 2 ms (Use when connecting transistor outputs.) 1: Two scans every 5 ms (Use when connecting contact outputs or switches.)	0, 1	1	x	A	A	A	A	6 - 9
	Cntl Input Scans									

Constant Number	Name	Description	Setting Range	Factory Setting	Change during Operation	Control Methods				Page
	Display					V/f	V/f with PG	Open Loop Vector	Flux Vector	
b1-07	Operation selection after switching to remote mode	Used to set the Operation mode by switching to the Remote mode using the Local/Remote Key. 0: Run signals that are input during mode switching are disregarded. (Input Run signals after switching the mode.)	0, 1	0	x	A	A	A	A	6 - 9
	LOC/REM RUN Sel	1: Run signals become effective immediately after switching to the Remote mode.								

■ DC Braking: b2

Constant Number	Name	Description	Setting Range	Factory Setting	Change during Operation	Control Methods				Page
	Display					V/f	V/f with PG	Open Loop Vector	Flux Vector	
b2-01	Zero speed level (DC injection braking starting frequency)	Used to set the frequency which starts DC injection braking (the initial excitation for flux vector control) in units of 0.1 Hz when deceleration to stop is selected.	0.0 to 10.0	0.5	x	B	B	B	B	7 - 41 6 - 29
	DCInj Start Freq	***When b2-01 is less than E1-09, E1-09 becomes the DC injection braking starting frequency. Only with flux vector control is b2-01 used.								
b2-02	DC injection braking current	Sets the DC injection braking current as a percentage of the Inverter rated current.	0 to 100	50	x	B	B	B	x	7 - 41
	DCInj Current	***The initial excitation current for flux vector control depends on the E2-03 setting.								
b2-03	DC injection braking time at start	Used to set the time to perform DC injection braking (initial excitation for flux vector control) at start in units of 1 second.	0.00 to 10.00	0.00	x	B	B	B	B	7 - 41 6 - 29
	DCInj Time @ Start	***Used to stop coasting motor and restart it. When the set value is 0, DC injection braking at start is not performed.								
b2-04	DC injection braking time at stop	Used to set the time to perform DC injection braking (initial excitation for flux vector control) at stop in units of 1 second.	0.00 to 10.00	0.50	x	B	B	B	B	7 - 41 6 - 29
	DCInj Time @ Stop	***Used to prevent coasting after the stop command is input. When the set value is 0.00, DC injection braking at stop is not performed.								

Speed Search: b3

Constant Number	Name	Description	Setting Range	Factory Setting	Change during Operation	Control Methods				Page
	Display					V/f	V/f with PG	Open Loop Vector	Flux Vector	
b3-01	Speed search selection at start	Sets the speed search function to start when the run command is input. 0: Disabled (Starts from the minimum output frequency.) 1: Enabled (Speed search is started from the maximum frequency. In a control method with PG, the motor starts at the frequency of motor rotation when the run command is input.)	0, 1	0 *	x	A	A	A	A	7 - 42
	SpdSrch at Start									
b3-02	Speed search operating current	Sets the speed search operation current as a percentage of the Inverter rated current. *Not usually necessary to set. When restarting is not possible with the set value, reduce the value.	0 to 200	100	x	A	x	A	x	7 - 42
	SpdSrch Current									
b3-03	Speed search deceleration time	Sets the output frequency deceleration time during speed search in 1-second units. *Set the time for deceleration from the maximum output frequency to 0 Hz.	0.1 to 10.0	2.0	x	A	x	A	x	7 - 42
	SpdSrch Dec Time									

* When the control method is changed, the Inverter reverts to factory settings. (The open loop vector control factory settings will be displayed.)

Timer Function: b4

Constant Number	Name	Description	Setting Range	Factory Setting	Change during Operation	Control Methods				Page
	Display					V/f	V/f with PG	Open Loop Vector	Flux Vector	
b4-01	Timer function ON-delay time	Sets the timer function output ON-delay time (dead band) for the timer function input, in 1-second units. *Enabled when the timer function is set for multi-function inputs and outputs.	0.0 to 300.0	0.0	x	A	A	A	A	7 - 43
	Delay-ON Timer									
b4-02	Timer function OFF-delay time	Sets the timer function output OFF-delay time (dead band) for the timer function input, in 1-second units. *Enabled when the timer function is set for multi-function inputs and outputs.	0.0 to 300.0	0.0	x	A	A	A	A	7 - 43
	Delay-OFF Timer									

PID Control: b5

Constant Number	Name	Description	Setting Range	Factory Setting	Change during Operation	Control Methods				Page
	Display					V/f	V/f with PG	Open Loop Vector	Flux Vector	
b5-01	PID control mode selection	0: Disabled 1: Enabled (Deviation is D-controlled.) 2: Enabled (Feedback value is D-controlled.)	0 to 2	0	○	A	A	A	A	7 - 46
	PID Mode									

Constant Number	Name	Description	Setting Range	Factory Setting	Change during Operation	Control Methods				Page
	Display					V/f	V/f with PG	Open Loop Vector	Flux Vector	
b5-02	Proportional gain (P)	Sets P-control proportional gain as a percentage. **P-control is not performed when the setting is 0.00.	0.00 to 25.00	1.00	○	A	A	A	A	7 - 46
	PID Gain									
b5-03	Integral (I) time	Sets I-control integral time in 1-second units. **I-control is not performed when the setting is 0.0.	0.0 to 360.0	1.0	○	A	A	A	A	7 - 46
	PID I Time									
b5-04	Integral (I) limit	Sets the I-control limit as a percentage of the maximum output frequency.	0.0 to 100.0	100.0	○	A	A	A	A	7 - 46
	PID I Limit									
b5-05	Differential (D) time	Sets D-control derivative time in 1-second units. **D-control is not performed when the setting is 0.00.	0.00 to 10.00	0.00	○	A	A	A	A	7 - 46
	PID D Time									
b5-06	PID limit	Sets the limit after PID-control as a percentage of the maximum output frequency.	0.0 to 100.0	100.0	○	A	A	A	A	7 - 46
	PID Limit									
b5-07	PID offset adjustment	Sets the offset after PID-control as a percentage of the maximum output frequency.	-100.0 to +100.0	0.0	○	A	A	A	A	7 - 47
	PID Offset									
b5-08	PID primary delay time constant	Sets the time constant for low pass filter for PID-control outputs in 1-second units. **Not usually necessary to set.	0.00 to 10.0	0.00	○	A	A	A	A	7 - 47
	PID Delay Time									

■ Dwell Functions: b6

Constant Number	Name	Description	Setting Range	Factory Setting	Change during Operation	Control Methods				Page
	Display					V/f	V/f with PG	Open Loop Vector	Flux Vector	
b6-01	Dwell frequency at start	<p>The diagram consists of two vertically aligned graphs. The top graph, labeled 'Run command', shows a pulse that goes from 'OFF' to 'ON' and then back to 'OFF'. The bottom graph, labeled 'Output frequency', shows a ramp-up phase, a horizontal dwell phase, and a ramp-down phase. The dwell phase occurs while the run command is 'ON'. Four parameters are indicated: b6-01 is the dwell frequency level; b6-02 is the dwell time duration; b6-03 is the dwell time at the start of the dwell phase; and b6-04 is the dwell time at the end of the dwell phase.</p>	0.0 to 150.0	0.0	x	A	A	A	A	7 - 49
	Dwell Ref @ Start		0.0 to 10.0	0.0	x	A	A	A	A	7 - 49
b6-02	Dwell time at start		0.0 to 150.0	0.0	x	A	A	A	A	7 - 49
	Dwell Time @ Start		0.0 to 10.0	0.0	x	A	A	A	A	7 - 49
b6-03	Dwell frequency at stop	<p>**The dwell function is used to stop/start the output frequency temporarily when driving a motor with a heavy load.</p>	0.0 to 150.0	0.0	x	A	A	A	A	7 - 49
	Dwell Ref @ Stop		0.0 to 10.0	0.0	x	A	A	A	A	7 - 49
b6-04	Dwell time at stop		0.0 to 150.0	0.0	x	A	A	A	A	7 - 49
	Dwell Time @ Stop		0.0 to 10.0	0.0	x	A	A	A	A	7 - 49

■ **Droop Control: b7**

Constant Number	Name	Description	Setting Range	Factory Setting	Change during Operation	Control Methods				Page
	Display					V/f	V/f with PG	Open Loop Vector	Flux Vector	
b7-01	Droop control gain	Sets the slip as a percentage of maximum frequency when the maximum output frequency is specified and the rated torque occurs. ※Droop-control is not performed when the setting is 0.0.	0.0 to 100.0	0.0	○	x	x	x	A	7 - 17
	Droop Gain									
b7-02	Droop control delay time	Droop control responsiveness constant ※When hunting or oscillation occurs, increase the value.	0.03 to 2.00	0.05	○	x	x	x	A	7 - 17
	Droop Delay Time									

■ **Energy Saving: b8**

Constant Number	Name	Description	Setting Range	Factory Setting	Change during Operation	Control Methods				Page
	Display					V/f	V/f with PG	Open Loop Vector	Flux Vector	
b8-01	Energy-saving gain	Sets the Inverter output voltage when the energy-saving command is input. ※Enabled when the “energy-saving mode” command is set for multi-function input. Set as a percentage of the V/f pattern voltage.	0 to 100	80	x	A	A	x	x	7 - 12 7 - 35
	Energy Save Gain									
b8-02	Energy-saving frequency	Sets the energy-saving effective range minimum frequency in Hz. ※The energy-saving function is only enabled when the frequency is greater than the energy-saving frequency and the speeds are consistent.	0.0 to 150.0	0.0	x	A	A	x	x	7 - 12 7 - 35
	Energy Save Freq									

■ **Zero Servo: b9**

Constant Number	Name	Description	Setting Range	Factory Setting	Change during Operation	Control Methods				Page
	Display					V/f	V/f with PG	Open Loop Vector	Flux Vector	
b9-01	Zero-servo gain	Used to adjust the strength of the zero-servo lock. ※Enabled when the “zero-servo command” is set for the multi-function input. When the zero-servo command has been input and the frequency reference drops below excitation level (b2-01), a position control loop is created and the motor stops. Increasing the zero-servo gain in turn increases the strength of the lock. Increasing it by too much will cause oscillation.	0 to 100	5	x	x	x	x	A	7 - 18
	Zero Servo Gain									

Constant Number	Name	Description	Setting Range	Factory Setting	Change during Operation	Control Methods				Page
	Display					V/f	V/f with PG	Open Loop Vector	Flux Vector	
b9-02	Zero-servo completion width	Sets the output width of the P-lock completion signal. ※Enabled when the “zero-servo completion (end)” is set for a multi-function input. The zero-servo completion signal is ON when the current position is within the range (the zero-servo position + zero-servo completion width.) Set the allowable position displacement from the zero-servo position to 4 times the pulse rate of the PG (pulse generator, encoder) in use.	0 to 16383	10	X	X	X	X	A	7 - 18
	Zero Servo Count									

8.2.2 Autotuning Constants: C

■ Acceleration/Deceleration: C1

Constant Number	Name	Description	Setting Range	Factory Setting	Change during Operation	Control Methods				Page																												
	Display					V/f	V/f with PG	Open Loop Vector	Flux Vector																													
C1-01	Acceleration time 1	Sets the acceleration time to accelerate from 0 to the maximum output frequency, in 1-second units.	0.0 to 6000.0 *	10.0	○	Q	Q	Q	Q	6 - 10 6 - 17																												
	Accel Time 1																																					
C1-02	Deceleration time 1	Sets the deceleration time to decelerate from the maximum output frequency to 0, in 1-second units.								0.0 to 6000.0 *	10.0	○	Q	Q	Q	Q	6 - 10 6 - 17																					
	Decel Time 1																																					
C1-03	Acceleration time 2	The acceleration time when the multi-function input “accel/decel time 1” is set to ON.															0.0 to 6000.0 *	10.0	○	B	B	B	B	6 - 10 6 - 17														
	Accel Time 2																																					
C1-04	Deceleration time 2	The deceleration time when the multi-function input “accel/decel time 1” is set to ON.																						0.0 to 6000.0 *	10.0	○	B	B	B	B	6 - 10 6 - 17							
	Decel Time 2																																					
C1-05	Acceleration time 3	The acceleration time when the multi-function input “accel/decel time 2” is set to ON.																													0.0 to 6000.0 *	10.0	x	A	A	A	A	6 - 10 6 - 17
	Accel Time 3																																					
C1-06	Deceleration time 3	The deceleration time when the multi-function input “accel/decel time 2” is set to ON.																																				0.0 to 6000.0 *
	Decel Time 3																																					
C1-07	Acceleration time 4	The acceleration time when the multi-function input “accel/decel time 1” and “accel/decel time 2” are set to ON.	0.0 to 6000.0 *	10.0	x	A	A	A	A																													
	Accel Time 4																																					
C1-08	Deceleration time 4	The deceleration time when the multi-function input “accel/decel time 1” and “accel/decel time 2” are set to ON.								0.0 to 6000.0 *	10.0	x	A	A	A	A																						
	Decel Time 4																																					
C1-09	Emergency stop time	The deceleration time when the multi-function input “Emergency (fast) stop” is set to ON. ※This function can be used a stopped method when a fault has been detected.															0.0 to 6000.0 *	10.0	x	B	B	B	B															
	Fast Stop Time																																					
C1-10	Accel/decel time setting unit	0: 0.01-second units 1: 0.1-second units																						0.1	1	x	A	A	A	A								
	Acc/Dec Units																																					
C1-11	Accel/decel time switching frequency	Sets the frequency for automatic acceleration/deceleration switching. Below set frequency: Accel/decel time 4 Above set frequency: Accel/decel time 1 ※The multi-function input “accel/decel time 1” or “accel/decel time 2” take priority.																						0.0 to 150.0	0.0	x	A	A	A	A	6 - 11							
	Acc/Dec SW Freq																																					

* The setting range for acceleration/deceleration times will differ according to the setting for C1-10 (the unit for acceleration/deceleration time.) When C1-10 is set to 0, the setting range for acceleration/deceleration times becomes 0.00 to 600.00 seconds.

■ S-curve Acceleration/Deceleration: C2

Constant Number	Name	Description	Setting Range	Factory Setting	Change during Operation	Control Methods				Page
	Display					V/f	V/f with PG	Open Loop Vector	Flux Vector	
C2-01	S-curve characteristic time at acceleration start	<p>All sections of the S-curve characteristic time are set in seconds units.</p> <p>**When the S-curve characteristic time is set, the accel/decel times will increase by only half of the S-curve characteristic times at start and end.</p>	0.0 to 2.50	0.20	x	A	A	A	A	7 - 50
	SCrv Acc @ Start									
C2-02	S-curve characteristic time at acceleration end		0.0 to 2.50	0.20	x	A	A	A	A	7 - 50
	SCrv Acc @ End									
C2-03	S-curve characteristic time at deceleration start	0.00 to 2.50	0.20	x	A	A	A	A	7 - 50	
	SCrv Dec @ Start									
C2-04	S-curve characteristic time at deceleration end	0.00 to 2.50	0.00	x	A	A	A	A	7 - 50	
	SCrv Dec @ End									

■ Motor Slip Compensation: C3

Constant Number	Name	Description	Setting Range	Factory Setting	Change during Operation	Control Methods				Page
	Display					V/f	V/f with PG	Open Loop Vector	Flux Vector	
C3-01	Slip compensation gain	<p>Used to improve speed accuracy when operating with a load.</p> <p>**Usually setting is not necessary. When actual speed is low, increase the set value. When actual speed is high, decrease the set value. In flux vector control mode this function becomes gain to compensate for slip caused by temperature variation.</p>	0.0 to 2.5	1.0 *	○	B	x	B	B	7 - 32 7 - 50
	Slip Comp Gain									
C3-02	Slip compensation primary delay time	<p>Slip compensation primary delay time is set in ms units.</p> <p>**Usually setting is not necessary. Adjust when slip compensation responsiveness is low, or speed is not stabilized.</p> <p>When responsiveness is low, decrease the set value. When speed is not stabilized, increase the set value.</p>	0 to 10000	200 *	x	A	x	A	x	7 - 51
	Slip Comp Time									
C3-03	Slip compensation limit	Sets the slip compensation limit as a percentage of motor rated slip.	0 to 250	200	x	A	x	A	x	7 - 51
	Slip Comp Limit									
C3-04	Slip compensation selection during regeneration	<p>0: Disabled. 1: Enabled.</p> <p>**When the slip compensation during regeneration function has been activated, as regeneration capacity increases momentarily, it may be necessary to use a braking option (Braking Resistor Unit or Braking Unit.)</p>	0, 1	0	x	A	x	A	x	7 - 51
	Slip Comp Regen									

User Constants

8.2.2 Autotuning Constants: C

Constant Number	Name	Description	Setting Range	Factory Setting	Change during Operation	Control Methods				Page
	Display					V/f	V/f with PG	Open Loop Vector	Flux Vector	
C3-05	Flux calculation method	Used to set the flux calculation method. 0: Flux is calculated based on the output frequency after compensation.	0, 1	0	x	x	x	A	x	--
	Flux Select	1: Flux is calculated based on the output frequency before compensation.								

* When the control method is changed, the Inverter reverts to factory settings. (The open loop vector control factory settings will be displayed.)

■ Torque Compensation: C4

Constant Number	Name	Description	Setting Range	Factory Setting	Change during Operation	Control Methods				Page
	Display					V/f	V/f with PG	Open Loop Vector	Flux Vector	
C4-01	Torque compensation gain	Sets torque compensation gain as a ratio. *Usually setting is not necessary. Adjust in the following circumstances: • When the cable is long; increase the set value. • When the motor capacity is smaller than the Inverter capacity (Max. applicable motor capacity), increase the set values. • When the motor is oscillating, decrease the set values.	0.00 to 2.50	1.00	○	B	B	B	x	7 - 52
	Torq Comp Gain	Adjust the output current range at minimum speed rotation so that it does not exceed the Inverter rated output current.								
C4-02	Torque compensation time constant	The torque compensation delay time is set in ms units. *Usually setting is not necessary. Adjust in the following circumstances: • When the motor is oscillating, increase the set values. • When the responsiveness of the motor is low, decrease the set values.	0 to 10000	20 *	x	A	A	A	x	7 - 52
	Torq Comp Time									

* When the control method is changed, the Inverter reverts to factory settings. (The open loop vector control factory settings will be displayed.)

■ Speed Control (ASR): C5

Constant Number	Name	Description	Setting Range	Factory Setting	Change during Operation	Control Methods				Page
	Display					V/f	V/f with PG	Open Loop Vector	Flux Vector	
C5-01	ASR proportional (P) gain 1	Sets the proportional gain of the speed loop (ASR.)	0.00 to 300.00	20.00 *	○	x	B	x	B	6 - 33 6 - 43
	ASR P Gain 1									
C5-02	ASR integral (I) time 1	Sets the integral time of the speed loop (ASR) in 1-second units.	0.000 to 10.000	0.500 *	○	x	B	x	B	6 - 33 6 - 43
	ASR I Time 1									
C5-03	ASR proportional (P) gain 2	**Usually setting is not necessary. Set to change the rotational speed gain.	0.00 to 300.00	20.00 *	○	x	B	x	B	6 - 33 6 - 43
	ASR P Gain 2									
C5-04	ASR integral (I) time 2		0.000 to 10.000	0.500 *	○	x	B	x	B	6 - 33 6 - 43
	ASR I Time 2									
C5-05	ASR limit	Sets the upper limit for the compensation frequency for the speed control loop (ASR) to a percentage of the maximum output frequency.	0.0 to 20.0	5.0	x	x	A	x	x	6 - 45
	ASR Limit									
C5-06	ASR primary delay time	Sets the filter time constant; the time from the speed loop to the torque command output, in units of 1-second.	0.000 to 0.500	0.004	x	x	x	x	A	6 - 35
	ASR Delay Time									
C5-07	ASR switching frequency	Sets the frequency for switching between Proportion Gain 1, 2 and Integral Time 1, 2 in Hz units.	0.0 to 150.0	0.0	x	x	x	x	A	6 - 33
	ASR Gain SW Freq									
C5-08	ASR integral (I) limit	Set to a small value to prevent any radical load change. Set to 100% of the maximum output frequency.	0 to 400	400	x	x	x	x	A	--
	ASR I Limit									

* When the control method is changed, the Inverter reverts to factory settings. (The open loop vector control factory settings will be displayed.)

■ Carrier Frequency: C6

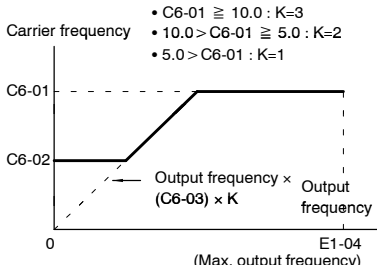
Constant Number	Name	Description	Setting Range	Factory Setting	Change during Operation	Control Methods				Page
	Display					V/f	V/f with PG	Open Loop Vector	Flux Vector	
C6-01	Carrier Frequency Upper Limit	Set the carrier frequency upper limit and lower limit in kHz units. (See note 2) The carrier frequency gain is set as follows: ※ In vector control mode, the upper limit of the carrier frequency is fixed at C6-01	2.0	2.0	x	B	B	B	B	7 - 53
	Carrier Freq Max									
C6-02	Carrier Frequency Lower Limit	Carrier frequency • C6-01 ≥ 10.0 : K=3 • 10.0 > C6-01 ≥ 5.0 : K=2 • 5.0 > C6-01 : K=1	0.4 to 2.0	2.0	x	A	A	x	x	7 - 53
	Carrier Freq Min									
C6-03	Carrier Frequency Gain		00 to 99	0	x	A	A	x	x	7 - 53
	Carrier Gain									

■ Hunting Prevention: C7

Constant Number	Name	Description	Setting Range	Factory Setting	Change during Operation	Control Methods				Page
	Display					V/f	V/f with PG	Open Loop Vector	Flux Vector	
C7-01	Hunting prevention selection	0: Disabled 1: Enabled ※ The hunting prevention function is used to stop a motor under a light load from hunting. This function is exclusively for the V/f control mode. When greater responsiveness than oscillation control is required, set hunting prevention to “disabled.”	0, 1	1	x	A	A	x	x	7 - 12
	Hunt Prev Select									
C7-02	Hunting prevention gain	Sets the ratio for hunting prevention gain. ※ Usually setting is not necessary. Adjust in the following circumstances: • When oscillation occurs due to a light load, increase the set values. • When the motor is stalled, decrease the set values. If the set values become too large, the motor may stall as a result of non-controlled current.	0.00 to 2.50	1.00	x	A	A	x	x	7 - 13
	Hunt Prev Gain									

■ Factory Tuning: C8

Constant Number	Name	Description	Setting Range	Factory Setting	Change during Operation	Control Methods				Page
	Display					V/f	V/f with PG	Open Loop Vector	Flux Vector	
C8-08	AFR gain	Sets the internal speed feedback detection control section as a ratio. ※Usually setting is not necessary. Adjust in the following circumstances: <ul style="list-style-type: none"> • When hunting occurs, increase the set values. • When responsiveness is low, decrease the set values. Change the responsiveness in 0.05 units at a time, checking after each change.	0.00 to 10.00	1.00	x	x	x	A	x	7 - 5
	AFR Gain									
C8-09	Speed Feedback Detection Limit (ARF) Time	<ul style="list-style-type: none"> • Increase setting if hunting occurs. • Decrease setting if response is poor. 	0 to 2000	50	x	x	x	A	x	--
	AFR Time									
C8-30	Carrier frequency selection during auto-tuning	0: Carrier frequency is set to 2.0 kHz. 1: Carrier frequency is set to a value as set in C6-01.	0, 1	0	x	x	x	A	x	--
	Carrier in tune									

8.2.3 Reference Constants: d

■ Preset Reference: d1

Constant Number	Name	Description	Setting Range	Factory Setting	Change during Operation	Control Methods				Page	
	Display					V/f	V/f with PG	Open Loop Vector	Flux Vector		
d1-01	Frequency reference 1	Sets the frequency reference in the units used in o1-03 (frequency reference display/set units.) The factory setting unit for o1-03 is Hz.	0 to 150.00	0.00	○	Q	Q	Q	Q	6 - 7	
	Reference 1										
d1-02	Frequency reference 2	The frequency reference when the multi-function input “multi-step speed reference 1” is ON.		0.00	○	Q	Q	Q	Q	Q	6 - 7
	Reference 2										
d1-03	Frequency reference 3	The frequency reference when the multi-function input “multi-step speed reference 2” is ON.		0.00	○	Q	Q	Q	Q	Q	6 - 7
	Reference 3										
d1-04	Frequency reference 4	The frequency reference when the multi-function input “multi-step speed reference 1, 2” is ON.		0.00	○	Q	Q	Q	Q	Q	6 - 8
	Reference 4										
d1-05	Frequency reference 5	The frequency reference when the multi-function input “multi-step speed reference 3” is ON.		0.00	○	B	B	B	B	B	6 - 8
	Reference 5										
d1-06	Frequency reference 6	The frequency reference when the multi-function input “multi-step speed reference 1, 3” is ON.	0.00	○	B	B	B	B	B	6 - 8	
	Reference 6										
d1-07	Frequency reference 7	The frequency reference when the multi-function input “multi-step speed reference 2, 3” is ON.	0.00	○	B	B	B	B	B	6 - 8	
	Reference 7										
d1-08	Frequency reference 8	The frequency reference when the multi-function input “multi-step speed reference 1, 2, 3” is ON.	0.00	○	B	B	B	B	B	6 - 8	
	Reference 8										
d1-09	Jog frequency reference	The frequency reference when the multi-function inputs, “Jog frequency reference selection,” “FJOG command,” and “RJOG command” are ON.	6.00	○	Q	Q	Q	Q	Q	6 - 8	
	Jog Reference										

■ Reference Limits: d2

Constant Number	Name	Description	Setting Range	Factory Setting	Change during Operation	Control Methods				Page
	Display					V/f	V/f with PG	Open Loop Vector	Flux Vector	
d2-01	Frequency reference upper limit	Sets the output frequency upper limit as a percentage of the maximum output frequency.	0.0 to 110.0	100.0	x	B	B	B	B	7 - 54
	Ref Upper Limit									
d2-02	Frequency reference lower limit	Sets the output frequency lower limit as a percentage of the maximum output frequency.	0.0 to 109.0	0.0	x	B	B	B	B	7 - 54
	Ref Lower Limit									

■ Jump Frequencies: d3

Constant Number	Name	Description	Setting Range	Factory Setting	Change during Operation	Control Methods				Page
	Display					V/f	V/f with PG	Open Loop Vector	Flux Vector	
d3-01	Jump frequency 1	Set the center values of the jump frequencies in Hz. ※This function is disabled by setting the jump frequency to 0 Hz. Always ensure that the following applies: $d3-01 \geq d3-02 \geq d3-03$ Operation in the jump frequency range is prohibited but during acceleration and deceleration, speed changes smoothly without jump.	0.0 to 150.0	0.0	x	B	B	B	B	7 - 54
	Jump Freq 1									
d3-02	Jump frequency 2									
	Jump Freq 2									
d3-03	Jump frequency 3		0.0	x	B	B	B	B	7 - 54	
	Jump Freq 3									
d3-04	Jump frequency width	Sets the jump frequency bandwidth in Hz. ※The jump frequency will be the jump frequency \pm d3-04.	0.0 to 20.0	1.0	x	B	B	B	B	7 - 54
	Jump Bandwidth									

■ Reference Frequency Hold: d4

Constant Number	Name	Description	Setting Range	Factory Setting	Change during Operation	Control Methods				Page
	Display					V/f	V/f with PG	Open Loop Vector	Flux Vector	
d4-01	Frequency reference hold function selection	Sets whether or not frequencies on hold will be recorded. 0: Disabled (when operation is stopped or the power is turned on again starts at 0.) 1: Enabled (when operation is stopped or the power is turned on again starts at the previous hold frequency.) ※This function is available when the multi-function inputs "accel/decel Ramp Hold" or "up/down" commands are set.	0, 1	0	x	A	A	A	A	7 - 55
	MOP Ref Memory									
d4-02	+ - Speed limits	Sets the increase/decrease frequency for analog frequency references as a percentage of the maximum output frequency. ※This function is available when the multi-function inputs "Trim Ctl Increase" or "Trim Ctl Decrease" is set.	0 to 100	25	x	A	A	A	A	7 - 55
	Trim Control Lvl									

■ Torque Control: d5

Constant Number	Name	Description	Setting Range	Factory Setting	Change during Operation	Control Methods				Page
	Display					V/f	V/f with PG	Open Loop Vector	Flux Vector	
d5-01	Torque control selection	0: Speed control (C5-01 to C5-07) 1: Torque control ※This function is only available in flux vector control mode. To use the function for switching between speed and torque control, set to 0 and set the multi-function input to "speed/torque control change."	0, 1	0	x	x	x	x	A	7 - 19 7 - 26
	Torq Control Sel									

User Constants

8.2.3 Reference Constants: d

Constant Number	Name	Description	Setting Range	Factory Setting	Change during Operation	Control Methods				Page
	Display					V/f	V/f with PG	Open Loop Vector	Flux Vector	
d5-02	Torque reference delay time	Sets the torque reference delay time in ms units. ※This function can be used to adjust the noise of the torque control signal or the responsiveness with the host controller. When oscillation occurs during torque control, increase the set value.	0 to 1000	0	x	x	x	x	A	7 - 24
	Torq Ref Filter									
d5-03	Speed limit selection	Sets the speed limit command method for the torque control mode. 1: The analog input limit from an analog frequency reference terminal (terminals 13 and 14.) 2: Limited by d5-04 constant setting values.	1, 2	1	x	x	x	x	A	7 - 21
	Speed Limit Sel									
d5-04	Speed limit	Sets the speed limit during torque control as a percentage of the maximum output frequency. ※This function is enabled when d5-03 is set to 2. Directions are as follows. +: operation command direction -: operation command opposite direction	-120 to +120	0	x	x	x	x	A	7 - 21
	Speed Lmt Value									
d5-05	Speed limit bias	Sets the speed limit bias as a percentage of the maximum output frequency. ※Bias is given to the specified speed limit. It can be used to adjust the margin for the speed limit.	0 to 120	10	x	x	x	x	A	7 - 23
	Speed Lmt Bias									
d5-06	Speed/torque control switching timer	Sets the delay time from inputting the multi-function input "speed/torque control change" (from ON to OFF or OFF to ON) until the control is actually changed, in ms units. ※This function is enabled when the multi-function input "speed/torque control change" is set. In the speed/torque control switching timer, the three analog inputs hold the values of when the "speed/torque control change" changes. Always be sure to allow time for this process to finish completely.	0 to 1000	0	x	x	x	x	A	7 - 26
	Ref Hold Time									

8.2.4 Motor Constant Constants: E

■ V/f Pattern: E1

Constant Number	Name	Description	Setting Range	Factory Setting	Change during Operation	Control Methods				Page	
	Display					V/f	V/f with PG	Open Loop Vector	Flux Vector		
E1-01	Input voltage setting	Sets the Inverter input voltage in units of 1 V. **This setting is used as the reference value for functions such as the protection functions.	360 to 460 *1	400 *1	x	Q	Q	Q	Q	6 - 18 6 - 21 6 - 31 6 - 39	
	Input Voltage										
E1-02	Motor selection	0: Standard fan-cooled motor (general-purpose motor) 1: Standard blower-cooled motor (Inverter-exclusive motor) **This setting is used as the reference value for functions such as the protection functions.	0, 1	0	x	Q	Q	Q	Q	6 - 21 6 - 39	
	Motor Selection										
E1-03	V/f pattern selection	0 to E: Select from the 15 preset patterns. F: Custom user-set patterns (Applicable for settings E1-04 to E1-10.)	0 to F	F	x	Q	Q	x	x	6 - 22	
	V/F Selection										
E1-04	Max. output frequency	<p>Output voltage (V)</p> <p>VMAX □E1-05□ (V BASE) □E1-13□</p> <p>VC □E1-08□ □</p> <p>VMIN □E1-10□</p> <p>Frequency (Hz)</p> <p>FMIN □E1-09□ FB □E1-07□ FA □E1-06□ FMAX □E1-04□</p>	50.0 to 150.0	60.0	x	Q	Q	Q	Q	6 - 24	
	Max Frequency										
E1-05	Max. voltage		0.0 to 510.0 *1	400.0 *1	x	Q	Q	Q	Q	Q	6 - 24
	Max Voltage										
E1-06	Base frequency		0.0 to 150.0	60.0	x	Q	Q	Q	Q	Q	6 - 24
	Base Frequency										
E1-07	Mid. output frequency		0.0 to 150.0	3.0 *2	x	Q	Q	A	x	6 - 24	
	Mid Frequency A										
E1-08	Mid. output frequency voltage		<p>**To set V/f characteristics in a straight line, set the same values for E1-07 and E1-09. In this case, the setting for E1-08 will be disregarded.</p> <p>Always ensure that the four frequencies are set in the following manner: E1-04 (FMAX) ≥ E1-06 (FA) > E1-07 (FB) ≥ E1-09 (FMIN)</p>	0.0 to 510.0 *1	22.0 *1 *2	x	Q	Q	A	x	6 - 24
	Mid Voltage A										
E1-09	Min. output frequency			0.0 to 150.0	0.5 *2	x	Q	Q	Q	A	6 - 24
	Min Frequency										
E1-10	Min. output frequency voltage			0.0 to 510.0 *1	4.0 *1 *2	x	Q	Q	A	x	6 - 24
	Min Voltage										
E1-11	Mid. output frequency 2	0.0 to 150.0		0.0 *3	x	A	A	A	A	--	
	Mid Frequency B										
E1-12	Mid. output frequency voltage 2	Set only to fine-adjust V/f for the output range when using flux vector control. Normally, this setting is not required.		0.0 to 510.0 *1	0.0 *3	x	A	A	A	A	--
	Mid Voltage B										
E1-13	Base voltage	0.0 to 510.0 *1		0.0 *4	x	A	A	Q	Q	6 - 24	
	Base Voltage										

User Constants

8.2.4 Motor Constant Constants: E

- * 1. These are values for a 400-V class Inverter. Multiply the values by approx. 1.5 for the 575-V class Inverter.
- * 2. When the control method is changed, the Inverter reverts to factory settings. (The open loop vector control factory settings will be displayed.)
- * 3. E1-11 and E1-12 are disregarded when set to 0.0.
- * 4. E1-13 is set to the same value as E1-05 by autotuning.

■ Motor Setup: E2

Constant Number	Name	Description	Setting Range	Factory Setting	Change during Operation	Control Methods				Page
	Display					V/f	V/f with PG	Open Loop Vector	Flux Vector	
E2-01	Motor rated current	Sets the motor rated current in 1 A units. **These set values will become the reference values for motor protection, torque limits and torque control. These values will automatically be set if they were set during autotuning.	37.0 to 740.0 *2	370.0 *1	x	Q	Q	Q	Q	6 - 21 6 - 39
	Motor Rated FLA									
E2-02	Motor rated slip	Sets the motor rated slip in Hz units. **These set values will become the reference values for slip compensation. These values will be automatically set during autotuning.	0.00 to 20.00	1.30 *1	x	A	A	Q	Q	7 - 13 7 - 30
	Motor Rated Slip									
E2-03	Motor no-load current	Sets the motor no-load current in 1 A units. **These values will be automatically set during autotuning.	0.00 to 2000.0	96.0 *1	x	A	A	Q	Q	7 - 13 7 - 31
	No-Load Current									
E2-04	Number of motor poles	Sets the number of motor poles. **These values will automatically be set during autotuning.	2 to 48	4	x	x	Q	x	Q	6 - 39 7 - 31
	Number of Poles									
E2-05	Motor line-to-line resistance	Sets the motor phase-to-phase resistance in Ω units. **These values will be automatically set during autotuning.	0.000 to 65.000	0.020 *1	x	A	A	A	A	7 - 13 7 - 31
	Term Resistance									
E2-06	Motor leak inductance	Sets the voltage drop due to motor leakage inductance as a percentage of the motor rated voltage. **These values will be automatically set during autotuning.	0.0 to 30.0	5.0	x	x	x	A	A	7 - 9 7 - 31
	Leak Inductance									
E2-07	Motor iron-core saturation coefficient 1	Sets the motor iron-core saturation coefficient at 50% of magnetic flux. **These values will be automatically set during autotuning.	0.00 to 0.50	0.50	x	x	x	A	A	7 - 9 7 - 32
	Saturation Comp 1									
E2-08	Motor iron-core saturation coefficient 2	Sets the motor iron-core saturation coefficient at 75% of magnetic flux. **These values will be automatically set during autotuning.	0.00 to 0.75	0.75	x	x	x	A	A	7 - 9 7 - 32
	Saturation Comp 2									
E2-09	Motor mechanical loss	Sets motor mechanical loss as a percentage of motor rated output (W). **Usually setting is not necessary. Adjust in the following circumstances: • When torque loss is large due to motor bearing. • When the torque loss in the pump or fan is large. The set mechanical loss will compensate for torque.	0.0 to 10.0	0.0	x	x	x	x	A	7 - 32
	Mechanical Loss									

- * 1. The factory setting depends upon the Inverter capacity. The values for a 400-V class Inverter of 200 kW will be displayed. See page 8 - 42.
- * 2. The setting range is 10% to 200% of the Inverter’s rated output current. The values for a 400-V class Inverter of 200 kW will be displayed.

Motor 2 Control Method: E3

Constant Number	Name	Description	Setting Range	Factory Setting	Change during Operation	Control Methods				Page
	Display					V/f	V/f with PG	Open Loop Vector	Flux Vector	
E3-01	Motor 2 control method selection	0: V/f control	0 to 2	2	x	A	x	A	x	--
	Control Method	1: Open loop vector								

Motor 2 V/f Pattern: E4

Constant Number	Name	Description	Setting Range	Factory Setting	Change during Operation	Control Methods				Page
	Display					V/f	V/f with PG	Open Loop Vector	Flux Vector	
E4-01	Motor 2 max. output frequency	<p>Output voltage (V)</p> <p>VMAX (E4-02)</p> <p>VC (E4-05)</p> <p>VMIN (E4-07)</p> <p>FMIN (E4-06) FB (E4-04) FA (E4-03) FMAX (E4-01)</p> <p>Frequency (Hz)</p> <p>***To set V/f characteristics in a straight line, set the same values for E4-04 and E4-06. In this case, the setting for E4-05 will be disregarded. Always ensure that the four frequencies are set in the following manner: E4-01 (FMAX) ≥ E4-03 (FA) > E4-04 (FB) ≥ E4-06 (FMIN)</p>	50.0 to 150.0	60.0	x	A	x	A	x	6 - 24
	V/F2 Max Freq									
E4-02	Motor 2 max. voltage		0.0 to 510.0 *1	400 *1	x	A	x	A	x	6 - 24
	V/F2 Max Voltage									
E4-03	Motor 2 max. voltage frequency		0.0 to 150.0	60.0	x	A	x	A	x	6 - 24
	V/F2 Base Freq									
E4-04	Motor 2 mid. output frequency 1		0.0 to 150.0	3.0 *2	x	A	x	A	x	6 - 24
	V/F2 Mid Freq									
E4-05	Motor 2 mid. output frequency voltage 1	0.0 to 510.0 *1	22.0 *1	x	A	x	A	x	6 - 24	
	V/F2 Mid Voltage									
E4-06	Motor 2 min. output frequency	0.0 to 150.0	0.5 *2	x	A	x	A	x	6 - 24	
	V/F2 Min Freq									
E4-07	Motor 2 min. output frequency voltage	0.0 to 510.0 *1	4.0 *1	x	A	x	A	x	6 - 24	
	V/F2 Min Voltage									

- * 1. These are values for a 400-V class Inverter. Multiply the values by approx. 1.5 for the 575-V class Inverter.
- * 2. When the control method is changed, the Inverter reverts to factory settings. (The open loop vector control factory settings will be displayed.)

■ **Motor 2 Setup: E5**

Constant Number	Name	Description	Setting Range	Factory Setting	Change during Operation	Control Methods				Page
	Display					V/f	V/f with PG	Open Loop Vector	Flux Vector	
E5-01	Motor 2 rated current	Sets the motor rated current in 1 A units. **These set values will become the reference values for motor protection, torque limits and torque control. These values will automatically be set if they were set during autotuning.	37.0 to 740.0 *2	370.0 *1	X	A	X	A	X	7 - 8
	Motor 2 rated FLA									
E5-02	Motor 2 rated slip	Sets the motor rated slip in Hz units. **These set values will become the reference values for slip compensation. These values will be automatically set during autotuning.	0.00 to 20.00	1.30 *1	X	A	X	A	X	7 - 8
	Motor 2 Slip Freq									
E5-03	Motor 2 no-load current	Sets the motor no-load current in 1 A units. **These values will be automatically set during autotuning.	0.00 to 2000.0	96.0 *1	X	A	X	A	X	7 - 8
	Motor 2 No-load 1									
E5-04	Motor 2 number of poles	Sets the number of motor poles. **These values will automatically be set during autotuning.	2 to 48	4	X	X	X	X	X	---
	Motor 2 # Poles									
E5-05	Motor 2 line-to-line resistance	Sets the motor phase-to-phase resistance in Ω units. **These values will be automatically set during autotuning.	0.000 to 65.000	0.020 *1	X	A	X	A	X	7 - 8
	Motor 2 term Ohms									
E5-06	Motor 2 leak inductance	Sets the voltage drop due to motor leakage inductance as a percentage of the motor rated voltage. **These values will be automatically set during autotuning.	0.0 to 30.0	5.0 *1	X	X	X	A	X	7 - 9
	Motor 2 Leak									

* 1. The factory setting depends upon the Inverter capacity. The values for a 400-V class Inverter of 200 kW will be displayed. See page 8 - 42.

* 2. The setting range is 10% to 200% of the Inverter's rated output current. The values for a 400-V class Inverter of 200 kW will be displayed.

8.2.5 Options Constants: F

■ PG Option Setup: F1

Constant Number	Name	Description	Setting Range	Factory Setting	Change during Operation	Control Methods				Page
	Display					V/f	V/f with PG	Open Loop Vector	Flux Vector	
F1-01	PG constant	Sets the number of PG (pulse generator or encoder) pulses.	0 to 60000	600	x	x	Q	x	Q	6 - 26 6 - 41
	PG Pulse/Rev	**Sets the number of pulses per motor revolution.								
F1-02	Operation selection at PG open circuit	Sets the PG disconnection stopping method. 0: Ramp to stop (Deceleration stop using deceleration time 1, C1-02.) 1: Coast to stop 2: Fast stop (Emergency stop using the fast-stop time, C1-09.) 3: Continue operation (PGO is displayed, and continues operation.)	0 to 3	1	x	x	B	x	B	6 - 27 6 - 42
	PG Fdbk Loss Sel									
F1-03	Operation selection at overspeed	Sets the stopping method when an overspeed (os) fault occurs. 0: Ramp to stop (Deceleration stop using deceleration time 1, C1-02.) 1: Coast to stop 2: Fast stop (Emergency stop using the fast-stop time, C1-09.) 3: Continue operation (OS is displayed, and continues operation.)	0 to 3	1	x	x	B	x	B	6 - 28 6 - 42
	PG Overspeed Sel									
F1-04	Operation selection at deviation	Sets the stopping method when a speed deviation (DEV) fault occurs. 0: Ramp to stop (Deceleration stop using deceleration time 1, C1-02.) 1: Coast to stop 2: Fast stop (Emergency stop using the fast-stop time, C1-09.) 3: Continue operation (DEV is displayed and continues operation.)	0 to 3	3	x	x	B	x	B	6 - 28 6 - 42
	PG Deviation Sel									
F1-05	PG rotation	0: Phase A leads with forward run command. (Phase B leads with reverse run command.) 1: Phase B leads with forward run command. (Phase A leads with reverse run command.)	0, 1	0	x	x	B	x	B	6 - 26
	PG Rotation Sel									
F1-06	PG division rate (PG pulse monitor)	Sets the division ratio for the PG speed control card pulse output. Division ratio = (1 + n) / m (n=0,1 m=1 to 32) F1-06 = $\frac{\square\square}{n\ m}$	1 to 132	1	x	x	B	x	B	6 - 27
	PG Output Ratio	**This constant is only effective when a PG-B2 is used. The possible division ratio settings are: $1/32 \leq F1-06 \leq 1$.								
F1-07	Integral value during accel/decel enable/disable	Sets integral control during acceleration/deceleration to either enabled or disabled. 0: Disabled (The integral function isn't used while accelerating or decelerating; it is used at constant speeds.) 1: Enabled (The integral function is used at all times.)	0, 1	0	x	x	B	x	x	6 - 41
	PG Ramp PI Sel									
F1-08	Overspeed detection level	Sets the overspeed detection method. Frequencies above that set for F1-08 (set as a percentage of the maximum output frequency), which continue to exceed this frequency for the detection time (F1-09), are detected as overspeed faults.	0 to 120	115	x	x	A	x	A	6 - 28 6 - 42
	PG Overspd level									
F1-09	Overspeed detection delay time		0.0 to 2.0	0.0 *	x	x	A	x	A	6 - 28 6 - 42
	PG Overspd Time									

User Constants

8.2.5 Options Constants: F

Constant Number	Name	Description	Setting Range	Factory Setting	Change during Operation	Control Methods				Page
	Display					V/f	V/f with PG	Open Loop Vector	Flux Vector	
F1-10	Excessive speed deviation detection level	Sets the speed deviation detection method. Any speed deviation above the F1-10 set level (set as a percentage of the maximum output frequency), which continues for the deviation detection time (F1-11) is detected as a speed deviation. **Speed deviation is the difference between actual motor speed and the reference command speed.	0 to 50	10	x	x	A	x	A	6 - 28 6 - 42
	PG Deviate Level									
F1-11	Excessive speed deviation detection delay time	**Speed deviation is the difference between actual motor speed and the reference command speed.	0.0 to 10.0	0.5	x	x	A	x	A	6 - 28 6 - 42
	PG Deviate Time									
F1-12	Number of PG gear teeth 1	Sets the number of teeth on the gears if there are gears between the PG and the motor. Motor speed (r/min) $= \frac{\text{Load gear teeth}}{\text{No. of pulses input PG} \times 60} \times \frac{\text{F1-13}}{\text{F1-12}}$ *A gear ratio of 1 will be used if either of these constants is set to 0.	0 to 1000	0	x	x	A	x	x	6 - 41
	PG# Gear Teeth 1									
F1-13	Number of PG gear teeth 2	*A gear ratio of 1 will be used if either of these constants is set to 0.	0 to 1000	0	x	x	A	x	x	6 - 41
	PG# Gear Teeth 2									
F1-14	PG open-circuit detection time	Used to set the PG disconnection detection time. PGO will be detected if the detection time continues beyond the set time.	0.0 to 10.0	2.0	x	x	A	x	A	6 - 27
	PGO Time									

* The setting range will change when the control method is changed. (The setting range for Open loop vector control will be displayed.)

■ Other Options Setup: F2 through F9

F2: Analog Reference Card

F3: Digital Reference Card

F4: Analog Monitor Card

F5: DO-02 Digital Output Card

F6: DO-08 Digital Output Card

F7: Pulse Monitor Card

F8: SI-F/G

F9: DOS/SI-B

Constant Number	Name	Description	Setting Range	Factory Setting	Change during Operation	Control Methods				Page
	Display					V/f	V/f with PG	Open Loop Vector	Flux Vector	
F2-01	Bi-polar or uni-polar input selection	Sets the functions for channel 1 to 3 which are effective when the AI-14B Analog Reference Card is used. 0: 3-channel individual (Channel 1: terminal 13, Channel 2: terminal 14, Channel 3: terminal 16) 1: 3-channel addition (Addition values are the frequency reference) **When set to 0, select 1 for b1-01. In this case the multi-function input "Option/Inverter selection" cannot be used.	0, 1	0	x	B	B	B	B	7 - 58
	AI-14 Input Sel									
F3-01	Digital input option	Sets the Digital Reference Card input method. 0: BCD 1% unit 1: BCD 0.1% unit 2: BCD 0.01% unit 3: BCD 1 Hz unit 4: BCD 0.1 Hz unit 5: BCD 0.01 Hz unit 6: BCD special setting (5-digit input) 7: Binary input **6 is only effective when the DI-16H2 is used.	0 to 7	0	x	B	B	B	B	7 - 58
	DI Input									
F4-01	Channel 1 monitor selection	Effective when the Analog Monitor Card is used. Monitor selection: Set the number of the monitor item to be output. (U1-□□)	1 to 33	2	x	B	B	B	B	7 - 59
	AO Ch1 Select									
F4-02	Channel 1 gain	Gain: Set the multiple of 10 V for outputting monitor items. **4, 10, 11, 12, 13, 14, 25, 28 cannot be set. 29 to 31 are not used. When the AO-12 is used outputs of ± 10 V are possible. In this case, set H4-07 (select multi-function analog output signal level) to 1. When the AO-08 is used, only outputs of 0 to +10 V are possible.	0.00 to 2.50	1.00	○	B	B	B	B	7 - 59
	AO Ch1 Gain									
F4-03	Channel 2 monitor selection	Effective when the Analog Monitor Card is used. Monitor selection: Set the number of the monitor item to be output. (U1-□□)	1 to 33	3	x	B	B	B	B	7 - 59
	AO Ch2 Select									
F4-04	Channel 2 gain	Gain: Set the multiple of 10 V for outputting monitor items. **4, 10, 11, 12, 13, 14, 25, 28 cannot be set. 29 to 31 are not used. When the AO-12 is used outputs of ± 10 V are possible. In this case, set H4-07 (select multi-function analog output signal level) to 1. When the AO-08 is used, only outputs of 0 to +10 V are possible.	0.00 to 2.50	0.50	○	B	B	B	B	7 - 59
	AO Ch2 Gain									
F5-01	Channel 1 output selection	Effective when a Digital Output Card is used. Set the number of the multi-function output to be output.	0.0 to 37	0	x	B	B	B	B	7 - 59
	DO-02 Ch1 Select									
F5-02	Channel 2 output selection	Effective when a Digital Output Card is used. Set the number of the multi-function output to be output.	0.0 to 37	1	x	B	B	B	B	7 - 59
	DO-02 Ch2 Select									

User Constants

8.2.6 Terminal Constants: H

Constant Number	Name	Description	Setting Range	Factory Setting	Change during Operation	Control Methods				Page
	Display					V/f	V/f with PG	Open Loop Vector	Flux Vector	
F6-01	Output mode selection	Effective when a DO-08 Digital Output Card is used. Set the output mode. 0: 8-channel individual outputs 1: Binary code output	0, 1	0	x	B	B	B	B	7 - 60
	DO-08 Selection									
F7-01	Frequency multiple selection	Effective when the Pulse Monitor Card is used. Sets the number of output pulses. 0: 1F, 1: 6F, 2: 10F, 3: 12F, 4: 36F *F= the output frequency displayed in Hz. Example: When 0 (1F) is set, and the output frequency is 60 Hz, 60 pulses per second are output. (50% duty)	0 to 4	1	x	B	B	B	B	7 - 61
	PO-36F Selection									
F8-01	Optical option (SI-F/G)	0: Deceleration to stop 1: Coast to stop 2: Emergency stop 3: Continue operation	0 to 3	1	○	B	B	B	B	--
	E-15 Det Sel									
F9-01	External fault input level from Optical option	0: NO contact 1: NC contact	0, 1	0	x	B	B	B	B	--
	E-15 Selection									
F9-02	External fault from Optical option	0: Always detect 1: Detect during operation	0, 1	0	x	B	B	B	B	--
	EFO Detection									
F9-03	Action for external fault from Optical option	0: Deceleration to stop 1: Coast to stop 2: Emergency stop 3: Continue operation	0 to 3	1	x	B	B	B	B	--
	EFO Fault Act									
F9-04	Optical option trace sampling time	--	0 to 60000	0	x	B	B	B	B	--
	Trace Sample Time									

8.2.6 Terminal Constants: H

■ Multi-function Inputs: H1

Constant Number	Name	Display	Setting Range	Factory Setting	Change during Operation	Control Methods				Page
						V/f	V/f with PG	Open Loop Vector	Flux Vector	
H1-01	Multi-function input 1 (terminal 11)	Terminal 11 Sel	0 to 77	24	x	B	B	B	B	7 - 63
H1-02	Multi-function input 2 (terminal 12)	Terminal 12 Sel	0 to 77	14	x	B	B	B	B	7 - 63
H1-03	Multi-function input 3 (terminal 13)	Terminal 13 Sel	0 to 77	3 (0) *	x	B	B	B	B	7 - 63
H1-04	Multi-function input 4 (terminal 14)	Terminal 14 Sel	0 to 77	4 (3) *	x	B	B	B	B	7 - 63
H1-05	Multi-function input 5 (terminal 15)	Terminal 15 Sel	0 to 77	6 (4) *	x	B	B	B	B	7 - 63
H1-06	Multi-function input 6 (terminal 16)	Terminal 16 Sel	0 to 77	8 (6) *	x	B	B	B	B	7 - 63

* The values in parentheses indicate initial values when initialized in 3-wire sequence.

Multi-function Input Functions

Setting value	Function	Control Methods				Page
		V/f	V/f w/ PG	Open loop vector	Flux vector	
0	3-wire sequence (Forward/Reverse run command)	○	○	○	○	6 - 14
1	Local/Remote selection (ON: Operator, OFF: Constant setting)	○	○	○	○	7 - 63
2	Option/Inverter selection (ON: Option card)	○	○	○	○	7 - 63
3	Multi-step speed reference 1 When H3-05 is set to "0," this function is combined with "Master/auxiliary speed switch."	○	○	○	○	6 - 14
4	Multi-step speed reference 2	○	○	○	○	6 - 14
5	Multi-step speed reference 3	○	○	○	○	6 - 14
6	Jog frequency reference (higher priority than multi-step speed reference)	○	○	○	○	6 - 14
7	Accel/Decel time 1	○	○	○	○	6 - 17
8	External baseblock NO (NO contact: Baseblock at ON)	○	○	○	○	7 - 64
9	External baseblock NC (NC contact: Baseblock at OFF)	○	○	○	○	7 - 64
A	Accel/Decel ramp hold (ON: Accel/decel stopped, frequency on hold)	○	○	○	○	7 - 64
B	OH2 alarm signal input (ON: OH2 will be displayed)	○	○	○	○	7 - 65
C	Multi-function analog input selection (ON: Enable)	○	○	○	○	7 - 65
D	No V/f control with PG (ON: Speed feedback control disabled,) (normal V/f control)	○	○	x	x	7 - 65
E	Speed control integral reset (ON: Integral control disabled)	x	○	x	○	7 - 65
F	Not used. (Do not input this setting.)	-	-	-	-	-
10-	Up command (Always set with the down command)	○	○	○	○	7 - 67
11	Down command (Always set with the up command)	○	○	○	○	7 - 67
12	FJOG command (ON: Forward run at jog frequency d1-09)	○	○	○	○	6 - 17
13	RJOG command (ON: Reverse run at jog frequency d1-09)	○	○	○	○	6 - 17
14	Fault reset (Reset when turned ON)	○	○	○	○	7 - 68
15	Emergency stop (ON: Deceleration to stop in emergency stop time C1-09)	○	○	○	○	6 - 17
16	Motor switch command (Motor 2 selection)	○	-	○	-	7 - 68
18	Timer function input (Functions are set with b4-01, b4-02 and the timer function is set at the same time)	○	○	○	○	7 - 43
19	PID control disable (ON: PID control disabled)	○	○	○	○	7 - 69
1A	Accel/Decel time 2	○	○	○	○	6 - 17
1B	Constants write enable (ON: All constants can be written-in. OFF: All constants other than frequency monitor are write protected.)	○	○	○	○	7 - 69
1C	Trim control increase (ON: d4-02 frequencies are added to analog frequency references.)	○	○	○	○	7 - 69
1D	Trim control decrease (ON: d4-02 frequencies are subtracted from analog frequency references.)	○	○	○	○	7 - 69
1E	Analog frequency reference sample/hold	○	○	○	○	7 - 71
1F	Frequency reference terminal 36/39 selection (ON: selects terminal 39)	○	○	○	○	6 - 17
20 to 2F	External fault (Desired settings possible) Input mode: NO contact/NC contact, Detection mode: Normal/during operation Stopping method: Deceleration to stop, coast to stop, emergency stop or continue operation.	○	○	○	○	7 - 71
30	PID control integral reset (ON: Reset)	○	○	○	○	-
60	DC injection braking command (ON: Performs DC injection braking)	○	○	○	○	7 - 74
61	External speed search command 1: Maximum output frequency (ON: speed search)	○	x	○	x	7 - 74
62	External speed search command 2: Set frequency (ON: speed search)	○	x	○	x	7 - 74
63	Energy-saving command (ON: Energy-saving control set for b8-01, b8-02)	○	○	x	x	7 - 12

User Constants

8.2.6 Terminal Constants: H

Setting value	Function	Control Methods				Page
		V/f	V/f w/ PG	Open loop Vector	Flux vector	
64	External speed search command 3	○	○	○	○	-
65	KEB (deceleration at momentary power loss) command (NO contact)	○	○	○	○	-
66	KEB (deceleration at momentary power loss) command (NO contact)	○	○	○	○	-
71	Speed/torque control change (ON: Torque control)	x	x	x	○	7 - 74
72	Zero-servo command (ON: Zero-servo)	x	x	x	○	7 - 75
77	Speed control (ASR) proportional gain switch (ON: C5-03)	x	x	x	○	7 - 75

■ Multi-function Outputs: H2

Constant Number	Name	Display	Setting Range	Factory Setting	Change during Operation	Control Methods				Page
						V/f	V/f with PG	Open Loop Vector	Flux Vector	
H2-01	Multi-function input (terminal 53-57)	Terminal 53 Sel	0 to 37	0	x	B	B	B	B	7 - 77
H2-02	Multi-function input (terminal 19)	Terminal 19 Sel	0 to 37	1	x	B	B	B	B	7 - 77
H2-03	Multi-function input (terminal 20)	Terminal 20 Sel	0 to 37	2	x	B	B	B	B	7 - 77

Multi-function Output Functions

Setting value	Function	Control Methods				Page
		V/f	V/f w/ PG	Open loop Vector	Flux vector	
0	During run □ON: run command is ON or voltage is being output)	○	○	○	○	7 - 78
1	Zero-speed	○	○	○	○	7 - 78
2	Frequency agree 1: (Detection width L4-02)	○	○	○	○	7 - 92
3	Desired frequency agree 1 (ON: Output frequency = ±L4-01, detection width in L4-02)	○	○	○	○	7 - 92
4	Frequency (Four) detection 1 (ON: +L4-01 ≥ output frequency ≥ -L4-01, detection width in L4-02)	○	○	○	○	7 - 92
5	Frequency (Four) detection 2 (ON: Output frequency ≥ +L4-01 or output frequency ≤ -L4-01, detection width in L4-02)	○	○	○	○	7 - 92
6	Inverter operation ready READY: After initialization, no faults	○	○	○	○	-
7	During DC bus undervoltage (UV) detection	○	○	○	○	-
8	During baseblock (ON: during baseblock)	○	○	○	○	-
9	Frequency reference selection (ON: Frequency reference from Operator)	○	○	○	○	-
A	Run command selection (ON: Run command from Operator)	○	○	○	○	-
B	Overtorque detection 1 NO (NO contact: Overtorque detection at ON)	○	○	○	○	7 - 95
C	Loss of frequency reference (Effective when operation selection is "1" for L4-05 frequency reference missing)	○	○	○	○	7 - 92
D	Braking resistor fault (ON: Resistor overheat or braking transistor fault)	○	○	○	○	-
E	Fault (ON: Faults other than CPF00, CPF01 have occurred.)	○	○	○	○	9 - 2
F	Not used. (Do not set.)	-	-	-	-	-
10	Minor fault (ON: Alarm displayed)	○	○	○	○	9 - 6
11	Fault reset command active	○	○	○	○	-
12	Timer function output	○	○	○	○	7 - 43
13	Frequency agree 2 (Detection width: L4-04)	○	○	○	○	7 - 92
14	Desired frequency agree 2 (ON: Output frequency = L4-03, detection width in L4-04)	○	○	○	○	7 - 92
15	Frequency detection 3 (ON: Output frequency ≤ -L4-03, detection width in L4-04)	○	○	○	○	7 - 92
16	Frequency detection 4 (ON: Output frequency ≥ -L4-03, detection width in L4-04)	○	○	○	○	7 - 92

Setting value	Function	Control Methods				Page
		V/f	V/f w/ PG	Open loop Vector	Flux vector	
17	Overtorque detection 1 NC (NC Contact: Torque detection at OFF)	○	○	○	○	7 - 95
18	Overtorque detection 2 NO (NO Contact: Torque detection at ON)	○	○	○	○	7 - 95
19	Overtorque detection 2 NC (NC Contact: Torque detection at OFF)	○	○	○	○	7 - 95
1A	During reverse run (ON: During reverse run)	○	○	○	○	-
1B	During baseblock 2 (OFF: During baseblock)	○	○	○	○	-
1C	Motor selection (Motor under selection)	-	-	-	-	-
1D	Regenerating (ON: Regenerating)	x	x	x	○	-
1E	Restart enabled (ON: Restart enabled)	○	○	○	○	7 - 94
1F	Motor overload (OL1) pre-alarm (ON: 90% or more of the detection level)	○	○	○	○	7 - 78
20	Inverter overheat (OH) pre-alarm (ON: Temperature exceeds L8-02 setting)	○	○	○	○	7 - 78
30	During torque limit (current limit) (ON: During torque limit)	x	x	○	○	-
31	During speed limit. (ON: During speed limit)	x	x	x	○	-
33	Zero-servo end (ON: Zero-servo function completed)	x	x	x	○	7 - 78
37	During run 2 (ON: Frequency output, OFF: Base block, DC injection braking, initial excitation, operation stop.	○	○	○	○	7 - 78

■ Analog Inputs: H3

Constant Number	Name	Description	Setting Range	Factory Setting	Change during Operation	Control Methods				Page
	Display					V/f	V/f with PG	Open Loop Vector	Flux Vector	
H3-01	Signal level selection (terminal 36)	0: 0 to +10V [11-bit + polarity (positive/negative) input] 1: 0 to ±10V	0, 1	0	x	B	B	B	B	6 - 4
	Term 36 Signal									
H3-02	Gain (terminal 36)	Sets the frequency when 10 V is input, as a percentage of the maximum output frequency.	0.0 to 1000.0	100.0	○	B	B	B	B	6 - 6
	Terminal 36 Gain									
H3-03	Bias (terminal 36)	Sets the frequency when 0 V is input, as a percentage of the maximum frequency.	-100.0 to +100.0	0.0	○	B	B	B	B	6 - 6
	Terminal 36 Bias									
H3-04	Signal level selection (terminal 42)	0: 0 to +10V [11-bit + polarity (positive/negative) input] 1: 0 to ±10V	0, 1	0	x	B	B	B	B	6 - 6
	Term 42 Signal									
H3-05	Multi-function analog input (terminal 42)	Select from the functions listed in the following table. Refer to page 7 - 79.	0 to 1F	0	x	B	B	B	B	6 - 5
	Terminal 42 Sel									
H3-06	Gain (terminal 42)	Sets the input gain (level) when terminal 42 is 10 V. Set according to the 100% value on page 7 - 79.	0.0 to 1000.0	100.0	○	B	B	B	B	6 - 6
	Terminal 42 Gain									
H3-07	Bias (terminal 42)	Sets the input gain (level) when terminal 42 is 0 V. Set according to the 100% value on page 7 - 79.	-100.0 to +100.0	0.0	○	B	B	B	B	6 - 6
	Terminal 42 Bias									
H3-08	Signal level selection (terminal 39)	0: 0 to +10 V (Always cut jumper wire J1) 1: 0 to ±10 V (Always cut jumper wire J1) 2: 4 to 20 mA (10-bit input)	0 to 2	2	x	A	A	A	A	6 - 4
	Term 39 Sel									
H3-09	Multi-function analog input (terminal 39)	Set as for H3-05. *Cannot be set to 0. The 1F function will become "frequency reference."	1 to 1F	1F	x	A	A	A	A	6 - 4
	Terminal 39 Sel									

User Constants

8.2.6 Terminal Constants: H

Constant Number	Name	Description	Setting Range	Factory Setting	Change during Operation	Control Methods				Page
	Display					V/f	V/f with PG	Open Loop Vector	Flux Vector	
H3-10	Gain (terminal 39)	Sets the input gain (level) when terminal 39 is 10 V (20 mA). Set according to the 100% value on page 7 - 79. If H3-09 = "1F" the setting in H3-02 is used.	0.0 to 1000.0	100.0	○	A	A	A	A	6 - 6
	Terminal 39 Gain									
H3-11	Bias (terminal 39)	Sets the input gain (level) when terminal 39 is 0 V (4 mA). Set according to the 100% value on page 7 - 79. If H3-09 = "1F" the setting in H3-03 is used.	-100.0 to +100.0	0.0	○	A	A	A	A	6 - 6
	Terminal 39 Bias									
H3-12	Analog input filter time constant	Sets terminals 36, 39, 42 to primary delay filter time constant, in seconds units. **Effective for noise control etc.	0.00 to 2.00	0.00	x	A	A	A	A	6 - 7
	Filter Avg Time									

H3-05 and H3-09 Settings

Setting	Function	Contents	Control Methods			
			V/f	V/f with PG	Open Loop Vector	Flux Vector
0	H3-05: Auxiliary frequency reference	Maximum output frequency	○	○	○	○
	H3-09: "0" cannot be set					
1	Frequency gain	Frequency reference (voltage) command value	○	○	○	○
2	Frequency bias	Maximum output frequency (added to H3-03)	○	○	○	○
4	Voltage bias	Motor rated voltage (E1-05)	○	○	x	x
5	Accel/decel change (reduction coefficient)	Set acceleration and deceleration times (C1-01 to C1-08)	○	○	○	○
6	DC injection braking current	Inverter rated output current	○	○	○	x
7	Overtorque detection level	Motor rated torque	○	○	○	○
8	Stall prevention level during run	Inverter rated current	○	○	x	x
9	Frequency reference lower limit level	Maximum output frequency	○	○	○	○
A	Jump frequency	Maximum output frequency	○	○	○	○
B	PID feedback	Maximum output frequency	○	○	○	○
10	Forward torque limit	Motor's rated torque	x	x	○	○
11	Reverse torque limit	Motor's rated torque	x	x	○	○
12	Regenerative torque limit	Motor's rated torque	x	x	○	○
13	Torque reference/torque limit at speed control	Motor's rated torque	x	x	x	○
14	Torque compensation bias	Motor's rated torque	x	x	x	○
15	Forward/reverse torque limit	Motor's rated torque	x	x	○	○
1F	H3-05: Not used (terminal 39: frequency reference)	-	○	○	○	○
	H3-09: Frequency reference	Maximum output frequency				

■ Analog Outputs: H4

Constant Number	Name	Description	Setting Range	Factory Setting	Change during Operation	Control Methods				Page
	Display					V/f	V/f with PG	Open Loop Vector	Flux Vector	
H4-01	Monitor selection (terminal 45)	Sets the number of the monitor item to be output (U1-□□) from terminal 21. *4, 10, 11, 12, 13, 14, 25, 28 cannot be set and 29 to 31 are not used.	1 to 33	2	x	B	B	B	B	7 - 82
	Terminal 45 Sel									
H4-02	Gain (terminal 45)	Sets the multi-function analog output 1 voltage level gain. Sets whether the monitor item output will be output in multiples of 10 V.	0.00 to 2.50	1.00	○	B	B	B	B	7 - 82
	Terminal 45 Gain									
H4-03	Bias (terminal 45)	Sets the multi-function analog output 1 voltage level bias. Sets output characteristic up/down parallel movement as a percentage of 10 V.	-10.0 to +10.0	0.0	○	B	B	B	B	7 - 82
	Terminal 45 Bias									
H4-04	Monitor selection (terminal 48)	Sets the number of the monitor item to be output (U1-□□) from terminal 48. *4, 10, 11, 12, 13, 14, 25, 28 cannot be set and 29 to 31 are not used.	1 to 33	3	x	B	B	B	B	7 - 82
	Terminal 48 Sel									
H4-05	Gain (terminal 48)	Sets the multi-function analog output 2 voltage level gain. Sets whether the monitor item output will be output in multiples of 10 V.	0.00 to 2.50	0.50	○	B	B	B	B	7 - 82
	Terminal 48 Gain									
H4-06	Bias (terminal 48)	Sets the multi-function analog output 2 voltage level bias. Sets output characteristic up/down parallel movement as a percentage of 10 V.	-10.0 to +10.0	0.0	○	B	B	B	B	7 - 82
	Terminal 48 Bias									
H4-07	Analog output signal level selection	Sets the signal output level for multi-function outputs 1 and 2 (terminals 45, 48.) 0: 0 to +10 V output 1: 0 to +10 V output *The optional Analog Monitor Card may also be used with this setting.	0□1	0	x	B	B	B	B	7 - 82
	AO Level Select									

■ MEMOBUS Communications: H5

Constant Number	Name	Description	Setting Range	Factory Setting	Change during Operation	Control Methods				Page
	Display					V/f	V/f with PG	Open Loop Vector	Flux Vector	
H5-01	Station address	Set the Inverter's node address.	0 to 20	1F	x	A	A	A	A	7 - 83
	Serial Comm ADR									
H5-02	Communication speed selection	Set the baud rate for 6CN MEMOBUS communications. 0: 1200 bps 1: 2400 bps 2: 4800 bps 3: 9600 bps	0 to 3	3	x	A	A	A	A	7 - 83
	Serial Com Sel									

User Constants

8.2.6 Terminal Constants: H

Constant Number	Name	Description	Setting Range	Factory Setting	Change during Operation	Control Methods				Page
	Display					V/f	V/f with PG	Open Loop Vector	Flux Vector	
H5-03	Communication parity selection	Set the parity for 6CN MEMOBUS communications. 0: No parity 1: Even parity 2: Odd parity	0 to 2	0	x	A	A	A	A	7 - 83
	Serial Com Sel									
H5-04	Stopping method after communication error	Set the stopping method for communications errors. 0: Deceleration stop 1: Coast to stop 2: Emergency stop 3: Continue operation	0 to 3	3	x	A	A	A	A	7 - 83
	Serial Fault Sel									
H5-05	Communication error detection selection	Set whether or not a communications timeout is to be detected as a communications error. 0: Do not detect. 1: Detect	0, 1	1	x	A	A	A	A	7 - 84
	Serial Flt Dtct									

8.2.7 Protection Constants: L

■ Motor Overload: L1

Constant Number	Name	Description	Setting Range	Factory Setting	Change during Operation	Control Methods				Page
	Display					V/f	V/f with PG	Open Loop Vector	Flux Vector	
L1-01	Motor protection selection	Sets whether the motor overload function is enabled or disabled at electric thermal overload relay. 0: Disabled 1: Enabled **In some applications when the Inverter power supply is turned off, the thermal value is reset, so even if this constant is set to 1, (Enabled), protection may not be effective. When several motors are connected to one Inverter, set to 0 (Disabled) and ensure that each motor is installed with a protection device.	0, 1	1	x	B	B	B	B	7 - 84
	MOL Fault Select									
L1-02	Motor protection time constant	Sets the electric thermal detection time in seconds units. **Usually setting is not necessary. The factory setting is 150% overload for one minute. When the motor's overload resistance is known, set at the overload resistance when the motor is hot started.	0.1 to 5.0	1.0	x	B	B	B	B	7 - 84
	MOL Time Const									

■ Power Loss Ridethrough: L2

Constant Number	Name	Description	Setting Range	Factory Setting	Change during Operation	Control Methods				Page
	Display					V/f	V/f with PG	Open Loop Vector	Flux Vector	
L2-01	Momentary power loss detection	0: Disabled (Undervoltage fault detection) 1: Enabled (Restarted when the power returns within the time for L2-02. When L2-02 is exceeded, undervoltage fault detection.) 2: Enabled while CPU is operating. (Restarts when power returns during control operations. Does not detect undervoltage fault.	0 to 2	0	x	B	B	B	B	7 - 85
	PwrL Selection									
L2-02	Momentary power loss ridethru time	Sets the recovery time, when momentary power loss selection (L2-01) is set to 1, in units of one second.	0.0 to 2.0	1.0 *1	x	B	B	B	B	7 - 85
	PwrL Ridethru t									
L2-03	Min. baseblock time	Sets the Inverter's minimum baseblock time in units of one second, when the Inverter is restarted after power loss ridethrough. **Sets the time for the motor's residual voltage to dissipate. When an overcurrent occurs when starting a speed search or DC injection braking, increase the set values.	0.0 to 25.5	10.0 *1	x	B	B	B	B	7 - 87
	PwrL Baseblock t									

User Constants

8.2.7 Protection Constants: L

Constant Number	Name	Description	Setting Range	Factory Setting	Change during Operation	Control Methods				Page
	Display					V/f	V/f with PG	Open Loop Vector	Flux Vector	
L2-04	Voltage recovery time	Sets the time required to return to normal voltage at the completion of a speed search, in units of one second. **Set the time required for a 400-V class Inverter to recover from 0 V to 400 VAC. (For the 575-V class Inverter, the time from 0 V to 575 VAC.)	0.0 to 5.0	0.3	x	A	A	A	A	7 - 87
	PwrL V/F Ramp t									
L2-05	Undervoltage detection level	Sets the main circuit under voltage (UV) detection level (main circuit DC voltage) in V units. **Usually setting is not necessary. Insert an AC reactor to lower the main circuit undervoltage detection level.	300 to 420 *2	380 *2	x	A	A	A	A	7 - 87
	PUV Det Level									
L2-06	KEB deceleration rate	Restores the operating conditions for momentary power loss by applying a frequency deceleration to create inertia energy when a power loss occurs, and thus avoid the power loss.	0.0 to 100.0	0.0	x	A	A	A	A	7 - 87
	KEB Frequency									

* 1. The factory setting depends upon the Inverter capacity. The values for a 400-V class Inverter of 200 kW will be displayed. See page 8 - 42.

* 2. These are values for a 400-V class Inverter. Multiply the value by approx. 1.5 for a 575-V class Inverter.

■ Stall Prevention: L3

Constant Number	Name	Description	Setting Range	Factory Setting	Change during Operation	Control Methods				Page
	Display					V/f	V/f with PG	Open Loop Vector	Flux Vector	
L3-01	Stall prevention selection during accel	0: Disabled (Acceleration as set. With a heavy load, the motor may stall.) 1: Enabled (Acceleration stopped when L3-02 level is exceeded. Acceleration starts again when the current is returned.) 2: Intelligent acceleration mode (Using the L3-02 level as a basis, acceleration is automatically adjusted. Set acceleration time is disregarded.)	0 to 2	1	x	B	B	B	x	7 - 88
	StallP Accel Sel									
L3-02	Stall prevention level during accel	Effective when L3-01 is set to 1 or 2. Set as a percentage of Inverter rated current. ※Usually setting is not necessary. The factory setting reduces the set values when the motor stalls.	0 to 200	150	x	B	B	B	x	7 - 88
	StallP Accel Lvl									
L3-03	Stall prevention limit during accel	Sets the lower limit for stall prevention during acceleration, as a percentage of the Inverter rated current, when operation is in the frequency range above the maximum voltage frequency (E1-06.) ※Usually setting is not necessary.	0 to 100	50	x	A	A	A	x	7 - 89
	StallP CHP Lvl									
L3-04	Stall prevention selection during decel	0: Disabled (Deceleration as set. If deceleration time is too short, a main circuit overvoltage may result.) 1: Enabled (Deceleration is stopped when the main circuit voltage exceeds the overvoltage level. Deceleration restarts when voltage is returned.) 2: Intelligent deceleration mode (Deceleration rate is automatically adjusted so that in Inverter can decelerate in the shortest possible time. Set deceleration time is disregarded.) ※When a braking option (Braking Resistor Unit or Braking Unit) is used, always set to 0 (Disabled.)	0 to 2	1	x	B	B	B	B	7 - 90
	StallP Decel Sel									
L3-05	Stall prevention selection during running	0: Disabled (Runs as set. With a heavy load, the motor may stall.) 1: Enabled: Deceleration time 1 (the deceleration time for the stall prevention function is C1-02.) 2: Enabled: Deceleration time 2 (the deceleration time for the stall prevention function is C1-04.)	0 to 2	1	x	B	B	x	x	7 - 90
	StallP Run Sel									
L3-06	Stall prevention level during running	Effective when L3-04 is 1 or 2. Set as a percentage of the Inverter rated current. ※Usually setting is not necessary. The factory setting reduces the set values when the motor stalls.	30 to 200	160	x	B	B	x	x	7 - 90
	StallP Run Level									

■ Reference Detection: L4

Constant Number	Name	Description	Setting Range	Factory Setting	Change during Operation	Control Methods				Page
	Display					V/f	V/f with PG	Open Loop Vector	Flux Vector	
L4-01	Speed agree detection level	Effective when “Desired frequency (ref/setting) agree 1,” “Frequency detection 1,” “Frequency detection 2,” are set for multi-function output.	0.0 to 150.0	0.0	x	B	B	B	B	7 - 92
	Spd Agree Level	Frequencies to be detected are set in Hz units.								
L4-02	Speed agree detection width	Effective when “Frequency (ref/out) agree 1,” “Desired frequency (ref/setting) agree 1,” “Frequency detection 1,” “Frequency detection 2” are set for multi-function output.	0.0 to 20.0	2.0	x	B	B	B	B	7 - 92
	Spd Agree Width	Sets the frequency detection width in Hz units.								
L4-03	Speed Agree detection level (+/-)	Effective when “Desired frequency (ref/setting) agree 2,” “Frequency detection 3,” “Frequency detection 4,” are set for multi-function output.	-150.0 to +150.0	0.0	x	A	A	A	A	7 - 92
	Spd Agree Lvl + -	Frequency detection width is set in Hz units.								
L4-04	Speed agree detection width (+/-)	Effective when “Frequency (ref/out) agree 2,” “Desired frequency (ref/setting) agree 1,” “Frequency detection 3,” “Frequency detection 4” are set for multi-function output.	0.0 to 20.0	2.0	x	A	A	A	A	7 - 92
	Spd Agree Wdth + -	Frequency detection width is set in Hz units.								
L4-05	Operation when frequency reference is missing	0: Stop (Operation follows the frequency reference.) 1: Operation at 80% speed continues. (At 80% of speed before the frequency reference was lost)	0, 1	0	x	A	A	A	A	7 - 92
	Ref Loss Sel	*: Frequency reference is lost: Frequency reference dropped over 90% in 400 ms.								

■ Fault Restart: L5

Constant Number	Name	Description	Setting Range	Factory Setting	Change during Operation	Control Methods				Page
	Display					V/f	V/f with PG	Open Loop Vector	Flux Vector	
L5-01	Number of auto restart attempts	Sets the number of auto restart attempts.	0 to 10	0	x	B	B	B	B	7 - 94
	Num of Restarts	Automatically restarts after a fault and conducts a speed search from the run frequency.								
L5-02	Auto restart operation selection	Sets whether a fault contact output is activated during fault restart.	0, 1	0	x	B	B	B	B	7 - 95
	Restart Sel	0: Not output (Fault contact is not activated.) 1: Output (Fault contact is activated.)								

■ Torque Detection: L6

Constant Number	Name	Description	Setting Range	Factory Setting	Change during Operation	Control Methods				Page
	Display					V/f	V/f with PG	Open Loop Vector	Flux Vector	
L6-01	Torque detection selection 1	0: Overtorque detection disabled. 1: Detection during speed agree only/Operation continues after detection (Minor fault) 2: Detection during run/Operation continues after detection (Minor fault) 3: Detection during speed agree only/Inverter output is shut off after detection (Fault) 4: Detection during run/Inverter output is shut off after detection (Fault)	0 to 4	0	x	B	B	B	B	7 - 95
	Torq Det 1 Sel									
L6-02	Torque detection level 1	Vector control: Motor rated torque is set as 100%. V/f control: Inverter rated current is set as 100%.	0 to 300	150	x	B	B	B	B	7 - 95
	Torq Det 1 Lvl									
L6-03	Torque detection time 1	Sets the torque detection time in 1-second units.	0.0 to 10.0	0.1	x	B	B	B	B	7 - 95
	Torq Det 1 Time									
L6-04	Torque detection selection 2	Setting procedure is the same as for "Torque detection selection 1" (L6-01 to L6-03.)	0 to 4	0	x	A	A	A	A	7 - 95
	Torq Det 2 Sel									
L6-05	Torque detection level 2	The following outputs are possible: Torque detection selection 1: Multi-function output "Torque detection selection 1" NO/NC	0 to 300	150	x	A	A	A	A	7 - 95
	Torq Det 2 Lvl									
L6-06	Torque detection time 2	Torque detection selection 2: Multi-function output "Torque detection selection 2" NO/NC	0.0 to 10.0	0.1	x	A	A	A	A	7 - 95
	Torq Det 2 Time									

■ Torque Limit: L7

Constant Number	Name	Description	Setting Range	Factory Setting	Change during Operation	Control Modes				Page
	Display					V/f	V/f with PG	Open Loop Vector	Flux Vector	
L7-01	Forward torque limit	Sets the torque limit value as a percentage of the motor rated torque. Four individual regions can be set.	0 to 300	200	x	x	x	B	B	7 - 4 7 - 28
	Torq Limit Fwd									
L7-02	Reverse torque limit		0 to 300	200	x	x	x	B	B	7 - 4 7 - 28
	Torq Limit Rev									
L7-03	Forward regenerative torque limit		0 to 300	200	x	x	x	B	B	7 - 4 7 - 28
	Torq Lmt Fwd Rgn									
L7-04	Reverse regenerative torque limit		0 to 300	200	x	x	x	B	B	7 - 4 7 - 28
	Torq Lmt Rev Rgn									

■ Hardware Protection: L8

Constant Number	Name	Description	Setting Range	Factory Setting	Change during Operation	Control Methods				Page
	Display					V/f	V/f with PG	Open Loop Vector	Flux Vector	
L8-01	Protect selection for internal DB resistor (Type ERF)	0: Disabled (no overheating protection) 1: Enabled (overheating protection)	0, 1	0	x	B	B	B	B	7 - 96
	DB Resistor Prot									
L8-02	Overheat pre-alarm level	Sets the detection temperature for the Inverter overheat detection pre-alarm in °C. **The pre-alarm detects when the cooling fin temperature reaches the set value.	50 to 110	95	x	A	A	A	A	7 - 98
	OH Pre-Alarm Lvl									
L8-03	Operation selection after overheat pre-alarm	Sets the operation for when the Inverter overheat pre-alarm goes ON. 0: Ramp to stop in deceleration time C1-02. 1: Coast to stop 2: Fast stop in fast-stop time C1-09. 3: Continue operation (Monitor display only.) **A fault will be given in setting 0 to 2 and a minor fault will be given in setting 3.	0 to 3	3	x	A	A	A	A	7 - 98
	OH Pre-Alarm Sel									
L8-05	Input open-phase protection selection	0: Disabled 1: Enabled (Detects if input current open-phase, power supply voltage imbalance or main circuit electrostatic capacitor deterioration occurs.)	0, 1	0	x	A	A	A	A	7 - 98
	Ph Loss In Sel									
L8-07	Output open-phase protection selection	0: Disabled 1: Enabled (Output open-phase detected at less than 5% of Inverter rated current.) **Output open-phase detection may occur or detection may not work inadvertently when applied motor capacity is small for Inverter capacity. In this case, set to 0 (Disabled.)	0,1	0	x	A	A	A	A	7 - 98
	Ph Loss Out Sel									

8.2.8 Operator Constants: o

■ Monitor Select: o1

Constant Number	Name	Description	Setting Range	Factory Setting	Change during Operation	Control Methods				Page
	Display					V/f	V/f with PG	Open Loop Vector	Flux Vector	
o1-01	Monitor selection	Set the number of the monitor item to be displayed in the earliest 4 monitor items. (U1-□□)	4 to 33	6	○	B	B	B	B	7 - 99
	Monitor Select	**The output monitor voltage (factory setting) can be changed.								
o1-02	Monitor selection after power up	Sets the monitor item to be displayed when the power is turned on. 1: Frequency reference□ 2: Output frequency	1 to 4	1	○	B	B	B	B	7 - 99
	Power-On Monitor	3: Output current□ 4: The monitor item set for o1-01								
o1-03	Frequency units of reference setting and monitor	Sets the units that will be set and displayed for the frequency reference and frequency monitor. 0: 0.01 Hz units 1: 0.01% units (Maximum output frequency is 100%) 2 to 39:r/min units (Sets the motor poles.) 40 to 39999: User desired display Set the desired values for setting and display for the max. output frequency.	0 to 39999	0	x	B	B	B	B	7 - 99
	Display Scaling	□ □ □ □ □ ↑ ↑ ↑ ↑ ↑ ↑ ↑ ↑ Example: When the max. output frequency value is 200.0, set 12000								
o1-04	Frequency units of constant setting	Set the V/f pattern setting units. (E1-04, 06, 09 set units) 0: Hz units 1: r/min units	0, 1	0	x	x	x	x	B	7 - 100
	Display Units	**Effective only in the flux vector control mode.								
o1-05	Constant No. display selection	Set the Operator constant number display method. 0: Normal display (e.g., A1-00)	0, 1	0	x	A	A	A	A	7 - 100
	Address Display	1: Display MEMOBUS communications register address								

User Constants

8.2.8 Operator Constants: o

■ Multi-function Selections: o2

Constant Number	Name	Description	Setting Range	Factory Setting	Change during Operation	Control Methods				Page
	Display					V/f	V/f with PG	Open Loop Vector	Flux Vector	
o2-01	LOCAL/REMOTE key enable/disable	Sets the Digital Operator Local/Remote Key 0: Disabled 1: Enabled (Switches between the Digital Operator and the constant settings.)	0, 1	1	x	B	B	B	B	7 - 100
	Local/remote key									
o2-02	STOP key during control circuit terminal operation	Sets the Stop Key in the run mode. 0: Disabled (When the run command is issued from and external terminal, the Stop Key is disabled.) 1: Enabled (Effective even during run.)	0, 1	1	x	B	B	B	B	7 - 101
	Oper STOP Key									
o2-03	User constant initial value	Clears or stores user initial values. 0: Stores/not set 1: Begins storing (Records the set constants as user initial values.) 2: All clear (Clears all recorded user initial values) **When the set constants are recorded as user initial values, 1110 will be displayed in the Initialize mode (A1-03.)	0 to 2	0	x	B	B	B	B	7 - 101
	User Defaults									
o2-04	kVA selection	Do not set.	0 to FF *	81 *	x	B	B	B	B	7 - 101
	Inverter Model #									
o2-05	Frequency reference setting method selection	When the frequency reference is set on the Digital Operator frequency reference monitor, sets whether the Enter Key is necessary. 0: Enter Key needed 1: Enter Key not needed **When set to 1, the Inverter accepts the frequency reference without Enter Key operation.	0, 1	0	x	A	A	A	A	7 - 101
	Operator M.O.P.									
o2-06	Operation selection when digital operator is disconnected	Sets the operation when the Digital Operator is disconnected. 0: Disabled (Operation continues even if the Digital Operator is disconnected.) 1: Enabled (OPR is detected at Digital Operator disconnection. Inverter output is cut off, and fault contact is operated.)	0, 1	0	x	A	A	A	A	7 - 102
	Oper Detection									
o2-07	Cumulative operation time setting	Sets the cumulative operation time in hour units. **Operation time is calculated from the set values.	0 to 65535	0	x	A	A	A	A	7 - 102
	Elapsed Time Set									
o2-08	Cumulative operation time selection	0: Cumulative time when the Inverter power is on. (All time while the Inverter power is on is accumulated.) 1: Cumulative Inverter run time. (Only Inverter output time is accumulated.)	0, 1	0	x	A	A	A	A	7 - 102
	Elapsed Time Run									
o2-09	Initialize mode selection	Do not set.	0 to 2	0	x	A	A	A	A	-
	Init Mode Sel									

* The factory setting depends upon the Inverter capacity. The values for a 400-V class Inverter of 200 kW will be displayed.

8.2.9 Factory Settings that Change with the Control Method (A1-02)

Constant No.	Name	Setting Range	Unit	Factory Setting			
	Display			V/f Control A1-02=0	V/f with PG A1-02=1	Open Loop Vector A1-02=2	Flux Vector A1-02=3
b3-01	Speed search selection at start	0□1	1	0	1	0	1
	SpfSrch at Start						
b3-02	Speed search operating current	0 to 200	1%	150	--	100	--
	SpdSrch Current						
C3-01	Slip compensation gain	0.0 to 2.5	0.1	0.0	--	1.0	1.0
	Slip Comp gain						
C3-02	Slip compensation primary delay time	0 to 10000	1 msec	2000	--	200	--
	Slip Comp Time						
C4-02	Torque compensation time constant	0 to 10000	1 msec	200	200	20	--
	Torq Comp Time						
C5-01	ASR proportional (P) gain 1	0.00 to 300.00	0.01	--	0.20	--	20.00
	ASR P Gain 1						
C5-02	ASR integral (I) time 1	0.000 to 10.000	0.001 sec	--	0.200	--	0.500
	ASR I Time 1						
C5-03	ASR proportional (P) gain 2	0.00 to 300.00	0.01	--	0.02	--	20.00
	ASR P Gain 2						
C5-04	ASR integral (I) time 2	0.000 to 10.000	0.001 sec	--	0.050	--	0.500
	ASR I Time 2						
E1-07 E4-04	Mid. output frequency	0.0 to 150.0	0.1 Hz	3.0	3.0	3.0	0.0
	Mid Frequency A						
E1-08 E4-05	Mid. output frequency voltage	0.0 to 510.0 (0.0 to 733.0)	0.1 V	*	*	22.0 (31.6)	0.0
	Mid voltage A						
E1-09 E4-06	Min. output frequency	0.0 to 150.0	0.1 Hz	1.5	1.5	0.5	0.0
	Min Frequency						
E1-10 E4-07	Min. output frequency voltage	0.0 to 510.0 (0.0 to 733.0)	0.1 V	*	*	4.0 (5.8)	0.0
	Min Voltage						
F1-09	Overspeed detection delay time	0.0 to 2.0	0.1 sec	--	1.0	--	0.0
	PG Overspd Time						

Note Values in parentheses are for 575-V class Inverters.

* Settings vary as shown in the following tables depending on the Inverter capacity.

400-V Class Inverters

Inverter Capacity (kW)	200 to 800
E1-08, E4-05	24.0
E1-10, E4-06	12.0

575-V Class Inverters

Inverter Capacity (kW)	300 to 1200
E1-08, E4-05	34.5
E1-10, E4-06	17.3

8.2.10 Factory Settings that Change with the Inverter Capacity (o2-04)

■ 400-V Class Inverters

Con-stant No.	Name	Unit	Factory Setting			
			200	400	600	800
-	Inverter Capacity	kW	200	400	600	800
o2-04	kVA selection	1	81	82	83	84
C6-01	Carrier frequency upper limit	kHz	2.0	2.0	2.0	2.0
-	Carrier frequency upper limit range	kHz	2.0	2.0	2.0	2.0
C6-02	Carrier frequency lower limit	kHz	2.0	2.0	2.0	2.0
C6-03	Carrier frequency proportional gain	1	0	0	0	0
E2-01 (E5-01)	Motor rated current	A	370.0	740.0	1110.0	1480.0
E2-02 (E5-02)	Motor rated slip	Hz	1.30	1.30	1.30	1.30
E2-03 (E5-03)	Motor no-load current	A	96.0	192.0	288.0	384.0
E2-05 (E5-05)	Motor line-to-line resistance	Ω	0.020	0.010	0.005	0.002
E2-06 (E5-06)	Motor leak inductance	%	5.0	5.0	5.0	5.0
L2-02	Momentary power loss ridethru time	sec	1.0	1.0	1.0	1.0
L2-03	Min. baseblock time	sec	10.0	10.0	10.0	10.0

■ 575-V Class Inverters

Constant No.	Name	Unit	Factory Setting			
-	Inverter Capacity	kW	300	600	900	1200
o2-04	kVA selection	1	91	92	93	94
C6-01	Carrier frequency upper limit *	kHz	2.0	2.0	2.0	2.0
-	Carrier frequency upper limit range	kHz	2.0	2.0	2.0	2.0
C6-02	Carrier frequency lower limit	kHz	2.0	2.0	2.0	2.0
C6-03	Carrier frequency proportional gain	1	0	0	0	0
E2-01 (E5-01)	Motor rated current	A	370.0	740.0	1110.0	1480.0
E2-02 (E5-02)	Motor rated slip	Hz	1.30	1.30	1.30	1.30
E2-03 (E5-03)	Motor no-load current	A	96.0	192.0	288.0	384.0
E2-05 (E5-05)	Motor line-to-line resistance	Ω	0.020	0.010	0.005	0.002
E2-06 (E5-06)	Motor leak inductance	%	5.0	5.0	5.0	5.0
L2-02	Momentary power loss ridethru time	sec	1.0	1.0	1.0	1.0
L2-03	Min. baseblock time	sec	10.0	10.0	10.0	10.0

8.2.10 Factory Settings that Change with the Inverter Capacity (o2-04)

9

Troubleshooting

This chapter describes the fault displays and countermeasure for the VS-616G5 and motor problems and countermeasures.

9.1 Protective and Diagnostic Functions	9 - 2
9.1.1 Fault Detection	9 - 2
9.1.2 Minor Fault Detection	9 - 6
9.1.3 Operation Errors	9 - 8
9.2 Troubleshooting	9 - 9
9.2.1 If Constant Constants Cannot Be Set	9 - 9
9.2.2 If the Motor Does Not Operate	9 - 9
9.2.3 If the Direction of the Motor Rotation is Reversed	9 - 11
9.2.4 If the Motor Does Not Put Out Torque or If Acceleration is Slow	9 - 11
9.2.5 If the Motor Does Not Operate According to Reference	9 - 11
9.2.6 If the Slip Compensation Function Has Low Speed Precision	9 - 11
9.2.7 If There is Low Speed Control Accuracy at High-speed Rotation in Open-loop Vector Control Mode	9 - 12
9.2.8 If Motor Deceleration is Slow	9 - 12
9.2.9 If the Motor Overheats	9 - 12
9.2.10 If There is Noise When the Inverter is Started or From an AM Radio	9 - 13
9.2.11 If the Ground Fault Interrupter Operates When the Inverter is Run	9 - 13
9.2.12 If There is Mechanical Oscillation	9 - 13
9.2.13 If the Motor Rotates Even When Inverter Output is Stopped	9 - 14
9.2.14 If 0 V is Detected When the Fan is Started, or Fan Stalls	9 - 14
9.2.15 If Output Frequency Does Not Rise to Frequency Reference	9 - 14



9.1 Protective and Diagnostic Functions

9.1.1 Fault Detection

When the Inverter detects a fault, the fault code is displayed on the Digital Operator, the fault contact output operates, and the Inverter output is shut OFF causing the motor to coast to a stop. (The stopping method can be selected for some faults, and the selected stopping method will be used with these faults.)

- When a fault has occurred, refer to the following table to identify and correct the cause of the fault.
- Use one of the following methods to reset the fault after restarting the Inverter:
 - Turn ON the fault reset signal.
(A multi-function input (H1-01 to H1-06) must be set to 14 (Fault Reset).)
 - Press the RESET Key on the Digital Operator.
 - Turn the main circuit power supply off and then on again.

Table 9.1 Fault Displays and Processing

Fault Display	Meaning	Probable Causes	Corrective Actions
OC Overcurrent	Overcurrent The Inverter output current exceeded the overcurrent detection level. (200% of rated current)	<ul style="list-style-type: none"> • A short-circuit or ground fault occurred at the Inverter output. (A short or ground fault can be caused by motor burn damage, worn insulation, or a damaged cable.) • The load is too large or the acceleration/deceleration time is too short. • A special-purpose motor or motor with a capacity too large for the Inverter is being used. • A magnetic switch was switched at the Inverter output. 	Reset the fault after correcting its cause.
GF Ground Fault	Ground Fault The ground fault current at the Inverter output exceeded approximately 50% of the Inverter rated output current.	A ground fault occurred at the Inverter output. (A ground fault can be caused by motor burn damage, worn insulation, or a damaged cable.)	Reset the fault after correcting its cause.
PUF DC Bus Fuse Open	Fuse Blown The fuse in the main circuit is blown.	The output transistor has failed because of a short-circuit or ground fault at the Inverter output. Check whether there is a short-circuit between the following terminals. A short-circuit will damage the output transistor: B1 (⊕3) ↔ U, V, W ⊖ ↔ U, V, W	Replace the Inverter after correcting the cause.
SC Short Circuit	Load Short-circuit The Inverter output or load was short-circuited.	A short-circuit or ground fault occurred at the Inverter output. (A short or ground fault can be caused by motor burn damage, worn insulation, or a damaged cable.)	Reset the fault after correcting its cause.
OV Overvoltage	Main Circuit Overvoltage The main circuit DC voltage exceeded the overvoltage detection level. 400-V class: Approx. 800 V 575-V class: Approx. 990 V	The deceleration time is too short and the regenerative energy from the motor is too large.	Increase the deceleration time or connect a Braking Resistor Unit.
		The power supply voltage is too high.	Decrease the voltage so it's within specifications.
UV1 DC Bus Undervolt	Main Circuit Undervoltage The main circuit DC voltage is below the undervoltage detection level (L2-05). 400-V class: Approx. 380 V 575-V class: Approx. 480 V	<ul style="list-style-type: none"> • An open-phase occurred with the input power supply. • A momentary power loss occurred. • The wiring terminals for the input power supply are loose. • The voltage fluctuations in the input power supply are too large. 	Reset the fault after correcting its cause.
UV2 CTL PS Undervolt	Control Power Fault The control power supply voltage dropped.	--	<ul style="list-style-type: none"> • Try turning the power supply off and on. • Replace the Inverter if the fault continues to occur.

Fault Display	Meaning	Probable Causes	Corrective Actions
UV3 MC Answerback	Inrush Prevention Circuit Fault A fault occurred in the inrush prevention circuit.	--	<ul style="list-style-type: none"> Try turning the power supply off and on. Replace the Inverter if the fault continues to occur.
PF Input Pha Loss	Main Circuit Voltage Fault The main circuit DC voltage oscillates unusually (not when regenerating). This fault is detected when L8-05 is set to "Enabled."	<ul style="list-style-type: none"> An open-phase occurred in the input power supply. A momentary power loss occurred. The wiring terminals for the input power supply are loose. The voltage fluctuations in the input power supply are too large. The voltage balance between phases is bad. 	Reset the fault after correcting its cause.
LF Output Pha Loss	Output Open-phase An open-phase occurred at the Inverter output. This fault is detected when L8-07 is set to "Enabled."	<ul style="list-style-type: none"> There is a broken wire in the output cable. There is a broken wire in the motor winding. The output terminals are loose. 	Reset the fault after correcting its cause.
		The motor being used has a capacity less than 5% of the Inverter's maximum motor capacity.	Check the motor and Inverter capacity.
OH□OH1□ Heatsink Over tmp	Cooling Fin Overheating The temperature of the Inverter's cooling fins exceeded the setting in L8-02 or 105°C.	The ambient temperature is too high.	Install a cooling unit.
		There is a heat source nearby.	Remove the heat source.
		The Inverter's cooling fan has stopped.	Replace the cooling fan. (Contact your Yaskawa representative.)
	Inverter internal cooling fan stopped	Inverter internal cooling fan has stopped.	
RH Dyn Brk Resistor	Installed Braking Resistor Overheating The braking resistor is overheated and the protection function set with L8-01 has operated.	The deceleration time is too short and the regenerative energy from the motor is too large.	<ul style="list-style-type: none"> Reduce the load, increase the deceleration time, or reduce the motor speed. Change to a Braking Resistor Unit.
RR Dyn Brk Transistr	Internal Braking Transistor Fault The braking transistor is not operating properly.	--	<ul style="list-style-type: none"> Try turning the power supply off and on. Replace the Inverter if the fault continues to occur.
OL1 Motor Overloaded	Motor Overload The motor overload protection function has operated based on the internal electronic thermal value.	The load is too heavy. The acceleration time, deceleration time, and cycle time are too short.	Check the size of the load and the length of the acceleration, deceleration, and cycle times.
		The V/f characteristics voltage is too high.	Check the V/f characteristics.
		The motor's rated current setting (E2-01) is incorrect.	Check the motor's rated current setting (E2-01).
OL2 Inv Overloaded	Inverter Overload The Inverter overload protection function has operated based on the internal electronic thermal value.	The load is too heavy. The acceleration time, deceleration time and cycle time are too short.	Check the size of the load and the length of the acceleration, deceleration, and cycle times.
		The V/f characteristics voltage is too high.	Check the V/f characteristics.
		The Inverter capacity is too low.	Replace the Inverter with one that has a larger capacity.
OL3 Overtorque Det 1	Overtorque 1 There has been a current greater than the setting in L6-02 for longer than the setting in L6-03.	--	<ul style="list-style-type: none"> Make sure that the settings in L6-02 and L6-03 are appropriate. Check the mechanical system and correct the cause of the overtorque.
OL4 Overtorque det 2	Overtorque 2 There has been a current greater than the setting in L6-05 for longer than the setting in L6-06.	--	<ul style="list-style-type: none"> Make sure that the current setting in L6-05 and time setting in L6-06 are appropriate. Check the mechanical system and correct the cause of the overtorque.

Troubleshooting

9.1.1 Fault Detection

Fault Display	Meaning	Probable Causes	Corrective Actions
OS Over speed	Overspeed The speed has been greater than the setting in F1-08 for longer than the setting in F1-09.	Overshooting/Undershooting are occurring.	Adjust the gain again.
		The reference speed is too high.	Check the reference circuit and reference gain.
		The settings in F1-08 and F1-09 aren't appropriate.	Check the settings in F1-08 and F1-09.
PGO PG open	PG Disconnection Detected The PG is disconnected. The Inverter is outputting a frequency, but PG pulses aren't being input.	There is a break in the PG wiring.	Fix the broken/disconnected wiring.
		The PG is wired incorrectly.	Fix the wiring.
		Power isn't being supplied to the PG.	Supply power to the PG properly.
		--	Check for open circuit when using brake (motor).
DEV Speed Deviation	Excessive Speed Deviation The speed deviation has been greater than the setting in F1-10 for longer than the setting in F1-11.	The load is too heavy.	Reduce the load.
		The acceleration time and deceleration time are too short.	Lengthen the acceleration time and deceleration time.
		The load is locked.	Check the mechanical system.
		The settings in F1-10 and F1-11 aren't appropriate.	Check the settings in F1-10 and F1-11.
		--	Check for open circuit when using brake (motor).
CF Out of Control	Control Fault The torque limit was reached continuously for 3 seconds or longer during a deceleration stop during open-loop vector control.	--	Check the motor constants.
SVE Zero Servo Fault	Zero Servo Fault The rotation position moved during zero servo operation.	The torque limit is too small.	Increase the limit.
		The load torque is too large.	Reduce the load torque.
		--	Check for signal noise.
OPR Oper Disconnect	Operator Connection Fault The Operator was disconnected during operation started by a run command from the Operator.	--	Check the Operator connection.
EFO Opt External Flt	External fault input from Transmission Option Card.	--	Check the Trsansmission Option Card and transmission signal.
EF3 External Fault 3	External fault (Input terminal 11)	An "external fault" was input from a multi-function input.	<ul style="list-style-type: none"> Reset external fault inputs to the multi-function inputs. Remove the cause of the external fault.
EF4	External fault (Input terminal 12)		
EF5	External fault (Input terminal 13)		
EF6	External fault (Input terminal 14)		
EF7	External fault (Input terminal 15)		
EF8	External fault (Input terminal 16)		
CPF00 COM-ERR (OP&INV)	Operator Communications Error 1 Communications with the Operator were not established within 5 seconds after the power was turned on.		
		The Inverter's control circuits are faulty.	Replace the Inverter.
CPF01 COM-ERR (OP&INV)	Operator Communications Error 2 After communications were established, there was a transmission error with the Digital Operator for more than 2 seconds.	The Digital Operator isn't connected properly.	Disconnect the Digital Operator and then connect it again.
		The Inverter's control circuits are faulty.	Replace the Inverter.
CPF02 BB Circuit Err	Baseblock circuit error	--	Try turning the power supply off and on again.
		The control circuit is damaged.	Replace the Inverter.

Fault Display	Meaning	Probable Causes	Corrective Actions
CPF03 EEPROM Error	EEPROM error	--	Try turning the power supply off and on again.
		The control circuit is damaged.	Replace the Inverter.
CPF04 Internal A/D Err	CPU internal A/D converter error	--	Try turning the power supply off and on again.
		The control circuit is damaged.	Replace the Inverter.
CPF05 External A/D Err	CPU external A/D converter error	--	Try turning the power supply off and on again.
		The control circuit is damaged.	Replace the Inverter.
CPF06 Option Error	Option Card connection error	The Option Card is not connected properly.	Turn off the power and insert the Card again.
		The Inverter or Option Card is faulty.	Replace the faulty component.
CPF07 PWM time error	PWM timer error 400-V class: Detected only for 400 kW or larger Inverters. 575-V class: Detected only for 600 kW or larger Inverters.	Inverter control section is faulty.	Replace the Control Card.
CPF08 DP-RAM Bcc error	Shared RAM BCC check error 400-V class: Detected only for 400 kW or larger Inverters. 575-V class: Detected only for 600 kW or larger Inverters.	Inverter control section is faulty.	Replace the Control Card.
CPF09 DP-RAM COM error	Shared RAM mutual diagnosis error 400-V class: Detected only for 400 kW or larger Inverters. 575-V class: Detected only for 600 kW or larger Inverters.	Inverter control section is faulty.	Replace the Control Card.
CPF10 DP-RAM Write err	Shared RAM write error 400-V class: Detected only for 400 kW or larger Inverters. 575-V class: Detected only for 600 kW or larger Inverters.	Inverter control section is faulty.	Replace the Control Card.
CPF20 Option A/D Error	Option Card A/D converter error	The Option Card is not connected properly.	Turn off the power and insert the Card again.
		The Option Card's A/D converter is faulty.	Replace the Option Card.
CPF21 Option CPU down	Transmission Option Card self diagnostic error	Option Card fault.	Replace the Option Card.
CPF22 Option Type Err	Transmission Option Card model code error		
CPF23 Option DPRAM Err	Transmission Option Card DPRAM error		

9.1.2 Minor Fault Detection

Minor faults are a type of Inverter protection function that do not operate the fault contact output and are automatically returned to their original status once the cause of the minor fault has been removed.

The Digital Operator display blinks and the minor fault is output from the multi-function outputs (H2-01 to H2-03).

Take appropriate countermeasures according to the table below.

Table 9.2 Minor Fault Displays and Processing

Minor fault display	Meaning	Probable causes	Corrective Actions
EF (blinking) External Fault	Forward/Reverse Run Commands Input Together Both the forward and reverse run commands have been ON for more than 0.5 s.	--	Check the sequence of the forward and reverse run commands. *Since the rotational direction is unknown, the motor will be decelerated to a stop when this minor fault occurs.
UV (blinking) DC Bus Undervolt	Main Circuit Undervoltage The following conditions occurred when there was no Run signal. <ul style="list-style-type: none"> The main circuit DC voltage was below the undervoltage detection level (L2-05). The surge current limiting contactor opened. The control power supply voltage when below the CUV level. 	See causes for UV1, UV2, and UV3 faults.	See corrective actions for UV1, UV2, and UV3 faults.
OV (blinking) Overvoltage	Main Circuit Overvoltage The main circuit DC voltage exceeded the overvoltage detection level. 400-V class: Approx. 800 V 800 V class: Approx. 990 V	The power supply voltage is too high.	Decrease the voltage so it's within specifications.
OH (blinking) Heatsink Over tmp	Cooling Fin Overheating The temperature of the Inverter's cooling fins exceeded the setting in L8-02.	The ambient temperature is too high.	Install a cooling unit.
		There is a heat source nearby.	Remove the heat source.
		The Inverter cooling fan has stopped.	Replace the cooling fan. (Contact your Yaskawa representative.)
OH2 (blinking) Over Heat 2	Inverter Overheating Pre-alarm An OH2 alarm signal (Inverter overheating alarm signal) was input from a multi-function input.	--	Clear the multi-function input's overheating alarm input.
OL3 (blinking) Overtorque Det 1	Overtorque 1 There has been a current greater than the setting in L6-02 for longer than the setting in L6-03.	--	<ul style="list-style-type: none"> Make sure that the settings in L6-02 and L6-03 are appropriate. Check the mechanical system and correct the cause of the overtorque.
OL4 (blinking) Overtorque Det 2	Overtorque 2 There has been a current greater than the setting in L6-05 for longer than the setting in L6-06.	--	<ul style="list-style-type: none"> Make sure that the current setting in L6-05 and time setting in L6-06 are appropriate. Check the mechanical system and correct the cause of the overtorque.
OS (blinking) Over speed	Overspeed The speed has been greater than the setting in F1-08 for longer than the setting in F1-09.	Overshooting/undershooting are occurring.	Adjust the gain again.
		The reference speed is too high.	Check the reference circuit and reference gain.
		The settings in F1-08 and F1-09 aren't appropriate.	Check the settings in F1-08 and F1-09.
PGO (blinking) PG open	The PG is disconnected. The Inverter is outputting a frequency, but PG pulses aren't being input.	There is a break in the PG wiring.	Fix the broken/disconnected wiring.
		The PG is wired incorrectly.	Fix the wiring.
		Power isn't being supplied to the PG.	Supply power to the PG properly.

Minor fault display	Meaning	Probable causes	Corrective Actions
DEV (blinking) Speed Deviation	Excessive Speed Deviation The speed deviation has been greater than the setting in F1-10 for longer than the setting in F1-11.	The load is too large.	Reduce the load.
		The acceleration time and deceleration time are too short.	Lengthen the acceleration time and deceleration time.
		The load is locked.	Check the mechanical system.
		The settings in F1-10 and F1-11 aren't appropriate.	Check the settings in F1-10 and F1-11.
UV4 PU Undervolt	PU Control Circuit Undervoltage Module control power supply dropped during operation. 400-V class: Detected only for 400 kW or larger Inverters. 575-V class: Detected only for 600 kW or larger Inverters.	---	<ul style="list-style-type: none"> Check wirings on the power supply side. Improve the power supply voltage.
UNBC Unbalance Cur	Unbalanced Current The output current for each Modulle became unbalanced. 400-V class: Detected only for 400 kW or larger Inverters. 575-V class: Detected only for 600 kW or larger Inverters.	---	Check wirings.
OH4 Conv Ovr tmp	Converter overheating The converter fin temperature became higher than 105 °C. 400-V class: Detected only for 400 kW or larger Inverters. 575-V class: Detected only for 600 kW or larger Inverters.	---	Check the fin and ambient temperatures.
EF3 (blinking) External Fault 3	External fault (Input terminal 11)	An "external fault" was input from a multi-function input.	<ul style="list-style-type: none"> Reset external fault inputs to the multi-function inputs. Remove the cause of the external fault.
EF4 (blinking)	External fault (Input terminal 12)		
EF5 (blinking)	External fault (Input terminal 13)		
EF6 (blinking)	External fault (Input terminal 14)		
EF7 (blinking)	External fault (Input terminal 15)		
EF8 (blinking)	External fault (Input terminal 16)		
CE MEMOBUS Com Err	Communications Error Normal reception was not possible for 2 s after received control data.	--	Check the communications devices and signals.
BUS Option Com Err	Option Card Transmission Error A communications error occurred in a mode where the run command or a frequency reference is set from an Transmission Option Card.	--	Check the Transmission Card and signals.
CALL Serial Com Call	SI-B Communications Error Control data was not normally received when power was turned ON.	--	Check the communications devices and signals.
E-15 Si-F/G Com Err	SI-F/G Communications Error Detected A communications error occurred in a mode where run or a frequency reference is set from an Transmission Option Card and E-15 is set to continue operation.	--	Check the communications signals.
EF0 Opt External Flt	DDS/SI-B External Error Detected An external error ware received from an Option Card when EF0 was set to continue operation.	--	Remove the cause of the external error.

9.1.3 Operation Errors

After the constants have been set, an operation error will occur if there is an invalid setting or a contradiction between two constant settings.

It won't be possible to start the Inverter until the constants have been set correctly. (The minor fault output and fault contact output will not operate, either.)

When an operation error has occurred, refer to the following table to identify and correct the cause of the errors.

Table 9.3 Operation Error Displays and Incorrect Settings

Display	Meaning	Incorrect settings
OPE01 kVA Selection	Incorrect Inverter capacity setting	The Inverter capacity setting doesn't match the Unit. (Contact your Yaskawa representative.)
OPE02 Limit	Constant setting range error	The constant setting is outside of the valid setting range.
OPE03 Terminal	Multi-function input selection error	One of the following errors has been made in the multi-function input (H1-01 to H1-06) settings: <ul style="list-style-type: none"> • The same setting has been selected for two or more multi-function inputs. • An up or down command was selected independently. (They must be used together.) • The up/down commands (10 and 11) and Accel/Decel Ramp Hold (A) were selected at the same time. • Speed Search 1 (61, maximum output frequency) and Speed Search 2 (62, set frequency) were selected at the same time. • External Baseblock NO (8) and External Baseblock NC (9) were selected at the same time. • The up/down commands (10 and 11) were selected while PID control (b5-01) was enabled. • The Terminal 36/39 Switch (1F) was selected, but the terminal 39 function selector (H3-09) wasn't set to frequency reference (1F).
OPE05 Sequence Select	Option Card selection error	The Option Card was selected as the frequency reference source by setting b1-01 to 3, but an Option Card isn't connected.
OPE06 PG Opt Missing	Control method selection error	<ul style="list-style-type: none"> • V/f control with PG feedback was selected by setting A1-02 to 1, but a PG Speed Control Card isn't connected. • Flux vector control was selected by setting A1-02 to 3, but a PG Speed Control Card isn't connected.
OPE07 Analog Selection	Multi-function analog input selection error	<ul style="list-style-type: none"> • The same setting (other than 1F) has been selected for H3-05 and H3-09. • An A1-14B Analog Reference Card is being used and F2-01 is set to 0, but a multi-function input (H1-01 to H1-06) has been set to Option/Inverter Selection (2).
OPE08 Elevator Table	Constant selection error	A setting has been made that is not required in the current control method. Ex.: A function used only with flux vector control was selected for open-loop vector control.
OPE10 V/f Ptrn Setting	V/f data setting error	Constants E1-04, E1-06, E1-07, and E1-09 do not satisfy the following conditions: <ul style="list-style-type: none"> • $E1-04 (FMAX) \geq E1-06 (FA) \geq E1-07 (FB) \geq E1-09 (FMIN)$
OPE11 CarrFrg/On-Delay	Constant setting error	One of the following constant setting errors exists. <ul style="list-style-type: none"> • The carrier frequency upper limit (C6-01) > 5 KHz and the carrier frequency lower limit (C6-02) \geq 5 KHz. • The carrier frequency gain (C6-03) > 6 and (C6-01) > (C6-02). • Upper/lower limit error in C6-01 to 03 or C8-15.
ERR EEPROM R/W Err	EEPROM write error	A verification error occurred when writing EEPROM. <ul style="list-style-type: none"> • Try turning the power supply off and on again. • Try setting the constants again.

9.2 Troubleshooting

Due to constant setting errors, faulty wiring, and so on, the Inverter and motor may not operate as expected when the system is started up. If that should occur, use this section as a reference and apply the appropriate measures.

If the contents of the fault are displayed, refer to *9.1 Protective and Diagnostic Functions*.

9.2.1 If Constant Constants Cannot Be Set

■ The display does not change when the Increment and Decrement Keys are pressed.

1. Passwords do not match. (Only when a password is set.)

- If the constant A1-04 (Password 1) and A1-05 (Password 2) numbers are different, the constants for the initialize mode cannot be changed. Reset the password.
- If you cannot remember the password, display A1-05 (select password) by pressing the Reset/Select Key and the Menu Key simultaneously while in the A1-04 display. Then reset the password. (Input the reset password in constant A1-04.)

2. Constant write enable is input.

- This occurs when “constant write enable” (set value: 1B) is set for a multi-function input. If the constant write enable input is OFF, the constants cannot be changed. Turn it ON and then set the constants.

3. The Inverter is operating (drive mode).

- There are some constants that cannot be set during operation. Turn the Inverter off and then make the settings.

■ OPE01 through OPE11 is displayed.

- This is a constant setting error. The set value for the constant is wrong. Refer to *9.1.3 Operation Errors* and correct the setting.

■ CPF00 or CPF01 is displayed.

- This is a Digital Operator communications error. The connection between the Digital Operator and the Inverter may be faulty. Remove the Digital Operator and then re-install it.

9.2.2 If the Motor Does Not Operate

■ The motor does not operate when the Run Key on the Digital Operator is pressed.

IMPORTANT

If the Inverter is not in drive mode, it will remain in ready status and will not start. Press the Menu Key to display the operation mode, and enter the drive mode by pressing the Enter Key.

1. The operation method setting is wrong.

- If constant b1-02 (run source) is set to “1” (control circuit terminal), the motor will not operate when the Run Key is pressed. Either press the Local/Remote Key* to switch to Digital Operator operation or set constant b1-02 to “0” (Digital Operator).
 - * The Local/Remote Key is enabled (set value: 1) or disabled (set value: 2) by means of constant o2-01. It is enabled when the drive mode is entered.

2. The frequency reference is too low.

- If the frequency reference is set below the frequency set in E1-09 (minimum output frequency), the Inverter will not operate. Raise the frequency reference to at least the minimum output frequency. (Related constant: b1-05)

3. There is a multi-function analog input setting error.

- If multi-function analog inputs H3-05 and H3-09 are set to “1” (frequency gain), and if no voltage (current) is input, then the frequency reference will be zero. Check to be sure that the set value and analog input value are correct.

4. Frequency reference 2 is specified with multi-step speed operation, and auxiliary frequency reference is not input.

- If multi-function analog input H3-05 is set to “0” (auxiliary frequency reference), and if multi-step speed reference is used, the auxiliary frequency reference will be treated as frequency reference 2. Check to be sure that the set value and analog input value (terminal 42) are correct.

5. A digital setting was made for frequency reference 2 for multi-step speed operation, but “1F” was not set for a multi-function analog input (H3-05).

- The auxiliary frequency reference is treated as frequency reference 2 when the multi-step speed references are used and “0” (auxiliary frequency reference) is set for the multi-function analog input (H3-05).
- Make sure that “1F” is set for the multi-function analog input (H3-05) and that the setting of frequency reference 2 is appropriate.

■ **The motor does not operate when an external operation signal is input.**

IMPORTANT

If the Inverter is not in operation mode, it will remain in ready status and will not start. Press the Menu Key to display the drive mode, and enter the drive mode by pressing the Enter Key.

1. The operation method selection is wrong.

- If constant b1-02 (run source) is set to “0” (Digital Operator), the motor will not operate when an external operation signal is input. Set b1-02 to “1” (control circuit terminal) and try again.
- Similarly, the motor will also not operate if the Local/Remote Key has been pressed to switch to Digital Operator operation. In that case press the Local/Remote Key* again to return to the original setting.
** The Local/Remote Key is enabled (set value: 1) or disabled (set value: 2) by means of constant o2-01. It is enabled when drive mode is entered.

2. A 3-wire sequence is in effect.

- The input method for a 3-wire sequence is different than when operating by forward/stop and reverse/stop (2-wire sequence). When 3-wire sequence is set, the motor will not operate even when an input terminal suitable for forward run/stop and reverse run/stop is turned ON.
- When using a 3-wire sequence, refer to the timing chart on page 6 - 14 and input the proper signals.
- When using a 2-wire sequence, set multi-function inputs H1-01 through H1-06 to a value other than 0.

3. The frequency reference is too low.

- If the frequency reference is set below the frequency set in E1-09 (minimum output frequency), the Inverter will not operate.
Raise the frequency reference to at least the minimum output frequency. (Related constant: b1-05)

4. There is a multi-function analog input setting error.

- If multi-function analog inputs H3-05 and H3-09 are set to “1” (frequency gain), and if no voltage (current) is input, then the frequency reference will be zero. Check to be sure that the set value and analog input value are correct.

5. Frequency reference 2 is specified with multi-step speed operation and auxiliary frequency reference is not input.

- If multi-function analog input H3-05 is set to “0” (auxiliary frequency reference) and if multi-step speed reference is used, the auxiliary frequency reference will be treated as frequency reference 2. Check to be sure that the set value and analog input value (terminal 42) are correct.

6. A digital setting was made for frequency reference 2 for multi-step speed operation, but “1F” was not set for a multi-function analog input (H3-05).

- The auxiliary frequency reference is treated as frequency reference 2 when the multi-step speed references are used and “0” (auxiliary frequency reference) is set for the multi-function analog input (H3-05).
- Make sure that “1F” is set for the multi-function analog input (H3-05) and that the setting of frequency reference 2 is appropriate.

■ **The motor stops during acceleration or when a load is connected.**

- The load may be too heavy. The Inverter has a stall prevention function and an automatic torque boost function, but the motor responsiveness limit may be exceeded if acceleration is too rapid or if the load is too heavy. Lengthen the acceleration time or reduce the load. Also consider increasing the motor capacity.

■ The motor only rotates in one direction.

- “Reverse run prohibited” is selected. If b1-04 (prohibition of reverse operation) is set to “1” (reverse run prohibited), the Inverter will not receive reverse run commands. To use both forward and reverse operation, set b1-04 to “0.”

9.2.3 If the Direction of the Motor Rotation is Reversed

- The motor output wiring is faulty. When the Inverter T1(U), T2(V), and T3(W) are properly connected to the motor T1(U), T2(V), and T3(W), the motor operates in a forward direction when a forward run command is executed. The forward direction depends on the manufacturer and the motor type, so be sure to check the specifications. Switching two wires among the T1(U), T2(V), and T3(W) will reverse the direction of rotation.

9.2.4 If the Motor Does Not Put Out Torque or If Acceleration is Slow

■ The torque limit has been reached.

- When a torque limit has been set in constants L7-01 to L7-04, no torque will be output beyond that limit. This can cause the torque to be insufficient, or the acceleration time to be too long. Check to be sure that the value set for the torque limit is suitable.
If the torque limit has been set by multi-function analog inputs H3-05 and H3-09 (set value: 10 to 13), check to be sure that the analog input value is suitable.

■ The stall prevention level during acceleration is too low.

- If the value set for L3-02 (stall prevention level during acceleration) is too low, the acceleration time will be too long. Check to be sure that the set value is suitable.

■ The stall prevention level during running is too low.

- If the value set for L3-06 (stall prevention level during running) is too low, the speed will drop before outputting torque. Check to be sure that the set value is suitable.

■ Autotuning not performed during vector control.

- Vector control is not effective without autotuning. Perform autotuning for motor unit separately or set constants obtained from calculations.

9.2.5 If the Motor Does Not Operate According to Reference

■ The motor runs faster than reference.

1. The frequency reference bias setting is wrong (the gain setting is wrong).

- The frequency reference bias set in constant H3-03 is added to the frequency reference. Check to be sure that the set value is suitable.

2. Frequency bias is set for multi-function analog inputs.

- When “2” (frequency bias) is set for multi-function analog inputs H3-05 and H3-09, a frequency corresponding to the input voltage (current) is added to the frequency reference. Check to be sure that the set value and analog input value are suitable.

3. A signal is being input to the frequency reference (current) terminal 39.

- When “1F” (frequency reference) is set for constant H3-09 (multi-function analog input terminal 39), a frequency corresponding to the terminal 39 input voltage (current) is added to the frequency reference. Check to be sure that the set value and analog input value are suitable.

■ The motor does not rotate according to reference.

- Torque control mode is selected. When constant d5-01 (torque control selection) is set to “1” (torque control), speed control cannot be executed. (Speed limits can be set.)
To switch torque control and speed control, set the following
 - Set constant d5-01 to “0” (speed control).
 - Set one of the constants from H1-01 through H1-06 (multi-function inputs) to “71” (speed/torque control change).

9.2.6 If the Slip Compensation Function Has Low Speed Precision

- The slip compensation limit has been reached. With the slip compensation function, compensation cannot be carried out beyond the slip compensation limit set in constant C3-03. Check to be sure that the set value is suitable.

9.2.7 If There is Low Speed Control Accuracy at High-speed Rotation in Open-loop Vector Control Mode

- The motor's rated voltage is high.
- The Inverter's maximum output voltage is determined by its input voltage. (For example, if 400 VAC is input, then the maximum output voltage will be 400 VAC.) If, as a result of vector control, the output voltage reference value exceeds the Inverter output voltage maximum value, the speed control accuracy will decrease. Either use a motor with a low rated voltage (i.e., a special motor for use with vector control) or change to flux vector control.

9.2.8 If Motor Deceleration is Slow

■ The deceleration time is long even when control resistance is connected.

1. "Stall prevention during deceleration enabled" is set.

- When control resistance is connected, set constant L3-04 (stall prevention selection during deceleration) to "0" (disabled). When this constant is set to "1" (enabled, the factory-set default), control resistance is not used.

2. The deceleration time setting is too long.

- Check the deceleration time setting (constants C1-02, C1-04, C1-06, and C1-08).

3. Motor torque is insufficient.

- If the constants are correct and there is no overvoltage fault, then the motor's power is limited. Consider increasing the motor capacity.

4. The torque limit has been reached.

- When a torque limit has been set in constants L7-01 to L7-04, no torque will be output beyond that limit. This can cause the deceleration time to be too long. Check to be sure that the value set for the torque limit is suitable.
- If the torque limit has been set by multi-function analog inputs H3-05 and H3-09 (set value: 10 to 13), check to be sure that the analog input value is suitable.

■ If the Vertical-axis Load Drops When Brake is Applied

- The sequence is incorrect.
- The Inverter goes into DC injection braking status for 0.5 seconds after deceleration is completed. (This is the factory-set default.)
- To ensure that the brake holds, set frequency detection 2 (H2-01 = 5) for the multi-function contact output terminals (53-57) so that the contacts will OPEN when the output frequency is greater than L4-01 (3.0 to 5.0 Hz). (The contacts will close below L4-01.)
- There is hysteresis in frequency detection 2 (L4-02 \square 2.0 Hz). Change the setting to approximately 0.5 Hz if there are drops during stop. Do not use the "running" signal (H2-01 = 0) for the brake ON/OFF signal.

9.2.9 If the Motor Overheats

■ The load is too big.

- If the motor load is too heavy and the motor is used with the effective torque exceeding the motor's rated torque, the motor will overheat. Some motor ratings are given for short period performance and are not continuous ratings. Reduce the load amount by either lightening the load or lengthening the acceleration/deceleration time. Also consider increasing the motor capacity.

■ The ambient temperature is too high.

- The motor rating is determined within a particular ambient operating temperature range. The motor will burn out if it is run continuously at the rated torque in an environment in which the maximum ambient operating temperature is exceeded. Lower the motor's ambient temperature to within the acceptable ambient operating temperature range.

■ The withstand voltage between the motor phases is insufficient.

- When the motor is connected to the Inverter output, a surge is generated between the Inverter switching and the motor coil. Normally the maximum surge voltage is three times the Inverter's input power supply voltage (i.e., 1,400 V for 575-V class). Be sure to use a motor with a withstand voltage between the motor phases that is greater than the maximum surge voltage. In particular, when using a 575-V class Inverter, use a special motor for Inverters.

■ Autotuning not performed during vector control.

- Vector control is not effective without autotuning. Perform autotuning for motor unit separately, or set control method selection (A1-02) to V/f control.

9.2.10 If There is Noise When the Inverter is Started or From an AM Radio

- If noise is generated by Inverter switching, implement the following countermeasures:
 - Install an Input Noise Filter at the Inverter's power supply input area.
 - Install an Output Noise Filter at the Inverter's power supply output area.
 - Use metal tubing. Electric waves can be shielded by metal, so encase the Inverter with metal (steel).
 - Ground the Inverter and motor.
 - Separate main circuit wiring from control wiring.

9.2.11 If the Ground Fault Interrupter Operates When the Inverter is Run

- The Inverter performs internal switching, so there is a certain amount of leakage current. This may cause the ground fault interrupter to operate and cut off the power supply. Change to a ground fault interrupter with a high leakage detection level (i.e., a sensitivity current of 200 mA or greater per Unit, with an operating time of 0.1 s or more), or one that incorporates high frequency countermeasures (i.e., one designed for use with Inverters).

In addition, remember that the leakage current increases as the cable is lengthened.

9.2.12 If There is Mechanical Oscillation

■ The machinery is making unusual sounds.

1. There may be resonance between the mechanical system's characteristic frequency and the carrier frequency.

- If the motor is running with no problems and the machinery is oscillating with a high-pitched whine, it may indicate that this is occurring. Use the jump frequency functions in constants d3-01 to d3-04 to reduce oscillation.

2. There may be resonance between a machine's characteristic frequency and the output frequency of the Inverter.

- To prevent this from occurring, either use the jump frequency functions in constants d3-01 to d3-04 or install rubber padding on the motor base to reduce oscillation.

■ Oscillation and hunting are occurring with open-loop vector control.

- The gain adjustment may be insufficient. Reset the gain to a more effective level by adjusting constants C4-02 (torque compensation time constant), C8-08 (AFR gain), and C3-02 (slip compensation primary delay time) in order. Lower the gain setting and raise the primary delay time setting.
- Vector control is not effective without autotuning. Perform autotuning for motor unit separately or set the motor constants obtained from calculations.

■ Oscillation and hunting are occurring with V/f control.

- The gain adjustment may be insufficient. Reset the gain to a more effective level by adjusting constants C4-02 (torque compensation time constant), C7-02 (hunting prevention gain), and C3-02 (slip compensation primary delay time) in order. Lower the gain setting and raise the primary delay time setting.

■ Oscillation and hunting are occurring with flux vector control.

- The gain adjustment may be insufficient. Adjust the various types of speed control loop (ASR) gain. (For details, refer to page 6 - 36.)
- If the mechanical system's resonance point coincides with the Inverter's operating frequency and the oscillation cannot be eliminated in this way, increase the ASR primary delay time (constant C5-06) and then try adjusting the gain again.
- Vector control is not effective without autotuning. Perform autotuning for motor unit separately or set the motor constants obtained from calculations.

■ Oscillation and hunting are occurring with V/f w/PG control.

- The gain adjustment may be insufficient. Adjust the various types of speed control loop (ASR) gain. (For details, refer to page 6 - 44.)
- If the oscillation cannot be eliminated in this way, set the hunting prevention selection (constant C7-01) to "0" (disabled) and then try adjusting the gain again.

9.2.13 If the Motor Rotates Even When Inverter Output is Stopped

■ **Oscillation and hunting are occurring with PID control.**

- Check the oscillation cycle and individually adjust the P, I, and D. (Refer to page 7 - 47.)

■ **Autotuning not performed during vector control.**

- Vector control is not effective without autotuning. Perform autotuning for motor unit separately or set the motor constants obtained from calculations.

9.2.13 If the Motor Rotates Even When Inverter Output is Stopped

- The DC injection braking is insufficient. If the motor continues operating at low speed, without completely stopping, and after a deceleration stop has been executed, it means that the DC injection braking is not decelerating enough. Adjust the DC injection braking as follows:
 - Increase the constant b2-02 (DC injection braking current) setting.
 - Increase the constant b2-04 (DC injection braking time at stop) setting.

9.2.14 If 0 V is Detected When the Fan is Started, or Fan Stalls

- Generation of 0 V and stalling can occur if the fan is turning when it is started. The DC injection braking is insufficient when starting.
- This can be prevented by slowing fan rotation by DC injection braking before starting the fan. Increase the constant b2-03 (DC injection braking time at start) setting.

9.2.15 If Output Frequency Does Not Rise to Frequency Reference

■ **The frequency reference is within the jump frequency range.**

- When the jump frequency function is used, the output frequency does not change within the jump frequency range.
- Check to be sure that the jump frequency (constants d3-01 to d3-03) and jump frequency width (constant d3-04) settings are suitable.

■ **The frequency reference upper limit has been reached.**

- The output frequency upper limit is determined by the following formula:
Maximum output frequency (E1-04) × Frequency reference upper limit (d2-01) / 100
- Check to be sure that the constant E1-04 and d2-01 settings are suitable.

10

Maintenance and Inspection

This chapter describes basic maintenance and inspection for the VS-616G5 Inverters.

10.1	Maintenance and Inspection	10 - 3
10.1.1	Daily Inspection	10 - 3
10.1.2	Periodic Inspection	10 - 3
10.1.3	Periodic Maintenance of Parts	10 - 3
10.1.4	Replacement of In-panel Ventilation Fan Unit	10 - 4
10.1.5	Dismounting and Mounting the Module	10 - 6



WARNING

- Do not touch the Inverter Panel terminals. Some of the terminals carry high voltages and are extremely dangerous.
Touching the terminals can result in electric shock.
- Always have the protective cover in place when power is being supplied to the Inverter. When attaching the cover, always turn OFF power to the Inverter through the MCCB.
Doing so can result in electric shock.
- After turning OFF the main circuit power supply, wait until the CHARGE indicator light goes out before performance maintenance or inspections.
The capacitor will remain charged and is dangerous.
- Maintenance, inspection, and replacement of parts must be performed only by authorized personnel. Remove all metal objects, such as watches and rings, before starting work. Always use grounded tools.
Failure to heed these warning can result in electric shock.



CAUTION

- A CMOS IC is used in the control board. Handle the control board and CMOS IC carefully. The CMOS IC can be destroyed by static electricity if touched directly.
The CMOS IC can be destroyed by static electricity if touched directly.
- Do not change the wiring, or remove connectors or the Digital Operator, during operation.
Doing so can result in personal injury.

10.1 Maintenance and Inspection

The maintenance period of the Inverter is as follows:

Maintenance Period: Within 18 months of shipping from the factory or within 12 months of being delivered to the final user, whichever comes first.

10.1.1 Daily Inspection

Check the following items with the system in operation.

- The motor should not be vibrating or making unusual noises.
- There should be no abnormal heat generation.
- The ambient temperature should not be too high.
- The output current value shown on the monitor display should not be higher than normal.
- In-panel ventilation fan unit placed at the top of the Inverter Panel should be operating normally.
- The cooling fan attached to the Module should be operating normally.

IMPORTANT

Open the door only when checking the cooling fan operation. Do not open the door when not conducting inspection.

10.1.2 Periodic Inspection

Check the following items during periodic maintenance.

Always turn OFF the power supply before beginning inspection. Confirm that the LED indicators on the front door have all turned OFF, and then wait until at least five minutes has elapsed before beginning the inspection. Be sure not to touch terminals right after the power has been turned off. Doing so can result in electric shock.

Table 10.1 Periodic Inspections

Item	Inspection	Corrective Procedure
External terminals, mounting bolts, connectors, etc.	Are all screws and bolts tight?	Tighten loose screws and bolts firmly.
	Are connectors tight?	Reconnect the loose connectors.
Cooling fins	Are the fins dirty or dusty?	Clean off any dirt and dust with an air gun using dry air at a pressure of 39.2×10^4 to 58.8×10^4 Pa (4 to 6 kg•cm ²).
PCBs	Is there any conductive dirt or oil mist on the PCBs?	Clean off any dirt and dust with an air gun using dry air at a pressure of 39.2×10^4 to 58.8×10^4 Pa (4 to 6 kg•cm ²). Replace the boards if they cannot be made clean.
Cooling fan, in-panel ventilation fan unit	Is there any abnormal noise or vibration or has the total operating time exceeded 20,000 hours?	Replace the cooling fan or in-panel ventilation fan unit.
Power elements	Is there any conductive dirt or oil mist on the elements?	Clean off any dirt and dust with an air gun using dry air at a pressure of 39.2×10^4 to 58.8×10^4 Pa (4 to 6 kg•cm ²).
Smoothing capacitor	Are there any irregularities, such as discoloration or odor?	Replace the capacitor or Inverter Module.

10.1.3 Periodic Maintenance of Parts

The Inverter Panel is configured of many parts, and these parts must be operating properly in order to make full use of the Inverter functions.

Among the electronic components, there are some that require maintenance depending on their usage conditions. To keep the Inverter Panel operating normally over a long period of time, it is necessary to perform period inspections and replace parts according to their service life.

Periodic inspection standards vary depending the Inverter Panel's installation environment and usage conditions. The Inverter Panel's maintenance periods are given below. Keep them as reference.

10.1.4 Replacement of In-panel Ventilation Fan Unit

Table 10.2 Part Replacement Guidelines

Part	Standard Replacement Period	Replacement Method
Cooling fan, in-panel ventilation fan unit	2 to 3 years	Replace with new part.
Smoothing capacitor	5 years	Replace with new part. (Determine need by inspection.)
Breaker relays	—	Determine need by inspection.
Fuses	10 years	Replace with new part.
Aluminum capacitors on PCBs	5 years	Replace with new board. (Determine need by inspection.)

Note Usage conditions are as follows:

- Ambient temperature: Yearly average of 30°C
- Load factor: 80% max.
- Operating rate: 12 hours max. per day

10.1.4 Replacement of In-panel Ventilation Fan Unit

A fan unit is located on the ceiling of the Panel for dissipating heat generated inside the Panel. Periodically replace the fan unit according to the following procedure.

1. Turn OFF the fan unit circuit protector located at the top of the Panel.

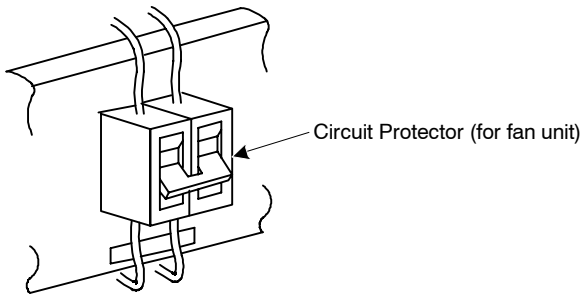

Fig 10.1 Fan Unit Circuit Protector

2. Remove the fan unit cover mounting screws (six M5 screws) and then lift the cover.

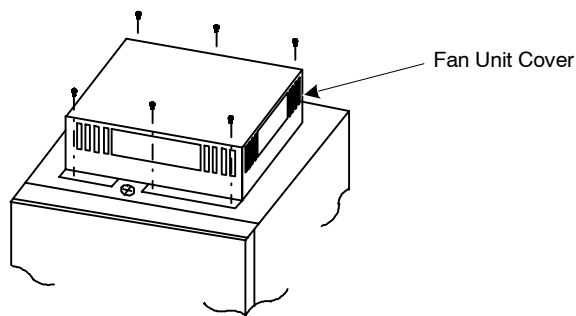

Fig 10.2 In-panel Ventilation Fan Mounted on Ceiling

3. Detach wirings from the Panel and remove the fan unit.

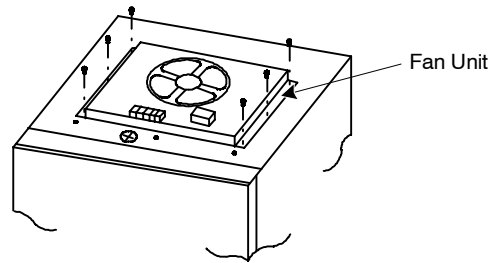



Fig 10.3 Removal of In-panel Ventilation Fan Unit

4. Mount a new fan unit in the procedure reverse to the above.

10.1.5 Dismounting and Mounting the Module

 WARNING
<ul style="list-style-type: none">● Before mounting or dismounting a Module, make sure that the main circuit and control power supply have been turned OFF. Not doing so can result in electric shock.● Do not dismount a Module until the CHARGE lamp on the Module turns OFF after turning OFF the power supply. An electric shock may occur if the Module is dismounted while still charged.● Use special lifts for mounting or dismounting the Module. Not doing so can result in injury.● The Modules are heavy, and mounting or dismounting the Modules must be performed by three workers: One to operate the lift and two others for mounting and dismounting the Modules. Not doing so can result in injury

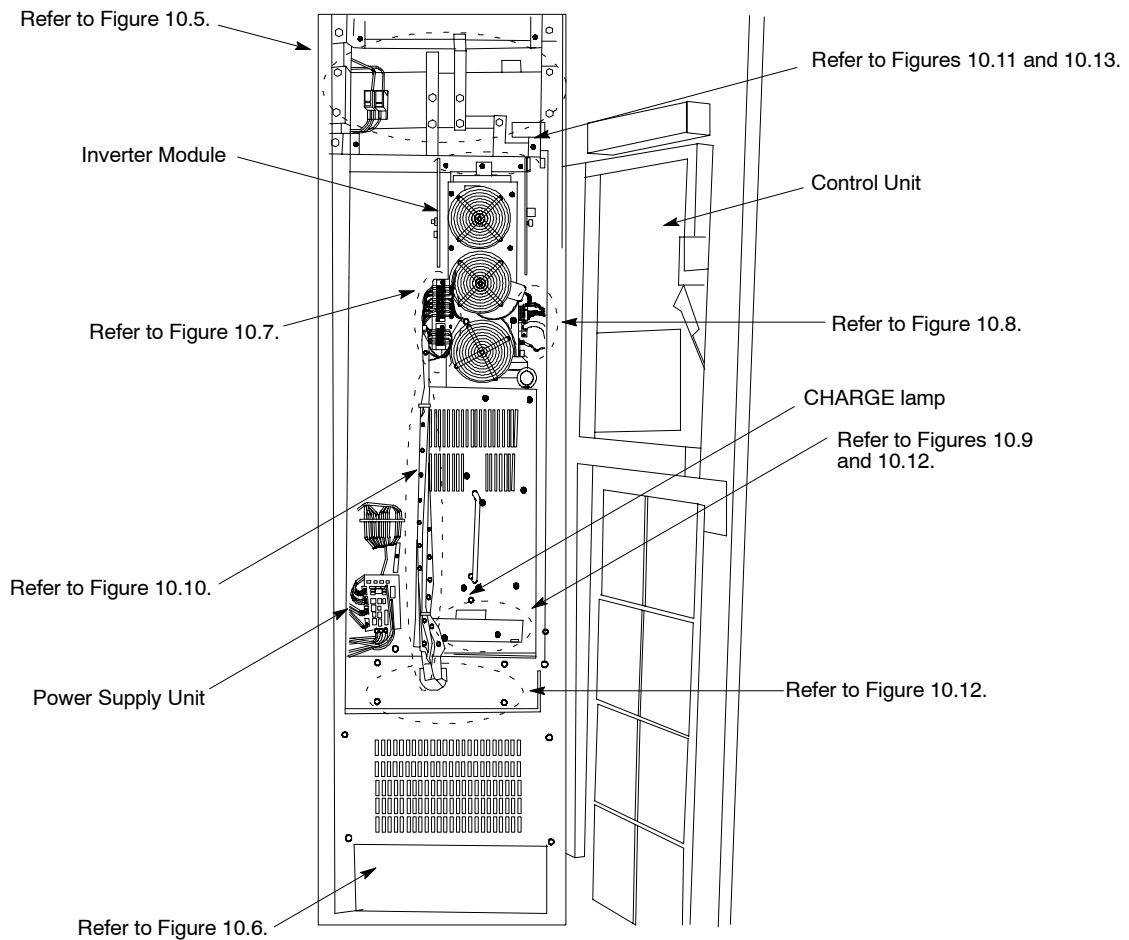

Fig 10.4 Inverter Panel

■ Dismounting the Module

Dismount the Module according to the following procedure.

1. Loosen the M5 screws shown in Figures 10.5 and 10.6, and then remove the protective cover.

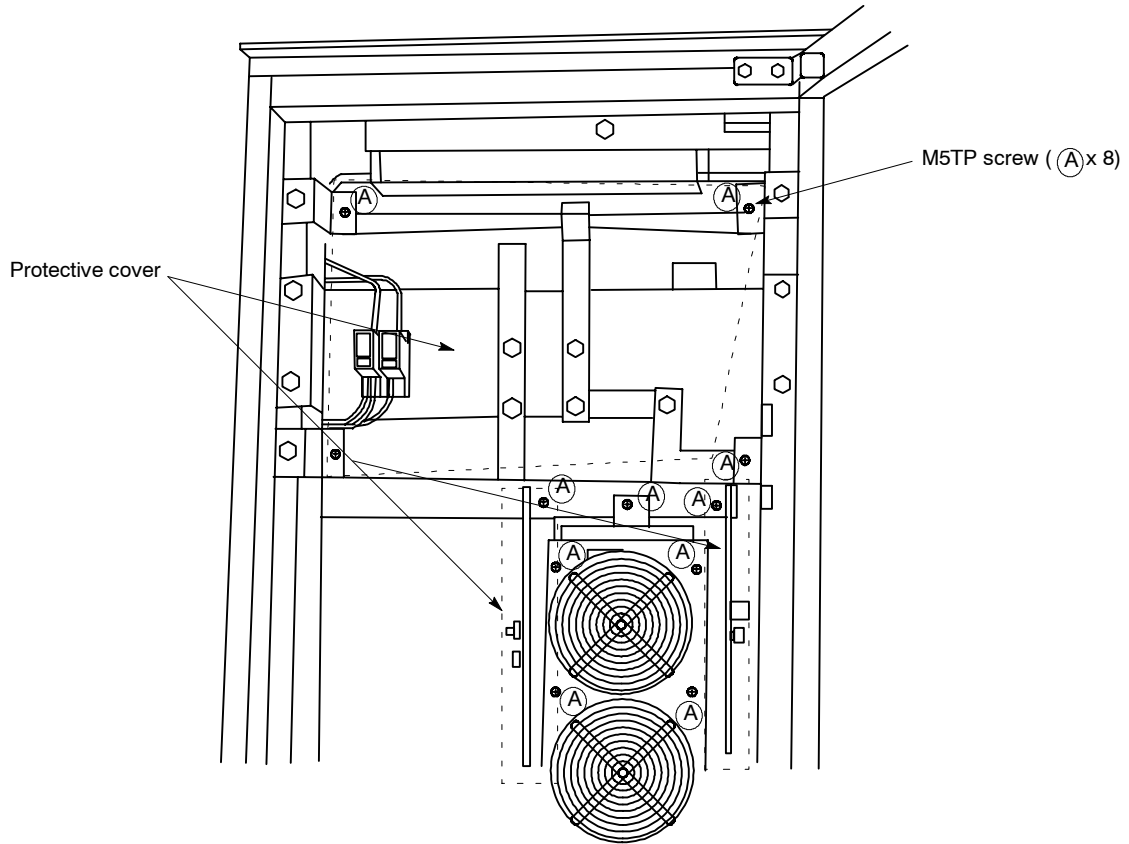

Fig 10.5

2. Remove the protective cover of the fan terminals TB1 and TB2 of the Module.

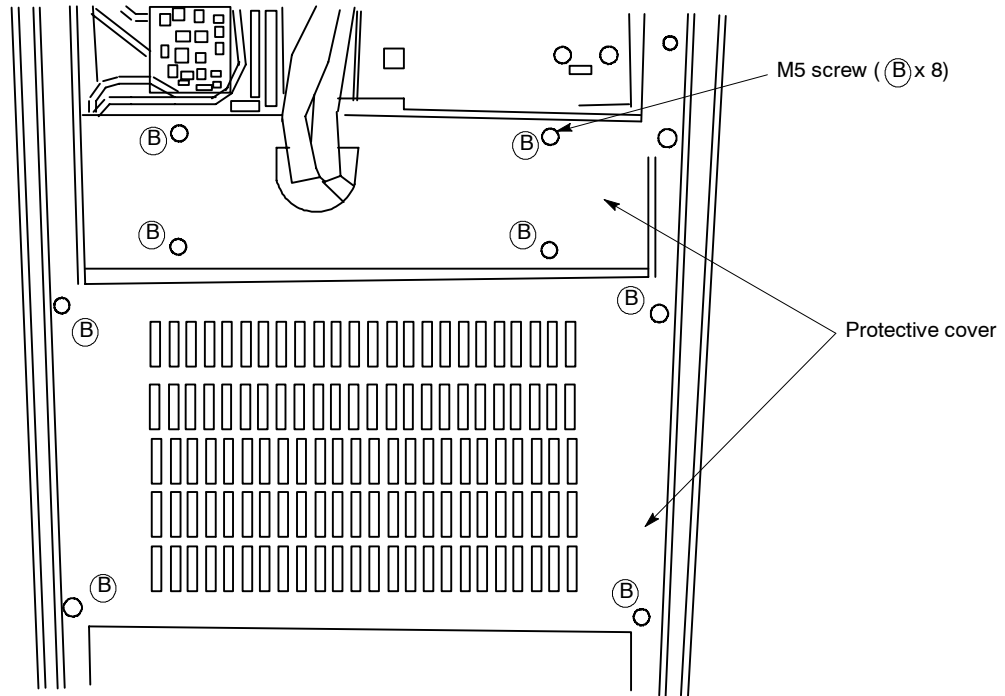

Fig 10.6

3. Remove the wires (with white lead name) connecting between the Inverter Panel and “7” and “8” of TB1 and “3” and “4” of TB2.
4. Remove the protective cover mounting screws (M4 round head screws) and then remove the cover.

5. After removing the terminal screws, remove wires.

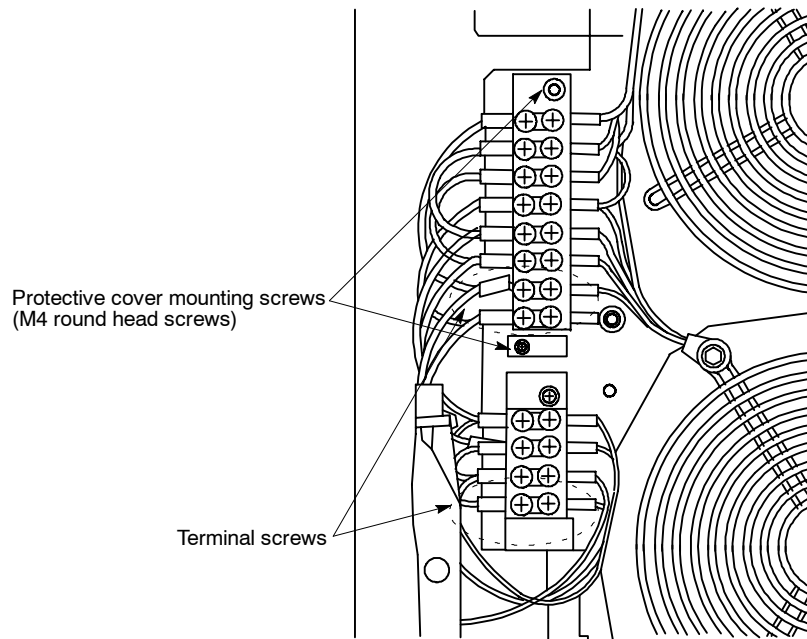

Fig 10.7

6. Remove wires from the PCB located on the right side of the Module. Remove the following connectors.
 30CN (3-pin VH connector)
 15CN (6-pin VH connector)
 7CN (MDR plug, M2.6 screw)
 SG (M4 round head screws)

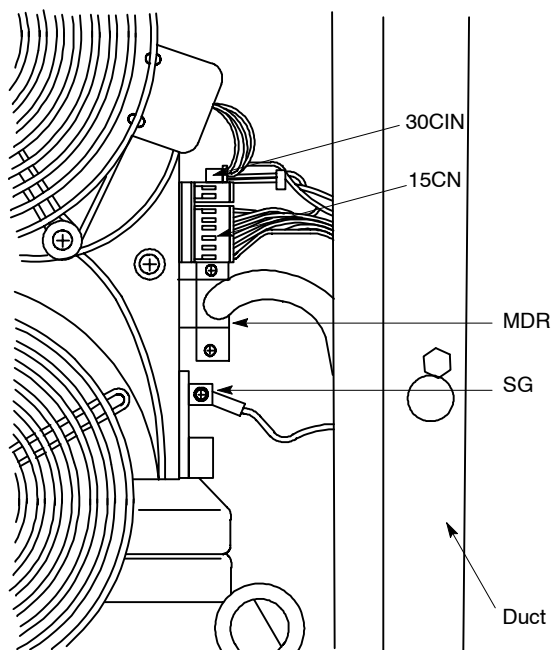

Fig 10.8

7. Remove M6 screws, washers, and S washers to detach the Module mounting bracket. Also remove the M8 grounding bolt and the grounding wire.

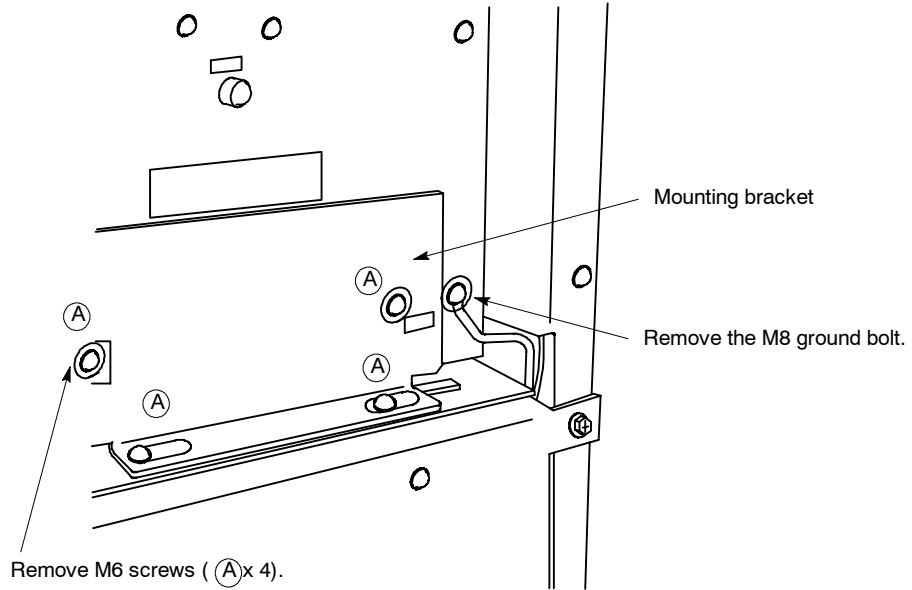

Fig 10.9

8. Cut the lock used for fixing the wiring duct.

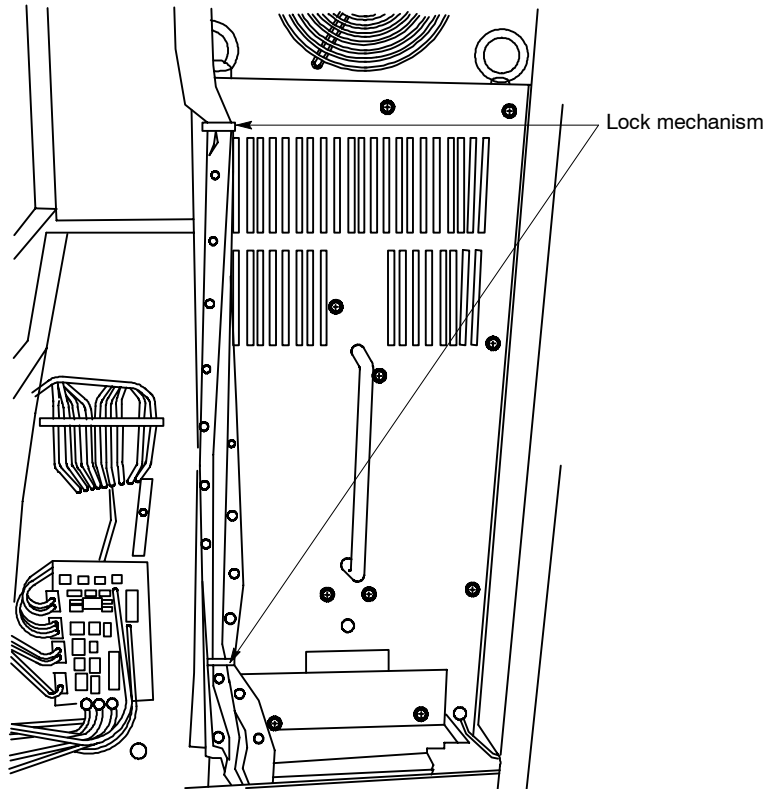

Fig 10.10

9. Remove M12 nuts, washers, S washers, and M12x38 square thread bolts used for connecting the “+” and “-” bus bar of the Module.

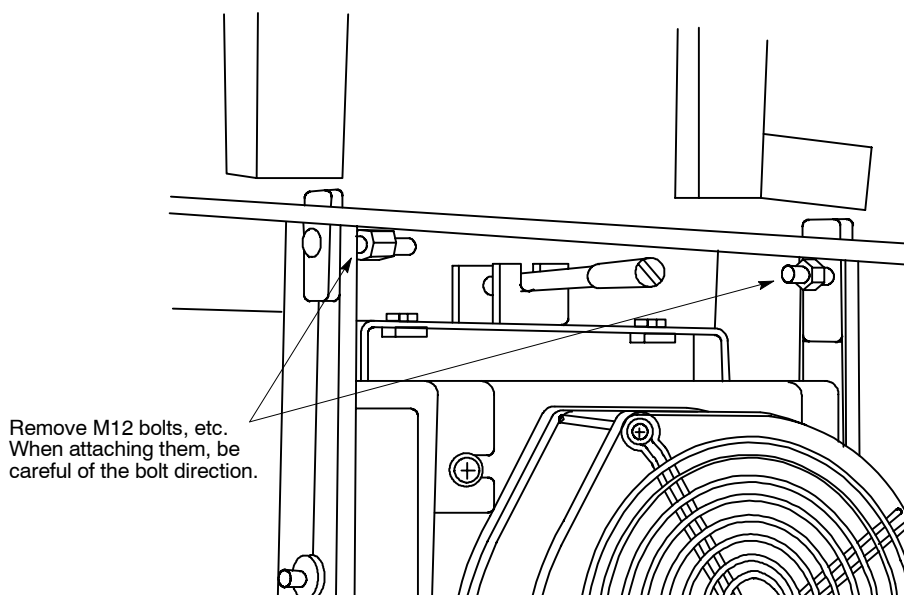

Fig 10.11

10. Remove M12 nuts, washers, S washers, and M12x38 square thread bolts used for connecting the U/V/W bus bar of the Module and the bus bar on the Inverter Panel.

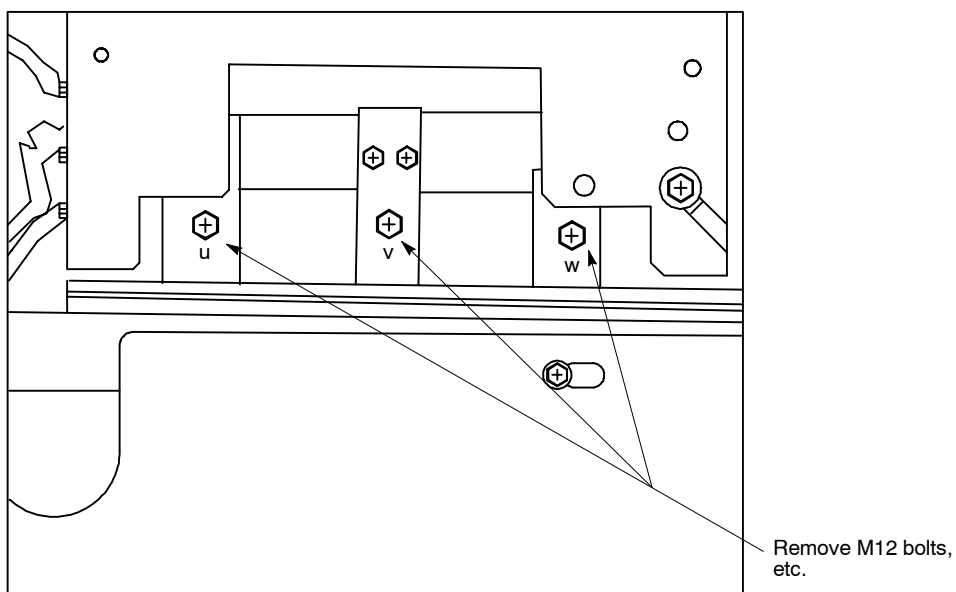

Fig 10.12

10.1.5 Dismounting and Mounting the Module

11. Loosen the fixing bolt at the top of the Module.

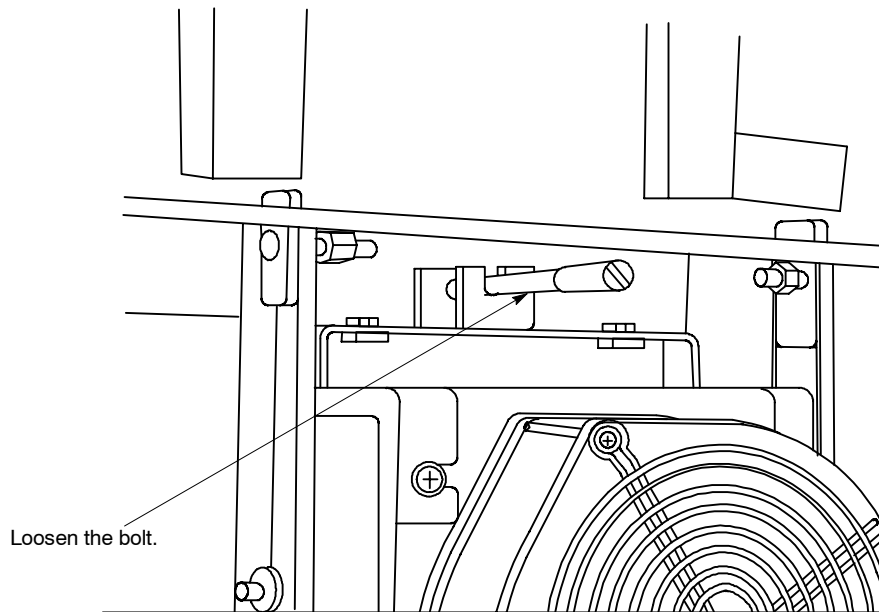

Fig 10.13

■ Drawing Out the Module

Draw out the Module using the following procedure.

1. Adjust the rack height using the up/down handle of the Module draw-out lift.

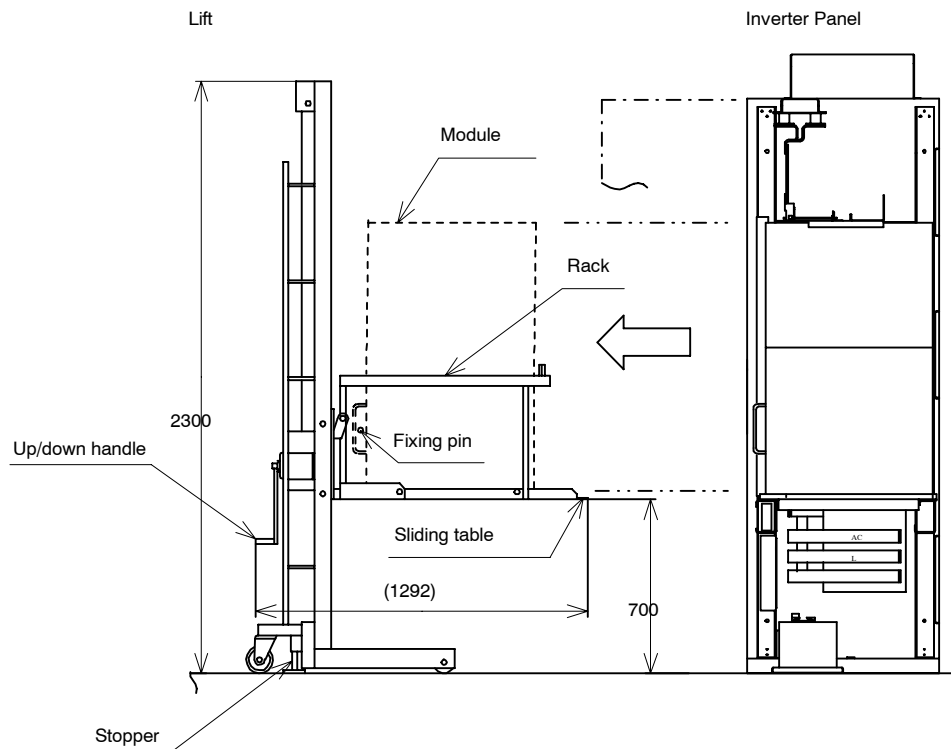

Fig 10.14 Special Lift

2. Insert the sliding table between the Panel beam and the module mounting base.

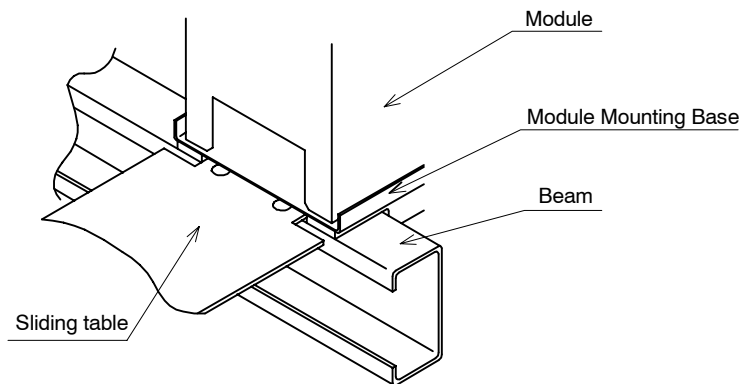

Fig 10.15 Sliding Table Insertion

3. Hook the lifter stopper and, while pressing the sliding table so that it will not move when the Module is pulled out, draw out the Module.
4. Insert the fixing pin into the module holder to keep the Module stationary and then lower the rack.

■ Mounting the Module

Mount the Module by reversing the above module dismounting and drawing out procedure.

■ **Disposing of the Module**



WARNING

- Before disposing of the Module, open a hole in the heat sink attached to the Module to purge gas. Exposing the heat sink to a high temperature without opening a hole in the heat sink can result in explosion and injury.

Before disposing of the Module, cut the refrigerant charging port and open a hole in the heat sink.

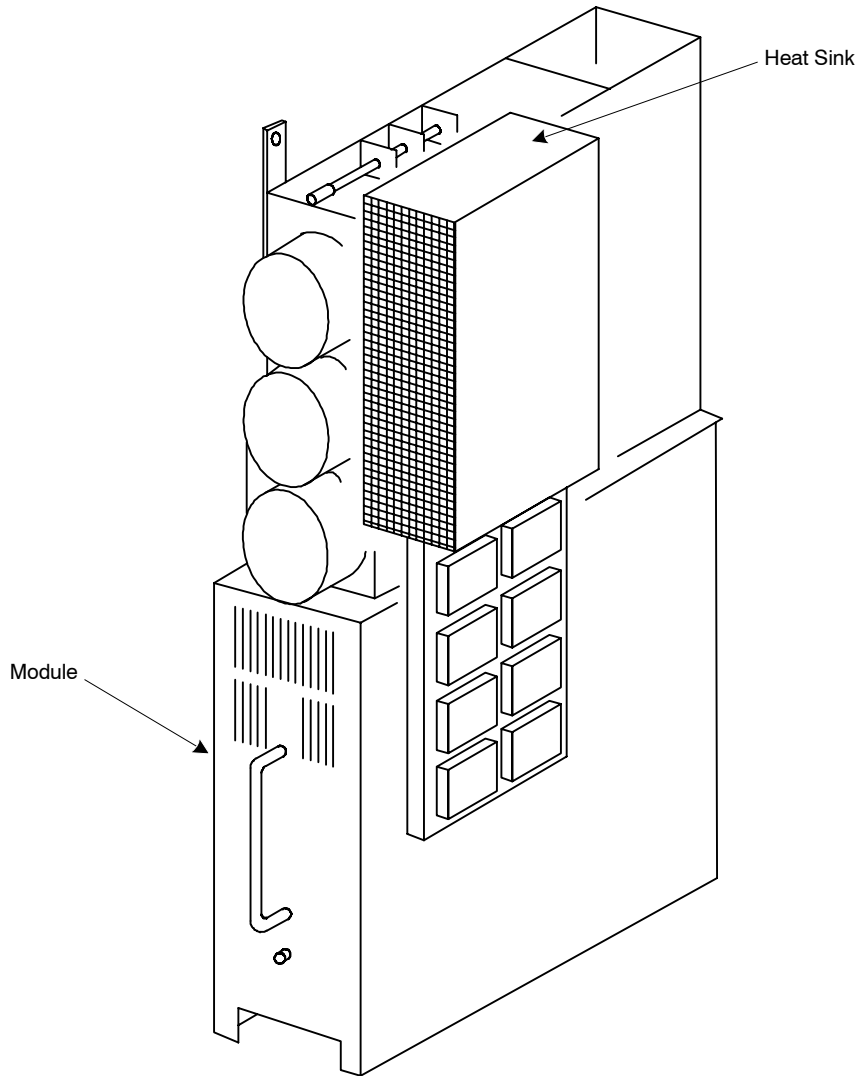
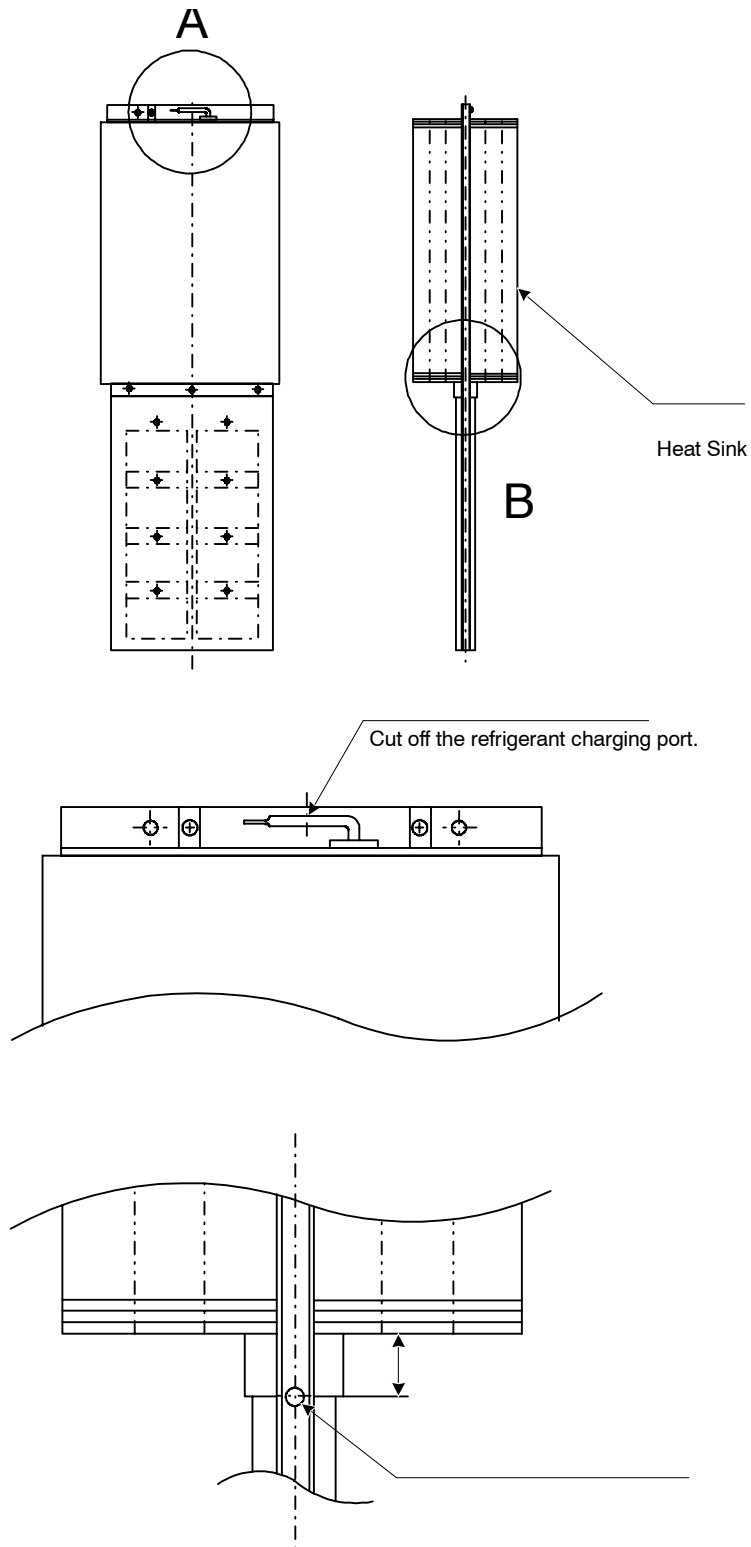

Fig 10.16 Heat Sink



Maintenance and Inspection

10.1.5 Dismounting and Mounting the Module

Purging Gas



11

Specifications

This chapter describes the basic specifications of the VS-616G5 Inverters and specifications for options and peripheral devices.

11.1 Standard Inverter Specifications	11 - 2
11.2 Specifications of Options and Peripheral Devices	11 - 4
11.2.1 Selection of MCCB and Ground Fault Interrupter	11 - 4
11.2.2 Module Draw-out Lift	11 - 4
11.2.3 Option Cards	11 - 6

11.1 Standard Inverter Specifications

Table 11.1 Standard Inverter Specifications

Model number CIMR-G5A <input type="checkbox"/>		400-V Class Inverters				575-V Class Inverters			
		42008	44008	46008	48008	53008	56008	59008	512C8
Max. applicable motor output (kW)		200	400	600	800	300	600	900	1200
Output ratings	Rated output capacity (kVA)	320	610	910	1200	410	800	1200	1600
	Rated output current (A)	414	800	1200	1600	414	800	1200	1600
	Max. output voltage (V)	3-phase, 380/400/415/440/460 VAC (Proportional to input voltage.)				3-phase, 500/525/575/600 VAC (Proportional to input voltage.)			
	Rated output frequency (Hz)	Up to 150 Hz (available by programming)							
Power supply characteristics	Voltage (V) Frequency (Hz)	3-phase, 380/400/415/440/460VAC, 50/60 Hz				3-phase, 500/525/575/600 VAC, 50/60 Hz			
	Allowable voltage fluctuation	+10%, -15%							
	Allowable frequency fluctuation	± 5%							
Control characteristics	Control method	Sine wave PWM							
	Torque characteristics (see notes 1, 2)	150% at 1 Hz (150% at 0 r/min with PG)							
	Speed control range (see notes 1, 2)	1: 100 (1: 1000 with PG)							
	Speed control accuracy (see notes 1, 2)	± 0.2% (± 0.02% with PG)							
	Speed control response (see notes 1, 2)	5 Hz (30 Hz with PG)							
	Torque limits	Provided (4 quadrant steps can be changed by constants settings.)							
	Torque accuracy	± 10%							
	Frequency control range	0.1 to 150 Hz							
	Frequency accuracy (temperature characteristics)	Digital references: ± 0.01% (-10°C to +40°C)							
		Analog references: ± 0.1% (25°C ± 10°C)							
	Frequency setting resolution	Digital references: 0.01 Hz							
		Analog references: 0.03 Hz/60 Hz (11 bits + sign)							
	Output frequency resolution	0.01 Hz							
	Overload capacity	150% of rated current for one minute							
Frequency setting signal	-10 to 10 V, 0 to 10 V, 4 to 20 mA								
Acceleration/Deceleration time	0.01 to 6000.0 s (Accel/decel time setting independently, 4 steps available.)								
Braking torque	Approx. 20%								

Model number CIMR-G5A <input type="checkbox"/>		400-V Class Inverters				575-V Class Inverters			
		42008	44008	46008	48008	53008	56008	59008	512C8
Protective functions	Motor protection	Protection by electronic thermal overload relay.							
	Instantaneous over-current protection	Stops at approx. 200% of rated output current.							
	Fuse blown protection	Stops for fuse blown.							
	Overload protection	Stops in one minute at approx. 150% of rated output current.							
	Main circuit overvoltage protection	Stops when main-circuit DC voltage is approx. 820 V.				Stops when main-circuit DC voltage is approx. 1040 V.			
	Main circuit undervoltage protection	Stops when main-circuit DC voltage is approx. 380 V.				Stops when main-circuit DC voltage is approx. 480 V.			
	Momentary power loss ridethru	Stops for 15 ms or more. By selecting the momentary power loss mode, operation can be continued if power is restored within 2 s.							
	Cooling fin overheating	Protection by thermistor.							
	Stall prevention	Stall prevention during acceleration, deceleration, or running.							
	Grounding protection	Protection by electronic circuits. (Overcurrent level)							
Environment	Charge indicator (internal LED)	Lit when the main circuit DC voltage is approx. 50 V or more.							
	Ambient operating temperature	-10° to 40°C							
	Ambient operating humidity	90 % RH max. (no condensing)							
	Storage temperature	-20°C to +60°C							
	Application site	Indoor (no corrosive gas, dust, etc.)							
	Altitude	1000 m max.							
	Vibration	2 m/s ² (0.2G) max							

Note 1. Autotuning is sometimes required.

2. Operate in the flux vector control or open-loop vector control mode. Operation in the V/f control mode should be avoided.

11.2 Specifications of Options and Peripheral Devices

11.2.1 Selection of MCCB and Ground Fault Interrupter

Be sure to install an MCCB or ground fault interrupter on the power supply side in order to protect the Inverter wirings.

When using an MCCB, use one that has the sensitivity current of 200 mA min. and operation time of 0.1 s min. and also that incorporates countermeasures against harmonics.

The following tables show MCCB selection examples.

■ 400-V Class Inverters

VS-616G5 Model CIMR-G5A□	Output Capacity (kVA)	Rated Output Current (A)	MCCB Model	Rated Current (A)
4200	320	414	NF600	600
4400	610	800	NF1200	1200
4600	910	1200	NF2000	1800
4800	1200	1600	NF2500	2500

■ 575-V Class Inverters

VS-616G5 Model CIMR-G5A□	Output Capacity (kVA)	Rated Output Current (A)	MCCB Model	Rated Current (A)
5300	410	414	NF600	600
5600	800	800	NF1200	1200
5900	1200	1200	NF2000	1800
512C	1600	1600	NF2500	2500

11.2.2 Module Draw-out Lift

The following two lifts and a crane are available for drawing out the Module.

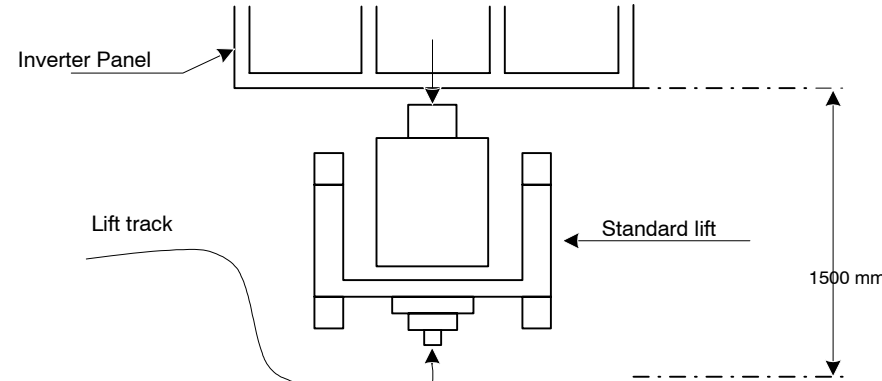
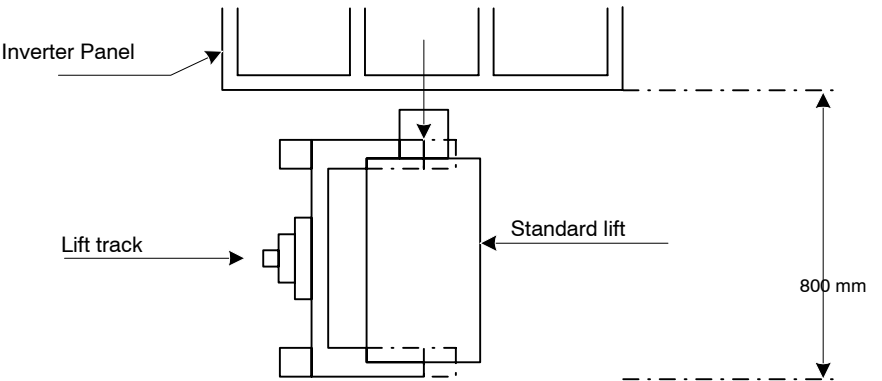
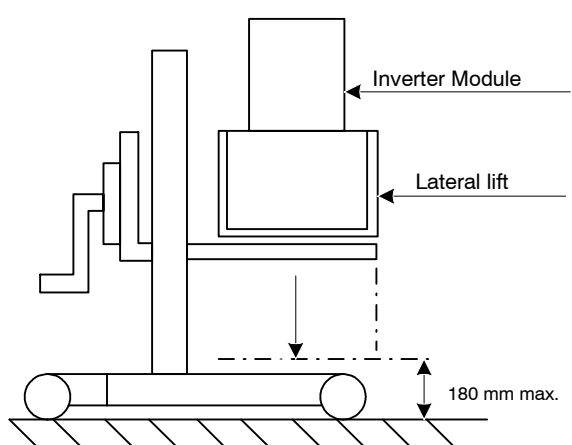
Name	Code No.	Application
Standard Lift (FC30604)	YLF000033	<p>Use this lift if the passage is wider than 1500 mm.</p>  <p>The diagram shows a cross-section of a lift system. At the top, an 'Inverter Panel' is mounted. Below it, a 'Standard lift' is positioned on a 'Lift track'. A vertical dimension line on the right indicates a clearance of 1500 mm between the bottom of the lift and the floor level.</p>
Lateral Lift (FC30497A)* ¹	YLF000032	<p>Use this lift when the passage is between 800 mm and 1500 mm.</p>  <p>The diagram shows a cross-section of a lift system. An 'Inverter Panel' is at the top. A 'Standard lift' is positioned on a 'Lift track'. A vertical dimension line on the right indicates a clearance of 800 mm between the bottom of the lift and the floor level.</p>
Portable Crane (FC30498)* ²	YLF000034	<p>Use this crane when lowering the Module from the lateral lift onto the floor. (Used in combination with the lateral lift.)</p>  <p>The diagram shows a side view of a crane mechanism. An 'Inverter Module' is being lowered from a 'Lateral lift' onto a floor. A vertical dimension line on the right indicates a maximum clearance of 180 mm between the floor and the bottom of the module.</p>

* 1. With the lateral lift, the Module cannot be lowered to the floor level. Therefore, use a crane to lower it down to the floor.
 * 2. This crane is not required if a crane is provided in the electrical room or if lowering down to a platform wider than 180 mm.

11.2.3 Option Cards

The following Option Cards are available.

Table 11.2 Option Cards

Type	Name	Code No.	Descriptions	Manual No.
Built-in (connect to connector)	Speed (frequency) reference Optional Cards	Analog Reference Card AI-14U	73600-C001X Used to set high-accuracy, high-resolution analog speed references. • Input signal levels: 0 to +10 VDC (20 kΩ) 1 channel 4 to 20 mA DC (250Ω) 1 channel • Input resolution: 14 bits (1/16384)	TOE-C736-30.13
		Analog Reference Card AI-14B	73600-C002X Used to set high-accuracy, high-resolution analog speed references. • Input signal level: 0 to ±10 VDC (20 kΩ) 4 to 20 mA DC (500Ω) 3 channels • Input resolution: 13 bits + sign (1/8192)	TOE-C736-30.14
		Digital Reference Card DI-08	73600-C003X Used to set frequency references in 2-digit BCD or 8-bit binary. • Input signal: 8 bits binary 2 digits BCD + SIGN signal + SET signal • Input voltage: +24 V(insulated) • Input current: 8 mA	TOE-C736-30.15
		Digital Reference Card DI-16H2	73600-C016X Used to set 16-bit digital speed references. • Input signal: 16 bits binary 4 digits BCD + SIGN signal + SET signal • Input voltage: +24 V(insulated) • Input current: 8 mA Used to set frequency references with 16 or 12 bits (switchable).	TOE-C736-40.7
		RS-232C/485/422 Interface Card SI-K2	73600-C015X Used to convert RS-232C to RS-485 or RS-422. Supports baud rates up to 9.6 kbps.	TOE-C736-40.6
	Monitoring Optional Cards	Analog Monitor Card AO-08	73600-D001X Converts analog signals to monitor the Inverter's output status (output frequency, output current, etc.) to absolute values and outputs them. • Output resolution: 8 bits (1/256) • Output voltage: 0 to +10 V(not insulated) • Output channels: 2 channels	TOE-C736-30.21
		Analog Monitor Card AO-12	73600-D002X Output analog signals to monitor the Inverter's output status (output frequency, output current, etc.). • Output resolution: 11 bits (1/2048) + sign • Output voltage: - 10 to +10 V (not insulated) • Output channels: 2 channels	TOE-C736-30.22
		Pulse Monitor Card PO-36F	73600-D003X Used to output pulse-train signals according to the output frequency of the Inverter • Output pulse: 1F, 6F, 10F, 12F, 36F (F: Output frequency) • Output voltage: +12 V ± 10% (insulated) • Output current: 20 mA max.	TOE-C736-30.23
		Digital Output Card DO-08	73600-D004X Outputs isolated digital signals to monitor the Inverters operating status (alarm signals, zero speed detection, etc.) • Output form: Photocoupler output, 6 channels (48 V, 50 mA max.) Relay contact outputs, 2 channels (250 VAC: 1 A max., DC 30V: 1 A max.)	TOE-C736-30.24
		2C-Relay Output Card DO-02C	73600-D007X Provides two multi-function outputs (DPDT relay contacts) in addition to those provided by the Inverter.	TOE-C736-40.8

Table 11.2 Optional Cards (Continued)

Type	Name	Code No.	Descriptions	Manual No.
Built-in (connect to connector) PG Speed Control Cards	PG-A2	73600-A012X	Used for V/f control. Speed feedback is performed using the PG attached to the motor to compensate for speed fluctuations caused by slipping. <ul style="list-style-type: none"> • A-phase pulse (single pulse) input (voltage, complementary, open-collector input) • Maximum input frequency: 32767 Hz • Pulse monitor output: +12 V, 20 mA (PG power supply output: +12 V, 200 mA max.)	TOE-C736-40.1
	PG-B2	73600-A013X	<ul style="list-style-type: none"> • Used for flux vector control. • A-, B-phase input (complimentary input) • Maximum input frequency: 32767 Hz • Pulse monitor output: Open-collector (PG power supply output: +12 V, 200 mA max.)	TOE-C736-40.2
	PG-D2	73600-A014X	<ul style="list-style-type: none"> • Differential input. • A-phase pulse (differential pulse) input, for V/f control • Maximum input frequency: 300 kHz • Input: Conforms to RS-422 • Pulse monitor output: RS-422 (PG power supply output: +5 or +12 V, 200 mA max.)	TOE-C736-40.3
	PG-X2	73600-A015X	Used for flux vector control. <ul style="list-style-type: none"> • A-, B-, Z-phase pulse (differential pulse) input • Maximum input frequency: 300 kHz • Input: Conforms to RS-422 • Pulse monitor output: RS-422 (PG power supply output: +5 or +12 V, 200 mA max.)	TOE-C736-40.4
	Synchronous Phase Control Card SP-A2	73600-A016X	Connector to Inverter to enable synchronized startup control with the motor. An external voltage detection transformer (CPT005845) is required	TOE-C736-40.5

Specifications

11.2.3 Option Cards

12

Appendix

This chapter provides precautions for the Inverter, motor, and peripheral devices and also provides lists of constants.

12.1	Inverter Application Precautions	12 - 2
12.1.1	Selection	12 - 2
12.1.2	Settings	12 - 2
12.1.3	Handling	12 - 2
12.2	Motor Application Precautions	12 - 3
12.2.1	Using the Inverter for an Existing Standard Motor ..	12 - 3
12.2.2	Power Transmission Mechanism (Speed Reducers, Belts, and Chains)	12 - 3
12.3	Peripheral Device Application Precautions ..	12 - 4
12.4	Wiring Examples	12 - 5
12.4.1	Using Two Braking Units in Parallel	12 - 5
12.4.2	Using a JVOP-95-□, -96-□ VS Operator	12 - 6
12.4.3	Using an Open-collector Transistor for Operation Signals	12 - 7
12.4.4	Using Open-collector, Contact Outputs	12 - 7
12.5	Function Block Diagram	12 - 8
12.6	Spare Parts Lists	12 - 10
12.7	User Constants	12 - 12

12.1 Inverter Application Precautions

12.1.1 Selection

■ Inverter Capacity

When connecting special motors or multiple motors in parallel to an Inverter, select the Inverter capacity so that the rated output current of the Inverter is 1.1 times the sum of all the motor rated currents.

■ Initial Torque

The startup and acceleration characteristics of the motor are restricted by the overload current ratings of the Inverter that is driving the motor. The torque characteristics are generally less than those required when starting using a normal commercial power supply. If a large initial torque is required, select an Inverter with a somewhat larger capacity or increase the capacity of both the motor and the inverter.

■ Emergency Stop

Although the Inverter's protective functions will stop operation when a fault occurs, the motor will not stop immediately. Always provide mechanical stop and protection mechanisms on equipment requiring an emergency stop.

■ Options

Terminals \ominus and $\oplus 1$ are for connecting only the options specifically provided by Yaskawa. Never connect any other devices to these terminals.

12.1.2 Settings

■ Upper Limits

The Digital Operator can be used to set high-speed operation up to a maximum of 150 Hz. Incorrect settings can be dangerous. Use the maximum frequency setting functions to set upper limits. (The maximum output frequency is factory-set to 60 Hz.)

■ DC Injection Braking

The motor can overheat if the DC injection braking voltage or braking time is set to a large value.

■ Acceleration/Deceleration Times

The motor's acceleration and deceleration times are determined by the torque generated by the motor, the load torque, and the load's inertial moment ($GD^2/4$). If the stall prevention functions are activated during acceleration or deceleration, increase the acceleration or deceleration time. The stall prevention functions will increase the acceleration or deceleration time by the amount of time the stall prevention function is active.

To reduce the acceleration or deceleration times, increase the capacity of the motor and Inverter.

12.1.3 Handling

■ Wiring Check

The Inverter will be internally damaged if the power supply voltage is applied to output terminal U, V, or W. Check wiring for any mistakes before supplying power. Check all wiring and sequences carefully.

■ Inspections

The internal capacitors in the Inverter require time to discharge after the power supply is turned OFF. Do not start inspections until the CHARGE indicator goes out.

12.2 Motor Application Precautions

12.2.1 Using the Inverter for an Existing Standard Motor

When a standard motor is operated with the Inverter, power loss is slightly higher than when operated with a commercial power supply. In addition, cooling effects also diminish in the low-speed range, resulting in an increase in the motor temperature. Therefore, the motor torque should be reduced in the low-speed range.

The following graph shows the allowable load characteristics of a standard motor.

If 100% torque is continuously required in the low-speed range, use a special motor for use with inverters.

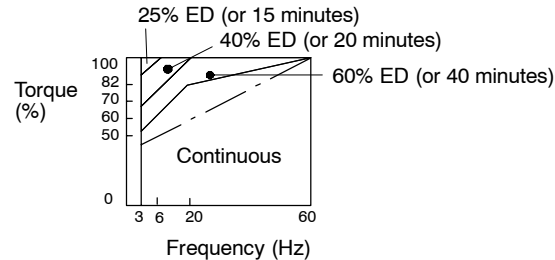

If the input voltage is high (440 V or higher) or the wiring distance is long, the motor insulation voltage must be considered. Contact your Yaskawa representative for details.

■ High-speed Operation

When using the motor at a high speed (60 Hz or more), problems may arise in dynamic balance and bearing durability. Contact the motor manufacturer for details.

■ Torque Characteristics

The motor may require more acceleration torque when the motor is operated with the Inverter than when operated with a commercial power supply. Check the load torque characteristics of the machine to be used with the motor to set a proper V/f pattern.

■ Vibration

Resonance with the Natural Frequency of the Mechanical System

Take special care when a machine that has been operated at a constant speed is to be operated in variable speed mode.

If resonance occurs, install vibration-proof rubber on the motor base or use the frequency jump function to skip any frequency resonating the machine.

Imbalanced Rotor

Take special care when the motor is operated at a higher speed (60 Hz or more).

■ Noise

Noise is almost the same as when the motor is operated with a commercial power supply. Motor noise, however, becomes louder when the motor is operated at a speed higher than the rated speed (60 Hz).

12.2.2 Power Transmission Mechanism (Speed Reducers, Belts, and Chains)

If an oil-lubricated gearbox or speed reducer is used in the power transmission mechanism, oil lubrication will be affected when the motor operates only in the low speed range. The power transmission mechanism will make noise and experience problems with service life and durability if the motor is operated at a speed higher than 60 Hz.

12.3 Peripheral Device Application Precautions

■ Selecting and Installing Wiring Breakers

Install a molded-case circuit breaker (MCCB) on the power supply line to the Inverter to protect the wiring. Select the MCCB according to the Inverter's power supply power factor (which changes with the supply voltage, output frequency, and load). Contact your Yaskawa representative for selection standards. Operating characteristics of completely magnetic MCCBs change with high-frequency currents. Select a model with a large capacity. We recommend using only ground fault interrupters designed for inverters.

■ Using Magnetic Contactors on the Motor Line

As a rule, do not install a magnetic contactor between the Inverter and motor to turn the motor ON and OFF during operation. Supplying power to the motor while the Inverter is operating will cause a large surge current to flow, and the Inverter's overcurrent protection function will operate. If a magnetic contactor is installed to switch to a commercial power supply, switch the lines only after stopping both the Inverter and the motor. Use the speed search function if switching is required while the motor shaft is rotating.

If a magnetic contactor is required for momentary power losses, use a contactor with delayed operation.

■ Installing Thermal Overload Relays

The Inverter has a protection function using an electronic thermal to protect the motor from overheating. However, if more than one motor is operated from one Inverter or if a multi-pole motor is operated, install thermal overload relays or thermal protectors between the Inverter and motors. Set the constant L1-01 to "1" and set the heat-operating thermal overload relay or thermal protector to 1.0 times the value on the motor nameplate at 50 Hz or 1.1 times the value at 60 Hz.

■ Improving the Power Factor (Eliminating Phase Advancing Capacitors)

Install a DC reactor (incorporated in standard models) or AC reactor on the power supply line to the Inverter to improve the power factor.

Capacitors or surge suppressors on the output line from the Inverter can overheat or be destroyed by the high-frequency component of the Inverter's output. They can also cause overcurrents to flow to the Inverter, causing the overcurrent protection function to activate. Do not install capacitors or surge suppressors in the output line.

■ Electromagnetic Interference

The Inverter's I/O circuits (main circuits) contain a high-frequency component, which may adversely affect communications devices (e.g., AM radios) located nearby. This interference can be reduced by installing noise filters, or you can install the wiring between the Inverter and motor and the power supply wiring in a metal duct and ground the duct.

■ Wire Sizes and Distances

Motor torque will be reduced by voltage drop along the cable if the distance between the Inverter and the motor is too long. This is particularly noticeable for low-frequency outputs. Use wires of sufficient size.

Always use the optional extension cables when operating the Digital Operator separated from the Inverter. For remote operation using analog signals, keep the control line length between the Analog Operator or operation signals and the Inverter to 50 m or less, and separate the lines from high-power lines (main circuits or relay sequence circuits) to reduce induction from peripheral devices.

When setting frequencies from an external frequency setter (and not from a Digital Operator), use shielded twisted-pair wires and ground the shield to terminal 12, as shown in the following diagram.

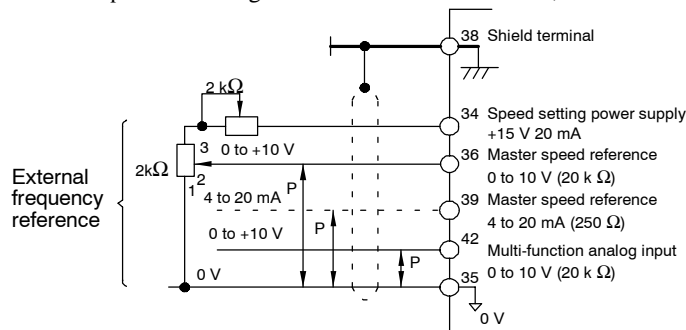

12.4 Wiring Examples

12.4.1 Using Two Braking Units in Parallel

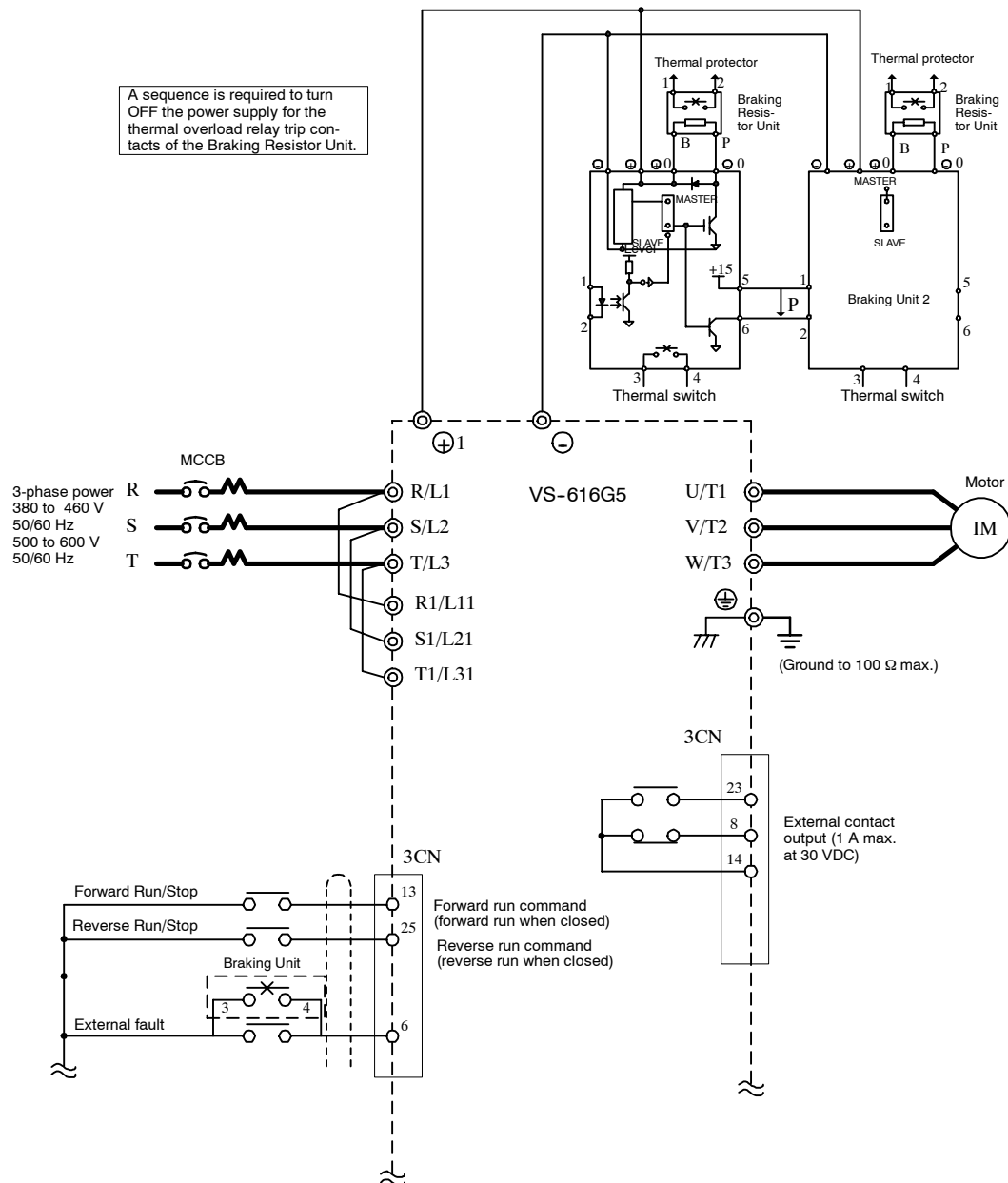

* Disable stall prevention during deceleration by setting L3-04 to "0" when using a Braking Resistor Unit. The motor may not stop within the deceleration time if this setting is not changed.

12.4.2 Using a JVOP-95-□, -96-□ VS Operator

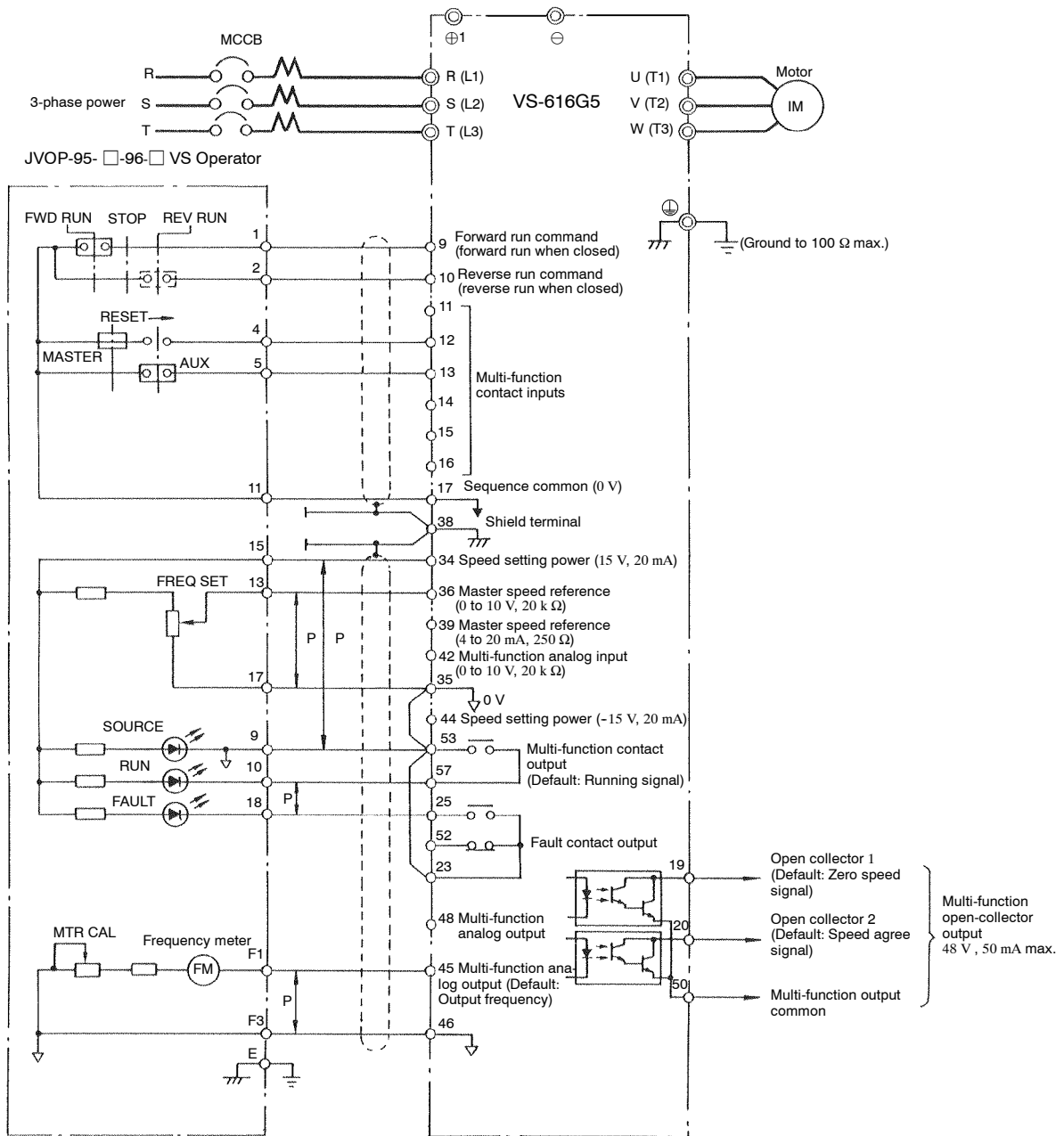

12.4.3 Using an Open-collector Transistor for Operation Signals

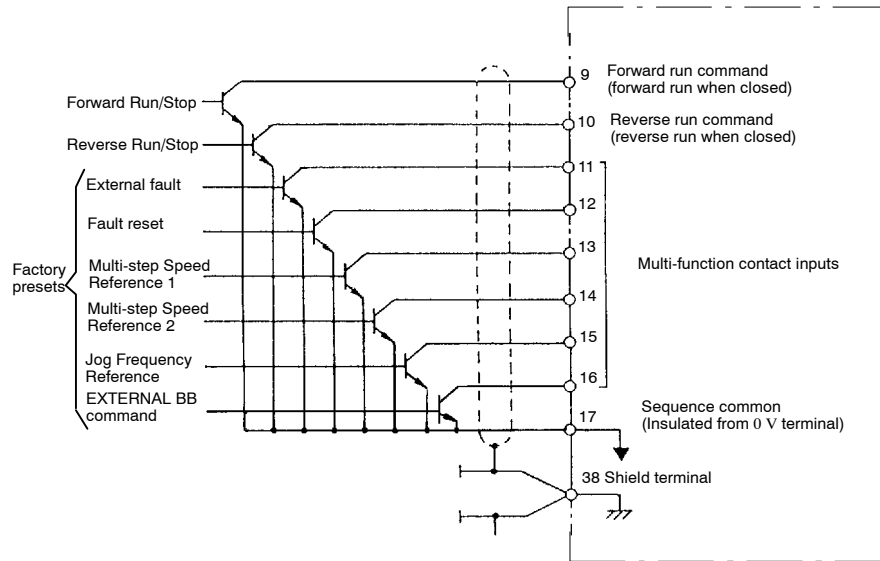

12.4.4 Using Open-collector, Contact Outputs

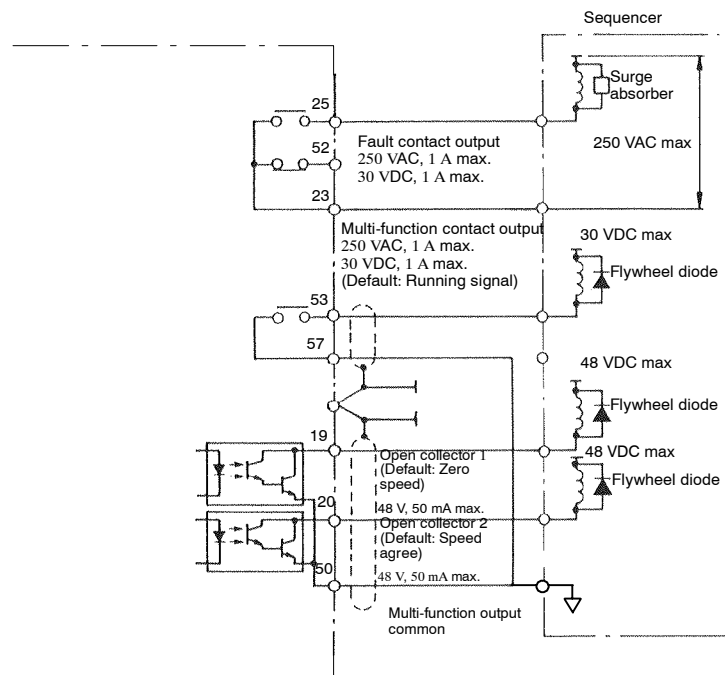

12.5 Function Block Diagram

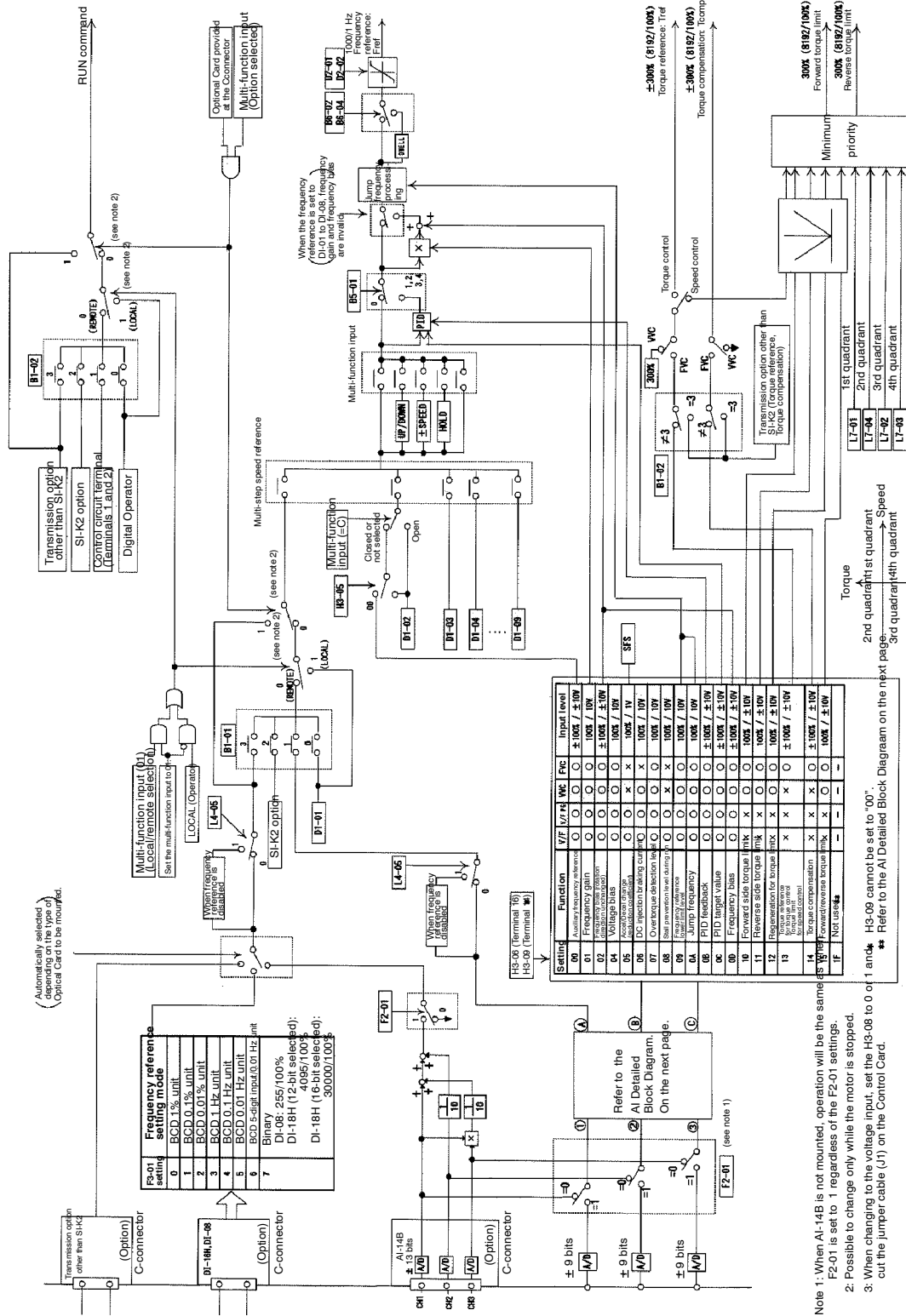

Note 1: When AI-14B is not mounted, operation will be the same as F2-01 is set to 1 regardless of the F2-01 settings.
 2: Possible to change only while the motor is stopped.
 3: When changing to the voltage input, set the H3-08 to 0 or 1 and cut the jumper cable (J1) on the Control Card.

■ A1 Detailed Block Diagram

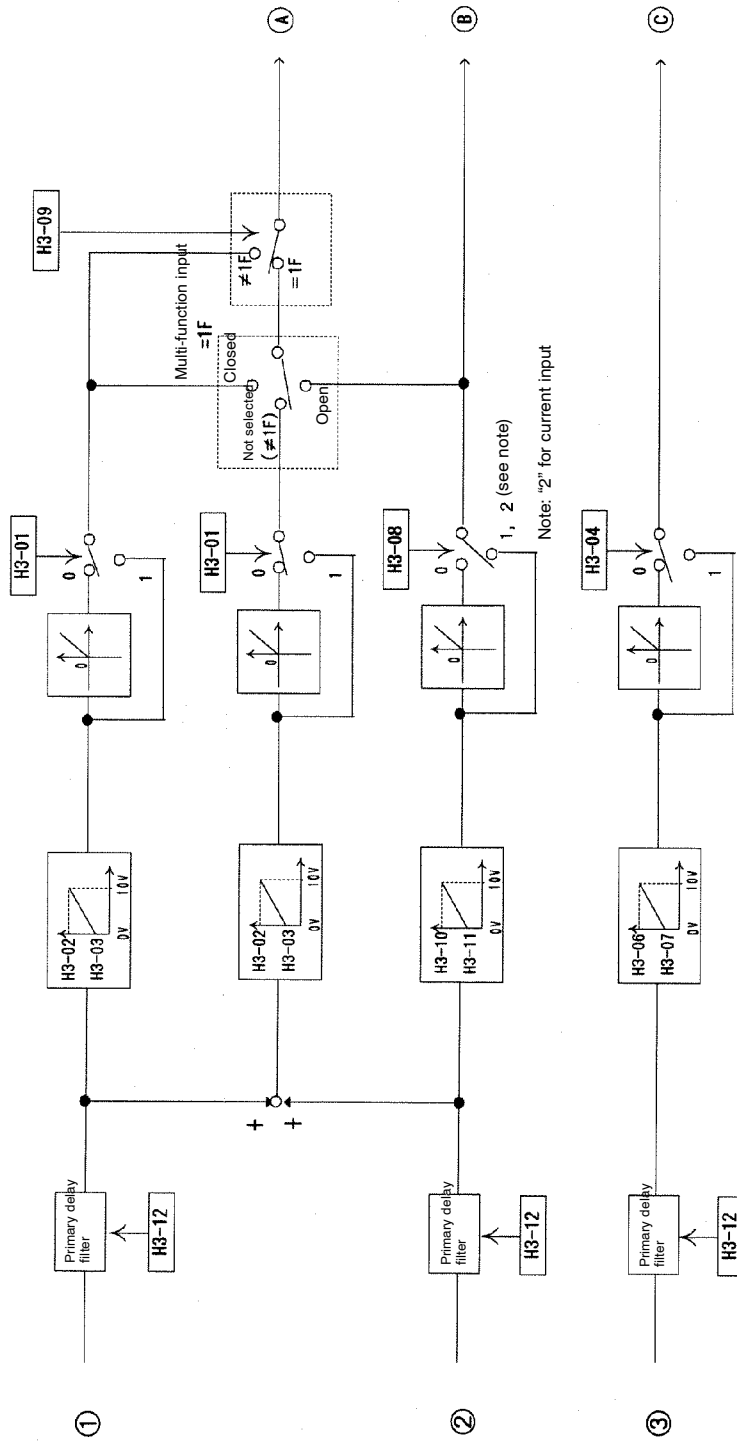

12.6 Spare Parts Lists

■ 400-V Class Inverters

Spare Part		Inverter Model (CIMR-G5A□)				
		4200	4400	4600	4800	
Inverter Module	Model	-	-	-	-	
	Code No.	EUJ61512X	EUJ61512X	EUJ61512X	EUJ61512X	
	Quantity	1	2	3	4	
Converter Module	Model	-	-	-	-	
	Code No.	EUJ61514X	EUJ61511X	EUJ61511X	EUJ61511X	
	Quantity	1	1	2	2	
Control Unit	Model	-	-	-	-	
	Code No.	EUA61505X	EUA61505X	EUA61506X	EUA61506X	
	Quantity	1	1	1	1	
Power Supply Unit	Model	-	-	-	-	
	Code No.	EUS61503X	EUS61503X	EUS61501X	EUS61501X	
	Quantity	1	1	1	1	
DC Reactor	Model	DGK0039	DGK0059	DGK0049	DGK0059	
	Code No.	X010112	X010114	X010113	X010114	
	Quantity	1	1	2	2	
Coupling Reactor	Model	-	UXBC	UXBC	UXBC	
	Code No.	-	X010119	X010119	X010119	
	Quantity	-	2	3	4	
Power Supply Transformer	Model	USN-B	USN-B	USN-B	USN-B	
	Code No.	CPT020069	CPT020070	CPT020071	CPT020072	
	Quantity	1	1	1	1	
Discharging Resistor	Model	SMR220W	SMR220W	SMR220W	SMR220W	
	Code No.	R010084	R010084	R010084	R010084	
	Quantity	2	4	6	8	
Fans	Cooling Fan	Model	UT676DX-TP	UT676DX-TP	UT676DX-TP	UT676DX-TP
		Code No.	FAN001008	FAN001008	FAN001008	FAN001008
		Quantity	4	8	13	16
	In-panel Ventilation Fan Unit	Model	THA1V-7556X	THA1V-7556X	THA1-350P549-2TP	THA1-350P549-2TP
		Code No.	FAN000101	FAN000101	FAN000220	FAN000220
		Quantity	1	2	1	1
		Model	THA1-350P549-2TP	THA1-400P549-2TP	THA1-350P549-2TP	THA1-400P549-2TP
		Code No.	FAN000220	FAN000221	FAN000220	FAN000221
		Quantity	1	1	2	2

■ 575-V Class Inverters

Spare Part		Inverter Module (CIMR-G5A□)			
		5300	5600	5900	512C
Inverter Module	Model	-	-	-	-
	Code No.	EUJ61513X	EUJ61513X	EUJ61513X	EUJ61513X
	Quantity	1	2	3	4
Converter Module	Model	-	-	-	-
	Code No.	EUJ61514X	EUJ61511X	EUJ61511X	EUJ61511X
	Quantity	1	1	2	2
Control Unit	Model	-	-	-	-
	Code No.	EUA61505X	EUA61505X	EUA61506X	EUA61506X
	Quantity	1	1	1	1
Power Supply Unit	Model	-	-	-	-
	Code No.	EUS61504X	EUS61504X	EUS61502X	EUS61502X
	Quantity	1	1	1	1
DC Reactor	Model	DGK0039	DGK0059	DGK0049	DGK0059
	Code No.	X010112	X010114	X010113	X010114
	Quantity	1	1	2	2

Spare Part		Inverter Module (CIMR-G5A□)				
		5300	5600	5900	512C	
Coupling Reactor	Model	-	UXBC	UXBC	UXBC	
	Code No.	-	X010119	X010119	X010119	
	Quantity	-	2	3	4	
Power Supply Transformer	Model	USN-B	USN-B	USN-B	USN-B	
	Code No.	CPT020073	CPT020074	CPT020075	CPT020076	
	Quantity	1	1	1	1	
Discharging Resistor	Model	SMR220W	SMR220W	SMR220W	SMR220W	
	Code No.	R010084	R010084	R010084	R010084	
	Quantity	2	4	6	8	
Fans	Cooling Fan	Model	UT676DX-TP	UT676DX-TP	UT676DX-TP	UT676DX-TP
		Code No.	FAN001008	FAN001008	FAN001008	FAN001008
		Quantity	4	8	13	16
	In-panel Ventilation Fan Unit	Model	THA1V-7556X	THA1V-7556X	THA1-350P549-2TP	THA1-350P549-2TP
		Code No.	FAN000101	FAN000101	FAN000220	FAN000220
		Quantity	1	2	1	1
		Model	THA1-350P549-2TP	THA1-400P549-2TP	THA1-350P549-2TP	THA1-400P549-2TP
		Code No.	FAN000220	FAN000221	FAN000220	FAN000221
		Quantity	1	1	2	2

* A module draw-out lift is required to replace Modules.

12.7 User Constants

Factory settings are given for a 400-V class Inverter of 200 kW set to open loop vector control (A1-02 = 2).

Table 12.1 User Constants

No.	Name (Display)	Factory Setting	Setting	No.	Name (Display)	Factory Setting	Setting
A1-00	Language selection for digital operator display (Select Language)	1 * ₁		b6-01	Dwell frequency at start (Dwell Ref @ Start)	0.0	
A1-01	Constant access level (Access Level)	2		b6-02	Dwell time at start (Dwell Time @ Start)	0.0	
A1-02	Control method selection (Control Method)	2 * ₁		b6-03	Dwell frequency at stop (Dwell Ref @ Stop)	0.0	
A1-03	Initialize (Init Parameters)	0		b6-04	Dwell time at stop (Dwell Time @ Stop)	0.0	
A1-04	Password 1 (Enter Password)	0		b7-01	Droop control gain ^{*2} (Droop Gain)	0.0	
A1-05	Password 2 (Select Password)	0		b7-02	Droop control delay time ^{*2} (Droop Delay Time)	0.05	
A2-01 to A2-32	User setting constant (User Pram 1 to 32)	---		b8-01	Energy-saving gain (Energy Save Gain)	80	
b1-01	Reference selection (Reference Source)	1		b8-02	Energy-saving frequency (Energy Save Freq)	0.0	
b1-02	Operation method selection (Run Source)	1		b9-01	Zero-servo gain (Zero Servo Gain)	5	
b1-03	Stopping method selection (Stopping Method)	0		b9-02	Zero-servo completion width (Zero Servo Count)	10	
b1-04	Prohibition of reverse operation (Reverse Oper)	0		C1-01	Acceleration time 1 (Accel Time 1)	10.0	
b1-05	Operation selection for setting of E1-09 or less (Zero-Speed Oper)	0		C1-02	Deceleration time 1 (Decel Time 1)	10.0	
b1-06	Read sequence input twice (Cntl Input Scans)	1		C1-03	Acceleration time 2 (Accel Time 2)	10.0	
b1-07	Operation after switching to remote mode ^{*2} (LOC/REM RUN Sel)	0		C1-04	Deceleration time 2 (Decel Time 2)	10.0	
b2-01	Zero speed level (DC injection braking start frequency) (DCInj Start Rreq)	0.5		C1-05	Acceleration time 3 (Accel Time 3)	10.0	
b2-02	DC injection braking current (DCInj Current)	50		C1-06	Deceleration time 3 (Decel Time 3)	10.0	
b2-03	DC injection braking time at start (DCInj Time @ Start)	0.00		C1-07	Acceleration time 4 (Accel Time 4)	10.0	
b2-04	DC injection braking time at stop (DCInj Time @ Stop)	0.50		C1-08	Deceleration time 4 (Decel Time 4)	10.0	
b3-01	Speed search selection at start (SpdSrch at Start)	0 * ₃		C1-09	Emergency stop time (Fast Stop Time)	10.0	
b3-02	Speed search operating current (SpdSrch Current)	100 * ₃		C1-10	Accel/decel time setting unit (Acc/Dec Units)	1	
b3-03	Speed search deceleration time (SpdSrch Dec Time)	2.0		C1-11	Accel/decel time switching frequency (Acc/Dec SW Freq)	0.0	
b4-01	Timer function ON-delay time (Delay-ON Timer)	0.0		C2-01	S-curve characteristic time at acceleration start (SCrv Acc @ Start)	0.20	
b4-02	Timer function OFF-delay time (Delay-OFF Timer)	0.0		C2-02	S-curve characteristic time at acceleration end (SCrv Acc @ End)	0.20	
b5-01	PID control mode selection (PID Mode)	0		C2-03	S-curve characteristic time at deceleration start (SCrv Dec @ Start)	0.20	
b5-02	Proportional gain (P) (PID Gain)	1.00		C2-04	S-curve characteristic time at deceleration end (SCrv Dec @ End)	0.00	
b5-03	Integral (I) time (PID I Time)	1.0		C3-01	Slip compensation gain (Slip Comp Gain)	1.0 * ₃	
b5-04	Integral (I) limit (PID I Limit)	100.0		C3-02	Slip compensation primary delay time (Slip Comp Time)	200 * ₃	
b5-05	Differential (D) time (PID D Time)	0.00		C3-03	Slip compensation limit (Slip Comp Limit)	200	
b5-06	PID limit (PID Limit)	100.0		C3-04	Slip compensation during regeneration (Slip Comp Regen)	0	
b5-07	PID offset adjustment (PID Offset)	0.0		C3-05	Flux calculation method (Flux Select)	0	
b5-08	PID primary delay time constant (PID Delay Time)	0.00		C4-01	Torque compensation gain (Torq Comp Gain)	1.00	

* 1. Not initialized. (Japanese standard specifications: A1-01 = 1, A1-02 = 2)

* 2. Not displayed for some models depending on software version No.

* 3. Factory setting depends on the control method (A1-02).

Table 12.1 User Constants (Continued)

No.	Name (Display)	Factory Setting	Setting	No.	Name (Display)	Factory Setting	Setting
C4-02	Torque compensation time constant (Torq Comp Time)	20 * ₁		d3-04	Jump frequency width (Jump Bandwidth)	1.0	
C5-01	ASR proportional (P) gain 1 (ASR P Gain 1)	20.00 * ₁		d4-01	Frequency reference hold function selection (MOP Ref Memory)	0	
C5-02	ASR integral (I) time 1 (ASR I Time 1)	0.500 * ₁		d4-02	+ - Speed limits ^{□ 2} (Trim Control Lvl)	25	
C5-03	ASR proportional (P) gain 2 (ASR P Gain 2)	20.00 * ₁		d5-01	Torque control selection (Torq Control Sel)	0	
C5-04	ASR integral (I) time 2 (ASR I Time 2)	0.500 * ₁		d5-02	Torque reference delay time (Torq Ref Filter)	0	
C5-05	ASR limit (ASR Limit)	5.0		d5-03	Speed limit selection (Speed Limit Sel)	1	
C5-06	ASR primary delay time (ASR Delay Time)	0.004		d5-04	Speed limit (Speed Lmt Value)	0	
C5-07	ASR switching frequency (ASR Gain SW Freq)	0.0		d5-05	Speed limit bias (Speed Lmt Bias)	10	
C5-08	ASR integral (I) limit ^{□ 2} (ASR I Limit)	400		d5-06	Speed/torque control switching timer (Ref Hold Time)	0	
C6-01	Carrier frequency upper limit (Carrier Freq Max)	2.0 * ₃		E1-01	Input voltage setting (Input Voltage)	400 * ₄	
C6-02	Carrier frequency lower limit (Carrier Freq Min)	2.0 * ₃		E1-02	Motor selection (Motor Selection)	0	
C6-03	Carrier frequency proportional gain (Carrier Freq Gain)	0 * ₃		E1-03	V/f pattern selection (V/F Selection)	0F	
C7-01	Hunting prevention selection (Hunt Prev Select)	1		E1-04	Max. output frequency (Max Frequency)	60.0	
C7-02	Hunting prevention gain (Hunt Prev Gain)	1.00		E1-05	Max. voltage (Max Voltage)	400.0 * ₄	
C8-08	AFR gain (AFR Gain)	1.00		E1-06	Base frequency (Base Frequency)	60.0	
C8-09	Speed feedback detection control (AFR) time* ² (AFR Time)	50		E1-07	Mid. output frequency (Mid. Frequency A)	3.0 * ₁	
C8-30	Carrier frequency during autotuning ^{□ 2} (Carrier in tune)	2		E1-08	Mid. output frequency voltage (Mid Voltage A)	22.0 * ₁ * ₄	
d1-01	Frequency reference 1 (Reference 1)	0.00		E1-09	Min. output frequency (Min Frequency)	0.5 * ₁	
d1-02	Frequency reference 2 (Reference 2)	0.00		E1-10	Min. output frequency voltage (Min Voltage)	4.0 * ₁ * ₄	
d1-03	Frequency reference 3 (Reference 3)	0.00		E1-11	Mid. output frequency 2* ² (Mid Frequency B)	0.0	
d1-04	Frequency reference 4 (Reference 4)	0.00		E1-12	Mid. output frequency voltage 2* ² (Mid Voltage B)	0.0	
d1-05	Frequency reference 5 (Reference 5)	0.00		E1-13	Base voltage ^{□ 2} (Base Voltage)	0.0	
d1-06	Frequency reference 6 (Reference 6)	0.00		E2-01	Motor rated current (Motor Rated FLA)	370.0 * ₃	
d1-07	Frequency reference 7 (Reference 7)	0.00		E2-02	Motor rated slip (Motor Rated Slip)	1.30 * ₃	
d1-08	Frequency reference 8 (Reference 8)	0.00		E2-03	Motor no-load current (No-Load Current)	96.0 * ₃	
d1-09	Jog frequency reference (Jog Reference)	6.00		E2-04	Number of motor poles (Number of Poles)	4	
d2-01	Frequency reference upper limit (Ref Upper Limit)	100.0		E2-05	Motor line-to-line resistance (Term Resistance)	0.020 * ₃	
d2-02	Frequency reference lower limit (Ref Lower Limit)	0.0		E2-06	Motor leak inductance (Lead Inductance)	5.0 * ₃	
d3-01	Jump frequency 1 (Jump Freq 1)	0.0		E2-07	Motor iron-core saturation coefficient 1 (Saturation Comp 1)	0.50	

Appendix

No.	Name (Display)	Factory Setting	Setting	No.	Name (Display)	Factory Setting	Setting
d3-02	Jump frequency 2 (Jump Freq 2)	0.0		E2-08	Motor iron-core saturation coefficient 2 (Saturation Comp 2)	0.75	
d3-03	Jump frequency 3 (Jump Freq 3)	0.0		E2-09	Motor mechanical loss (Mechanical Loss)	0.0	

- * 1. Factory setting depends on the control method (A1-02).
- * 2. Not displayed for some models depending on software version No.
- * 3. Setting unit and initial setting depend on Inverter capacity.
- * 4. These are values for a 400-V class Inverter. Multiply the value by approx. 1.5 for a 575-V class Inverter.

Table 12.1 User Constants (Continued)

No.	Name (Display)	Factory Setting	Setting	No.	Name (Display)	Factory Setting	Setting
E3-01	Motor 2 control method selection * ₁ (Control Method)	2		F4-03	Channel 2 monitor selection (AO Ch2 Select)	3	
E4-01	Motor 2 max. output frequency * ₁ (V/F2 Max Freq)	60.0		F4-04	Channel 2 gain (AO Ch2 Gain)	0.50	
E4-02	Motor 2 max. voltage * ₁ (V/F2 Max Voltage)	400.0 * ₂		F5-01	Channel 1 output selection (DO-02 Ch1 Select)	0	
E4-03	Motor 2 max. voltage frequency * ₁ (V/F2 Base Freq)	60.0		F5-02	Channel 2 output selection (DO-02 Ch2 Select)	1	
E4-04	Motor 2 mid. output frequency 1 * ₁ (V/F2 Mid Freq)	3.0		F6-01	Output mode selection (DO-08 Selection)	0	
E4-05	Motor 2 mid. output frequency voltage 1 * ₁ (V/F2 Mid Voltage)	22.0 * ₂		F7-01	Frequency multiple selection (PO-36F Selection)	1	
E4-06	Motor 2 min. output frequency (V/F2 Min Freq)	0.5		F8-01	Transmission option (SI-F/G) * ₁ (E-15 Det Sel)	1	
E4-07	Motor 2 min. output frequency voltage * ₁ (V/F2 Min Voltage)	4.0 * ₂		F9-01	External fault input level from transmissin option (FF0 Selection) * ₁	0	
E5-01	Motor 2 rated current * ₁ (Motor 2 rated FLA)	370.0 * ₃		F9-02	External fault detection from transmission option (EF0 Detection) * ₁	0	
E5-02	Motor 2 rated slip * ₁ (Motor 2 Slip Freq)	1.30 * ₃		F9-03	Action for external fault from transmission option (EF0 Fault Act) * ₁	1	
E5-03	Motor 2 no-load current * ₁ (Motor 2 No-load I)	96.0 * ₃		F9-04	Transmission option trace sampling time (Trace Sample Time) * ₁	0	
E5-04	Motor 2 number of poles * ₁ (Motor 2 # Poles)	4 poles		H1-01	Multi-function input (terminal 11) (Terminal 11 Sel)	24	
E5-05	Motor 2 line-to-line resistance * ₁ (Motor 2 term Ohms)	0.020 * ₃		H1-02	Multi-function input (terminal 12) (Terminal 12 Sel)	14	
E5-06	Motor 2 leak inductance * ₁ (Motor 2 Leak)	5.0 * ₃		H1-03	Multi-function input (terminal 13) (Terminal 13 Sel)	3 (0) * ₅	
F1-01	PG constant (PG Pulse/Rev)	600		H1-04	Multi-function input (terminal 14) (Terminal 14 Sel)	4 (3) * ₅	
F1-02	Operation selection at PG open circuit (PG Fdbk Loss Sel)	1		H1-05	Multi-function input (terminal 15) (Terminal 15 Sel)	6 (4) * ₅	
F1-03	Operation selection at overspeed (PG Overspeed Sel)	1		H1-06	Multi-function input (terminal 16) (Terminal 16 Sel)	8 (6) * ₅	
F1-04	Operation selection at deviation (PG Deviation Sel)	3		H2-01	Multi-function input (terminal 53-57) (Terminal 53-57 Sel)	0	
F1-05	PG rotation (PG Rotation Sel)	0		H2-02	Multi-function input (terminal 19) (Terminal 19 Sel)	1	
F1-06	PG division rate (PG pulse monitor) (PG output Ratio)	1		H2-03	Multi-function input (terminal 20) (Terminal 26 Sel)	2	
F1-07	Integral value during accel/decel enable/disable (PG Ramp PI/I Sel)	0		H3-01	Signal level selection (terminal 36) (Term 36 Signal)	0	
F1-08	Overspeed detection level (PG Overspd Level)	115		H3-02	Gain (terminal 36) (Terminal 36 Gain)	100.0	
F1-09	Overspeed detection delay time (PG Overspd Time)	0.0 * ₄		H3-03	Bias (terminal 36) (Terminal 36 Bias)	0.0	
F1-10	Excessive speed deviation detection level (PG Deviate level)	10		H3-04	Signal level selection (terminal 42) (Term 42 Signal)	0	
F1-11	Excessive speed deviation detection delay time (PG Deviate Time)	0.5		H3-05	Multi-function analog input (terminal 42) (Terminal 42 Sel)	0	
F1-12	Number of PG gear teeth 1 (PG# Gear Teeth 1)	0		H3-06	Gain (terminal 42) (Terminal 42 Gain)	100.0	
F1-13	Number of PG gear teeth 2 (PG# Gear Teeth 2)	0		H3-07	Bias (terminal 42) (Terminal 42 Bias)	0.0	
F1-14	PG open-circuit detection time * ₁ (PGO Time)	2.0		H3-08	Signal level selection (terminal 39) (Term 39 Signal)	2	

Appendix

F2-01	Bi-polar or uni-polar input selection (AI-14 Input Sel)	0		H3-09	Multi-function analog input (terminal 39) (Terminal 39 Sel)	1F	
F3-01	Digital input option (DI Input)	0		H3-10	Gain (terminal 39) (Terminal 39 Gain)	100.0	
F4-01	Channel 1 monitor selection (AO Ch1 Select)	2		H3-11	Bias (terminal 39) (Terminal 39 Bias)	0.0	
F4-02	Channel I gain (AO Ch1 Gain)	1.00		H3-12	Analog input filter time constant (Filter Avg Time)	0.00	

- * 1. Not displayed for some models depending on software version No.
- * 2. These are values for a 400-V class Inverter. Multiply the value by approx. 1.5 for a 575-V class Inverter.
- * 3. Setting unit and initial setting depend on Inverter capacity.
- * 4. Depends on the control method (A1-02).
- * 5. Factory setting in the parentheses is for 3-wire sequence.

Table 12.1 User Constants (Continued)

No.	Name (Display)	Factory Setting	Setting	No.	Name (Display)	Factory Setting	Setting
H4-01	Monitor selection (terminal 45) (Terminal 45 Sel)	2		L5-01	Number of auto restart attempts (Num of Restarts)	0	
H4-02	Gain (terminal 45) (Terminal 45 Gain)	1.00		L5-02	Auto restart operation selection (Restart Sel)	0	
H4-03	Bias (terminal 45) (Terminal 45 Bias)	0.0		L6-01	Torque detection selection 1 (Torq Det 1 Sel)	0	
H4-04	Monitor selection (terminal 48) (Terminal 48 Sel)	3		L6-02	Torque detection level 1 (Torq Det 1 Lvl)	150	
H4-05	Gain (terminal 48) (Terminal 48 Gain)	0.50		L6-03	Torque detection time 1 (Torq Det 1 Time)	0.1	
H4-06	Bias (terminal 48) (Terminal 48 Bias)	0.0		L6-04	Torque detection selection 2 (Torq Det 2 Lvl)	0	
H4-07	Analog output signal level selection (AO Level Select)	0		L6-05	Torque detection level 2 (Torq Det 2 Lvl)	150	
H5-01	Station address (Serial Comm Adr)	1F		L6-06	Torque detection time 2 (Torq Det 2 time)	0.1	
H5-02	Communication speed selection (Serial Baud Rate)	3		L7-01	Forward torque limit (Torq Limit Fwd)	200	
H5-03	Communication parity selection (Serial Com Sel)	0		L7-02	Reverse torque limit (Torq Limit Rev)	200	
H5-04	Stopping method after communication error (Serial Fault Sel)	3		L7-03	Forward regenerative torque limit (Torq Lmt Fwd Rgn)	200	
H5-05	Communication error detection selection *1 (Serial Flt Dctct)	1		L7-04	Reverse regenerative torque limit (Torq Lmt Rev Rgn)	200	
L1-01	Motor protection selection (MOL Fault Select)	1		L8-01	Protect selection for internal DB resistor (DB Resistor Prot)	0	
L1-02	Motor protection time constant (MOL Time Const)	1.0		L8-02	Overheat pre-alarm level (OH Pre-Alarm Lvl)	95	
L2-01	Momentary power loss detection (PwrL Selection)	0		L8-03	Operation selection after overheat pre-alarm (OH Pre-Alarm Sel)	3	
L2-02	Momentary power loss ridethru time (PwrL Ridethru t)	1.0 *2		L8-05	Input open-phase protection selection (Ph Loss In Sel)	0	
L2-03	Min. baseblock time (PwrL Baseblock t)	10.0 *2		L8-07	Output open-phase protection selection (Ph Loss Out Sel)	0	
L2-04	Voltage recovery time (PwrL V/F Ramp t)	0.3 *2		o1-01	Monitor selection (Monitor Select)	6	
L2-05	Undervoltage detection level (PUV Det Level)	380 *3		o1-02	Monitor selection after power up (Power-On Monitor)	1	
L2-06	KEB deceleration rate (KEB Frequency)	0.0		o1-03	Frequency units of reference setting/monitor (Display Scaling)	0	
L3-01	Stall prevention selection during accel (StallP Accel Sel)	1		o1-04	Frequency units of constant setting (Display Units)	0	
L3-02	Stall prevention level during accel (StallP Accel Lvl)	150		o1-05	Constant no. display selection (Address Display)	0	
L3-03	Stall prevention limit during accel (StallP CHP Lvl)	50		o2-01	LOCAL/REMOTE key enable/disable (Local/Remote Key)	1	
L3-04	Stall prevention selection during decel (StallP Decel Sel)	1		o2-02	STOP key during control circuit terminal operation (Oper STOP Key)	1	
L3-05	Stall prevention selection during running (StallP Run Sel)	1		o2-03	User constant initial value (User Defaults)	0	
L3-06	Stall prevention level during running (StallP Run Level)	160		o2-04	kVA selection (Inverter Model #)	81 *2	
L4-01	Speed agree detection level (Spd Agree Level)	0.0		o2-05	Frequency reference setting method *1 (Operator M.O.P.)	0	

Appendix

L4-02	Speed agree detection width (Spd Agree Width)	2.0		o2-06	Operation selection when digital operator is disconnected (Oper Detection)	0	
L4-03	Speed agree detection level (+/-) (Spd Agree Lvl +/-)	0.0		o2-07	Cumulative operation time setting (Elapsed Time Set)	□	
L4-04	Speed agree detection width (+/-) (Spd Agree Width +/-)	2.0		o2-08	Cumulative operation time selection (Elapsed Time Run)	0	
L4-05	Operation when frequency reference is missing (Ref Loss Sel)	0		o2-09	Initialize mode selection *1 (Init Mode Sel)	0 *4	

* 1. Not displayed for some models depending on software version No.

* 2. Setting unit and initial setting depend on Inverter capacity.

* 3. These are values for a 400-V class Inverter. Multiply the value by approx. 1.5 for a 575-V class Inverter.

* 4. Not initialized. (Japanese standard specification is o2-09 = 0.)

Index

A

acceleration: 6-1 6 - 11, 6 - 17
acceleration/deceleration ramp hold: 7-5 7 - 61
access levels: *chapt1* 1 - 5; *chapt4* 4 - 6, 4 - 22; 6-1 6 - 2
Advanced: *chapt1* 1 - 5; *chapt4* 4 - 6
 setting user constants: *chapt4* 4 - 11
AFR. *See* automatic frequency generator
analog input characteristics, gain and bias: 7-5 7 - 75
analog inputs: 6-1 6 - 5
 adjusting, gain and bias: 6-1 6 - 6; 7-3 7 - 25
 switching: 6-1 6 - 5
Analog Monitor Card, settings: 7-5 7 - 56
Analog Reference Card, settings: 7-5 7 - 55
anchor bolt: 2-4 2 - 11
ASR. *See* speed loop
automatic frequency regulator: 7-1 7 - 5
autotuning: *chapt1* 1 - 2; *chapt4* 4 - 34
 input voltage setting, flux vector control: 6-4 6 - 31
 open-loop vector control: 6-2 6 - 18
 faults: 6-2 6 - 19
 setting user constants: 6-2 6 - 18

B

Basic: *chapt1* 1 - 5; *chapt4* 4 - 6
 setting user constants: *chapt4* 4 - 10
bias, analog inputs: 6-1 6 - 6
Braking Unit: 12-3 12 - 5
BUS (option communications error): *chapt9* 9 - 7

C

CALL (serial communications call): *chapt9* 9 - 7
carrier frequency: 7-5 7 - 51
CE (MEMOBUS communications error): *chapt9* 9 - 7
CF (out of control): *chapt9* 9 - 4
closed-loop connectors, control circuit: *chapt3* 3 - 22
common functions: 7-5 7 - 38
communications error (CE): *chapt9* 9 - 7
connection cable: *chapt3* 3 - 7

connection diagrams: *chapt3* 3 - 3
constants write enable: 7-5 7 - 65
contact outputs: 12-3 12 - 7
control circuit terminal: *chapt3* 3 - 12
control fault (CF): *chapt9* 9 - 4
control inputs: 6-1 6 - 9
 responsiveness: 6-1 6 - 9
control method, affects on factory settings: *chapt8* 8 - 41
control methods: *chapt4* 4 - 24; 6-1 6 - 3
control power supply voltage jumper: *chapt5* 5 - 5
Control Unit: *chapt1* 1 - 7; *chapt10* 10 - 6; 12-5 12 - 10
Converter Module: 12-5 12 - 10
converter overheating: *chapt9* 9 - 7
Cooling Fan: 12-5 12 - 10, 12 - 11
Coupling Reactor: 12-5 12 - 10, 12 - 11
CPF: *chapt9* 9 - 4
cumulative operating time: 7-5 7 - 92
current, rated setting, V/f control: 6-3 6 - 21

D

DC injection braking command: 7-5 7 - 69
DC injection braking function: 7-5 7 - 40
DC Reactor: 12-5 12 - 10
DDS/SI-B external error detected: *chapt9* 9 - 7
deceleration: 6-1 6 - 11, 6 - 17
 time switching frequency: 6-1 6 - 11
 times: 6-1 6 - 17
DEV (speed deviation): *chapt9* 9 - 4, 9 - 7
Digital Operator: *chapt1* 1 - 4, 1 - 8; *chapt5* 5 - 13
 attaching: 2-7 2 - 14
Digital Output Card: 7-5 7 - 56
Digital Reference Card, settings: 7-5 7 - 55
dimensions: 2-4 2 - 6
Discharging Resistor: 12-5 12 - 10, 12 - 11
display, status: *chapt5* 5 - 4
disposing of the Module: *chapt10* 10 - 14
droop control: 7-3 7 - 17

Index

dwell: *chapt1* 1 - 4
dwell function: 7-5 7 - 47

E

E-15 (Si-F/G communications error): *chapt9* 9 - 7
EF (external fault): *chapt9* 9 - 4, 9 - 6, 9 - 7
EF0 (option external fault): *chapt9* 9 - 7
EFO: *chapt9* 9 - 4
emergency stop: 6-1 6 - 10, 6 - 17
 time setting: 6-1 6 - 10
 time switching frequency: 6-1 6 - 11
 times: 6-1 6 - 17
energy-saving control function: 7-4 7 - 35
energy-saving control functions: 7-2 7 - 12
ERR (EEPROM read/write error): *chapt9* 9 - 8
errors, operation: *chapt9* 9 - 8
excessive speed deviation: *chapt9* 9 - 4, 9 - 7
external baseblock NC: 7-5 7 - 61
external baseblock NO: 7-5 7 - 61
external dimensions: 2-4 2 - 6
external faults: 7-5 7 - 66
external speed search 1: 7-5 7 - 69
external speed search 2: 7-5 7 - 69

F

factory settings: 12-7 12 - 12
fault reset: 7-5 7 - 64
fault restart settings: 7-5 7 - 86
faults: *chapt9* 9 - 2
 autotuning
 flux vector control: 6-4 6 - 32
 open-loop vector control: 6-2 6 - 19
 detection functions
 flux vector control: 6-4 6 - 27
 V/f control with PG: 6-5 6 - 42
 minor: *chapt9* 9 - 6
feedback control: *chapt1* 1 - 4
floor level: 2-4 2 - 10

flux vector control: *chapt1* 1 - 2; 6-4 6 - 26; 7-3 7 - 15
 PG Speed Control Cards: 6-4 6 - 26; 6-5 6 - 41
forward/reverse run commands input together (EF):
 chapt9 9 - 6
frequency detection settings: 7-5 7 - 84
frequency references: *chapt1* 1 - 4; 6-1 6 - 4, 6 - 14;
 7-5 7 - 52
 function selection: 6-1 6 - 17
 jog: 6-1 6 - 14
 multi-step: 6-1 6 - 14
 presetting: 6-1 6 - 8
 selecting: 6-1 6 - 4
 selecting the source: 6-1 6 - 7
 selecting the units: 6-1 6 - 7
 terminal 13 signal level: 6-1 6 - 4
 terminal 14 signal level: 6-1 6 - 4
 terminal 16 signal level: 6-1 6 - 5
 voltage range: 6-1 6 - 4
function block diagram: 12-5 12 - 8

G

gain, analog inputs: 6-1 6 - 6
gear teeth: 6-5 6 - 41
generated loss: 2-4 2 - 6
GF (ground fault): *chapt9* 9 - 2
ground fault (GF): *chapt9* 9 - 2
grounding: *chapt3* 3 - 27

H

hardware protection settings: 7-5 7 - 88
hold status: 7-5 7 - 53
hunting prevention function: 7-2 7 - 12; 7-4 7 - 35

I

IGBT: *chapt1* 1 - 4
In-panel Ventilation Fan Unit: 12-5 12 - 10, 12 - 11
in-panel ventilation fan unit: *chapt10* 10 - 4

Index

initial excitation function, flux vector control: 6-4 6 - 30

initialize mode: *chapt4* 4 - 21
user constant list: *chapt8* 8 - 3

input voltage, setting: *chapt5* 5 - 5
V/f control: 6-3 6 - 21
V/f control with PG: 6-5 6 - 39

inrush prevention circuit fault (UV3): *chapt9* 9 - 3

inspection: *chapt10* 10 - 3

installation: 2-4 2 - 13
conditions: 2-4 2 - 10
site: 2-4 2 - 10
space: 2-4 2 - 13

installation orientation: 2-4 2 - 13

installation site: 2-4 2 - 10

insulated gate bipolar transistor. *See* IGBT

integral control, V/f control with PG: 6-5 6 - 41

inverter capacity, affects on factory settings: *chapt8* 8 - 42

Inverter Module: *chapt1* 1 - 7; *chapt10* 10 - 6; 12-5 12 - 10

inverter overheat pre-alarm: 7-5 7 - 73

inverter overheating pre-alarm (OH2): *chapt9* 9 - 6

J

jog: 6-1 6 - 8, 6 - 17

jump frequencies: 7-5 7 - 52

jumper wire: 6-1 6 - 5; 7-3 7 - 21

K

key function settings: 7-5 7 - 91

L

language: *chapt4* 4 - 22

LF (output phase loss): *chapt9* 9 - 3

lifting bar: 2-1 2 - 5

lifting with wires: 2-1 2 - 4

load short-circuit (SC): *chapt9* 9 - 2

local/remote selection: 7-5 7 - 60

M

main circuit overvoltage (OV): *chapt9* 9 - 6

main circuit terminals: *chapt3* 3 - 9

main circuit undervoltage (UV): *chapt9* 9 - 6

main circuit undervoltage (UV1): *chapt9* 9 - 2

main circuit voltage fault (PF): *chapt9* 9 - 3

maintenance: *chapt10* 10 - 3

MEMOBUS communications: 7-5 7 - 77

modes

Inverter: *chapt4* 4 - 4

switching: *chapt4* 4 - 5

modified constants mode: *chapt4* 4 - 36

Module: *chapt10* 10 - 6

Dismounting: *chapt10* 10 - 7

drawing out: *chapt10* 10 - 12

mounting: *chapt10* 10 - 13

Module Draw-out Lift: *chapt11* 11 - 4

momentary power loss settings: 7-5 7 - 79

monitor output, adjusting: 7-5 7 - 76

monitoring, startup: *chapt4* 4 - 18

motor, using the Inverter for a standard motor: 12-1 12 - 3

motor constants: 7-1 7 - 6

V/f control: 6-3 6 - 21; 7-3 7 - 29

V/f control with PG: 6-5 6 - 39

motor overload OL1: 7-5 7 - 73

motor protection settings: 7-5 7 - 78

motor switch command: 7-5 7 - 64

mounting dimensions: 2-4 2 - 6

multi-function analog input selection: 7-5 7 - 62

multi-function analog input/frequency reference, current: 7-5 7 - 74

multi-function analog output settings: 7-5 7 - 76

multi-function analog output signal level: 7-5 7 - 76

multi-function input functions: *chapt8* 8 - 27

multi-function input settings: 7-5 7 - 59

multi-function inputs: 6-1 6 - 13

multi-function output functions: *chapt8* 8 - 28

multi-function output settings: 7-5 7 - 71

N

no V/f control with PG: 7-5 7 - 62
no-load, operation: *chapt5* 5 - 12
 Digital Operator: *chapt5* 5 - 12
 frequency reference setting: *chapt5* 5 - 12
 status checking: *chapt5* 5 - 12

O

OC (overcurrent): *chapt9* 9 - 2
OH (heat sink over temperature): *chapt9* 9 - 6
OH OH1 (heat sink over temperature): *chapt9* 9 - 3
OH2 (overheat 2): *chapt9* 9 - 6
OH2 alarm signal: 7-5 7 - 62
OL1 (motor overloaded): *chapt9* 9 - 3
OL2 (inverter overloaded): *chapt9* 9 - 3
OL3 (overtorque detection 1): *chapt9* 9 - 3, 9 - 6
OL4 (overtorque detection 2): *chapt9* 9 - 3, 9 - 6
OPE: *chapt9* 9 - 8
open-loop vector control: 6-2 6 - 18; 7-1 7 - 2; 7-2 7 - 10
open-loop vector control: *chapt1* 1 - 2
operation mode: *chapt4* 4 - 12
operator display selection: 7-5 7 - 90
OPR (operator disconnect): *chapt9* 9 - 4
Option Card transmission error (BUS): *chapt9* 9 - 7
option card/inverter selection: 7-5 7 - 60
Option Cards, settings: 7-5 7 - 53
OS (overspeed): *chapt9* 9 - 4, 9 - 6
output open phase (LF): *chapt9* 9 - 3
OV (overvoltage): *chapt9* 9 - 2, 9 - 6
overcurrent (OC): *chapt9* 9 - 2
overspeed: *chapt9* 9 - 4, 9 - 6
 flux vector control: 6-4 6 - 28; 6-5 6 - 42
overtorque 1 (OL3): *chapt9* 9 - 6
overtorque 2 (OL4): *chapt9* 9 - 6
overtorque detection settings: 7-5 7 - 87

P

password: *chapt4* 4 - 27
PF (input phase loss): *chapt9* 9 - 3
PG
 constant, flux vector control: 6-4 6 - 26
 disconnection stopping method
 flux vector control: 6-4 6 - 27
 V/f control with PG: 6-5 6 - 42
 flux vector control: 6-4 6 - 26
 gear teeth, V/f control with PG: 6-5 6 - 41
 pulse number, V/f control with PG: 6-5 6 - 41
 pulse output monitor division rate, flux vector control: 6-4 6 - 27
 rotation direction, flux vector control: 6-4 6 - 26
 speed deviation
 flux vector control: 6-4 6 - 28
 V/f control with PG: 6-5 6 - 42
 V/f control with PG: 6-5 6 - 41
PG disconnection detection: *chapt9* 9 - 4
PG Speed Control Card: *chapt3* 3 - 14; 6-4 6 - 26; 6-5 6 - 41
 installing: *chapt3* 3 - 14
 terminal blocks: *chapt3* 3 - 15
 wiring: *chapt3* 3 - 22
 wiring: *chapt3* 3 - 17
PGO (PG open): *chapt9* 9 - 4, 9 - 6
PID control function: *chapt1* 1 - 4; 7-5 7 - 42
 block diagram: 7-5 7 - 44
 control operations: 7-5 7 - 42
 control settings: 7-5 7 - 45
 types: 7-5 7 - 43
PID disable: 7-5 7 - 65
poles: 6-5 6 - 39
 number: 6-5 6 - 39
power supplies: *chapt5* 5 - 4
Power Supply Transformer: 12-5 12 - 10, 12 - 11
Power Supply Unit: *chapt1* 1 - 7; *chapt10* 10 - 6; 12-5 12 - 10
power transmission mechanism: 12-1 12 - 3
programming mode: *chapt4* 4 - 29
 parameter list: *chapt8* 8 - 4
PU control circuit undervoltage: *chapt9* 9 - 7
PUF (DC bus fuse open): *chapt9* 9 - 2

Index

Pulse Monitor Card, settings: 7-5 7 - 58

PWM timer error: *chapt9* 9 - 5

Q

Quick-start: *chapt4* 4 - 6

setting user constants: *chapt4* 4 - 9

Quick-start: *chapt1* 1 - 5

R

rated current

V/f control: 6-3 6 - 21

V/f control with PG: 6-5 6 - 39

reference source: 6-1 6 - 4

reverse operation: 6-1 6 - 11

RH (dynamic brake resistor): *chapt9* 9 - 3

RR (dynamic brake transistor): *chapt9* 9 - 3

run: 6-1 6 - 9

command: 6-1 6 - 9

source: 6-1 6 - 9

S

S-curve characteristic function: 7-5 7 - 47

SC (short circuit): *chapt9* 9 - 2

sequence control, 3-wire: 6-1 6 - 14

sequential operation: *chapt4* 4 - 25, 4 - 26

settings

analog output bias (terminal 21), H4-03: 6-4 6 - 36;
6-5 6 - 44

analog output bias (terminal 23), H4-06: 6-4 6 - 36;
6-5 6 - 45

analog output gain (terminal 21), H4-02: 6-4 6 - 36;
6-5 6 - 44

analog output gain (terminal 23), H4-05: 6-4 6 - 36;
6-5 6 - 45

analog output level selection, H4-07: 6-4 6 - 36

analog output selection (terminal 21), H4-01: 6-4 6
- 36; 6-5 6 - 44

analog output selection (terminal 23), H4-04: 6-4 6
- 36; 6-5 6 - 45

shared RAM BCC check error: *chapt9* 9 - 5

shared RAM mutual diagnosis error: *chapt9* 9 - 5

shared RAM write error: *chapt9* 9 - 5

SI-B communications error: *chapt9* 9 - 7

SI-F/G communications error detected: *chapt9* 9 - 7

side-by-side connection: 2-4 2 - 10

slip compensation gain: 7-3 7 - 32; 7-5 7 - 48

speed control

flux vector control: 6-4 6 - 33

integral reset, V/f control with PG: 6-5 6 - 44

integral time

flux vector control: 6-4 6 - 33; 6-5 6 - 43

low-speed gain: 6-4 6 - 33; 6-5 6 - 43

mode select, V/f control with PG: 6-5 6 - 44

proportional gain

flux vector control: 6-4 6 - 33; 6-5 6 - 43

low-speed gain: 6-4 6 - 33; 6-5 6 - 43

responsiveness, flux vector control: 6-4 6 - 35

V/f control with PG: 6-5 6 - 43

speed control gain, flux vector control: 6-4 6 - 36

fine adjustments: 6-4 6 - 36

speed control integral reset: 7-5 7 - 62

speed control proportional gain: 7-5 7 - 70

speed feedback: 7-1 7 - 5

speed limit function: 7-3 7 - 21

speed search function: 7-5 7 - 40

speed torque control change: 7-5 7 - 69

stall prevention function settings: 7-5 7 - 81

Status Monitor: *chapt4* 4 - 14

stopping method: 6-1 6 - 12

coasting: 6-1 6 - 12

coasting with timer: 6-1 6 - 13

DC injection braking: 6-1 6 - 12

deceleration: 6-1 6 - 12

flux vector control: 6-4 6 - 29

storage location: 2-1 2 - 3

storage method: 2-1 2 - 3

SVE (zero servo fault): *chapt9* 9 - 4

switching, speed control and torque control: 7-3 7 -
26

timer: 7-3 7 - 26

T

temperature: 2-4 2 - 10

terminal position: *chapt3* 3 - 5

timer function: 7-5 7 - 41

Index

- torque compensation function: 7-3 7 - 24; 7-5 7 - 50
 - torque control: *chapt1* 1 - 2; 7-3 7 - 19
 - torque limits: 7-1 7 - 4; 7-3 7 - 27
 - analog inputs: 7-1 7 - 4; 7-3 7 - 28
 - torque reference: 7-3 7 - 20
 - primary filter: 7-3 7 - 24
 - transmission cable: *chapt3* 3 - 8
 - Transmission Option Card DPRAM error (CPF23):
chapt9 9 - 5
 - Transmission Option Card model code error (CPF22):
chapt9 9 - 5
 - Transmission Option Card self diagnostic error (CPF21): *chapt9* 9 - 5
 - transporting on rollers: 2-1 2 - 5
 - trim control increase and decrease: 7-5 7 - 65
 - troubleshooting: *chapt9* 9 - 1, 9 - 9
- ### U
- unbalanced current: *chapt9* 9 - 7
 - up and down commands: 7-5 7 - 63
 - user constants: *chapt4* 4 - 27
 - application constants: *chapt8* 8 - 4
 - autotuning
 - acceleration/deceleration: *chapt8* 8 - 10
 - carrier frequency: *chapt8* 8 - 14
 - factory tuning: *chapt8* 8 - 15
 - hunting prevention: *chapt8* 8 - 14
 - motor slip compensation: *chapt8* 8 - 11
 - S-curve acceleration/deceleration: *chapt8* 8 - 11
 - speed control: *chapt8* 8 - 13
 - torque compensation: *chapt8* 8 - 12
 - autotuning constants: *chapt8* 8 - 10
 - constants with factory settings dependent on control method: *chapt8* 8 - 41
 - constants with factory settings dependent on inverter capacity: *chapt8* 8 - 42
 - DC braking: *chapt8* 8 - 5
 - droop control: *chapt8* 8 - 8
 - dwll functions: *chapt8* 8 - 7
 - factory settings: 12-7 12 - 12
 - initializing: *chapt4* 4 - 25
 - lists
 - initialize mode: *chapt8* 8 - 3
 - programming mode: *chapt8* 8 - 4
 - motor constants: *chapt8* 8 - 19
 - motor 2 control method: *chapt8* 8 - 21
 - motor 2 setup: *chapt8* 8 - 22
 - motor 2 V/f pattern: *chapt8* 8 - 21
 - motor setup: *chapt8* 8 - 20
 - V/f pattern: *chapt8* 8 - 19
 - operation mode selections: *chapt8* 8 - 4
 - operator constants: *chapt8* 8 - 39
 - monitor selections: *chapt8* 8 - 39
 - multi-function selections: *chapt8* 8 - 40
 - options: *chapt8* 8 - 23
 - other option setup: *chapt8* 8 - 25
 - PG option setup: *chapt8* 8 - 23
 - PID control: *chapt8* 8 - 6
 - protection constants: *chapt8* 8 - 33
 - fault restart: *chapt8* 8 - 36
 - hardware protection: *chapt8* 8 - 38
 - motor overload: *chapt8* 8 - 33
 - power loss ridethrough: *chapt8* 8 - 33
 - reference directions: *chapt8* 8 - 36
 - stall prevention: *chapt8* 8 - 35
 - torque detection: *chapt8* 8 - 37
 - torque limits: *chapt8* 8 - 37
 - reference constants: *chapt8* 8 - 16
 - jump frequencys: *chapt8* 8 - 17
 - preset references: *chapt8* 8 - 16
 - reference frequency hold: *chapt8* 8 - 17
 - reference limits: *chapt8* 8 - 16
 - torque control: *chapt8* 8 - 17
 - saving energy: *chapt8* 8 - 8
 - search speed: *chapt8* 8 - 6
 - setting
 - Advanced: *chapt4* 4 - 11
 - Basic: *chapt4* 4 - 10
 - Quick-start: *chapt4* 4 - 9
 - terminal constants: *chapt8* 8 - 26
 - analog inputs: *chapt8* 8 - 29
 - analog outputs: *chapt8* 8 - 31
 - MEMOBUS communications: *chapt8* 8 - 31
 - multi-function inputs: *chapt8* 8 - 26
 - multi-function outputs: *chapt8* 8 - 28
 - timer function: *chapt8* 8 - 6
 - zero servo: *chapt8* 8 - 8
 - UV (DC bus undervoltage): *chapt9* 9 - 6
 - UV1 (DC bus undervoltage): *chapt9* 9 - 2
 - UV2 (CTL PS undervoltage): *chapt9* 9 - 2
 - UV3 (MC answerback): *chapt9* 9 - 3
- ### V
- V/f control: 6-3 6 - 21
 - motor constants: 6-3 6 - 21; 7-3 7 - 29

Index

V/f control with PG: 6-5 6 - 39; 7-4 7 - 33
motor constants: 6-5 6 - 39

V/f patterns: *chapt1* 1 - 3
user-defined, setting: 6-5 6 - 40
user-defined patterns, setting: 6-3 6 - 24

vector control: *chapt1* 1 - 2
flux: *chapt1* 1 - 2
open-loop: *chapt1* 1 - 2

ventilation: 2-4 2 - 10

voltage: *chapt5* 5 - 5; 6-4 6 - 31
input: *chapt5* 5 - 5
autotuning in flux vector control: 6-4 6 - 31

voltage range: 6-1 6 - 4
frequency reference: 6-1 6 - 4

VS Operator: 12-3 12 - 6

W

warning label: *prelim_2* viii

write-protect: *chapt4* 4 - 27

Z

zero servo fault (SVE): *chapt9* 9 - 4

zero-servo command: 7-5 7 - 70

zero-servo control: 7-3 7 - 18

zero-servo end: 7-5 7 - 73

zero-servo function. *See* zero-servo control

zero-speed: 7-5 7 - 73

zero-speed operation, flux vector control: 6-4 6 - 29

zero-servo control: *chapt1* 1 - 4

G5 – HHP Drive



YASKAWA ELECTRIC AMERICA, INC.

Drives Division
16555 W. Ryerson Rd., New Berlin, WI 53151, U.S.A.
Phone: (800) YASKAWA (800-927-5292) Fax: (262) 782-3418
Internet: <http://www.drives.com>

YASKAWA ELECTRIC AMERICA, INC.

Chicago-Corporate Headquarters
2121 Norman Drive South, Waukegan, IL 60085, U.S.A.
Phone: (800) YASKAWA (800-927-5292) Fax: (847) 887-7310
Internet: <http://www.yaskawa.com>

MOTOMAN INC.

805 Liberty Lane, West Carrollton, OH 45449, U.S.A.
Phone: (937) 847-6200 Fax: (937) 847-6277
Internet: <http://www.motoman.com>

YASKAWA ELECTRIC CORPORATION

New Pier Takeshiba South Tower, 1-16-1, Kaigan, Minatoku, Tokyo, 105-0022, Japan
Phone: 81-3-5402-4511 Fax: 81-3-5402-4580
Internet: <http://www.yaskawa.co.jp>

YASKAWA ELETRICO DO BRASIL COMERCIO LTDA.

Avenida Fagundes Filho, 620 Bairro Saude Sao Paulo-SP, Brasil CEP: 04304-000
Phone: 55-11-5071-2552 Fax: 55-11-5581-8795
Internet: <http://www.yaskawa.com.br>

YASKAWA ELECTRIC EUROPE GmbH

Am Kronberger Hang 2, 65824 Schwalbach, Germany
Phone: 49-6196-569-300 Fax: 49-6196-888-301

MOTOMAN ROBOTICS AB

Box 504 S38525, Torsas, Sweden
Phone: 46-486-48800 Fax: 46-486-41410

MOTOMAN ROBOTEC GmbH

Kammerfeldstrabe 1, 85391 Allershausen, Germany
Phone: 49-8166-900 Fax: 49-8166-9039

YASKAWA ELECTRIC UK LTD.

1 Hunt Hill Orchardton Woods Cumbernauld, G68 9LF, Scotland, United Kingdom
Phone: 44-12-3673-5000 Fax: 44-12-3645-8182

YASKAWA ELECTRIC KOREA CORPORATION

Paik Nam Bldg. 901 188-3, 1-Ga Euljiro, Joong-Gu, Seoul, Korea
Phone: 82-2-776-7844 Fax: 82-2-753-2639

YASKAWA ELECTRIC (SINGAPORE) PTE. LTD.

Head Office: 151 Lorong Chuan, #04-01, New Tech Park Singapore 556741, Singapore
Phone: 65-282-3003 Fax: 65-289-3003

TAIPEI OFFICE (AND YATEC ENGINEERING CORPORATION)

10F 146 Sung Chiang Road, Taipei, Taiwan
Phone: 886-2-2563-0010 Fax: 886-2-2567-4677

YASKAWA JASON (HK) COMPANY LIMITED

Rm. 2909-10, Hong Kong Plaza, 186-191 Connaught Road West, Hong Kong
Phone: 852-2803-2385 Fax: 852-2547-5773

BEIJING OFFICE

Room No. 301 Office Building of Beijing International Club,
21 Jianguomanwai Avenue, Beijing 100020, China
Phone: 86-10-6532-1850 Fax: 86-10-6532-1851

SHANGHAI OFFICE

27 Hui He Road Shanghai 200437 China
Phone: 86-21-6553-6600 Fax: 86-21-6531-4242

SHANGHAI YASKAWA-TONJI M & E CO., LTD.

27 Hui He Road Shanghai 200437 China
Phone: 86-21-6533-2828 Fax: 86-21-6553-6677

BEIJING YASKAWA BEIKE AUTOMATION ENGINEERING CO., LTD.

30 Xue Yuan Road, Haidian, Beijing 100083 China
Phone: 86-10-6232-9943 Fax: 86-10-6234-5002

SHOUGANG MOTOMAN ROBOT CO., LTD.

7, Yongchang-North Street, Beijing Economic & Technological Development Area,
Beijing 100076 China
Phone: 86-10-6788-0551 Fax: 86-10-6788-2878

YEA, TAICHUNG OFFICE IN TAIWAN

B1, 6F, No.51, Section 2, Kung-Yi Road, Taichung City, Taiwan, R.O.C.
Phone: 886-4-2320-2227 Fax: 886-4-2320-2239