

Selection Guide | 1.1 kW – 630 kW

VLT® Refrigeration Drive FC 103
improves efficiency of compressors,
condensers, evaporators and pumps

No 1

in Global Refrigeration.
Dedicated solutions
deliver higher energy
efficiency, optimum
system performance and
enhanced reliability

VLT®
Refrigeration
Drive



VLT® Refrigeration Drive FC 103 reduces lifecycle costs

For over 60 years the Danfoss Refrigeration team has specialised in the development of innovative and effective refrigeration technology solutions. Danfoss has now developed the ideal drive for refrigeration system compressors, condensers, evaporators, fans and pumps – the VLT® Refrigeration Drive FC 103.

To help significantly reduce lifecycle costs of your refrigeration systems, the VLT® Refrigeration Drive FC 103 offers efficiency and reliability enhancing features, integrated process control functions and commissioning environment specifically designed to meet the needs of refrigeration compressor, condenser, evaporator, fan and pump applications.

All-inclusive

- Top efficiency (98%)
- Automatic Energy Optimisation (AEO)
- DC link chokes
- Refrigerant tables
- Large performance range
- Open for all kind of controllers including Danfoss ADAP-KOOL®

Integrated functions save money

- Multi-zone cascade controller
- Neutral zone controller
- Floating condensing temperature control
- Oil return management
- Multi-feedback evaporator control
- Safe stop
- Sleep mode
- Dry-running protection
- Overload protection
- Flow compensation

Easy installation

- Quick Menu
- Easy & swift commissioning via built-in wizard.
- Speaks “refrigeration language”
- Small enclosure size
- IP20–IP66 enclosure rating

Faster system payback with speed control

Reducing the operating costs of refrigeration systems with quick payback is becoming increasingly important. Speed control of the electric drives used in these systems is a pragmatic and effective approach. Load-dependent speed control reduces power consumption and therefore saves money.

When you consider that energy costs amount to 90% or more of total operating costs over the total product lifetime, it's easy to see that there is plenty of potential for savings in this area. Speed control also lowers mechanical stress in the system, which reduces service and maintenance costs.

VLT® Refrigeration Drive FC 103 – simply uncomplicated

Danfoss developed the VLT® Refrigeration Drive FC 103 to allow all users in the refrigeration world to benefit from the advantages of speed control in a simple, uncomplicated manner.

With its functions specifically tailored for refrigeration technology, it reduces total life cycle costs in the application.

The drive reduces the number of external components, required integrates easily into existing

refrigeration systems, and makes motors energy efficient thanks to its high performance. In this way it improves the energy balance of the overall refrigeration system and reduces its environmental footprint.

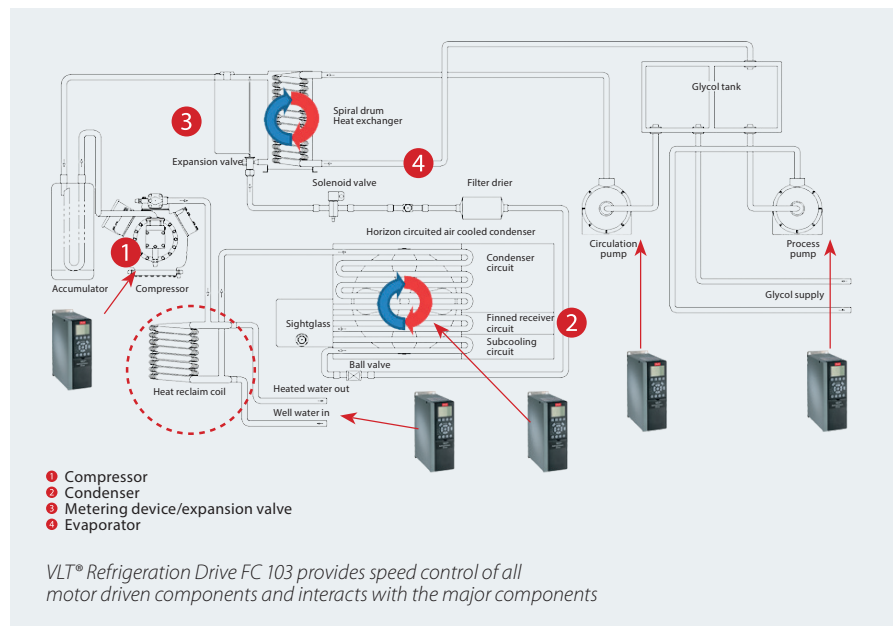

Proven reliability

Starting with the first VLT® Drive – the VLT® 5 from 1968 – every drive series from Danfoss has proven the reliability of VLT® drives.





2006-2008

2010-2012

2013-



Optimise compressor performance coefficient – Achieve system-wide energy efficiency

The performance of a refrigeration system is expressed using the energy efficiency ratio (EER) or the coefficient of performance (COP). This is the ratio of the generated cooling or heating capacity to the power actually consumed, and is usually based on full-load operation.

However, it is not enough to rate a refrigeration unit at just one load level, since most refrigeration systems operate under partial load conditions. This means that significant energy savings can be obtained using speed control.

Refrigeration system without speed control

In a refrigeration system without speed control, the compressor always runs at full speed, regardless of the cooling capacity actually required. The cooling output is regulated by the evaporator, which is filled by the expansion device.

Since the expansion valve constantly tries to fill the evaporator optimally, this

adjustment causes the evaporation pressure to change and therefore creates oscillation in the system.

With the compressor operating at full output capacity, this oscillation can persist for a very long time. As a result, the evaporator is never properly filled and operates ineffectively, and the cooling capacity of the refrigerant is not optimal.

Refrigeration system with speed control

The continuous variable speed control by VLT® Refrigeration Drive FC 103 makes intelligent capacity control possible. By creating stability while balancing the capacity to the actual load, system-wide COP improves providing significant energy savings. Intelligent compressor and condenser fan control is a “must” in any optimised refrigeration system.

The following positive effects can be achieved in a refrigeration system with variable-speed compressor operation:

Compressor

- 6 compressors pack controller
- Stable suction pressure
- Increased capacity using a smaller compressor
- Built-in soft starter function
- Built-in oil return management improves reliability and lifetime
- Low and high pressure monitoring
- Reduced mechanical load
- Fewer start and stops extends the lifetime
- No mechanical capacity control
- Improves system COP

Condenser fan control

- Load dependent capacity control
- Operate single fans/multiple parallel operating fans
- Stable condensing pressure
- Floating condensing temperature adapts to outdoor temperature
- Reduced charge of refrigerant
- Less dirt build-up on condenser
- Stand-alone control using VLT® Refrigeration Drive FC 103
- Improves system COP

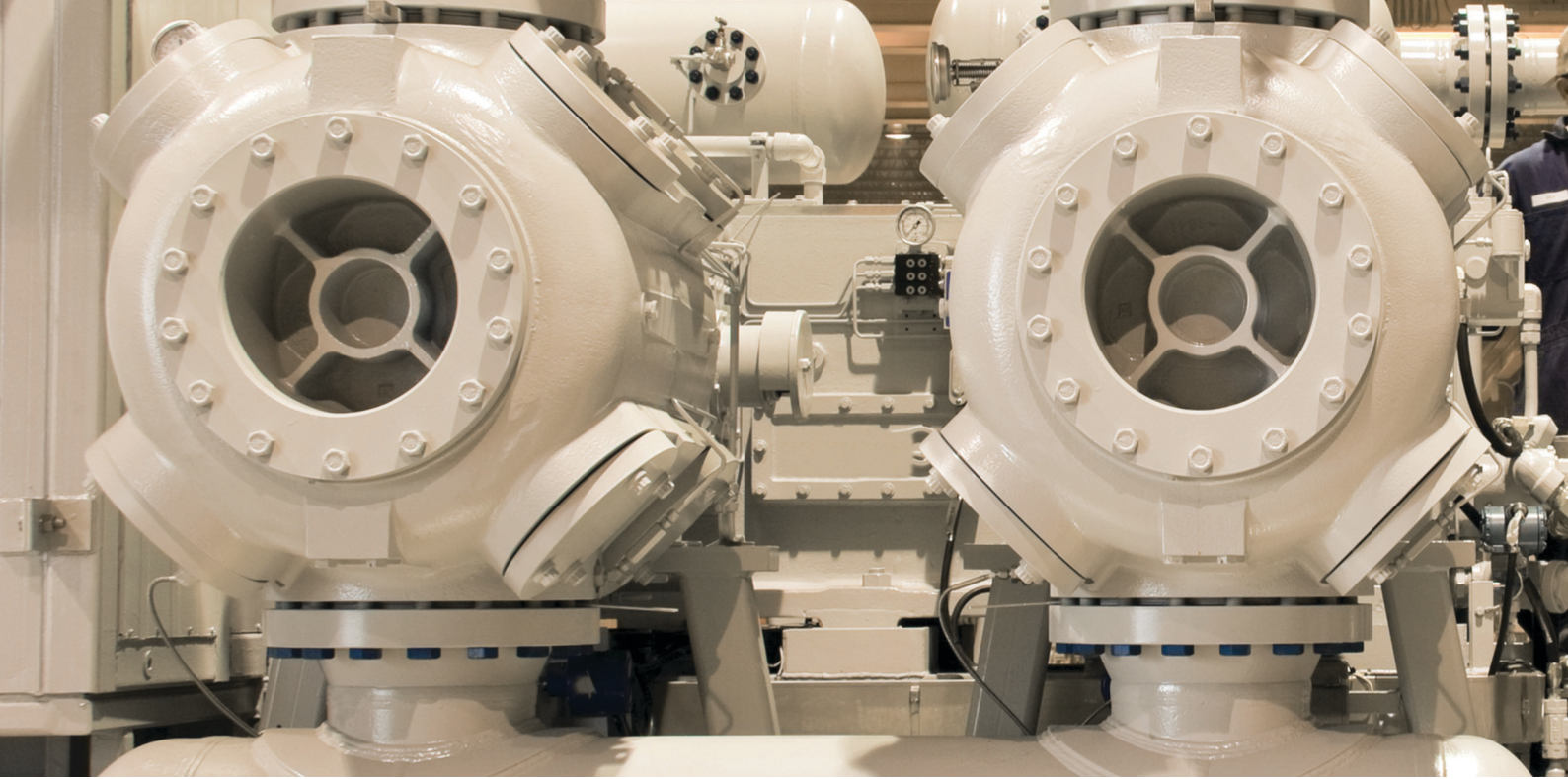

Pumps in process cooling or air-conditioning systems

- Coolant pump capacity according to demand
- Stable coolant flow and pressure
- Stand-alone control using VLT® Refrigeration Drive FC 103
- Operate from direct signal (0/4-20 mA or 0-10 V DC)

Fans in process cooling or air-conditioning systems

- Optimized operation of air handling units
- High efficiency
- Airflow according to demand
- Stand-alone control using VLT® Refrigeration Drive FC 103
- Operate from direct signal (0/4-20 mA or 0-10 V DC)

Depending on the application, speed control can result in energy savings ranging from 10% to as much as 70%.

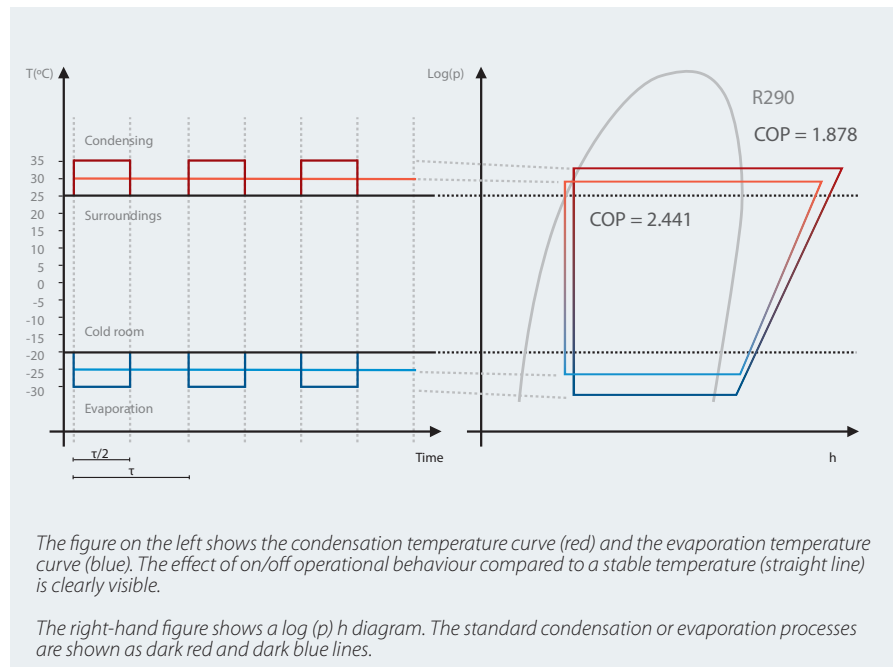

The figure on the left shows the condensation temperature curve (red) and the evaporation temperature curve (blue). The effect of on/off operational behaviour compared to a stable temperature (straight line) is clearly visible.

The right-hand figure shows a log (p) h diagram. The standard condensation or evaporation processes are shown as dark red and dark blue lines.

Multi-zone pack controller

– Improved energy savings and stable operation



Read the compressor status directly from the display. D = Variable speed control, O = Off, R = Mains operation, X = Deactivated

There is a speed range in the interaction between the compressor and frequency converter that allows the system to save energy. The compressor should function within this range most of the time. If the difference between the maximum required performance and the average performance under partial load is too great, it is a good idea to use a cascade configuration. In many cases the required capital investment, including the conversion of an existing system, will be amortised quickly.

Cascading the system

In a system with cascaded compressors, the base load is handled by a speed-controlled compressor. If the demand rises, the drive starts up additional compressors one at a time. As a result, the compressors work largely at their optimum efficiency point, with the control constantly ensuring that the system is operating at maximum energy efficiency. Step-less capacity control thus achieved eliminates the need for large number of small size compressors. This cascading principle can also be applied to fans and pumps using the VLT® Refrigeration Drive FC 103.

Advanced Multi-zone pack controller

- Effectively cascades and controls up to 6 compressors pack
- Focused towards piston, screw and scroll compressors
- Three zone setups avoid too frequent staging and de-staging
- Makes pressures & temperatures stable.
- Reduces compressor wear & tear
- Can also control groups of condenser fans

Easy commissioning

The VLT® Refrigeration FC 103 drive offers a setup wizard, using common refrigeration terms rather than computer language. Field testing shows that ease of programming makes installers and service technicians more comfortable and confident, making their jobs easier and quicker.

The wizard menu also supports the commissioning engineers if they encounter any problems. The menu will help the engineer troubleshoot and offer 'quick fixes' to get the drive up and running if there is a problem.

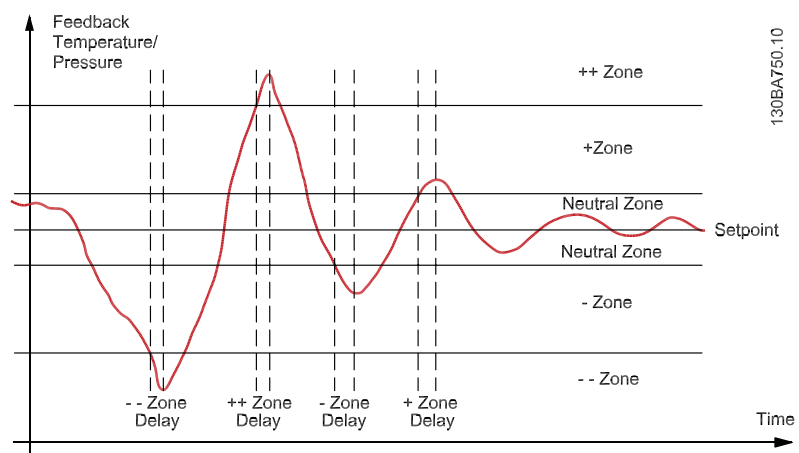

Commissioning is fast and easy using the the frequency converter display panel. The wizard that appears the first time the device is switched on guides the user through the necessary settings.

The user only has to switch from external to internal control. If necessary, the wizard can be called up again from the Quick Menu. Configuring the necessary parameters is even easier with the wizard in the VLT® Motion Control Tool MCT 10 software.

During operations, the FC 103 can show the compressor status on the frequency converter display panel and log the compressor's operating time and number of starts.

Reduced service costs

Mechanical wear is automatically reduced by the fact that only as many compressors are running as are actually needed. This allows service intervals to be extended. The user can configure rotation of mains-powered compressors to ensure that they all end up with a similar number of operating hours.

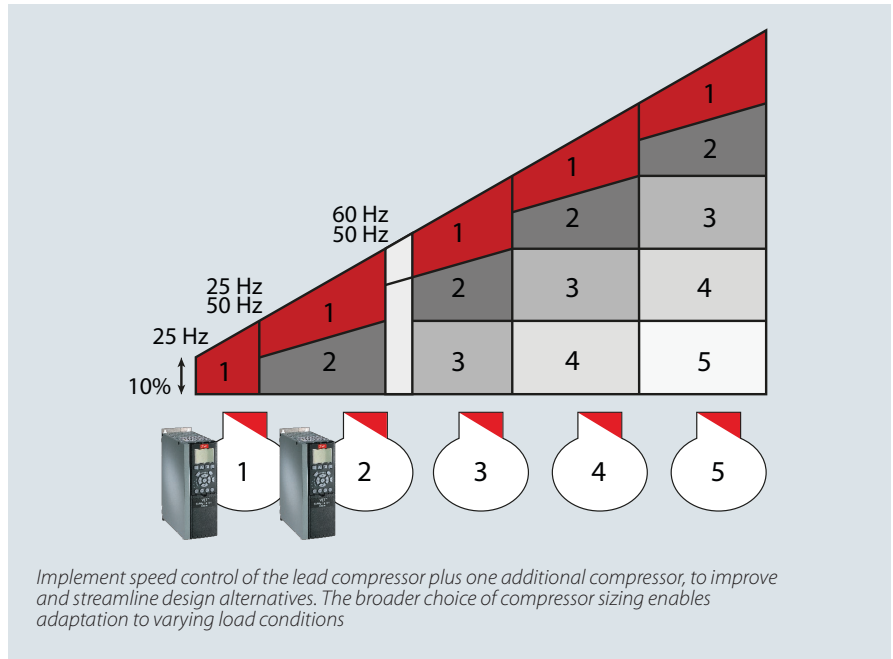

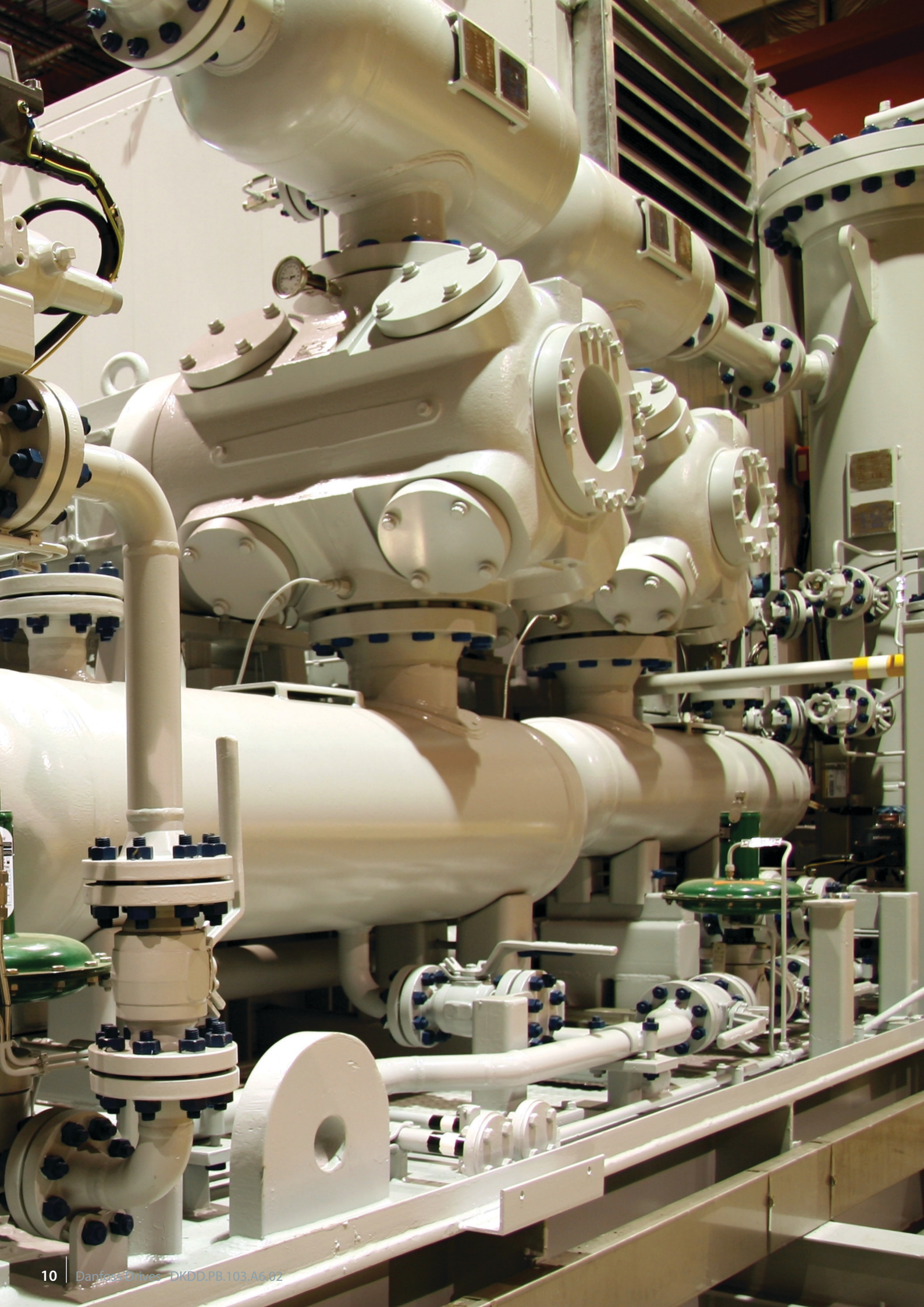

Dedicated compressor features

The VLT® Refrigeration Drive FC 103 is designed for operating piston, scroll, screw compressors and centrifugal compressors. Variable speed control allows the refrigeration capacity of a compressor to be adapted to exactly match the demand.

Day/night control

Compressors usually operate with different setpoints depending on the time of day. This in turn results in different evaporator fan speeds, resulting in reduced energy consumption. This function can be easily programmed with day/night control.

Neutral Zone

The FC 103 continues to control fixed speed compressors in situations where the variable speed compressor fails. Neutral zone is in a fail situation set by a special parameter "Fixed speed neutral zone". This gives the opportunity to have fewer starts by expanding the neutral zone and longer duration of safe operation even under challenging situations.

Oil Return Management

If compressors run at low speed for longer periods of time, lubrication oil will end up in the refrigerant and pipelines. Lack of oil in crankcase causes insufficient lubrication. Built-in oil return management in the FC 103 ensures oil is returned to crankcase thus significantly improving system reliability. Oil management functionality increases the compressor speed up to its maximum value for the user defined interval of time and brings the oil back to the compressor.

- Oil boost functionality activates at fixed time intervals
- Or when the compressor speed has been lower than nominal speed for too long time
- Improves lubrication and system reliability

Condensing temperature monitoring

The frequency converter can monitor the Floating Head Pressure high pressure levels using connected temperature sensors. Speed is reduced before the head pressure reaches a critical value. This allows safe operation of system for longer duration thus enhancing food safety and process control.

Single compressor or pack

The user has the choice of operating the system with a single large compressor or using the pack controller to operate the system with several smaller compressors which are activated as the demand for cooling capacity increases. The built in Pack Controller can distribute running hours evenly across all compressors, keeping wear and tear on individual compressors to a minimum and ensures that all compressors are in great shape.

Direct entry of evaporator temperature

The user can enter the desired evaporator temperature directly in the control panel of the FC 103. The frequency converter also takes the properties of the refrigerant into account. Tables for the most commonly used refrigerants are preloaded in the frequency converter. User-defined entry of the refrigerant used in the system is also possible. Simplifies commissioning.

Inject ON

When all connected compressors on the FC 103 are stopped due to a missing safety circuit, this will be registered by the system unit which will close all valves connected to the case controllers. This supports prevention of liquid flow to the compressor when FC 103 starts the compressor again. As soon as a compressor starts running again, the valves will reopen.

Fewer starts and stops

Start-up is the critical phase of compressor operation. The FC 103 minimises the number of required starts and stops by varying the speed of the compressor to match the capacity to the cooling demand. This ensures maximum run time and minimum number of starts and stops. In addition, the maximum number of start/stop cycles in a given period can be configured using the control panel.

Unloaded start

To further extend the lifetime of the FC 103 a pressure relief valve can be opened to allow the compressor to start up quickly with no load.

135% Starting torque

The FC 103 delivers 135% of the rated starting torque for a period of half a second. In normal operation, 110% of the rated torque is available for 60 seconds.

Smaller compressors with the same peak load

The operator can configure the system with a smaller compressor for a given peak load. This provided that the compressor is designed for over-speed operation, the FC 103 can run it at up to 90 Hz. This may allow brief peak loads to be handled in this way without necessarily requiring a larger compressor for this purpose.

P0 optimisation

The FC 103 supports connection of an ADAP-KOOL® LonWorks control for P0 optimisation.

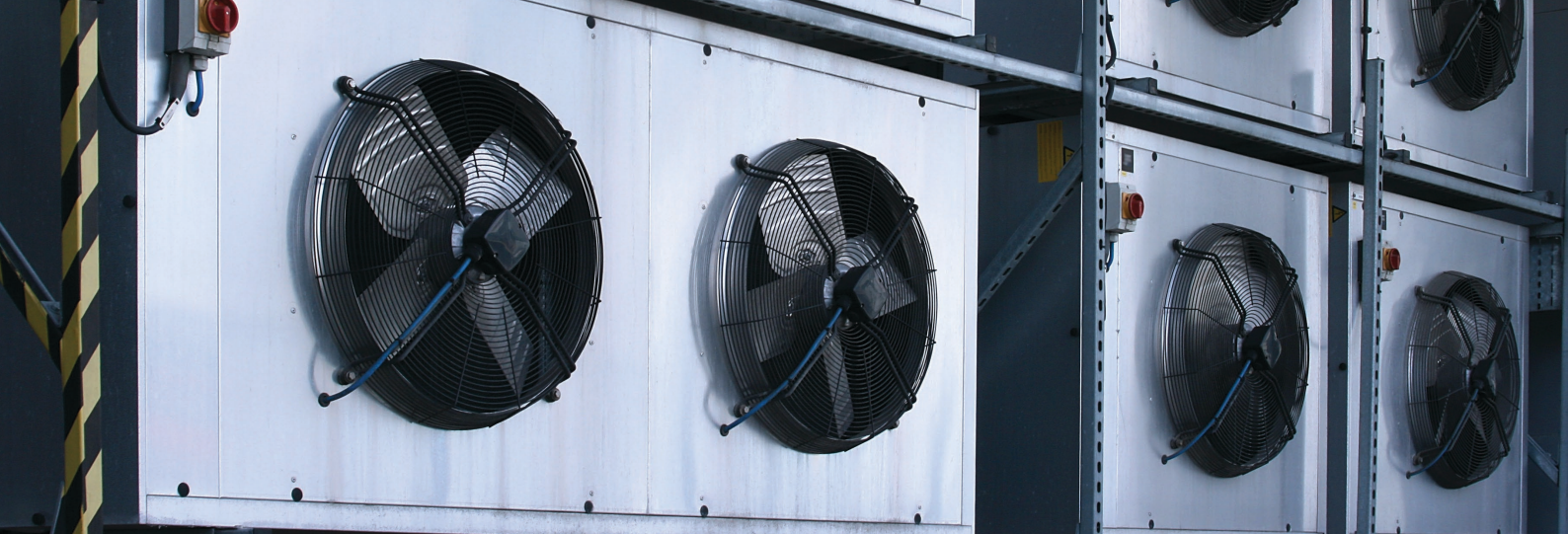

Dedicated condenser and evaporator features

User-friendly, distributed intelligence and reduced power consumption are beneficial for condenser and evaporator applications.

Floating condensing temperature optimises COP

VLT® Refrigeration Drive FC 103 intelligently controls evaporative condensers or air-cooled condensers to optimise refrigeration system performance (COP) at lower energy consumption. The drive adapts condensing temperature set point as the outdoor temperature drops, lowering the set point to a new stable level. This functionality provides:

- Increased cooling capacity at lower power consumption
- Ability to run on fewer compressors, hence reducing wear and tear

Intelligent functions

The FC 103 handles logical rules and inputs from sensors, real time functionality and time-related actions. This enables the FC 103 to control a wide range of functions, including:

- Weekend and working-day operations
- Cascaded P-PI for temperature control
- Belt monitoring

Resonance monitoring

By pressing a few buttons on the Local Control Panel, the drive can be set to avoid frequency bands, at which connected fans create resonances in the in condensers or evaporators. This reduces vibration noise and wear and tear on equipment.

Auto tuning of the PI controllers

With auto tuning of the PI controllers, the drive monitors how the system reacts on corrections made by the drive – and learns from it.

Extended I/O capacity

When operated by an external controller, all the FC 103 I/O points are available as remote I/O to extend the capacity of the controller. For example, room temperature sensors (Pt1000/ Ni1000) can be directly connected.

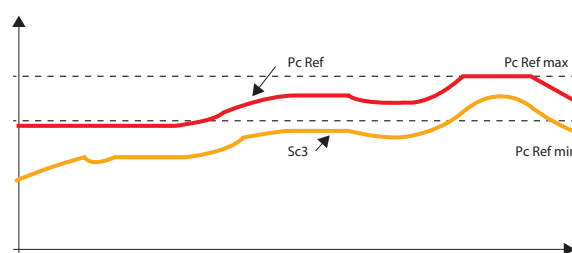

Floating condensing temperature set point control by VLT® Refrigeration Drive FC 103.

4 x PID controller

(Individual set-points/feed-backs)

- PID for closed loop control of the motor connected to the drive
- 3 PIDs for external closed loop control of refrigeration equipment
- Auto-tuning of all 4 PID loops
- Eliminates the need for other controllers
- Provides flexibility for the controller and reduces the load



Dedicated pump features

The VLT® Refrigeration Drive FC 103 offers a vast number of pump-specific features developed in cooperation with OEMs, contractors and manufacturers around the world.

Embedded Pump Cascade Controller

The Pump Cascade Controller distributes running hours evenly across all pumps, keeps wear and tear on individual pumps to a minimum and ensures that all pumps are in great shape.

Leakage or broken pipe

Continuous liquid supply can be assured in the event of leakage or a broken pipe. For example, overload is prevented by reducing drive speed – and supply is secured at lower flow.

Sleep Mode

In Sleep Mode the drive detects situations with low or no flow. Instead of continuous operation, sleep mode boosts the system pressure and then stops to save energy. The drive starts automatically when the pressure falls below the lower set point.

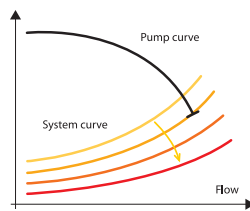

Dry Pump Protection and End of Curve

Dry Pump Protection and End of Curve relate to situations where the pump runs without creating the desired pressure – for example, when a pipe leaks. In this situation the drive sets off an alarm, shuts off the pump, or performs another pre-programmed action.

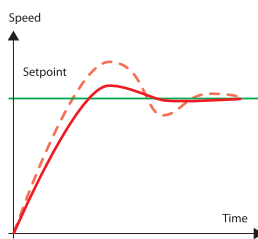

Auto tuning of the PI controllers

With auto tuning of the PI controllers, the drive monitors how the system reacts to corrections made by the drive, learns from it, and calculates the 'P' and 'I' values so that precise and stable operation is achieved quickly. This applies to each PI controller in the 4-menu sets individually. Exact P and I settings at start-up will not be necessary – which lowers commissioning costs.

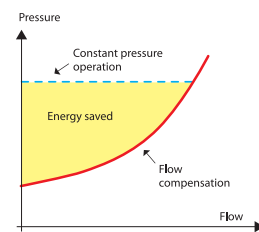

Flow compensation

Significant energy savings and reduced installation costs are provided by flow compensation in both fan and pump systems. A pressure sensor mounted close to the fan or pump provides a reference enabling pressure to be kept constant at the discharge end of the system. The drive constantly adjusts the pressure reference to follow the system curve.

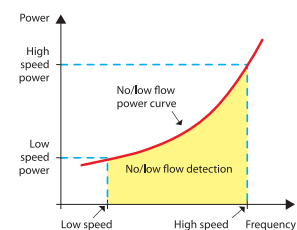

No/low flow

An operating pump will normally consume more power the faster it runs – according to a curve determined by the pump and application design. The FC 103 will detect situations where the pump runs fast but is not fully loaded. This could indicate that water circulation has stopped, the pump runs dry, or a leaking pipe.

VLT® Refrigeration Drive

Systematic energy savings



The VLT® Refrigeration Drive FC 103 benefits from Danfoss' many years of experience in both refrigeration and drive technology. It combines an energy-efficient power stage with advanced software algorithms. This is the only way to effectively realise potential energy savings.

VVC+ vector control

The FC 103 uses proven VVC+ vector control, which automatically adapts to all load conditions and supplies exactly the right voltage to the motor.

Fan and pump applications

Due to their nonlinear load characteristics, the power consumption of fans and pumps can be radically reduced by using intelligent speed control. Power consumption decreases with the cube of the reduction in speed.

Higher system efficiency reduces power dissipation

With efficiency ratings up to 99% and a power factor greater than 0.9, VLT® frequency converters are distinctly better than comparable devices. Losses for chokes and filters are already allowed for in the rating.

This reduces not only direct energy costs for the drive itself, but also the costs for air conditioning or removing additional heat.

Low power consumption in standby mode

Speed-controlled cooling fans with control electronics designed for low current draw can ensure low power consumption even in standby mode. Thanks to its short start-up period when switched on, the power stage can be completely disconnected from the mains during short breaks in operation.

AEO control for automatic load balancing

Automatic Energy Optimising (AEO) provides additional energy savings of up to 5%. This feature matches the input current to the actual motor speed and load, and draws only the amount of power necessary for motor excitation and operation with this load. This avoids additional thermal losses in the motor.

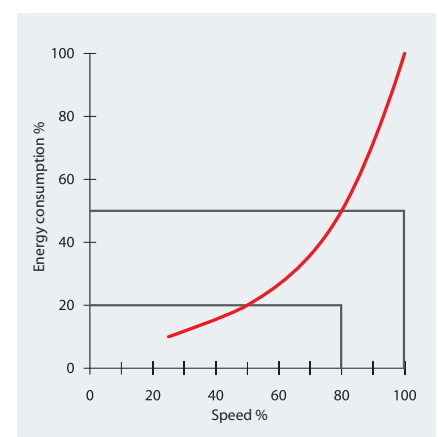

On fan and pumps up to 50% energy can be saved by reducing the speed from 100% to 80%.

Free choice of motor technology Easy commissioning and algorithms for optimal efficiency

As an independent manufacturer of drive solutions, Danfoss is committed to supporting all commonly used motor types and fostering ongoing development.

Danfoss frequency converters have traditionally offered control algorithms for high efficiency with standard induction motors and permanent magnet (PM) motors, and now they also sup-

port synchronous reluctance motors. In this way Danfoss offers you to combine your favorite motor technology like asynchronous-, permanent magnet- or synchronous reluctance motors with a VLT® Refrigeration Drive.

Furthermore, the VLT® Refrigeration Drive makes commissioning just as easy as with standard induction motors by combining ease of use



Protect people and equipment

To protect people and equipment, in practically all refrigeration applications, the system operator must ensure that compressors are actually stopped and cannot start up again. This is important in order to avoid HP tripping or vacuum formation in the suction line or the evaporator.

The Safe Torque Off function (compliant with EN 61800-5-2) of the VLT® Refrigeration Drive FC 103 provides a cost-effective way to implement this with high reliability. Unlike software functions that trigger a stop command using the digital inputs, here the control voltage of the output module is enabled or disabled directly via the safe terminal of the frequency converter.

This reduces cabling cost, and the functionality integrated in the FC 103 eliminates the need for costly and bulky external components, such as contactors and relays, that are used for this purpose in conventional solutions.

Easy commissioning

Another significant advantage of the integrated safety function in the FC 103 is that it can be activated without

special software or complicated set-up procedures. This considerably simplifies commissioning, servicing, and the replacement of individual components.

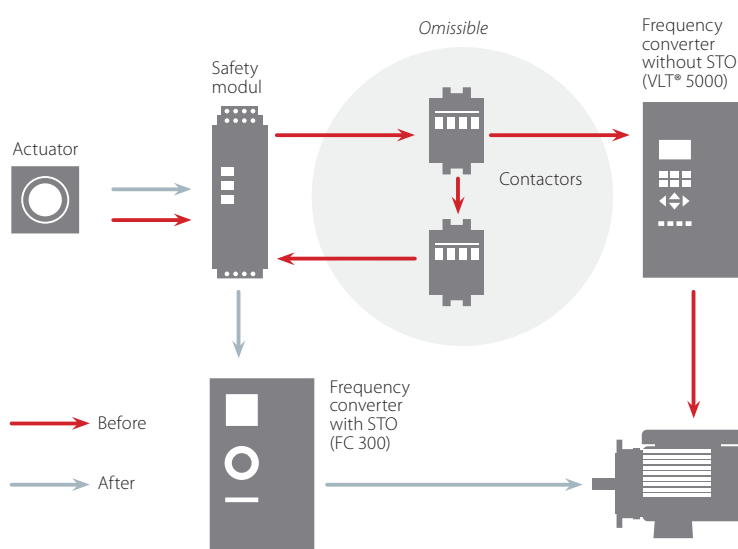

Two contactors can be omitted in safety installations due to the safety functionality in VLT® Refrigeration Drive.



Simplified installation

VLT® Refrigeration Drive FC 103 eliminates the need for special start equipment due to built-in current reduction. It offers motor protection against overload and high temperature conditions and has built-in crank case heater functionality.

Start up compressors gently and reduce wear and tear

There is often insufficient lubrication when compressors are started or operated at excessively low speeds. This is not a problem when compressors are started directly from the mains, since they pass through the critical area quickly.

However, in theory the situation is different with variable speed operation: long ramp times mean slow acceleration, resulting in extended operation in the critical region.

To effectively avoid this potential source of wear, the FC 103 provides a separate start ramp for the start-up process when working with a compressor. Once the compressor has passed through the critical region and

adequate lubrication is assured, it automatically switches to a slower and gentler starting ramp. Naturally, the fast ramp is also active during the stop process.

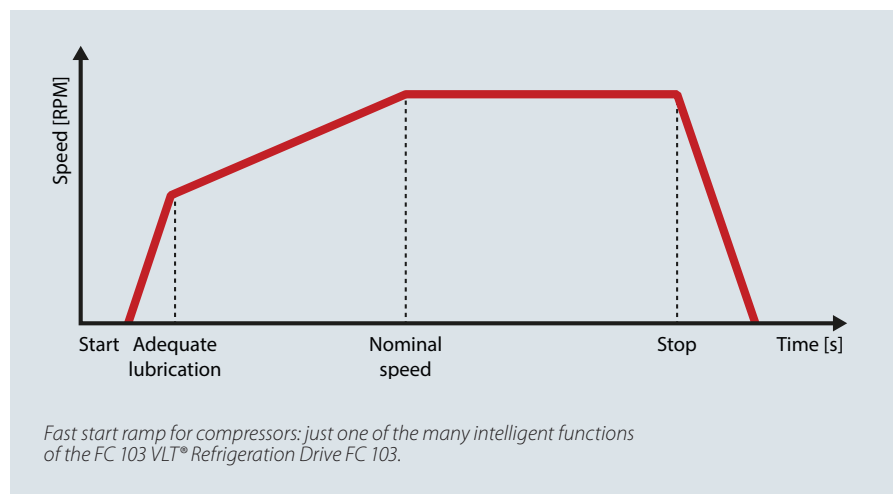

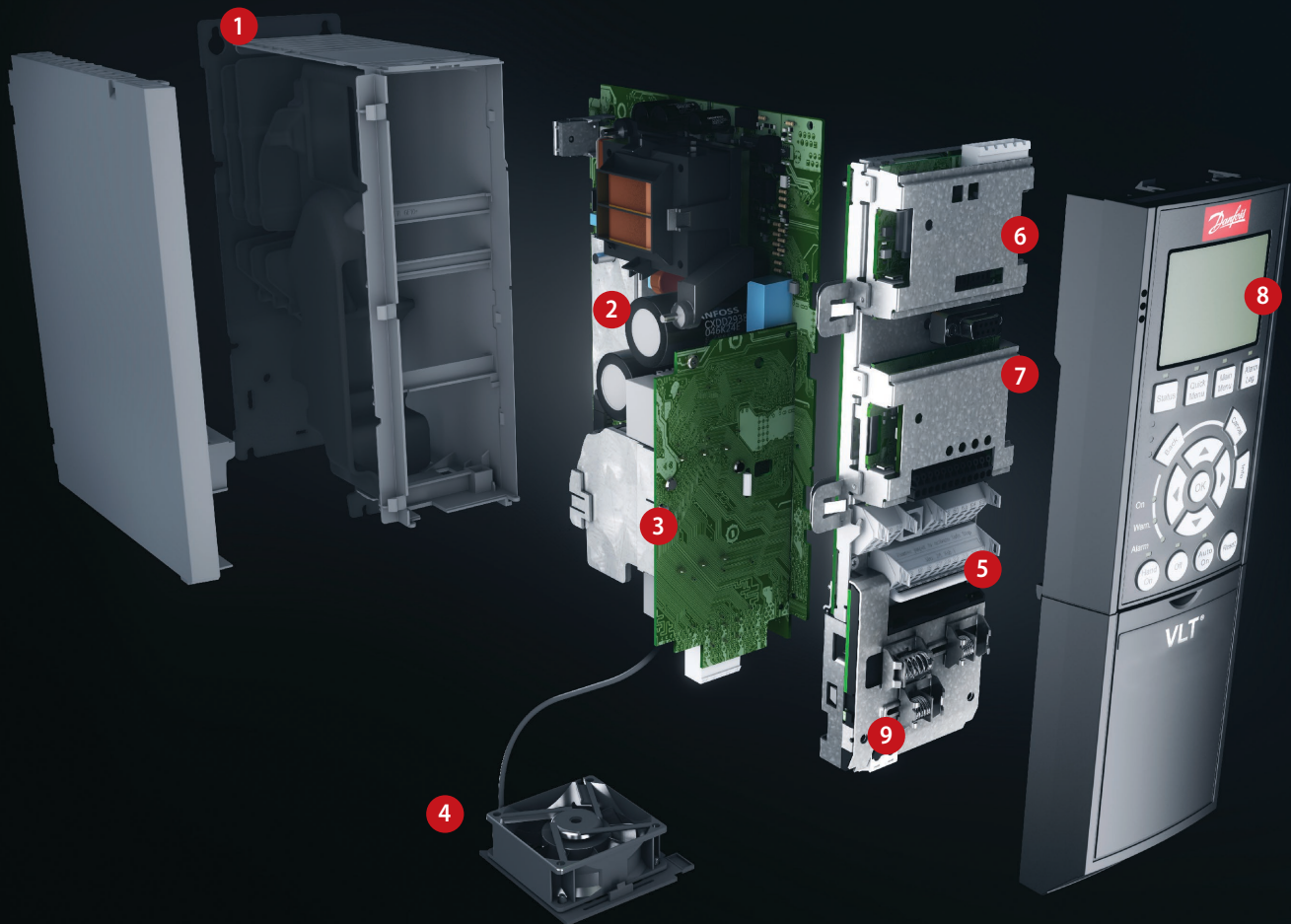

Modular simplicity

Delivered fully assembled and tested to meet your specific requirements

1. Enclosure

The drive meets requirements for enclosure class IP20/Chassis. IP21/Type 1, IP54/Type 12, IP55/Type 12 or IP66/Type 4X.

2. EMC and Network effects

All versions of VLT® Refrigeration Drive comply as standard with EMC limits B, A1 or A2 according to the EN 55011 norm. The standard integrated DC coils ensure low harmonic load on the network according to EN 61000-3-12 and increase the lifetime of the DC link capacitors.

3. Protective coating

The electronic components are, as standard, coated as per IEC 60721-3-3, class 3C2. For harsh and aggressive environments, coating as per IEC 60721-3-3, class 3C3 is available.

4. Removable fan

Like most of the elements, the fan can be quickly removed and remounted for easy cleaning.

5. Control terminals

Double-stack, spring-loaded cage clamps enhance reliability and facilitate easy commissioning and service.

6. Fieldbus option

See complete list of available fieldbus options on page 52.

7. Pack controller and I/O extensions

Controls multiple compressors, condensers, evaporators or pumps. *See also pages 11 to 13.*

A wide range of I/O options are available either factory-mounted or as retrofit.

8. Display option

Danfoss Drives' removable Local Control Panel is available with a variety of language packs.

English is available in all drives.

Alternatively the drive can be commissioned via the built-in USB/RS485 connection or a fieldbus with VLT® Motion Control Tool MCT 10 setup software.

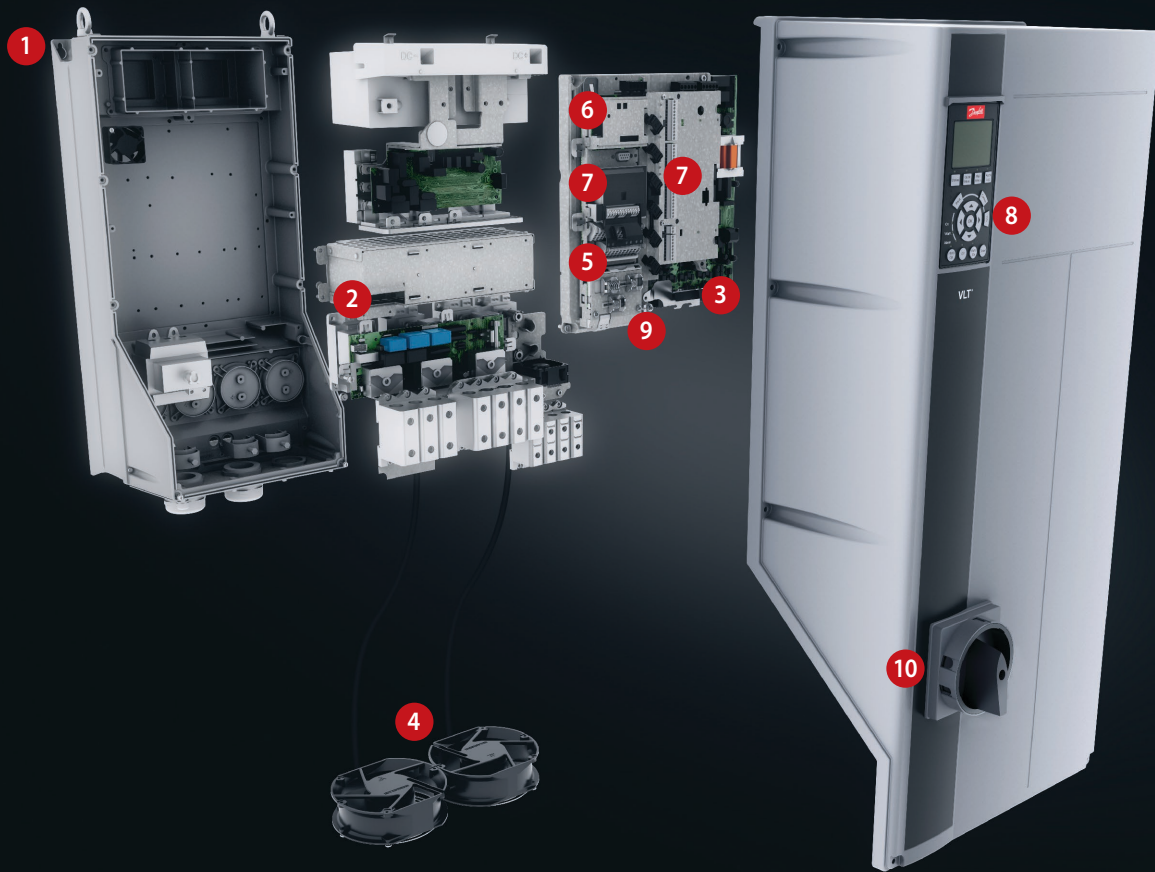

9. 24 V external power supply

The external 24 V supply keeps the VLT® Refrigeration Drive logic “alive” when the AC mains is removed.

10. Mains disconnect

This switch interrupts the mains supply and has a free useable auxiliary contact.

Safety

The VLT® Refrigeration Drive can optionally be delivered with the Safe Torque Off (Safe Stop) functionality suitable for category 3, performance level d according to EN 13849-1 and SIL 2 according to IEC 62061/IEC 61508. This feature prevents the drive from starting unintended.

Built-in Smart Logic Controller

The Smart Logic Controller is a clever way to add customer-specific functionality to the drive and increase the opportunities for the drive, motor and application working together.

The controller monitors a specified event. When an event occurs, the controller performs a pre-defined action and then starts monitoring for the next pre-defined event. 20 steps of events and resulting actions are available before returning to the first set.

Logic functions can be selected and run independent from the sequence control. This enables drives to monitor variables or signal defined events in an easy and flexible way independently of the motor control.



Intuitive setup with graphical interface

The VLT® Refrigeration Drive features a user-friendly, hot pluggable local control panel (LCP) for easy setup and parameter configuration.

After choosing language navigate through setup parameters individually. Alternatively, use a pre-defined quick menu or a SmartStart guide for application specific setup.

The LCP can be detached and used to copy settings to other Refrigeration Drives in the system. It can also be

mounted remotely on a control panel fascia. This enables the user to take full advantage of the LCP, eliminating the need for additional switches and instrumentation.

My Personal Menu allows direct access to up to 50 user-selectable parameters.

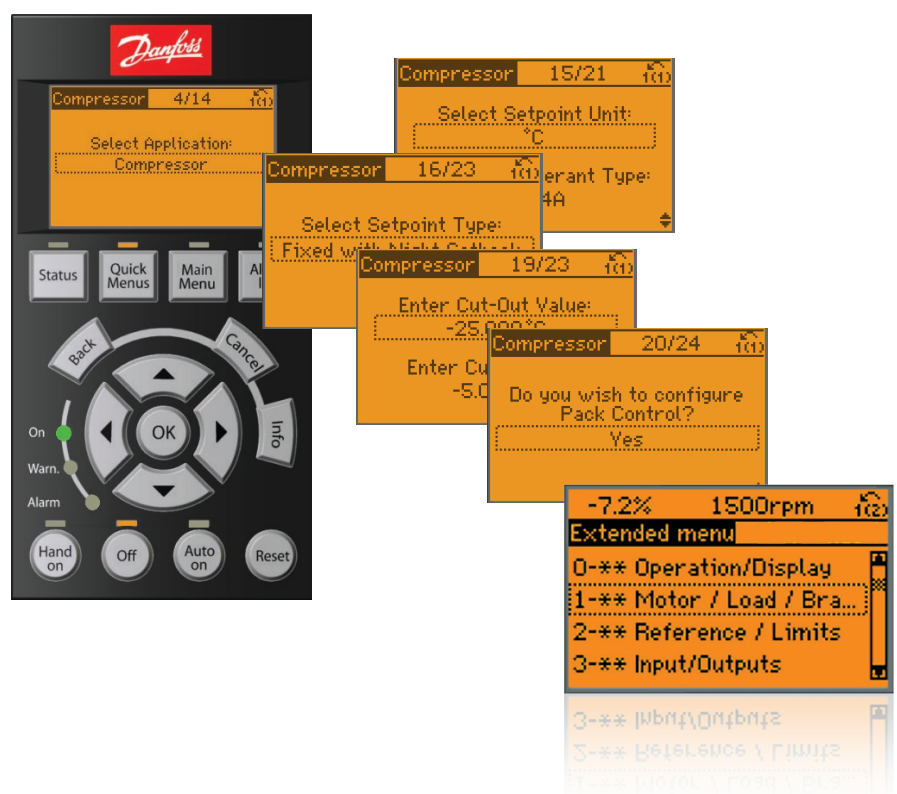

Efficient set-up wizard speaks refrigeration language

For setting up the drive in the most efficient and logical way, the text and language used in the drive make complete sense to the engineers and installers in the field of refrigeration.

To make installation even more efficient, the built-in "Set-up wizard menu" guides user through the set-up of the drive in a clear and structured manner. The following applications are supported:

- Multi compressor control
- Multi condenser fan, cooling tower / evaporative condensing
- Single fan and pump
- Pump system

The feature is activated at the first power up, after a factory reset, or from the quick menu. When activating the

wizard, the drive will ask for the information it needs to run the application.

You will be guided through the programming of all important parameters like motor data and used control signal (including instructions for connection). At every single step help is easily available by pressing the info button on the display.

Finally, you can also choose to start the Automatic Motor Adaptation (AMA). This functionality will determine the exact motor data and thereby ensure robust and energy efficient operation of your appliance.

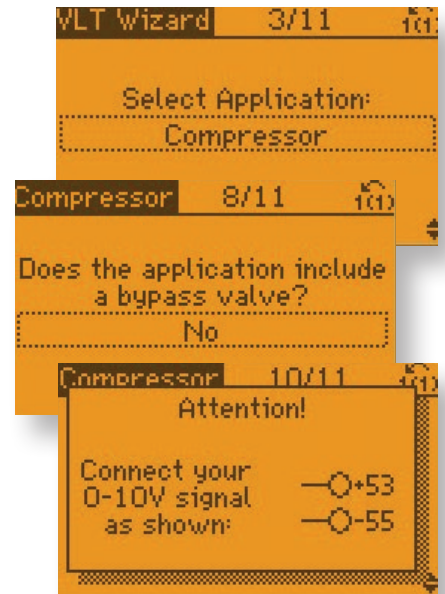

VLT® Motion Control Tool

The real effect is money saved

Free VLT® Motion Control Tool MCT 10 set-up software provides easy control of details as well as a general overview of drive systems, large or small. The tool handles all drives-related data.

Explorer-like interface

The MCT 10 software features Explorer-like interface design and functionality to ease both use and learning of the facilities.

More efficient service organisation

- Scope & logging: analyze problems easily
- Read out alarms, warnings and error log in one view
- Compare a saved project with an on-line drive

More efficient commissioning

- Easy fieldbus handling, multiple drives in project file. Enables the service organization to be more efficient

- Offline commissioning off-site
- Save/send/mail projects anywhere

Basic

- Scope & Graph
- Alarm history in saved projects
- Graphical Timebased Actions, Preventive Maintenance and Basic Cascade Controller
- Multiple fieldbus support

Advanced

- No limitation in the number of drives
- Motor database
- Real-time logging from the drive

Online and offline mode

In the online mode, you work with the actual setup of the drives in question. Your actions will have immediate effect on the performance of the drive(s).

Connections

- USB
- RS485

Project oriented

In project mode you work with the drive parameters as a 'virtual' set-up. This allows you to adjust the whole system before you implement it into the drives and put it in action. In project mode you can set the system up even before the drives are installed. A single command will update the whole system. In case a drive is exchanged, it is easily set up to perform exactly as its predecessor.

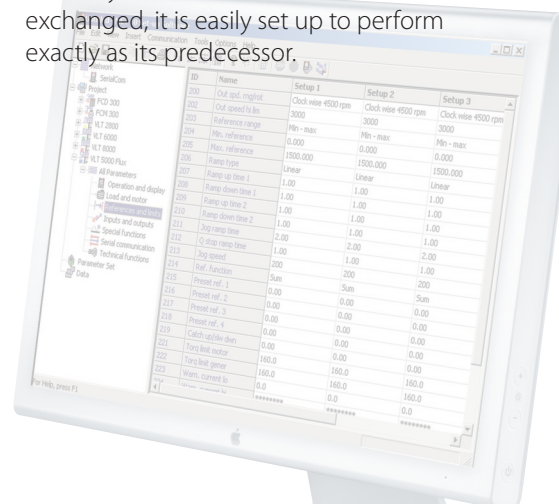



Optimize performance and grid protection

Built-in protection as standard

The VLT® Refrigeration Drive FC 103 contains all modules necessary for compliance with EMC standards.

A built-in, scalable RFI filter minimizes electromagnetic interference and the integrated DC link chokes reduce the harmonic distortion in the mains network, in accordance with IEC 61000-3-2. Furthermore, they increase the lifetime of the DC link capacitors and therefore also the drive's overall efficiency.

The solutions save cabinet space, as they are integrated in the drive from the factory. Efficient EMC mitigation also enables the use of cables with smaller cross-sections, which again reduces installation costs.

**Danfoss VLT®
Refrigeration Drives
are equipped with DC
chokes that reduce mains
interference to a THDi of**

40%

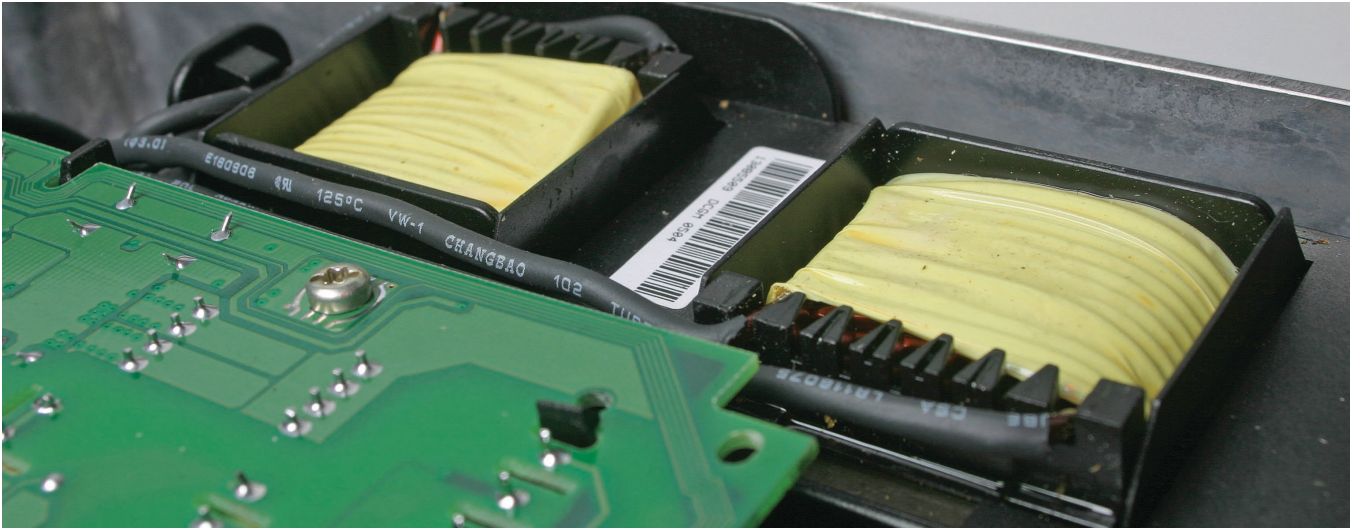

Expand grid and motor protection with filter solutions

If needed, Danfoss' wide range of solutions for harmonic mitigation can provide additional protection, such as the

- VLT® Advanced Harmonic Filter AHF
- VLT® Advanced Active Filter AAF
- VLT® 12-pulse Drives

Provide motor protection with:

- VLT® Sine Wave Filter
- VLT® dU/dt Filter
- VLT® Common Mode Filters

With this solutions you may achieve optimum performance for your application, even in weak or unstable grids.

Use motor cables up to 300 m

The design of the VLT® Refrigeration Drive FC 103 makes it a perfect choice in applications that require long motor cables. Without needing additional components the drive provides trouble free operation with cable lengths of up to 150 m screened or 300 m unscreened. This allows the drive to be installed in a central control room a distance away from the application without affecting motor performance.

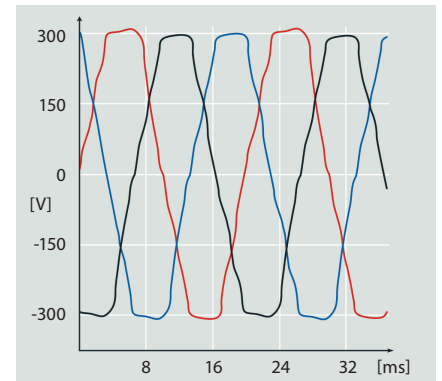

Harmonic distortion

Electrical interference reduces efficiency and risks harming equipment.

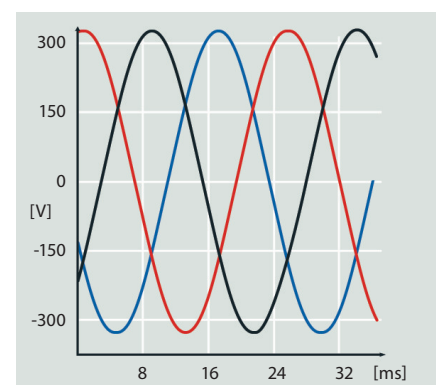

Optimised Harmonic performance

Efficient harmonic mitigation protects electronics and increases efficiency.

EMC Standards		Conducted emission		
Standards and requirements	EN 55011 Facility operators must comply with EN 55011	Class B Housing and light industries	Class A Group 1 Industrial environment	Class A Group 2 Industrial environment
	EN/IEC 61800-3 Converter manufacturers must conform to EN 61800-3	Category C1 First environment, home and office	Category C2 First environment, home and office	Category C3 Second environment
FC 103 compliance ¹⁾		■	■	■

For further details see the VLT® Refrigeration Drive Design Guide
¹⁾ Compliance to mentioned EMC classes depends on the selected filter

Adverse effects of harmonics

- Limitations on supply and network utilization
- Increased transformer, motor and cable heating
- Reduced equipment lifetime
- Costly equipment downtime
- Control system malfunctions
- Pulsating and reduced motor torque
- Audible noise

Solutions for harmonics mitigation

The mains voltage supplied by electricity utilities to homes, businesses and industry should be a uniform sinusoidal voltage with a constant amplitude and frequency.

This ideal situation is no longer found in any power grid due to harmonics. This is mainly because consumers take non-sinusoidal current from the grid or have a nonlinear characteristic, e.g. strip lights, light dampers, energy-saving bulbs and frequency converters.

Because of the constantly increasing use of non-linear loads, deviations become increasingly serious. Irregular power supplies influence the performance and operation of electrical equipment, so motors, frequency converters and transformers must be more highly rated to maintain proper operation.



VLT® Advanced Active Filter AAF 006

VLT® Advanced Active Filters identify harmonic distortion from non-linear loads and inject counter-phase harmonic and reactive currents into the AC line to cancel out the distortion, resulting in distortion levels of no more than 5% THvD. The optimal sinusoidal waveform of the AC power is restored and the power factor of the system is reestablished at 1.

Advanced Active Filters follow the same design principles as all our other drives. The modular platform provides high energy efficiency, user friendly operation, efficient cooling and high enclosure ratings.

VLT® Advanced Active Filter AAF 006
Voltage range: 380-480 V
Corrective current range: 190-400 A

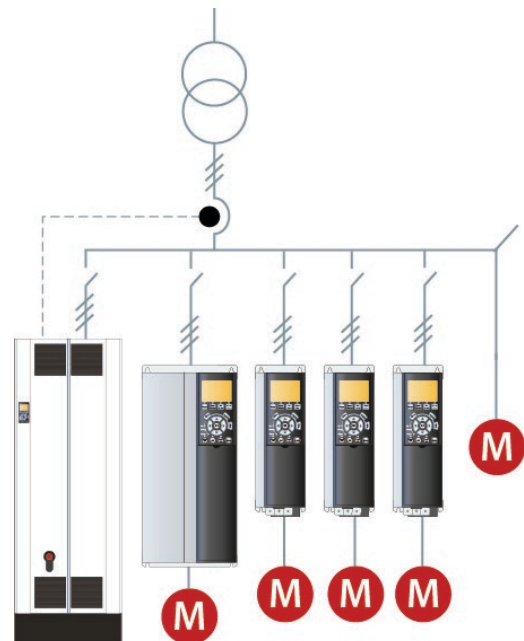

VLT® Advanced Harmonic Filter AHF 005/010

The Danfoss harmonic filters AHF 005/010 are specially designed to be connected in front of a VLT® frequency converter, and ensure that the harmonic current distortion generated back to the mains is reduced to a minimum.

One filter can be used for several frequency converters, helping owners reduce system costs. Easy commissioning saves installation costs, and due to the filter's maintenance free design running expenses for the units are eliminated.

VLT® Advanced Harmonic Filter AHF 005 (5% THiD)
VLT® Advanced Harmonic Filter AHF 010 (10% THiD)
Voltage range: 380-690 V
Filter current range: 10-480 A

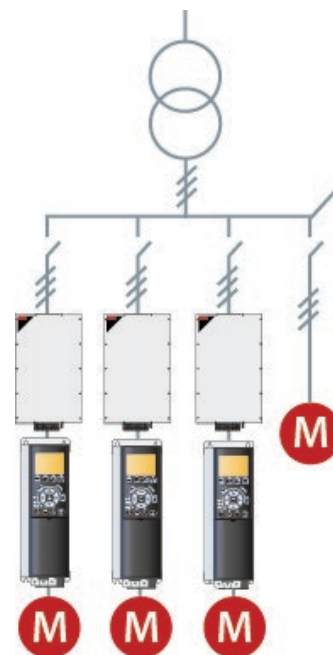

Cost effective mitigation

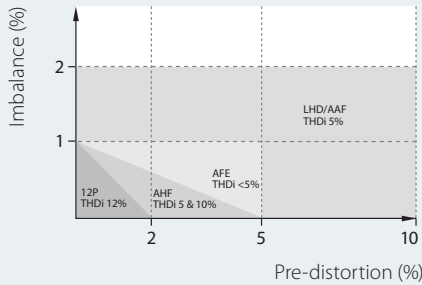

Imbalance and pre-distortion

The harmonic mitigation performance of the different solutions depends on the grid quality. The higher the imbalance and pre-distortion, the more harmonic the equipment has to suppress. The graph shows at what pre-distortion and imbalance level each technology can keep its guaranteed THDi performance.

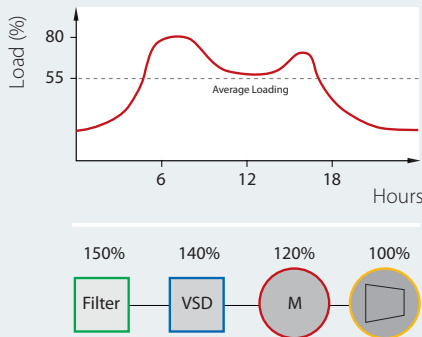
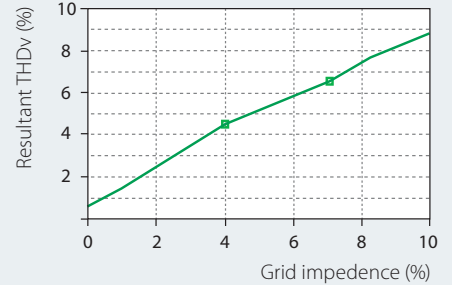

Over-sizing

Published filter data are all given at 100% loading but filters are seldom run at full load due to over-sizing and load profile. Serial mitigation equipment must always be sized for the maximum current, but be aware of the duration of part load operation and evaluate the different filter types accordingly. Over-sizing gives poor mitigation performance and high running costs. It is also a waste of money.

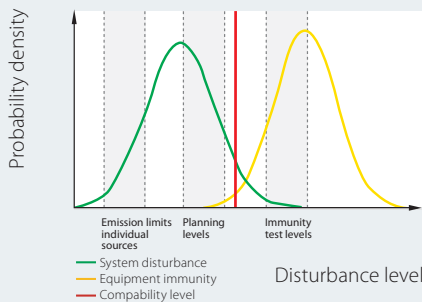
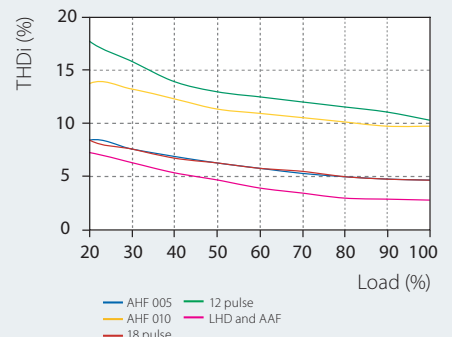

Standards compliance

Keeping equipment immunity higher than system distortion ensures trouble free operation. Most standards set restrictions on total voltage distortion according to a planned level, often between 5% and 8%. Equipment immunity is, in most cases, far higher: for drives, between 15-20%. However, this influences product life adversely.

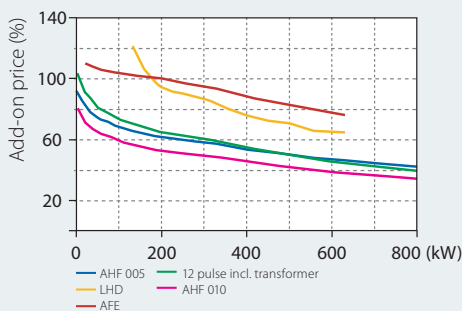
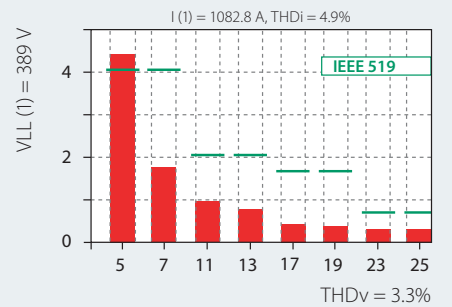

Power size vs. initial costs

Compared to the frequency converter, the different solutions have different add-on prices depending on power size. The passive solutions in general offer the lowest initial cost and as the complexity of the solutions increase, so does the price.

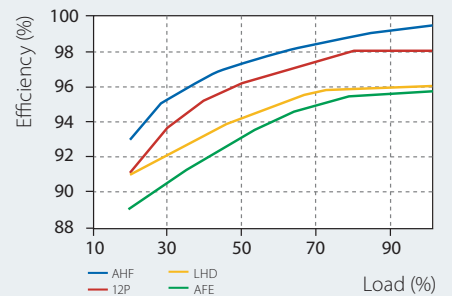

System impedance

As an example, a 400 kW FC 103 drive on a 1000 kVA transformer with 5% impedance results in ~5% THDv (total harmonic voltage distortion) at ideal grid conditions, whereas the same drive on a 1000 kVA, 8% imp. transformer leads to 50% higher THDv, namely 7.5%.

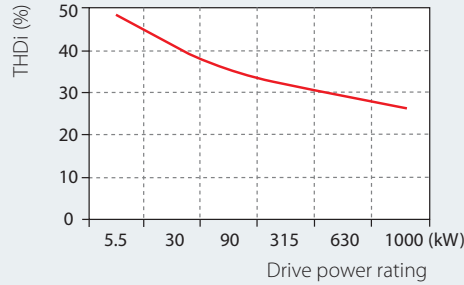

Total Harmonic distortion

Each drive generates its own total harmonic current distortion (THDi) which depends on the grid conditions. The bigger the drive is in relation to the transformer the smaller the THDi.

Harmonic performance

Each harmonic mitigation technology has its own THDi characteristic which is load dependent. These characteristics are set at ideal grid conditions without pre-distortion and with balanced phases. Variations hereof will result in higher THDi values.

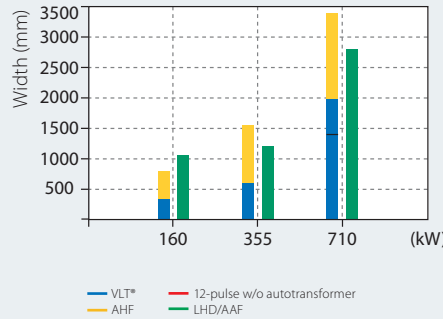

Wall space

In many applications the amount of available wall space is limited and must be utilized to the greatest extent possible. Based on different technologies, the various harmonic solutions each have their optimum size and power relationship.

Fulfilling the standards

To determine whether or not the harmonic pollution of a given application/grid exceeds a specific standard, many complex calculations must be done. With the help from free Danfoss MCT31 harmonic calculation software, this is made easy and less time consuming.

System efficiency

The running cost is mainly determined by the overall system efficiency. This depends on the individual products, true power-factors and efficiencies. Active solutions tend to keep the true power-factor independent of load and grid variations. On the other hand, active solutions are less efficient than passive solutions.

High reliability in any environment



All VLT® Refrigeration Drive FC 103 versions have manganese phosphor rear bodies. IP66/Type 4X enclosed drives are suitable for installation in demanding environments.

Cooling air is kept outside the device to prevent any pollution of the electronics. The surfaces are smooth and easily cleaned.

The IP55/66, Type 4X series are designed for easy accessibility and time-saving installation.

Furthermore, all components such as EMC filters for compliance with EN 55011, class A1/B, as well as the DC coils, are protected inside the drive.

Because of the high-density integration, the tight housings of the VLT® Refrigeration Drive are significantly smaller when compared to other drives of the same performance.

Motor and power cables are mounted securely through glands in the base plate.



The VLT® Refrigeration Drive is also available with a mains switch option. This switch interrupts the mains supply and has a free useable auxiliary contact.



An external watertight USB plug connected to the control card inside IP55/66 enclosures makes USB access easy.



VLT® Refrigeration Drive FC 103

– optimized for installation in panels

IP20 / UL TYPE 1 Enclosures

The functionality fulfills the highest requirements even for applications with high overload, long motor cables and ambient temperatures up to 50 °C (55 °C with derating).

Optimized design

Optimized efficiency and intelligent cooling technology make for a compact and service-friendly design. Supplementary equipment such as EMC filters, harmonics suppression and brake modules are integrated into the enclosure.

Save installation time

The IP20 / UL TYPE 1 enclosure series is designed for easy accessibility and time-saving installation.

Mechanical fastening points are easy to access from the front even with automatic tools.

All terminals are sufficiently dimensioned and clearly marked. Just loosen a few screws to get to the terminals.

Accessories for bonding screened cables are included. The compact enclosures are easier to install. This is important especially within existing installations with limited accessibility. An extensive range of options and accessories are available, optimizing the drive for the respective application.



Intelligent heat management

– cooling methods for additional benefits

Total separation between cooling air and electronics protects the electronics and allows for installation where heat is removed from outside of the cabinets.

With the VLT® Refrigeration Drive FC 103, a flanged heat sink kit is available for mounting the drive in the backplate of a cabinet, separating the heatsink airflow from the electronics.

Eliminating airflow over the electronics increases drive lifetime as contaminants are excluded from the drive.

Back channel cooling minimizes heat loss while increasing energy efficiency, a significant benefit for high power drives.

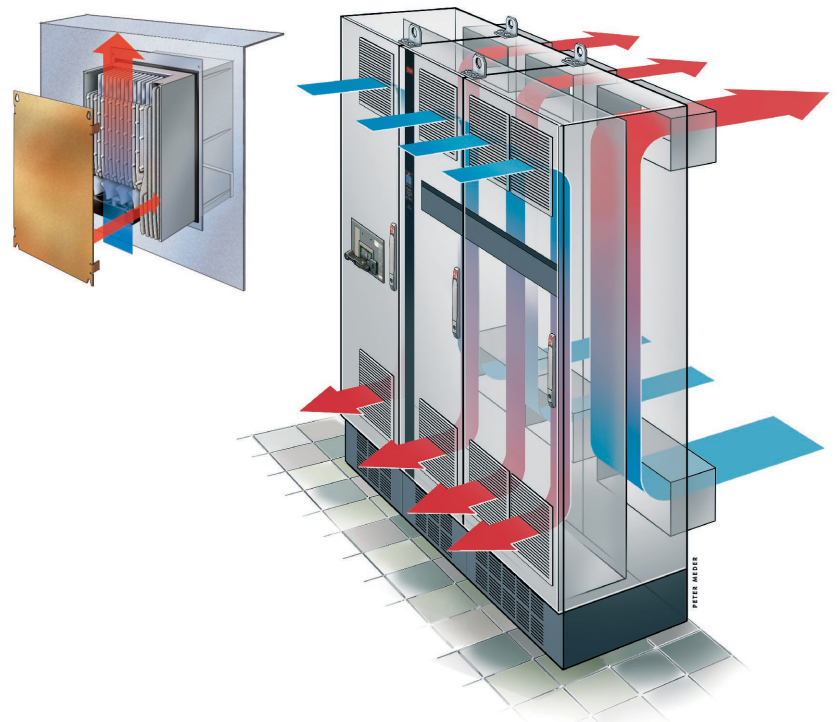



Support common fieldbuses

Increase productivity

With the range of fieldbus options the VLT® Refrigeration Drive FC 103 can be easily connected to the fieldbus system of your choice. This makes the VLT® Refrigeration Drive a future-ready solution that can easily be expanded and updated if your needs change. See the complete list of fieldbuses on page 52.

Danfoss fieldbus options can also be installed as a plug-and-play solution at a later stage, if the production layout demands a new communication platform. This way, you can be confident that you can optimize your plant without being forced to replace your existing drive system.

Download drivers for easy PLC integration

Integrating a drive into an existing bus system can be time consuming and complicated. To make this process easy and more efficient, Danfoss provides all necessary fieldbus drivers and instructions, which can be downloaded for free from the Danfoss website.

After installation the bus parameters, typically only a few, can be set directly in the VLT® drive via the local control panel, the VLT® MCT 10 or the fieldbus itself.



A close-up photograph of several fresh fish, likely salmon, resting on a bed of crushed ice. The fish are arranged in a slightly overlapping manner, showing their silvery scales and vibrant pinkish-red gills. The ice is clear and chunky, providing a cooling effect. The lighting is bright, highlighting the freshness and texture of the fish and ice.

Proven refrigeration experience



Sabharwal Food Industries (Pvt) Ltd., India

Sabharwal Food Industries (Pvt) Ltd near Delhi offers one stop shop for fresh frozen Cold Storage and processed food supported with state-of-the-art refrigeration system that utilizes VLT® Refrigeration Drives FC 103 to deliver optimum system performance and significantly improved energy savings”.

VLT® Refrigeration Drives FC 103 are applied on screw compressors and evaporator fans.



Helsinki Ice Stadium, Finland

Helsinki Ice Stadium opened 1966 and it is the oldest ice stadium in Helsinki. The spectator capacity is 8120. For the opening hockey game in 1967, there were almost 11000 spectators.

Besides hockey, the stadium hosts exhibitions, concerts and other sport events VLT® drives provide refrigeration.



Sainsbury, United Kingdom

Sainsbury's stores, amongst the leading supermarket chain in the United Kingdom, are committed to achieving their CO₂ milestone supported by Danfoss Drives, electronic controllers and related refrigeration controls.



VLT® drives are employed to keep correct and constant temperature in Maersk containers. Compact design, high efficiency, extreme reliability and dedicated refrigeration features are necessary for drives to operate cooling containers at sea and in trains and trucks all over the world. The quality of the cargo depends on it.

Maersk Containers, Denmark



Corman, Belgium

Located a stone's throw from the famous Gileppe dam, Belgium, the Corman public limited company specialises in a broad range of anhydrous dairy fats, concentrated butter and technically adapted butter to the needs of food and agriculture industries throughout the world.

Installing VLT® drives proved to be the best way to reduce operation costs and to cater effectively for the changing needs in the production lines.



Versacold Group, Canada

The Versacold Group operates approximately 24 large cold storage and distribution facilities across Canada and the Pacific Northwest, United States.

The warehouses are refrigerated by VLT® drives and provide storage for a variety of pharmaceutical and retail-wholesale grocery chains, contributing to improved quality of life in large metropolitan areas and small villages throughout North America.



Grupo Bimbo, S.A.B. de C.V., Mexico

Grupo Bimbo, S.A.B. de C.V. is the largest Mexican-owned baking company, with operations in the Americas, Asia and Europe.

The company has used and trusted Danfoss products for a long time. At the Hazpan plant in Mexico Bimbo applied a VLT® frequency converter to control an 200kW ammonium cooling compressor – the investment paid back in two years.

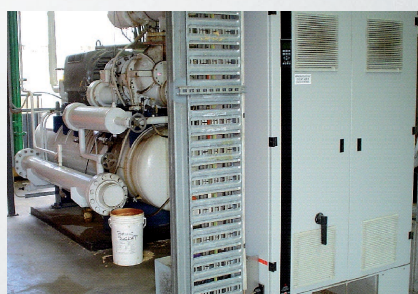

CUB Yatala brewery, Australia

Carlton & United Breweries' Yatala brewery in Queensland, North Australia, boasts better than world's best practice kWh-per-hectolitre figures after a major revamp of its brine chilling plant.

The chiller systems' VLT® drives allow the pumping and compressor capacities to be modulated according to plant demand for chilled brine.

Connection example

The numbers represent the terminals on the drive

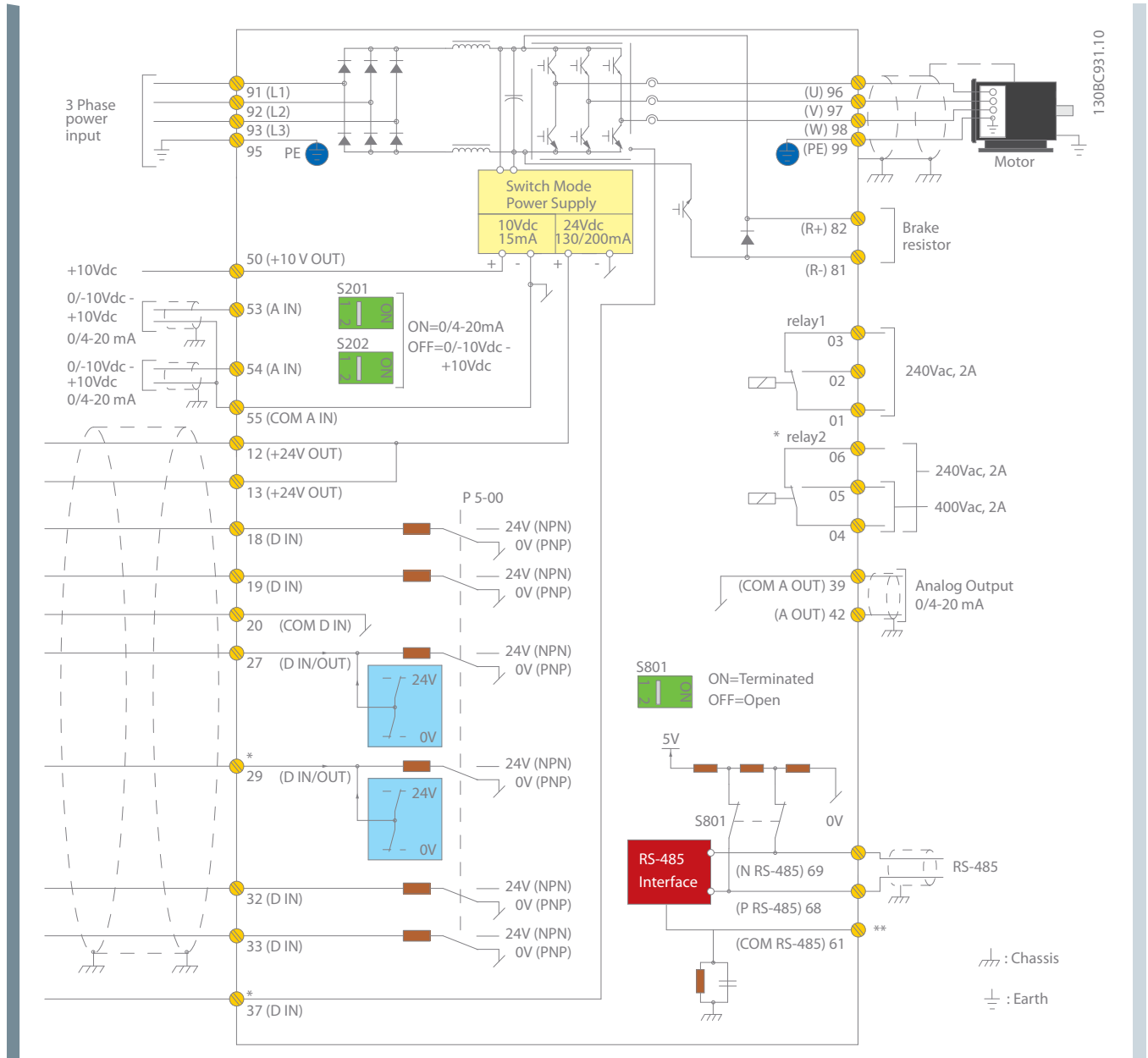

This diagram shows a typical installation of the VLT® Refrigeration Drive. Power is connected to the terminals 91 (L1), 92 (L2) and 93 (L3) and the motor is connected to 96 (U), 97 (V) and 98 (W).

Terminals 88 and 89 are used for load sharing between drives. Analog inputs can be connected to the 53 (V or mA), and for 54 (V or mA) terminals.

These inputs can be set up as either reference, feedback or thermistor inputs.

There are 6 digital inputs to be connected to terminals 18, 19, 27, 29, 32, and 33. Two digital input/output terminals (27 and 29) can be set up as digital outputs to show an actual status or warning or can be used as pulse reference signal.

The terminal 42 analogue output can show process values such as $0 - I_{max}$.

On the 68 (P+) and 69 (N-) terminals' RS 485 interface, the drive can be controlled and monitored via serial communication.

VLT® Refrigeration Drive technical data

Basic unit without extensions

Main supply (L1, L2, L3)	
Supply voltage	3 x 200-240 V AC1.1-45 kW 3 x 380-480 V AC1.1-450 kW 3 x 525-600 V AC1.1-90 kW 3 x 525-690 V AC75-630 kW
Supply frequency	50/60 Hz
Displacement power factor (cos φ) near unity	> 0.98
True power factor (λ)	≥ 0.9
Switching on input supply L1, L2, L3	1-2 times/min.
Harmonic disturbance	Meets EN 61000-3-12

Output data (U, V, W)	
Output voltage	0-100% of supply voltage
Output frequency (dependent on power size)	0-590 Hz
Switching on output	Unlimited
Ramp times	0.1-3600 sec.

Digital inputs	
Programmable digital inputs	6*
Changeable to digital output	2 (terminal 27, 29)
Logic	PNP or NPN
Voltage level	0-24 V DC
Maximum voltage on input	28 V DC
Input resistance, Ri	Approx. 4 kΩ
Scan interval	5 ms

* Two of the inputs can be used as digital outputs.

Analog inputs	
Analogue inputs	2
Modes	Voltage or current
Voltage level	0 to +10 V (scaleable)
Current level	0/4 to 20 mA (scaleable)
Accuracy of analog inputs	Max. error: 0.5% of full scale

Pulse inputs	
Programmable pulse inputs	2*
Voltage level	0-24 V DC (PNP positive logic)
Pulse input accuracy (0.1-1 kHz)	Max. error: 0.1% of full scale

* Two of the digital inputs can be used for pulse inputs.

Digital outputs	
Programmable digital/pulse outputs	2
Voltage level at digital/frequency output	0-24 V DC
Max. output current (sink or source)	40 mA
Maximum output frequency at frequency output	0-32 kHz
Accuracy on frequency output	Max. error: 0.1% of full scale

Analogue output	
Programmable analogue outputs	1
Current range at analogue output	0/4-20 mA
Max. load to common at analogue output (clamp 30)	500 Ω
Accuracy on analogue output	Max. error: 1% of full scale

Control card	
USB interface	1.1 (Full Speed)
USB plug	Type "B"
RS485 interface	Up to 115 kBaud
Max. load (10 V)	15 mA
Max. load (24 V)	200 mA

Relay output	
Programmable relay outputs	2
Max. terminal load (AC) on 1-3 (break), 1-2 (make), 4-6 (break) power card	240 V AC, 2 A
Max. terminal load (AC) on 4-5 (make) power card	400 V AC, 2 A
Min. terminal load on 1-3 (break), 1-2 (make), 4-6 (break), 4-5 (make) power card	24 V DC 10 mA, 24 V AC 20 mA

Surroundings/external	
Enclosure	IP: 00/20/21/54/55/66 UL Type: Chassis/1/12/4x Outdoor
Vibration test	1.0 g (D, E & F-enclosures: 0.7 g)
Max. relative humidity	5-95% (IEC 721-3-3; Class 3K3 (non-condensing) during operation)
Ambient temperature	Up to 55 °C (50 °C without derating; D-enclosure 45 °C)
Galvanic isolation of all	I/O supplies according to PELV
Aggressive environment	Designed for coated/uncoated 3C3/3C2 (IEC 60721-3-3)

Fieldbus communication	
Standard built-in: FC Protocol Modbus RTU Metasys N2 FC MC	Optional: VLT® PROFIBUS DP V1 MCA 101 VLT® PROFINET MCA 120 VLT® AK-LonWorks MCA 107

Ambient temperature	
– Electronic thermal motor protection against overload	
– Up to 55 °C (50 °C without derating; D-enclosure 45 °C)	
– Temperature monitoring of the heatsink ensures that the frequency converter trips in case of overtemperature	
– The frequency converter is protected against short-circuits on motor terminals U, V, W	
– The frequency converter is protected against earth faults on motor terminals U, V, W	
– Protection against mains phase loss	

Application options	
Extend the functionality of the drive with integrated options:	
• VLT® General Purpose I/O MCB 101	
• VLT® Extended Relay Card MCB 113	
• VLT® 24 V External Supply MCB 107	

Relay and analogue I/O option	
• VLT® Relay Card MCB 105	
• VLT® Analog I/O MCB109	

Power options	
Choose from a wide range of external power options for use with our drive in critical networks or applications:	
• VLT® Advanced Active Filter	
• VLT® Advanced Harmonic Filter	
• VLT® dU/dt filter	
• VLT® Sine wave filter (LC filter)	

High power options	
See the VLT® High Power Drive Selection Guide for a complete list.	

PC software tools	
• VLT® Motion Control Tool MCT 10	
• VLT® Energy Box	
• VLT® Motion Control Tool MCT 31	

Enclosure overview

3 phases

VLT® Refrigeration Drive			T2 200 – 240 V				T4 380 – 480 V					T6 525 – 600 V					T7 525 – 690 V						
FC 103	kW	HP	IP20	IP21	IP55	IP66	IP00	IP20	IP21	IP54	IP55	IP66	IP20	IP21	IP54	IP55	IP66	IP00	IP20	IP21	IP54	IP55	
P1K1	1.1	1.5																					
P1K5	1.5	2	A2	A2	A4/A5	A4/A5		A2	A3		A4/A5	A4/A5	A3	A3		A5	A5		A3				A5
P2K2	2.2	3																					
P3K0	3.0	4	A3	A3	A5	A5																	
P3K7	3.7	5																					
P4K0	4.0	5.5						A2	A2		A4/A5												
P5K5	5.5	7.5						A2	A2		A4/A5												
P7K5	7.5	10	B3	B1	B1	B1		A3	A3		A5	A5	A3	A3		A5	A5		A3				A5
P11K	11	15																					
P15K	15	20	B4	B2	B2	B2		B3	B1		B1	B1	B3	B1		B1	B1		B4				B2
P18K	18.5	25																					
P22K	22	30																					
P30K	30	40	C3	C1	C1	C1		B4	B2		B2	B2	B4	B2		B2	B2		B4	B2			B2
P37K	37	50																					
P45K	45	60	C4	C2	C2	C2																	
P55K	55	75						C3	C1		C1	C1	C3	C1		C1	C1		C3	C2			C2
P75K	75	100																					
P90K	90	125						C4	C2		C2	C2	C4	C2		C2	C2						
N75K	75	100																					
N90K	90	125																					
N110	110	150						D3h	D1h D5h D6h	D1h D5h D6h									D3h	D1h D5h D6h	D1h D5h D6h		
N132	132	200																					
N160	160	250																					
N200	200	300																					
N250	250	350						D4h	D2h D7h D8h	D2h D7h D8h									D4h	D2h D7h D8h	D2h D7h D8h		
N315	315	450																					
N400	400	550																					
P315	315	315																					
P355	355	500																					
P400	400	550					E2		E1	E1													
P450	450	600																					
P500	500	650																					
P560	560	750																E2		E1	E1		
P630	630	900																					

- IP00/Chassis
- IP20/Chassis
- IP21/Type 1
- IP21 with upgrade kit – available in US only
- IP54/Type 12
- IP55/Type 12
- IP66/NEMA 4X

Electrical data

VLT® Refrigeration Drive 3 x 200-240 V AC

Enclosure	IP20/Chassis ⁴⁾ , IP21/Type 1		A2			A3	
	IP55/Type 12, IP66/NEMA 4X		A4 + A5			A5	
			P1K1	P1K5	P2K2	P3K0	P3K7
Typical shaft output	[kW]		1.1	1.5	2.2	3.0	3.7
Typical shaft output 208 V	[HP]		1.5	2	3	4	5
Output current							
Continuous (3 x 200-240 V)	[A]		6.6	7.5	10.6	12.5	16.7
Intermittent (3 x 200-240 V)	[A]		7.3	8.3	11.7	13.8	18.4
Output power							
Continuous at 208 V AC	[kVA]		2.38	2.70	3.82	4.50	6.00
Maximum input current							
Continuous (3 x 200-240 V)	[A]		5.9	6.8	9.5	11.3	15.0
Intermittent (3 x 200-240 V)	[A]		6.5	7.5	10.5	12.4	16.5
Max. pre-fuses	[A]		10	15	20	25	32
Additional specifications							
Estimated power loss at rated max. load ²⁾	[W]		63	82	116	155	185
Efficiency ³⁾			0.96				
Max. cable cross-section Mains, motor, brake and load sharing ¹⁾	[mm ²] ([AWG])		4, 4, 4 (12, 12, 12) (min. 0.2 (24))				
Max. cable cross-section Disconnect ¹⁾	[mm ²] ([AWG])		6, 4, 4 (10, 12, 12)				
Weight							
IP20/Chassis	[kg]		4.9			6.6	
IP21/Type 1	[kg]		5.5			7.5	
IP55/Type 12, IP66/NEMA 4X	[kg]		9.7			13.5	

- ¹⁾ The 3 values for the max. cable cross-section indicate single core, flexible wire, and flexible wire with sleeve, respectively.
- ²⁾ The typical power loss is at normal load conditions and expected to be within ± 15% (tolerance relates to variations in voltage and cable conditions).
Values are based on a typical motor efficiency. Lower efficiency motors will also add to the power loss in the frequency converter and vice versa.
If the switching frequency is raised from nominal, the power losses may rise significantly. LCP and typical control card power consumptions are included. Further options and customer load may add up to 30 W to the losses. (Though typically only 4 W extra for a fully loaded control card or options for slot A or slot B, each).
- ³⁾ Measured using 5 m screened motor cables at rated load and rated frequency.
- ⁴⁾ Enclosure types A2 + A3 can be converted to IP21 using a conversion kit. See also Mechanical mounting and IP21/Type 1 enclosure kit in the Design Guide.
- ⁵⁾ Enclosure types B3 + B4 and C3 + C4 can be converted to IP21 using a conversion kit. See also Mechanical mounting and IP21/Type 1 enclosure kit in the Design Guide.

VLT® Refrigeration Drive 3 x 200-240 V AC

Enclosure	IP20/Chassis ⁵⁾		B3			B4		C3		C4		
	IP21/Type 1 IP55/Type 12 IP66/NEMA 4X		B1			B2	C1		C2			
			P5K5	P7K5	P11K	P15K	P18K	P22K	P30K	P37K	P45K	
Typical shaft output	[kW]		5.5	7.5	11	15	18.5	22	30	37	45	
Typical shaft output 208 V	[HP]		7.5	10	15	20	25	30	40	50	60	
Output current												
Continuous (3 x 200-240 V)	[A]		24.2	30.8	46.2	59.4	74.8	88.0	115	143	170	
Intermittent (3 x 200-240 V)	[A]		26.6	33.9	50.8	65.3	82.3	96.8	127	157	187	
Output power												
Continuous at 208 V AC	[kVA]		8.7	11.1	16.6	21.4	26.9	31.7	41.4	51.5	61.2	
Maximum input current												
Continuous (3 x 200-240 V)	[A]		22.0	28.0	42.0	54.0	68.0	80.0	104	130	154	
Intermittent (3 x 200-240 V)	[A]		24.2	30.8	46.2	59.4	74.8	88.0	114	143	169	
Max. pre-fuses	[A]		50		63	80	125		150	200	250	
Additional specifications												
Estimated power loss at rated max. load ²⁾	[W]		310		514	602	737	845	1140	1353	1636	
Efficiency ³⁾			0.96					0.97				
IP20 max. cable cross-section Mains, motor, brake ¹⁾	[mm ²] ([AWG])		10, 10, - (8, 8, -)			35,25,25 (2,4,4)		35 (2)	50 (1)		150 (300 mcm)	
IP21 max. cable cross-section Mains, brake ¹⁾	[mm ²] ([AWG])		16, 10, 16 (6, 8, 6)			35,25,25 (2,4,4)		18, 22, 30 kW = 50(1) 37, 45 kW = 150 (MCM300)				
IP21 max. cable cross-section Motor ¹⁾	[mm ²] ([AWG])		10, 10, - (8, 8, -)			35, 25, 25 (2, 4, 4)		18, 22, 30 kW = 50(1) 37, 45 kW = 150 (MCM300)			18, 22, 30 kW = 50(1) 37, 45 kW = 150 (MCM300)	
IP21, IP55, IP66 max. cable cross-section Mains and motor	[mm ²] ([AWG])		16,10,10 (6,8,8)			16, 10, 10 (6, 8, 8)		50 (1)		150 (300 mcm)		
IP21, IP55, IP66 max. cable cross-section Brake	[mm ²] ([AWG])		16, 10, 10 (6, 8, 8)			16, 10, 10 (6, 8, 8)		50 (1)		95 (3/0)		
Max. cable cross-section Disconnect ¹⁾	[mm ²] ([AWG])		16, 10, 10 (6, 8, 8)			16, 10, 10 (6, 8, 8)		50, 35, 35 (1, 2, 2)		95, 70, 70 (3/0, 2/0, 2/0)		185, 150, 120 (350 mcm, 300 mcm, 4/0)
Weight												
IP20/Chassis	[kg]		12			23.5		35		50		
IP21/Type 1, IP55/Type 12, IP66/NEMA 4X	[kg]		23			27		45		65		

VLT® Refrigeration Drive 3 x 380-480 V AC

Enclosure	IP20/Chassis ¹⁾		A2					A3	
	IP55/Type 12, IP66/NEMA 4X		A4 + A5					A5	
			P1K1	P1K5	P2K2	P3K0	P4K0	P5K5	P7K5
Typical shaft output	[kW]		1.1	1.5	2.2	3.0	4.0	5.5	7.5
Typical shaft output 460 V	[HP]		1.5	2	2.9	4.0	5.3	7.5	10
Output current									
Continuous (3 x 380-440 V)	[A]		3.0	4.1	5.6	7.2	10	13	16
Intermittent (3 x 380-440 V)	[A]		3.3	4.5	6.2	7.9	11.0	14.3	17.6
Continuous (3 x 441-480 V)	[A]		2.7	3.4	4.8	6.3	8.2	11	14.5
Intermittent (3 x 441-480 V)	[A]		3.0	3.7	5.3	6.9	9.0	12.1	16.0
Output power									
Continuous at 400 V AC	[kVA]		2.1	2.8	3.9	5.0	6.9	9.0	11.0
Continuous at 460 V AC	[kVA]		2.4	2.7	3.8	5.0	6.5	8.8	11.6
Maximum input current									
Continuous (3 x 380-440 V)	[A]		2.7	3.7	5.0	6.5	9.0	11.7	14.4
Intermittent (3 x 380-440 V)	[A]		3.0	4.1	5.5	7.2	9.9	12.9	15.8
Continuous (3 x 441-480 V)	[A]		2.7	3.1	4.3	5.7	7.4	9.9	13.0
Intermittent (3 x 441-480 V)	[A]		3.0	3.4	4.7	6.3	8.1	10.9	14.3
Max. pre-fuses	[A]		10		20			30	
Additional specifications									
Estimated power loss at rated max. load ²⁾	[W]		58	62	88	116	124	187	255
Efficiency ³⁾			0.96		0.97				
IP20, IP21 max. cable cross-section Mains, motor, brake and load sharing ¹⁾	[mm ²] ([AWG])		4, 4, 4 (12, 12, 12) (min. 0.2 (24))						
IP55, IP66 max. cable cross-section Mains, motor, brake and load sharing ¹⁾	[mm ²] ([AWG])		4, 4, 4 (12, 12, 12)						
Max. cable cross-section Disconnect ¹⁾	[mm ²] ([AWG])		6, 4, 4 (10, 12, 12)						
Weight									
IP20/Chassis	[kg]		4.8		4.9			6.6	
IP55/Type 12, IP66/NEMA 4X	[kg]		13.5					14.2	

¹⁾ The 3 values for the max. cable cross-section indicate single core, flexible wire, and flexible wire with sleeve, respectively.

²⁾ The typical power loss is at normal load conditions and expected to be within $\pm 15\%$ (tolerance relates to variations in voltage and cable conditions). Values are based on a typical motor efficiency. Lower efficiency motors will also add to the power loss in the frequency converter and vice versa.

If the switching frequency is raised from nominal, the power losses may rise significantly. LCP and typical control card power consumptions are included. Further options and customer load may add up to 30 W to the losses. (Though typically only 4 W extra for a fully loaded control card or options for slot A or slot B, each).

³⁾ Although measurements are made with state of the art equipment, some measurement inaccuracy must be allowed for ($\pm 5\%$).

⁴⁾ Measured using 5 m screened motor cables at rated load and rated frequency.

⁵⁾ Enclosure types A2 + A3 can be converted to IP21 using a conversion kit. See also Mechanical mounting and IP21/Type 1 enclosure kit in the Design Guide.

⁶⁾ Enclosure types B3 + B4 and C3 + C4 can be converted to IP21 using a conversion kit. See also Mechanical mounting and IP21/Type 1 enclosure kit in the Design Guide.

VLT® Refrigeration Drive 3 x 380-480 V AC

Enclosure	IP20/Chassis ⁵⁾	B3			B4		
		IP21/Type 1, IP55/Type 12 IP66/NEMA 4X	B1			B2	
			P11K	P15K	P18K	P22K	P30K
Typical shaft output	[kW]	11	15	18,5	22,0	30	
Typical shaft output 460 V	[HP]	15	20	25	30	40	
Output current							
Continuous (3 x 380-440 V)	[A]	24	32	37,5	44	61	
Intermittent (3 x 380-440 V)	[A]	26,4	35,2	41,3	48,4	67,1	
Continuous (3 x 441-480 V)	[A]	21	27	34	40	52	
Intermittent (3 x 441-480 V)	[A]	23,1	29,7	37,4	44	61,6	
Output power							
Continuous at 400 V AC	[kVA]	16,6	22,2	26	30,5	42,3	
Continuous at 460 V AC	[kVA]	16,7	21,5	27,1	31,9	41,4	
Maximum input current							
Continuous (3 x 380-440 V)	[A]	22	29	34	40	55	
Intermittent (3 x 380-440 V)	[A]	24,2	31,9	37,4	44	60,5	
Continuous (3 x 441-480 V)	[A]	19	25	31	36	47	
Intermittent (3 x 441-480 V)	[A]	20,9	27,5	34,1	39,6	51,7	
Max. pre-fuses	[A]	40		50	60	80	
Additional specifications							
Estimated power loss at rated max. load ²⁾	[W]	392	392	465	525	739	
Efficiency ³⁾		0,98					
IP20 max. cable cross-section Mains, motor, brake ¹⁾	[mm ²] ([AWG])	10, 10,- (8, 8,-)			35, -, - (2, -, -)		
IP21, IP55, IP66 max. cable cross-section Motor ¹⁾	[mm ²] ([AWG])	10, 10,- (8, 8,-)			35, 25, 25 (2, 4, 4)		
IP21, IP55, IP66 max. cable cross-section Mains, brake ¹⁾	[mm ²] ([AWG])	16, 10, 16 (6, 8, 6)			35, -, - (2, -, -)		
Max. cable cross-section Disconnect ¹⁾	[mm ²] ([AWG])	16, 10, 10 (6, 8, 8)					
Weight							
IP20/Chassis	[kg]	12			35		
IP21/Type 1, IP55/Type 12, IP66/NEMA 4X	[kg]	23	23		27		

VLT® Refrigeration Drive 3 x 380-480 V AC

Enclosure	IP20/Chassis ¹⁾		B4		C3		C4	
	IP21/Type 1, IP55/Type 12 IP66/NEMA 4X		C1		C2			
			P37K	P45K	P55K	P75K	P90K	
Typical shaft output	[kW]	37	45	55	75	90		
Typical shaft output 460 V	[HP]	50	60	75	100	125		
Output current								
Continuous (3 x 380-440 V)	[A]	73	90	106	147	177		
Intermittent (3 x 380-440 V)	[A]	80.3	99	117	162	195		
Continuous (3 x 441-480 V)	[A]	65	80	105	130	160		
Intermittent (3 x 441-480 V)	[A]	71.5	88	116	143	176		
Output power								
Continuous at 400 V AC	[kVA]	50.6	62.4	73.4	102	123		
Continuous at 460 V AC	[kVA]	51.8	63.7	83.7	103.6	128		
Maximum input current								
Continuous (3 x 380-440 V)	[A]	66	82	96	133	161		
Intermittent (3 x 380-440 V)	[A]	72.6	90.2	106	146	177		
Continuous (3 x 441-480 V)	[A]	59	73	95	118	145		
Intermittent (3 x 441-480 V)	[A]	64.9	80.3	105	130	160		
Max. pre-fuses	[A]	100	125	160	250			
Additional specifications								
Estimated power loss at rated max. load ²⁾	[W]	739	843	1083	1384	1474		
Efficiency ³⁾				0.98		0.99		
IP20 max. cable cross-section Mains and motor	[mm ²] ([AWG])	35 (2)	50 (1)		150 (300 mcm)			
IP20 max. cable cross-section Brake and load sharing	[mm ²] ([AWG])	35 (2)	50 (1)		95 (4/0)			
IP21, IP55, IP66 max. cable cross-section Motor and motor	[mm ²] ([AWG])		50 (1)		150 (300 mcm)			
IP21, IP55, IP66 max. cable cross-section Brake and load sharing	[mm ²] ([AWG])		50 (1)		95 (3/0)			
Max. cable cross-section Mains disconnect ⁴⁾	[mm ²] ([AWG])		50, 35, 35 (1, 2, 2)		95, 70, 70 (3/0, 2/0, 2/0)	185, 150, 120 (350 mcm, 300 mcm, 4/0)		
Weight								
IP20/Chassis	[kg]	23.5		35		50		
IP21/Type 1, IP55/Type 12, IP66/NEMA 4X	[kg]		45			65		

¹⁾ The 3 values for the max. cable cross-section indicate single core, flexible wire, and flexible wire with sleeve, respectively.

²⁾ The typical power loss is at normal load conditions and expected to be within $\pm 15\%$ (tolerance relates to variations in voltage and cable conditions).

Values are based on a typical motor efficiency. Lower efficiency motors will also add to the power loss in the frequency converter and vice versa.

If the switching frequency is raised from nominal, the power losses may rise significantly.

LCP and typical control card power consumptions are included. Further options and customer load may add up to 30 W to the losses.

(Though typically only 4 W extra for a fully loaded control card or options for slot A or slot B, each).

Although measurements are made with state of the art equipment, some measurement inaccuracy must be allowed for ($\pm 5\%$).

³⁾ Measured using 5 m screened motor cables at rated load and rated frequency.

⁴⁾ Enclosure types A2 + A3 can be converted to IP21 using a conversion kit. See also Mechanical mounting and IP21/Type 1 enclosure kit in the Design Guide.

⁵⁾ Enclosure types B3 + B4 and C3 + C4 can be converted to IP21 using a conversion kit. See also Mechanical mounting and IP21/Type 1 enclosure kit in the Design Guide.

VLT® Refrigeration Drive 3 x 380-480 V AC

Enclosure	IP20		D3h			D4h			E2		
	IP21, IP54		D1h + D5h + D6h			D2h + D7h + D8h			E1		
			N110	N132	N160	N200	N250	N315	P355	P400	P450
Typical shaft output 400 V	[kW]		110	132	160	200	250	315	355	400	450
Typical shaft output 460 V	[HP]		150	200	250	300	350	450	500	600	600
Output current											
Continuous (at 400 V)	[A]		212	260	315	395	480	588	658	745	800
Intermittent (60 s overload) (at 400 V)	[A]		233	286	347	435	528	647	724	820	880
Continuous (at 460/480 V)	[A]		190	240	302	361	443	535	590	678	730
Intermittent (60 s overload) (at 460/480 V)	[A]		209	264	332	397	487	588	649	746	803
Output power											
Continuous (at 400 V)	[kVA]		147	180	218	274	333	407	456	516	554
Continuous (at 460 V)	[kVA]		151	191	241	288	353	426	470	540	582
Maximum input current											
Continuous (at 400 V)	[A]		204	251	304	381	463	567	647	733	787
Continuous (at 460/480 V)	[A]		183	231	291	348	427	516	580	667	718
Max. cable cross-section Mains, motor, brake and load sharing ¹⁾²⁾	[mm ²] ([AWG])		2 x 95 (2 x 3/0)			2 x 185 (2 x 350 mcm)			4 x 240 (4 x 500 mcm)		
Max. external mains fuses ³⁾	[A]		315	350	400	550	630	800	900		
Additional specifications											
Estimated power loss at 400 V ⁴⁾⁵⁾	[W]		2555	2949	3764	4109	5129	6663	7532	8677	9473
Estimated power loss at 460 V ⁴⁾⁵⁾	[W]		2257	2719	3612	3561	4558	5703	6724	7819	8527
Efficiency ⁵⁾			0.98								
Output frequency			0-590 Hz								
Heatsink overtemperature trip			110 °C								
Control card ambient trip			75 °C						85 °C		
Weight											
IP20 (IP21, IP54)	[kg] (lbs)		[62] (135) (D1h + D3h) 166 (D5h), 129 (D6h)			[125] (175) (D2h + D4h) 200 (D7h), 225 (D8h)			[234] (515) [270] (594)	[236] (519) (272)	[277] (609) [313] (689)

Technical specifications, D-frames 380-480 V, mains supply 3 x 380-480 V AC and E-frames 380-480 V, mains supply 3 x 380-480 V AC

¹⁾ American Wire Gauge.

²⁾ Wiring terminals on N132, N160, and N315 frequency converters cannot receive cables one size larger.

³⁾ For fuse ratings, check reference.

⁴⁾ Typical power loss is at normal conditions and expected to be within ±15% (tolerance relates to variety in voltage and cable conditions).

⁵⁾ These values are based on a typical motor efficiency (IE/IE3 border line). Lower efficiency motors add to the power loss in the frequency converter. If the switching frequency is raised from nominal, the power losses rise significantly. LCP and typical control card power consumptions are included. Options and customer load can add up to 30 W to the losses, though usually a fully loaded control card and options for slots A and B each add only 4 W.

⁶⁾ Measured using 5 m screened motor cables at rated load and rated frequency.

⁷⁾ Additional frame size weights are as follows: D5h – 166 (255) / D6h – 129 (285) / D7h – 200 (440) / D8h – 225 (496). Weights are in kg (lbs).

VLT® Refrigeration Drive 3 x 525-600 V AC

Enclosure	IP20/Chassis, IP21/Type 1		A3			A3				
	IP55/Type 12		A5							
			P1K1	P1K5	P2K2	P3K0	P4K0	P5K5	P7K5	
Typical shaft output	[kW]		1.1	1.5	2.2	3.0	4.0	5.5	7.5	
Typical shaft output	[HP]		1.5	2	3	4	5	7.5	10	
Output current										
Continuous (3 x 525-550 V)	[A]		2.6	2.9	4.1	5.2	6.4	9.5	11.5	
Intermittent (3 x 525-550 V)	[A]		2.9	3.2	4.5	5.7	7.0	10.5	12.7	
Continuous (3 x 551-600 V)	[A]		2.4	2.7	3.9	4.9	6.1	9.0	11.0	
Intermittent (3 x 551-600 V)	[A]		2.6	3.0	4.3	5.4	6.7	9.9	12.1	
Output power										
Continuous at 550 V AC	[kVA]		2.5	2.8	3.9	5.0	6.1	9.0	11.0	
Continuous at 575 V AC	[kVA]		2.4	2.7	3.9	4.9	6.1	9.0	11.0	
Maximum input current										
Continuous (3 x 525-600 V)	[A]		2.4	2.7	4.1	5.2	5.8	8.6	10.4	
Intermittent (3 x 525-600 V)	[A]		2.6	3.0	4.5	5.7	6.4	9.5	11.4	
Max. pre-fuses	[A]		5	10		16	20	25	30	
Additional specifications										
Estimated power loss at rated max. load ³⁾	[W]		50	65	92	122	145	195	261	
Efficiency ⁴⁾			0.97							
Max. cable cross-section Mains, motor, brake ²⁾	[mm ²] ([AWG])		4, 4, 4 (12, 12, 12) (min. 0.2 (24))							
Max. cable cross-section Disconnect ²⁾	[mm ²] ([AWG])		6, 4, 4 (10, 12, 12)							
Weight										
IP20/Chassis	[kg]		6.5				6.6			
IP21/Type 1, IP55/Type 12	[kg]		13.5				14.2			

VLT® Refrigeration Drive 3 x 525-600 V AC

Enclosure	IP20/Chassis		B3			B4			
	IP21/Type 1, IP55/Type 12 IP66/NEMA 4X		B1			B2		C1	
			P11K	P15K	P18K	P22K	P30K	P37K	
Typical shaft output	[kW]		11	15	18.5	22	30	37	
Typical shaft output	[HP]		15	20	25	30	40	50	
Output current									
Continuous (3 x 525-550 V)	[A]		19	23	28	36	43	54	
Intermittent (3 x 525-550 V)	[A]		21	25	31	40	47	59	
Continuous (3 x 551-600 V)	[A]		18	22	27	34	41	52	
Intermittent (3 x 551-600 V)	[A]		20	24	30	37	45	57	
Output power									
Continuous at 550 V AC	[kVA]		18.1	21.9	26.7	34.3	41.0	51.4	
Continuous at 575 V AC	[kVA]		17.9	21.9	26.9	33.9	40.8	51.8	
Maximum input current									
Continuous at 550 V	[A]		17.2	20.9	25.4	32.7	39	49	
Intermittent at 550 V	[A]		19	23	28	36	43	54	
Continuous at 575 V	[A]		16	20	24	31	37	47	
Intermittent at 575 V	[A]		17.6	22	27	34	41	52	
Max. pre-fuses	[A]		35		45	50	60	80	
Additional specifications									
Estimated power loss at rated max. load ³⁾	[W]		300	300	370	440	600	740	
Efficiency ⁴⁾			0.98						
IP20 max. cable cross-section Mains, motor, brake ²⁾	[mm ²] ([AWG])		10, 10,- (8, 8,-)			35, -,- (2, -,-)			
IP21, IP55, IP66 max. cable cross-section Mains, brake ²⁾	[mm ²] ([AWG])		16, 10, 10 (6, 8, 8)			35, -,- (2, -,-)		50, -,- (1, -,-)	
IP21, IP55, IP66 max. cable cross-section Motor ²⁾	[mm ²] ([AWG])		10, 10,- (8, 8,-)			35, 25, 25 (2, 4, 4)		50, -,- (1, -,-)	
Max. cable cross-section Disconnect ²⁾	[mm ²] ([AWG])		16, 10, 10 (6, 8, 8)			50, 35, 35 (1, 2, 2)			
Weight									
IP20/Chassis	[kg]		12			23.5			
IP21/Type 1, IP55/Type 12, IP66/NEMA 4X	[kg]		23			27			

VLT® Refrigeration Drive 3 x 525-600 V AC

Enclosure	IP20/Chassis		C3		C4	
	IP21/Type 1, IP55/Type 12 IP66/NEMA 4X		C1		C2	
			P45K	P55K	P75K	P90K
Typical shaft output	[kW]		45	55	75	90
Typical shaft output	[HP]		60	75	100	125
Output current						
Continuous (3 x 525-550 V)	[A]		65	87	105	137
Intermittent (3 x 525-550 V)	[A]		72	96	116	151
Continuous (3 x 551-600 V)	[A]		62	83	100	131
Intermittent (3 x 551-600 V)	[A]		68	91	110	144
Output power						
Continuous at 550 V AC	[kVA]		61.9	82.9	100	130.5
Continuous at 575 V AC	[kVA]		61.7	82.7	99.6	130.5
Maximum input current						
Continuous at 550 V	[A]		59	78.9	95.3	124.3
Intermittent at 550 V	[A]		65	87	105	137
Continuous at 575 V	[A]		56	75	91	119
Intermittent at 575 V	[A]		62	83	100	131
Max. pre-fuses	[A]		100	125	150	175
Additional specifications						
Estimated power loss at rated max. load ³⁾	[W]		900	1100	1500	1800
Efficiency ⁴⁾			0.98			
IP20 max. cable cross-section Mains and motor	[mm ²] ([AWG])		50 (1)		150 (300 mcm)	
IP20 max. cable cross-section Brake	[mm ²] ([AWG])		50 (1)		95 (4/0)	
IP21, IP55, IP66 max. cable cross-section Mains and motor	[mm ²] ([AWG])		50 (1)		150 (300 mcm)	
IP21, IP55, IP66 max. cable cross-section Brake	[mm ²] ([AWG])		50 (1)		95 (4/0)	
Max. cable cross-section Disconnect ²⁾	[mm ²] ([AWG])		50, 35, 35 (1, 2, 2)		95, 70, 70 (3/0, 2/0, 2/0)	185, 150, 120 (350 mcm, 300 mcm, 4/0)
Weight						
IP20/Chassis	[kg]		35		50	
IP21/Type 1, IP55/Type 12, IP66/NEMA 4X	[kg]		45		65	

VLT® Refrigeration Drive 3 x 525-690 V AC

Enclosure	IP20		D3h					D4h			
	IP21, IP54		D1h, D5h, D6h					D2h, D7h, D8h			
			N75K	N90K	N110	N132	N160	N200	N250	N315	N400
Typical shaft output 550 V	[kW]		55	75	90	110	132	160	200	250	315
Typical shaft output 575 V	[HP]		75	100	125	150	200	250	300	350	400
Typical shaft output 690 V	[kW]		75	90	110	132	160	200	250	315	400
Output current											
Continuous (at 550 V)	[A]		90	113	137	162	201	253	303	360	418
Intermittent (60 s overload) (at 550 V)	[A]		99	124	151	178	221	278	333	396	460
Continuous (at 575/690 V)	[A]		86	108	131	155	192	242	290	344	400
Intermittent (60 s overload) (at 575/690 V)	[A]		95	119	144	171	211	266	319	378	440
Output power											
Continuous (at 550 V)	[kVA]		86	108	131	154	191	241	289	343	398
Continuous (at 575 V)	[kVA]		86	108	130	154	191	241	289	343	398
Continuous (at 690 V)	[kVA]		103	129	157	185	229	289	347	411	478
Maximum input current											
Continuous (at 550 V)	[A]		89	110	130	158	198	245	299	355	408
Continuous (at 575 V)	[A]		85	106	124	151	189	234	286	339	390
Continuous (at 690 V)	[A]		87	109	128	155	197	240	296	352	400
Max. cable cross-section Mains, motor, brake and load sharing ¹⁾	[mm ²] ([AWG])		2 x 95 (2 x 3/0)					2 x 185 (2 x 350)			
Max. external mains fuses ²⁾	[A]		160	315	315	315	315	550			
Additional specifications											
Estimated power loss at 575 V ^{3) 4)}	[W]		1162	1428	1739	2099	2646	3071	3719	4460	5023
Estimated power loss at 690 V ^{3) 4)}	[W]		1204	1477	1796	2165	2738	3172	3848	4610	5150
Efficiency ⁴⁾			0.98								
Output frequency			0-590 Hz								0-525 Hz
Heatsink overtemperature trip			110 °C								
Control card ambient trip			75 °C						80 °C		
Weight											
IP20, IP21, IP54	[kg] (lbs)		[62] (135) (D1h + D3h) 166 (D5h), 129 (D6h)					[125] (275) (D2h + D4h) 200 (D7h), 225 (D8h)			

Constant-torque applications

Low starting torque (110% overload)

Scroll compressor	[0.6 to 0.9 nominal]
Screw compressor	[0.4 to 0.7 nominal]
Piston compressor	[0.6 to 0.9 nominal]

Normal starting torque [overtorque]

Scroll compressor	[1.2 to 1.6 nominal]
Screw compressor	[1.0 to 1.6 nominal]
2-cylinder compressor	[up to 1.6 nominal]
4-cylinder compressor	[up to 1.2 nominal]
6-cylinder compressor	[up to 1.2 nominal]

High starting torque [overtorque]

2-cylinder compressor	[up to 2.2 nominal]
4-cylinder compressor	[up to 1.8 nominal]
6-cylinder compressor	[up to 1.6 nominal]

Technical specifications, D-frames 525-690 V, mains supply 3 x 525-690 V AC

¹⁾ American Wire Gauge.

²⁾ For fuse ratings, check reference.

³⁾ Typical power loss is at normal conditions and expected to be within ±15% (tolerance relates to variety in voltage and cable conditions).

⁴⁾ These values are based on a typical motor efficiency (IE/IE3 border line). Lower efficiency motors add to the power loss in the frequency converter. If the switching frequency is raised from nominal, the power losses rise significantly. LCP and typical control card power consumptions are included. Options and customer load can add up to 30 W to the losses, though usually a fully loaded control card and options for slots A and B each add only 4 W.

⁴⁾ Measured using 5 m screened motor cables at rated load and rated frequency.

Technical specifications for VLT® Low Harmonic Drive, VLT® Advanced Active Filter AAF006 and VLT® 12-pulse
Please see the VLT® High Power Drive Selection Guide.

VLT® Refrigeration Drive 3 x 525-690 V AC

Enclosure		IP00		E2		
		IP21, IP54		E1		
			P450	P500	P560	P630
Typical shaft output 550 V		[kW]	355	400	450	500
Typical shaft output 575 V		[HP]	450	500	600	650
Typical shaft output 690 V		[kW]	450	500	560	630
Output current						
Continuous (at 550 V)		[A]	470	523	596	630
Intermittent (60 s overload) (at 550 V)		[A]	517	575	656	693
Continuous (at 575/690 V)		[A]	450	500	570	630
Intermittent (60 s overload) (at 575/690 V)		[A]	495	550	627	693
Output power						
Continuous (at 550 V)		[kVA]	448	498	568	600
Continuous (at 575 V)		[kVA]	448	498	568	627
Continuous (at 690 V)		[kVA]	538	598	681	753
Maximum input current						
Continuous (at 550 V)		[A]	453	504	574	607
Continuous (at 575 V)		[A]	434	482	549	607
Continuous (at 690 V)		[A]	434	482	549	607
Max. cable size Brake ¹⁾		[mm ²] ([AWG])	2 x 185 (4 x 350 MCM)			4x 240 (4x500MCM)
Max. external mains fuses ²⁾		[A]	700		900	
Additional specifications						
Estimated power loss at 600 V ^{3) 4)}		[W]	5323	6010	7395	8209
Estimated power loss at 690 V ^{3) 4)}		[W]	5529	6239	7653	8495
Efficiency ⁴⁾			0.98			
Output frequency			0-525 Hz			
Heatsink overtemperature trip			110 °C	95 °C		110 °C
Power card ambient trip			85 °C			85 °C
Weight						
IP00		[kg]	221		236	277
IP21, IP54		[kg]	263		272	313

Technical specifications, E-frames 525-690 V, mains supply 3 x 525-690 V AC

¹⁾ American Wire Gauge.

²⁾ For fuse ratings, check reference.

³⁾ Typical power loss is at normal conditions and expected to be within ±15% (tolerance relates to variety in voltage and cable conditions).

⁴⁾ These values are based on a typical motor efficiency (IE/IE3 border line). Lower efficiency motors add to the power loss in the frequency converter. If the switching frequency is raised from nominal, the power losses rise significantly. LCP and typical control card power consumptions are included. Options and customer load can add up to 30 W to the losses, though usually a fully loaded control card and options for slots A and B each add only 4 W.

⁴⁾ Measured using 5 m screened motor cables at rated load and rated frequency.

Technical specifications for VLT® Low Harmonic Drive, VLT® Advanced Active Filter AAF006 and VLT® 12-pulse

Please see the VLT® High Power Drive Selection Guide.

Dimensions and air flow

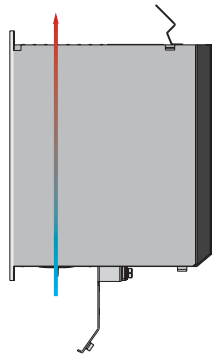

A2 IP20

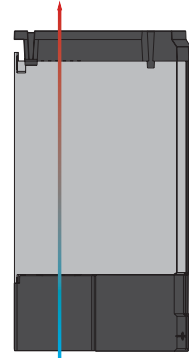
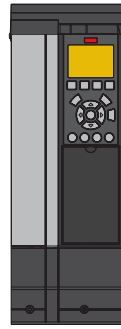

A3 with IP21/Type 12 NEMA 1 Kit

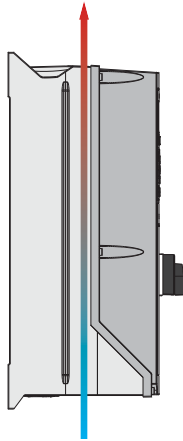

A4 IP55 with mains disconnect

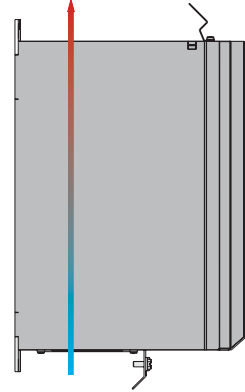
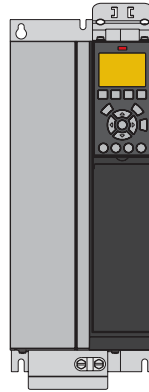

B3 IP20

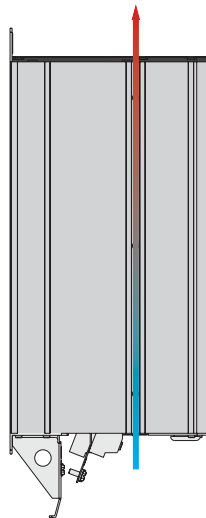
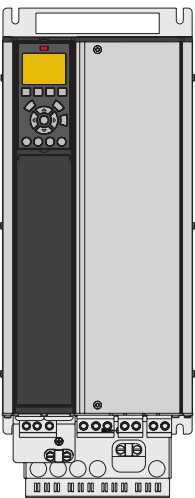

B4 IP20

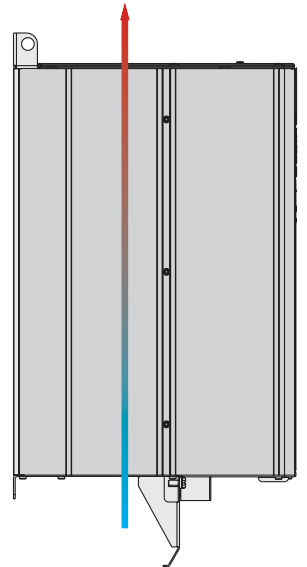
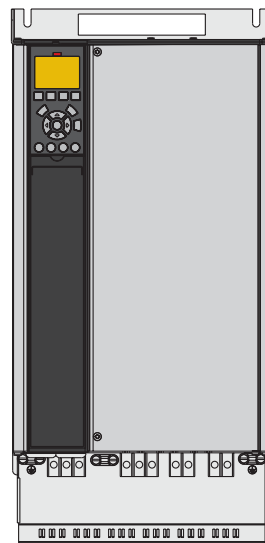

C3 IP20

A, B and C enclosures

Enclosure	VLT® Refrigeration Drive													
	A2		A3		A4	A5	B1	B2	B3	B4	C1	C2	C3	C4
Protection rating	IP20	IP21	IP20	IP21	IP55/IP66		IP21/IP55/IP66		IP20		IP21/IP55/IP66		IP20	
H mm Height of back plate	268	375	268	375	390	420	480	650	399	520	680	770	550	660
H1 mm With de-coupling plate for fieldbus cables	374	–	374	–	–	–	–	–	420	595	–	–	630	800
H2 mm Distance to mounting holes	254	350	257	350	401	402	454	624	380	495	648	739	521	631
W mm	90	90	130	130	200	242	242	242	165	230	308	370	308	370
W1 mm With one C option	130	130	170	170	–	242	242	242	205	230	308	370	308	370
W2 mm With two C options	150	150	190	190	–	242	242	242	225	230	308	370	308	370
W3 mm Distance between mounting holes	70	70	110	110	171	215	210	210	140	200	272	334	270	330
D mm Depth without option A/B	205	207	205	207	175	195	260	260	249	242	310	335	333	333
D1 mm With mains disconnect	–	–	–	–	206	224	289	290	–	–	344	378	–	–
D2 mm With option A/B	220	222	220	222	175	195	260	260	262	242	310	335	333	333
Air cooling	I (air space inlet) mm	100	100	100	100	100	200	200	200	200	200	225	200	225
	O (air space outlet) mm	100	100	100	100	100	200	200	200	200	200	225	200	225
Weight (kg)	4.9	5.3	6.6	7	9.7	13.5/14.2	23	27	12	23.5	45	65	35	50

A3 IP20 with option C

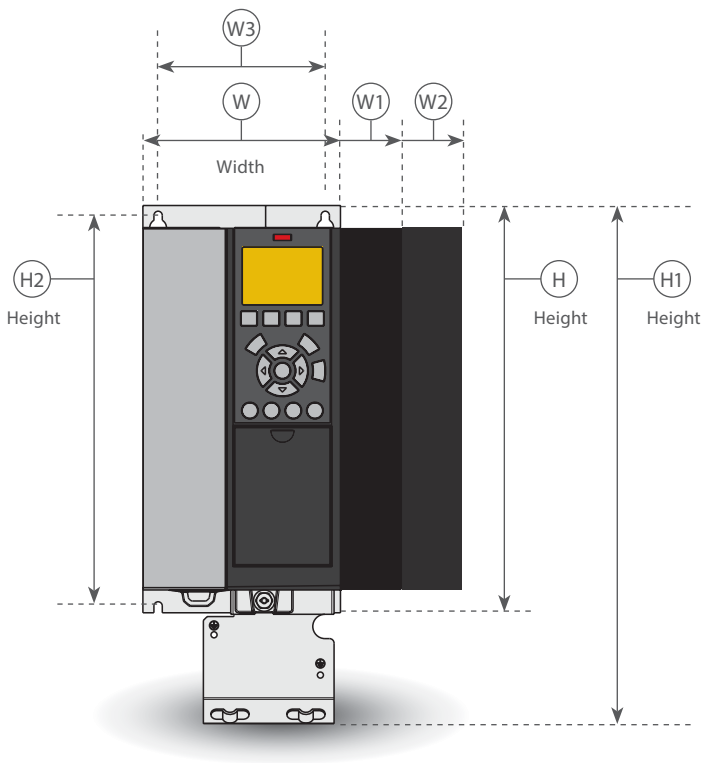

A4 IP55 with mains disconnect

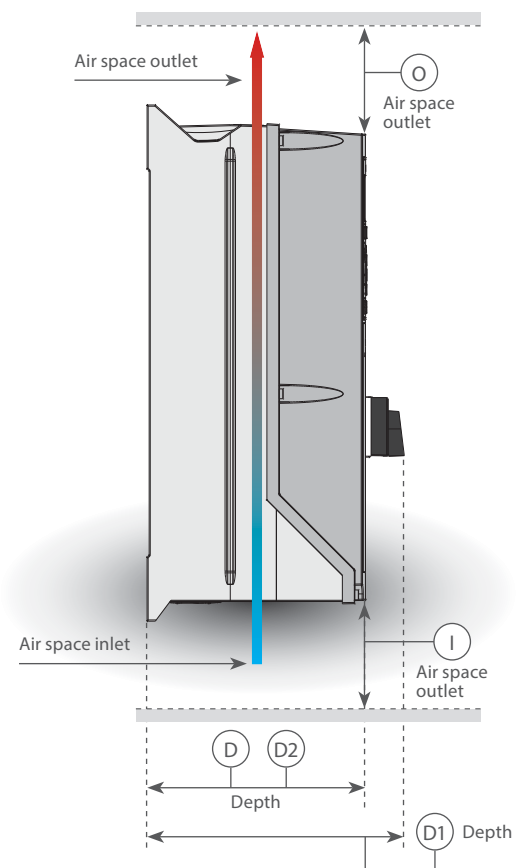

Dimensions and air flow

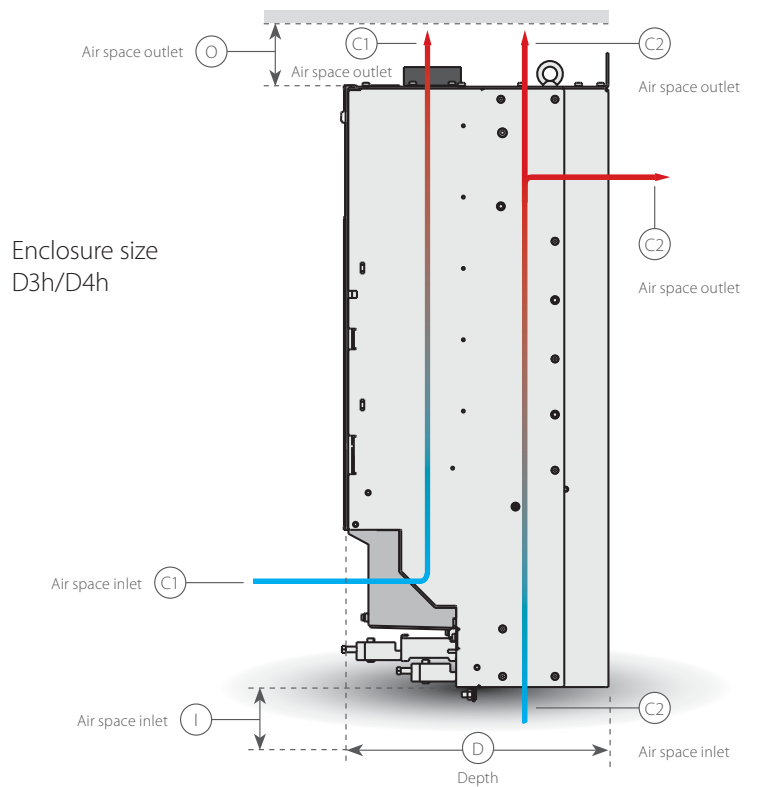
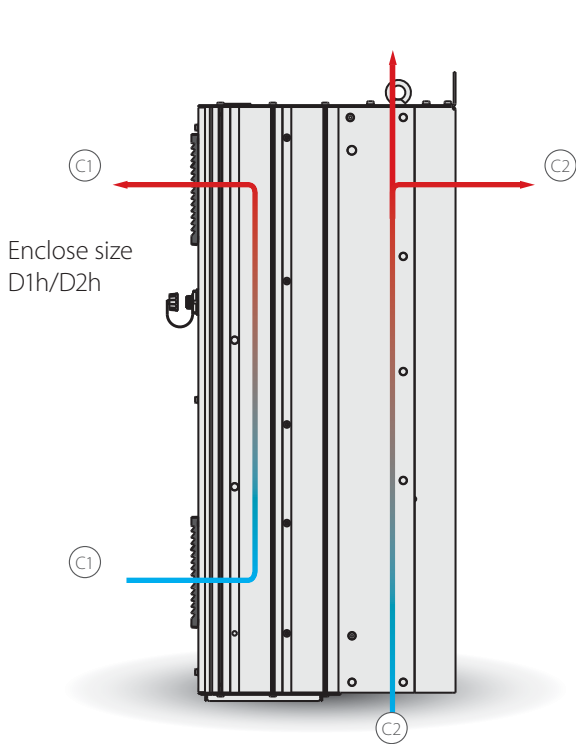
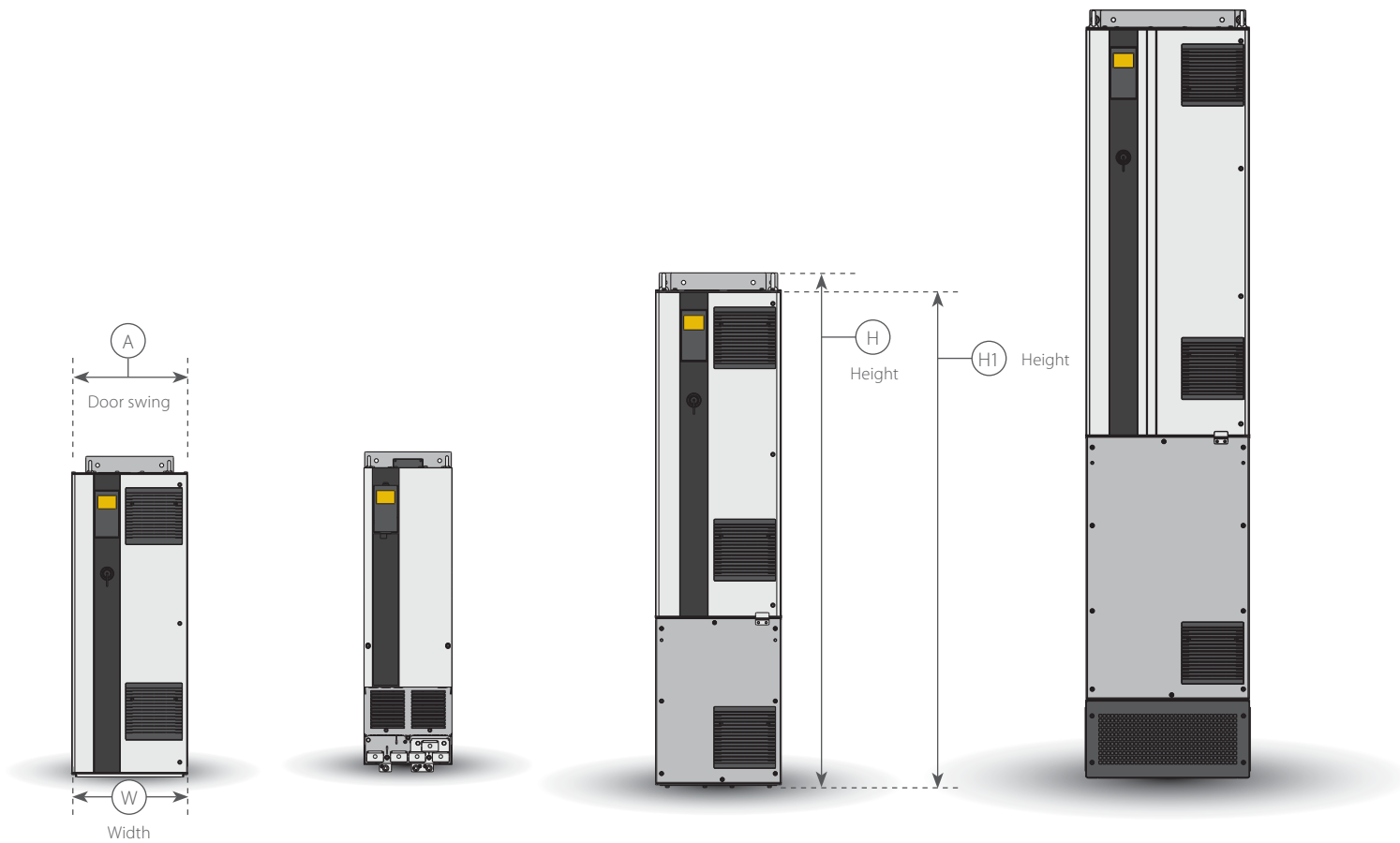

D enclosures

		VLT® Refrigeration Drive							
Enclosure		D1h	D2h	D3h	D4h	D5h	D6h	D7h	D8h
Protection rating		IP21/IP54		IP20		IP21/IP54			
H mm	Height of back plate	901	1107	909	1122	1324	1665	1978	2284
H1 mm	Height of product	844	1050	844	1050	1277	1617	1931	2236
W mm		325	420	250	350	325	325	420	420
D mm		378	378	375	375	381	381	384	402
D1 mm	With mains disconnect	-	-	-	-	426	426	429	447
Door swing A mm		298	395	n/a	n/a	298	298	395	395
Air cooling	I (air space inlet) mm	225	225	225	225	225	225	225	225
	O (air space outlet) mm	225	225	225	225	225	225	225	225
	C1	102 m ³ /hr (60 cfm)	204 m ³ /hr (120 cfm)	102 m ³ /hr (60 cfm)	204 m ³ /hr (120 cfm)	102 m ³ /hr (60 cfm)		204 m ³ /hr (120 cfm)	
	C2	420 m ³ /hr (250 cfm)	840 m ³ /hr (500 cfm)	420 m ³ /hr (250 cfm)	840 m ³ /hr (500 cfm)	420 m ³ /hr (250 cfm)		840 m ³ /hr (500 cfm)	

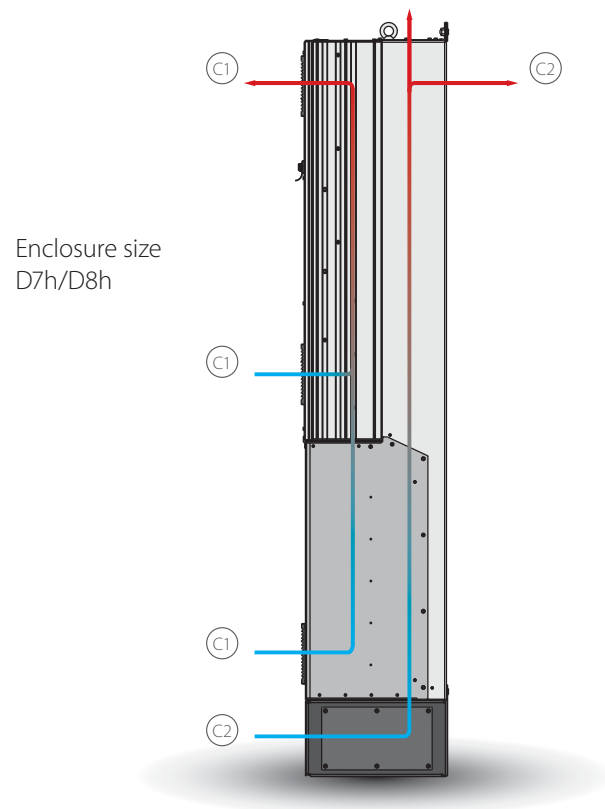
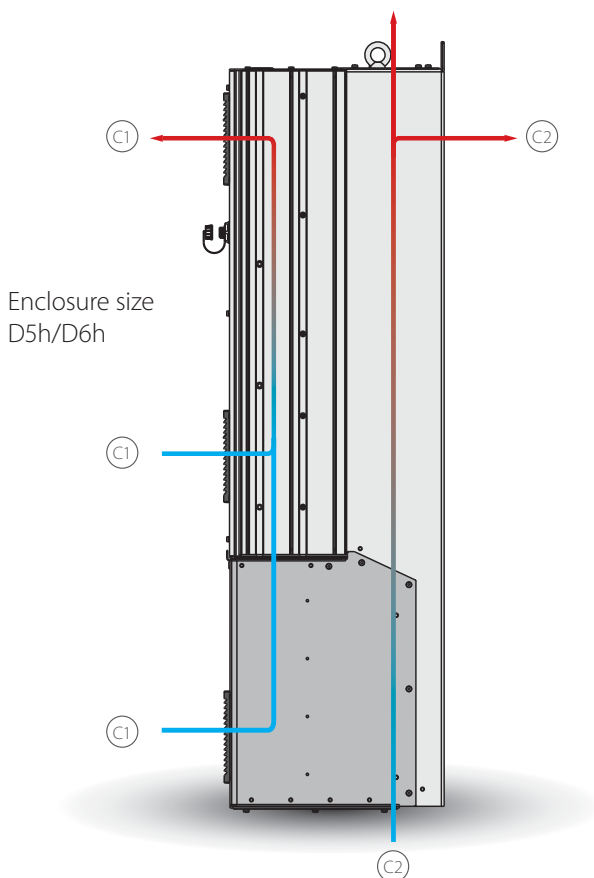

Dimensions and air flow

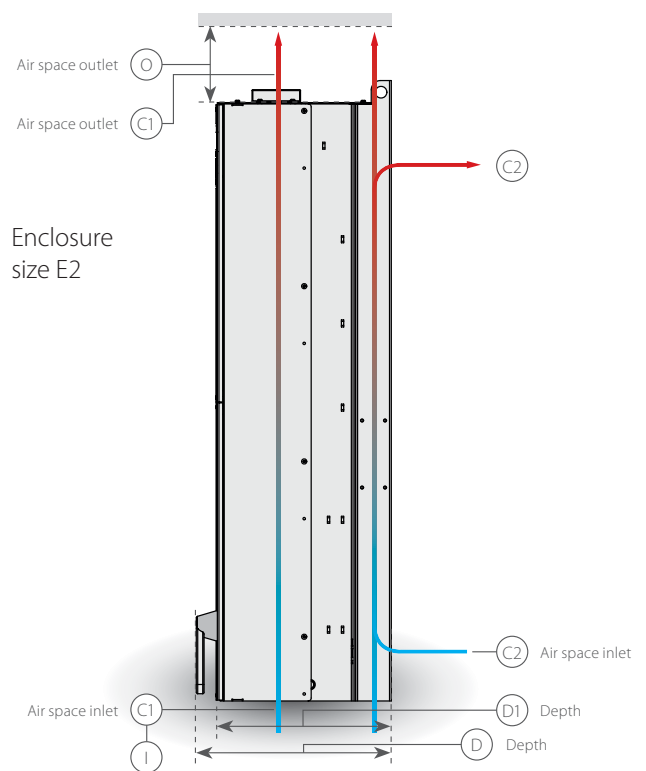
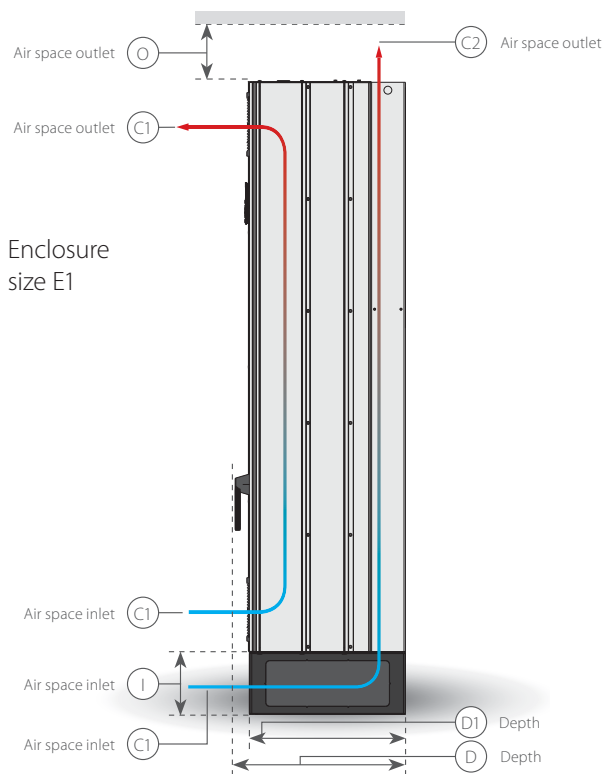
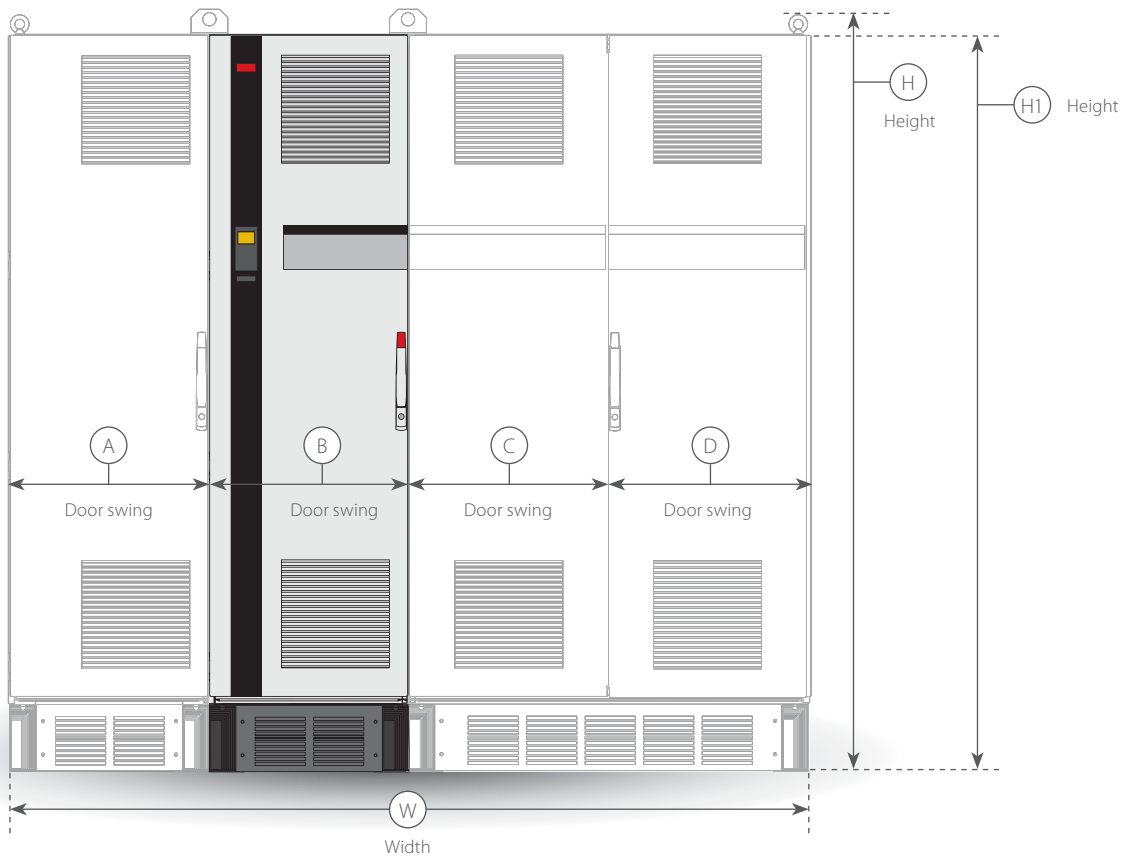

E enclosures

		VLT® Refrigeration Drive	
Enclosure		E1	E2
Protection rating		IP21/IP54	IP00
H mm (inches)		2000 (79)	1547 (61)
H1 mm (inches)		n/a	n/a
W mm (inches)		600 (24)	585 (23)
D mm (inches)		538 (21)	539 (21)
D1 mm (inches)		494 (19)	498 (20)
Door swing A mm (inches)		579 (23)	579 (23)
Door swing B mm (inches)		n/a	n/a
Door swing C mm (inches)		n/a	n/a
Door swing D mm (inches)		n/a	n/a
Air cooling	I (air space inlet) mm (inches)	225 (9)	225 (9)
	O (air space outlet) mm (inches)	225 (9)	225 (9)
	C1	1105 m ³ /hr (650 cfm) or 1444 m ³ /hr (850 cfm)	1105 m ³ /hr (650 cfm) or 1444 m ³ /hr (850 cfm)
	C2	340 m ³ /hr (200 cfm)	255 m ³ /hr (150 cfm)

A options: Fieldbuses

Available for the full product range

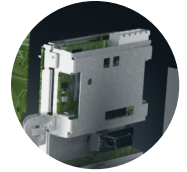

Fieldbus

A

VLT® PROFIBUS DP V1 MCA 101

VLT® PROFINET MCA 120

VLT® AK-LonWorks MCA 107

VLT® PROFIBUS DP MCA 101

Operating the frequency converter via a fieldbus enables you to reduce the cost of your system, communicate faster and more efficiently, and benefit from an easier user interface.

- VLT® PROFIBUS DP MCA 101 provides wide compatibility, a high level of availability, support for all major PLC vendors, and compatibility with future versions
- Fast, efficient communication, transparent installation, advanced diagnosis and parameterisation and auto-configuration of process data via GSD-file
- A-cyclic parameterisation using PROFIBUS DP-V1, PROFIdrive or Danfoss FC profile state machines, PROFIBUS DP-V1, Master Class 1 and 2

Ordering number

130B1100 standard, 130B1200 coated

VLT® PROFINET MCA 120

VLT® PROFINET MCA 120 uniquely combines the highest performance with the highest degree of openness. The MCA120 gives the user access to the power of Ethernet. The option is designed so that many of the features from the PROFIBUS MCA 101 can be reused, minimising user effort to migrate PROFINET, and securing the investment in PLC program.

Other features:

- Built-in web server for remote diagnosis and reading out of basic drive parameters
- Support of DP-V1 Diagnostic allows easy, fast and standardized handling of warning and fault information into the PLC, improving bandwidth in the system

PROFINET encompasses a suite of messages and services for a variety of manufacturing automation applications, including control, configuration and information.

Ordering number

130B1135 standard, 130B1235 coated

VLT® AK-LonWorks MCA 107

VLT® AK-LonWorks MCA 107 is a complete electronic refrigeration and control system for monitoring and controlling refrigeration plants. Connecting this drive to ADAP-KOOL® Lon network is really simple. After entering a network address, pressing a service pin starts the automatic configuration procedure.

Ordering number

130B1169 standard, 130B1269 coated
(Class 3C3/IEC 60721-3-3)

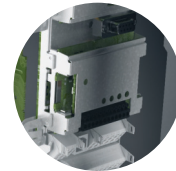

B options: Functional extensions

Available for the full product range

Functional extensions

B

VLT® General Purpose I/O MCB 101

VLT® Relay Card MCB 105

VLT® Analog I/O MCB 109

VLT® General Purpose I/O MCB 101

This I/O option offers an extended number of control inputs and outputs:

- 3 digital inputs 0-24 V:
Logic '0' < 5 V; Logic '1' > 10V
- 2 analogue inputs 0-10 V:
Resolution 10 bit plus sign
- 2 digital outputs NPN/PNP push pull
- 1 analogue output 0/4-20 mA
- Spring loaded connection

Ordering number

130B1125 standard, 130B1212 coated

VLT® Relay Card MCB 105

Makes it possible to extend relay functions with 3 additional relay outputs.

Max. terminal load:

- AC-1 Resistive load 240 V AC 2 A
- AC-15 Inductive
load @cos fi 0.4 240 V AC 0.2 A
- DC-1 Resistive load 24 V DC 1 A
- DC-13 Inductive
load @cos fi 0.4 24 V DC 0.1 A

Min. terminal load:

- DC 5 V 10 mA
- Max switch rate at rated
load/min. load 6 min⁻¹/20 sec⁻¹
- Protects control cable connection
- Spring-loaded control wire connection

Ordering number

130B1110 standard, 130B1210 coated

VLT® Analog I/O MCB 109

This analogue input/output option is easily fitted in the frequency converter for upgrading to advanced performance and control using the additional in/outputs. This option also upgrades the frequency converter with a battery back-up supply for the frequency converter's built-in clock. This provides stable use of all frequency converter clock functions as timed actions etc.

- 3 analogue inputs, each configurable as both voltage and temperature input
- Connection of 0-10 V analogue signals as well as PT1000 and NI1000 temperature inputs
- 3 analogue outputs each configurable as 0-10 V outputs
- Incl. back-up supply for the standard clock function in the frequency converter

The back-up battery typically lasts for 10 years, depending on environment.

Ordering number

130B1143 standard, 130B1243 coated

C options: Pack controller and relay card

Available for the full product range

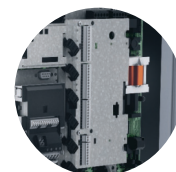

Option slot

C

VLT® Extended Relay Card MCB 113

VLT® Extended Relay Card MCB 113

The VLT® Extended Relay Card MCB 113 adds inputs/outputs to VLT® Refrigeration Drive FC 103 for increased flexibility and possibility to control up to 6 compressors

- 7 digital inputs
- 2 analogue outputs
- 4 SPDT relays
- Meets NAMUR recommendations
- Galvanic isolation capability

Ordering number

130B1164 standard, 130B1264 coated



D option: External power supply

Available for the full product range

Option slot

D

VLT® 24 V DC Supply Option MCB 107

VLT® 24 V DC Supply MCB 107

The option is used to connect an external DC supply to keep the control section and any installed option alive during power failure.

- Input voltage range...24 V DC +/- 15% (max. 37 V in 10 sec.)
- Max. input current 2.2 A
- Max. cable length 75 m
- Input capacitance load < 10 uF
- Power-up delay < 0.6 s

Ordering number

130B1108 uncoated, 130B1208 coated

Accessories

Available for the full product range

LCP

VLT® Control Panel LCP 102 (Graphical)
Ordering number: 130B1107

LCP Panel Mounting Kit

Ordering number for IP20 enclosure

- 130B1113: With fasteners, gasket, graphical LCP and 3 m cable
- 130B1114: With fasteners, gasket, numerical LCP and 3 m cable
- 130B1117: With fasteners, gasket and without LCP and with 3 m cable
- 130B1170: With fasteners, gasket and without LCP

Ordering number for IP55 enclosure

- 130B1129: With fasteners, gasket, blind cover and 8 m "free end" cable

Power Options*

VLT® Sine-Wave Filter MCC 101

VLT® dU/dt Filter MCC 102

VLT® Advanced Harmonic Filter AHF 005/010

VLT® Advanced Active Filter

VLT® Brake Resistors MCE 101

Accessories

USB Extension

- Ordering number:
- 130B1155: 350 mm cable
- 130B1156: 650 mm cable

IP21/Type 1 (NEMA 1) kit

Ordering number

- 130B1122: For frame size A2
- 130B1123: For frame size A3
- 130B1187: For frame size B3
- 130B1189: For frame size B4
- 130B1191: For frame size C3
- 130B1193: For frame size C4

*Ordering number: See relevant Design Guide

Ordering typecode

[1]	[2]	[3]	[4]	[5]	[6]	[7]	[8]	[9]	[10]	[11]	[12]	[13]	[14]	[15]	[16]	[17]	[18]	[19]
FC-																	X	XX

[1] Application (character 4-6)

103	VLT® Refrigeration Drive FC 103
-----	---------------------------------

[2] Power size (character 7-10)

P1K1	1.1 kW/1.5 HP
P1K5	1.5 kW/2.0 HP
P2K2	2.2 kW/3.0 HP
P3K0	3.0 kW/4.0 HP
P3K7	3.7 kW/5.0 HP
P4K0	4.0 kW/5.5 HP
P5K5	5.5 kW/7.5 HP
P7K5	7.5 kW/10 HP
P11K	11 kW/15 HP
P15K	15 kW/20 HP
P18K	18.5 kW/25 HP
P22K	22 kW/30 HP
P30K	30 kW/40 HP
P37K	37 kW/50 HP
P45K	45 kW/60 HP
P55K	55 kW/75 HP
P75K	75 kW/100 HP
P90K	90 kW/125 HP
N75K	75 kW/100 HP
N90K	90 kW/125 HP
N110	110 kW/150 HP
N132	132 kW/200 HP
N160	160 kW/250 HP
N200	200 kW/300 HP
N250	250 kW/350 HP
N315	315 kW/450 HP
N400	315 kW/450 HP
P355	355 kW/500 HP
P400	400 kW/550 HP
P450	450 kW/600 HP
P500	500 kW/650 HP
P560	560 kW/750 HP
P630	630 kW/900 HP

[3] AC Line Voltage (character 11-12)

T2	3 x 200/240 V AC (1.1 – 45 kW)
T4	3 x 380/480 V AC (1.1 – 450 kW)
T6	3 x 525/600 V AC (1.1 – 90 kW)
T7	3 x 525/690 V AC (90 – 630 kW)

[4] Enclosure (character 13-15)

For cabinet mounting:

E00	IP00/Chassis (frame E2)
E20	IP20/Chassis (frame A2, A3, B3, B4, C3, C4, D3h, D4h)

Standalone:

E21	IP21/Type 1 (frame B1, B2, C1, C2, D1h, D2h, D5h, D6h, D7h, D8h, E1, F1, F2, F3, F4, VLT® Low Harmonic Drive D13, E9, F18)
E54	IP54/Type 12 (frame D1h, D2h, D5h, D6h, D7h, D8h, E1, E1, F1, F2, F3, F4, VLT® Low Harmonic Drive D13, E9, F18)
E55	IP55 (frame A5, B1, B2, C1, C2)
E66	IP66/Type 4X outdoor (frame A5, B1, B2, C1, C2)
Z55	IP55/Type 12 (frame A4)
Z66	IP66/NEMA 4X (frame A4)

Special designs:

E55	NEMA 3R Ready IP54 – to be used with the NEMA 3R cover (D1h and D2h only)
E2M	IP21/Type 1 with mains shield (frame D1h, D2h, D5h, D6h, D7h, D8h, E1, VLT® Low Harmonic Drive D13 + E9)
P21	IP21/Type 1 (frame as E21 – with back plate)
E5M	IP54/Type 12 with mains shield (frame D1h, D2h, D5h, D6h, D7h, D8h, E1, VLT® Low Harmonic Drive D13 + E9)
P55	IP55 (frame as E55 – with back plate)
Y55	IP55 (frame as Z55 – with back plate)
Y66	IP66/NEMA 4X (frame as Z66 – with back plate)

[5] RFI filter, terminal and monitoring options – EN/IEC 61800-3 (character 16-17)

H1	RFI-Filter Class A1/B (C1) (A, B and C frames only)
H2	RFI-Filter, Class A2 (C3)
H4	RFI-Filter, Class A2 (C2) (B, C and D frames only)
H5	RFI-Filter, Class A2 (C3) Marine ruggedized

[6] Braking and safety (character 18)

X	No brake IGBT
T	Safe Stop without brake

[7] LCP Display (character 19)

X	Blank faceplate, no LCP installed
G	Graphical Local Control Panel (LCP 102)

[8] PCB Coating – IEC 721-3-3 (character 20)

X	Standard coated PCB Class 3C2
C	Coated PCB Class 3C3
R	Coated PCB Class 3C3 + ruggedized

[9] Mains input (character 21)

X	No mains option
1	Mains disconnect
3	Mains disconnect + fuse (D, E and F3, F4, F9, F11, F14, F18 frame only)
4	Mains contactor + fuse (D frame only)

[10] Cable (character 22)

X	Standard cable entries
O	Metric cable entries
S	US cable entries

[11] Auxiliary 24 V supply and external temperature monitoring (character 23)

X	No adaptation
Q	Heat-sink access panel (D frame only)

[13] LCP language (character 28)

X	Standard language package including English, German, French, Spanish, Danish, Italian, Swedish, Dutch and Russian
---	---

[14] Fieldbus (character 29-30)

AX	No option
A0	VLT® PROFIBUS DP V1 MCA 101
AL	VLT® PROFINET MCA 120
AZ	VLT® AK-LonWorks MCA 107

[15] Application 1 (character 31-32)

BX	No application option
BK	VLT® General Purpose MCB 101
BP	VLT® Relay Option MCB 105
B0	VLT® Analog I/O Option MCB 109

[16] Application 2 (character 33-34)

X	No option
R	VLT® Extended Relay Card MCB 113

[19] Control Power Backup Input (character 38-39)

DX	No DC input installed
D0	VLT® 24 V DC Supply Option MCB 107

1) reduced motor cable length

Please beware that not all combinations are possible. Find help configuring your drive with the online configurator found under: driveconfig.danfoss.com



A better tomorrow is **driven by drives**

Danfoss Drives is a world leader in variable speed control of electric motors.

We offer you unparalleled competitive edge through quality, application-optimized products and a comprehensive range of product lifecycle services.

You can rely on us to share your goals. Striving for the best possible performance in your applications is our focus. We achieve this by providing the innovative products and application know-how required to optimize efficiency, enhance usability, and reduce complexity.

From supplying individual drive components to planning and delivering complete drive systems; our experts are ready to support you all the way.

You will find it easy to do business with us. Online, and locally in more than 50 countries, our experts are never far away, reacting fast when you need them.

You gain the benefit of decades of experience, since 1968. Our low voltage and medium voltage AC drives are used with all major motor brands and technologies in power sizes from small to large.

VACON® drives combine innovation and high durability for the sustainable industries of tomorrow.

For long lifetime, top performance, and full-throttle process throughput, equip your demanding process industries and marine applications with VACON® single or system drives.

- Marine and Offshore
- Oil and Gas
- Metals
- Mining and Minerals
- Pulp and Paper

- Energy
- Elevators and Escalators
- Chemical
- Other heavy-duty industries

VLT® drives play a key role in rapid urbanization through an uninterrupted cold chain, fresh food supply, building comfort, clean water and environmental protection.

Outmaneuvering other precision drives, they excel, with remarkable fit, functionality and diverse connectivity.

- Food and Beverage
- Water and Wastewater
- HVAC
- Refrigeration
- Material Handling
- Textile

VLT® | VAGON®

Danfoss can accept no responsibility for possible errors in catalogues, brochures and other printed material. Danfoss reserves the right to alter its products without notice. This also applies to products already on order provided that such alterations can be made without subsequential changes being necessary in specifications already agreed. All trademarks in this material are property of the respective companies. Danfoss and the Danfoss logotype are trademarks of Danfoss A/S. All rights reserved.