

# Valvistor® Proportional Flow Control Cartridge Valves

CVCS-\*\*-HFV, 10 Series, Covers  
CVI-\*\*-HFV-A/B, 10 Series, Inserts

350 bar  
Up to 2160 L/min



ENGINEERING  
TOMORROW

BC444864371497en-000101

# Table of Contents

General Description .....	2
Valvistor Technology.....	2
Basic characteristics .....	2
Features and Benefits.....	3
Functional Symbols.....	4
Model Codes .....	5
Operating Data .....	6
Pivot Valve Electrical Data.....	6
Flow Pressure Drop Charts.....	7
Pressure Drop .....	9
Hydraulic Fluids .....	10
Filtration Requirements .....	10
Temperature Limits .....	10
Mounting Bolts and Assembly Torques	11
Seal Kits.....	11
Ordering Procedure .....	11
Installation Dimensions .....	12
Valvistor Line Extension (High performance and OBE options) .....	13
Released Part Numbers.....	14

## General Description

Danfoss' Vickers® HFV (Hydraulic Feedback Valvistor®) range of slip-in cartridge valves uses a self-regulating hydraulic design for the control of flow rate by a current-controlled PWM signal. The design achieves servo-type control of the main poppet without using an electrical feedback transducer.

The construction and features of these valves open up a wide range of applications with hydraulic cylinders and motors. Such applications include ie casting, deep drawn presses, injection molding, container handling, shovel loaders, forestry and dump trucks. With the addition of HFV valves to the established ISO 7368 (DIN 24342) cartridge valves, Danfoss has further enhanced an already comprehensive range.

## Valvistor Technology

In "Valvistor" designs a main poppet amplifies a small flow through the pilot circuit, comparable to a transistor. Thus the name "Valvistor", derived from "valve" and "transistor". Figures 1 and 2 show the construction of proportional throttles to ISO 7368. In both cases a Vickers type KTG4V-3S proportional valve is used as the pilot control valve. Hydraulic position feedback is obtained by providing the main poppet with a longitudinal slot (5) in its cylindrical surface. This slot, together with a metering edge inside the sleeve, forms a variable orifice between the inlet of the valve and the volume above the main poppet (3). When the valve is closed and the main poppet is seated, the variable orifice area is almost closed.

**Figure 1**

Construction for flow direction A to B; poppet in the closed (no flow) condition. (Note: For flow A-B, poppet drilled from A.)

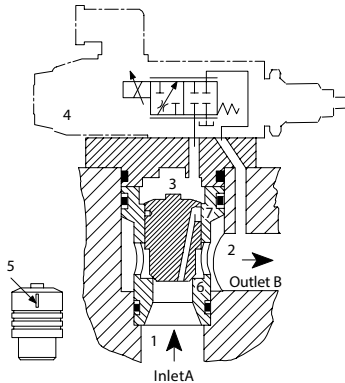

**Figure 2**

Construction for flow direction B to A; poppet partially open. (Note: For flow B-A, poppet drilled from B.)

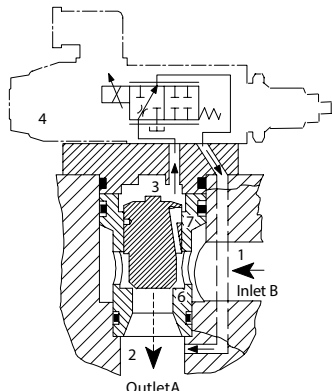

## Basic Characteristics

Nominal Sizes:

ISO 7368	DIN 24342
06	NG16
08	NG25
09	NG32
10	NG40
11	NG50
12	NG63

Maximum operating pressure ..... 350 bar (5000 psi)  
Flow ratings ..... up to 2160 L/min (571 USgpm)

Catalog data based on pilot valve KTG4V-3S-EN427.

As the main poppet opens, the variable orifice area increases. The slot is a part of one leg of a hydraulic bridge circuit and provides an internal position feedback. With the pilot throttle valve closed (figure 1), there is no pilot flow through the closed-off slot in the seated poppet. The pressure above the main poppet (3) is equal to the pressure at the valve inlet (1), due to the controlled small opening at the variable orifice. As the upper area of the poppet is greater than the area facing the inlet (1), the poppet is held against its seat (6) by a force proportional to the difference between valve inlet and outlet pressures.

Opening the pilot throttle valve (figure 2) lowers the pressure in volume (3) allowing the main poppet to move off its seat. As this occurs the slot passes the metering edge (7), opening the variable orifice and allowing flow through the pilot circuit. Initially the flow through the pilot valve equals the flow through the slot plus the volume displaced by the opening movement of the main poppet. The main poppet moves upwards until the pressure drops across the slot and the pilot effects a force balance on the poppet. The poppet is then held in a steady-state condition with equal flow across the slot and the pilot.

If the flow through the pilot valve is reduced (by reducing the command current to the solenoid), the force balance of the main poppet is again disturbed and the main poppet moves Downwards reducing the slot area and decreasing flow to the upper chamber until the force balance is restored. Thus by controlling flow through the pilot valve, the main poppet can be controlled in any position from fully closed to fully open. In this manner a very simple, effective servo-control of the main poppet is obtained. If the outlet pressure exceeds inlet pressure when the pilot valve is closed, the main poppet allows reverse flow (see CVCS model code). The main valve function is determined by the type of pilot fitted.

If pressure compensation is added to the pilot stage, the complete valve is pressure compensated. If a pilot relief valve is fitted, the main stage operates as a relief valve. As the pilot flow is returned to the valve outlet (i.e. no "drain" connection) the valve is energy efficient. Therefore the position of the main poppet is controlled by a closed-loop system with a variable orifice in the poppet acting as the internal position feedback element. The command signal in this feedback system is pilot flow, as set at the proportional pilot throttle valve (4).

## Features and Benefits

The HFV range with its simplicity, cost effectiveness and performance level can be applied in almost all applications from high performance industrial areas such as injection molding to those applications just requiring proportional functionality.

The data in this catalog is based on the specially developed proportional pilot KTG4V-3S-60-EN427. The functional flexibility of the Valvistor may be extended by the use of different pilots. Contact Danfoss for application assistance.

In addition, the HFV range offers:

<b>Unequaled simplicity</b>	No inner electrical feedback loop and associated electronics
<b>Two models: for flow direction A to B or B to A</b>	Provides system design options and flexibility
<b>Free flow in reverse direction</b>	Provides system design options and flexibility
<b>Poppet valve construction</b>	Provides tight shut-off and load holding
<b>Internal pilot flow</b>	Simple installation and energy efficient
<b>Very fast response</b>	Provides the system designer with high dynamic acceleration/velocity/deceleration profiles for demanding performance requirements such as: <ul style="list-style-type: none"> <li>• Cylinder position control including lift/lower</li> <li>• Rotary actuator dynamic control</li> <li>• Velocity profile control</li> </ul>
<b>Smooth closing and opening</b>	Shock-free start-up and shut-off allow high velocities to be maintained for longer periods, thus reducing cycle times
<b>Low hysteresis</b>	8% to 1% depending on pilot valve used
<b>Integral feedback</b>	Internal hydraulic feedback provides effective, low-cost position control of main poppet
<b>Repeatability</b>	Provides repeatable and accurate actuator velocity to a given operator command input
<b>Electrical operation</b>	Current-controlled PWM signal
<b>Pressure compensation</b>	Can be achieved by pressure compensating pilot stage only
<b>Cost-effective design</b>	Provides multiple functions such as pressure compensation, flow control and reverse free flow check valve
<b>Optional manual override</b>	Pin design
<b>Compatible with antiwear hydraulic oils and phosphateesters (non alkyl)</b>	Flexible application for broad range of installations
<b>Electrical connections DIN or conduit box</b>	Provides design flexibility to meet OEM or user preference

Inherent benefits of Danfoss cartridge valve technology are applicable to the Valvistor range.

# Functional Symbols

## Valvistor® Proportional Throttle Valves

Complete valve assembly comprises insert, cover and proportional solenoid operated pilot valve (pilot valve to be specified and ordered separately).

Models without free reverse flow capability  
 Use cover type CVCS-\*\*-HFV\*-W-  
 \*2(9)-1\*

Simplified symbol

### Direction of controlled flow

A to B

Use insert type CVI-\*\*-HFV-20-A-\*\*\*-1\*

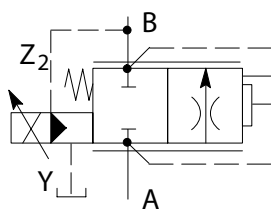
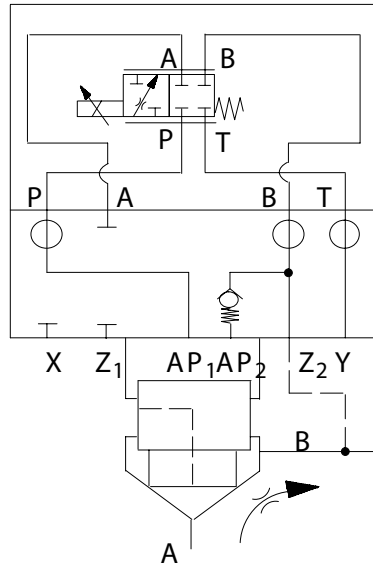

B to A

Use insert type CVI-\*\*-HFV-20-B-\*\*\*-1\*

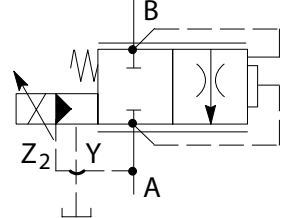
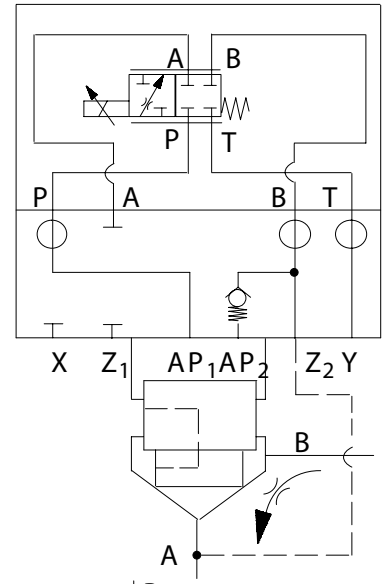

Models with free reverse flow capability  
 Use cover type CVCS-\*\*-HFV\*-2(9)-1\*  
 Note: Omit W from model code  
 position 6

Simplified symbol

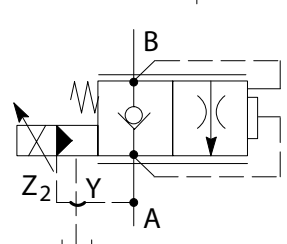
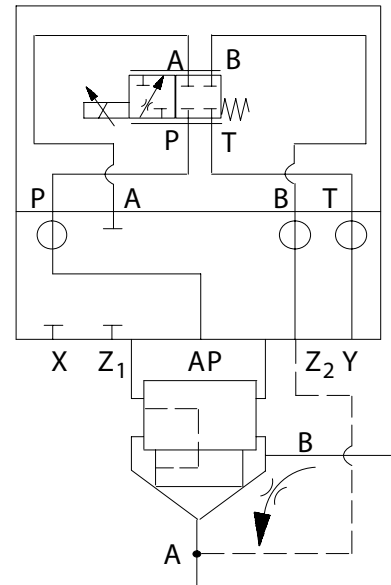
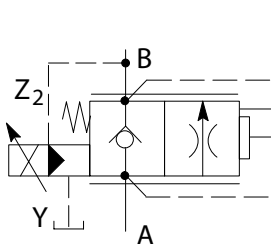
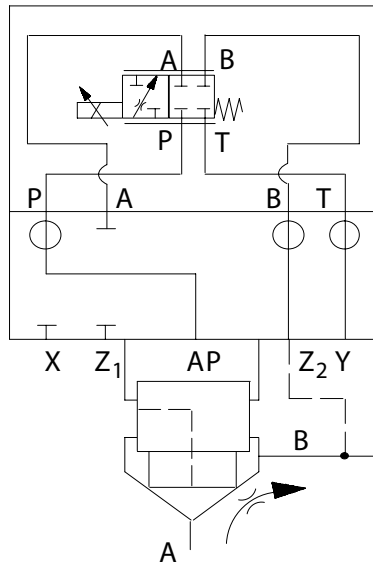

# Model Codes Valvistor® Proportional Throttle Valves

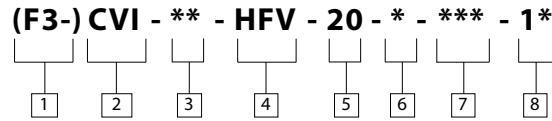

**1 Seal Material**

**F3** - Seals for phosphate Esters or chlorinated hydrocarbons. Omit for all other fluid types.

**2 Model**

**CVI** - Cartridge valve insert

**3 Nominal size to ISO 7368 (DIN 24342)**

- 16** - 06 (NG16)
- 25** - 08 (NG25)
- 32** - 09 (NG32)
- 40** - 10 (NG40)
- 50** - 11 (NG50)
- 63** - 12 (NG63)

**4 Flow direction**

**HFV** - Hydraulic feedback, Valvistor

**5 Area ratio**

**20** - 1:2 area ratio

**6 Flow direction**

**A** - For flow A to B  
**B** - For flow B to A

**7 Flow capacity at Δp = 10 bar (145 psi)**

Size/Flow Direction	Code	L/min	USgpm
16A	21	210	55
16B	21	210	55
25A	40	405	107
25B	32	320	107
32A	63	630	166
32B	63	630	166
40A	90	900	238
40B	81	900	238
50A	130	1305	345
50B	130	1305	345
63A	216	2160	571
63B	216	2160	571

**Valvistor Throttle Covers (Suitable for flows A to B and B to A)**

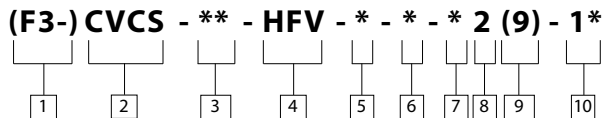

**1 Fluid compatibility**

**F3** - Seals for phosphate esters or chlorinated hydrocarbons. Omit for all other fluid types.

**2 Model**

**CVI** - Cartridge valve cover to ISO 7368

**3 Nominal size to ISO 7368 (DIN 24342)**

- 16** - 06 (NG16)
- 25** - 08 (NG25)
- 32** - 09 (NG32)
- 40** - 10 (NG40)
- 50** - 11 (NG50)
- 63** - 12 (NG63)

**4 Type**

**HFV** - Hydraulic feedback, Valvistor

**5 Size 3 pilot valve mounting bolts**

**1** - Imperial threads  
**3** - Metric threads

**6 Control option**

**W** - Mainstage Valvistor without free reverse flow. Omit for standard mainstage Valvistor with free reverse flow capability

**7 Thread/seal combination**

**B** - G (BSPF) threads for gage ports; metric threads for orifices (only available when "3" specified at position 5)  
**S** - SAE O-ring gage; inch threads for orifices (only available when "1" specified at position 5)

**8 Seals**

**2** - Inch O-ring seals to ISO 3601

**9 Mounting bolts**

Sizes 16-40 only  
**9** - Metric mounting bolts supplied as standard when "B" (BSPF threads) specified at position 7 Omit for sizes 50 and 63

**10 Design number, 1\* series**

Subject to change. Installation dimensions unaltered for design numbers 10 to 19.

**Pilot Valve**

For operation with 12V control system:  
KTG4V-3S2B 08N-(V)M-\*\*\*\*  
\*(1)**G5-60-EN427**

For operation with 24V control system:  
KTG4V-3S2B 08N-(V)M-\*\*\*\*  
\*(1)**H5-60-EN427**

For full technical details of this valve including types of electrical connections, see Danfoss' Vickers Slip-in Cartridge Valve Catalog.

## Operating Data

Data is typical with fluid at 36 cSt (168 SUS) and 50C (122F).

<b>Maximum pressure</b>	350 bar (5000 psi)					
<b>Flow ratings</b>	See model code (CVI)					
<b>Controlled flow characteristics</b>	See graphs on pages 7 and 8					
<b>Pressure drop, free return flow</b>	See graphs on page 9					
<b>Dynamic performance:</b>	06	08	09	10	11	12
Step input ▲ response at $\Delta p = 10$ bar (145 psi)	(NG16)	(NG25)	(NG32)	(NG40)	(NG50)	(NG63)
Opening time (ms)	50	85	130	240	280	340
Closing time (ms)	40	60	85	130	200	300
Hysteresis ▲	<8%	<8%	<8%	<8%	<8%	<8%
Repeatability ▲	<3%	<3%	<3%	<3%	<3%	<3%
<b>Area ratio (all sizes)</b>	2:1					
<b>Hydraulic fluids</b>	See page 11					
<b>Temperature limits</b>	See page 11					
<b>Filtration requirements</b>	See page 11					
<b>Mounting bolts and assembly torques</b>	See page 12					
<b>Seal kits</b>	See page 12					
<b>Mass</b>	See page 12					

▲ Data quoted with KTG4V-3S---60-EN427 as pilot valve, driven by EEA-PAM-523-A-32 (Economic Performance)

▲ For standard & high performance and On-Board-Electronics (OBE) options, see "Valvistor line extension" on page 13.

## Pilot Valve Electrical Data

Full performance data and model code breakdown can be found in Danfoss' Vickers Slip-in Cartridge Valve Catalog.

<b>Type</b>	KTG4V-3S---60-EN427 (denotes special spool)	
<b>Max. current at 50°C (122F)</b>	Coil type	
	G	H
	3.2A	1.6A
<b>Coil resistance at 20°C (68F)</b>	1.8 ohms 7.3 ohms	
<b>Coil inductance at 1000Hz</b>	7.5 mH 29 mH	
<b>Relative duty factor</b>	Continuous rating (ED = 100%)	
<b>Electrical protection with plugs fitted correctly</b>	IEC 947 class IP65	
<b>Recommended amplifier</b>	EEA-PAM-523-A-32	

▲ For standard & high performance and On-Board-Electronics (OBE) options, see "Valvistor line extension" on page 13.

### Performance Characteristics

The graphs on the following two pages show typical flow characteristics for different values of input current to pilot valve plotted against flow rate and valve pressure drop. They are based on a standard HFV insert and cover with a KTG4V-3S---EN427 pilot valve. A minimum pressure drop of 5 bar (72 psi) is recommended. Higher pressure drops result in improved control.

# Flow/Pressure Drop vs Solenoid Current (% of max.)

Size 16

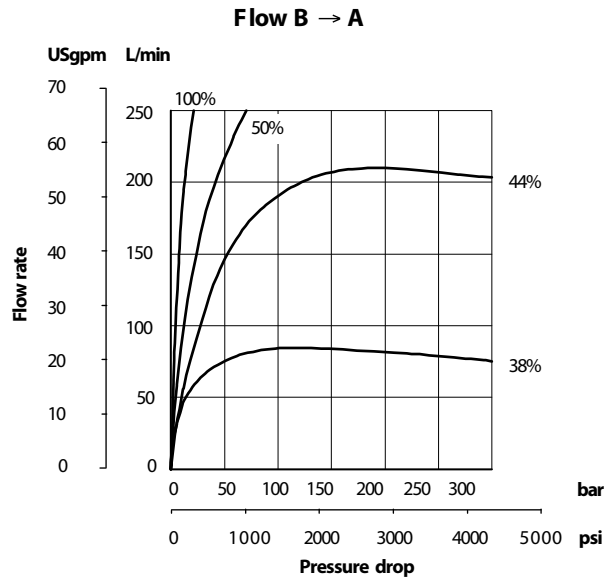
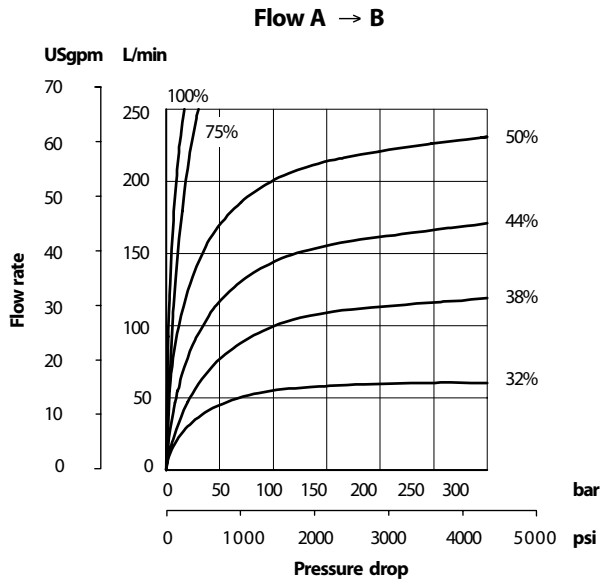

Size 25

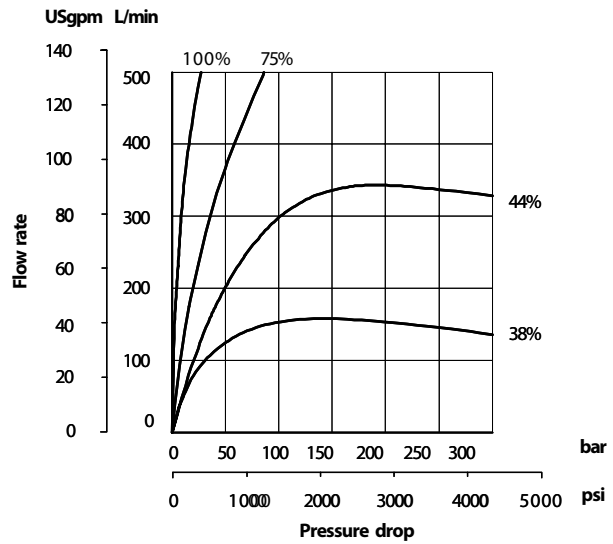
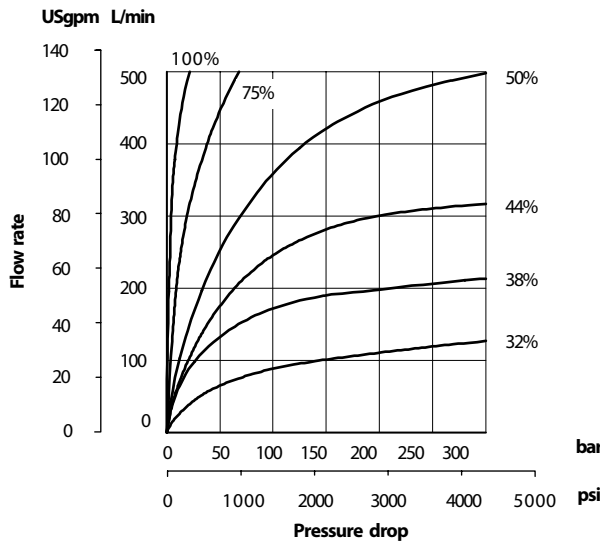

Size 32

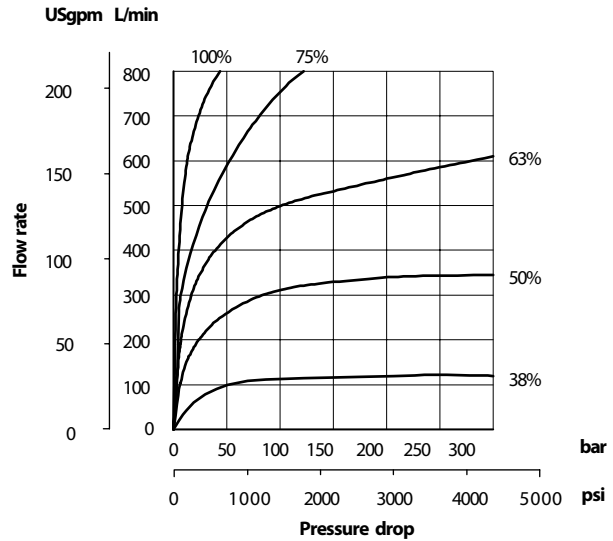
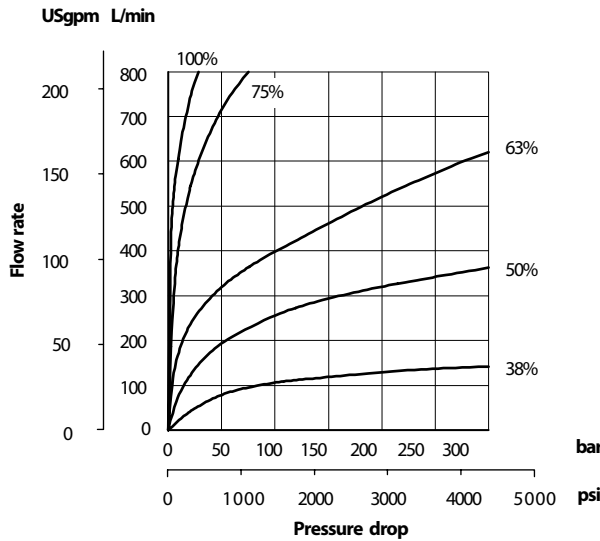



# Flow/Pressure Drop vs Solenoid Current (% of max.)

Size 40

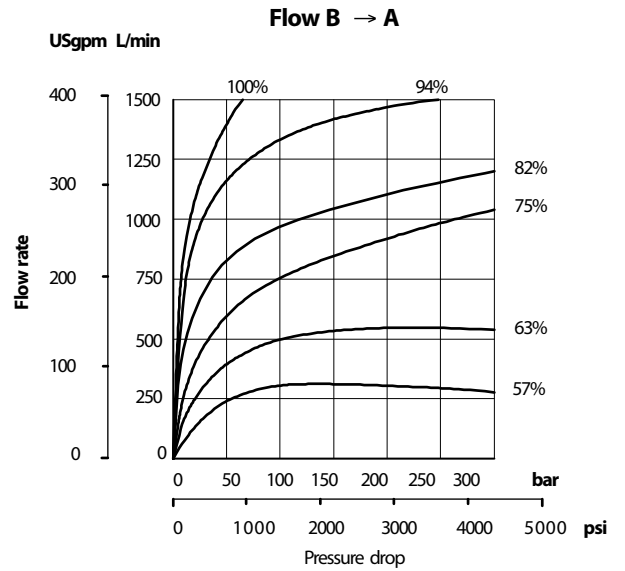
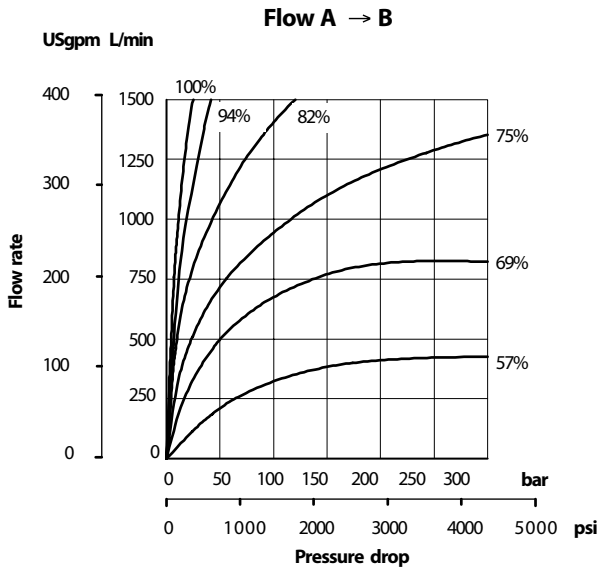

Size 50

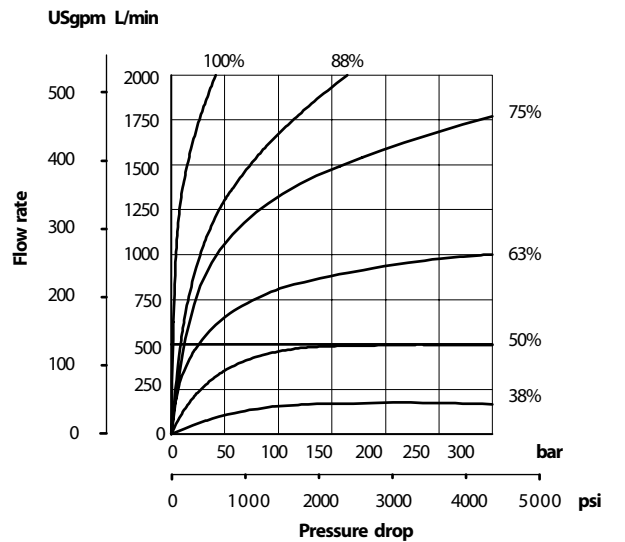
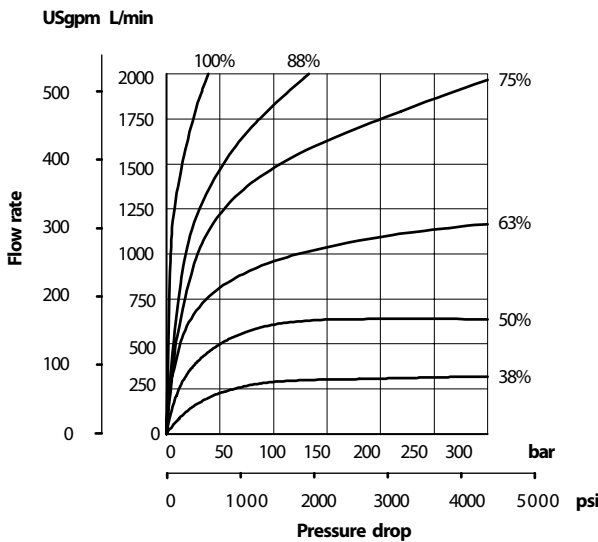

Size 63

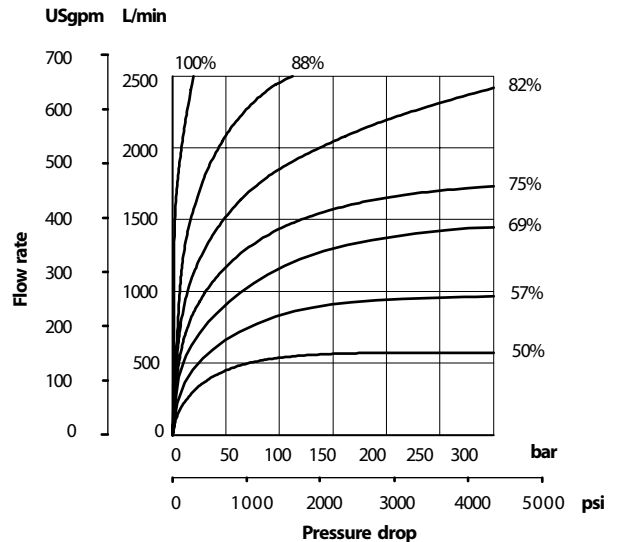
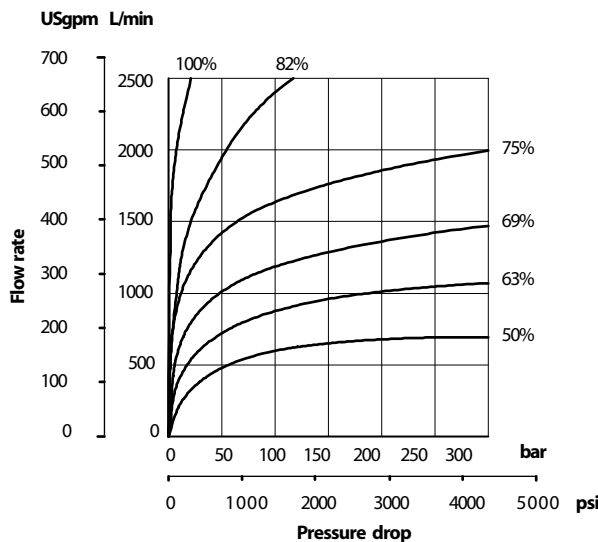

# Pressure Drops - Free Return Flow

Size 16

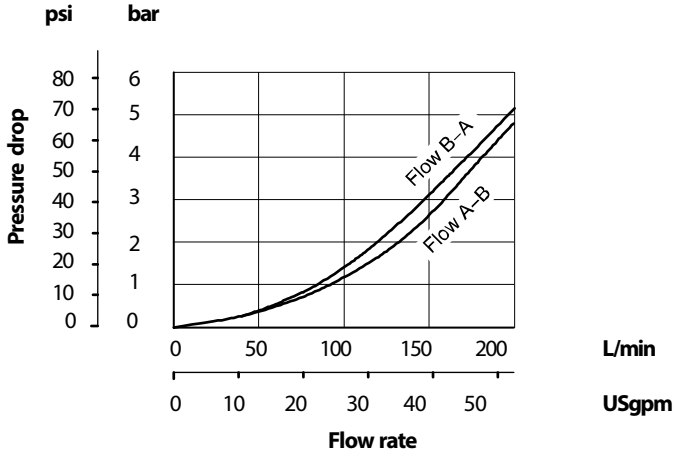

Size 25 psi bar

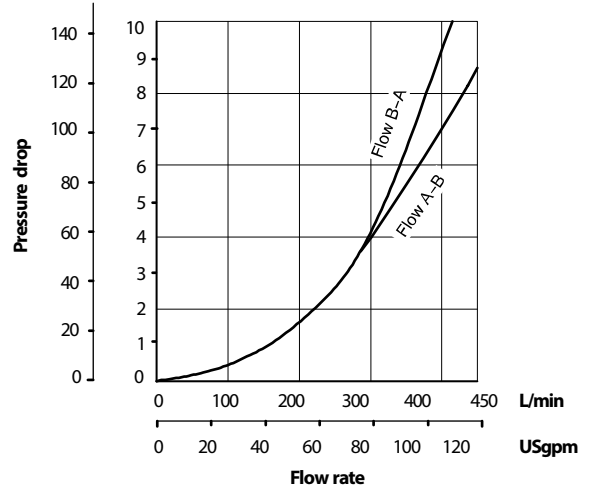

Size 32

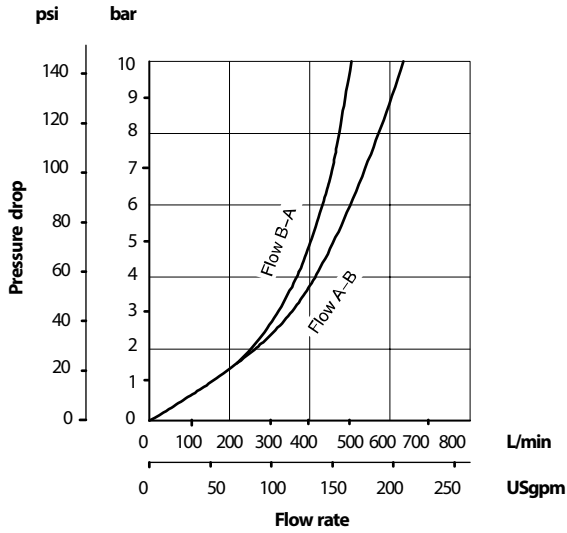

Size 40 psi bar

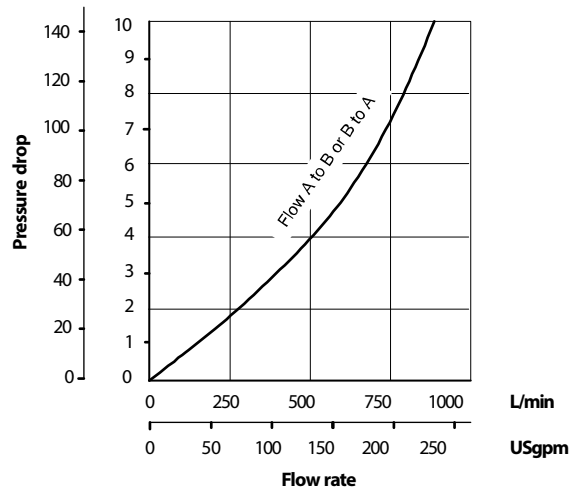

Size 50

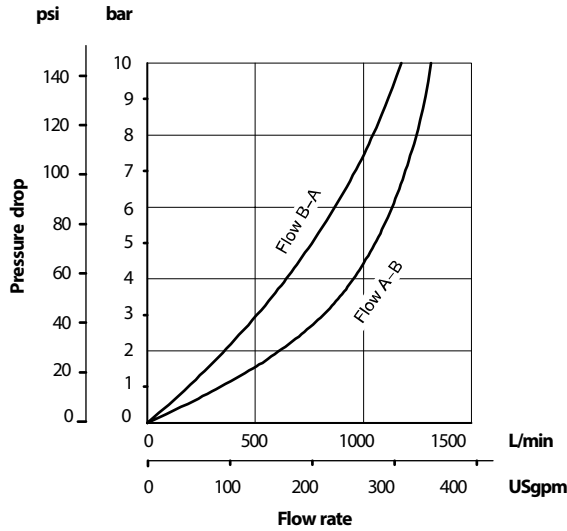

Size 63 psi bar

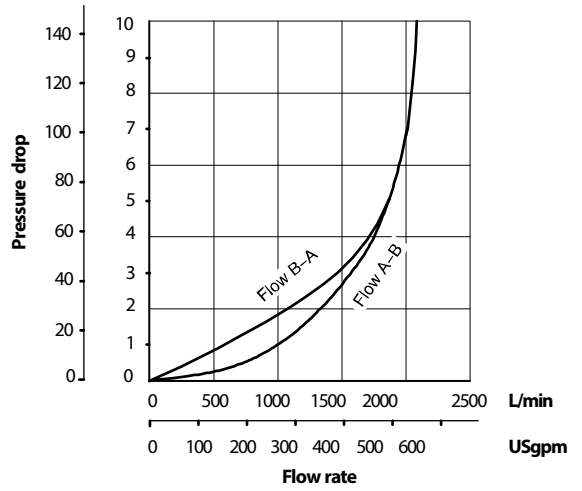

## Hydraulic Fluids

All cartridge valves can be used with antiwear hydraulic oils, and certain low viscosity fluids. Add prefix "F3" to model designations when phosphate esters (not alkyl-based) or chlorinated hydrocarbons are to be used. The extreme viscosity range is from 500 to 5 cSt (2270 to 42 SUS) but the recommended running range is from 54 to 13 cSt (245 to 70 SUS).

## Filtration Requirements

Essential information on the correct methods for treating hydraulic fluid is included in the Danfoss Vickers publication 561 "Vickers Guide to Systemic Contamination Control", available from your local Danfoss distributor.

Recommendations on filtration and the selection of products to control fluid condition are also included in Danfoss Vickers publication 561.

## Temperature Limits

Ambient min .....- 20C (-4F)  
Ambient max .....+70C (+158F)

### Fluid temperatures

	Petroleum oil	Wateroil containing
Min.	-20C (-4F)	+10C (+50F)
Max.	+80C (+176F)	+54C (+130F)

Recommended cleanliness levels using petroleum oil under common conditions is based on the highest fluid pressure levels in the system. In referencing the table below, the bolded numbers highlight the recommended cleanliness level for Valvistor proportional throttles.

Fluids other than petroleum, severe service cycles or temperature extremes are cause for adjustment of these cleanliness codes. See Danfoss Vickers publication 561 for exact details.

## Recommended Fluid Cleanliness Level (ISO Code)

Product	System Pressure Level 69 bar (1000 psi)	System Pressure Level 138 bar (2000 psi)	System Pressure Level 210+ bar (3000 psi)
Vane Pumps – Fixed	20/18/15	19/17/14	18/16/13
Vane Pumps – Variable	18/16/14	17/15/13	
Piston Pumps – Fixed	19/17/15	18/16/14	17/15/13
Piston Pumps – Variable	18/16/14	17/15/13	16/14/12
Directional Valves	20/18/15	20/18/15	19/17/14
Pressure/Flow Control Valves	19/17/14	19/17/14	19/17/14
Servo Valves	16/14/11	16/14/11	16/13/10
<b>Proportional Valves</b>	<b>17/15/12</b>	<b>17/15/12</b>	<b>15/13/11</b>
Cylinders	20/18/15	20/18/15	20/18/15
Vane Motors	20/18/15	19/17/14	18/16/13
Axial Piston Pumps	19/17/14	18/16/13	17/15/12
Radial Piston Pumps	20/18/14	19/17/13	18/16/13

## Mounting Bolts and Assembly Torques

As noted in CVCS model code position , cover types CVCS-\*\*-HFV1-(W)-B29-1\* , sizes 16 to 40 inclusive, are supplied

complete with metric mounting bolts. For correct installation of all other CVCS-\*\*-HFV\* cover types, the following Danfoss bolt kits are recommended.

### Inch threads

Nominal Size	Bolt Size	Bolt Kit Model Code	Recommended Assembly Torque, lbf ft
16	5/16"-18 x 1.50	BKDNG16-700	26
25	1/2"-13 x 1.50	BKDPNG25-704	81
32	5/8"-11 x 2.00	BKDNG32-713	210
40	3/4"-10 x 2.25	BKDPNG40-706	370
50	3/4"-10 x 3.00	BKDNG50-708	429
63	1 1/4"-7 x 3.50	BKDNG63-710	888

### Metric threads

Nominal Size	Bolt Size	Bolt Kit Model Code	Recommended Assembly Torque, Nms
16	◆	-	35
25	◆	-	110
32	◆	-	285
40	◆	-	500
50	M20 x 80	BKDNG50-709M	580
63	M30 x 90	BKDNG63-711M	1200

■ With threads lubricated.      ◆ See installation drawing, next page.

### For Pilot Valve

See Slip-in Cartridge Valve Catalog.

## Seal Kits

### For CVI-\*\*-HFV inserts

Nominal Size	Seal Kit Type, See Model Code Standard	F3-
16	456173	02-157617
25	456926	02-157618
32	479449	02-157619
40	478732	514808
50	478733	02-157620
63	456798	02-157621

### For CVCS-\*\*-HFV covers

Nominal Size	Seal Kit Type, See Model Code Standard	F3-
16	02-157672	02-157671
25	02-157674	02-157673
32	02-157905	02-157906
40	02-157712	02-157713
50	02-310971	02-310973
63	02-310975	02-310976

## Weights

Nominal Size	CVI-**-HFV Insert	CVCS-**-HFV Cover
16	0,13 kg (0.29lb) 1,2 kg (2.6 lb)	1,2 (2.6)
25	0,33 (0.73)	1,9 (4.2)
32	0,9 (1.98)	3,3 (7.3)
40	1,35 (3.0)	6,3 (13.9)
50	2,2 (4.8)	9,6 (21.0)
63	5,4 (11.9)	19,4 (42.7)

## Ordering Procedure

The component parts of the Valvistor proportional throttle assembly, including the pilot control valve, must be ordered individually. In addition there is a choice of electronics: typically a Vickers Eurocard drive amplifier, alternatively a Vickers 12V DC or 24V DC proportional power plug. The full model code must be specified in all cases.

### Typical Valvistor Component Selection

1 x CVI-\*\*-HFV-20-\*\*-10 insert, see this catalog

1 x CVCS-\*\*-HFV\*\*-2\*-10 cover, see this catalog

1 x cover mounting bolt kit u, see this catalog

1 x KTG4V-3S- - - 60-EN427, see product catalog Slip-in Cartridge.

1 x pilot valve mounting bolt kit, product catalog Valve Catalog.

Plus:

### Drive Electronics for 24V DC System

1 x EEA-PAM-523-A-32 Eurocard amplifier, see catalog 2464

or

1 x EHH-AMP-702-\*-10 proportional power plug, see catalog 2115

### Drive Electronics for 12V DC System

1 x EHH-AMP-712-\*-10 proportional power plug, catalog 2282

# Installation Dimensions in mm (inches)

CVCS-\*\*-HFV\*

3rd angle projection

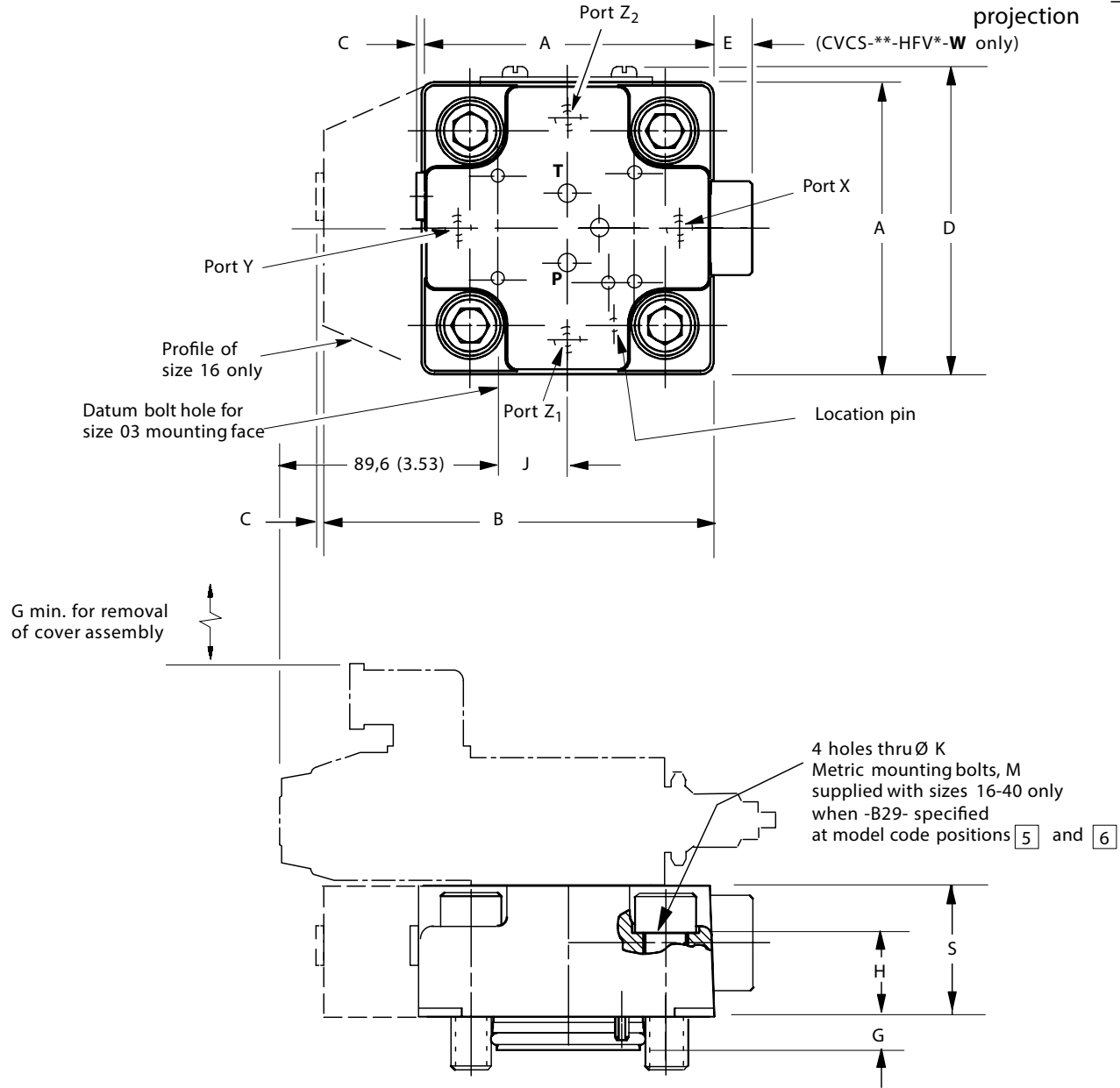
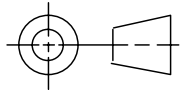

Valve Size	A sq.	B	C max.	D	E max.	G	H	J	Ø K (K dia.)	M Mounting Bolts (supplied)	S
16	66,0 (2.6)	85,5 (3.36)	4,5 (0.18)	68,5 (2.7)	14,5 (0.57)	8,0 (0.32)	36,0 (1.42)	32,50 (1.28)	8,75/9,25 (0.344/0.364)	M8 x 50 cap hd. screw	48,0 (1.89)
25	86,0 (3.38)	- (0.14)	3,5 (3.5)	88,5 (0.53)	13,5 (0.42)	10,5 (0.98)	25,0 (0.82)	20,75	13,75/14,25 (0.541/0.561)	M12 x 40 cap hd. screw	39,0 (1.54)
32	102,5 (4.0)	-	3,5 (0.14)	104,5 (4.2)	13,5 (0.53)	13,0 (0.52)	30,0 (1.18)	21,50 (0.85)	17,75/18,25 (0.699/0.718)	M16 x 55 cap hd. screw	48,0 (1.89)
40	126,0 (5.0)	-	2,0 (0.08)	128,5 (5.1)	11,0 (0.43)	15,0 (0.59)	35,0 (1.38)	21,50 (0.85)	21,75/22,25 (0.856/0.875)	M20 x 60 cap hd. screw	58,0 (2.28)
50	142,5 (5.6)	-	4,5 (0.18)	145,0 (5.7)	0 (0)	18,0 (0.71)	42,0 (1.66)	21,50 (0.85)	21,75/22,25 (0.856/0.875)	-	68,0 (2.68)
63	183,0 (7.2)	-	4,5 (0.18)	185,5 (7.3)	0 (0)	20,0 (0.79)	48,0 (1.89)	21,50 (0.85)	32,75/33,25 (1.289/1.309)	-	83,0 (3.27)

# Valvistor® Line Extension

Proportional Slip-in Cartridge Valve, Flow Control

K(B)TG4V-3 Pilot Stage K(B)FTG4V-3 Pilot Stage

The Vickers® line is now extended with the addition of K(B) TG4V-3 and K(B)FTG4V-3 pilot stage proportional valves. The new features and benefits of the higher performance and on-board electronics (OBE) open up new applications and markets. The valves piloted with K(B)FTG4V-3 offer performance that is close to conventional feedback valves. As its name implies, the Valvistor design has a main poppet valve that amplifies a low flow rate through the pilot circuit, similar to a transistor. This innovative design achieves servo-type control of the main poppet, without using an electrical main poppet position feedback transducer on the Slip-in cartridge valve.



## Features and benefits of the new valves include:

- Integral hydraulic feedback on main stage — Closed loop, main-stage performance is achieved without using a main-stage LVDT.
- Pilot stage selected to meet specific requirements — Cost-effective design results in design flexibility.
- Pilot flow is directed to the load — Higher flow efficiency is achieved since the flow is not wasted to the tank.
- IP65 and IP67 environmental protection rated best in class — More reliable performance in harsh environments.
- On board ramp adjustment on KBTG pilot.

Applications include injection and blow molding, rubber molding, press, die-casting, offshore, civil engineering, marine, primary metal, and mobile applications. The tables below show existing Valvistor configurations and the new extended configurations with K(B) TG4V-3 and K(B)FTG4V-3 as pilot valves.

## High Performance

Pilot Valve Model Code & Part Number	Extended Configuration		Extended Configurations	
	Non-OBE Valve KFTG4V-3-2B13N-Z-M-U-H7-10, 506834		OBE Valve KBFTG4V-3-2B13N-Z-M1-PE7-H7-11, 5996165-001 KBFTG4V-3-2B13N-Z-M2-PE7-H7-11, 5996350-001	
Step Response (ms) Delta P Tested	Open 10 bar	Close 10bar	Open 10bar	Close 10bar
NG16	51	33	35	25
NG25	88	50	50	30
NG32	135	71	70	45
NG40	249	108	130	65
NG50	290	167	170	100
NG63	352	250	200	150
Hysteresis	1%	1%	1%	1%

**Notes:** Valvistor full flow reached at around 70% command input of K(B)F with 13N spool. For M2 version, the command input range is 4-12ma, valve is fully open at 4ma, and fully closed at 12ma.

## Standard Performance

	Extended Configuration		Extended Configurations	
<b>Pilot Valve</b>	<b>Non-OBE Valve</b>		<b>OBE Valve</b>	
<b>Model Code &amp; Part Number</b>	KTG4V-3-2B08N-M-U-H7-60-EN427, 02-398752 Other configurations available. Contact Danfoss		KBTG4V-3-2B08N-M1-PE7-H7-10-EN427, 02-398750 KBTG4V-3-2B08N-M2-PE7-H7-10-EN427, 02-398751	
<b>Step Response (ms)</b>	<b>Open</b>	<b>Close</b>	<b>Open</b>	<b>Close</b>
<b>Delta P Tested</b>	<b>10 bar</b>	<b>10 bar</b>	<b>10 bar</b>	<b>10 bar</b>
NG16	50	40	38	24
NG25	85	60	66	36
NG32	130	85	101	51
NG40	240	130	186	78
NG50	280	200	217	120
NG63	340	300	264	180
Hysteresis	<5	<5	<5	<5

**Notes:** For M2 version, the command input range is 4-12ma, valve is fully open at 4ma, and fully closed at 12ma.

## Economical Solution

	Extended Configuration		Extended Configurations	
<b>Pilot Valve</b>	<b>Non-OBE Valve</b>		<b>OBE Valve</b>	
<b>Model Code &amp; Part Number</b>	KTG4V-3S-2B08N-M-U-H5-60-EN427, 02-154581 Other configurations available. Contact Danfoss		KBTG4V-3S-2B08N-M1-PE7-H5-10-EN427, 02-397168 KBTG4V-3S-2B08N-M2-PE7-H5-10-EN427, 02-398753	
<b>Step Response (ms)</b>	<b>Open</b>	<b>Close</b>	<b>Open</b>	<b>Close</b>
<b>Delta P Tested</b>	<b>10 bar</b>	<b>10 bar</b>	<b>10 bar</b>	<b>10 bar</b>
NG16	50	40	38	24
NG25	85	60	66	36
NG32	130	85	101	51
NG40	240	130	186	78
NG50	280	200	217	120
NG63	340	300	264	180
Hysteresis	<8%	<8%	<8%	<8%

**Notes:** For M2 version, the command input range is 4-12ma, valve is fully open at 4ma, and fully closed at 12ma.

## Released Part Numbers

<b>Model Code</b>	<b>Assembly Number</b>	<b>Model Code</b>	<b>Assembly Number</b>
CVCS-16-HFV1-S2-10	02-311552	F3-CVCS-16-HFV3-W-B29-10	02-358045
CVCS-16-HFV1-W-S2-10	02-312313	F3-CVCS-25-HFV1-W-S2-10	02-333781
CVCS-16-HFV3-B29-10	02-310565	F3-CVCS-25-HFV3-W-B29-10	02-319363
CVCS-16-HFV3-W-B29-10	02-312336	F3-CVCS-32-HFV1-W-S2-10	02-312315
CVCS-25-HFV1-S2-10	02-311553	F3-CVCS-40-HFV1-W-S2-10	02-353592
CVCS-25-HFV1-W-S2-10	02-312312	F3-CVCS-50-HFV1-S2-10	02-325658
CVCS-25-HFV3-B29-10	02-157809	F3-CVCS-50-HFV1-W-S2-10	02-395045
CVCS-25-HFV3-W-B29-10	02-157811		
CVCS-32-HFV1-S2-10	02-311554	CVI-16-HFV-20-A-21-10	02-310564
CVCS-32-HFV1-W-S2-10	02-312310	CVI-16-HFV-20-B-21-10	02-310563
CVCS-32-HFV3-B29-10	02-310641	CVI-25-HFV-20-A-43-10	02-157670
CVCS-32-HFV3-W-B29-10	02-312335	CVI-25-HFV-20-B-32-10	02-157741
CVCS-40-HFV1-S2-10	02-312311	CVI-32-HFV-20-A-63-10	02-310643
CVCS-40-HFV1-W-S2-10	02-312314	CVI-32-HFV-20-B-63-10	02-310642
CVCS-40-HFV3-B29-10	02-157212	CVI-40-HFV-20-A-90-10	02-157234
CVCS-40-HFV3-W-B29-10	02-312121	CVI-40-HFV-20-B-81-10	02-157233
CVCS-50-HFV1-S2-10	02-312103	CVI-50-HFV-20-A-130-10	02-312101
CVCS-50-HFV1-W-S2-10	02-312104	CVI-50-HFV-20-B-130-10	02-312102
CVCS-50-HFV3-B2-10	02-311957	CVI-63-HFV-20-A-216-10	02-311063
CVCS-50-HFV3-W-B2-10	02-311959	CVI-63-HFV-20-B-216-10	02-311062
CVCS-63-HFV1-S2-10	02-312106		
CVCS-63-HFV1-W-S2-10	02-312107		
CVCS-63-HFV3-B2-10	02-311958		
CVCS-63-HFV3-W-B2-10	02-311960		

### Products we offer:

- Cartridge valves
- DCV directional control valves
- Electric converters
- Electric machines
- Electric motors
- Gear motors
- Gear pumps
- Hydraulic integrated circuits (HICs)
- Hydrostatic motors
- Hydrostatic pumps
- Orbital motors
- PLUS+1® controllers
- PLUS+1® displays
- PLUS+1® joysticks and pedals
- PLUS+1® operator interfaces
- PLUS+1® sensors
- PLUS+1® software
- PLUS+1® software services, support and training
- Position controls and sensors
- PVG proportional valves
- Steering components and systems
- Telematics

**Danfoss Power Solutions** is a global manufacturer and supplier of high-quality hydraulic and electric components. We specialize in providing state-of-the-art technology and solutions that excel in the harsh operating conditions of the mobile off-highway market as well as the marine sector. Building on our extensive applications expertise, we work closely with you to ensure exceptional performance for a broad range of applications. We help you and other customers around the world speed up system development, reduce costs and bring vehicles and vessels to market faster.

Danfoss Power Solutions – your strongest partner in mobile hydraulics and mobile electrification.

### Go to [www.danfoss.com](http://www.danfoss.com) for further product information.

We offer you expert worldwide support for ensuring the best possible solutions for outstanding performance. And with an extensive network of Global Service Partners, we also provide you with comprehensive global service for all of our components.

Local address:

### Hydro-Gear

[www.hydro-gear.com](http://www.hydro-gear.com)

### Daikin-Sauer-Danfoss

[www.daikin-sauer-danfoss.com](http://www.daikin-sauer-danfoss.com)

**Danfoss Power Solutions (US) Company**  
2800 East 13th Street  
Ames, IA 50010, USA  
Phone: +1 515 239 6000

**Danfoss Power Solutions GmbH & Co. OHG**  
Krokamp 35  
D-24539 Neumünster, Germany  
Phone: +49 4321 871 0

**Danfoss Power Solutions ApS**  
Nordborgvej 81  
DK-6430 Nordborg, Denmark  
Phone: +45 7488 2222

**Danfoss Power Solutions Trading (Shanghai) Co., Ltd.**  
Building #22, No. 1000 Jin Hai Rd  
Jin Qiao, Pudong New District  
Shanghai, China 201206  
Phone: +86 21 2080 6201