



■ Features :

- Universal AC input / Full range
- Built-in active PFC function, PF>0.94
- High efficiency up to 89%
- Withstand 300VAC surge input for 5 seconds
- Protections: Short circuit / Overload / Over voltage / Over temperature
- Medical safety approved (MOOP level)
- Built-in cooling fan ON-OFF control
- Built-in DC OK signal
- Built-in remote ON-OFF control
- Standby 5V@0.3A
- Built-in remote sense function
- No load power consumption<0.8W (Note.7)
- Current sharing up to 2400W (3+1) (24V,36V,48V)
- 5 years warranty



■ GTIN CODE

MW Search: <https://www.meanwell.com/serviceGTIN.aspx>



SPECIFICATION

MODEL	MSP-600-3.3	MSP-600-5	MSP-600-7.5	MSP-600-12	MSP-600-15	MSP-600-24	MSP-600-36	MSP-600-48		
OUTPUT	DC VOLTAGE	3.3V	5V	7.5V	12V	15V	24V	36V	48V	
	RATED CURRENT	120A	120A	80A	53A	43A	27A	17.5A	13A	
	CURRENT RANGE	0 ~ 120A	0 ~ 120A	0 ~ 80A	0 ~ 53A	0 ~ 43A	0 ~ 27A	0 ~ 17.5A	0 ~ 13A	
	RATED POWER	396W	600W	600W	636W	645W	648W	630W	624W	
	RIPPLE & NOISE (max.) Note.2	120mVp-p	150mVp-p	150mVp-p	150mVp-p	150mVp-p	150mVp-p	200mVp-p	240mVp-p	
	VOLTAGE ADJ. RANGE	2.8 ~ 3.8V	4.3 ~ 5.8V	6.8 ~ 9V	10.2 ~ 13.8V	13.5 ~ 18V	21.6 ~ 28.8V	28.8 ~ 39.6V	40.8 ~ 55.2V	
	VOLTAGE TOLERANCE Note.3	±2.0%	±2.0%	±2.0%	±1.0%	±1.0%	±1.0%	±1.0%	±1.0%	
	LINE REGULATION	±0.5%	±0.5%	±0.5%	±0.3%	±0.3%	±0.2%	±0.2%	±0.2%	
	LOAD REGULATION	±1.0%	±1.0%	±1.0%	±0.5%	±0.5%	±0.5%	±0.5%	±0.5%	
	SETUP, RISE TIME	1000ms, 50ms/230VAC 250ms, 50ms/115VAC at full load								
HOLD UP TIME (Typ.)	16ms/230VAC 16ms/115VAC at full load									
INPUT	VOLTAGE RANGE Note.5	85 ~ 264VAC		120 ~ 370VDC						
	FREQUENCY RANGE	47 ~ 63Hz								
	POWER FACTOR (Typ.)	PF>0.93/230VAC		PF>0.99/115VAC at full load						
	EFFICIENCY (Typ.)	78.5%	82%	86%	88%	88%	88%	89%	89%	
	AC CURRENT (Typ.)	8.5A/115VAC		5A/230VAC						
	INRUSH CURRENT (Typ.)	35A/115VAC		80A/230VAC						
LEAKAGE CURRENT	Earth leakage current < 300µA/264VAC , Touch leakage current < 100µA/264VAC									
PROTECTION	OVERLOAD	105 ~ 135% rated output power Protection type : Constant current limiting, recovers automatically after fault condition is removed								
	OVER VOLTAGE	3.96 ~ 4.62V	6 ~ 7V	9.4 ~ 10.9V	14.4 ~ 16.8V	18.8 ~ 21.8V	30 ~ 34.8V	41.4 ~ 48.6V	57.6 ~ 67.2V	
	OVER TEMPERATURE	Shut down o/p voltage, recovers automatically after temperature goes down								
FUNCTION	5V STANDBY	5VSB : 5V@0.3A ; tolerance ±5%, ripple : 50mVp-p(max.)								
	DC OK SIGNAL	PSU turn on : 3.3 ~ 5.6V ; PSU turn off : 0 ~ 1V								
	REMOTE CONTROL	RC+ / RC- : 4 ~ 10V or open = power on ; 0 ~ 0.8V or short = power off								
FAN CONTROL (Typ.)	Load 35 ± 15% or RTH2 ≥ 50°C Fan on									
ENVIRONMENT	WORKING TEMP.	-40 ~ +70°C (Refer to "Derating Curve")								
	WORKING HUMIDITY	20 ~ 90% RH non-condensing								
	STORAGE TEMP., HUMIDITY	-40 ~ +85°C, 10 ~ 95% RH non-condensing								
	TEMP. COEFFICIENT	±0.03%/°C (0 ~ 50°C)								
	VIBRATION	10 ~ 500Hz, 5G 10min./1cycle, 60min. each along X, Y, Z axes								
SAFETY & EMC (Note 4)	SAFETY STANDARDS	ANSI/AAMI ES60601-1, IEC60601-1, EAC TP TC 004 approved; Design refer to BS EN/EN60601-1, BS EN/EN62368-1								
	ISOLATION LEVEL	Primary-Secondary: 2xMOOP, Primary-Earth: 1xMOOP, Secondary-Earth: 1xMOOP								
	WITHSTAND VOLTAGE	I/P-O/P:4KVAC I/P-FG:2KVAC O/P-FG:0.5KVAC								
	ISOLATION RESISTANCE	I/P-O/P, I/P-FG, O/P-FG:100M Ohms / 500VDC / 25°C / 70% RH								
	EMC EMISSION	Compliance to BS EN/EN55011 (CISPR11) Class B, BS EN/EN61000-3-2,-3, EAC TP TC 020								
EMC IMMUNITY	Compliance to BS EN/EN61000-4-2,3,4,5,6,8,11, BS EN/EN60601-1-2, BS EN/EN55035, EAC TP TC 020									
OTHERS	MTBF	1126.7K hrs min. Telcordia SR-332 (Bellcore) ; 138.7K hrs min. MIL-HDBK-217F (25°C)								
	DIMENSION	218*105*63.5mm (L*W*H)								
	PACKING	1.57Kg;8pcs/13.6Kg/1.34CUFT								

NOTE

1. All parameters NOT specially mentioned are measured at 230VAC input, rated load and 25°C of ambient temperature.
2. Ripple & noise are measured at 20MHz of bandwidth by using a 12" twisted pair-wire terminated with a 0.1µf & 47µf parallel capacitor.
3. Tolerance : includes set up tolerance, line regulation and load regulation.
4. The power supply is considered a component which will be installed into a final equipment. All the EMC tests are been executed by mounting the unit on a 360mm*360mm metal plate with 1mm of thickness. The final equipment must be re-confirmed that it still meets EMC directives. For guidance on how to perform these EMC tests, please refer to "EMI testing of component power supplies." (as available on https://www.meanwell.com/Upload/PDF/EMI_statement_en.pdf)
5. Derating may be needed under low input voltages. Please check the derating curve for more details.
6. Length of set up time is measured at first cold start. Turning ON/OFF the power supply may lead to increase of the set up time.
7. No load power consumption<0.8W when RC+ & RC- (CN100 pin3,4) 0 ~ 0.8V or short.
8. When the input voltage is less than 40VAC, the SPS may exhibit degradation of performance. The final product manufacturers must re-confirm this deviation that does not affect basic safety or essential performance.
9. The ambient temperature derating of 3.5°C/1000m with fanless models and of 5°C/1000m with fan models for operating altitude higher than 2000m(6500ft).

※ Product Liability Disclaimer : For detailed information, please refer to <https://www.meanwell.com/serviceDisclaimer.aspx>

Mechanical Specification

Case No. 977A Unit:mm

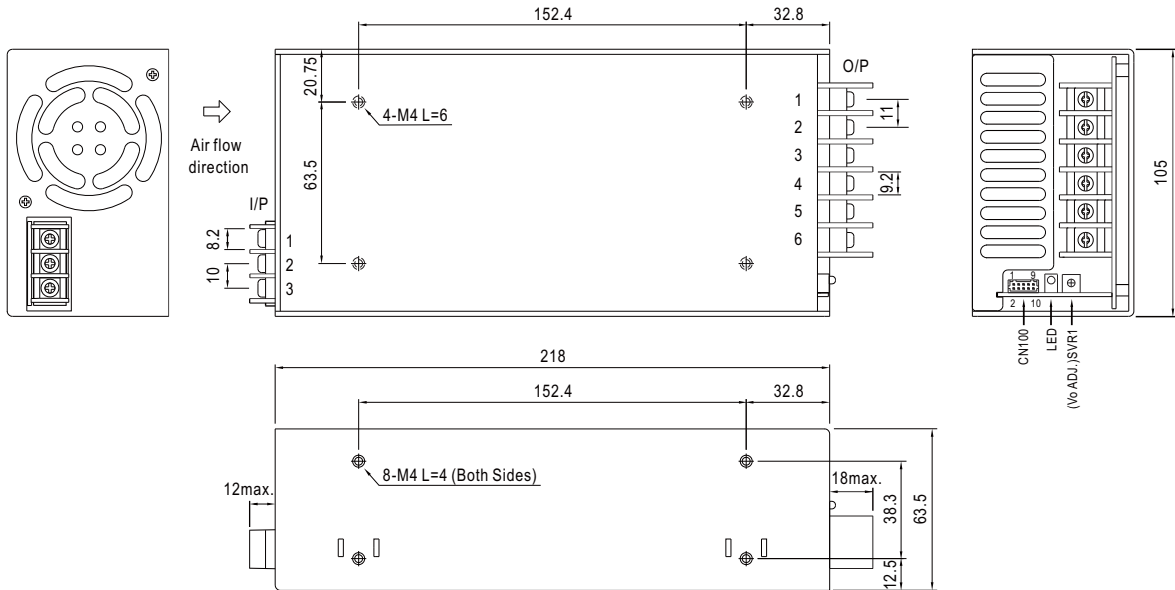

AC Input Terminal Pin No. Assignment

Pin No.	Assignment
1	AC/L
2	AC/N
3	FG \perp

DC Output Terminal Pin No. Assignment

Pin No.	Assignment
1~3	-V
4~6	+V

Connector Pin No. Assignment (CN100) : HRS DF11-10DP-2DS or equivalent

Pin No.	Assignment	Pin No.	Assignment	Mating Housing	Terminal
1	AUXG	6,8	GND	HRS DF11-10DS or equivalent	HRS DF11-**SC or equivalent
2	AUX	7	DC-OK		
3	RC+	9	+S		
4	RC-	10	-S		
5	CS				

Block Diagram

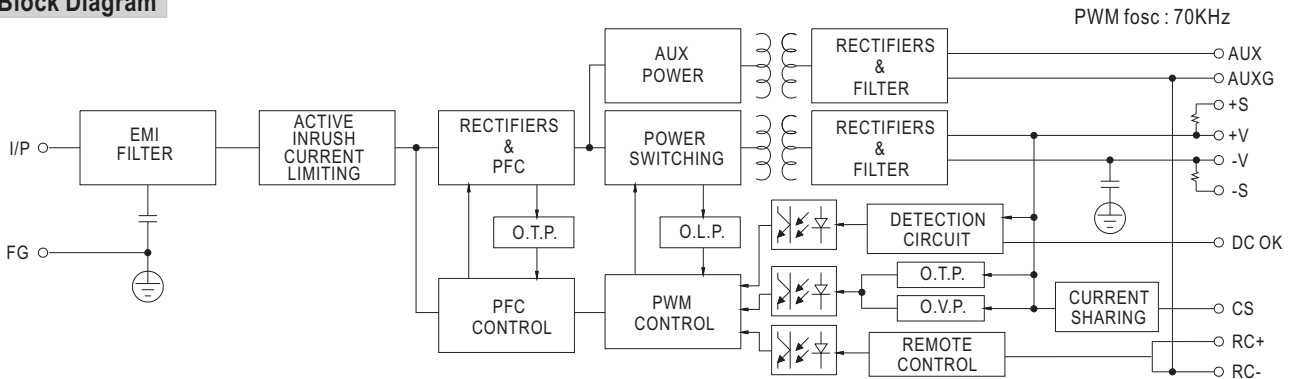

Derating Curve

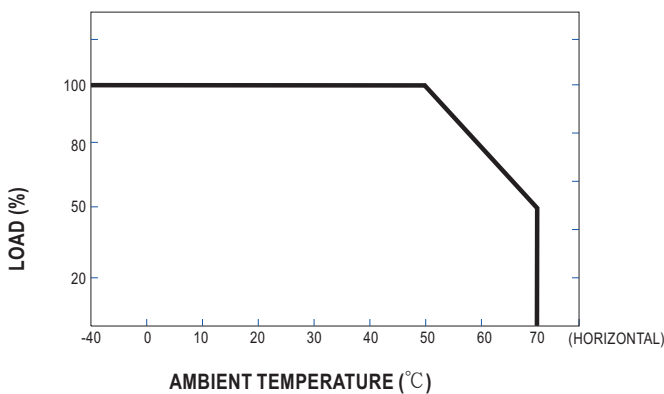

Output Derating VS Input Voltage

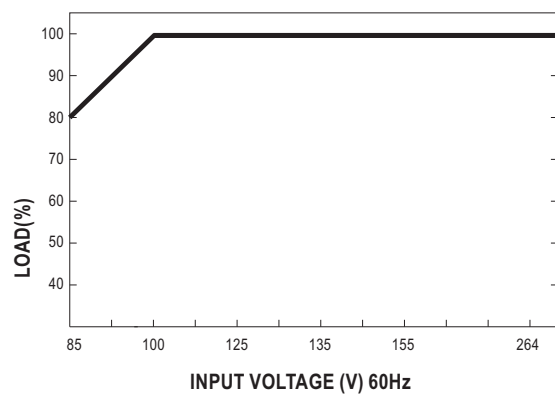

■ Function Description of CN100

Pin No.	Function	Description
1	AUXG	Auxiliary voltage output ground. The signal return is isolated from the output terminals (+V & -V).
2	AUX	Auxiliary voltage output, 4.75~5.25V, referenced to pin 1(AUXG). The maximum load current is 0.3A. This output is not controlled by the "remote ON/OFF control".
3	RC+	Turns the output on and off by electrical or dry contact between pin 4 (RC-), Short: Power OFF, Open: Power ON.
4	RC-	Remote control ground.
5	CS	Current sharing signal. When units are connected in parallel, the CS pins of the units should be connected to allow current balance between units.
6,8	GND	This pin connects to the negative terminal(-V). Return for DC-OK signal output.
7	DC-OK	DC-OK signal is a TTL level signal, referenced to pin8(DC-OK GND). High when PSU turns on.
9	+S	Positive sensing. The +S signal should be connected to the positive terminal of the load. The +S and -S leads should be twisted in pair to minimize noise pick-up effect. The maximum line drop compensation is 0.5V.
10	-S	Negative sensing. The -S signal should be connected to the negative terminal of the load. The -S and +S leads should be twisted in pair to minimize noise pick-up effect. The maximum line drop compensation is 0.5V.

■ Function Manual

1. Remote Sense

The remote sensing compensates voltage drop on the load wiring up to 0.5V.

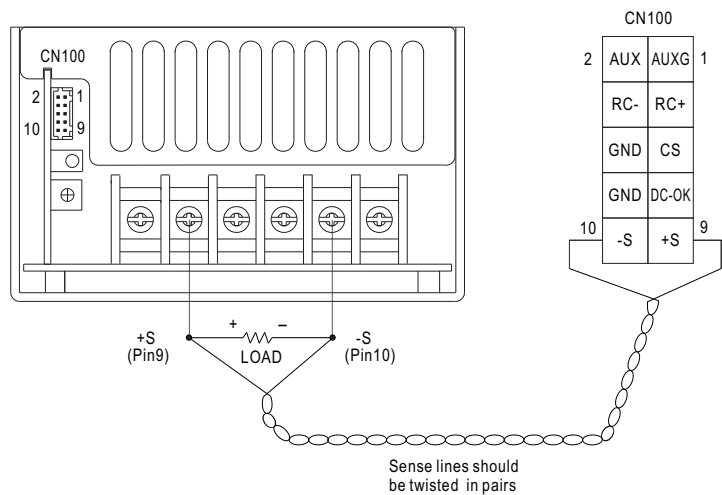

Fig 1.1

2. DC-OK Signal

DC-OK signal is a TTL level signal. High when PSU turns on.

Between DC-OK(pin7) and GND(pin6,8)	Output Status
3.3 ~ 5.6V	ON
0 ~ 1V	OFF

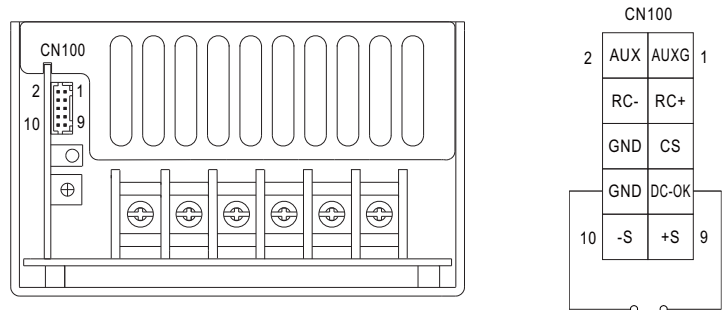

Fig 2.1

3.Remote Control

The PSU can be turned ON/OFF by using the "Remote Control" function.

Between RC+(pin3) and RC-(pin4)	Output Status
SW ON (Short)	OFF
SW OFF (Open)	ON

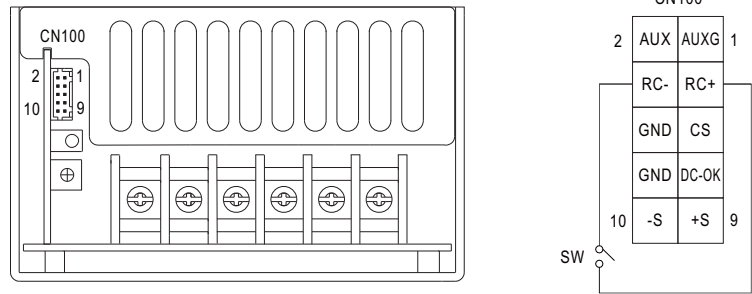

Fig 3.1

4.Current Sharing with Remote Sensing (Only for 24V, 36V and 48V)

MSP-600 has the built-in active current sharing function and can be connected in parallel to provide higher output power :

- (1)Parallel operation is available by connecting the units shown as below.
(+S,-S,CS and GND are connected mutually in parallel).
- (2)Difference of output voltages among parallel units should be less than 2%.
- (3)The total output current must not exceed the value determined by the following equation.
(output current at parallel operation)=(Rated current per unit)×(Number of unit)×0.9
- (4)In parallel operation 4 units is the maximum, please consult the manufacturer for applications of more connecting in parallel.
- (5)The power supplies should be paralleled using short and large diameter wiring and then connected to the load.

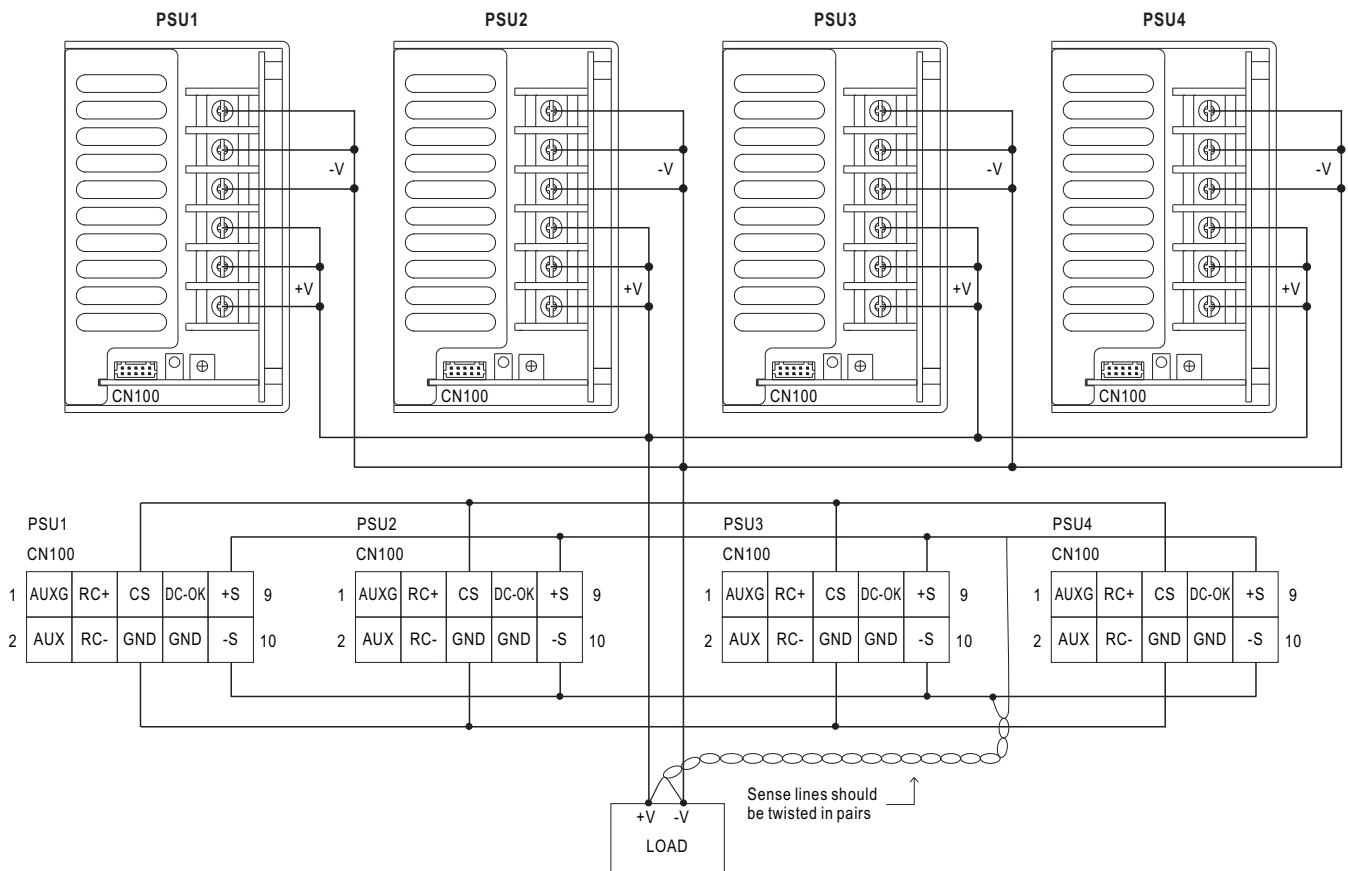

Fig 4.1

Note : 1. In parallel connection, maybe only one unit (master) operate if the total output load is less than 2% of rated load condition.
The other PSU (slave) may go into standby mode and its output LED and relay will not turn on.
2.2% min. of dummy load is required.