



■ Features

- Constant Current mode output
- Plastic housing with Class II design
- Built-in active PFC function
- IP67 rating for indoor or outdoor installations
- Class 2 power unit
- Function: 3 in 1 dimming
- Typical lifetime > 50000 hours
- 5 years warranty

■ Applications

- LED panel lighting
- LED flood lighting
- Indoor LED lighting
- High bay lighting
- Type "HL" for use in Class I, Division 2 hazardous (Classified) location

■ Description

LPFH-60D series is a 60W AC/DC LED driver featuring the constant current output. LPFH-60D operates from 200~400VAC and offers models with different rated voltage ranging between 12V and 54V. Thanks to the high efficiency up to 90%, with the fanless design, the entire series is able to operate for -40°C~ +90°C case temperature under free air convection. The entire series is rated with IP67 ingress protection level and is suitable to work for a variety of applications at dry or damp locations. LPFH-60D is equipped with the 3 in 1 dimming function so as to provide the optimal design flexibility for LED lighting system.

■ Model Encoding

LPFH - 60 D - 24

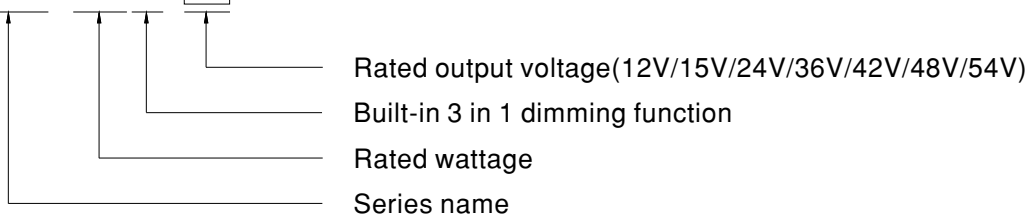



SPECIFICATION

MODEL		LPFH-60D-12	LPFH-60D-15	LPFH-60D-24	LPFH-60D-36	LPFH-60D-42	LPFH-60D-48	LPFH-60D-54
OUTPUT	DC VOLTAGE	12V	15V	24V	36V	42V	48V	54V
	RATED CURRENT	5A	4A	2.5A	1.67A	1.43A	1.25A	1.12A
	RATED POWER <small>Note.5</small>	60W	60W	60W	60.12W	60.06W	60W	60.48W
	CONSTANT CURRENT REGION <small>Note.2</small>	7.2 ~12V	9 ~ 15V	14.4 ~ 24V	21.6 ~ 36V	25.2 ~ 42V	28.8 ~ 48V	32.4 ~ 54V
	CURRENT RIPPLE	5.0% max. @rated current						
	CURRENT TOLERANCE	±5.0%						
	SETUP TIME <small>Note.6</small>	700ms / 230VAC,277VAC; 500ms / 347VAC						
INPUT	VOLTAGE RANGE	200 ~ 400VAC 282 ~ 565VDC (Please refer to "STATIC CHARACTERISTIC" section)						
	FREQUENCY RANGE	47 ~ 63Hz						
	POWER FACTOR (Typ.)	PF ≥ 0.95/230VAC, 277VAC, PF ≥ 0.92/347VAC@full load (Please refer to "POWER FACTOR (PF) CHARACTERISTIC" section)						
	TOTAL HARMONIC DISTORTION	THD < 20% (@load ≥ 60%/230VAC, 277VAC; @load ≥ 75%/347VAC) (Please refer to "TOTAL HARMONIC DISTORTION(THD)" section)						
	EFFICIENCY (Typ.)	86%	87%	89%	90%	90%	90%	90%
	AC CURRENT (Typ.)	0.4A / 230VAC,277VAC 0.32A / 347VAC						
	INRUSH CURRENT (Typ.)	COLD START 40A(twidth=550µs measured at 50% Ipeak) at 347VAC; Per NEMA 410						
	MAX. No. of PSUs on 16A CIRCUIT BREAKER	7 units (circuit breaker of type B) / 12 units (circuit breaker of type C) at 347VAC						
	LEAKAGE CURRENT	<0.75mA / 347VAC						
PROTECTION	SHORT CIRCUIT	Hiccup mode, recovers automatically after fault condition is removed.						
	OVER VOLTAGE	15 ~ 17V	17.5 ~ 21V	28 ~ 35V	41 ~ 49V	46 ~ 54V	54 ~ 63V	59 ~ 66V
	OVER TEMPERATURE	Shut down o/p voltage, auto-recovery or re-power on to recovery						
ENVIRONMENT	WORKING TEMP.	Tcase=-40 ~ +90°C (Please refer to " OUTPUT LOAD vs TEMPERATURE" section)						
	MAX. CASE TEMP.	Tcase=+90°C						
	WORKING HUMIDITY	20 ~ 95% RH non-condensing						
	STORAGE TEMP., HUMIDITY	-40 ~ +90°C, 10 ~ 95% RH						
	TEMP. COEFFICIENT	±0.03%/°C (0 ~ 50°C)						
	VIBRATION	10 ~ 500Hz, 5G 12min./1cycle, period for 72min. each along X, Y, Z axes						
SAFETY & EMC	SAFETY STANDARDS	UL8750(type"HL"), CSA C22.2 No. 250.0-08, EAC TP TC 004, IP67 approved						
	WITHSTAND VOLTAGE	I/P-O/P:3.0KVAC						
	ISOLATION RESISTANCE	I/P-O/P:100M Ohms / 500VDC / 25°C/ 70% RH						
	EMC EMISSION	Compliance to FCC part 15 Subpart B (@load ≥ 60%),EAC TP TC 020						
	EMC IMMUNITY	Compliance to IEC61000-4-2,4,5; light industry level (surge immunity : Line-Line:2KV),EAC TP TC 020						
OTHERS	MTBF	1267.7K hrs min. Telcordia SR-332 (Bellcore) ; 343.9Khrs min. MIL-HDBK-217F (25°C)						
	DIMENSION	162.5*43*32mm (L*W*H)						
	PACKING	0.45Kg; 32pcs / 15.4Kg / 0.93CUFT						
NOTE	<ol style="list-style-type: none"> All parameters NOT specially mentioned are measured at 230VAC input, rated current and 25°C of ambient temperature. Please refer to "DRIVING METHODS OF LED MODULE". Ripple & noise are measured at 20MHz of bandwidth by using a 12" twisted pair-wire terminated with a 0.1uf & 47uf parallel capacitor. Tolerance : includes set up tolerance, line regulation and load regulation. Length of set up time is measured at first cold start. Turning ON/OFF the driver may lead to increase of the set up time. The driver is considered as a component that will be operated in combination with final equipment. Since EMC performance will be affected by the complete installation, the final equipment manufacturers must re-qualify EMC Directive on the complete installation again. This series meets the typical life expectancy of >50,000 hours of operation when Tcase, particularly (Ⓒ) point (or TMP, per DLC), is about 70°C or less. Please refer to the warranty statement on MEAN WELL's website at http://www.meanwell.com 							

■ **Block Diagram**

PFC fosc : 50~120KHz
 PWM fosc : 60~130KHz

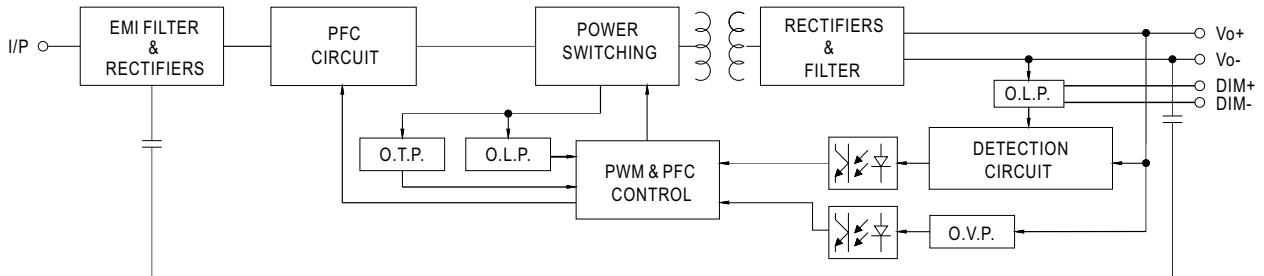

■ **DRIVING METHODS OF LED MODULE**

※ This series works in constant current mode to directly drive the LEDs.

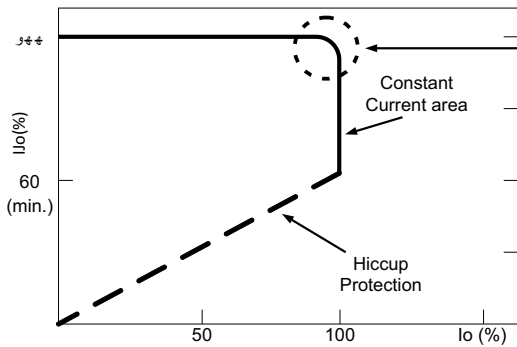

Typical LED power supply I-V curve

In the constant current region, the highest voltage at the output of the driver depends on the configuration of the end systems.

Should there be any compatibility issues, please contact MEAN WELL.

■ DIMMING OPERATION

※ 3 in 1 dimming function



- Output constant current level can be adjusted by applying one of the three methodologies between DIM+ and DIM-: 1 ~ 10VDC, or 10V PWM signal or resistance.
- Direct connecting to LEDs is suggested. It is not suitable to be used with additional drivers.
- Dimming source current from power supply: 100 μ A (typ.)

◎ Applying additive 1 ~ 10VDC

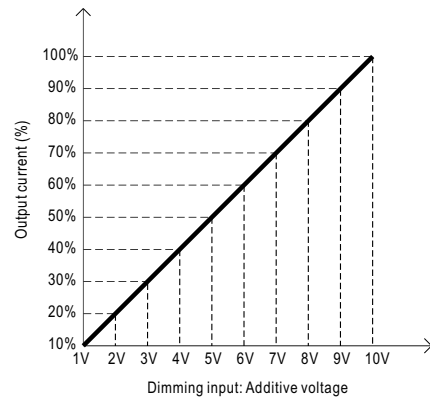
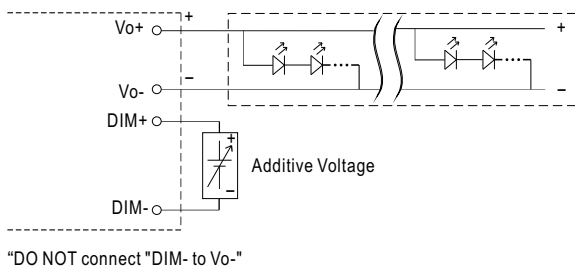

◎ Applying additive 10V PWM signal (frequency range 100Hz ~ 3KHz):

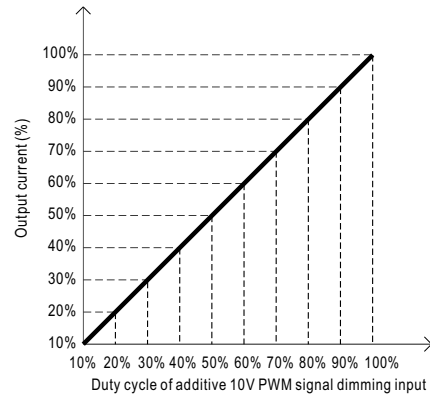

◎ Applying additive resistance:

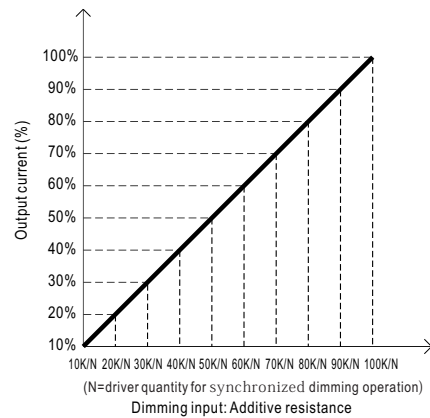

Note: In the case of turning the lighting fixture down to 0% brightness, please refer to the configuration as follow, or please contact MEAN WELL for other options.

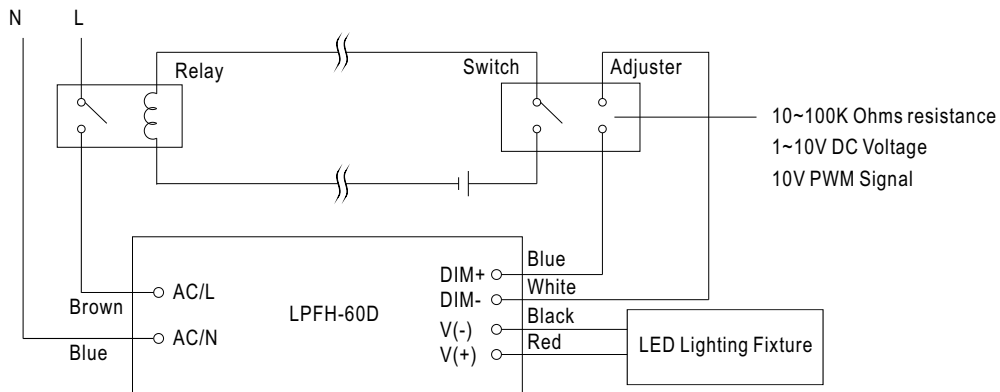

Using a switch and relay can turn ON/OFF the lighting fixture.

1. Output constant current level can be adjusted through output cable by connecting a resistor or 1~10Vdc or 10V PWM signal between DIM+ and DIM-.
2. The LED lighting fixture can be turned ON/OFF by the switch.

OUTPUT LOAD vs TEMPERATURE

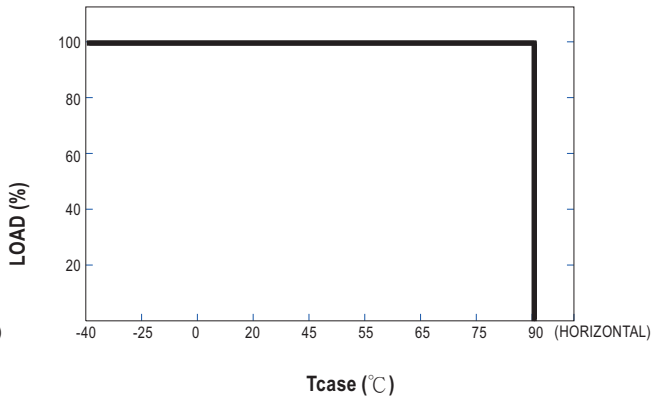
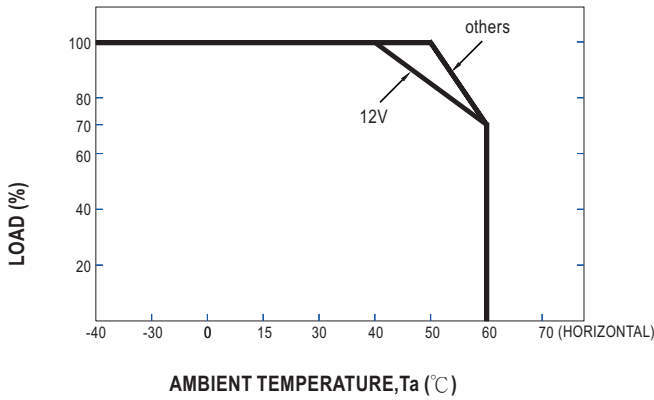

STATIC CHARACTERISTIC

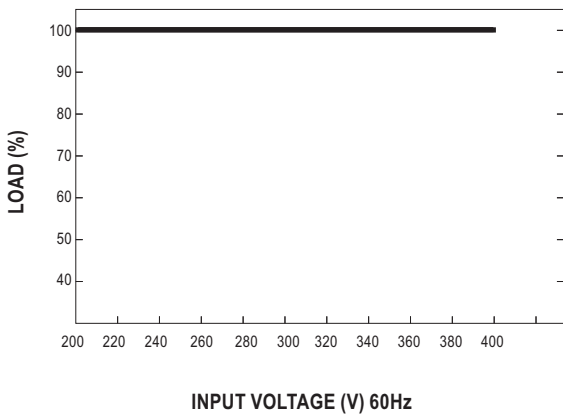

※ De-rating is needed under low input voltage.

POWER FACTOR (PF) CHARACTERISTIC

※ T_{case} at 80°C

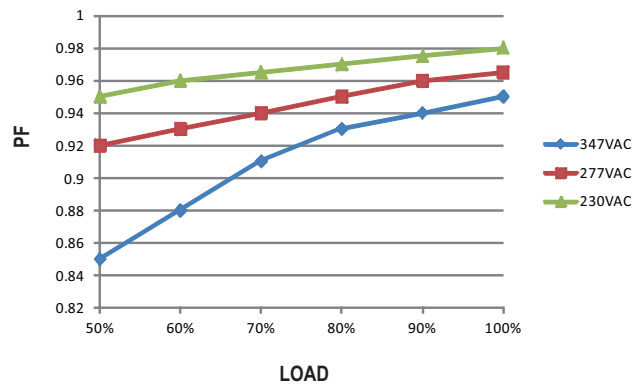

TOTAL HARMONIC DISTORTION (THD)

※ 54V Model, T_{case} at 80°C

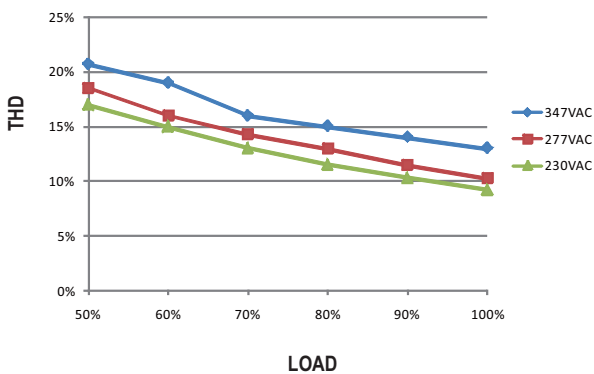

EFFICIENCY vs LOAD

LPFH-60D series possess superior working efficiency that up to 90% can be reached in field applications.

※ 54V Model, T_{case} at 80°C

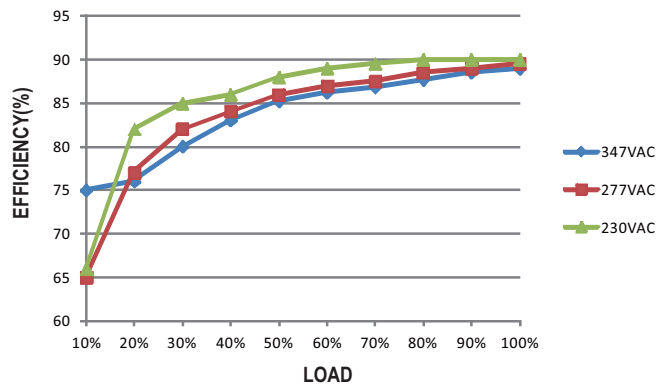

■ LIFE TIME

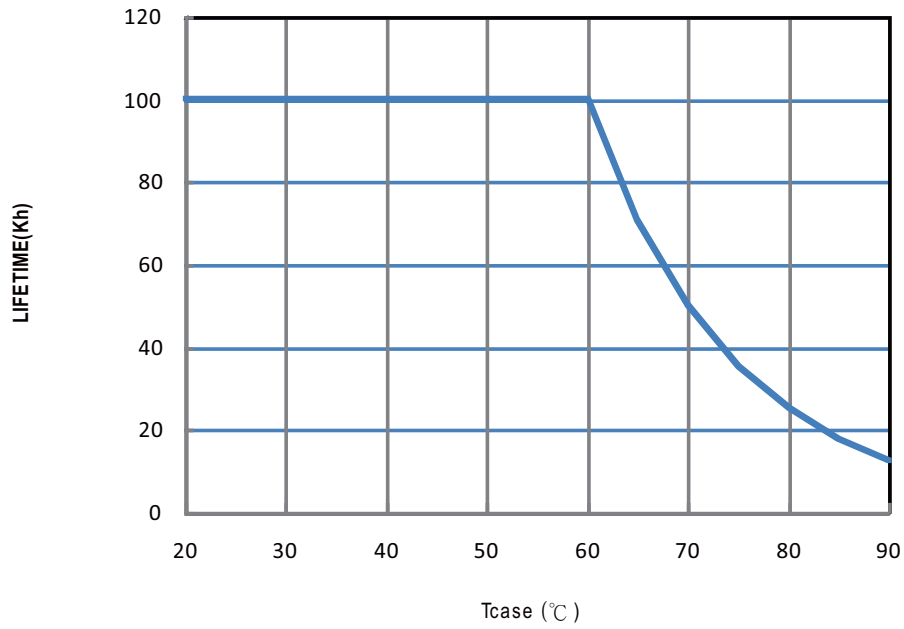

MECHANICAL SPECIFICATION

Case No. LPF-60 Unit:mm

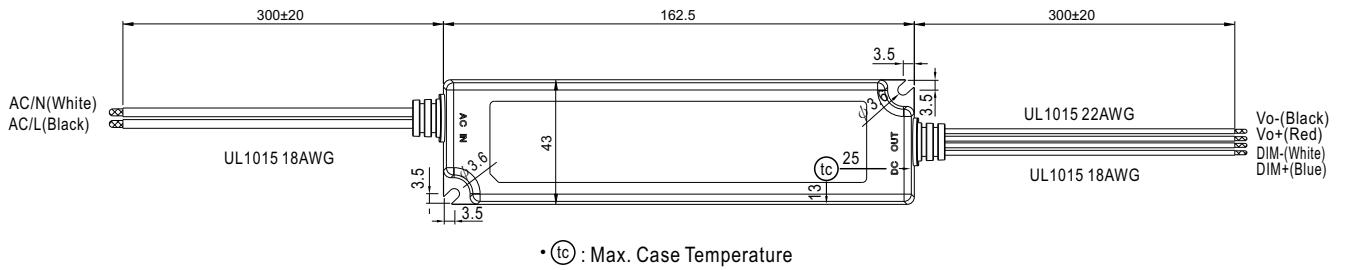

Recommend Mounting Direction

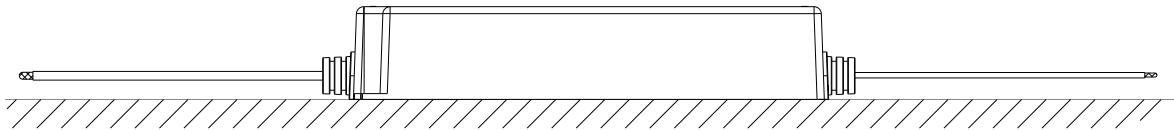

INSTALLATION MANUAL

Please refer to : <http://www.meanwell.com/manual.html>