



■ Features

- Constant Voltage + Constant Current mode output
- Metal housing design with functional Ground
- Built-in active PFC function
- No load / Standby power consumption <0.5W
- Suitable for use in Dry, Damp and Wet Locations
- Function options: output adjustable via potentiometer;
3 in 1 dimming (dim-to-off)
- Typical lifetime >50000 hours
- 5 years warranty

■ Applications

- LED street lighting
- LED architectural lighting
- LED bay lighting
- LED floodlighting
- Type “HL” for use in Class I, Division 2 hazardous (Classified) location.

■ GTIN CODE

MW Search: <https://www.meanwell.com/serviceGTIN.aspx>

■ Model Encoding

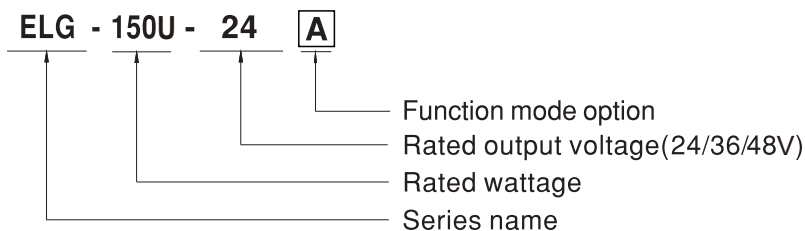

Type	Function	Note
Blank	Io and Vo fixed.	By Request
A	Io and Vo adjustable through built-in potentiometer.	By Request
B	3 in 1 dimming function (0~10Vdc, 10V PWM signal and resistance)	By Request

SPECIFICATION

MODEL	ELG-150U-24□	ELG-150U-36□	ELG-150U-48□	
OUTPUT	DC VOLTAGE	24V	36V	48V
	CONSTANT CURRENT REGION <small>Note.2</small>	12 ~ 24V	18 ~ 36V	24 ~ 48V
	RATED CURRENT	6.25A	4.17A	3.13A
	RATED POWER	150W	150.1W	150.2W
	RIPPLE & NOISE (max.) <small>Note.3</small>	200mVp-p	250mVp-p	250mVp-p
	VOLTAGE ADJ. RANGE	Adjustable for A-Type only (via the built-in potentiometer)		
		21.6 ~ 26.4V	32.4 ~ 39.6V	43.2 ~ 52.8V
	CURRENT ADJ. RANGE	Adjustable for A-Type only (via the built-in potentiometer)		
		3.2 ~ 6.25A	2.1 ~ 4.17A	1.56 ~ 3.13A
	VOLTAGE TOLERANCE <small>Note.4</small>	±3.0%	±2.5%	±2.0%
	LINE REGULATION	±0.5%	±0.5%	±0.5%
LOAD REGULATION	±1.0%	±1.0%	±0.5%	
SETUP, RISE TIME <small>Note.6</small>	1600ms, 80ms/120VAC 500ms, 100ms/230VAC			
HOLD UP TIME (Typ.)	10ms/120VAC, 230VAC			
INPUT	VOLTAGE RANGE <small>Note.5</small>	100 ~ 305VAC 142 ~ 431VDC (Please refer to "STATIC CHARACTERISTIC" section)		
	FREQUENCY RANGE	47 ~ 63Hz		
	POWER FACTOR	PF ≥ 0.97/120VAC, PF ≥ 0.95/230VAC, PF ≥ 0.92/277VAC@full load (Please refer to "POWER FACTOR (PF) CHARACTERISTIC" section)		
	TOTAL HARMONIC DISTORTION	THD < 20% (@load ≥ 50%/120VAC; @load ≥ 60%/230VAC; @load ≥ 75%/277VAC) (Please refer to TOTAL HARMONIC DISTORTION(THD) section)		
	EFFICIENCY (Typ.)	89%	90%	90%
	AC CURRENT	1.7A / 120VAC 0.9A / 230VAC 0.7A/277VAC		
	INRUSH CURRENT(Typ.)	COLD START 65A(twidth=1ms measured at 10% Ipeak) at 277VAC; Per NEMA 410		
	LEAKAGE CURRENT	<0.75mA / 277VAC		
NO LOAD / STANDBY POWER CONSUMPTION	<0.5W			
PROTECTION	OVER CURRENT	95 ~ 108% Constant current limiting, recovers automatically after fault condition is removed		
	SHORT CIRCUIT	Hiccup mode, recovers automatically after fault condition is removed		
	OVER VOLTAGE	28 ~ 34V	41 ~ 48V	54 ~ 62V
	OVER TEMPERATURE	Shut down output voltage, re-power on to recover		
ENVIRONMENT	WORKING TEMP.	Tcase=-40 ~ +85°C (Please refer to OUTPUT LOAD vs TEMPERATURE section)		
	MAX. CASE TEMP.	Tcase=+85°C		
	WORKING HUMIDITY	20 ~ 95% RH non-condensing		
	STORAGE TEMP., HUMIDITY	-40 ~ +80°C, 10 ~ 95% RH		
	TEMP. COEFFICIENT	±0.03%/°C (0 ~ 60°C)		
VIBRATION	10 ~ 500Hz, 5G 12min./1cycle, period for 72min. each along X, Y, Z axes			
SAFETY & EMC	SAFETY STANDARDS	Design refer to UL8750 (type"HL"), CSA C22.22 No.250.13-12		
	WITHSTAND VOLTAGE	I/P-O/P:3.75KVAC I/P-FG:2.0KVAC O/P-FG:1.5KVAC		
	ISOLATION RESISTANCE	I/P-O/P, I/P-FG, O/P-FG:100M Ohms / 500VDC / 25°C / 70% RH		
	EMC EMISSION	Design refer to FCC part 15 class A		
EMC IMMUNITY	Design refer to IEC61000-4-2,3,4,5,6,8,11;EN61547,light industry level			
OTHERS	MTBF	2554.5K hrs min. Telcordia SR-332 (Bellcore) 252.4Khrs min. MIL-HDBK-217F (25°C)		
	DIMENSION	219*63*35.5mm (L*W*H)		
	PACKING	0.95Kg ; 16pcs/16.0kg/0.77CUFT		
NOTE	1. All parameters NOT specially mentioned are measured at 230VAC input, rated current and 25°C of ambient temperature. 2. Please refer to "DRIVING METHODS OF LED MODULE". 3. Ripple & noise are measured at 20MHz of bandwidth by using a 12" twisted pair-wire terminated with a 0.1uf & 47uf parallel capacitor. 4. Tolerance : includes set up tolerance, line regulation and load regulation. 5. De-rating may be needed under low input voltages. Please refer to "STATIC CHARACTERISTICS" sections for details. 6. Length of set up time is measured at first cold start. Turning ON/OFF the driver may lead to increase of the set up time. 7. The driver is considered as a component that will be operated in combination with final equipment. Since EMC performance will be affected by the complete installation, the final equipment manufacturers must re-qualify EMC Directive on the complete installation again. 8. This series meets the typical life expectancy of >50,000 hours of operation when Tcase, particularly (Tc) point (or TMP, per DLC), is about 75°C or less. 9. Please refer to the warranty statement on MEAN WELL's website at http://www.meanwell.com			

Block Diagram

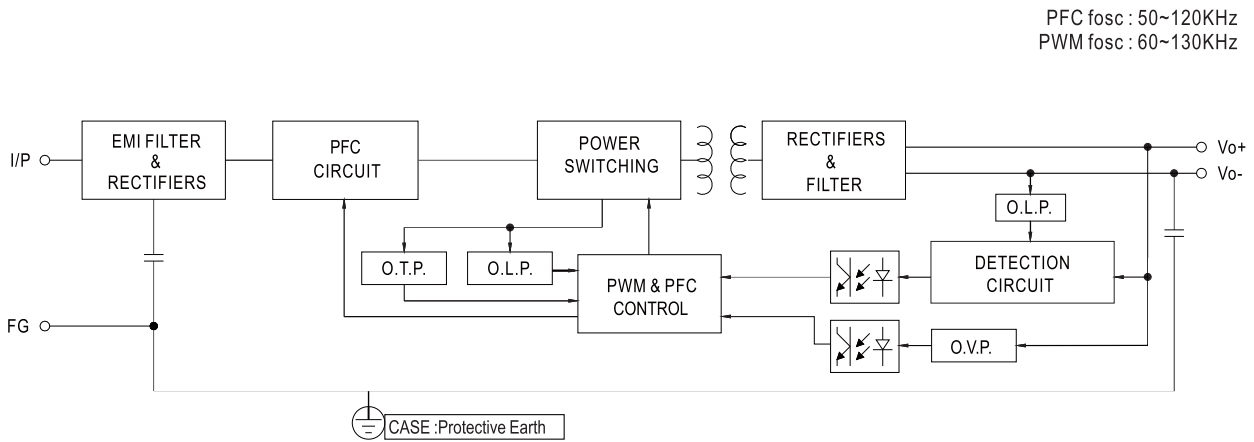

DRIVING METHODS OF LED MODULE

※ This series is able to work in either Constant Current mode (a direct drive way) or Constant Voltage mode (usually through additional DC/DC driver) to drive the LEDs.

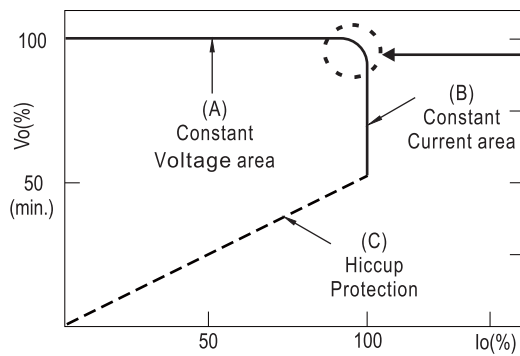

Typical output current normalized by rated current (%)

In the constant current region, the highest voltage at the output of the driver depends on the configuration of the end systems.

Should there be any compatibility issues, please contact MEAN WELL.

DIMMING OPERATION

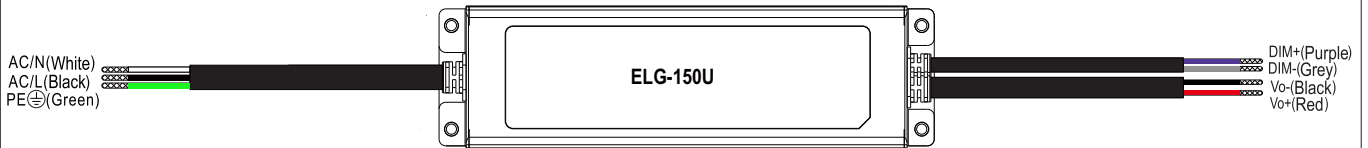

※ 3 in 1 dimming function (for B-Type)

- Output constant current level can be adjusted by applying one of the three methodologies between DIM+ and DIM-: 0 ~ 10VDC, or 10V PWM signal or resistance.
- Direct connecting to LEDs is suggested. It is not suitable to be used with additional drivers.
- Dimming source current from power supply: 100 μ A (typ.)

◎ Applying additive 0 ~ 10VDC

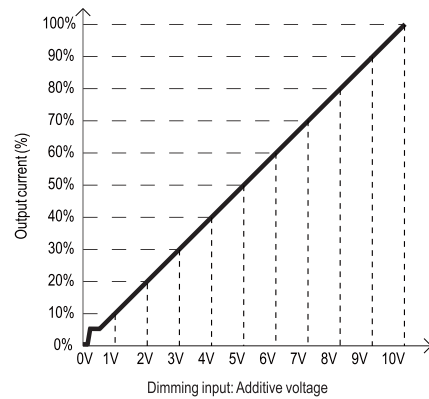
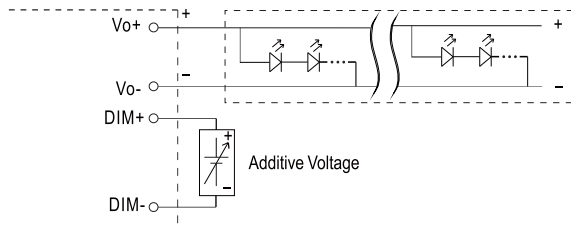

◎ Applying additive 10V PWM signal (frequency range 100Hz ~ 3KHz):

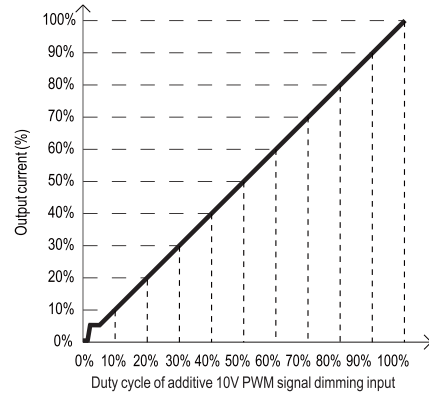
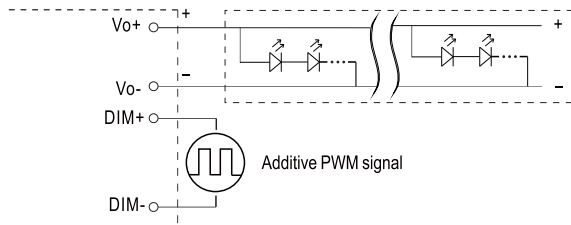

◎ Applying additive resistance:

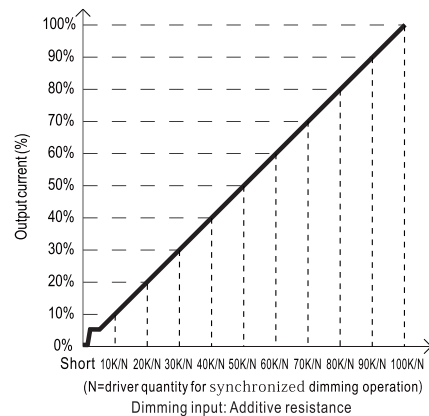
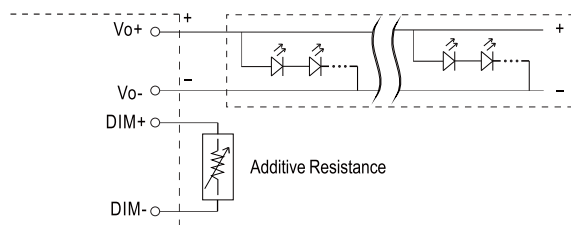

Note : 1. Min. dimming level is about 8% and the output current is not defined when $0\% < I_{out} < 8\%$.
 2. The output current could drop down to 0% when dimming input is about 0k Ω or 0Vdc, or 10V PWM signal with 0% duty cycle.

OUTPUT LOAD vs TEMPERATURE

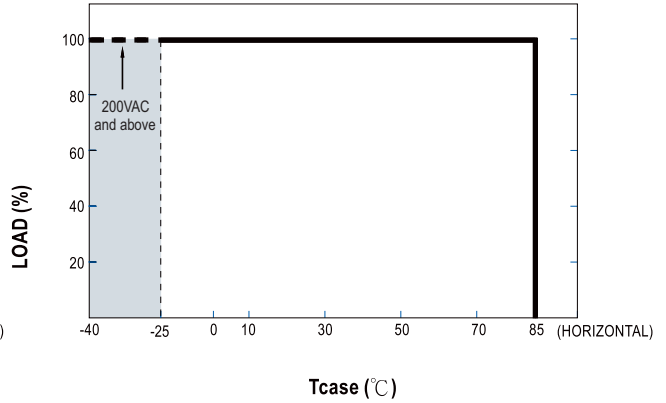
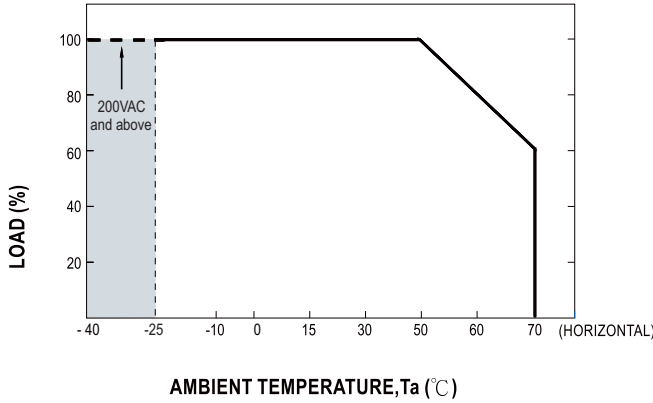

STATIC CHARACTERISTIC

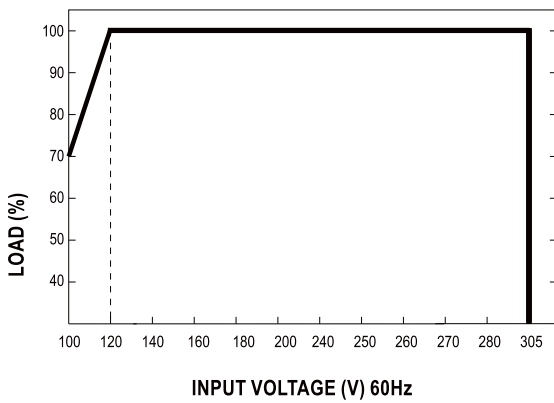

※ De-rating is needed under low input voltage.

POWER FACTOR (PF) CHARACTERISTIC

※ 48V Model, T_{case} at 80°C

Constant Current Mode

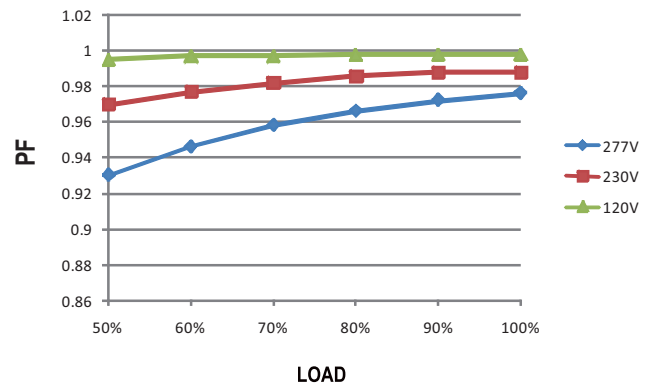

TOTAL HARMONIC DISTORTION (THD)

※ 48V Model, T_{case} at 80°C

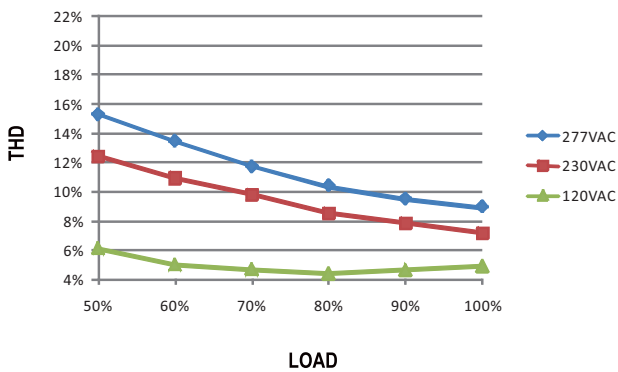

EFFICIENCY vs LOAD

ELG-150U series possess superior working efficiency that up to 90% can be reached in field applications.

※ 48V Model, T_{case} at 80°C

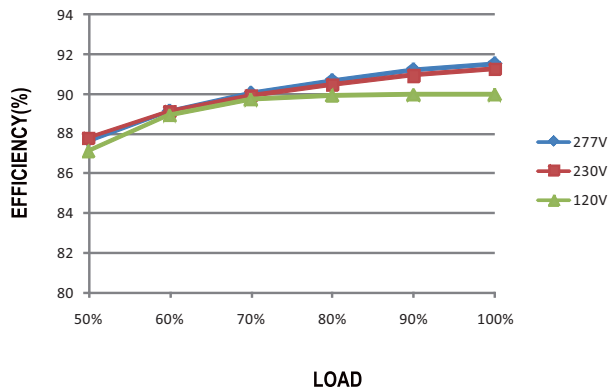



■ LIFE TIME

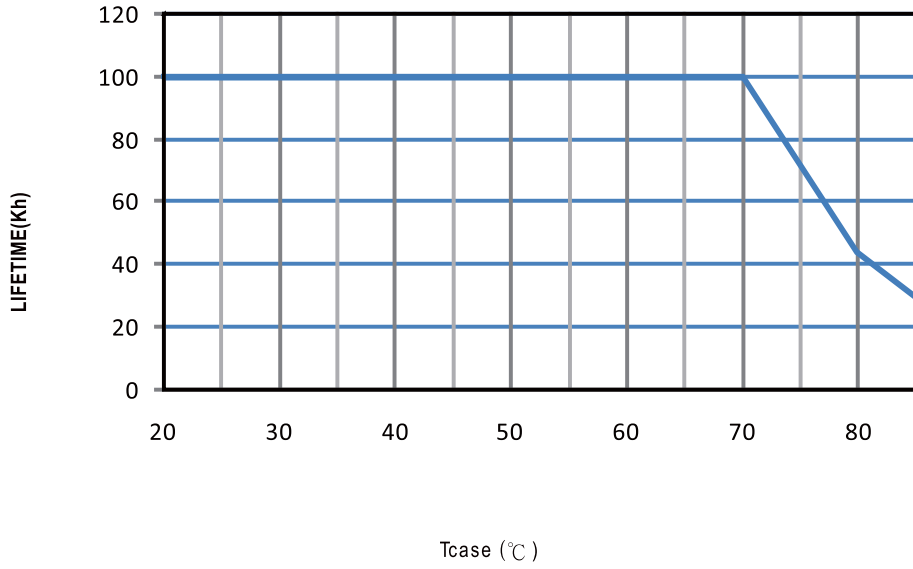

■ Mechanical Specification

※ Blank-Type

CASE NO.: 237A Unit:mm

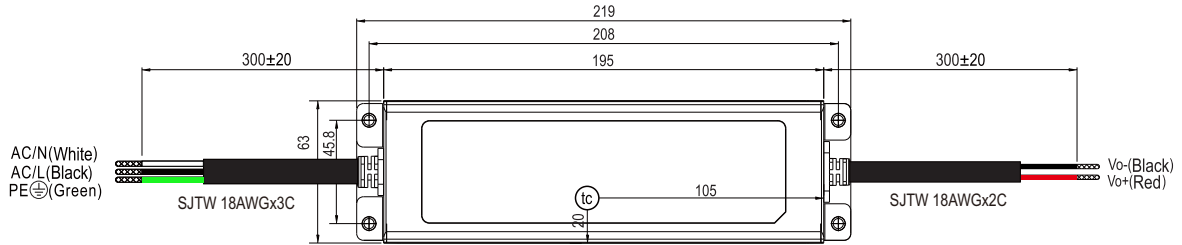

* (tc) : Max. Case Temperature



※ A-Type

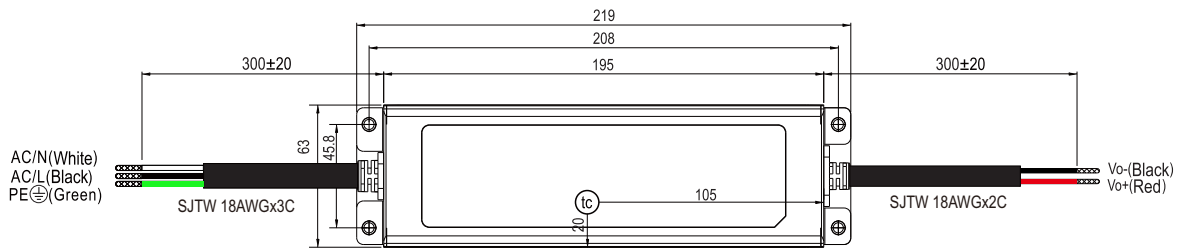

* (tc) : Max. Case Temperature

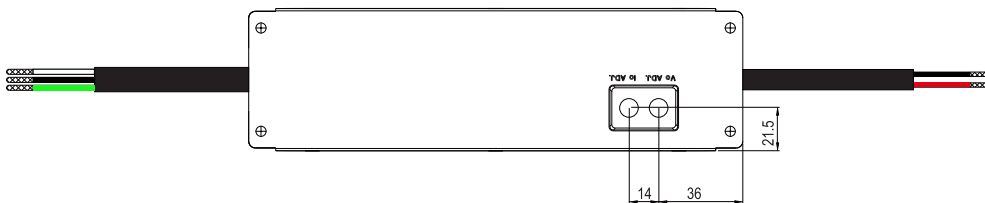

※ B-Type

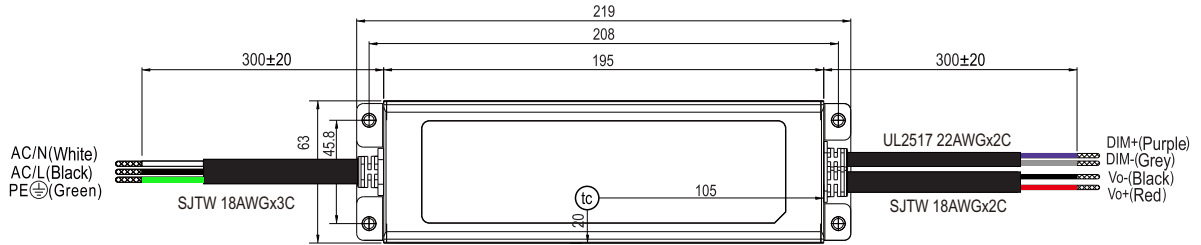

* (tc) : Max. Case Temperature



■ INSTALLATION MANUAL

Please refer to : <http://www.meanwell.com/manual.html>