

Vacuum Ejector

Series ZM

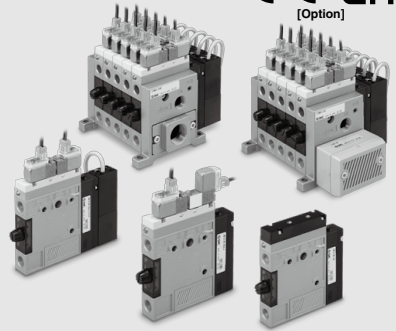

All in One!

- Built-in suction filter and silencer
- Air supply valve for generating a vacuum
- Vacuum release valve (equipped with a flow volume adjustment valve)
- Vacuum pressure switch (solid state, diaphragm)

Adaptable for a manifold application

All tubing, wiring, indicators, and adjustment functions have been eliminated from the side surfaces, thus enabling assembly and maintenance while linked to a manifold.

- EXH system — Common
- SUP system — Common, Individual

Maximum air suction volume increased by 40% Maximum vacuum pressure – 84 kPa

The suction volume has been increased by 40% through the adoption of a two-stage nozzle construction.

Compact and lightweight

15.5 mm width, 400 g (full system)

Air operated type

Two-stage nozzle construction

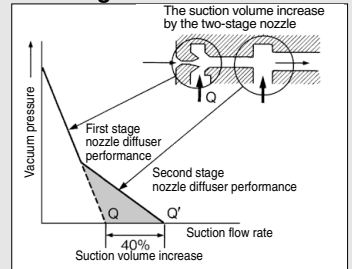

Series ZM Applications

Fields: Semiconductor and electrical, automobile assembly, food and medical equipment, and various types of manufacturing and assembly equipment

Machines: Robotic hand/material handling, automotive assembling machines, automatic transfer equipment, pick and place, printing machinery

Functions: Vacuum adsorption transfer, vacuum adsorption retention, vacuum generated air flow

Application example

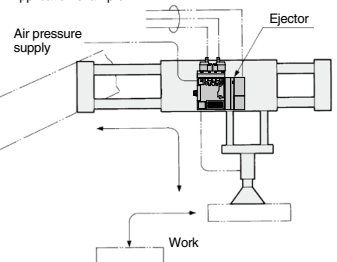

Vacuum Ejector With Valve and Switch Series ZM

Note) CE/UKCA-compliant:
For DC only.



How to Order

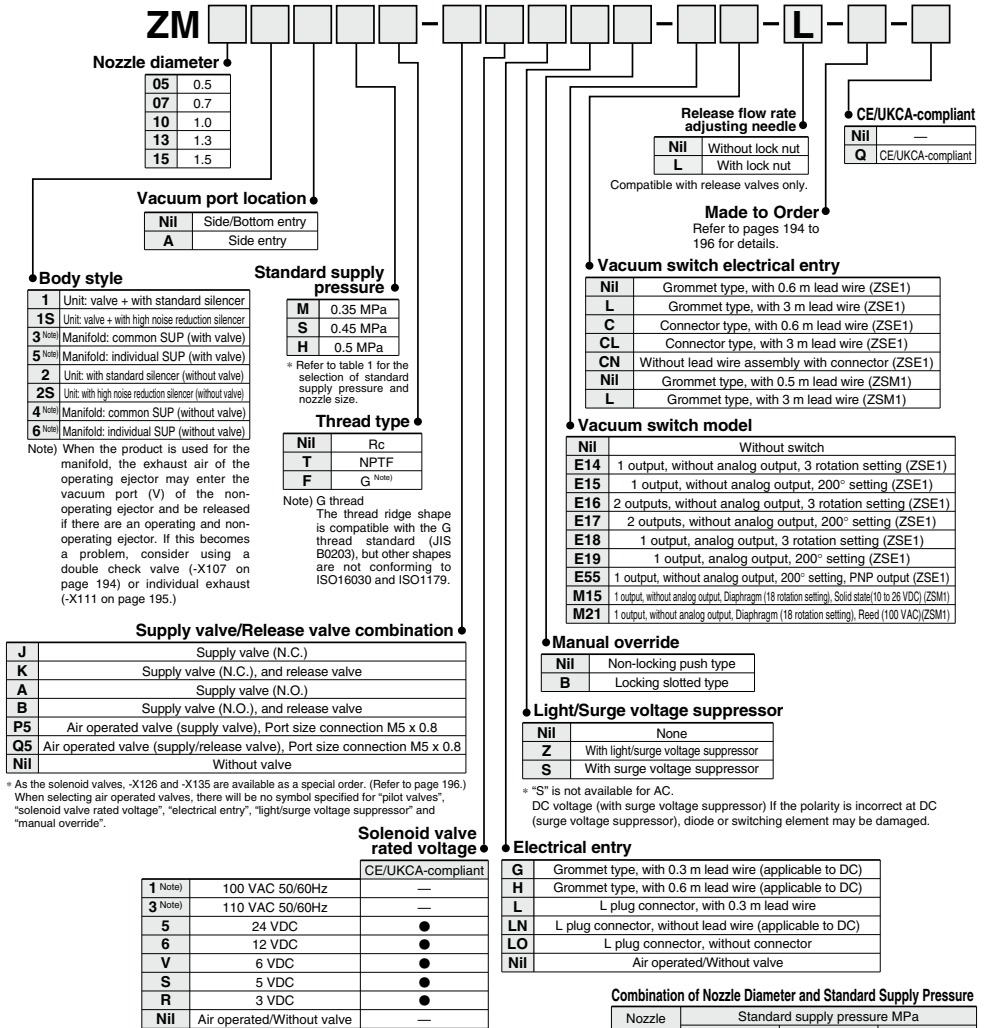

* As the solenoid valves, -X126 and -X135 are available as a special order. (Refer to page 196.)
When selecting air operated valves, there will be no symbol specified for "pilot valves",
"solenoid valve rated voltage", "electrical entry", "light/surge voltage suppressor" and
"manual override".

Note) CE/UKCA-compliant products are not available for "1" and "3".

* "S" is not available for AC.

DC voltage (with surge voltage suppressor) If the polarity is incorrect at DC
(surge voltage suppressor), diode or switching element may be damaged.

Table (1) How to Order Connector for Solid State Switch

- Without lead wire (A connector and 4 sockets) **ZS-20-A**
- With lead wire **ZS-20-5A-** 

Note) If ordering switch with 5 m lead wire, specify both switch and lead wire with connector part numbers.

Ex.) ZM -E15CN 1 pc.
* ZS-20-5A-50 1 pc.

Lead wire length	
Nil	0.6 m
30	3 m
50	5 m

Table (2) How to Order for Supply Valve and Vacuum Release Valve

● How to Order Solenoid Valves (Refer to the table (3))

● How to order connector assembly

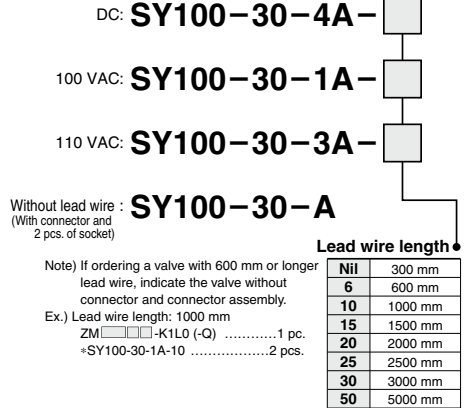
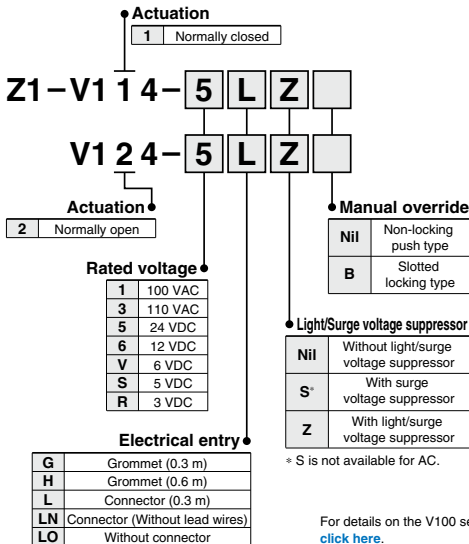



Warning

The pilot valve should be changed. When replacing the current model (black color) in which "1" or "3" is used for the solenoid valve rated voltage, replace the lead wire assembly with connector together.

Caution

The type of actuation cannot be changed just by changing the solenoid valve.

Table (3) Solenoid Valve Model

Supply valve N.C. Release valve (N.C.)	Z1-V114- 
Supply valve N.O.	V124- 

Quick Delivery/Model

<Without valve/Single unit>	<With valve/Single unit>	
● ZM052H	● ZM051H-K5LZ(-Q)	● ZM131H-K5LZ(-Q)
● ZM072H	● ZM051H-K5LZ-E15(-Q)	● ZM131H-K5LZ-E15(-Q)
● ZM102H	● ZM071H-K5LZ(-Q)	● ZM131M-K5LZ(-Q)
● ZM132H	● ZM071H-K5LZ-E15(-Q)	● ZM131M-K5LZ-E15(-Q)
	● ZM101H-K5LZ(-Q)	
	● ZM101H-K5LZ-E15(-Q)	

Series ZM

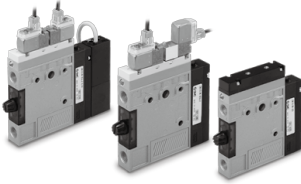

Symbol

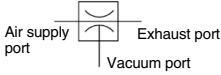

Ejector System Circuit

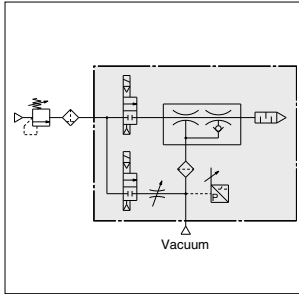

Made to Order
(Refer to pages 194 to 196 for details.)

Symbol	Specifications
X107	Double check valve/For manifold
X111	With individual exhaust spacer
X126	Double solenoid supply valve (With release valve)
X135	Double solenoid supply valve (Without release valve)

Model

Nozzle dia. ø (mm)	Model	Standard supply pressure			Maximum suction flow rate (L/min (ANR))	Air consumption (L/min (ANR))	Diffuser construction
		H	M	S			
0.5	ZM05□H	0.5 MPa	—	—	15	17	Double diffuser
0.7	ZM07□H				30	30	
1.0	ZM10□H				50	60	
1.3	ZM13□H				66	90	
0.7	ZM07□M	0.35 MPa	—	—	23	33	
1.0	ZM10□M				38	60	
1.3	ZM13□M				44	85	
1.3	ZM13□S				37	88	Single diffuser
1.5	ZM15□S	0.45 MPa	45	110			

Vacuum Ejector Specifications

Fluid	Air	
Maximum operating pressure	0.7 MPa	
Maximum vacuum pressure	- 84 kPa	
Supply pressure range	Air pressure supply (P) port (Without valve)	0.2 to 0.55 MPa
	Air pressure supply (P) port (With valve)	0.25 to 0.55 MPa
	Pilot pressure supply (PA, PB) ports for supply and release ^(Note)	P port pressure to 0.55 MPa
Operating temperature range	Without valve	5 to 60 °C
	With valve	5 to 50 °C
Air supply valve	Main valve	Poppet
Vacuum release valve	Pilot valve	V114, V124
Vacuum pressure switch	Electronic	ZSE1-00-□□□□
	Diaphragm	ZSM1-0-□□□□
Suction filter	Filtration degree: 30 μm, Material: PE (Polyethylene)	

Note) Combination of supply valve and release valve: P5, Q5

The supply and release valves of this product have a structure which uses the pressure of the air pressure supply (P) port to operate them. Be sure to supply a pressure that is the pressure of the air pressure supply (P) port or more and 0.55 MPa or less to the pilot pressure supply (PA, PB) ports for supply and release.

Valve Specifications

How to operate	Pilot type
Main valve	NBR poppet
Effective area	3 mm ²
Cv factor	0.17
Operating pressure range	0.25 to 0.7 MPa
Electrical entry	Plug connector, Grommet (available on DC)
Max. operating frequency	5 Hz
Voltage	24/12/6/5/3 VDC, 100/110 VAC (50/60 Hz)
Power consumption	DC: 0.35 W (With light: 0.4 W)
Apparent power	100 VAC: 0.78 VA (With light: 0.81 VA)
	110 VAC: 0.86 VA (With light: 0.89 VA)

Weight

		(kg)					
Model	Without switch	-E□□	-E□□L	-M□□	-M□□L		
ZM□□2□	0.13	0.17	0.22	0.25	0.29		
ZM□□4□							
ZM□□6□							
ZM□□1□-J□□	0.16	0.2	0.25	0.28	0.33		
ZM□□3□-J□□							
ZM□□5□-J□□							
ZM□□1□-K□□	0.18	0.22	0.27	0.29	0.34		
ZM□□3□-K□□							
ZM□□5□-K□□							
ZM□□1□-A□□	0.17	0.2	0.25	0.27	0.32		
ZM□□3□-A□□							
ZM□□5□-A□□							
ZM□□1□-B□□	0.18	0.21	0.26	0.29	0.34		
ZM□□3□-B□□							
ZM□□5□-B□□							
ZM□□□□-□□	0.17	0.2	0.25	0.27	0.32		
Stations	-04R/L	-04B	-06R/L	-06B	-SR/L	-SB	
1	0.209	0.219	0.219	0.229	0.239	0.269	
2	0.214	0.224	0.224	0.234	0.244	0.274	
3	0.219	0.229	0.229	0.239	0.249	0.279	
4	0.224	0.234	0.234	0.244	0.254	0.284	
5	0.229	0.239	0.239	0.249	0.259	0.289	
6	0.234	0.244	0.244	0.254	0.264	0.294	
7	0.239	0.249	0.249	0.259	0.269	0.299	
8	0.244	0.254	0.254	0.264	0.274	0.304	
9	0.249	0.259	0.259	0.269	0.279	0.309	
10	0.254	0.264	0.264	0.274	0.284	0.314	

Construction: ZM□1□-K□L-E□

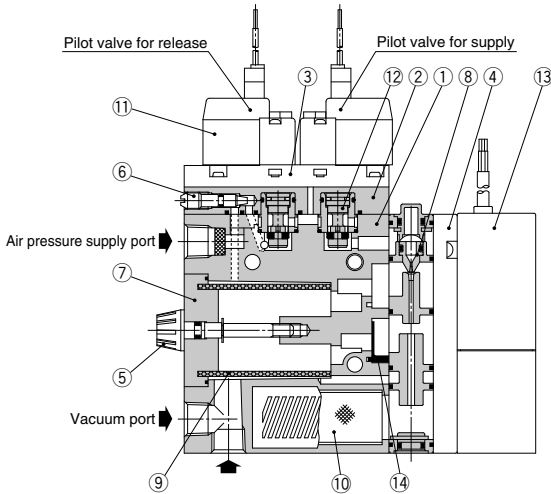

⚠ Precautions

- Be sure to read before handling.
- Refer to back page 1 for Safety Instructions and back page 2 to 4 for Vacuum Equipment Precautions.

⚠ Caution

Selection and sizing of Series ZM
Refer to the Vacuum Equipment Model Selection on front matter 18 to 39.

Operation of an ejector equipped with a valve

When the air supply pilot valve is turned ON, air flows to the diffuser assembly, and a vacuum is created.

When the pilot valve for releasing the vacuum is turned ON, air flows to the vacuum port side, immediately causing a release in the vacuum. The release speed can be adjusted by regulating the flow volume adjustment screw.

When the supply valve is turned OFF, the atmospheric pressure causes the air to flow back from the silencer, thus releasing the vacuum. However, in order to properly release a vacuum, a vacuum release valve must be used.

Operating environment

Because the filter cover is made of polycarbonate, do not use it with or expose it to following chemicals: paint thinner, carbon tetrachloride, chloroform, acetic ester, aniline, cyclohexane, trichloroethylene, sulfuric acid, lactic acid, water-soluble cutting oil (alkalinic), etc. Also, do not expose it to direct sunlight.

Furthermore, avoid use in direct sunlight.

Release flow rate adjusting screw

Turning the vacuum release flow rate adjusting screw 4 full turns from the fully closed position renders the valve fully open. Do not turn more than four times since turning excessively may cause the screw fall off.

In order to prevent the screw from loosening and falling out, the release flow rate adjusting needle with lock nut is also available.

Component Parts

No.	Description	Material	Note
1	Body	Aluminum die-casted	
2	Valve cover	Resin	
3	Adapter plate	Resin	
4	Cover	Zinc die-casted	Without switch: ZM-HCA, With switch: ZM-HCB
5	Tension bolt	Stainless steel/Polyacetal	

Replacement Parts

No.	Description	Material	Part no.
6	Release flow rate adjusting needle	Brass/Electroless nickel plating	ZM-NA (With lock nut: ZM-ND-L)
7	Filter cover assembly	—	ZM-FCB-0
8	Diffuser assembly	—	ZM□□0□-0 (Refer to page 176) Nozzle diameter ↓ Standard supply pressure
9	Suction filter	Polyethylene	ZM-SF
10	Silencer assembly	—	ZM-SA (High noise reduction: ZM-SA-D)
11	Pilot valve	—	Z1-V114-□□□□ (Refer to page 177) V124-□□□□
12	Poppet valve assembly	—	ZMA-PV2-0
13	Vacuum pressure switch	—	ZSE1-00-□□ ZSM1-015 ZSM1-021
14	Check valve	NBR	ZM-CV

Exhaust Characteristics/Flow Characteristics, Standard Supply Pressure: H ... 0.5 MPa

ZM05□H

Exhaust Characteristics

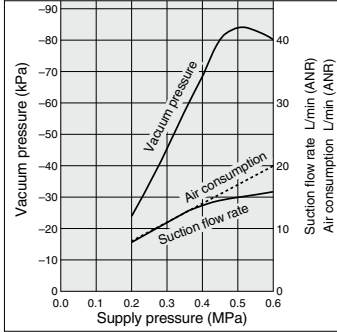

Flow Characteristics

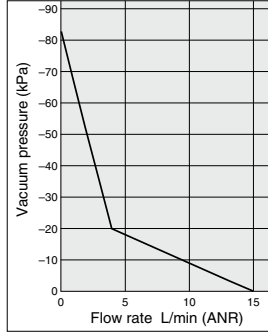

ZM07□H

Exhaust Characteristics

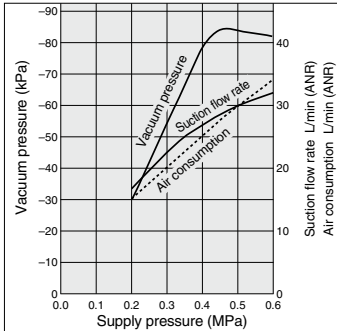

Flow Characteristics

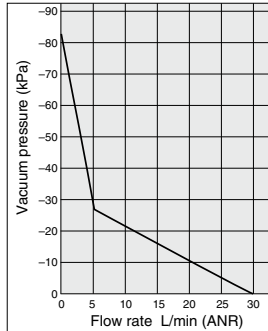

ZM10□H

Exhaust Characteristics

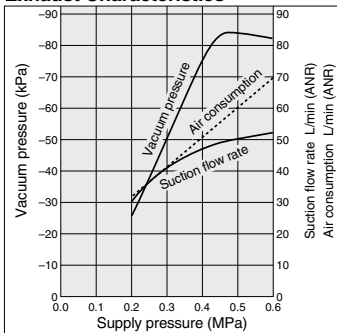

Flow Characteristics

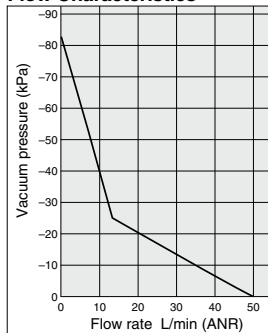

Exhaust Characteristics/Flow Characteristics, Standard Supply Pressure: H ... 0.5 MPa

ZM13□H

Exhaust Characteristics

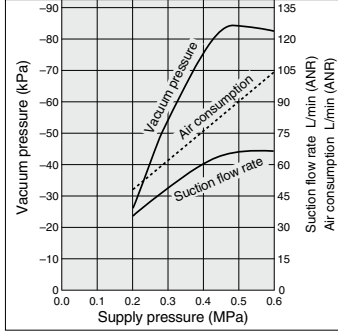

Flow Characteristics

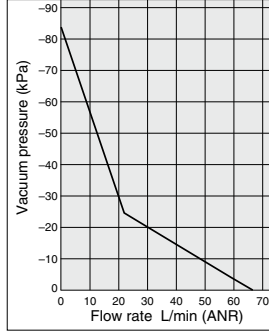

Exhaust Characteristics/Flow Characteristics, Standard Supply Pressure: S ... 0.45 MPa

ZM13□S

Exhaust Characteristics

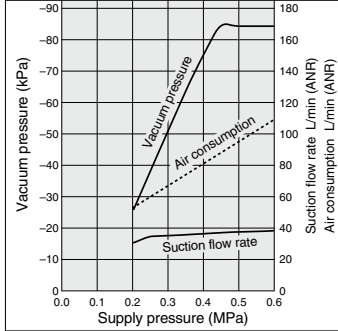

Flow Characteristics

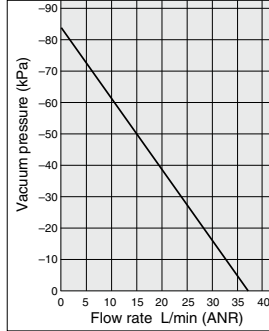

ZM15□S

Exhaust Characteristics

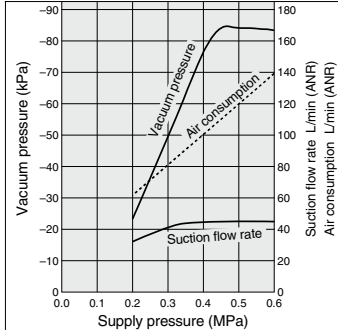

Flow Characteristics

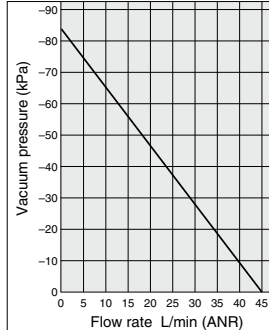

Exhaust Characteristics/Flow Characteristics, Standard Supply Pressure: M ... 0.35 MPa

ZM07□M

Exhaust Characteristics

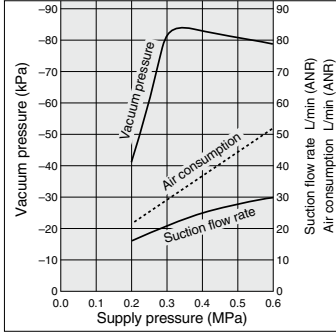

Flow Characteristics

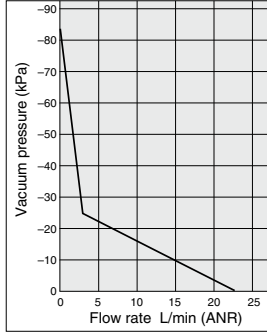

How to Read Flow Characteristics Graph

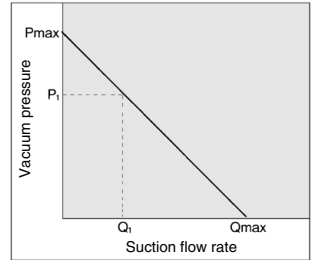

Flow characteristics are expressed in ejector vacuum pressure and suction flow. If suction flow rate changes, a change in vacuum pressure will also be expressed. Normally this relationship is expressed in ejector standard supply pressure. In graph, P_{max} is max. vacuum pressure and Q_{max} is max. suction flow. The values are specified according to catalog use.

Changes in vacuum pressure are expressed in the order below.

1. When ejector suction port is covered and made airtight, suction flow is 0 and vacuum pressure is at maximum value (P_{max}).
2. When suction port is opened gradually, air can flow through (air leakage), suction flow increases, but vacuum pressure decreases (condition P_1 and Q_1).
3. When suction port is opened further, suction flow moves to maximum value (Q_{max}), but vacuum pressure is near 0 (atmospheric pressure).
When vacuum port (vacuum piping) has no leakage, vacuum pressure becomes maximum, and vacuum pressure decreases as leakage increases. When leakage value is the same as max. suction flow, vacuum pressure is near 0.
When ventilative or leaky work must be adsorbed, please note that vacuum pressure will not be high.

ZM10□M

Exhaust Characteristics

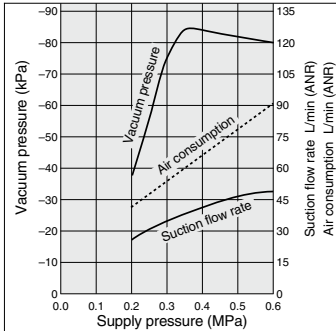

Flow Characteristics

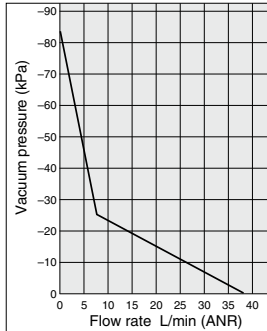

ZM13□M

Exhaust Characteristics

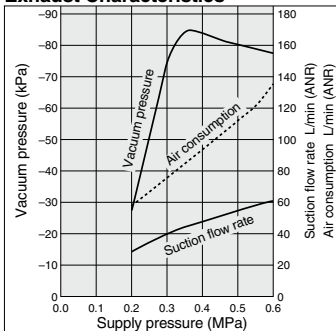

Flow Characteristics

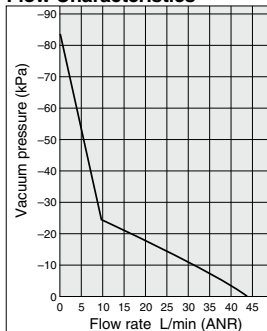

Vacuum Pressure Switch/Solid State Switch (ZSE), Diaphragm Switch (ZSM)

Vacuum Switch

Model	ZSE1-00-14	ZSE1-00-15	ZSE1-00-16	ZSE1-00-17	ZSE1-00-18	ZSE1-00-19	ZSE1-00-55	ZSM1-015	ZSM1-021
Sensor type	Solid state							Diaphragm	
Switch	Electronic circuit							Solid state	Reed
Set pressure range	0 to -101 kPa								
Hysteresis	1 to 10% of the set pressure (Changeable)		3% full span or less (Fixed)		1 to 10% of the set pressure (Changeable)		Max. 15 kPa	Max. 20 kPa	
Repeatability	±1% full span or less								
Temperature characteristics	±3% full span or less								
Operating voltage	12 to 24 VDC (Ripple ±10% or less)							4.5 to 28 VDC/AC/DC 100 V	
ON-OFF output	NPN open collector 30 V, Max. 80 mA						PNP open collector 80 mA	Open collector 28 V, Max. 40 mA	—
Setting points	1 point		2 points		1 point		1 point		
Operation indicator light	Lights up when ON		Lights ON (Output 1: Red, Output 2: Green)		Lights up when ON		Lights up when ON (Red)		Lights up when ON
Setting trimmer	3 rotations	200 degrees	3 rotations	200 degrees	3 rotations	200 degrees		18 rotations	
Current consumption	17 mA or less (When 24 VDC is ON)		25 mA or less (When 24 VDC is ON)		17 mA or less (When 24 VDC is ON)		10 mA or less (24 VDC)		
Max. current	—							—	24 V or less: 50 mA 48 V: 40 mA, 100 V: 20 mA
Max. operating pressure	0.2 MPa							0.5 MPa	

* When using ejector system, instantaneous pressure up to 0.5 MPa will not damage the switch.

Note) For details about wiring, refer to the Operation Manual that can be downloaded from our website (<http://www.smcworld.com>).

For details on the ZSE1 series, [click here](#).

Diaphragm Switch (ZSM)

Solid State Switch: ZSM1-015

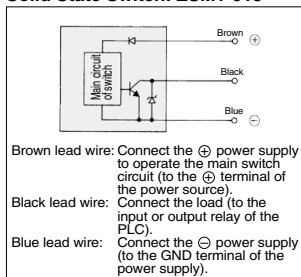

Reed Switch: ZSM1-021

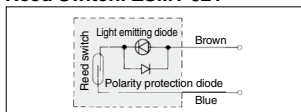

Contact protection box

The switch does not have a built-in contact protection circuit. Use this box if an induction load is applied or if the lead wire is longer than 5 meters.



Internal Circuit of Contact Protection Box

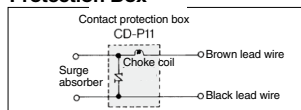

For details on the ZSM1 series, [click here](#).

How to Set the Pressure

- The ON pressure is set with the pressure setting trimmer. The high pressure/high vacuum pressure can be set turning it clockwise.
- When setting, use a flat head screw driver which fits the groove in the trimmer, and turn it gently with your fingertips.

ZSE1(L)-□□-14/-15/-18/-19

- Hysteresis can be set using the hysteresis setting trimmer. The setting is increased by turning it clockwise, and the range is 1 to 10% of the set pressure range.
- When the hysteresis setting trimmer is moved after setting the ON pressure, it must be set again.

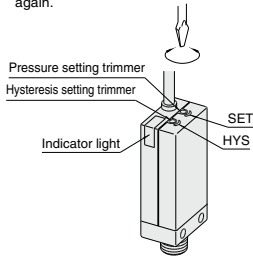

ZSE1(L)-□□-16/-17

- OUT1 (black lead wire, red LED) can be set with the pressure setting trimmer 1 (SET1).
- OUT2 (white lead wire, green LED) can be set with the pressure setting trimmer 2 (SET2).

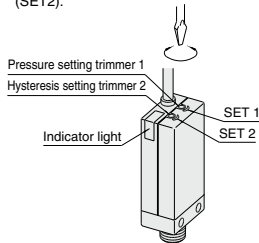

- When using the switch to confirm correct adsorption, the vacuum pressure is set to the minimum value to reliably adsorb. If the value is set below the minimum, the switch will be turned ON even when adsorption has failed or is insufficient. If the pressure is set too high, the switch may not turn ON even though it may adsorb correctly.

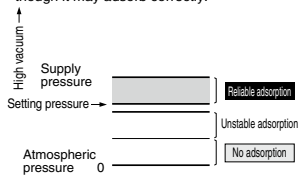

⚠ Caution

Observe the following precautions for setting the vacuum pressure: Use your fingertips to gently turn the screwdriver. Do not use a screwdriver with a large grip or with a tip that does not fit into the trimmer groove because this could damage the groove.

Hysteresis

Hysteresis is the difference in pressure when the output signal is ON and OFF. The pressure to be set is the ON pressure. It turns ON at the set pressure.

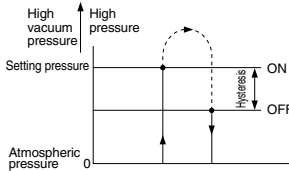

How to Use Connector

1. Attaching and detaching connectors

- When assembling the connector to the switch housing, push the connector straight onto the pins until the level locks into the housing slot.
- When removing the connector from the switch housing, push the lever down to unlock it from the slot and then withdraw the connector straight off of the pins.

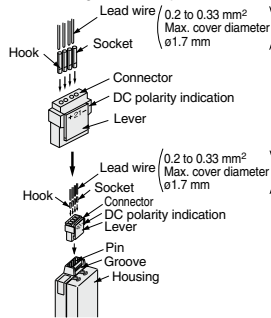

2. Crimping of lead wires and sockets

Strip 3.2 to 3.7 mm of the lead wire ends, insert each stripped wire into a socket and crimp contact it using special crimping tool. Be careful that the outer insulation of the lead wires does not interfere with the socket contact part. (Crimping tool: DXT170-75-1)

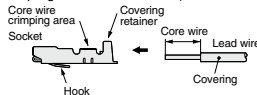

3. Attaching and detaching of socket to connector with lead wire

- **Attaching**
Insert the sockets into the square holes of the connector (with +, 1, 2, - indication), and continue to push the sockets all the way in until they lock by hooking into the seats in the connector. (When they are pushed in their hooks open and they are locked automatically.) Then confirm that they are locked by pulling lightly on the lead wires.
- **Detaching**
To detach a socket from a connector, pull out the lead wire while pressing the socket's hook with a stick having a thin tip (about 1 mm). If the socket will be used again, first spread the hook outward.

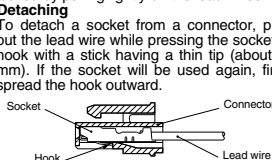



For Single Unit/Without Valve Basic Type

ZM□2□□^H□_M□_S

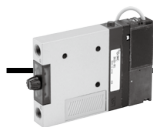
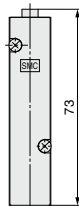
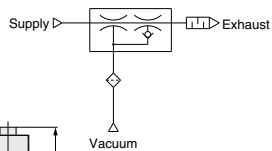
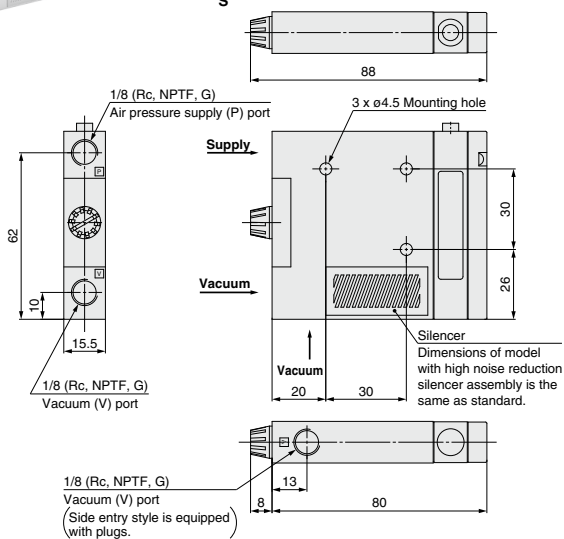

<Components>

For Single Unit/Without Valve Basic Type with Switch

ZM□2□□^H□□-□□_M□_S

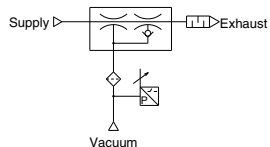
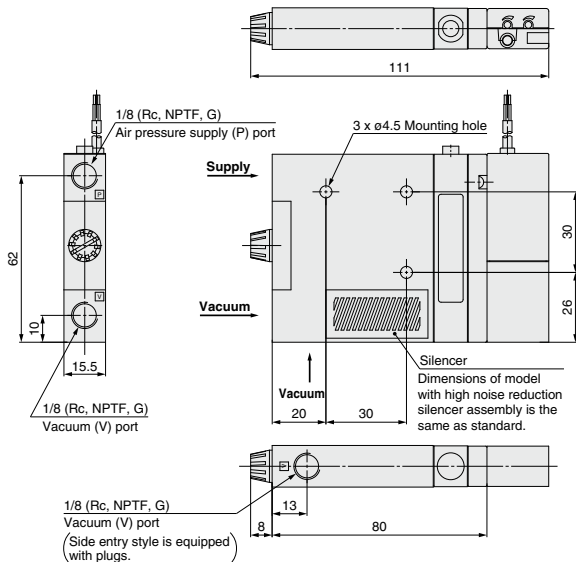

Air Operated Type

ZM□1□□□^H_S□□-P5

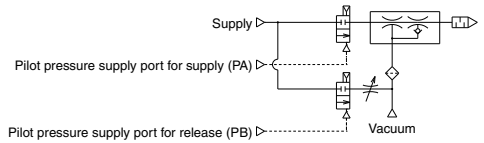

A: Release flow rate adjusting needle with lock nut

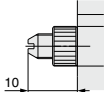

(Needle fully open)

Pilot pressure supply port for release (PB) ^{Note 2)}
M5 x 0.8

Pilot pressure supply port for supply (PA) ^{Note 2)}
M5 x 0.8

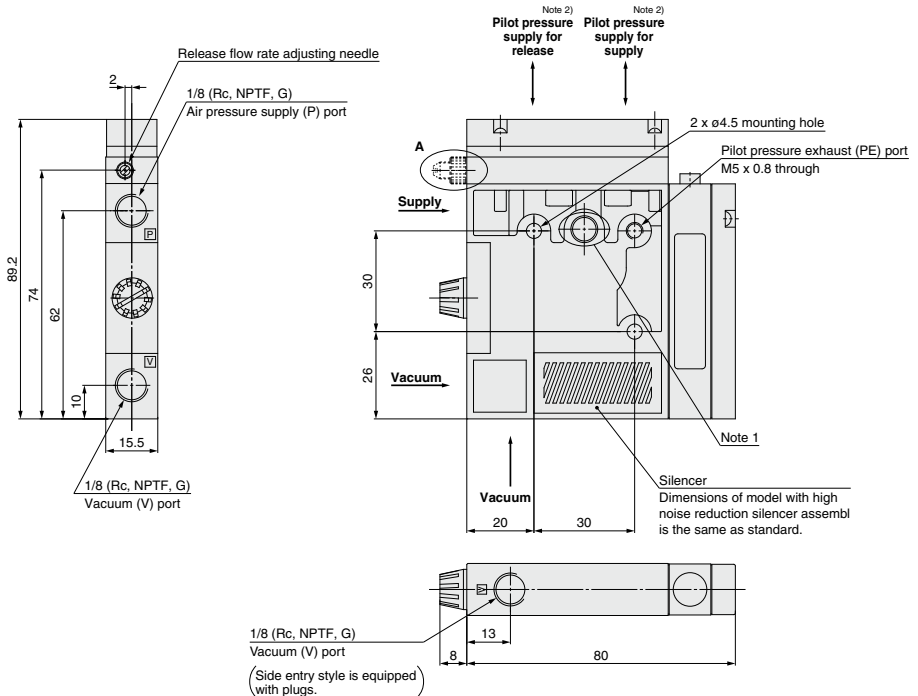
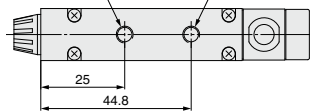

Note 1) This is a hole for using the manifold and single unit bodies in common, and it is not used for the single unit.
 Note 2) The supply and release valves of this product have a structure which uses the pressure of the air pressure supply (P) port to operate them. Be sure to supply a pressure that is the pressure of the air pressure supply (P) port or more and 0.55 MPa or less to the pilot pressure supply (PA, PB) ports for supply and release.

<Components>

For Single Unit/With Valve Basic Type with Switch and Valve

ZM□□□□^H_M□□-K□□□□-E□
S

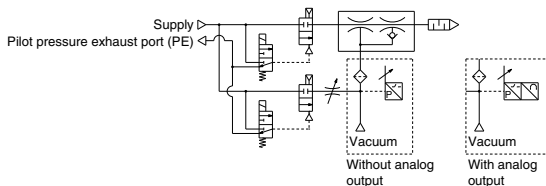

A: Release flow rate adjusting needle with lock nut

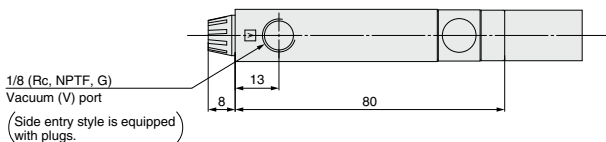
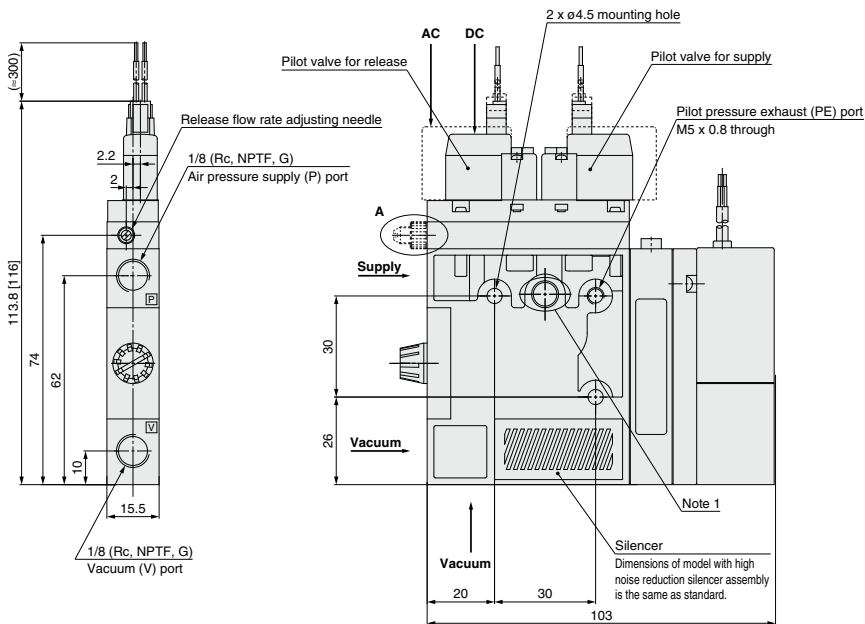
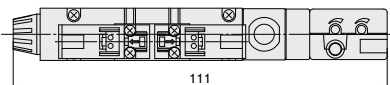
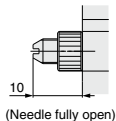

Note 1) This is a hole for using the manifold and single unit bodies in common, and it is not used for the single unit.
Note 2) [] : AC

<Components>

Single/With Air Supply Valve (N.O.) and Vacuum Release Valve **Basic Type with Valve**

ZM□1□□□^H_M□□-B□□□□_S

A: Release flow rate adjusting needle with lock nut

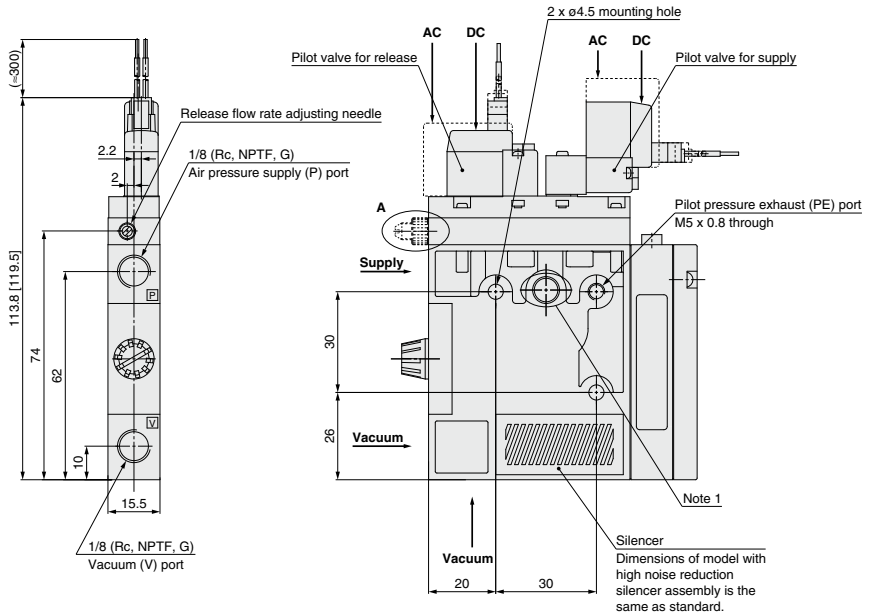
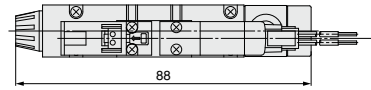
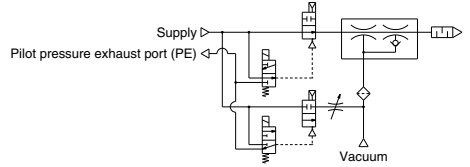
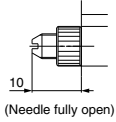

1/8 (Rc, NPTF, G)
Vacuum (V) port
(Side entry style is equipped
with plugs.)

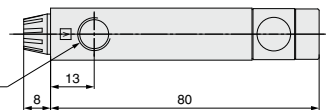

Note 1) This is a hole for using the manifold and single unit bodies in common, and it is not used for the single unit.
Note 2) []: AC

Manifold Specifications: Series ZM

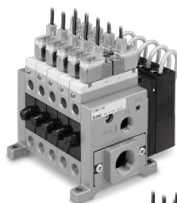

Manifold Specifications

Manifold style	Stacking
Common air pressure supply port (P)*	1/4 (Rc, NPTF, G)
Individual air pressure supply port (P)*	1/8 (Rc, NPTF, G)
Common exhaust port (EXH)	1/2, 3/4 (Rc, NPTF, G)
Common exhaust port (EXH) location	Right side/Left side/Both sides**
Max. number of stations	Max.10 stations
Silencer	ZZM-SA (With bolts)

* The common air pressure supply port (P) and individual air pressure supply port (P) can be mounted together.

** Right and left sides are viewed from the front side of vacuum port (V).

Maximum Ejector Stations (Max. operable nos. simultaneously)

Ejector model	ZM053	ZM073	ZM103	ZM133	ZM153
Manifold model	ZM054	ZM074	ZM104	ZM134	ZM154
ZZM [Stations] - □ R	10	8	5	4	3
ZZM [Stations] - □ B	10	10	8	6	5

* Effective area of external silencer is 160 mm².

How to Order Ejector Manifold

ZZM 06 - □ 06 R - R

• **Multi-ejector**
Series ZM
Manifold

• **Number of stations**

01	1 station
⋮	⋮
05	5 stations
⋮	⋮
10	10 stations (Max.)

* By viewing the front side of vacuum (V) port, stations are counted starting from station 1 on the left side.

• **Thread type**

NII	Rc
T	NPTF
F	G (Note)

Note) G thread
The thread ridge shape is compatible with the G thread standard (JIS B0203), but other shapes are not conforming to ISO16030 and ISO 1179.

• **Common air pressure supply (P) port location****

NII	Both sides
R	Right side
L	Left side

** Right and left sides are viewed from the front side of vacuum port (V).

• **Common exhaust port (EXH) and silencer location****

NII	None (When the common exhaust (EXH) port size is "00")
R	Right side
L	Left side
B	Both sides

** Right and left sides are viewed from the front side of vacuum port (V).

• **Common exhaust (EXH) port size**

04	1/2
06	3/4
S	Silencer for ZZM (ZZM-SA)

The asterisk (*) indicates the ejector model no. below the manifold base no. Prefix it to the vacuum ejector part numbers to be mounted. When it is not added, products are shipped separately.

Example)

ZZM06-06R 1 pc.

* ZM103H-J5LZ(-Q) 3 pcs.

* ZM133H-J5LZ(-Q) 3 pcs.

Manifold

ZZM [Number of ejectors] - [Common EXH port] [Port location]

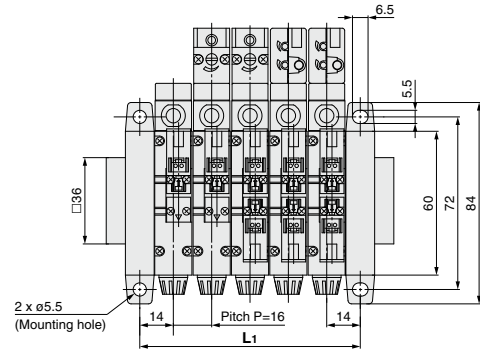

A: Release flow rate adjusting needle with lock nut

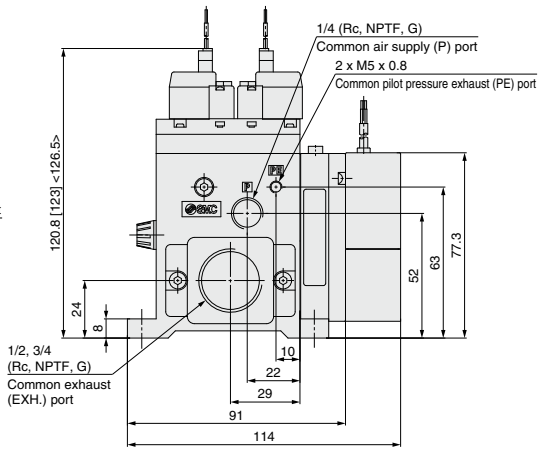
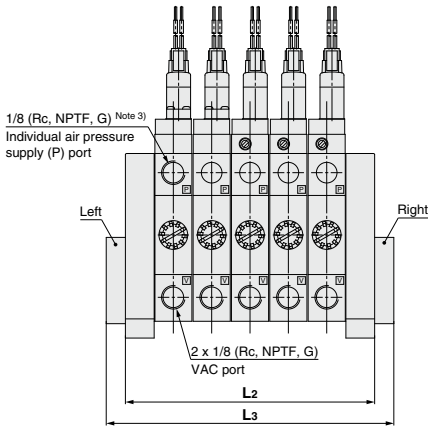
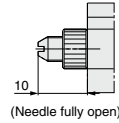

Note 1) [] for N.C., AC type
 Note 2) < > for N.O., AC type
 Note 3) For individual supply specifications

Vacuum port electrical entry (In the case of side entry/With plug at the bottom)

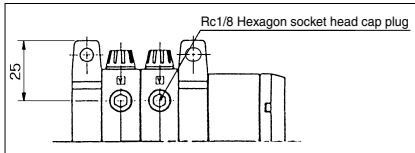

Stations		1	2	3	4	5	6	7	8	9	10
L	L1	28±1.5	44±1.5	60±1.5	76±1.5	92±1.5	108±2.0	124±2.0	140±2.0	156±2.0	172±2.0
	L2	40±1.5	56±1.5	72±1.5	88±1.5	104±1.5	120±2.0	136±2.0	152±2.0	168±2.0	184±2.0
L3	ZZM□□-□SB-□	104±1.5	120±1.5	136±1.5	152±1.5	168±1.5	184±2.0	200±2.0	216±2.0	232±2.0	248±2.0
	ZZM□□-□S□-□	72±1.5	88±1.5	104±1.5	120±1.5	136±1.5	152±2.0	168±2.0	184±2.0	200±2.0	216±2.0
	ZZM□□-□04B-□	52±1.5	68±1.5	84±1.5	100±1.5	116±1.5	132±2.0	148±2.0	164±2.0	180±2.0	196±2.0
	ZZM□□-□04B-□	46±1.5	62±1.5	78±1.5	94±1.5	110±1.5	126±2.0	142±2.0	158±2.0	174±2.0	190±2.0
	ZZM□□-□06B-□	56±1.5	72±1.5	88±1.5	104±1.5	120±1.5	136±2.0	152±2.0	168±2.0	184±2.0	200±2.0
	ZZM□□-□06□-□	48±1.5	64±1.5	80±1.5	96±1.5	112±1.5	128±2.0	144±2.0	160±2.0	176±2.0	192±2.0

[mm]

Series ZM

<Components>

Manifold/With Silencer **Manifold with Silencer Dedicated for Manifold**

ZZM [Number of ejectors] - S [Silencer location]

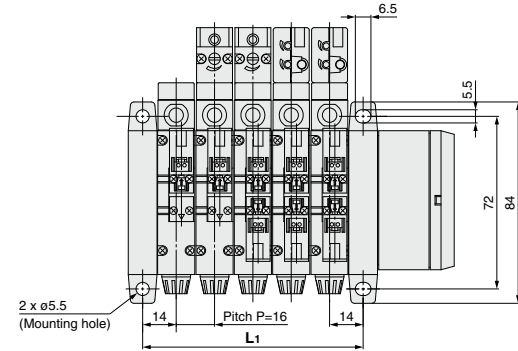

A: Release flow rate adjusting needle with lock nut

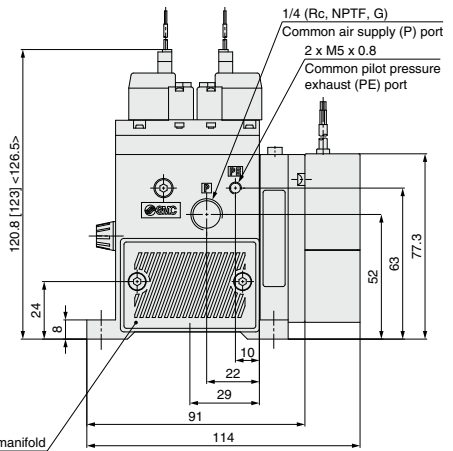
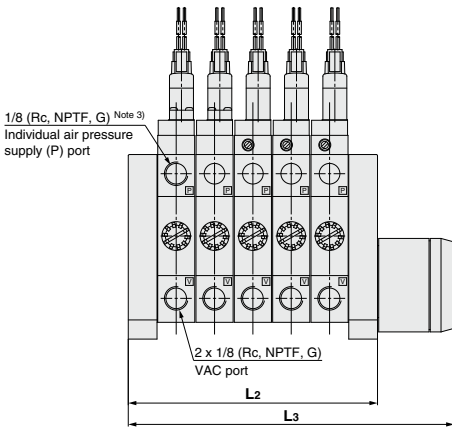
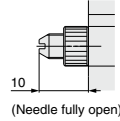

Silencer dedicated for manifold (ZZM-SA)

Note 1) [] for N.C., AC type
 Note 2) < > for N.O., AC type
 Note 3) For individual supply specifications

Vacuum port electrical entry (In the case of side entry/With plug at the bottom)

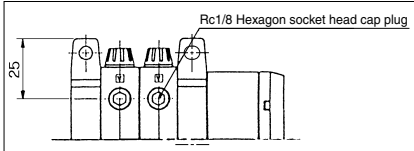

Stations		1	2	3	4	5	6	7	8	9	10
L1	L1	28±1.5	44±1.5	60±1.5	76±1.5	92±1.5	108±2.0	124±2.0	140±2.0	156±2.0	172±2.0
	L2	40±1.5	56±1.5	72±1.5	88±1.5	104±1.5	120±2.0	136±2.0	152±2.0	168±2.0	184±2.0
L3	ZZM□□-□SB-□	104±1.5	120±1.5	136±1.5	152±1.5	168±1.5	184±2.0	200±2.0	216±2.0	232±2.0	248±2.0
	ZZM□□-□S□-□	72±1.5	88±1.5	104±1.5	120±1.5	136±1.5	152±2.0	168±2.0	184±2.0	200±2.0	216±2.0
	ZZM□□-□04B-□	52±1.5	68±1.5	84±1.5	100±1.5	116±1.5	132±2.0	148±2.0	164±2.0	180±2.0	196±2.0
	ZZM□□-□04B-□	46±1.5	62±1.5	78±1.5	94±1.5	110±1.5	126±2.0	142±2.0	158±2.0	174±2.0	190±2.0
	ZZM□□-□06B-□	56±1.5	72±1.5	88±1.5	104±1.5	120±1.5	136±2.0	152±2.0	168±2.0	184±2.0	200±2.0
	ZZM□□-□06B-□	48±1.5	64±1.5	80±1.5	96±1.5	112±1.5	128±2.0	144±2.0	160±2.0	176±2.0	192±2.0

[mm]

Component Parts for Manifold

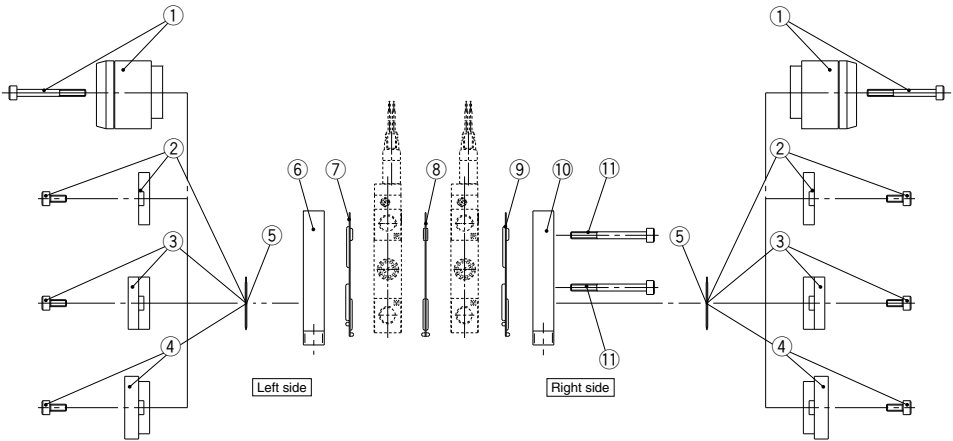

(1)

Stations	Manifold part no.	Clamp rod part no.
1	ZZM01-□□□□□	ZZM-CR-01
2	ZZM02-□□□□□	ZZM-CR-02
3	ZZM03-□□□□□	ZZM-CR-03
4	ZZM04-□□□□□	ZZM-CR-04
5	ZZM05-□□□□□	ZZM-CR-05
6	ZZM06-□□□□□	ZZM-CR-06
7	ZZM07-□□□□□	ZZM-CR-07
8	ZZM08-□□□□□	ZZM-CR-08
9	ZZM09-□□□□□	ZZM-CR-09
10	ZZM10-□□□□□	ZZM-CR-10

(2)

Manifold part no.	Adapter A		Adapter B		Silencer		Blanking plate	
	Left	Right	Left	Right	Left	Right	Left	Right
ZZM□□-□04R-□		○						○
ZZM□□-□04L-□	○							○
ZZM□□-□04B-□	○	○						
ZZM□□-□06R-□				○				○
ZZM□□-□06L-□			○					○
ZZM□□-□06B-□			○	○				
ZZM□□-□SR-□						○	○	
ZZM□□-□SL-□						○		○
ZZM□□-□SB-□						○	○	
ZZM□□-□00							○	○

(3)

No.	Model	Description	Quantity	Note
1	ZZM-SA	Silencer assembly	*	
2	ZZM-BP	Blanking plate assembly	*	
3	ZZM-ADA-□	Adapter A assembly	*	Common exhaust (EXH) port Size: 04 (Note 1)
4	ZZM-ADB-□	Adapter B assembly	*	Common exhaust (EXH) port Size: 06 (Note 1)
5	ZZM-GE	Gasket E	2	
6	ZZM-EPL-□	End plate L	1	Note 1)
7	ZZM-GBL	Gasket BL	1	
8	ZZM-GBB	Gasket BB	Station: 1	
9	ZZM-GBR	Gasket BR	1	
10	ZZM-EPR-□	End plate R	1	
11	ZZM-CR-□□	Clamp rod	1	Refer to Table (1), (Note 2)

* The used quantity varies depending on the part number.

Note 1) □: Symbol corresponding to the port thread type.

Note 2) Clamp rods consist of a set of 2 pcs.

Made to Order Specifications 1

Please contact SMC for detailed specifications, dimensions, and delivery.



1 Double Check Valve/For Manifold

Single: ZM Nozzle diameter Body Supply pressure — Valve voltage Electrical entry — X107
 ↓ Double check valve

When a manifold is used, the exhaust that is discharged to the silencer could flow out to the vacuum (V) port side. To reduce this, a check valve is used.

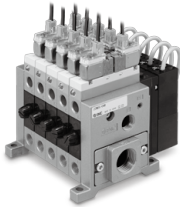

⚠ Warning

1. It cannot be used for maintaining a vacuum.
2. Use a vacuum release valve. (Compatible with valve K, B and Q5 types only.) (The workpiece cannot be released without a vacuum release valve.)
3. Compatible with the manifold specifications only.

Construction

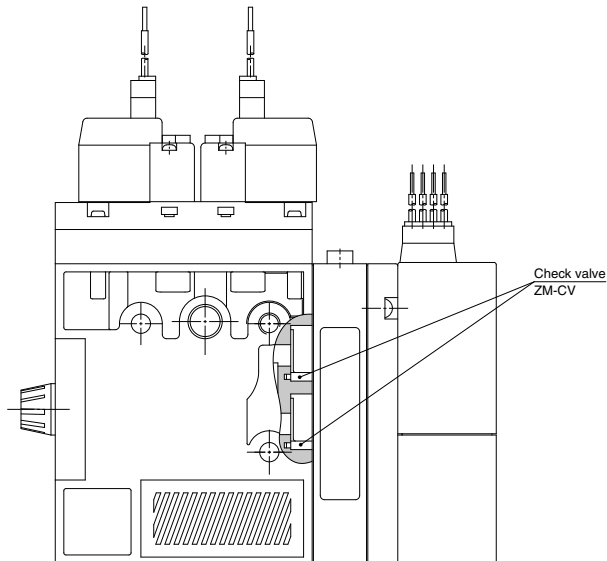



2 With Individual Exhaust Spacer

Single: ZM [Nozzle diameter] [Body] [Supply pressure] — X111 — [CE-compliant]
 ↓ Individual exhaust spacer

When using an individual ejector in a clean room, the exhaust can be discharged outside of the clean room by attaching an individual exhaust spacer. (The spacer can also be installed when using a manifold. Please contact SMC for mounting dimensions.)

* It is possible to manufacture it with a valve and a switch.

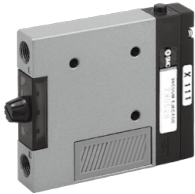

Exhaust spacer assembly: ZM — SP — []

↓ Thread Type

Nil	Rc
T	NPTF
F	G

⚠ Caution

To connect a pipe to the exhaust port, do not use an elbow joint because it creates resistance and prevents the system from attaining a sufficient vacuum.

When the product is used to prevent the manifold exhaust intrusion, exhaust intrusion may occur if exhaust pipes are put together.

When this special product is used for all manifold stations, the following part number can be used.

ZZM [] — 00 — []
 ↓ Stations
 Without exhaust ports on both sides
 ↓ Common air pressure supply (P) port location*

Nil	Both sides
R	Right side
L	Left side

* To the left or right when the vacuum (V) port is viewed from the front

Construction

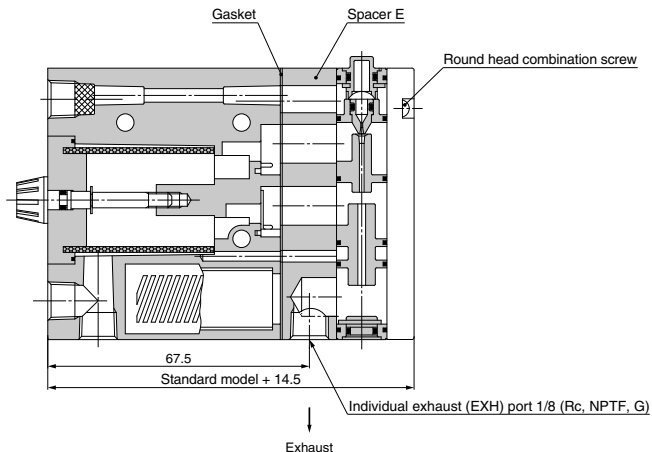

Please contact SMC for detailed specifications, dimensions, and delivery.



3 Double Solenoid Supply Valve

Single: ZM | Nozzle diameter | Body | Supply pressure | Valve voltage | Electrical entry | X126

◆ Double solenoid supply valve

-X126	With release valve (Valve K type only)
-X135	Without release valve (Valve J type only)

This is an air supply pilot valve that is made with double solenoids.

* It is possible to manufacture it with a switch.

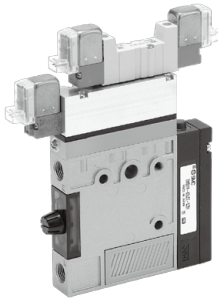

* When the valve voltage is 100 or 110 VAC, only the M plug connector can be selected as the electrical entry method.

Construction

