

Normal Close High Vacuum Solenoid Valve



*1 Excluding grommet/AC

Minimum operating pressure

1×10^{-6} Pa(abs)^{*1}

*1 OUT side

Leakage

Internal

1.3×10^{-9} Pa·m³/s

External

1.3×10^{-11} Pa·m³/s



Power consumption

Max. 25% reduction

Size	XSA [W]	Previous model [W]
XSA1	4.5	6
XSA2	7	8
XSA3	10.5	11.5

Weight

Max. 18%^{*1} lighter

*1 XSA2- $\frac{3}{2}$

0.5 kg **→** **0.41 kg**^{New}

Reverse pressure potential

0.5 MPa(G)^{*1}

*1 XSA1-12 (Refer to the Specifications on page 3.)

Consistent clean room production

Washed, assembled and inspected in a Class 100 environment, and sealed in double bags

Manufacturing process

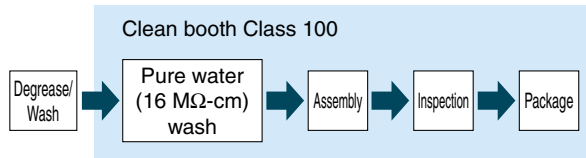

Applications

Photovoltaic cell manufacturing



Semiconductor manufacturing

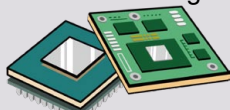

LCD manufacturing



Medical



Food



New

Female thread type (Rc, NPT) added



XSA Series



CAT.ES140-7B [Ⓐ]

Flame resistance
UL94V-0 compliant

Power consumption:

* DC/Class B

4.5 W (Size 1)

7 W (Size 2)

10.5 W (Size 3)

Electrical entry

	DC	AC
Grommet	●	—
DIN terminal	●	●
Terminal	●	●
Conduit	●	●
Flat terminal	●	—

Rated voltage

AC	100 V, 200 V, 110 V, 220 V, 240 V, 48 V, 24 V, 230 V
DC	24 V, 12 V

2 types of fittings and female threads available



Face seal fitting

A fitting with high leak integrity for vacuum to positive pressure, that forms a seal through the placement of a metal gasket at the end of the sleeve and the tightening of the nut.



Compression fitting

A self-aligning tube fitting that uses ferrule rings to compress the tubing, creating a seal when the nut is tightened.

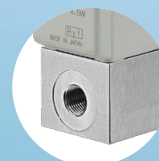

Female thread (Rc, NPT)

Reduced particle generation

Moving the spring from the sliding part of the armature to the body reduces contact with the spring, thus reducing particle generation.

Improved sealing performance

The larger spring creates a firm seal!
Leakage (Internal): 1.3×10^{-9} Pa·m³/s

Fluid temperature

5 to 60°C

Variations

Face seal fitting	Model	Orifice diameter				Fitting/Port size (inch)		Minimum operating pressure Pa(abs)	Leakage Pa·m ³ /s	
		ø2	ø3	ø4.5	ø6	1/4	3/8		Internal	External
Compression fitting	XSA1	●	●	—	—	●	—	1 x 10 ⁻⁶	1.3 x 10 ⁻⁹	1.3 x 10 ⁻¹¹
	XSA2	—	●	●	●	●	●			
	XSA3	—	—	●	●	●	●			

Female thread (Rc, NPT)	Model	Orifice diameter				Female thread (Rc, NPT)			Minimum operating pressure Pa(abs)	Leakage Pa·m ³ /s	
		ø2	ø3	ø4.5	ø6	1/8	1/4	3/8		Internal	External
Female thread (Rc, NPT)	XSA1	●	●	—	—	●	—	—	1 x 10 ⁻⁶	1.3 x 10 ⁻⁹	1.3 x 10 ⁻¹¹
	XSA2	—	●	●	—	—	●	—			
	XSA3	—	—	●	●	—	—	●			



Face seal fitting

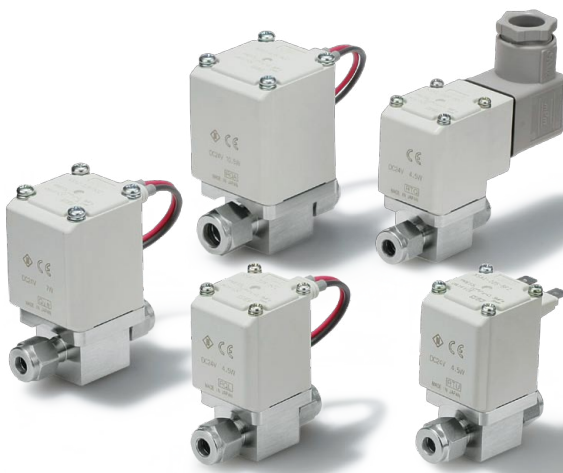

Compression fitting



Female thread (Rc, NPT)

Normal Close High Vacuum Solenoid Valve XSA Series



*1 Excluding grommet/AC

How to Order

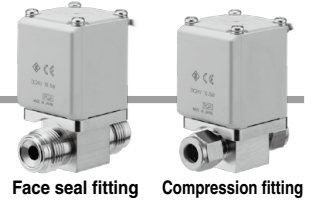

Face seal fitting Compression fitting



Female thread type

Face seal fitting
Compression fitting

XSA 1-12S-5G2-

Female thread type

XSA 1-11P-5G2

Valve size Orifice diameter Fitting size

Face seal fitting/Compression fitting

Valve size	Orifice diameter	Fitting size
1 Size 1	1 $\phi 2$	2 1/4
	2 $\phi 3$	
2 Size 2	2 $\phi 3$	2 1/4
	3 $\phi 4.5$	
	4 $\phi 6$	
3 Size 3	3 $\phi 4.5$	2 1/4
	4 $\phi 6$	

Female thread type

Valve size	Orifice diameter	Fitting size
1 Size 1	1 $\phi 2$	1 1/8
	2 $\phi 3$	
2 Size 2	2 $\phi 3$	2 1/4
	3 $\phi 4.5$	
3 Size 3	3 $\phi 4.5$	3 3/8
	4 $\phi 6$	

Fitting type

Face seal fitting/Compression fitting

V	Face seal fitting
S	Compression fitting

Female thread type

P	Rc female thread
N	NPT female thread

Voltage

1	100 VAC
2	200 VAC
3	110 VAC
4	220 VAC
5	24 VDC
6	12 VDC
7	240 VAC
8	48 VAC
B	24 VAC
J	230 VAC

Spacer

Nil	None
A	With spacer

* The spacer is used to raise the body when fastening it onto a flat area. Refer to the table below if spacers are required separately.

Electrical entry

		DC	AC
G	Grommet	●	—
GS	Grommet (With surge voltage suppressor)	●	● ^{*1}
D	DIN terminal (With surge voltage suppressor)	●	●
DL	DIN terminal with light (With surge voltage suppressor)	●	●
DO	DIN terminal without connector (With surge voltage suppressor)	●	●
T	Terminal (With surge voltage suppressor)	●	●
TL	Terminal with light (With surge voltage suppressor)	●	●
C	Conduit (With surge voltage suppressor)	●	●
F	Flat terminal	●	—

*1 Not CE-compliant

Table: Spacer Part No.
(Applicable to the face seal fitting/compression fitting)

Model	Part no.
XSA1	XSA1R-8-1
XSA2	XSA2R-8-1
XSA3	

For the special option below, refer to page 7.

Special electrical entry direction

XSA Series

Specifications

Model	XSA1-1 $\frac{1}{2}$	XSA1-2 $\frac{1}{2}$	XSA2-22	XSA2-32	XSA2-43* ³	XSA3-3 $\frac{2}{3}$	XSA3-43
Action	Normally closed						
Fluid	Air, Inert gas						
Orifice diameter mm \varnothing	2	3	4.5	6	4.5	6	
Withstand pressure MPa(G)	1.5						
Minimum operating pressure Pa(abs)/OUT side	1 x 10 ⁻⁶						
Maximum operating pressure MPa(G)/IN side	1.0						
Maximum operating pressure differential MPa* ¹	0.8	0.3	1.0	0.3	0.1	0.8	0.3
Reverse pressure potential MPa(G)* ²	0.5	0.25	0.4	0.2	0.05	0.2	0.15
Leakage Pa·m ³ /s* ⁴	Internal	1.3 x 10 ⁻⁹					
	External	1.3 x 10 ⁻¹¹					
Piping connection system	Face seal fitting/Compression fitting/(Rc, NPT) Female thread						
Connection size	Face seal fitting (inch)	1/4			3/8	1/4	3/8
	Compression fitting (inch)	1/4			—	3/8	—
(Rc, NPT) Female thread	1/8	1/4	—	—	—	3/8	—
Ambient and fluid temperature °C	5 to 60						
Rated voltage* ⁵	100/110/200/220/230/240/24/48 VAC 12/24 VDC						
Power consumption W* ⁶	DC	4.5	7	10.5			
Apparent power VA* ⁶	AC	7	9.5	12			
Coil temperature rise °C* ⁷	DC	50	55	65			
	AC	60	70	70			
Allowable voltage fluctuation	±10% or less of the rated voltage						
Allowable leakage voltage	DC	2% or less of the rated voltage					
	AC	5% or less of the rated voltage					
Coil insulation type	Class B						
Weight kg* ⁸	Face seal fitting	0.28	0.41	0.42	0.53	0.62	
	Compression fitting	0.28	0.41	0.42	0.53	0.55	
	(Rc, NPT) Female thread	0.33	0.53	—	0.74	0.74	

- *1 The operating pressure differential indicates the difference between Port 1 (high pressure side) and Port 2 (low pressure side).
Example) In the case of 0.3 MPa, Port 2 is a vacuum (1 Torr or less), while Port 1 can be pressurized to 0.2 MPa(G).
- *2 The reverse pressure potential indicates the pressure which can be applied from Port 2 when Port 1 is at atmospheric pressure.
- *3 Face seal fitting/compression fitting only
- *4 Leakage when the ambient temperature is at 20°C and there is 0.1 MPa of differential pressure. Gas permeation is not included.
- *5 AC type is equipped with full-wave rectifier.
- *6 Power consumption/Apparent power: The value when there is an ambient temperature of 20°C and when the rated voltage is applied. (Variation: ±10%)
- *7 The value when there is an ambient temperature of 20°C and when the rated voltage is applied. The value depends on the ambient environment. This is for reference.
- *8 Indicates case of grommet type

Flow Rate Characteristics

Face seal fitting/Compression fitting

		XSA1-12	XSA1-22	XSA2-22	XSA2-32	XSA2-43	XSA3-32	XSA3-43
Flow rate characteristics	C[dm ³ /(s·bar)]	0.55	1.07	1.07	1.51	2.78	1.54	2.89
	b	0.41	0.36	0.34	0.24	0.21	0.24	0.21

(Rc, NPT) Female thread

		XSA1-11	XSA1-21	XSA2-22	XSA2-32	XSA3-33	XSA3-43
Flow rate characteristics	C[dm ³ /(s·bar)]	0.54	1.14	1.14	2.23	2.37	3.50
	b	0.36	0.39	0.42	0.38	0.40	0.15

Construction/Operation

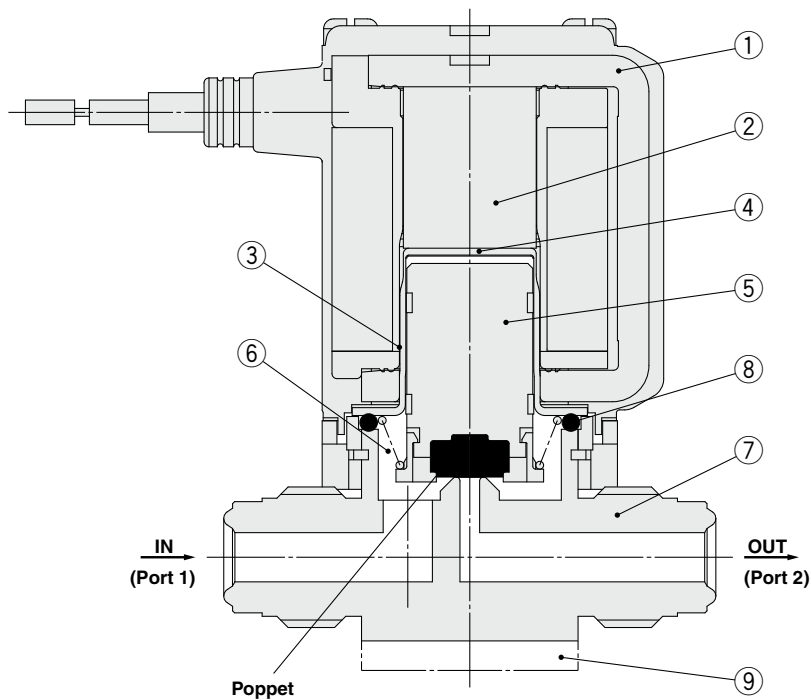

Component Parts

No.	Description	Material
1	Solenoid coil	Cu + Fe + Resin
2	Core	Fe
3	Tube	Stainless steel
4	Seat (PET seat to shut the residual magnetism)	PET
5	Armature assembly	FKM, Stainless steel, Resin (PPS)
6	Spring	Stainless steel
7	Body	Stainless steel
8	O-ring	FKM
9	Spacer	Al

■: Parts in contact with gas

<Option>

⑨ Spacer (Face seal fitting/compression fitting only): The spacer is used to raise the body when fastening it onto a flat area.

<Operating principle>

By energizing the solenoid coil ①, the armature assembly ⑤ overcomes the composite force, which consists of the force acting on the poppet due to differential pressure and the reactive force of the spring ⑥, and is adsorbed to the core ② side, thus opening the poppet.

When the energizing of the solenoid coil ① is canceled, the armature assembly ⑤ is separated from the core ② side by the reactive force of the spring ⑥, thus closing the poppet.

XSA Series

Dimensions: Face Seal Fitting, Compression Fitting

Grommet: G

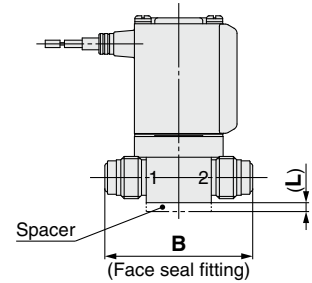
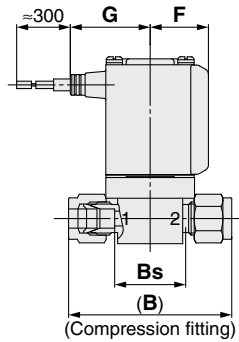
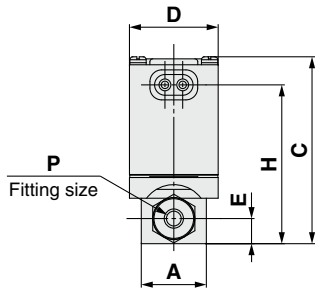
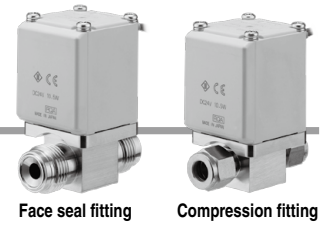

Without spacer

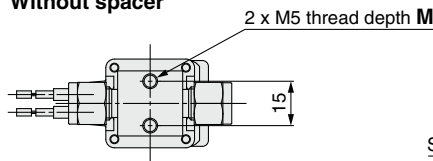

With spacer

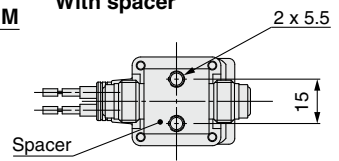

Grommet: GS

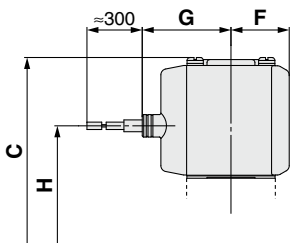

Conduit: C

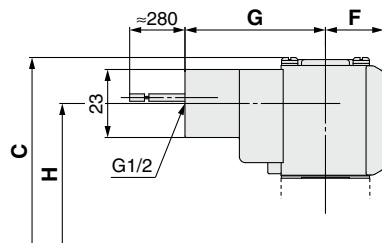

Flat terminal: F

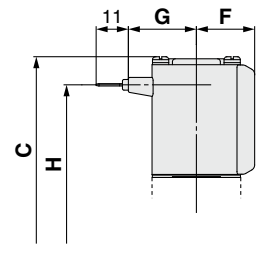
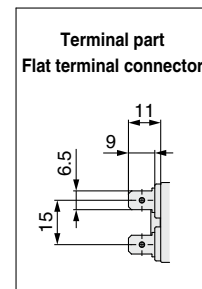

DIN terminal: D

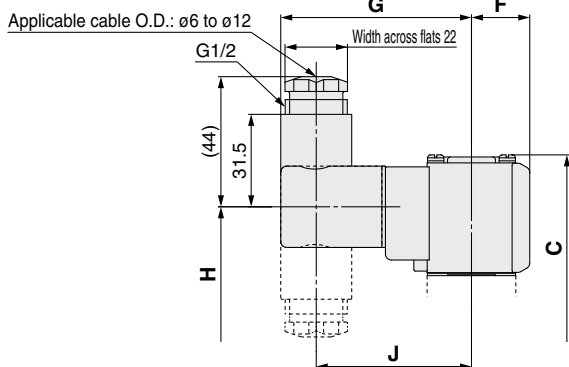

Terminal: T

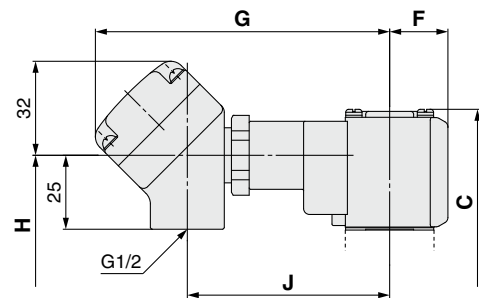

Dimensions

Model	A	B	Bs	C	D	E	F	L	M	P [inch]	Grommet: G		Grommet: GS		Conduit: C		Flat terminal: F		DIN terminal: D			Terminal: T		
											G	H	G	H	G	H	G	H	G	H	J	G	H	J
											XSA1-□2S	22	55	24	63	30	8.5	20	3	8	1/4	27	53.5	30
XSA1-□2V		50	—																					
XSA2-□2S		63	31.5							1/4														
XSA2-□2V		56	—	73.5	35		22			3/8	29.5	63	32.5	49.5	50	57	25.5	63	67	55	55	102	57	71
XSA2-43S		64.5	31							1/4														
XSA2-43V		67	—							3/8														
XSA3-32S	25	63	31.5			11.5		5	10	1/4	32	67.5	35	54	52.5	61.5	28	67.5	69.5	59.5			61.5	
XSA3-32V		56	—	78	40		24.5			3/8														73.5
XSA3-43S		64.5	31																					
XSA3-43V		67	—	82.5																				66



Female thread type

Dimensions: (Rc, NPT) Female Thread

Grommet: G

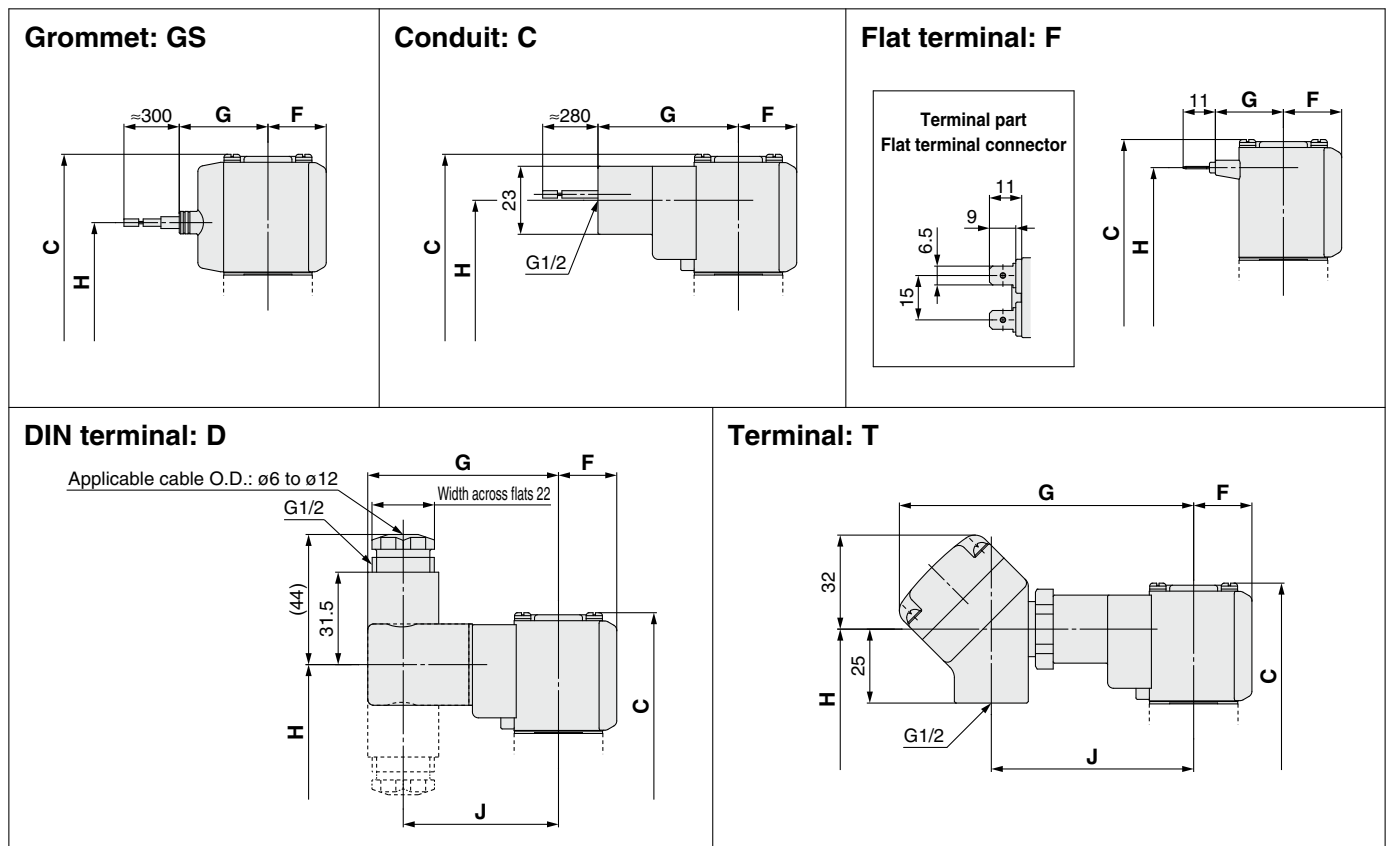
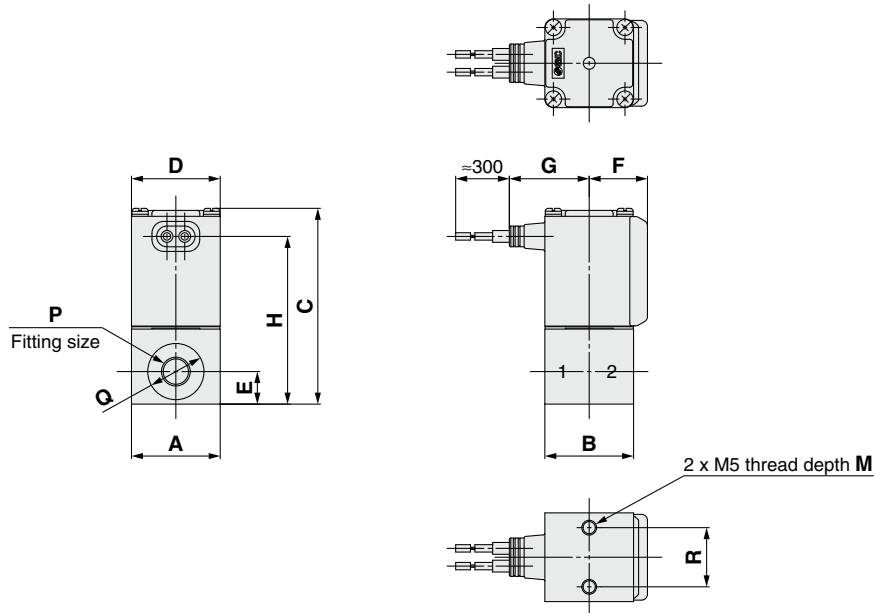

Dimensions

[mm]

Model	A	B	C	D	E	F	M	P	Q	R	Grommet: G		Grommet: GS		Conduit: C		Flat terminal: F		DIN terminal: D			Terminal: T		
											G	H	G	H	G	H	G	H	G	H	J	G	H	J
XSA1-□1P(N)	30	30	66	30	11	20	8	1/8	$\phi 19$	20	27	56.5	30	43	47.5	50.5	23	56.5	64.5	48.5	52.5	99.5	50.5	68.5
XSA2-□2P(N)	36	36	79	35	14	22	10	1/4	$\phi 24$	20	29.5	68.5	32.5	55	50	62.5	25.5	68.5	67	60.5	55	102	62.5	71
XSA3-□3P(N)	40	40	88	40	16.5	24.5		3/8	$\phi 29$	22	32	77.5	35	64	52.5	71.5	28	77.5	69.5	69.5	57.5	104.5	71.5	73.5

XSA Series

Special Option/Replacement Parts

Special Option



Special Electrical Entry Direction

XSA 1-12S-5G2

Enter standard product number.

Special electrical entry direction

Symbol	Electrical entry direction
A	
B	
C	

Replacement Parts

• DIN Connector Part No.

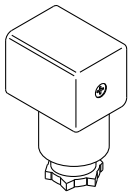

<For Class B Coil>

Electrical option	Rated voltage	Connector part no.
None	24 VDC	C18312G6GCU
	12 VDC	
	100 VAC	
	110 VAC	
	200 VAC	
	220 VAC	
	230 VAC	
	240 VAC	
	24 VAC	
48 VAC		
With light	24 VDC	GDM2A-L5
	12 VDC	GDM2A-L6
	100 VAC	GDM2A-L1
	110 VAC	GDM2A-L1
	200 VAC	GDM2A-L2
	220 VAC	GDM2A-L2
	230 VAC	GDM2A-L2
	240 VAC	GDM2A-L2
	24 VAC	GDM2A-L5
48 VAC	GDM2A-L15	

* Select an appropriate DIN connector suitable for the coil insulation type.

• Gasket Part No. for DIN Connector

VCW20-1-29-1 (For Class B Coil)

• Lead Wire Assembly for Flat Terminal (Set of 2 pcs.)

VX021S-1-16FB



XSA Series Specific Product Precautions 1

Be sure to read this before handling the products. Refer to the back cover for safety instructions. For common precautions, refer to the “Handling Precautions for SMC Products” and the “Operation Manual” on the SMC website: <http://www.smcworld.com>

Design

Warning

- 1. Cannot be used as an emergency shutoff valve, etc.**
The valve presented in this catalog is not designed for safety applications such as an emergency shutoff valve. If valves are used in this type of system, other reliable safety assurance measures should also be adopted.
- 2. Extended periods of continuous energization**
The solenoid coil will generate heat when continuously energized. Avoid using in a tightly shut container. Install the valve in a well ventilated area. Furthermore, do not touch it while it is being energized or right after it has been energized.

Selection

Warning

- 1. Fluid**
 - 1) Type of fluid**
Before using a fluid, check whether it is compatible with the materials of each model by referring to the fluids listed in this catalog. (Refer to the Component Parts on page 4.)
- 2. Fluid quality**

<Air>

 - 1) Use clean air.**
Do not use compressed air that contains chemicals, synthetic oils that include organic solvents, salt, corrosive gases, etc., as it can cause damage or malfunction.
 - 2) Install an air filter, if necessary.**
Install an air filter close to the valve on the upstream side. A filtration size of 5 μm or smaller should be selected.
 - 3) Install an aftercooler or air dryer, if necessary.**
Compressed air that contains excessive drainage may cause the malfunction of the valve or other pneumatic equipment. To prevent this, install an aftercooler, air dryer, etc.
 - 4) If excessive carbon powder is generated, eliminate it by installing a mist separator on the upstream side of the valve.**
If excessive carbon powder is generated by the compressor, it may adhere to the inside of the valve and cause a malfunction.
Refer to “SMC Air Preparation System” for further details on compressed air quality.

<Vacuum>
Vacuum piping direction: Connect the piping so that the pressure in the secondary side is lower.
Avoid the entry of foreign matter.
- 3. Ambient environment**
Use within the operable ambient temperature range. Check the compatibility between the product’s composition materials and the ambient atmosphere. Be certain that the fluid used does not touch the external surface of the product.

Selection

Warning

- 4. Countermeasures against static electricity**
Take measures to prevent static electricity since some fluids can cause static electricity.

Caution

- 1. Leakage voltage**
Particularly when using a resistor in parallel with a switching element and when using a C-R element (surge voltage suppressor) to protect the switching element, take note that leakage current will flow through the resistor, C-R element, etc., which may prevent the valve from turning off.

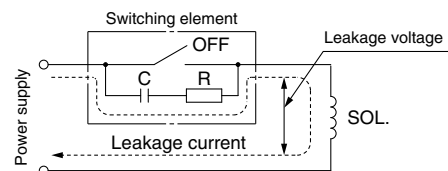

AC coil: 5% or less of the rated voltage
DC coil: 2% or less of the rated voltage

Mounting

Warning

- 1. If air leakage increases or equipment does not operate properly, stop operation.**
After mounting is completed, confirm that it has been done correctly by performing a suitable function test.
- 2. Do not apply external force to the coil section.**
When tightening is performed, apply a wrench or other tool to the outside of the piping connection ports.
- 3. The solenoid valve can be mounted in any direction, but the recommended mounting direction of the coil is upward.**
When mounting a valve with its coil positioned downward, foreign matter in the fluid will adhere to the iron core, leading to a malfunction. Especially for strict leakage control, the coil must be positioned upward.
- 4. Do not warm the coil assembly with a heat insulator, etc.**
Use tape, heaters, etc., for freeze prevention on the piping and body only. Warming the coil can cause it to burn out.
- 5. Avoid sources of vibration, or adjust the arm from the body to the minimum length so that resonance will not occur.**
- 6. Painting and coating**
Warnings or specifications printed or labeled on the product should not be erased, removed, or covered up.



XSA Series

Specific Product Precautions 2

Be sure to read this before handling the products. Refer to the back cover for safety instructions. For common precautions, refer to the “Handling Precautions for SMC Products” and the “Operation Manual” on the SMC website: <http://www.smcworld.com>

Piping

⚠ Caution

- 1. Preparation before piping**
Before mounting, clean the sealing surface with ethanol, etc.
- 2. Avoid connecting ground lines to piping, as this may cause the electric corrosion of the system.**
- 3. Tightening**
Tighten the fitting or female thread as follows.
After tightening, confirm that there is no leakage from the fitting.

Tightening of Fitting

Face seal fitting	1/8 turn after tightening by hand
Compression fitting	1 1/4 turns after tightening by hand

Tightening of Female Thread

NPT, Rc1/8	7 to 9 N·m
NPT, Rc1/4	12 to 14 N·m
NPT, Rc3/8	22 to 24 N·m

- 4. Connection of piping to products**
When connecting piping to a product, avoid mistakes regarding the supply port, etc.

Wiring

⚠ Warning

- 1. The solenoid valve is an electrical product. For safety, install an appropriate fuse and circuit breaker before use.**
When using multiple solenoid valves, it is not sufficient to merely install one fuse on the inlet side. In order to ensure the safety of the devices, select and install a fuse for each circuit.

⚠ Caution

- 1. As a rule, use electrical wire with a cross sectional area of 0.5 to 1.25 mm² for wiring.**
Furthermore, do not allow excessive force to be applied to the lines.
- 2. Use electrical circuits which do not generate chattering in their contacts.**
- 3. Use a voltage which is within ±10% of the rated voltage.** In cases with a DC power supply where importance is placed on responsiveness, stay within ±5% of the rated value. The voltage drop is the value in the lead wire section connecting the coil.
- 4. When a surge from the solenoid affects the electrical circuitry, install a surge voltage suppressor, etc., in parallel with the solenoid. Or, select an option that comes with a surge voltage protection circuit. (However, a surge voltage occurs even if the surge voltage protection circuit is used. For details, please consult with SMC.)**

Operating Environment

⚠ Warning

- 1. Do not use in an atmosphere containing corrosive gases, chemicals, sea water, water, water vapor, or where there is direct contact with any of these.**
- 2. Do not use in explosive atmospheres.**
- 3. Do not use in locations subject to vibration or impact.**
- 4. Do not use in locations where radiated heat will be received from nearby heat sources.**
- 5. Employ suitable protective measures in locations where there is contact with water droplets, oil, welding spatter, etc.**

Maintenance

⚠ Warning

- 1. Removing the product**
Confirm that the valve temperature has dropped sufficiently before performing work. If touched inadvertently, there is a danger of being burned.
1) Shut off the fluid supply and release the fluid pressure in the system.
2) Shut off the power supply.
3) Dismount the product.
- 2. Low frequency operation**
Switch valves at least once every 30 days to prevent a malfunction. Also, in order to use them under the optimum state, conduct a regular inspection biannually.

Electrical Connections

⚠ Caution

■ Grommet

Class B coil: AWG20 Insulator O.D. 2.5 mm

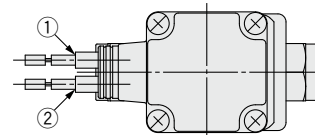

Rated voltage	Lead wire color	
	①	②
DC	Black	Red
100 VAC	Blue	Blue
200 VAC	Red	Red
Other AC	Gray	Gray

* There is no polarity.



XSA Series Specific Product Precautions 3

Be sure to read this before handling the products. Refer to the back cover for safety instructions. For common precautions, refer to the "Handling Precautions for SMC Products" and the "Operation Manual" on the SMC website: <http://www.smcworld.com>

Electrical Connections

⚠ Caution

■ DIN terminal

Internal connections for the DIN terminal are shown below. Please make connections to the power supply accordingly.

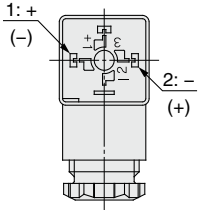

Terminal no.	1	2
DIN terminal	+ (-)	- (+)

- * There is no polarity.
- Use a heavy-duty cord with a cable O.D. of $\phi 6$ to $\phi 12$ mm.
- Use the tightening torques below for each section.

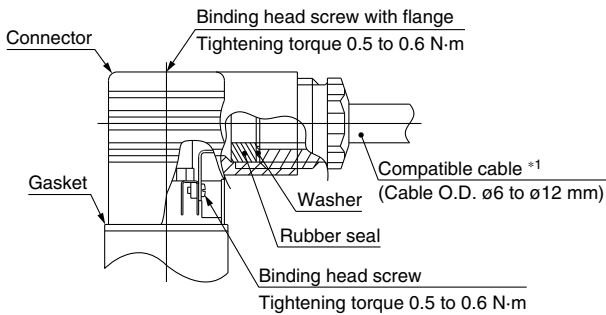

*1 For cables with an O.D. of $\phi 9$ to $\phi 12$ mm, remove the internal parts of the rubber seal before using.

Pitch between the terminals

This DIN terminal corresponds to the Form A DIN connector with an 18 mm terminal pitch, which complies with EN175301-803B.

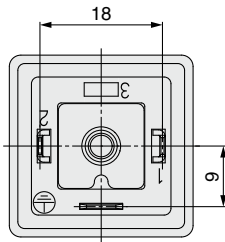

■ Conduit terminal

In the case of the conduit terminal, make connections according to the marks shown below.

- Use the tightening torques below for each section.
- Properly seal the terminal connection (G1/2) with the special wiring conduit, etc.

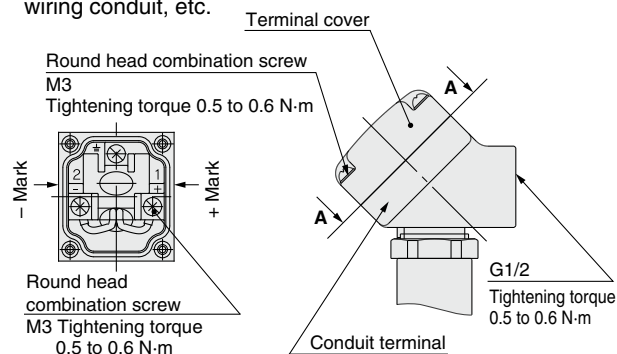

View A-A

(Internal connection diagram)

Electrical Connections

⚠ Caution

■ Conduit

Use the tightening torque below for the conduit.
Class B coil: AWG20 Insulator O.D. 2.5 mm

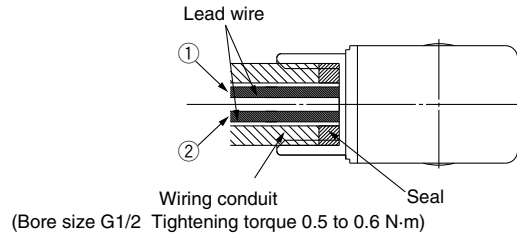

Rated voltage	Lead wire color	
	①	②
DC	Black	Red
100 VAC	Blue	Blue
200 VAC	Red	Red
Other AC	Gray	Gray

* There is no polarity.

Description	Part no.
Seal	VCW20-15-6

* Please order separately.

Electrical Circuits

⚠ Caution

[DC circuit]

Grommet, Flat terminal

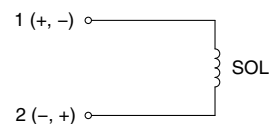

Without electrical option

Grommet, DIN terminal, Conduit terminal, Conduit

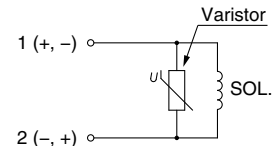

With surge voltage suppressor

DIN terminal, Conduit terminal

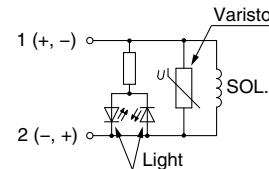

With light/surge voltage suppressor

[AC circuit]

* For AC, the standard product is equipped with a surge voltage suppressor.

Grommet, DIN terminal, Conduit terminal, Conduit

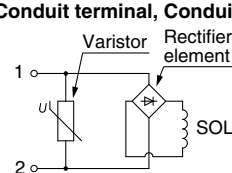

Without electrical option

DIN terminal, Conduit terminal

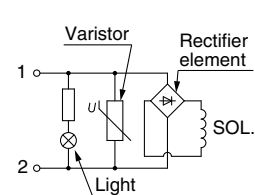



With light/surge voltage suppressor

Safety Instructions

These safety instructions are intended to prevent hazardous situations and/or equipment damage. These instructions indicate the level of potential hazard with the labels of “**Caution**,” “**Warning**” or “**Danger**.” They are all important notes for safety and must be followed in addition to International Standards (ISO/IEC)*1), and other safety regulations.

 **Caution:** **Caution** indicates a hazard with a low level of risk which, if not avoided, could result in minor or moderate injury.

 **Warning:** **Warning** indicates a hazard with a medium level of risk which, if not avoided, could result in death or serious injury.

 **Danger :** **Danger** indicates a hazard with a high level of risk which, if not avoided, will result in death or serious injury.

*1) ISO 4414: Pneumatic fluid power – General rules relating to systems.
ISO 4413: Hydraulic fluid power – General rules relating to systems.
IEC 60204-1: Safety of machinery – Electrical equipment of machines.
(Part 1: General requirements)
ISO 10218-1: Manipulating industrial robots – Safety.
etc.

Warning

1. The compatibility of the product is the responsibility of the person who designs the equipment or decides its specifications.

Since the product specified here is used under various operating conditions, its compatibility with specific equipment must be decided by the person who designs the equipment or decides its specifications based on necessary analysis and test results. The expected performance and safety assurance of the equipment will be the responsibility of the person who has determined its compatibility with the product. This person should also continuously review all specifications of the product referring to its latest catalog information, with a view to giving due consideration to any possibility of equipment failure when configuring the equipment.

2. Only personnel with appropriate training should operate machinery and equipment.

The product specified here may become unsafe if handled incorrectly. The assembly, operation and maintenance of machines or equipment including our products must be performed by an operator who is appropriately trained and experienced.

3. Do not service or attempt to remove product and machinery/equipment until safety is confirmed.

1. The inspection and maintenance of machinery/equipment should only be performed after measures to prevent falling or runaway of the driven objects have been confirmed.
2. When the product is to be removed, confirm that the safety measures as mentioned above are implemented and the power from any appropriate source is cut, and read and understand the specific product precautions of all relevant products carefully.
3. Before machinery/equipment is restarted, take measures to prevent unexpected operation and malfunction.

4. Contact SMC beforehand and take special consideration of safety measures if the product is to be used in any of the following conditions.

1. Conditions and environments outside of the given specifications, or use outdoors or in a place exposed to direct sunlight.
2. Installation on equipment in conjunction with atomic energy, railways, air navigation, space, shipping, vehicles, military, medical treatment, combustion and recreation, or equipment in contact with food and beverages, emergency stop circuits, clutch and brake circuits in press applications, safety equipment or other applications unsuitable for the standard specifications described in the product catalog.
3. An application which could have negative effects on people, property, or animals requiring special safety analysis.
4. Use in an interlock circuit, which requires the provision of double interlock for possible failure by using a mechanical protective function, and periodical checks to confirm proper operation.

Caution

1. The product is provided for use in manufacturing industries.

The product herein described is basically provided for peaceful use in manufacturing industries.
If considering using the product in other industries, consult SMC beforehand and exchange specifications or a contract if necessary.
If anything is unclear, contact your nearest sales branch.

Limited warranty and Disclaimer/ Compliance Requirements

The product used is subject to the following “Limited warranty and Disclaimer” and “Compliance Requirements”.

Read and accept them before using the product.

Limited warranty and Disclaimer

1. The warranty period of the product is 1 year in service or 1.5 years after the product is delivered, whichever is first.*2)
Also, the product may have specified durability, running distance or replacement parts. Please consult your nearest sales branch.
2. For any failure or damage reported within the warranty period which is clearly our responsibility, a replacement product or necessary parts will be provided.
This limited warranty applies only to our product independently, and not to any other damage incurred due to the failure of the product.
3. Prior to using SMC products, please read and understand the warranty terms and disclaimers noted in the specified catalog for the particular products.

*2) Vacuum pads are excluded from this 1 year warranty.

A vacuum pad is a consumable part, so it is warranted for a year after it is delivered.
Also, even within the warranty period, the wear of a product due to the use of the vacuum pad or failure due to the deterioration of rubber material are not covered by the limited warranty.

Compliance Requirements

1. The use of SMC products with production equipment for the manufacture of weapons of mass destruction (WMD) or any other weapon is strictly prohibited.
2. The exports of SMC products or technology from one country to another are governed by the relevant security laws and regulations of the countries involved in the transaction. Prior to the shipment of a SMC product to another country, assure that all local rules governing that export are known and followed.

Caution

SMC products are not intended for use as instruments for legal metrology.

Measurement instruments that SMC manufactures or sells have not been qualified by type approval tests relevant to the metrology (measurement) laws of each country. Therefore, SMC products cannot be used for business or certification ordained by the metrology (measurement) laws of each country.

Revision History

Edition B * Female thread type added

UZ

Safety Instructions

Be sure to read the “Handling Precautions for SMC Products” (M-E03-3) and “Operation Manual” before use.