

3 Port Solenoid Valve Pilot Operated Poppet Type VG342 Series

Rubber Seal



[Option]
Note) CE-compliant. For DIN terminal only

Low power consumption

4 W DC (Standard type)
1.8 W DC (Energy-saving type)

No lubrication required

Possible to use in vacuum or under low pressures

External pilot
Vacuum: Up to -101.2 kPa
Low pressure: 0 to 0.2 MPa

Changeable actuation: N.C., N.O., or external pilot

Can be used as a selector or divider valve (External pilot)

External Pilot

Use external pilot type in the following cases:

- For vacuum or for low pressure 0.2 MPa or less
- When having P port downsized in diameter
- When using A port as the atmospheric releasing port, e.g. air blower



Symbol

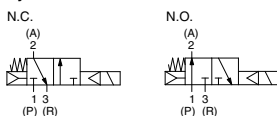

External pilot

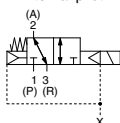

How to Order

VG342 - 1 G - 04 A - -

Valve type

Nil	Internal pilot
R	External pilot

Rated voltage

1	100 VAC, 50/60 Hz
2	200 VAC, 50/60 Hz
3	110 VAC, 50/60 Hz
4	220 VAC, 50/60 Hz
5	24 VDC
6	12 VDC
7	240 VAC, 50/60 Hz

Electrical entry

G	Grommet	CE-compliant	—
D	DIN terminal	—	●

Light/Surge voltage suppressor

Nil	None
S	With surge voltage suppressor (Only grommet type is only available.)
Z	With light/surge voltage suppressor (Except grommet type)

CE-compliant

Nil	—
Q	CE-compliant (Note)

Note) Applicable only for DIN terminal type

Pilot valve option

Nil	Standard type
Y	Energy-saving type (DC only)
E	Continuous duty type

Passage symbol

Nil	External pilot
A	N.C. (Normally closed)
B	N.O. (Normally open)

Thread type

Nil	Rc
F	G
N	NPT
T	NPTF

Port size

04	1/2
06	3/4
10	1

How to Order Pilot Valve Assembly

VO307 - 1 G 1 - X84 -

Pilot valve option

Nil	Standard type
Y	Energy-saving type (DC only)
E	Continuous duty type

Rated voltage

1	100 VAC, 50/60 Hz
2	200 VAC, 50/60 Hz
3	110 VAC, 50/60 Hz
4	220 VAC, 50/60 Hz
5	24 VDC
6	12 VDC
7	240 VAC, 50/60 Hz

CE-compliant

Nil	—
Q	CE-compliant (Note)

Note) Applicable only for DIN terminal type

Pilot valve assembly for VG342

Light/Surge voltage suppressor

Nil	None
S	With surge voltage suppressor (Only grommet type is available.)
Z	With light/surge voltage suppressor (Except grommet type)

Electrical entry

G	Grommet	CE-compliant	—
D	DIN terminal	—	●

VG342 Series

⚠ Caution

Light/Surge Voltage Suppressor

AC, 100 V or more

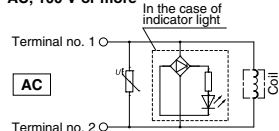

48 VDC or less

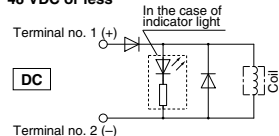

Electrical Connection

In the case of DIN terminal (with light/surge voltage suppressor), the connection is as follows. Connect each to the power supply side.

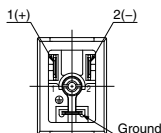

How to Change Passage State

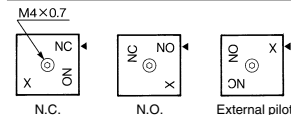

When changing the passage state, confirm that pressure has been removed from the valve.

Unscrew the M4 x 0.7 hexagon socket head cap screw in the changeover plate and match the ◀ mark on the adapter plate with the character on the changeover plate. Piping is as follows.

Mounting Screw Tightening Torques

M4: 1.4 N·m

Piping

Passage	Port	P	A	R
N.C.		Inlet	Outlet	Exhaust side (Plug, in case of 2 port valve)
N.O.		Exhaust side (Plug, in case of 2 port valve)	Outlet	Inlet
External		Universal porting (Piping of inlet pressure side is possible anywhere)		

Note 1) In the case of internal pilot, confirm that a plug is inserted to X port. If not, insert a R 1/8 plug.

Note 2) In the case of external pilot, supply air pressure from X port.

Confirm the safety sufficiently and conduct carefully when changing the passage state or restarting after changes.

Specifications

Type of actuation	In common between N.C. and N.O.	
Fluid	Air	
Operation	Internal pilot type	External pilot type
Operating pressure range	0.2 to 0.9 MPa	-101.2 kPa to 0.9 MPa
External pilot operating pressure range	—	Same as the operating pressure (Min. 0.2 MPa)
Response time ⁽¹⁾	30 ms or less (at the pressure of 0.5 MPa)	
Max. operating frequency	5 c/s (Min. operating frequency: 1 c/30 days based on JIS B 8374-1981)	
Ambient and fluid temperature	-10 to 50°C (No freezing)	
Lubrication	Not required (Use turbine oil Class 1 ISO VG32, if lubricated.)	
Manual override	Push type (Non-locking)	
Mounting orientation	Unrestricted	
Impact/Vibration resistance (m/s ²) ⁽²⁾	150/50	
Weight	1.0 kg	

Note 1) Based on dynamic performance test JIS B 8419: 2010. (Coil temperature 20°C, at rated voltage, without surge voltage suppressor)

Note 2) Impact resistance: No malfunction occurred when it is tested with a drop tester in the axial direction and at the right angles to the main valve and armature in both energized and de-energized states every once for each condition. (Values at the initial period)

Vibration resistance: No malfunction occurred in a one-sweep test between 45 and 1000 Hz. Test was performed at both energized and de-energized states in the axial direction and at the right angles to the main valve and armature. (Values at the initial period)

Flow Rate Characteristics

Port size	Flow rate characteristics											
	1 → 2 (P → A)		2 → 3 (A → R)		2 → 1 (A → P)		3 → 2 (R → A)					
	C (dm ³ /s/bar)	b Cv	C (dm ³ /s/bar)	b Cv	C (dm ³ /s/bar)	b Cv	C (dm ³ /s/bar)	b Cv	b Cv	b Cv		
1/2	26	0.38	7.0	27	0.37	7.4	27	0.36	7.3	25	0.37	6.8
3/4	38	0.30	9.8	38	0.32	9.8	40	0.22	9.8	40	0.20	9.6

Port size	Effective area (mm ²)	
	1 → 2 (P → A)	2 → 3 (A → R)
1	210	235

Pilot Valve Assembly Specifications

Electrical entry	Grommet (G), DIN terminal (D)	
Lead wire color	100 VAC: Blue, 200 VAC: Red, 24 VDC: Red/Black	
Enclosure	Dusttight	
Coil rated voltage (V)	AC (50/60 Hz)	100, 200, 110, 220, 240
	DC	24, 12
Allowable voltage fluctuation	-15 to +10% of rated voltage	
Apparent power VA (Hz)	AC	12.7 (50), 10.7 (60)
	Inrush Holding	7.6 (50), 5.4 (60)
Power consumption	DC	
	Without indicator light: 4 W With indicator light: 4.2 W	

Energy-saving type: VG342□-□□□-□□□-Y (-Q)

Use "Energy-saving type" if low power consumption is required for electronic control.
* DC only

Specifications different from standard are as follows.

Power consumption	DC	Without indicator light: 1.8 W With indicator light: 2 W
-------------------	----	---

Continuous duty type: VG342□-□□□-□□□-E (-Q)

Use "Continuous duty type" if energizing the valve for a long time.

Specifications different from standard are as follows.

Apparent power VA (Hz)	AC	Inrush	7.9 (50), 6.2 (60)
		Holding	5.8 (50), 3.5 (60)
Power consumption	DC	Without indicator light: 1.8 W With indicator light: 2 W	

DIN Connector part number

Standard	B1B09-2A
CE-compliant	GM209NJ-B17

VG342 Series

Dimensions

Grommet (G)

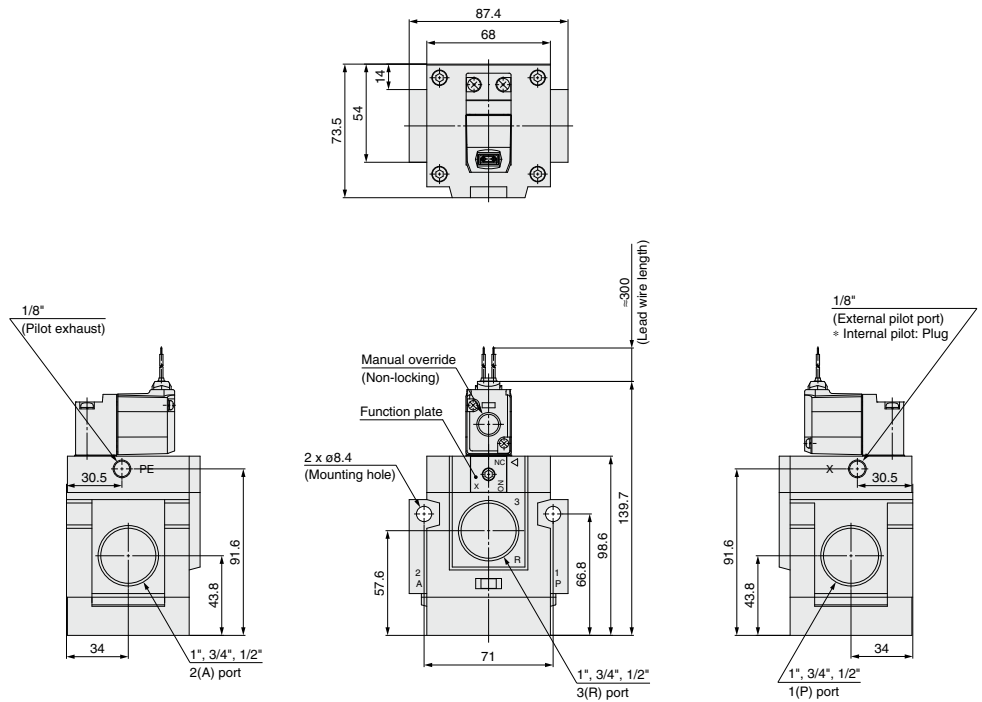

3 Port Solenoid Valve Pilot Operated Poppet Type **VG342 Series**

Dimensions

DIN terminal (D)

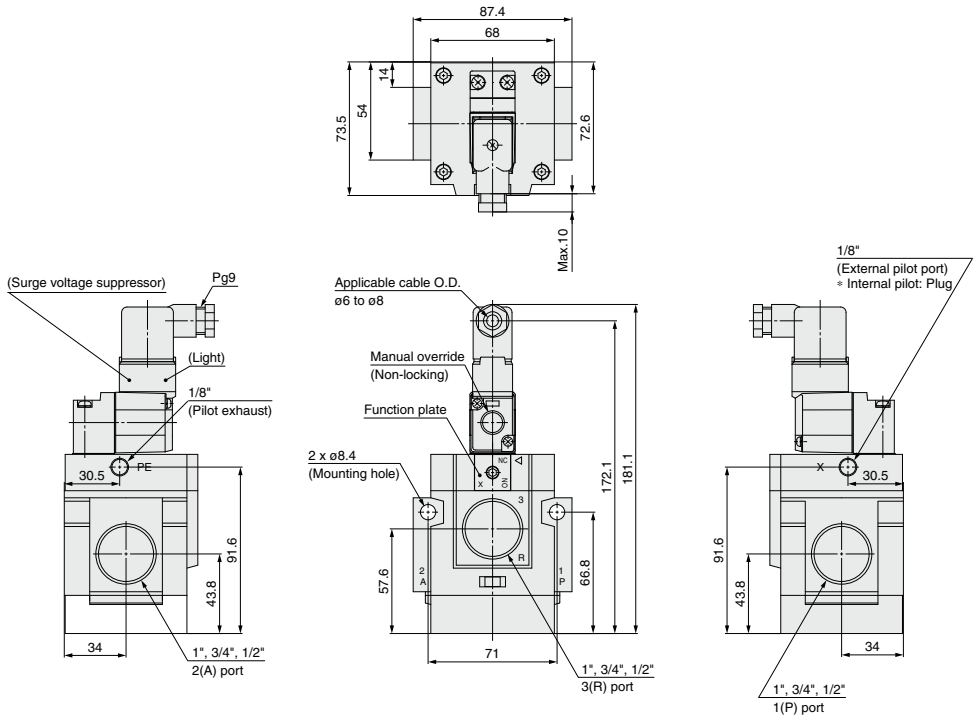

SYJ

VQZ

VP

VG

VP3