

5 Port Air Operated Valve

VFA1000/3000/5000 Series

RoHS



SYA

SYJA

VZA

VFA

VFRA

VPA4

SYJA

VZA

VTA















VGA

VPA

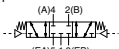
VPA3

Model Selection by Operating Conditions ①

Air Operated Valve: Single Unit

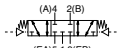
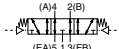
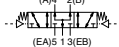
Series	Sonic conductance C[dm ³ /(s·bar)]	Type of actuation	Port size	Pilot port direction
Body ported	VFA1000 	2 position single VFA1000 (B)2 4(A)  (EB)3 1 5(EA) (P)	M5 x 0.8 1/8	Upward  Lateral 
		VFA3000 VFA5000 (A)4 2(B)  (EA)5 1 3(EB) (P)		
	VFA3000 	2 position double VFA1000 (B)2 4(A)  (EB)3 1 5(EA) (P)	1/8 1/4	
VFA5000 	3 position closed center  (EA)5 1 3(EB) (P)	1/4 3/8		
	3 position exhaust center  (EA)5 1 3(EB) (P)			
	3 position pressure center  (EA)5 1 3(EB) (P)			
Base mounted	VFA3000 	2 position single (A)4 2(B)  (EA)5 1 3(EB) (P)	1/4 3/8	
		2 position double (A)4 2(B)  (EA)5 1 3(EB) (P)		
	VFA5000 	3 position closed center  (EA)5 1 3(EB) (P)	1/4 3/8 1/2	
	3 position exhaust center  (EA)5 1 3(EB) (P)			
	3 position pressure center  (EA)5 1 3(EB) (P)			

Model Selection by Operating Conditions ②

Air Operated Valve: Manifold

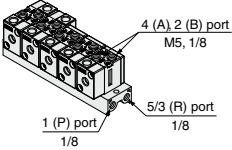
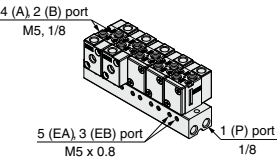
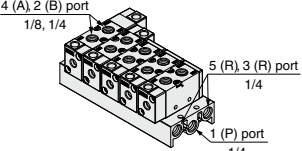
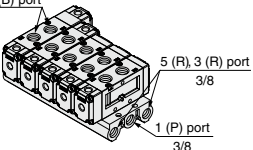
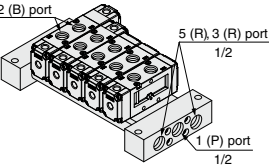
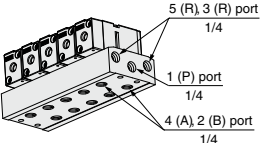
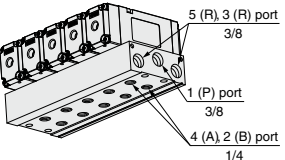
Series	EXH port type	Manifold base model	Applicable valve model	Applicable stations
Body ported	Common EXH	VV5FA1-30 	VFA1□30	2 to 20 stations
		VV5FA1-31 		
	Common EXH	VV5FA3-30 	VFA3□30	2 to 20 stations
		VV5FA5-20 	VFA5□20	2 to 10 stations
Common EXH	VV5FA5-21 		2 to 15 stations	
	Common EXH	VV5FA3-40 	VFA3□40	2 to 20 stations
Common EXH		VV5FA5-40 	VFA5□44	2 to 10 stations

- SYA
- SYJA
- VZA
- VFA
- VFRA
- VPA4
- SYJA
- VZA
- VTA
- VGA
- VPA
- VPA3

P.1512

P.1518

5 Port Air Operated Valve

VFA1000/3000/5000 Series Single Unit

Body Ported



How to Order Valve

Body ported VFA 3 1 3 0 - 01 - - -

Series

1	VFA1000
3	VFA3000
5	VFA5000

Type of actuation

1	2 position single
2	2 position double
3	3 position closed center
4	3 position exhaust center
5	3 position pressure center

* Only 1 and 2 are available with the VFA1000.

Body model

Symbol	VFA1000	VFA3000	VFA5000
2	○	—	○
3	—	○	—

A, B port size

Symbol	Port size	VFA1000	VFA3000	VFA5000
M5	M5 x 0.8	○	—	—
01	1/8	○	○	—
02	1/4	—	○	○
03	3/8	—	—	○

Thread type (Including pilot port)

Nil	Rc
F	G
N	NPT
T	NPTF

* M5 is available with Nil only.

Pilot port direction

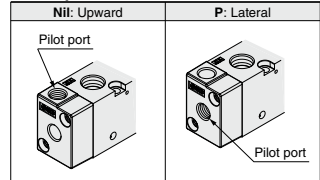

Bracket

Nil	Without bracket
F	With bracket

VFA1000, 3000
Single type
(The bracket cannot be connected after delivered.)

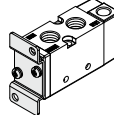

VFA1000
Double type only

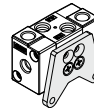

* Not available with the VFA5000.

5 Port Air Operated Valve Body Ported/Single Unit **VFA1000/3000/5000 Series**

Specifications



VFA1000 series



VFA3000 series

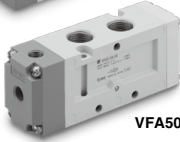

VFA5000 series

Model		VFA1000	VFA3000	VFA5000
Fluid		Air		
Operating pressure range (MPa)	2 position single	0.15 to 1.0		
	2 position double/3 position ^{Note 2)}	-101.2 kPa to 1.0		
Pilot pressure range (MPa)	2 position single	(0.4 x P + 0.1) to 1.0, P: Operating pressure		
	2 position double	0.1 to 1.0		
	3 position	0.15 to 1.0		
Ambient and fluid temperature (°C)		-10 to 50 (No freezing)		
Lubrication		Not required		
Mounting orientation		Free		
Impact/Vibration resistance (m/s ²) ^{Note 1)}		300/50		

Note 1) Impact resistance: No malfunction to axis and right angle directions of main valve, each one time when pilot signal ON and OFF. (Values at the initial period)

Vibration resistance: No malfunction from test with 45 to 2000 Hz one sweep, to axis and right angle direction of main valve, each one time when pilot signal ON and OFF. (Values at the initial period)

Note 2) Except VFA1000

Pilot Pressure Range (Single pilot)

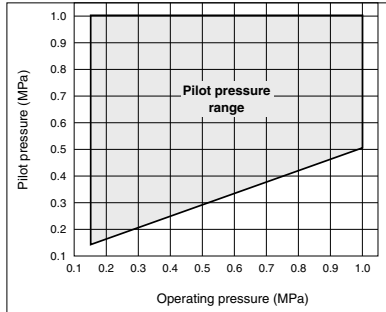

SYA

SYJA

VZA

VFA

VFRA

VPA4

SYJA

VZA

VTA

VGA

VPA

VPA3

VFA 1000/3000/5000 Series

Flow Rate Characteristics/Weights

Valve model	Type of actuation		Port size		Flow rate characteristics ^{Note 1)}						Weight (g) ^{Note 2)}
			1, 4, 2 (P, A, B)	5, 3 (EA, EB)	1→4/2 (P→A/B)			4/2→5/3 (A/B→EA/EB)			
					C[dm ³ /s/bar]	b	Cv	C[dm ³ /s/bar]	b	Cv	
VFA1□20-M5	2 position	Single	M5 x 0.8		0.49	0.40	0.13	0.52	0.35	0.13	97
		Double			0.49	0.40	0.13	0.52	0.35	0.13	120
VFA1□20-01	2 position	Single	1/8	M5 x 0.8	0.76	0.22	0.17	0.53	0.28	0.13	93
		Double			0.76	0.22	0.17	0.53	0.28	0.13	116
VFA3□30-01	2 position	Single	1/8		3.0	0.38	0.78	2.8	0.30	0.67	135
		Double			3.0	0.38	0.78	2.8	0.30	0.67	158
	3 position	Closed center			2.4	0.31	0.64	1.8	0.37	0.46	175
		Exhaust center			2.6	0.37	0.70	3.0 [2.5]	0.32 [0.28]	0.76 [0.62]	
		Pressure center			3.0	0.42	0.83	2.4	0.27	0.59	
					3.0 [1.4]	0.42 [0.44]	0.83 [0.39]	2.4	0.27	0.59	
VFA3□30-02	2 position	Single	1/4	1/8	4.0	0.36	1.0	3.1	0.32	0.75	131
		Double			4.0	0.36	1.0	3.1	0.32	0.75	154
	3 position	Closed center			2.4	0.45	0.68	1.9	0.37	0.47	171
		Exhaust center			3.0	0.42	0.82	3.1 [2.7]	0.36 [0.29]	0.79 [0.66]	
		Pressure center			5.5	0.37	1.4	2.6	0.32	0.64	
					5.5 [1.4]	0.37 [0.50]	1.4 [0.40]	2.6	0.32	0.64	
VFA5□20-02	2 position	Single	1/4		7.1	0.46	1.9	7.7	0.51	2.2	294
		Double			7.1	0.46	1.9	7.7	0.51	2.2	329
	3 position	Closed center			6.7	0.46	1.8	6.6	0.41	1.8	368
		Exhaust center			7.1	0.42	1.9	8.0 [7.4]	0.45 [0.47]	2.2 [2.1]	
		Pressure center			6.8	0.51	2.0	5.7	0.37	1.4	
					6.8 [2.7]	0.51 [0.50]	2.0 [0.78]	5.7	0.37	1.4	
VFA5□20-03	2 position	Single	3/8		8.8	0.44	2.4	10.0	0.49	2.9	280
		Double			8.8	0.44	2.4	10.0	0.49	2.9	315
	3 position	Closed center			7.5	0.43	2.0	7.5	0.38	1.9	354
		Exhaust center			8.3	0.40	2.2	10.0 [8.7]	0.48 [0.46]	3.0 [2.4]	
		Pressure center			9.2	0.50	2.6	6.1	0.35	1.6	
					9.2 [3.0]	0.50 [0.49]	2.6 [0.85]	6.1	0.35	1.6	

Note 1) [] : Normal position
 Note 2) Values without bracket

Construction: Body Ported

2 position single

Symbol
2 position single

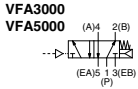
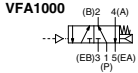

VFA1000

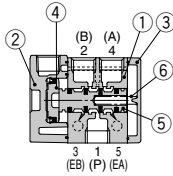

VFA3000, 5000

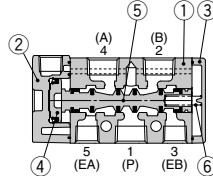

2 position double

Symbol
2 position double

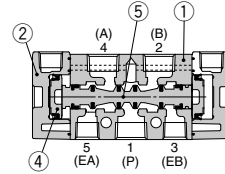
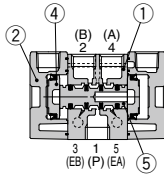
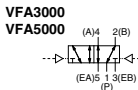
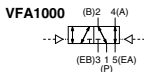

3 position closed center/exhaust center/pressure center

Symbol
3 position closed center

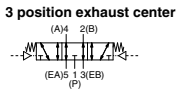
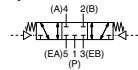

3 position exhaust center



3 position pressure center

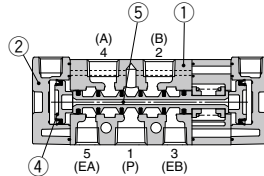
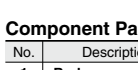

(Drawing shows a closed center type.)

Component Parts

No.	Description	Material	Note
1	Body	Aluminum die-casted	White
2	Pilot plate	Aluminum die-casted	Gray
3	End plate	Resin (VFA3130-F : Aluminum die-casted)	White
4	Piston	Resin	
5	Spool valve	Aluminum, HNBR	
6	Spring	Stainless steel	

Bracket Assembly Part No.

Description	Part no.
Bracket (for VFA1000 double)	DXT144-8-1A (With 2 mounting screws)

SYA
SYJA
VZA
VFA
VFRA
VPA4
SYJA
VZA
VTA
VGA
VPA
VPA3

VFA 1000/3000/5000 Series

Dimensions: VFA1000 Series/Body Ported

2 position single VFA1120-M5□(-F)(-P)

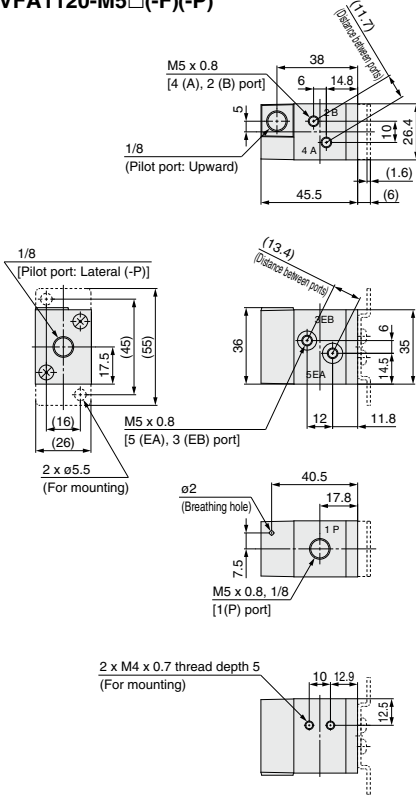

VFA1120-01□(-F)(-P)

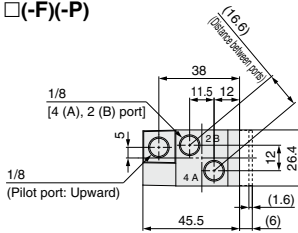

2 position double VFA1220-M5□(-F)(-P)

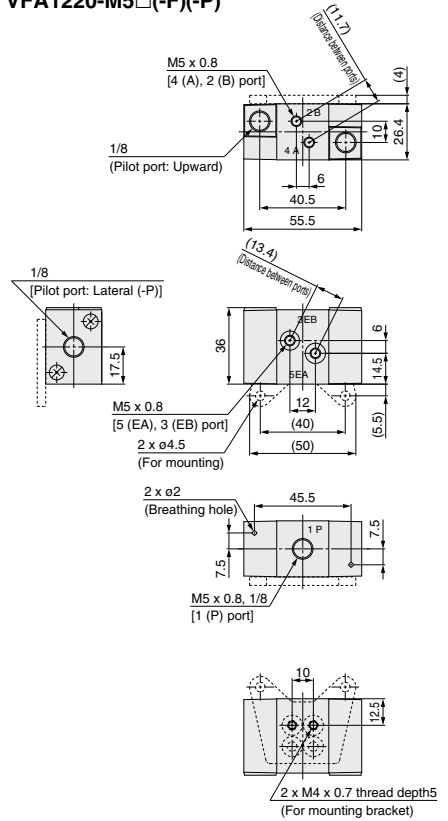

VFA1220-01□(-F)(-P)

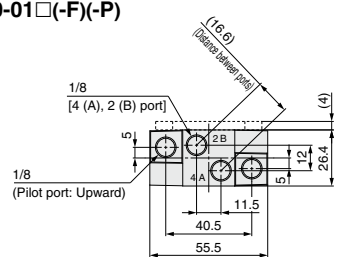

Dimensions: VFA3000 Series/Body Ported

2 position single

VFA3130-01□(-F)(-P)

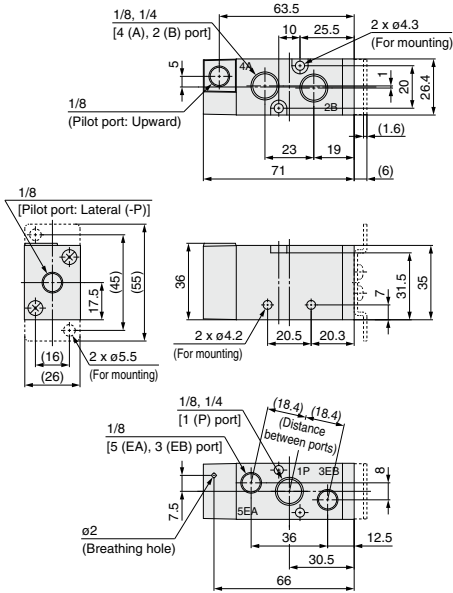

2 position double

VFA3230-01□(-P)

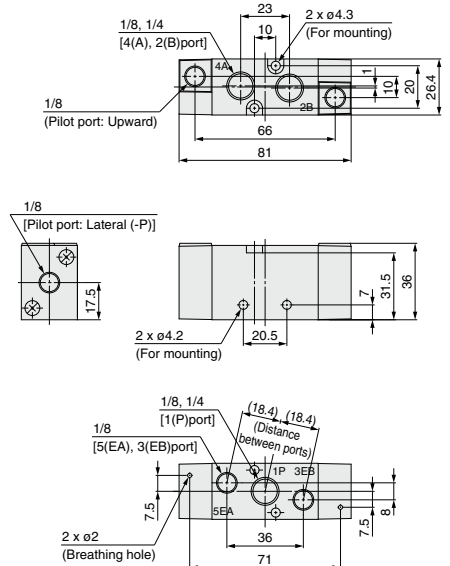

3 position closed center/exhaust center/pressure center

VFA3³₅430-01□(-P)

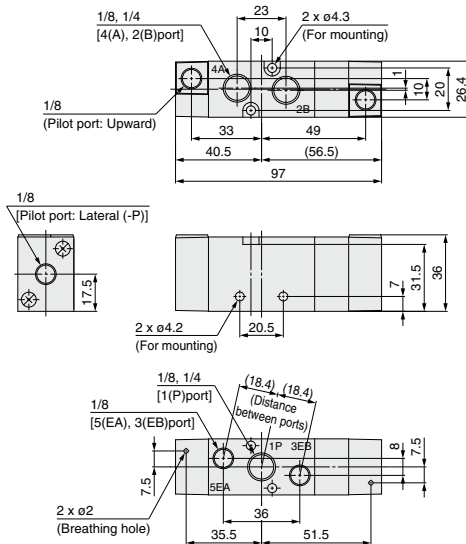

SYA
SYJA
VZA
VFA
VFRA
VPA4
SYJA
VZA
VTA
VGA
VPA
VPA3

VFA 1000/3000/5000 Series

Dimensions: VFA5000 Series/Body Ported

2 position single

VFA5120-⁰²₀₃□(-P)

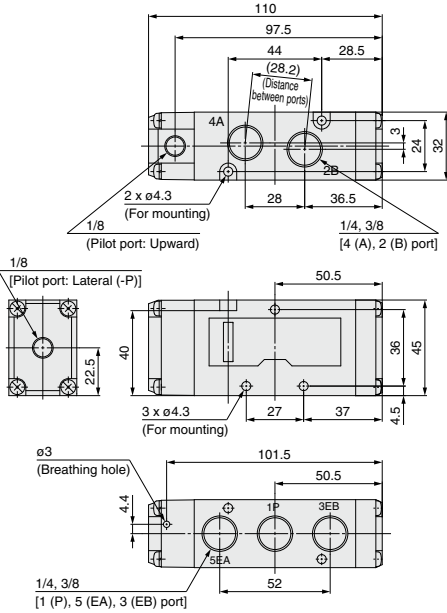

2 position double

VFA5220-⁰²₀₃□(-P)

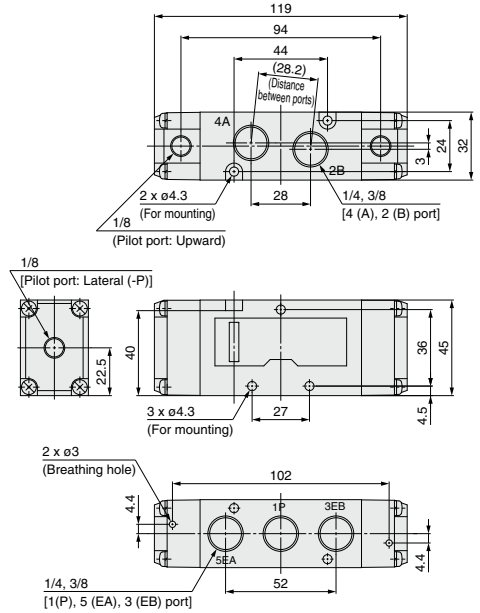

3 position closed center/exhaust center/pressure center

VFA5³₅4²⁰-⁰²₀₃□(-P)

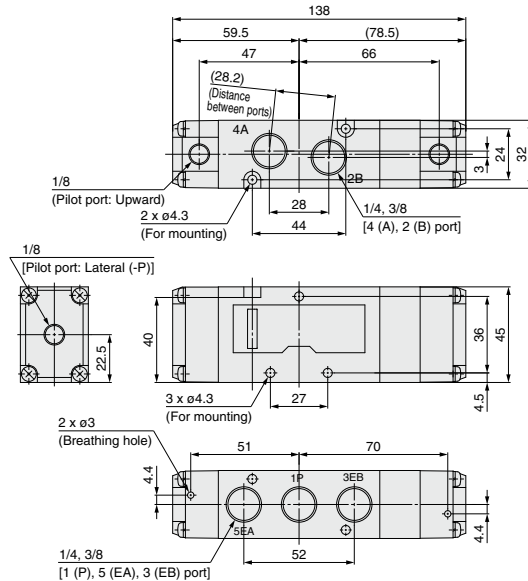

5 Port Air Operated Valve

VFA3000/5000 Series

Single Unit

Base Mounted



How to Order Valve

Base mounted
(VFA1000: Not available)

VFA **3** **1** **4** **0** - **02** -

Series

3	VFA3000
5	VFA5000

* Not available with the VFA1000.

Type of actuation

1	2 position single
2	2 position double
3	3 position closed center
4	3 position exhaust center
5	3 position pressure center

Body model

Body option

Symbol	VFA3000	VFA5000
0	○	—
4	—	○

Port size (Sub-plate)

Symbol	Port size	VFA3000	VFA5000
Nil	Without sub-plate (Pilot port: Rc)		
00	Without sub-plate (Pilot port: Other than Rc)		
02	1/4	○	○
03	3/8	○	○
04	1/2	—	○

* Without the sub-plate, two mounting screws and a gasket are included.

Pilot port direction

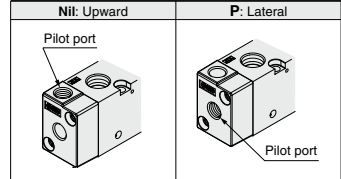

Thread type
(Including pilot port)

Nil	Rc
F	G
N	NPT
T	NPTF

5 Port Air Operated Valve Base Mounted/Single Unit **VFA3000/5000 Series**

Specifications



VFA3000 series



VFA5000 series

Model		VFA3000	VFA5000
Fluid		Air	
Operating pressure range (MPa)	2 position single	0.15 to 1.0	
	2 position double/3 position	-101.2 kPa to 1.0	
Pilot pressure range (MPa)	2 position single	(0.4 x P + 0.1) to 1.0, P: Operating pressure	
	2 position double	0.1 to 1.0	
	3 position	0.15 to 1.0	
Ambient and fluid temperature (°C)		-10 to 50 (No freezing)	
Lubrication		Not required	
Mounting orientation		Free	
Impact/Vibration resistance (m/s ²) ^{Note 1)}		300/50	

Note 1) Impact resistance: No malfunction to axis and right angle directions of main valve, each one time when pilot signal ON and OFF. (Values at the initial period)

Vibration resistance: No malfunction from test with 45 to 2000 Hz one sweep, to axis and right angle direction of main valve, each one time when pilot signal ON and OFF. (Values at the initial period)

Pilot Pressure Range (Single pilot)

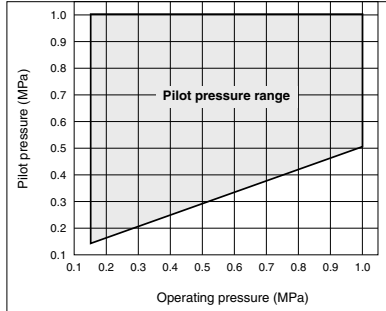

SYA

SYJA

VZA

VFA

VFRA

VPA4

SYJA

VZA

VTA

VGA

VPA

VPA3

VFA3000/5000 Series

Flow Rate Characteristics/Weights

Valve model	Type of actuation		Port size	Flow rate characteristics ^{Note 1)}						Weight (g) ^{Note 2)}
				1→4/2 (P→A/B)			4/2→5/3 (A/B→EA/EB)			
				C [dm ³ /s/bar]	b	Cv	C [dm ³ /s/bar]	b	Cv	
VFA3□40-02	2 position	Single	1/4	2.8	0.14	0.64	2.5	0.18	0.57	295 (143)
		Double		2.8	0.14	0.64	2.5	0.18	0.57	318 (166)
	3 position	Closed center		2.1	0.22	0.49	1.6	0.26	0.41	335 (183)
		Exhaust center		2.3	0.21	0.53	2.8 [2.1]	0.23 [0.26]	0.66 [0.50]	
		Pressure center		2.9 [1.1]	0.16 [0.45]	0.67 [0.32]	2.1	0.23	0.49	
VFA3□40-03	2 position	Single	3/8	3.1	0.24	0.76	2.6	0.23	0.62	278 (143)
		Double		3.1	0.24	0.76	2.6	0.23	0.62	301 (166)
	3 position	Closed center		2.2	0.33	0.57	1.6	0.34	0.40	318 (183)
		Exhaust center		2.6	0.27	0.61	2.8 [2.3]	0.30 [0.28]	0.68 [0.55]	
		Pressure center		3.4 [1.3]	0.29 [0.48]	0.80 [0.38]	2.2	0.31	0.52	
VFA5□44-02	2 position	Single	1/4	7.3	0.49	2.1	7.3	0.50	2.0	467 (278)
		Double		7.3	0.49	2.1	7.3	0.50	2.0	502 (313)
	3 position	Closed center		6.6	0.35	1.7	6.3	0.31	1.6	541 (352)
		Exhaust center		7.4	0.33	1.9	8.1 [7.4]	0.35 [0.34]	2.1 [1.9]	
		Pressure center		8.0 [2.9]	0.35 [0.48]	2.1 [0.85]	5.6	0.31	1.5	
VFA5□44-03	2 position	Single	3/8	8.4	0.34	2.2	8.9	0.29	2.3	454 (278)
		Double		8.4	0.34	2.2	8.9	0.29	2.3	489 (313)
	3 position	Closed center		7.3	0.34	2.0	7.1	0.28	1.8	528 (352)
		Exhaust center		8.1	0.27	2.0	14.0 [8.3]	0.26 [0.31]	3.4 [2.2]	
		Pressure center		8.1 [2.5]	0.33 [0.48]	2.0 [0.74]	5.7	0.31	1.4	
VFA5□44-04	2 position	Single	1/2	9.4	0.43	2.7	12.0	0.32	3.0	526 (278)
		Double		9.4	0.43	2.7	12.0	0.32	3.0	561 (313)
	3 position	Closed center		7.1	0.41	2.1	7.4	0.32	2.0	600 (352)
		Exhaust center		8.6	0.39	2.4	13.0 [8.9]	0.21 [0.40]	3.1 [2.5]	
		Pressure center		11.0 [2.6]	0.18 [0.47]	2.6 [0.78]	6.1	0.35	1.6	

Note 1) [] : Normal position

Note 2) () : Values without sub-plate

Construction: Base Mounted

VFA3000, 5000

Symbol
2 position single



2 position single

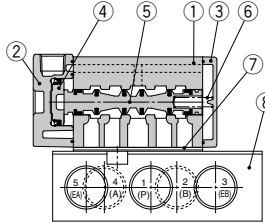

Symbol
2 position double



2 position double

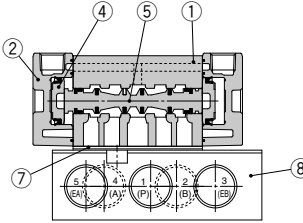

Symbol
3 position closed center

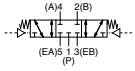

3 position closed center/exhaust center/pressure center

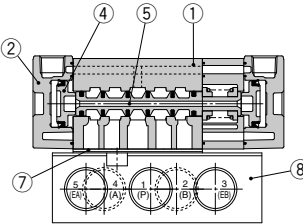

3 position exhaust center

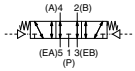

3 position pressure center

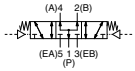

(Drawing shows a closed center type.)

Sub-plate part no.

VF 3 000-71-1

Series

3	VFA3000
5	VFA5000

Thread type

N	Rc
F	G
N	NPT
T	NPTF

Port size

Symbol	Port size	VFA3000	VFA5000
1	1/4	○	○
2	3/8	○	○
3	1/2	—	○

Component Parts

No.	Description	Material	Note
1	Body	Aluminum die-casted	White
2	Pilot plate	Aluminum die-casted	Gray
3	End plate	Resin	White
4	Piston	Resin	
5	Spool valve	Aluminum, HNBR	
6	Spring	Stainless steel	

Replacement Parts

No.	Description	Part no.		Note
		VFA3000	VFA5000	
7	Gasket	DXT031-30-11	DXT156-9-8	HNBR
8	Sub-plate	1/4: VF3000-71-1□ 3/8: VF3000-71-2□	1/4: VF5000-71-1□ 3/8: VF5000-71-2□ 1/2: VF5000-71-3□	Aluminum die-casted
—	Round head combination screw (1 pc.)	DXT031-44-1 (M4 x 39.5, With spring washer)	—	For mounting valve
—	Hexagon socket head cap screw (1 pc.)	—	AXT620-32-1 (M4 x 48, With spring washer)	For mounting valve

Caution

Tightening Torque
for Mounting Valve

M4: 1.4 N·m

Dimensions: VFA5000 Series/Base Mounted

2 position single

VFA5144-03⁰²₀₄□(-P)

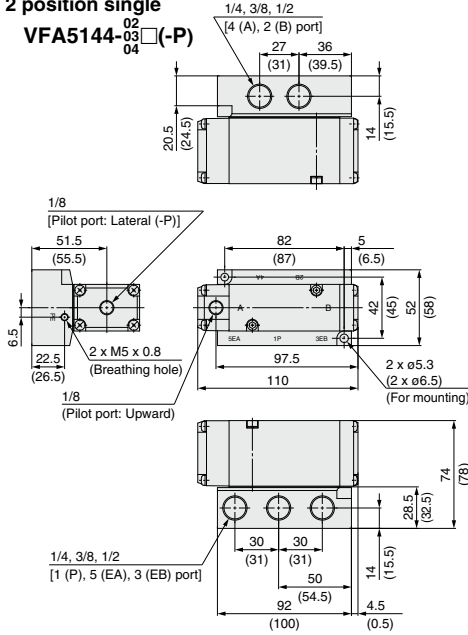

2 position double

VFA5244-03⁰²₀₄□(-P)

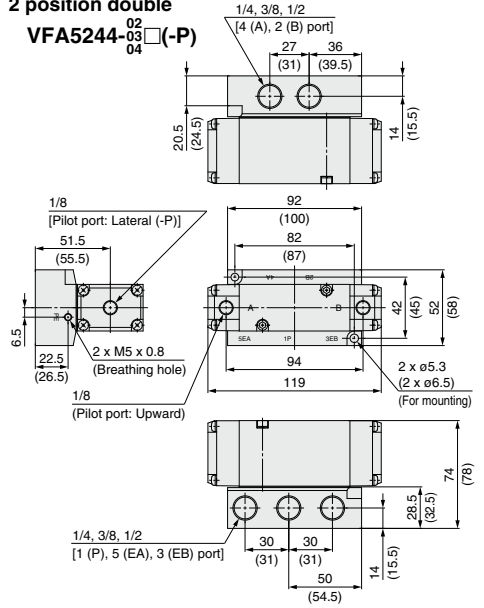

3 position closed center/exhaust center/pressure center

VFA5444-03⁰²₀₄□(-P)

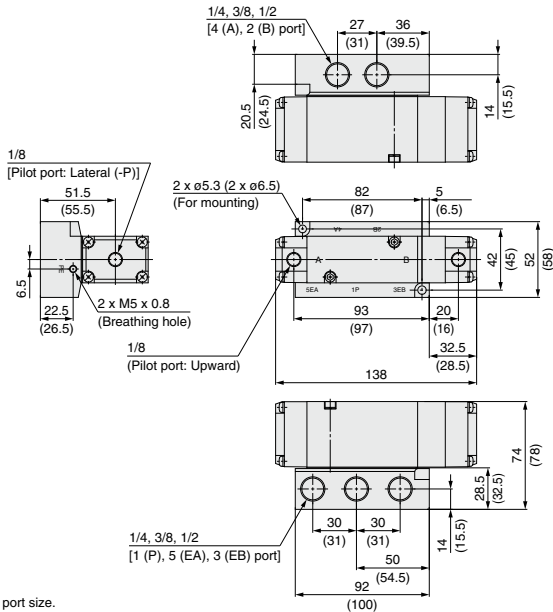

The dimensions in () are for 1/2 piping port size.

SYA
SYJA
VZA
VFA
VFRA
VPA4
SYJA
VZA
VTA
VGA
VPA
VPA3

5 Port Air Operated Valve

VFA 1000/3000/5000 Series

Manifold

Body Ported

How to Order Manifold

Common exhaust

VV5FA 1 - 30 - 04 1 - □

Series

1	VFA1000
3	VFA3000
5	VFA5000

Manifold model

Symbol	P, R Port size	VFA1000	VFA3000	VFA5000
30	1/8	○	—	—
	1/4	—	○	—
20	3/8	—	—	○
21	1/2	—	—	○

* The A and B ports are made on the top.

Thread type

Nil	Rc
00F	G
00N	NPT
00T	NPTF

Stations

02	2 stations
⋮	⋮
20	20 stations

* Up to 10 stations for VV5FA5-20, and up to 15 stations for VV5FA5-21.

Individual exhaust
(VFA1000 only)

VV5FA1 - 31 - 04 3 - □

Manifold model

Symbol	P, R Port size	EA, EB Port size
31	1/8	M5

Stations

02	2 stations
⋮	⋮
20	20 stations

Thread type

Nil	Rc
00F	G
00N	NPT
00T	NPTF

Note) When placing an order for body ported valve as a single unit, mounting screws for manifold and gasket are not attached. Order them separately, if necessary. (Refer to page 1514 for details.)

How to Order Valve

VFA 3 1 3 0 - 01 □ - □

Series

1	VFA1000
3	VFA3000
5	VFA5000

Type of actuation

1	2 position single
2	2 position double
3	3 position closed center
4	3 position exhaust center
5	3 position pressure center

* Only 1 and 2 are available with the VFA1000.

Body model

Symbol	VFA1000	VFA3000	VFA5000
2	—	—	○
3	○ Note)	○	—

Note) Manifold only

A, B port size

Symbol	Port size	VFA1000	VFA3000	VFA5000
M5	M5 x 0.8	○	—	—
01	1/8	○	○	—
02	1/4	—	○	○
03	3/8	—	—	○

Pilot port direction

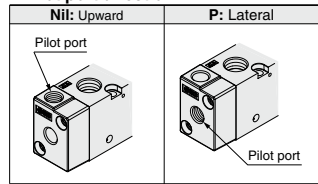

Thread type
(Including pilot port)

Nil	Rc
F	G
N	NPT
T	NPTF

* M5 is available with Nil only.

Manifold Specifications

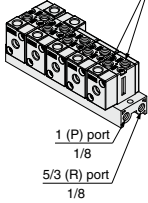
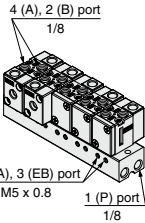
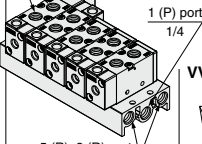
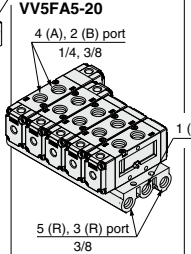
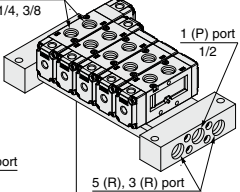
Series	VFA1000		VFA3000	VFA5000	
Manifold base model	VV5FA1-30 	VV5FA1-31 	VV5FA3-30 	VV5FA5-20 	VV5FA5-21 
	EXH port type	Common EXH	Individual EXH	Common EXH	Common EXH
Applicable valve model	VFA1□30		VFA3□30	VFA5□20	
Applicable stations	2 to 20 stations		2 to 20 stations	2 to 10 stations	2 to 15 stations
Manifold base Weight: W[g] Stations: n	W = 29n + 21	W = 51n + 35	W = 63n + 64	W = 97n + 80	W = 139n + 550

Note) Supply pressure to 1(P) ports and exhaust pressure from R ports on both sides for 10 stations or more (5 stations or more for the VFA5000).

SYA
SYJA
VZA
VFA
VFRA
VPA4
SYJA
VZA
VTA
VGA
VPA
VPA3

How to Order Manifold Assembly

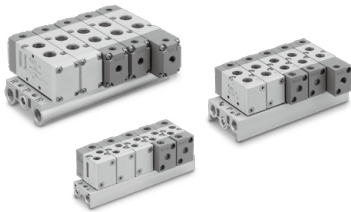

Example (VV5FA3-30)

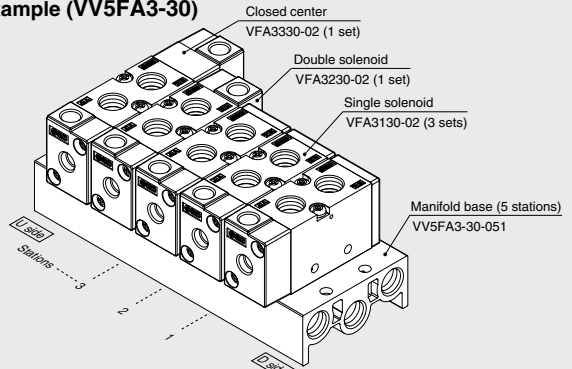

VV5FA3-30-051...1 set (Type 30, 5-station manifold base part no.)

* VFA3130-02.....3 sets (Single part no.)

* VFA3230-02.....1 set (Double part no.)

* VFA3330-02.....1 set (Closed center part no.)

↳ * The asterisk denotes the symbol for assembly. Prefix it to the part no. of the valve etc.

• The valve arrangement is numbered as the 1st station from D side.

• Under the manifold base part number, state the valves to be mounted in order from the 1st station as shown in the figure above.

VFA1000/3000/5000 Series

Manifold Options

■ For body ported Blanking plate assembly

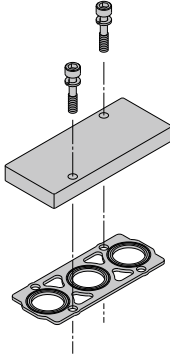

Series	Blanking plate assembly part no.
VFA1000	DXT144-13-3A
VFA3000	DXT031-38-5A
VFA5000	VF5000-70-1A

■ Mounting screw, gasket part no.

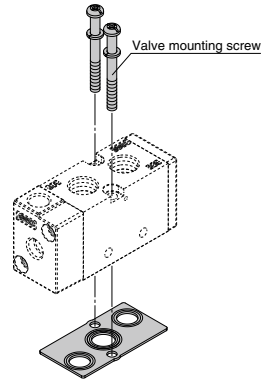

Series	Valve mounting screw (1 pc.)	Gasket
VFA1000	Round head combination screw DXT031-44-1	DXT144-12-2
VFA3000	(M4 x 39.5, With spring washer)	DXT155-25-7
VFA5000	Hexagon socket head cap screw AXT620-32-1 (M4 x 48, With spring washer)	DXT156-9-6

■ Individual EXH spacer assembly

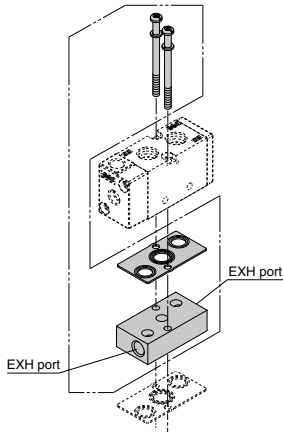

⚠ Caution

Tightening Torque for Mounting Screw

M4: 1.4N·m

⚠ Warning

When mounting a valve or spacer on the manifold base or sub-plate, etc., the mounting orientation is already decided. If mounted in a wrong direction, the equipment to be connected may result in a malfunction. Refer to the dimensions for mounting.

VF **3** 000-75-1 **A**

Series

Symbol	Series	Port size
3	VFA3000	1/8
5	VFA5000	1/4

Thread type

Nil	Rc
F	G
N	NPT
T	NPTF

Dimensions: VFA1000 Series

Type 30: VV5FA1-30-□□1-□: Common exhaust

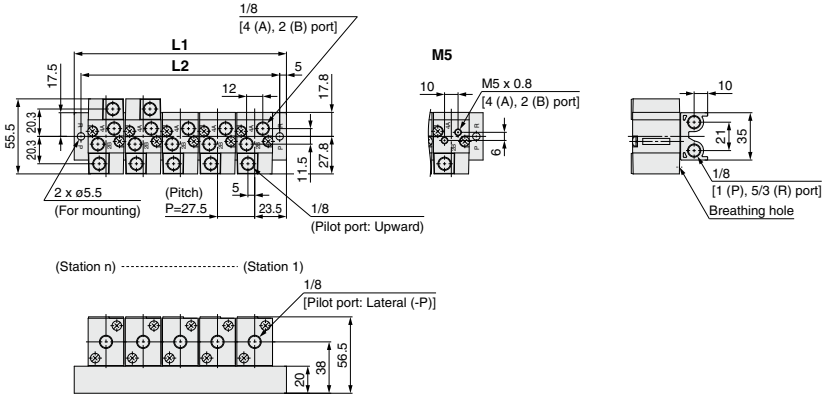

Type 31: VV5FA1-31-□□3-□: Individual exhaust

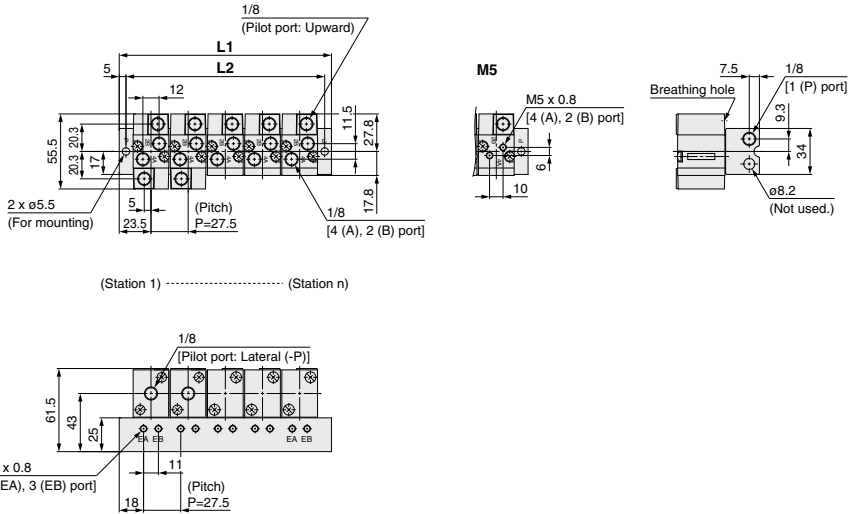

Dimensions (Common to Type 30 and Type 31)

L	n	2	3	4	5	6	7	8	9	10	11	12	13	14	15	16	17	18	19	20
L1		74.5	102	129.5	157	184.5	212	239.5	267	294.5	322	349.5	377	404.5	432	459.5	487	514.5	542	569.5
L2		64.5	92	119.5	147	174.5	202	229.5	257	284.5	312	339.5	367	394.5	422	449.5	477	504.5	532	559.5

n: Stations

- SYA
- SYJA
- VZA
- VFA
- VFRA
- VPA4
- SYJA
- VZA
- VTA
- VGA
- VPA
- VPA3

VFA1000/3000/5000 Series

Dimensions: VFA3000 Series

Type 30: VV5FA3-30-□□1-□: Common exhaust

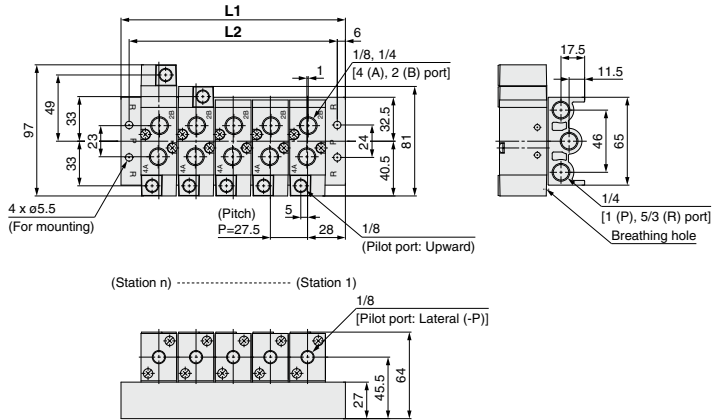

Dimensions

n: Stations

L \ n	2	3	4	5	6	7	8	9	10	11	12	13	14	15	16	17	18	19	20
L1	83.5	111	138.5	166	193.5	221	248.5	276	303.5	331	358.5	386	413.5	441	468.5	496	523.5	551	578.5
L2	71.5	99	126.5	154	181.5	209	236.5	264	291.5	319	346.5	374	401.5	429	456.5	484	511.5	539	566.5

Dimensions: VFA5000 Series

Type 20: VV5FA5-20-□□1-□: Common exhaust

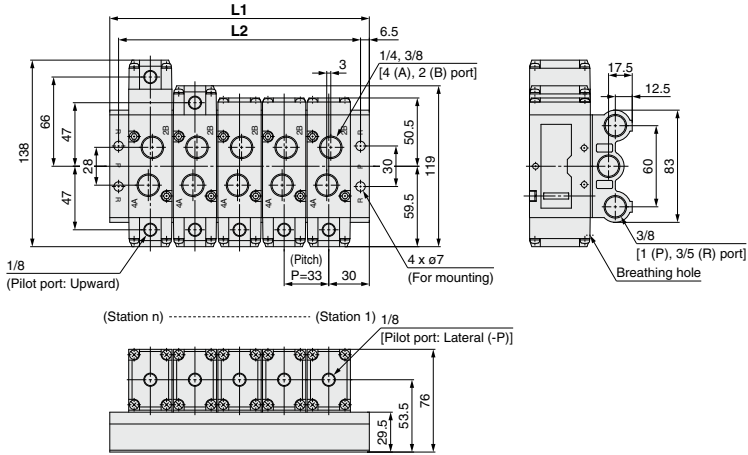

Dimensions

n	2	3	4	5	6	7	8	9	10
L1	93	126	159	192	225	258	291	324	357
L2	80	113	146	179	212	245	278	311	344

n: Stations

Type 21: VV5FA5-21-□□1-□: Common exhaust

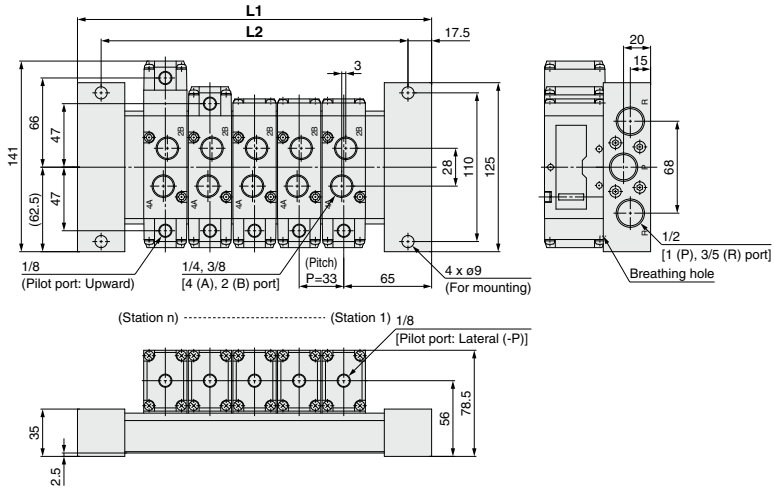

Dimensions

n	2	3	4	5	6	7	8	9	10	11	12	13	14	15
L1	163	196	229	262	295	328	361	394	427	460	493	526	559	592
L2	128	161	194	227	260	293	326	359	392	425	458	491	524	557

n: Stations

- SYA
- SYJA
- VZA
- VFA**
- VFRA
- VPA4
- SYJA
- VZA
- VTA
- VGA
- VPA
- VPA3

5 Port Air Operated Valve VFA3000/5000 Series Manifold

Base Mounted

How to Order Manifold

Common exhaust VV5FA **3** -40- **05** 2-02 **F**

Series

Symbol	Series	P, R Port size	A, B Port size
3	VFA3000	1/4	1/4
5	VFA5000	3/8	1/4

* The A and B ports are made on the bottom.

Stations

02	2 stations
⋮	⋮
20	20 stations

* Up to 10 stations for VV5FA5

Thread type

Nil	Rc
F	G
N	NPT
T	NPTF

How to Order Valve (With a gasket and two mounting screws)

VFA **3** **1** **4** **0** - □ - □

Series

3	VFA3000
5	VFA5000

* Not available with the VFA1000.

Type of actuation

1	2 position single
2	2 position double
3	3 position closed center
4	3 position exhaust center
5	3 position pressure center

Body model

Body option

Symbol	VFA3000	VFA5000
0	○	—
4	—	○

Pilot port direction

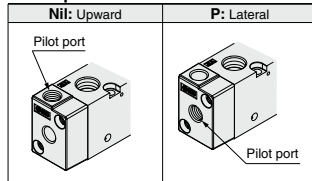

Pilot port thread type

Nil	Rc
00F	G
00N	NPT
00T	NPTF

Manifold Specifications

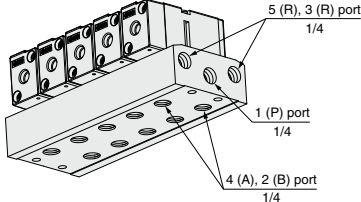
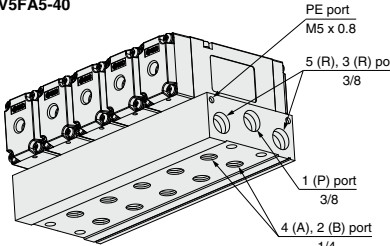
Series	Manifold base model	EXH port type	Applicable valve model	Applicable stations	Manifold base Weight: W[g] Stations: n
VFA3000	VV5FA3-40	Common EXH	VFA3□40	2 to 20 stations	W = 110n + 116
					
VFA5000	VV5FA5-40	Common EXH	VFA5□44	2 to 10 stations	W = 161n + 128
					

Note) Supply pressure to 1(P) ports and exhaust pressure from R ports on both sides for 10 stations or more (5 stations or more for the VFA5000).

- SYA
- SYJA
- VZA
- VFA
- VFRA
- VPA4
- SYJA
- VZA
- VTA
- VGA
- VPA
- VPA3

How to Order Manifold Assembly

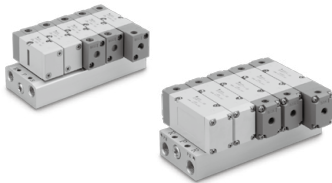

Example (VV5FA3-40)

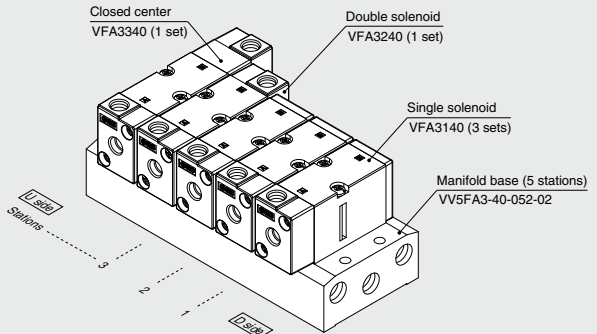

- VV5FA3-40-052-02...1 set (Type 40, 5-station manifold base part no.)
- * VFA3140.....3 sets (Single part no.)
 - * VFA3240.....1 set (Double part no.)
 - * VFA3340.....1 set (Closed center part no.)
- ↳ The asterisk denotes the symbol for assembly. Prefix it to the part no. of the valve etc.

- The valve arrangement is numbered as the 1st station from D side.
- Under the manifold base part number, state the valves to be mounted in order from the 1st station as shown in the figure above.

Refer to page 1520 for manifold options.

VFA3000/5000 Series

Manifold Options

■ For base mounted Blanking plate assembly

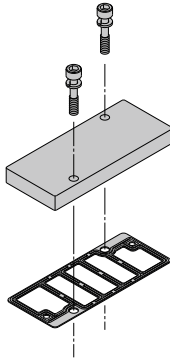

Series	Blanking plate assembly part no.
VFA3000	DXT031-38-5A
VFA5000	VF5000-70-2A

■ Mounting screw, gasket part no.

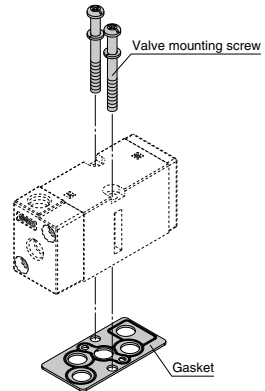

Series	Valve mounting screw (1 pc.)	Gasket
VFA3000	Round head combination screw DXT031-44-1 (M4 x 39.5, With spring washer)	DXT031-30-11
VFA5000	Hexagon socket head cap screw AXT620-32-1 (M4 x 48, With spring washer)	DXT156-9-8

■ Individual EXH spacer assembly

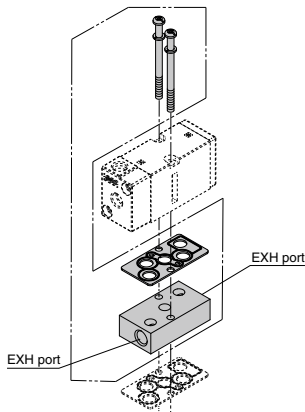

⚠ Caution

Tightening Torque for Mounting Screw

M4: 1.4N·m

⚠ Warning

When mounting a valve or spacer on the manifold base or sub-plate, etc., the mounting orientation is already decided. If mounted in a wrong direction, the equipment to be connected may result in a malfunction. Refer to the dimensions for mounting.

VF **3** 000-75-2 **A**

Series

Symbol	Series	Port size
3	VFA3000	1/8
5	VFA5000	1/4

Thread type

Nll	Rc
F	G
N	NPT
T	NPTF

Dimensions: VFA3000 Series

Type 40: VV5FA3-40-□□2-02□: Common exhaust

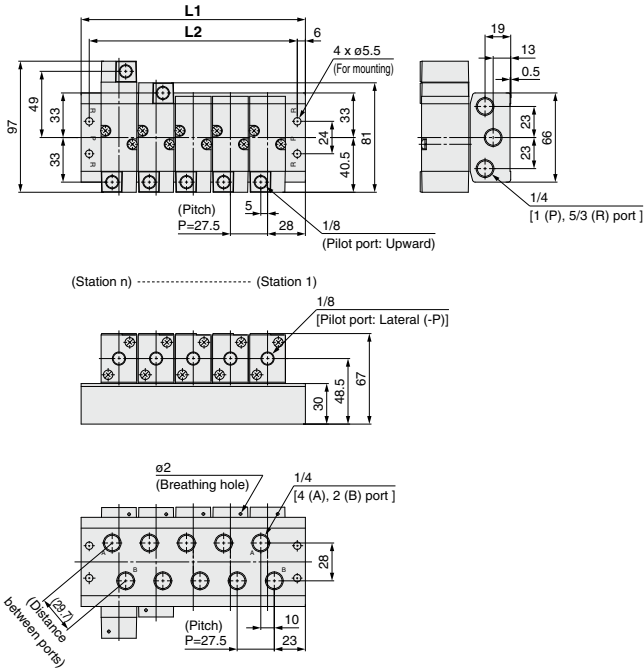

- SYA
- SYJA
- VZA
- VFA**
- VFRA
- VPA4
- SYJA
- VZA
- VTA
- VGA
- VPA
- VPA3

Dimensions

n: Stations

L \ n	2	3	4	5	6	7	8	9	10	11	12	13	14	15	16	17	18	19	20
L1	83.5	111	138.5	166	193.5	221	248.5	276	303.5	331	358.5	386	413.5	441	468.5	496	523.5	551	578.5
L2	71.5	99	126.5	154	181.5	209	236.5	264	291.5	319	346.5	374	401.5	429	456.5	484	511.5	539	566.5

