

Booster Regulator/Air Tank

VBA/VBAT Series

Increase factory air pressure by up to 4 times!
 Air-only operation requires no power supply,
 reduces heat generation,
 and allows easy installation.

RoHS

* Except the Chinese pressure vessel regulations compliant product (-X104)

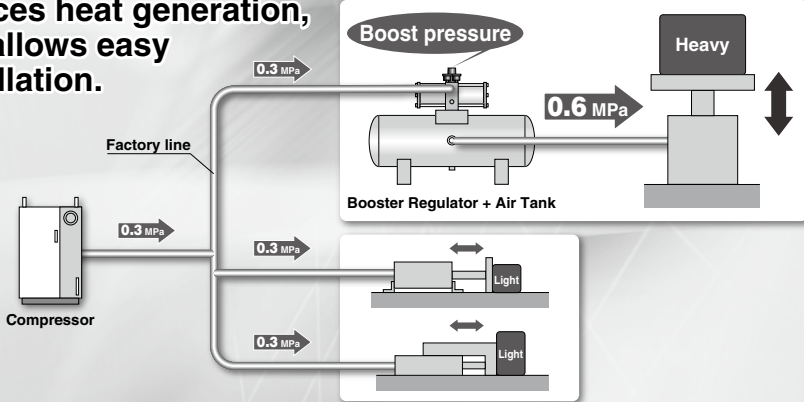

ARJ
AR425 to 935
ARX
AMR
ARM
ARP
IR□-A
IR
IRV
VEV
SRH
SRP
SRF
ITV
IC
ITVH
ITVX
PVQ
VY1
VBA VBAT
AP100

No power supply or wiring needed

There is no need to install dedicated electrical wiring.



Easy installation

Simply install the unit in the air line.
 Requires far less space than installing the compressor.



Low heat generation

Very little heat is generated because no electricity is used, and there is no impact on cylinders, solenoid valves, etc.

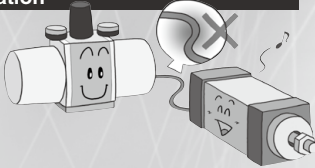

Air-only operation

Operation is safe because no electricity is used.

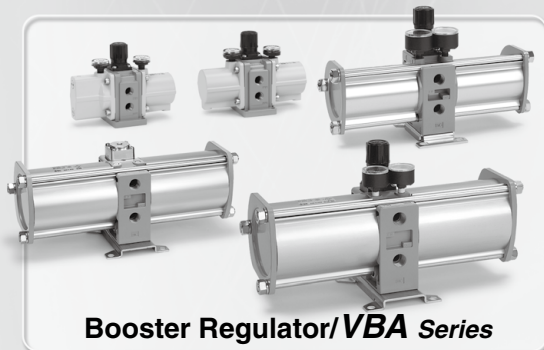
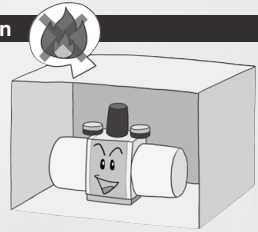

Booster Regulator/VBA Series



Air Tank/VBAT Series

Booster Regulator *VBA Series*

Improved service life

- Floating piston structure
 - Grease retaining groove*
- * Except VBA10A, 11A

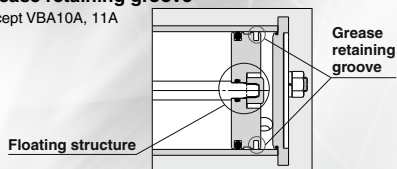

Doubled
that of the current model

Reduced noise

Reduced by **13 dB (A)**
compared with the current model

- Metal noise reduced by a bumper on the impact part of the switch valve
- Exhaust noise reduced by a high-noise reduction silencer

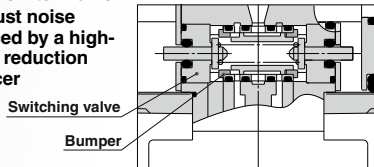

Improved reliability

Built-in mesh filter at IN port

- Prevents operation failure due to foreign matter.

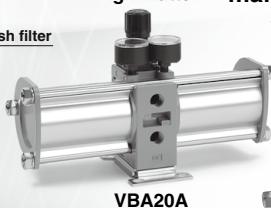
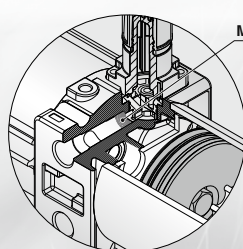

Anti-condensation

Integrated air-feeding tube with the main tube

- Mitigates condensation caused by cooling during exhaust expansion.

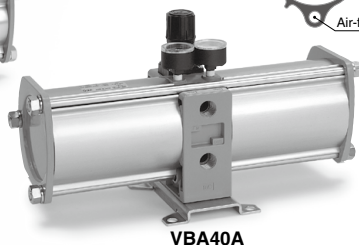
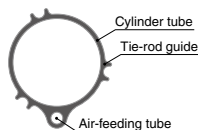

Elbow silencer added* (Option)

Space saving when installed has been realized.

- * Except VBA2□A, 4□A

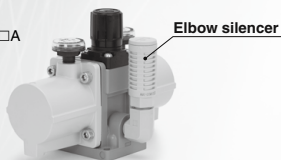

1/8" gauge ports

- Allows use of standard fittings for remote pressure monitoring, etc.
- * Gauge ports changed from 1/16" to 1/8" (VBA1□A, 2□A)

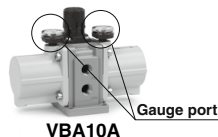

Air-operated type

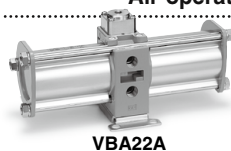







Max. operating pressure 1.6 MPa

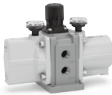

Fourfold pressure increase type



Pressure increase ratio Operation Set pressure range Body size	Twice			2 to 4 times
	Knob-operated type (Direct operation)		Air-operated type (Remote operation)	Knob-operated type (Direct operation)
	0.2 to 1.0 MPa	0.2 to 1.6 MPa (2.0 MPa)	0.2 to 1.0 MPa	0.4 to 2.0 MPa
1/4"	—	VBA10A-02 (0.2 to 2.0 MPa) 	—	VBA11A-02 
3/8"	VBA20A-03 	—	VBA22A-03 	—
1/2"	VBA40A-04 	VBA43A-04 (0.2 to 1.6 MPa) 	VBA42A-04 	—

- ARJ
- AR425 to 935
- ARX
- AMR
- ARM
- ARP
- IR□-A
- IR
- IRV
- VEX
- SRH
- SRP
- SRF
- ITV
- IC
- ITVH
- ITVX
- PVQ
- VY1
- VBA
- VBAT
- AP100

Air Tank *VBAT Series*

Perfect fit with a booster regulator

This is an air tank to which a booster regulator can be connected compactly. It can be used alone as a tank. The pressure vessel law is different from country to country, so as an air tank suitable to a country needs to be confirmed.

Extensive product lineup

To meet a variety of usage environment and pressure specifications, models are available in two materials, stainless steel 304 and carbon steel (SS400), and in four sizes ranging from 5 liters to 38 liters.

Model	VBAT05A	VBAT10A	VBAT20A	VBAT38A
Tank capacity (L)	5	10	20	38
Max. operating pressure (MPa)	2.0		1.0	
Material	Carbon steel			

Model	VBAT05S	VBAT10S	VBAT20S	VBAT38S
Tank capacity (L)	5	10	20	38
Max. operating pressure (MPa)	2.0			
Material	Stainless steel			



⚠ Caution

When used as a single unit (not connected with a booster regulator) and pressurized at over 1 MPa at normal temperatures, the air tank falls under the scope of the "High Pressure Gas Safety Act" in Japan.

Booster Regulator VBA Series



How to Order



Made to Order
(For details, refer to page 1020.)

VBA **40A** - **04** - **04**

Body size

10A	1/4", Knob-operated type	Pressure increase ratio: Twice
20A	3/8", Knob-operated type	
40A	1/2", Knob-operated type	
22A	3/8", Air-operated type	
42A	1/2", Air-operated type	
43A	1/2", Max. operating pressure 1.6 MPa	Pressure increase ratio: 2 to 4 times
11A <small>Note</small>	1/4", Knob-operated type	

Note) Set the pressure increase ratio to 2 or more.

Thread type Note

Symbol	Thread type
Nil	Rc
F	G
N	NPT
T	NPTF

Note) Thread types apply to the IN, OUT, and EXH ports of the VBA1□A and to the IN, OUT, EXH, and gauge ports of the VBA2□A and VBA4□A. The gauge ports of the VBA1□A are Rc thread type regardless of the thread type indication.

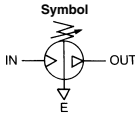

VBA10A-02



VBA11A-02



VBA20A-03



VBA22A-03



VBA40A-04



VBA42A-04



VBA43A-04

Semi-standard

Symbol	Semi-standard
Nil	Standard product
Z <small>Note</small>	<ul style="list-style-type: none"> ● Pressure unit on the product name label: psi ● Pressure unit on the pressure gauge: MPa and psi

Note) Thread type: NPT, NPTF
Under the new measurement law, the pressure unit of "psi" on the pressure gauges cannot be used in Japan.

Option

Symbol	Option
Nil	None
G	Pressure gauge
N	Silencer
S	High-noise reduction silencer <small>Note</small>
GN	Pressure gauge, Silencer
GS	Pressure gauge, High-noise reduction silencer <small>Note</small>
LN	Elbow silencer <small>Note</small>
LS	Elbow high-noise reduction silencer <small>Note</small>
GLN	Pressure gauge, Elbow silencer <small>Note</small>
GLS	Pressure gauge, Elbow high-noise reduction silencer <small>Note</small>

Note) Refer to "Combination of Thread Type and Options."

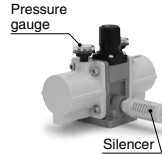

Silencer

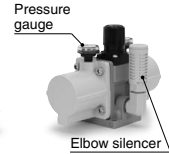

Elbow silencer

Port size

Symbol	Port size	Applicable series
02	1/4	VBA1□A
03	3/8	VBA2□A
04	1/2	VBA4□A

Combination of Thread Type and Options

Body size	Thread type	Option										Semi-standard		
		Nil	G	N	S	GN	GS	LN	LS	GLN	GLS	Nil	-Z	
10A 11A	Nil	●	●	●	●	●	●	●	●	●	●	●	●	—
	F	●	●	●	●	●	●	●	●	●	●	●	●	—
	N	●	●	●	—	—	—	—	—	—	—	—	—	●
	T	●	●	●	—	—	—	●	—	—	—	—	—	●
20A 22A	Nil	●	●	●	●	●	●	—	—	—	—	—	—	—
	F	●	●	●	●	●	●	—	—	—	—	—	—	—
	N	●	●	●	—	—	—	—	—	—	—	—	—	●
	T	●	●	●	—	—	—	—	—	—	—	—	—	●
40A 42A 43A	Nil	●	●	●	●	●	●	—	—	—	—	—	—	—
	F	●	●	●	●	●	●	—	—	—	—	—	—	—
	N	●	●	●	—	—	—	—	—	—	—	—	—	●
	T	●	●	●	—	—	—	—	—	—	—	—	—	●

Air Tank Compatibility Chart

Air tank \ Booster regulator	VBA10A/11A	VBA20A/22A	VBA40A/42A	VBA43A
VBAT05A(1)	●	—	—	—
VBAT05S(1)	—	—	—	—
VBAT10A(1)	●	●	—	—
VBAT10S(1)	—	—	—	—
VBAT20A(1)	—	●	●	—
VBAT20S(1)	—	—	—	●
VBAT38A(1)	—	●	●	—
VBAT38S(1)	—	—	—	●

Standard Specifications

Model	VBA10A-02	VBA20A-03	VBA40A-04	VBA22A-03	VBA42A-04	VBA43A-04	VBA11A-02
Fluid	Compressed air						
Pressure increase ratio	Twice						2 to 4 times ^{Note 4)}
Pressure adjustment mechanism	Knob-operated with relief mechanism ^{Note 2)}			Air-operated		Knob-operated with relief mechanism ^{Note 2)}	
Max. flow rate ^{Note 3)} (L/min (ANR))	230	1000	1900	1000	1900	1600	70
Set pressure range (MPa)	0.2 to 2.0	0.2 to 1.0		0.2 to 1.0		0.2 to 1.6	0.4 to 2.0
Supply pressure range (MPa)	0.1 to 1.0						
Proof pressure (MPa)	3	1.5			2.4		3
Port size (Rc) (IN/OUT/EXH: 3 locations)	1/4	3/8	1/2	3/8	1/2		1/4
Pressure gauge port size (Rc) (IN/OUT: 2 locations)	1/8						
Tank connection port (with plug) ^{Note 5)}	1/4	3/8	1/2	3/8	1/2		1/4
Ambient and fluid temperature (°C)	2 to 50 (No freezing)						
Installation	Horizontal						
Lubrication	Grease (Non-lube)						
Weight (kg)	0.84	3.9	8.6	3.9	8.6	8.6	0.89

Note 1) Be sure to secure an air supply capacity of the minimum operating pressure (0.1 MPa) or more.

Note 2) If the OUT pressure is higher than the set pressure by the knob, excess pressure is exhausted from the back of the knob.

Note 3) Flow rate at IN= OUT= 0.5 MPa. The pressure varies depending on the operating conditions. Refer to "Flow Rate Characteristics" on pages 1012 and 1013.

Note 4) Set the pressure increase ratio to 2 or more.

Note 5) The tank connection port cannot be used for applications other than the connection with VBAT.

Options/Part No.

Pressure Gauge, Silencer (When thread type is Rc or G.)

Model		VBA10A-02	VBA20A-03	VBA40A-04	VBA22A-03	VBA42A-04	VBA43A-04	VBA11A-02
Description		VBA10A-F02	VBA20A-F03	VBA40A-F04	VBA22A-F03	VBA42A-F04	VBA43A-F04	VBA11A-F02
Pressure gauge	G	G27-20-01	G36-10-01		KT-VBA22A-7	G36-10-01	G27-20-01	G27-20-01
Silencer	N	AN20-02	AN30-03	AN40-04	AN30-03	AN40-04	AN40-04	AN20-02
High-noise reduction silencer	S	ANA1-02	ANA1-03	ANA1-04	ANA1-03	ANA1-04	ANA1-04	ANA1-02
Elbow for silencer	L	KT-VBA10A-18	—	—	—	—	—	KT-VBA10A-18

Note 1) In the case of options GN, two pressure gauges and one silencer are included in the same container as accessories.

Note 2) KT-VBA22A-7 is a pressure gauge with fitting. (Please order two units when using with IN and OUT.)

Pressure Gauge, Silencer (When thread type is NPT or NPTF.)

Model		VBA10A-N02*	VBA20A-N03*	VBA40A-N04*	VBA22A-N03*	VBA42A-N04*	VBA43A-N04*	VBA11A-N02*
Description		VBA10A-T02*	VBA20A-T03*	VBA40A-T04*	VBA22A-T03*	VBA42A-T04*	VBA43A-T04*	VBA11A-T02*
Pressure gauge *: when Nil	G	G27-20-01	G36-10-N01		KT-VBA22A-7N	G36-10-N01	G27-20-N01	G27-20-01
Pressure gauge *: when "-Z" ^{Note 4)}		G27-P20-01-X30	G36-P10-N01-X30		KT-VBA22A-8N	G36-P10-N01-X30	G27-P20-N01-X30	G27-P20-01-X30
Silencer	N	AN20-N02	AN30-N03	AN40-N04	AN30-N03	AN40-N04	AN40-N04	AN20-N02
High-noise reduction silencer	S	—	ANA1-N03	ANA1-N04	ANA1-N03	ANA1-N04	ANA1-N04	—
Elbow for silencer	L	KT-VBA10A-18N	—	—	—	—	—	KT-VBA10A-18N

Note 1) In the case of options GN, two pressure gauges and one silencer are included in the same container as accessories.

Note 2) KT-VBA22A-7N, KT-VBA22A-8N are pressure gauges with fittings. (Please order two units when using with IN and OUT.)

Note 3) Under the new measurement law, the pressure unit of "psi" on the pressure gauges cannot be used in Japan.

Note 4) Pressure unit on the pressure gauge: MPa and psi

Related Products/Part No.

Mist Separator, Exhaust Cleaner

Model	For VBA10A-02 For VBA11A-02	For VBA20A-03 For VBA22A-03	For VBA40A-04 For VBA42A-04 For VBA43A-04
Mist separator	AM250C-02	AM450C-04, 06	AM550C-06, 10
Exhaust cleaner	AMC310-03	AMC510-06	AMC610-10

Note) Refer to page 1022 for air tanks, page 223 for mist separators and Best Pneumatics No.7 for exhaust cleaners.

Refer to the separate operation manual for the connection method.

ARJ
AR425 to 935
ARX
AMR
ARM
ARP
IR□-A
IR
IRV
VEX
SRH
SRP
SRF
ITV
IC
ITVH
ITVX
PVQ
VY1
VBA VBAT
AP100

VBA Series

Solid line: Operating range

Operate so that the flow rate follows the solid line even when the outlet side air has been consumed.

Ex.) For the VBA10A: When the inlet pressure is 0.5 MPa and the set pressure is 1.0 MPa, operate at an outlet air flow rate of 180 L/min (ANR) or less.

Dotted line: Outside of the set pressure range

P₁: Inlet pressure P₂: Outlet pressure

VBA10A

Flow Rate Characteristics

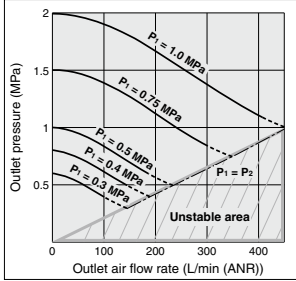

VBA20A, 22A

Flow Rate Characteristics

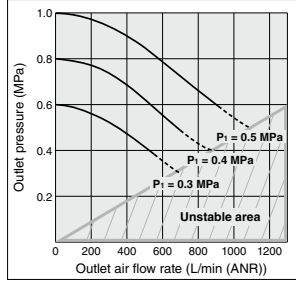

VBA40A, 42A

Flow Rate Characteristics

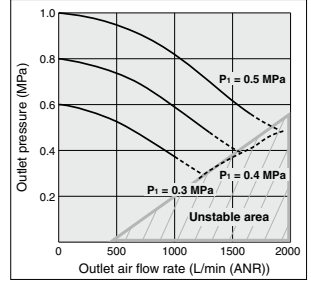

When operated at a flow rate that falls within the unstable area (P₂ < P₁ conditions) as shown in the graphs above, the booster regulator may not operate normally and may therefore fail to increase the pressure.

Pressure Characteristics

Inlet pressure: 0.7 MPa
Outlet pressure: 1.0 MPa (Representative value)
Flow rate: 20 L/min (ANR)

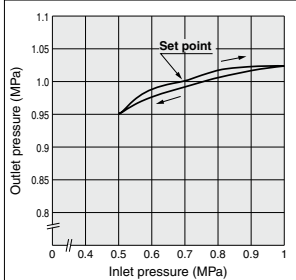

Pressure Characteristics

Inlet pressure: 0.7 MPa
Outlet pressure: 1.0 MPa (Representative value)
Flow rate: 20 L/min (ANR)

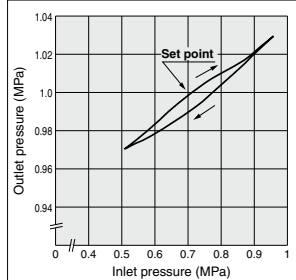

Pressure Characteristics

Inlet pressure: 0.7 MPa
Outlet pressure: 1.0 MPa (Representative value)
Flow rate: 20 L/min (ANR)

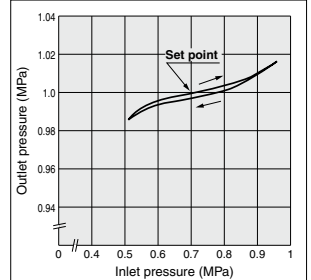

Charge Characteristics

(Pressure increase ratio: Twice)

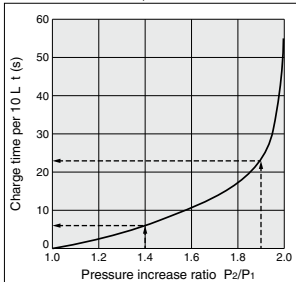

Charge Characteristics

(Pressure increase ratio: Twice)

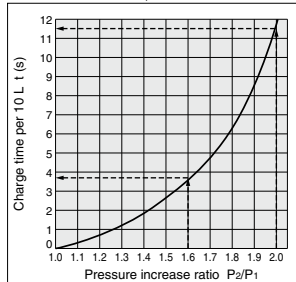

Charge Characteristics

(Pressure increase ratio: Twice)

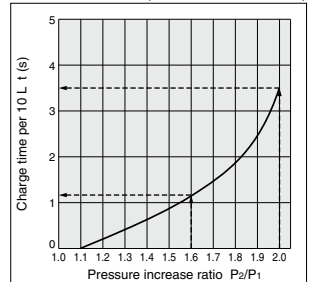

VBA10A

● The time required to charge pressure in the tank from 0.7 MPa to 0.95 MPa at 0.5 MPa supply pressure:

$$\frac{P_2}{P_1} = \frac{0.7}{0.5} = 1.4 \quad \frac{P_2}{P_1} = \frac{0.95}{0.5} = 1.9$$

With the pressure increase ratio from 1.4 to 1.9, the charge time of 23 – 6 = 17 sec. (t) is given by the graph. Then, the charge time (T) for a 10 L tank:

$$T = t \times \frac{V}{10} = 17 \times \frac{10}{10} = 17 \text{ (s)}.$$

VBA20A, 22A

● The time required to charge pressure in the tank from 0.8 MPa to 1.0 MPa at 0.5 MPa supply pressure:

$$\frac{P_2}{P_1} = \frac{0.8}{0.5} = 1.6 \quad \frac{P_2}{P_1} = \frac{1.0}{0.5} = 2.0$$

With the pressure increase ratio from 1.6 to 2.0, the charge time of 11.5 – 3.8 = 7.7 sec. (t) is given by the graph. Then, the charge time (T) for a 100 L tank:

$$T = t \times \frac{V}{10} = 7.7 \times \frac{100}{10} = 77 \text{ (s)}.$$

VBA40A, 42A

● The time required to charge pressure in the tank from 0.8 MPa to 1.0 MPa at 0.5 MPa supply pressure:

$$\frac{P_2}{P_1} = \frac{0.8}{0.5} = 1.6 \quad \frac{P_2}{P_1} = \frac{1.0}{0.5} = 2.0$$

With the pressure increase ratio from 1.6 to 2.0, the charge time of 3.5 – 1.1 = 2.4 sec. (t) is given by the graph. Then, the charge time (T) for a 100 L tank:

$$T = t \times \frac{V}{10} = 2.4 \times \frac{100}{10} = 24 \text{ (s)}.$$

Solid line: Operating range

Operate so that the flow rate follows the solid line even when the outlet side air has been consumed.

Ex.) For the VBA10A: When the inlet pressure is 0.5 MPa and the set pressure is 1.0 MPa, operate at an outlet air flow rate of 180 L/min (ANR) or less.

Dotted line: Outside of the set pressure range

P₁: Inlet pressure P₂: Outlet pressure

VBA43A

Flow Rate Characteristics

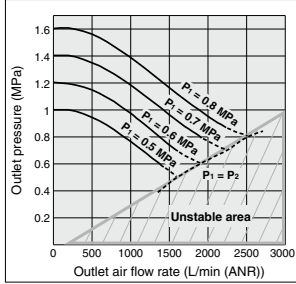

When operated at a flow rate that falls within the unstable area (P₂ < P₁ conditions) as shown in the graphs above, the booster regulator may not operate normally and may therefore fail to increase the pressure.

Pressure Characteristics

Inlet pressure: 0.7 MPa
Outlet pressure: 1.0 MPa (Representative value)
Flow rate: 20 L/min (ANR)

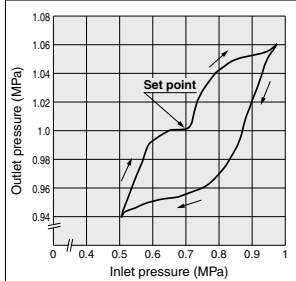

Charge Characteristics (Pressure increase ratio: Twice)

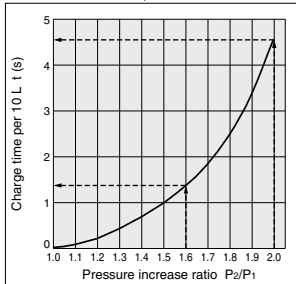

VBA43A

• The time required to charge pressure in the tank from 0.8 MPa to 1.0 MPa at 0.5 MPa supply pressure:

$$\frac{P_2}{P_1} = \frac{0.8}{0.5} = 1.6 \quad \frac{P_2}{P_1} = \frac{1.0}{0.5} = 2.0$$

With the pressure increase ratio from 1.6 to 2.0, the charge time of 4.5 - 1.3 = 3.2 sec. (t) is given by the graph. Then, the charge time (T) for a 100 L tank:

$$T = t \times \frac{V}{10} = 3.2 \times \frac{100}{10} = 32 \text{ (s)}$$

VBA11A

Flow Rate Characteristics

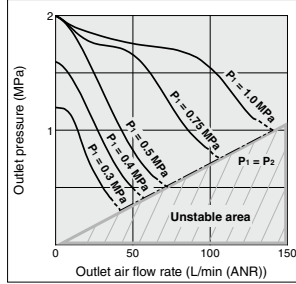

Pressure Characteristics

Inlet pressure: 0.6 MPa
Outlet pressure: 2.0 MPa (Representative value)
Flow rate: 10 L/min (ANR)

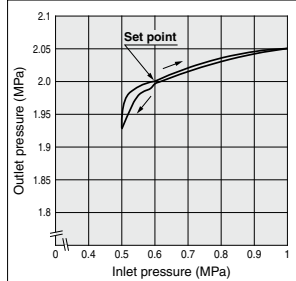

Charge Characteristics (Pressure increase ratio: Twice)

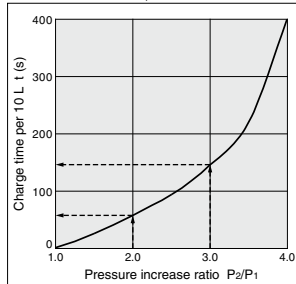

VBA11A

• The time required to charge pressure in the tank from 1.0 MPa to 1.5 MPa at 0.5 MPa supply pressure:

$$\frac{P_2}{P_1} = \frac{1.0}{0.5} = 2.0 \quad \frac{P_2}{P_1} = \frac{1.5}{0.5} = 3.0$$

With the pressure increase ratio from 2.0 to 3.0, the charge time of 147 - 58 = 89 sec. (t) is given by the graph. Then, the charge time (T) for a 10 L tank:

$$T = t \times \frac{V}{10} = 89 \times \frac{10}{10} = 89 \text{ (s)}$$

Pulsation/Pulsation is decreased with a tank.

If the outlet capacity is undersized, pulsation may occur.

VBAT05A

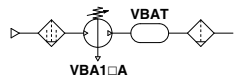
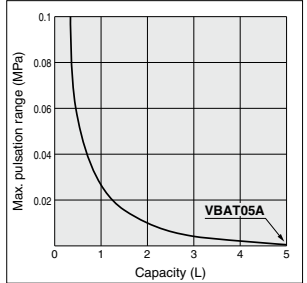

VBAT10A, 20A, 38A

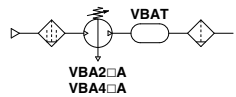
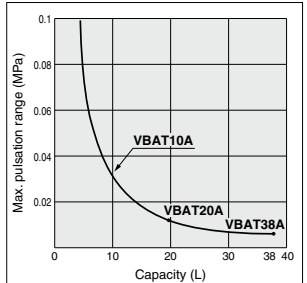

Conditions:
Inlet pressure: 0.5 MPa
Outlet set pressure: 1 MPa
Flow rate: Between 0 and max. flow rate

- Performance of air tank
 - Alleviates the pulsation generated on the outlet side.
 - When air consumption exceeds air supply during intermittent operation, required air will be accumulated in the tank for use. This does not apply for continuous operation.
 - Operation at a flow rate that falls within the unstable area under temporary P₁ ≥ P₂ conditions can be prevented when the outlet side air has been consumed.

ARJ

AR425
to 935

ARX

AMR

ARM

ARP

IR□-A

IR

IRV

VEV

SRH

SRP

SRF

ITV

IC

ITVH

ITVX

PVQ

VY1

VBA
VBAT

AP100

VBA Series

Sizing (Please use the Booster Regulator Model Selection Software on the SMC website, <http://mssc.smcworld.com/brmss/>)

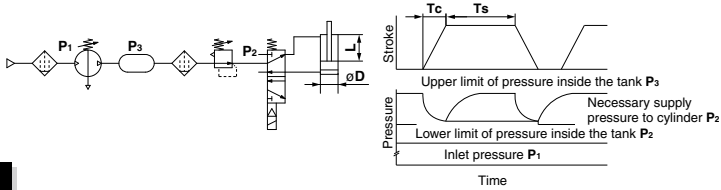

START

Provide requisite conditions for selection.

Necessary conditions:
D [mm]: Cylinder bore size
L [mm]: Cylinder stroke
W [mm/s]: Cylinder operating speed
C [pc.]: Number of cylinders
Tc [s]: Cylinder operating time
Ts [s]: Cylinder stop time
P1 [MPa]: Inlet pressure
P2 [MPa] ^{Note 1)}: Necessary supply pressure to cylinder

Example:
 100
 100
 200
 1
 0.5
 30
 0.5
 0.8

Other conditions:
Q [L/min (ANR)]: Required air flow rate
Qb [L/min (ANR)]: Outlet air flow rate of booster regulator
Tc [s]: Cylinder operating time
K: Cylinder double-acting: 2, single-acting: 1
P3 [MPa] ^{Note 2)}: Tank charge pressure
T1 [s]: Time to charge (Time to charge to P2)
T2 [s]: Time to charge (Time to charge to P3)
T [s]: Time to charge (Time to charge from P2 to P3)
Z: Number of booster regulators

Note 1) P2 is the necessary supply pressure to a cylinder, and set the pressure below the lower limit of pressure inside the tank with a regulator. Adjust the pressure taking the maximum operating pressure of equipment in use into consideration.
 Note 2) P3 is the output pressure of the booster regulator, which is also the upper limit of charge pressure to the tank.

Calculate required air flow rate Q.

$$Q \text{ [L/min (ANR)]} = \frac{\pi \times D^2 \times W}{4 \times 10^6} \times \frac{(P_2 + 0.101)}{0.101} \times 60 \times C$$

$$Q = \frac{\pi \times 100^2 \times 200}{4 \times 10^6} \times \frac{(0.8 + 0.101)}{0.101} \times 60 \times 1 = 841 \text{ [L/min (ANR)]}$$

Select booster regulator size from flow rate characteristics table.

VBA2□A: Qb = 600 [L/min (ANR)]
VBA4□A: Qb = 1050 [L/min (ANR)]
 Refer to "Flow Rate Characteristics" on pages 1012 and 1013.

Caution

- Set the pressure increase ratio of the VBA11A (pressure increase ratio 4) to 2 or more. As a malfunction may occur when operated at a pressure increase ratio of 2 times or less, operate at a pressure increase ratio of 2 (VBA10, VBA20A, etc.).
- Since the booster regulator is a compressor powered by the air, it consumes the air. The air consumption is approximately 1.2 times (pressure increase ratio 2) or 3.7 times (pressure increase ratio 4) larger than the outlet side volume. Therefore, the booster regulator requires a supply capacity of the inlet side volume that is approximately 2.2 times (pressure increase ratio 2) or 4.7 times (pressure increase ratio 4) larger than the outlet side volume.

Judgement of flow rate

NO: Need no tank (The VBA4□A can supply necessary pressure.)

Obtain the tank capacity V.

$$V \text{ [L]} = \frac{(Q - Qb/2) \times (Tc \times K/60)}{(P_3 - P_2) \times 9.9}$$

$$V = \frac{(841 - 600/2) \times (0.5 \times 2/60)}{(1.0 - 0.8) \times 9.9} = 4.6 \text{ [L]}$$

Select the tank capacity over V.

Select the **VBAT10□**, which can be directly connected to the **VBA2□A**.

Calculate time T from charge characteristics table.

Refer to "Charge Characteristics" on pages 1012 and 1013.

$$T \text{ [s]} = \left(\frac{V}{10}\right) \times \frac{T_2 - T_1}{Z}$$

$$T = \left(\frac{4.6}{10}\right) \times \frac{11.5 - 3.8}{1} = 3.5 \text{ [s]}$$

Judgement of charge time T ≤ Ts

NO: Extend stop time Ts up to charge time T or more.

YES

When running continuously for longer periods of time, confirm the life expectancy. When the life expectancy is shorter than required, select a larger sized booster regulator.

END

Avoid pulsation. (Max. 0.05 MPa)

Select the tank from table below.

Tank model	Internal capacity	Applicable combination model		
VBAT05A(1)	5L	VBA10A/11A	—	—
VBAT05S(1)		—	—	—
VBAT10A(1)	10L	VBA10A/11A	VBA20A/22A	—
VBAT10S(1)		—	—	—
VBAT20A(1)	20L	—	VBA20A/22A	VBA40A/42A
VBAT20S(1)		—	—	VBA40A/42A/43A
VBAT38A(1)	38L	—	VBA20A/22A	VBA40A/42A
VBAT38S(1)		—	—	VBA40A/42A/43A

Working Principle

The IN air passes through the check valve to **booster chambers A and B**. Meanwhile, air is supplied to **drive chamber B** via the governor and the switching valve. Then, the air pressure from **drive chamber B** and **booster chamber A** are applied to the piston, boosting the air in **booster chamber B**. As the piston travels, the boosted air is pushed via the check valve to the **OUT** side. When the piston reaches to the end, the piston causes the switching valve to switch, so that **drive chamber B** is in the exhaust state and **drive chamber A** is in the supply state respectively. Then, the piston reverses its movement, this time, the pressures from **booster chamber B** and **drive chamber A** boosts the air in **booster chamber A** and sends it to the **OUT** side. The process described above is repeated to continuously supply highly pressurized air from the IN to the **OUT** side. The governor establishes the outlet pressure by knob operation and pressure adjustment in the drive chamber by feeding back the outlet pressure.

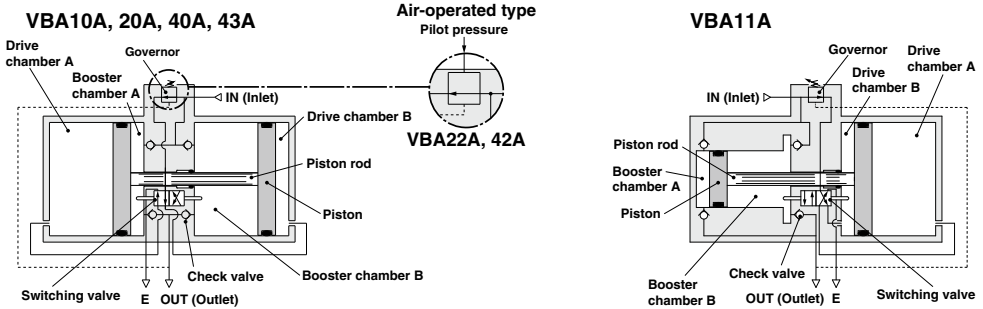

Circuit Example

- When only some of the machines in the plant require high-pressure air, booster regulators can be installed for only the equipment that requires it. This allows the overall system to use low-pressure air while accommodating machines requiring high-pressure air.

General line (low pressure) Locations requiring high pressure

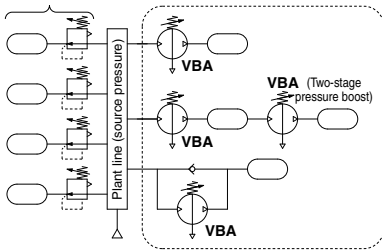

- When using two booster regulators for 2-stage pressure boost, be sure to supply sufficient flow to each booster regulator in order to stabilize the booster regulator inlet pressure. Refer to Selection 2. on page 1016 for the inlet side supply amount.

- When charging a tank or the like from a source at atmospheric pressure, a circuit with a check valve can be used to reduce the charge time by allowing air to pass through the check valve up to the inlet pressure.

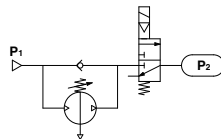

Initially, inlet pressure (P_1) passes through the check valve, fills P_2 , and results in $P_1 = P_2$.

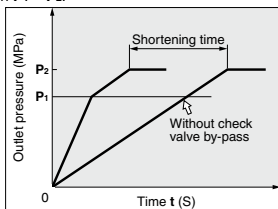

- When the actuator output is insufficient but space limitations prohibit switching to a larger cylinder diameter, a booster regulator can be used to increase the pressure. This makes it possible to boost the output without replacing the actuator.
- When a certain level of output is required but the cylinder size must be kept small so that the driver remains compact.

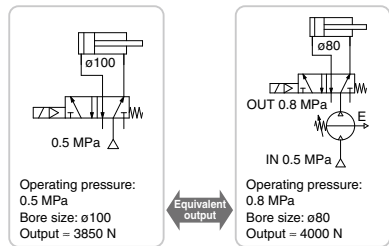

- When only one side of the cylinder is used for work, booster regulators can be installed only on the lines that require them to reduce the overall air consumption volume.

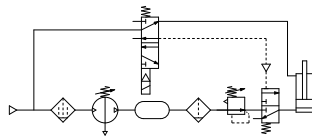

ARJ
AR425 to 935
ARX
AMR
ARM
ARP
IR□-A
IR
IRV
VEX
SRH
SRP
SRF
ITV
IC
ITVH
ITVX
PVQ
VY1
VBA
VBAT
AP100

Design

⚠ Warning

1. Warning concerning abnormal outlet pressure

- If there is a likelihood of causing an outlet pressure drop due to unforeseen circumstances such as equipment malfunction, thus leading to a major problem, take safety measures on the system side.
- Because the outlet pressure could exceed its set range if there is a large fluctuation in the inlet pressure, leading to unexpected accidents, take safety measures against abnormal pressures. If operation at a flow rate that falls within the unstable area ($P_1 \geq P_2$) occurs due to outlet pressure consumption, install an air tank, etc. (Refer to page 1013.)
- Operate the equipment within its maximum operating pressure and set pressure range.

2. Residual pressure measures

- Connect a 3-port valve to the OUT side of the booster regulator if the residual pressure must be released quickly from the outlet pressure side for maintenance, etc. (Refer to the diagram below.) The residual outlet pressure side cannot be released even if the 3-port valve is connected to the IN side because the check valve in the booster regulator will activate.

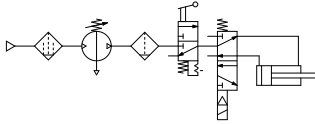

- After operation is finished, release the supply pressure at the inlet. This stops the booster regulator from moving needlessly and prevents operating malfunctions.

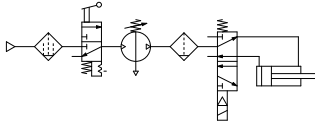

- If operated so that the inlet pressure and outlet pressure are exhausted every operational cycle, the flow rate will occasionally fall within the unstable area shown in the Flow Rate Characteristics graphs on pages 1012 and 1013, resulting in the switching valve stopping halfway and failing to increase the pressure. (The restart method is shown on page 1017-1.)
- When exhausting inlet pressure or outlet pressure (residual pressure), supply inlet pressure to the booster regulator after supplying the inlet pressure to the outlet side volume.

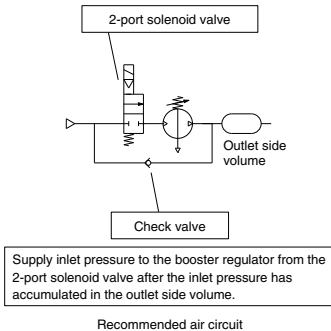

Design

⚠ Caution

1. System configuration

- Be sure to secure an air supply capacity of the minimum operating pressure (0.1 MPa) or more. If the internal operating pressure becomes the minimum operating pressure or less, the switching valve may remain in the intermediate position, which may cause a restart failure.
- The IN port of the booster regulator has metallic mesh to prevent dust from entering the booster regulator. However, it cannot remove dust continuously or separate drainage. Make sure to install a mist separator (AM series) on the inlet side of the booster regulator.
- The booster regulator has a sliding part inside, and it generates dust. Also, install an air purification device such as an air filter or a mist separator on the outlet side as necessary.
- Connect a lubricator to the outlet side, because the accumulated oil in the booster regulator may result in a malfunction.

2. Exhaust air measures

- Provide a dedicated pipe to release the exhaust air from each booster regulator. If centralized piping is used for the exhaust air, the switching valve may stop halfway and fail to increase the pressure due to the influence of other exhaust.
- In the same manner, if a silencer or exhaust cleaner other than those designated by SMC is used, back pressure will be generated due to the clogging of the silencer, which may result in the switching valve stopping halfway and failing to increase the pressure.
- Depending on the necessity, install a silencer or an exhaust cleaner on the exhaust port of the booster regulator to reduce the exhaust noise.

3. Maintenance space

- Allow the sufficient space for maintenance and inspection.

Selection

⚠ Caution

1. Check the specifications.

- Consider the operating conditions and operate this product within the specification range that is described in this catalog.

2. Selection

- Based on the conditions (such as pressure, flow rate and cycle time) required for the outlet side of the booster regulator, check the selection procedures described in this catalog or model selection software for size selection of the booster regulator. Model selection can be done using the selection software on the SMC website. Go to Documents/Downloads → Model Selection Software → Booster Regulators
- Since the booster regulator is a compressor powered by the air, it consumes the air. The air consumption is approximately 1.2 times (pressure increase ratio 2) or 3.7 times (pressure increase ratio 4) larger than the outlet side volume. Therefore, the booster regulator requires a supply capacity of the inlet side volume that is approximately 2.2 times (pressure increase ratio 2) or 4.7 times (pressure increase ratio 4) larger than the outlet side volume.
- Set the pressure of the VBA10A, VBA20A, VBA22A, VBA40A, VBA42A or VBA43A (pressure increase ratio 2) to a level that is at least 0.1 MPa higher than the inlet pressure. If the pressure differential is 0.1 MPa or less, the internal operating pressure becomes the minimum operating pressure or less and the switching valve may remain at the intermediate position, causing a restart failure.
- Set the pressure increase ratio of the VBA11A (pressure increase ratio 4) to 2 or more. When the VBA11A is used at a pressure increase ratio of 2 or less, the internal operating pressure becomes the minimum operating pressure or less and the switching valve may remain at the intermediate position, causing a restart failure.
- When operating the booster regulator continuously for longer periods of time, particularly confirm its service life.
- The service life of the booster regulator depends on not the operation hours but the operating cycles (piston sliding distance). The operating cycles (piston sliding distance) depend on the outlet flow of the booster regulator. Thus, when more outlet flow of the booster regulator is used, its service life becomes shorter. Selecting a booster regulator of a larger size will result in reduced operation frequency, thus increasing the service life of the product.
- When using two booster regulators for 2-stage pressure boost, be sure to provide a stable supply of pressure to the downstream booster regulator, and install a pressure vessel such as an air tank, etc., between the booster regulators. (Refer to the circuit diagram shown on page 1015.)

Mounting

⚠ Caution

1. Transporting

- When transporting this product, hold it lengthwise with both hands. Never hold it by the black knob that protrudes from the center because the knob could become detached from the body, causing the body to fall and leading to injury.

2. Installation

- Install this product so that the silver-colored tie-rods and cover are placed horizontally. If mounted vertically, it may result in a malfunction.
- Because the piston cycle vibration is transferred, use the following mounting bolts (VBA1: M5; VBA2, 4: M10) and tighten them with the specified torque (VBA1: 3 N·m; VBA2, 4: 24 N·m).
- If the transmission of vibration is not preferred, insert an isolating rubber material before installation.
- Mount the pressure gauge with a torque of 7 to 9 N·m.

Piping

⚠ Caution

1. Flushing

- Use an air blower to flush the piping to thoroughly remove any cutting chips, cutting oil, or debris from the piping inside, before connecting them. If they enter the inside of the booster regulator, they could cause the booster regulator to malfunction or its durability could be affected.

2. Piping size

- To bring the booster regulator's ability into full play, make sure to match the piping size to the port size.

Air Supply

⚠ Caution

1. Quality of air source

- Connect a mist separator to the inlet side near the booster regulator. If the quality of the compressed air is not thoroughly controlled, the booster regulator could malfunction (without being able to boost) or its durability could be affected.
- If dry air (atmospheric pressure dew point: -23°C or less) is used, the life expectancy may be shortened because dry air will accelerate evaporation of grease inside.

2. Pressure fluctuation

- Provide a stable supply of pressure for the inlet pressure. If the inlet pressure supply is unstable, operation also becomes unstable, which may result in the switching valve stopping halfway and failing to increase the pressure.

Operating Environment

⚠ Caution

1. Installation location

- Do not install this product in an area that is exposed to rainwater or direct sunlight.
- Do not install in locations influenced by vibrations. If it must be used in such an area due to unavoidable circumstances, please contact SMC beforehand.

Handling

⚠ Caution

1. Setting the pressure on the knob-operated type

- If air is supplied to the product in the shipped state, the air will be released. Set the pressure by quickly pulling up on the governor knob, releasing the lock, and rotating the knob in the direction of the arrow (+).
- There is an upper and lower limit for the knob rotation. If over-rotating the knob even after reaching to the limit, the internal parts may be damaged. If the knob suddenly feels heavy while being turned, stop turning the knob.
- Once the setting is completed, push the knob down and lock it.
- To decrease the outlet pressure, after the pressure has been set, rotate the knob in the direction of the arrow (-). The residual air will be released from the area of the knob, due to the relief construction of the governor.
- To reset the pressure, first reduce the pressure so that it is lower than the desired pressure; then, set it to the desired pressure.

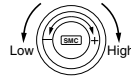

2. Setting the pressure on the air-operated type (VBA22A, 42A)

- Connect the outlet pipe of the pilot regulator for the remote control to the pilot port (P). (Refer to the diagram below.)
- Refer to the graph below for the relationship between the pilot pressure and outlet pressure.
- The AR20 and AW20 are recommended for the pilot regulator.

Pilot regulator

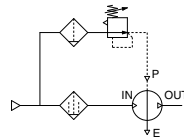

- The outlet pressure is twice the pilot pressure.
- When the inlet pressure is 0.4 MPa:

Pilot pressure
0.2 MPa to 0.4 MPa
Outlet pressure
0.4 MPa to 0.8 MPa

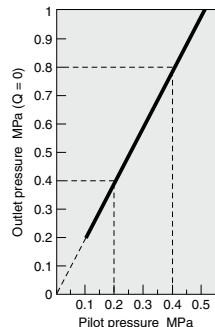

ARJ

AR425
to 935

ARX

AMR

ARM

ARP

IR□-A

IR

IRV

VEV

SRH

SRP

SRF

ITV

IC

ITVH

ITVX

PVQ

VY1

VBA
VBAT

AP100

Handling

Caution

3. Draining

- If this product is used with a large amount of drainage accumulated in the filter, mist separator or tank, the drainage could flow out, leading to equipment malfunction. Therefore, drain the system once a day. If it is equipped with an auto drain, check its operation once a day.

4. Exhaust

- If the air on the OUT side is not consumed for a long period of time when the pressure increase ratio is set to 2 or less, there may be delays in the left and right switching operation of the piston, which may result in air leakage from the exhaust port. This phenomenon is not considered abnormal. The leak will stop once the air on the OUT side is consumed.

5. Maintenance

Booster regulator

- Life expectancy varies depending on the quality of air and the operating conditions. Signs that the unit is reaching the end of its service life include the following:
 - Constant bleed from under the knob.
 - Air exhaust noise can be heard from the booster regulator at 10 to 20 second intervals even when there is no air consumption on the outlet side.Conduct maintenance earlier than scheduled in such cases.
- When maintenance is required, confirm the model and lot number of the booster regulator, and please contact SMC for maintenance kit.
- Conduct maintenance according to the specified maintenance procedure by individuals possessing enough knowledge and experiences in maintaining pneumatic equipment.
- The list of replacement parts and kit number are shown on page 1018, and the figure shows the position of the parts.

Silencer

It is normal for the silencer to change in color due to the turbine oil, grease, and drain contained in the exhaust, the surrounding atmosphere, etc. Back pressure will be generated if the silencer is clogged, which may result in the switching valve stopping halfway and failing to increase the pressure; therefore, be sure to perform regular maintenance on the product.

6. Restart method when the pressure will not increase

- With the inlet side in a pressurized state, use your finger, a finger valve, etc., to block the exhaust port, let the exhaust pressure rise, and then quickly release it.
- Release inlet and outlet pressure air and, after confirming the safety of the downstream devices, resupply the air.

VBA Series

Construction/Replacement Parts

VBA10A

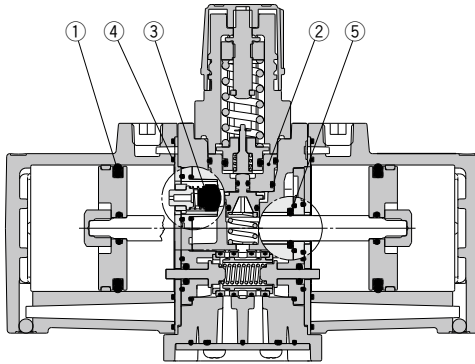

VBA11A

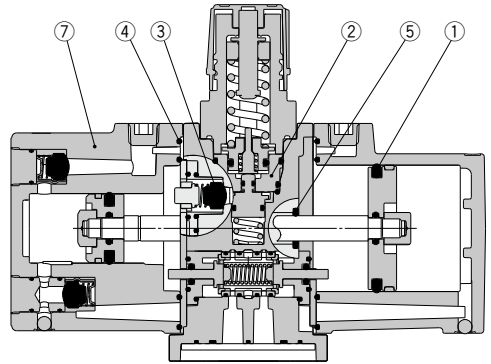

VBA20A, 22A, VBA40A, 42A, 43A

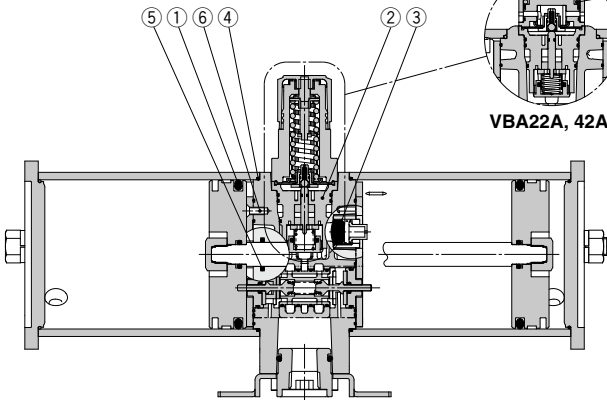

Replacement Parts/Kit No.

Place an order with the following applicable kit number.

Model	VBA10A	VBA20A	VBA40A	VBA22A	VBA42A	VBA43A	VBA11A
Kit no.	KT-VBA10A-1	KT-VBA20A-1	KT-VBA40A-1	KT-VBA22A-1	KT-VBA42A-1	KT-VBA43A-1	KT-VBA11A-20

The kit includes the parts from ① to ⑦ and a grease pack.

No.	Description	Model	VBA10A	VBA20A	VBA40A	VBA22A		VBA42A	VBA43A	VBA11A
						Quantity	Quantity			
1	Piston seal			2		2 large	1 small		2	1 each large and small
2	Governor assembly					1				
3	Check valve				4					2
4	Gasket					2				
5	Rod seal					1				
6	Mounting screw		—	8	12	8		12		—
7	Cover C assembly					—				1
—	Grease pack		1		2	1		2		1

* The grease pack has 10 g of grease.

* Make sure to refer to the procedure for maintenance.

* For details on the replacement parts kit, refer to the procedure for maintenance.

* Refer to page 1011 for pressure gauges.

Dimensions

VBA10A-02

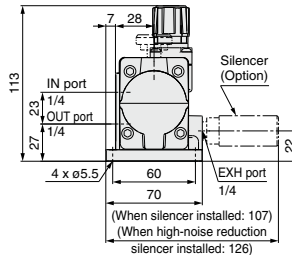
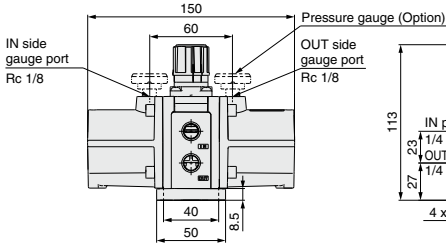

With elbow silencer (Option)

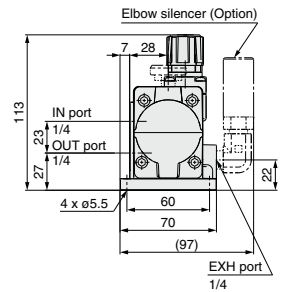

VBA11A-02

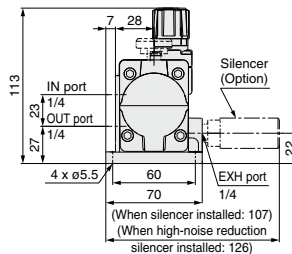
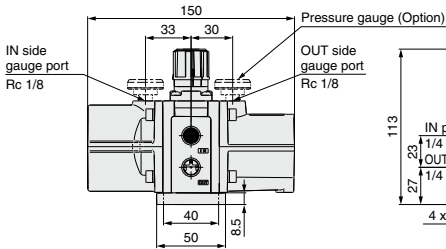

With elbow silencer (Option)

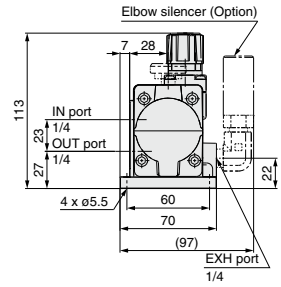

VBA20A-03

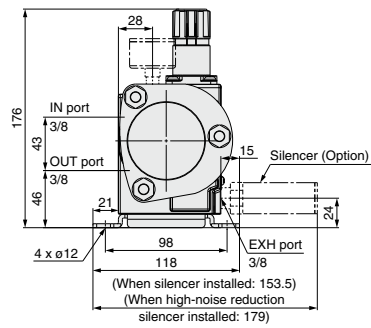
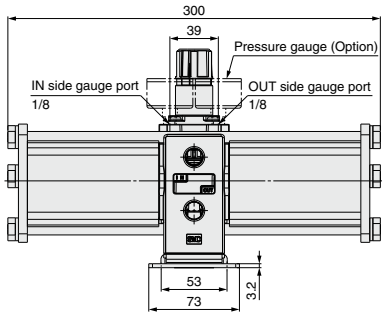

VBA40A-04

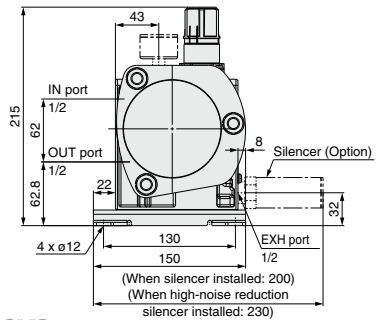
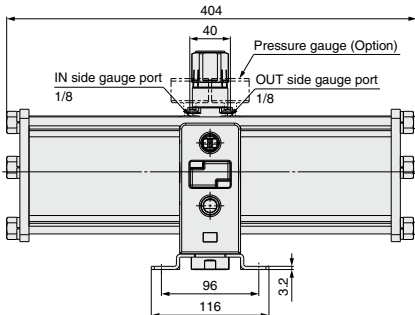

ARJ
AR425 to 935
ARX
AMR
ARM
ARP
IR□-A
IR
IRV
VEX
SRH
SRP
SRF
ITV
IC
ITVH
ITVX
PVQ
VY1
VBA
VBAT
AP100

VBA Series

Dimensions

VBA22A-03

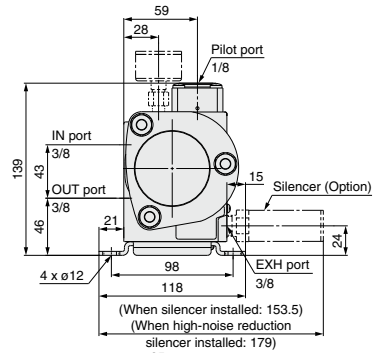
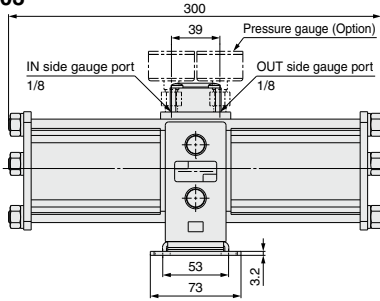

VBA42A-04

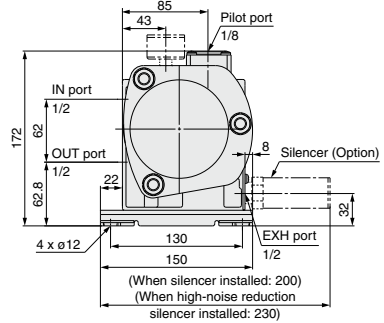
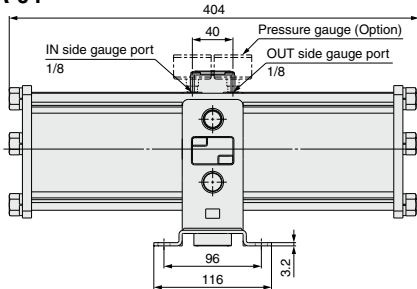

VBA43A-04

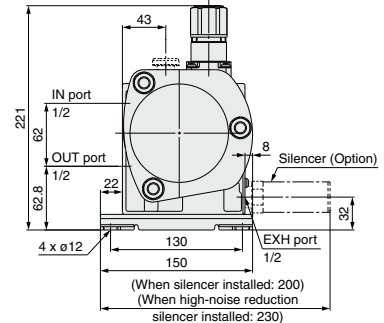
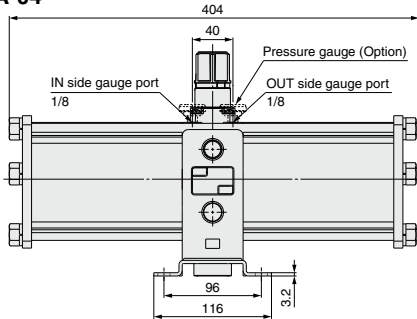

Made to Order

Made to Order For detailed dimensions, specifications and lead times, please contact SMC.

1 Copper-free/Fluorine-free

The inner or outer copper parts material has been changed to stainless steel or aluminum. The fluorine resin parts has been changed to general resin.

20 — Standard model no.

- Made to Order
Copper-free/Fluorine-free
(Excludes models with a pressure gauge (Option))

* This option cannot be selected for air tank with safety valve.

2 CE explosion-proof directive (ATEX) compliant

56 — Standard model no.

- Made to Order
CE explosion-proof directive (ATEX):
Category 3GD

3 Ozone resistant

Ozone resistance is strengthened through the use of fluororubber (diaphragm) and hydrogenated NBR (valve, rod seal) for the rubber parts of the seal material.

80 — Standard model no.

- Made to Order
Ozone resistant

* Weather resistant NBR (diaphragm) and hydrogenated NBR (valve) are used for the rubber parts of the standard model.

Air Tank VBAT Series

RoHS

* Except the Chinese pressure vessel regulations compliant product (-X104)



Made to Order
(For details, refer to page 1024.)

How to Order

- Compact connections are possible with booster regulators.
- It can be used alone as a tank.
- Also partially compatible with overseas standards



VBAT05A1



VBAT10S1



VBAT20S1



VBAT38A1

Caution

When used as a single unit (not connected with a booster regulator) and pressurized at over 1 MPa at normal temperatures, the air tank falls under the scope of the "High Pressure Gas Safety Act" in Japan.

Standard Product (For Japanese Market)

VBAT 10 A 1 - S

Note) The thread type for each port is Rc.

Tank internal capacity

Symbol	Internal capacity
05	5 L
10	10 L
20	20 L
38	38 L

Material

Symbol	Material
A	Carbon steel (SS400)
S	Stainless steel 304

Option

Symbol	Option
Nil	None
V	Drain valve

Option

Symbol	Option	Applicable model
Nil	None Note)	All models
R	Safety valve (Set pressure: 1 MPa)	VBAT05A1, VBAT10A1, VBAT20A1, VBAT38A1
S	Safety valve (Set pressure: 2 MPa)	VBAT05A1, VBAT10A1

Note) A safety valve port is provided only when option R or S is selected.

CE Certified Product

VBAT 10 A F - SV - Q

Tank internal capacity

Symbol	Internal capacity
05	5 L
10	10 L
20	20 L
38	38 L

Material

Symbol	Material
A	Carbon steel (SS400)

CE certified product (Self-declaration document attached)

Accessories

Symbol	Accessories	Applicable model
RV	Safety valve (Set pressure: 1 MPa) Drain valve	VBAT20A, VBAT38A
SV	Safety valve (Set pressure: 2 MPa) Drain valve	VBAT05A, VBAT10A

Thread type

Symbol	Thread type
Nil	Rc
F	G

Chinese Pressure Vessel Regulations Compliant Product

VBAT 05 A1 - U - X104

Tank capacity

Symbol	Internal capacity
05	5 L
10	10 L
20	22 L
38	38 L

Material

Symbol	Material
A1	Carbon steel
S1	Stainless steel

• Chinese pressure vessel regulations compliant product

• Safety valve/Pressure gauge set Note

Symbol	Applicable model
U	VBAT05A1, VBAT10A1 VBAT05S1, VBAT10S1
T	VBAT20A1, VBAT38A1 VBAT20S1, VBAT38S1

Note) When a drain valve is required, please order it separately.
Drain valve part no.: VBAT-V1
Note) The safety valve/pressure gauge set is not RoHS compliant.

ASME Standards Compliant Product

VBAT 05 A N 1 - E - X105

Tank capacity

Symbol	Internal capacity
05	5 L
10	10 L
20	22 L
38	38 L

Material

Symbol	Material
A	Carbon steel (SA-414)
S	Stainless steel (SA-240 316)

Thread type

Symbol	Thread type
Nll	Rc
N	NPT

• ASME standards compliant product

Note) This product can only be purchased from the SMC Corporation of America.
For details on how to order and lead times, please contact SMC separately.

• Accessory

Symbol	Accessory
E	Safety valve/Set pressure: 2.0 MPa (Included)
EV	Safety valve/Set pressure: 2.0 MPa (Included) + Drain valve

* A safety valve is required according to ASME Standards.

**The drain valve is sold separately.
Please order it separately.
(Packaged and shipped separately)**

Part no.	Thread type
VBAT-V1	Rc
VBAT-V1N	NPT

List of Air Tank for Overseas

Country/Region	Law	Exportable models	Details	Option (Order it separately.)
South Korea	1. Occupational Safety and Health Act KCs Certification 2. High-Pressure Gas Safety Control Act	VBAT05A1-X101 <small>Note 2)</small> VBAT10A1-X101 VBAT20A1-X101 VBAT38A1-X101 VBAT05S1-X101 VBAT10S1-X101 VBAT20S1-X101 VBAT38S1-X101	1. KCs Certification compliant product (Certificate included) A safety valve must be mounted. 2. High-pressure Gas Act not applicable (Not applicable when maximum operating pressure: 0.97 MPa)	VBAT-K <small>Note 1)</small> (Safety valve) VBAT-V1 (Drain valve)
Thailand, Taiwan	No applicable standard	Standard product		

Note 1) VBAT-K is not RoHS compliant.

Note 2) KCs certification is not applicable for this product. (Exception: When the inner diameter is less than 150 mm) KCs certification is not required for the VBAT05A1-X101, so there is no certification mark on the product.

In addition, as KCs certification is not applicable for this product, the installation of a safety valve is optional. If installation is desired, the VBAT-R may also be used.

ARJ
AR425 to 935
ARX
AMR
ARM
ARP
IR□-A
IR
IRV
VEV
SRH
SRP
SRF
ITV
IC
ITVH
ITVX
PVQ
VY1
VBA VBAT
AP100

VBAT Series

Standard Product (For Japanese Market)

Specifications

Model		VBAT05□1	VBAT10□1	VBAT20□1	VBAT38□1
Fluid					
Compressed air					
Tank capacity (L)		5	10	20	38
Max. operating pressure (MPa)	VBAT□A1	2.0		2.0	1.0
	VBAT□S1				
IN port size			3/8		1/2
OUT port size		3/8	3/8	1/2	3/4
Proof pressure (MPa)	VBAT□A1	3.3			1.6
	VBAT□S1	3.3			3.3
Ambient and fluid temperature (°C)		0 to 75			
Installation					
Horizontal (Floor mounting)					
Weight (kg)	VBAT□A1	6.6	10	14	21
	VBAT□S1	3.2	4.9	12	19
Material					
Carbon steel (SS400)					
Stainless steel 304					
Paint					
Outside: Silver paint, Inside: Rustproof paint					
None					

Note 1) The accessories and options are included in the same container.

Note 2) Since neither copper nor fluorine parts are used for the tank, the standard model can be used as a copper-free product when drain valve is not necessary.

Note 3) Scratches, scrapes, blotches, and uneven color may be present on the surface, but they do not affect the function or performance of the product.

Options/Accessories/Part No.

<For VBAT□A1 (Carbon Steel)>

Model	VBAT05A1-□	VBAT10A1-□	VBAT20A1-□	VBAT38A1-□
Accessory kit	VBAT5A-Y-3	VBAT10A-Y-3	VBAT20A-Y-3	
Safety valve (When selecting an option) ^{Note 1) 2)}	VBAT-R (Set pressure: 1 MPa), VBAT-S (Set pressure: 2 MPa)		VBAT-R (Set pressure: 1 MPa)	
Drain valve (When selecting an option)	VBAT-V1			

Note 1) The set pressure of the safety valve cannot be changed.

Note 2) The safety valve is a safety measure that protects the tank from excess pressure. The valve opens automatically when the specified pressure is reached, releasing excess pressure inside the tank. The valve closes again when the pressure drops below a designated value. Select a pressure valve appropriate for the maximum operating pressure specification of the tank.

<For VBAT□S1 (Stainless Steel)>

Model	VBAT05S1-□	VBAT10S1-□	VBAT20S1-□	VBAT38S1-□
Accessory kit	VBAT5S-Y-4	VBAT10S-Y-4	VBAT20S-Y-4	
Drain valve (When selecting an option)	VBAT-V1			

The Accessory Kit is a Set of Nos. ① to ④.

No.	Model Description	VBAT5A-Y-3	VBAT10A-Y-3	VBAT20A-Y-3
		VBAT5S-Y-4	VBAT10S-Y-4	VBAT20S-Y-4
		Quantity		
①	O-ring	1	1 (VBA1□A) 1 (VBA2□A)	1
②	Hexagon socket head taper screwed plug (for drain port)	1	1	1
③	Hexagon socket head cap screw	4	4 (VBA1□A) 4 (VBA2□A)	4
④	Anchor bolt/nut	—	—	4

For detailed dimensions, specifications and lead times, please contact SMC.

Made to Order



1 Copper-free/Fluorine-free

VBAT-V2 (A set of stainless steel needle valve and fittings) is included with the standard product.

Made to Order • Tank internal capacity • Copper-free/Fluorine-free

20 - VBAT10A 1 - V

• Material

Symbol	Material
A	Carbon steel (SS400)
S	Stainless steel

Symbol	Internal capacity
05	5 L
10	10 L
20	20 L
38	38 L

Note 1) The thread type for each port is Rc.

Note 2) Stainless steel fittings and a needle valve are included in the same container as accessories. (For lead times and detailed dimensions, please contact SMC.) It can be ordered separately.

Note 3) Since neither copper nor fluorine parts are used for the tank, the standard model can be used as a copper-free product when drain valve is not necessary.

Note 4) The material of the safety valve is brass only.

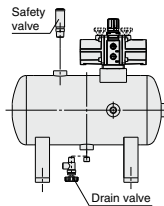

Drain valve: VBAT-V1

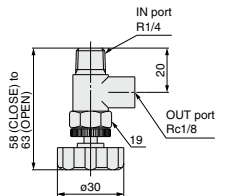

Body material: Brass

Safety valve: VBAT-R, VBAT-S

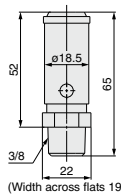

Body material: Brass

Safety valve mounting diagram when there is no safety valve port

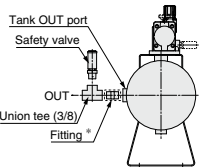

* When the tank OUT port is 3/8, use 3/8 fittings. When the size of the tank OUT port is other than 3/8, change the size with a 3/8 union tee fitting.

Mounting diagram for drain valve VBAT-V2

(A set of stainless steel needle valve and fittings is included.)

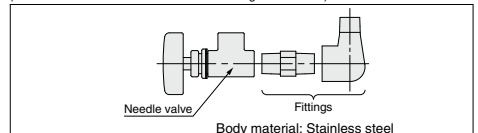

Body material: Stainless steel

Dimensions: Standard Product (For Japanese Market)

VBAT05A1 Material: Carbon steel

Connected to VBA10A, 11A

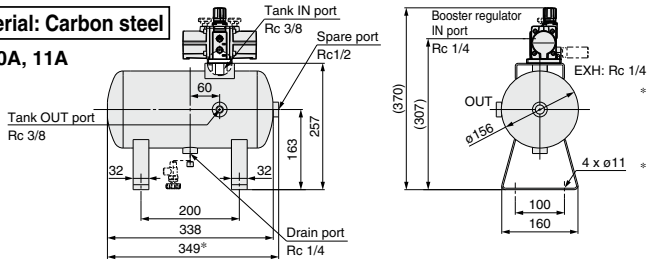

* The length may be longer than the specification if the plugs mounted on the tank are not fit to the end.
 ** The plug in the spare port has been firmly secured with adhesive. When removing the plug to use the port, be careful so as not to damage the plug.

VBAT10A1 Material: Carbon steel

Connected to VBA10A, 11A

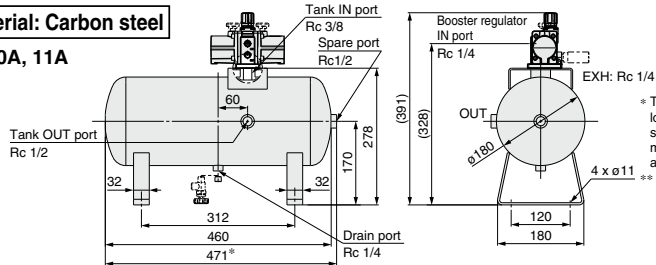

* The length may be longer than the specification if the plugs mounted on the tank are not fit to the end.
 ** The plug in the spare port has been firmly secured with adhesive. When removing the plug to use the port, be careful so as not to damage the plug.

Connected to VBA20A

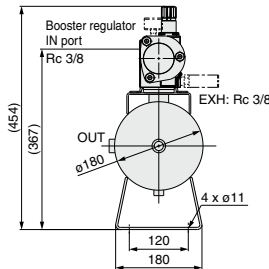
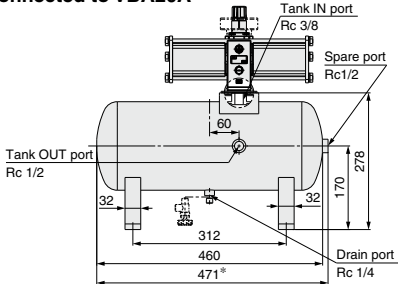

Connected to VBA22A

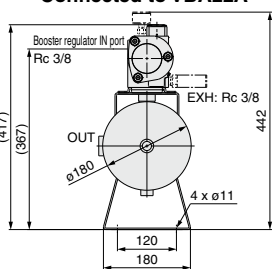

* The length may be longer than the specification if the plugs mounted on the tank are not fit to the end.
 ** The plug in the spare port has been firmly secured with adhesive. When removing the plug to use the port, be careful so as not to damage the plug.

VBAT20A1 Material: Carbon steel

Connected to VBA20A, 40A

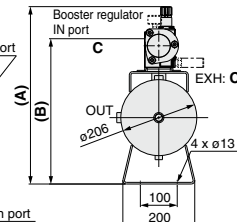
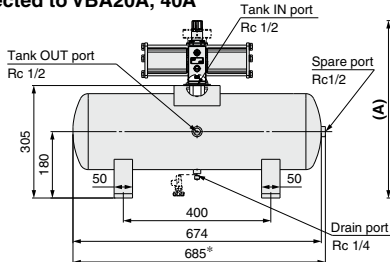

Connected to VBA22A, 42A

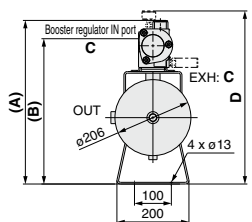

* The length may be longer than the specification if the plugs mounted on the tank are not fit to the end.
 ** The plug in the spare port has been firmly secured with adhesive. When removing the plug to use the port, be careful so as not to damage the plug.

Booster regulator model	A	B	C	D	Note
VBA20A	481	394	Rc 3/8	—	
VBA40A	520	429.8	Rc 1/2	—	
VBA22A	444	394	Rc 3/8	469	
VBA42A	477	429.8	Rc 1/2	493	

Note) When option G (pressure gauge) is selected

VBAT Series

Dimensions: Standard Product (For Japanese Market)

VBAT38A1 Material: Carbon steel

Connected to VBA20A, 40A

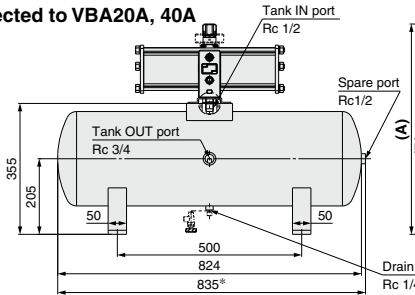

Connected to VBA22A, 42A

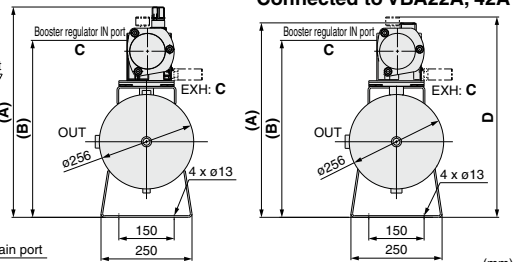

Booster regulator model	A	B	C	D (Note)
VBA20A	531	444	Rc 3/8	—
VBA40A	570	479.8	Rc 1/2	—
VBA22A	494	444	Rc 3/8	519
VBA42A	527	479.8	Rc 1/2	543

Note) When option G (pressure gauge) is selected

VBAT05S1 Material: Stainless steel 304

Connected to VBA10A, 11A

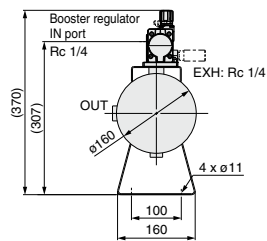
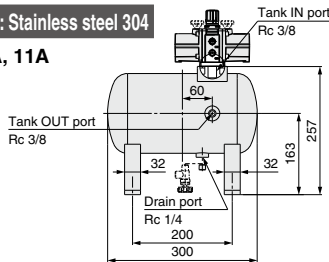

VBAT10S1 Material: Stainless steel 304

Connected to VBA10A, 11A

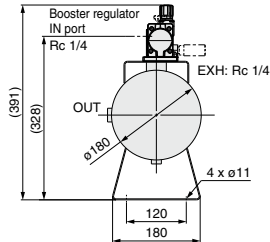
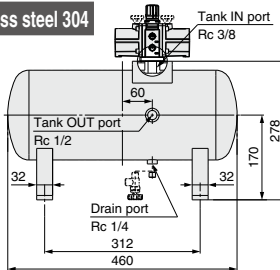

Connected to VBA20A

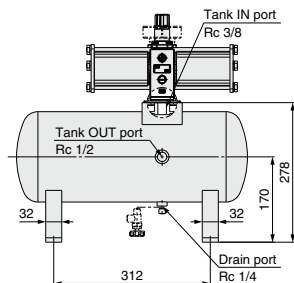

Connected to VBA22A

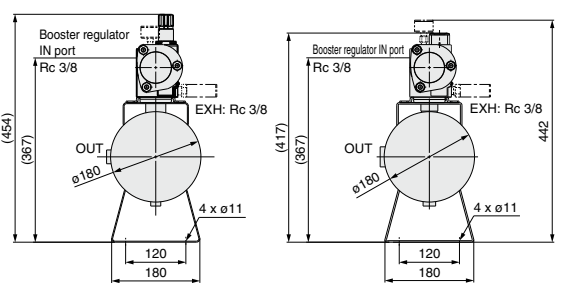

Dimensions: Standard Product (For Japanese Market)

VBAT20S1 Material: Stainless steel 304

Connected to VBA20A, 40A, 43A

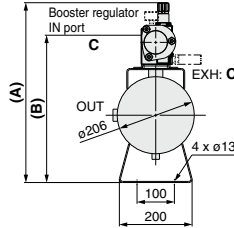
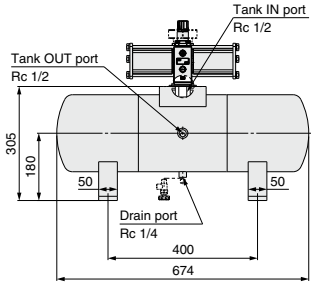

Connected to VBA22A, 42A

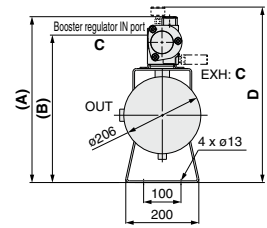

Booster regulator model	A	B	C	D (Note)
VBA20A	481	394	Rc 3/8	—
VBA40A	520	429.8	Rc 1/2	—
VBA22A	444	394	Rc 3/8	469
VBA42A	477	429.8	Rc 1/2	493
VBA43A	526	429.8	Rc 1/2	—

Note) When option G (pressure gauge) is selected

VBAT38S1 Material: Stainless steel 304

Connected to VBA20A, 40A, 43A

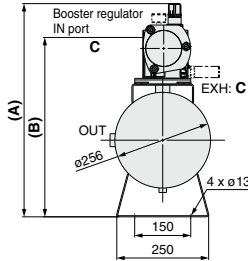
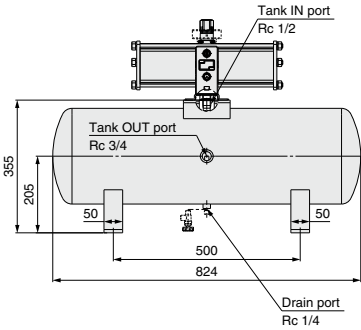

Connected to VBA22A, 42A

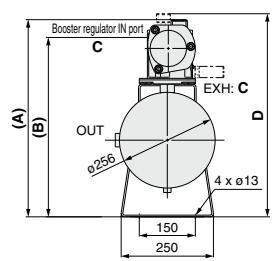

Booster regulator model	A	B	C	D (Note)
VBA20A	531	444	Rc 3/8	—
VBA40A	570	479.8	Rc 1/2	—
VBA22A	494	444	Rc 3/8	519
VBA42A	527	479.8	Rc 1/2	543
VBA43A	576	479.8	Rc 1/2	—

Note) When option G (pressure gauge) is selected

VBAT⁰⁵₁₀A1-R With safety valve

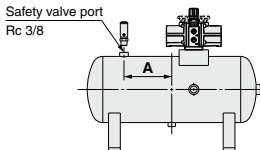

Tank model	A
VBAT05	60
VBAT10	130

VBAT²⁰₃₈A1-R With safety valve

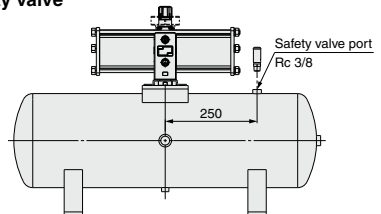

ARJ
AR425 to 935
ARX
AMR
ARM
ARP
IR□-A
IR
IRV
VEV
SRH
SRP
SRF
ITV
IC
ITVH
ITVX
PVQ
VY1
VBA
VBAT
AP100

VBAT Series

CE Marking-Conformity Products

Specifications

Model	VBAT05A□-SV-Q	VBAT10A□-SV-Q	VBAT20A□-RV-Q	VBAT38A□-RV-Q
Fluid	Compressed air			
Tank capacity (L)	5	10	20	38
Max. operating pressure (MPa)	2.0		1.0	
IN port size	3/8	1/2	3/4	
OUT port size	3/8	1/2	1/2	3/4
Proof pressure (MPa)	3.3		1.6	
Ambient and fluid temperature (°C)	0 to 75			
Installation	Horizontal (Floor mounting)			
Weight (kg)	6.6	10	14	21
Material	Carbon steel (SS400)			
Paint	Outside: Silver paint, Inside: Rustproof paint			

Note 1) Accessories are included in the same container.

Note 2) Scratches, scrapes, blotches, and uneven color may be present on the surface, but they do not affect the function or performance of the product.

Accessories/Part No.

<CE Marking-Conformity Products>

Model	VBAT05A□-SV-Q	VBAT10A□-SV-Q	VBAT20A□-RV-Q	VBAT38A□-RV-Q
Accessory kit	VBAT5A-Y-2	VBAT10A-Y-2	VBAT20A-Y-2	
Safety valve	VBAT-S (Set pressure: 2 MPa)		VBAT-R (Set pressure: 1 MPa)	
Drain valve	VBAT-V1			

The Accessory Kit is a Set of Nos. ① to ⑤.

No.	Description	Model	Quantity		
			VBAT5A-Y-2	VBAT10A-Y-2	VBAT20A-Y-2
①	Bushing assembly (with O-ring)		1	1	1
②	Hexagon socket head taper screwed plug (for drain port)		1	1	1
③	Hexagon socket head cap screw		4	4 (VBA1□A) 4 (VBA2□A)	4
④	Anchor bolt/nut		—	—	4
⑤	Hexagon socket head taper screwed plug (for safety valve port)		1	1	1

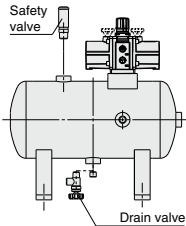

Drain valve: VBAT-V1

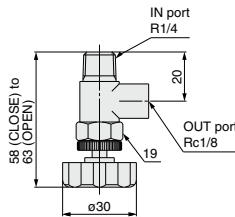

Body material: Brass

Safety valve: VBAT-R, VBAT-S

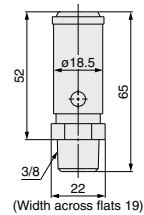

Body material: Brass

Dimensions: CE Marking-Conformity Products

VBAT05A-Q Material: Carbon steel

Connected to VBA10A, 11A

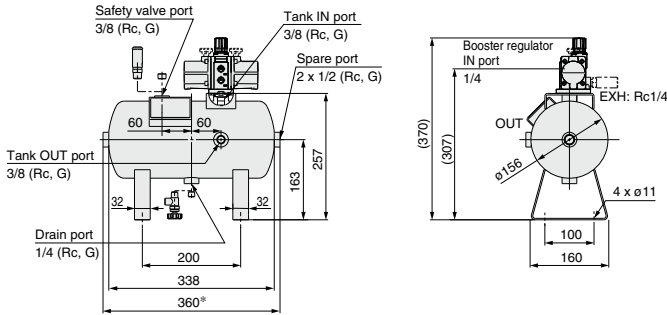

- * The length may be longer than the specification if the plugs mounted on the tank are not fit to the end.
- ** The plug in the spare port has been firmly secured with adhesive. When removing the plug to use the port, be careful so as not to damage the plug.

VBAT10A-Q Material: Carbon steel

Connected to VBA10A, 11A

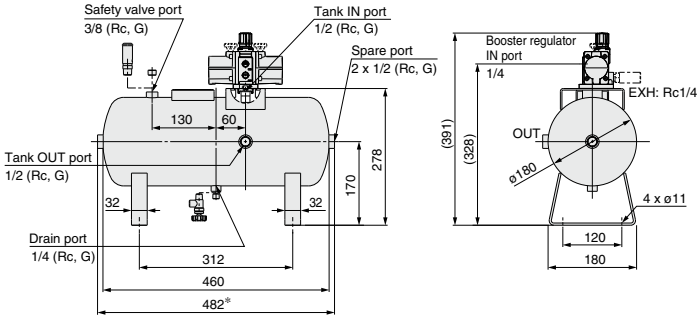

- * The length may be longer than the specification if the plugs mounted on the tank are not fit to the end.
- ** The plug in the spare port has been firmly secured with adhesive. When removing the plug to use the port, be careful so as not to damage the plug.

Connected to VBA20A

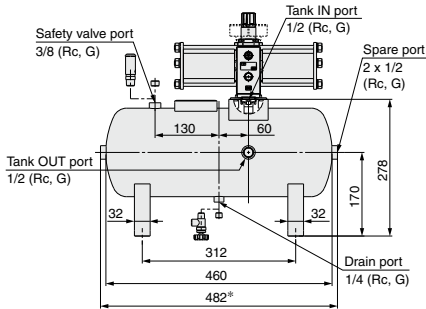

Connected to VBA22A

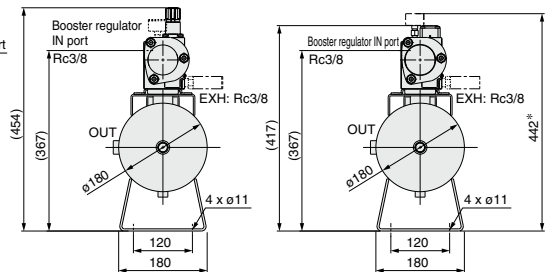

* When option G (pressure gauge) is selected

- * The length may be longer than the specification if the plugs mounted on the tank are not fit to the end.
- ** The plug in the spare port has been firmly secured with adhesive. When removing the plug to use the port, be careful so as not to damage the plug.

ARJ
AR425 to 935
ARX
AMR
ARM
ARP
IR□-A
IR
IRV
VEX
SRH
SRP
SRF
ITV
IC
ITVH
ITVX
PVQ
VY1
VBA VBAT
AP100

VBAT Series

Dimensions: CE Marking-Conformity Products

VBAT20A-Q Material: Carbon steel

Connected to VBA20A, 40A

Connected to VBA22A, 42A

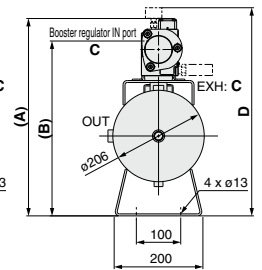
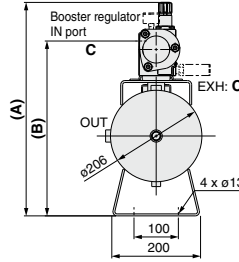
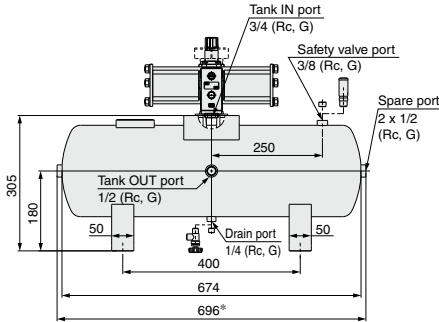

- * The length may be longer than the specification if the plugs mounted on the tank are not fit to the end.
- ** The plug in the spare port has been firmly secured with adhesive. When removing the plug to use the port, be careful so as not to damage the plug.

Booster regulator model	A	B	C	D
VBA20A	481	394	Rc3/8	—
VBA40A	520	429.8	Rc1/2	—
VBA22A	444	394	Rc3/8	469
VBA42A	477	429.8	Rc1/2	493

(mm) (Note) When option G (pressure gauge) is selected

VBAT38A-Q Material: Carbon steel

Connected to VBA20A, 40A

Connected to VBA22A, 42A

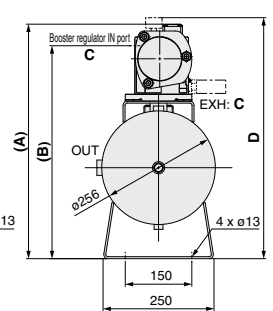
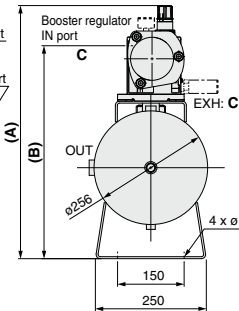
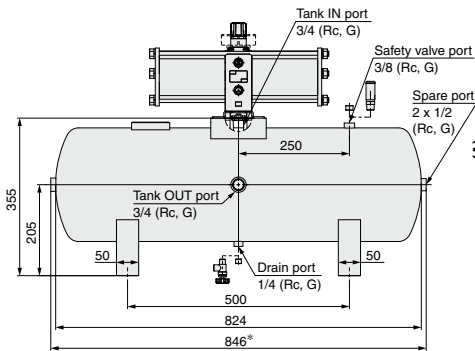

- * The length may be longer than the specification if the plugs mounted on the tank are not fit to the end.
- ** The plug in the spare port has been firmly secured with adhesive. When removing the plug to use the port, be careful so as not to damage the plug.

Booster regulator model	A	B	C	D
VBA20A	531	444	Rc3/8	—
VBA40A	570	479.8	Rc1/2	—
VBA22A	494	444	Rc3/8	519
VBA42A	527	479.8	Rc1/2	543

(mm) (Note) When option G (pressure gauge) is selected

VBAT Series

ASME Standards Compliant Product

Specifications

Model	VBAT05□□1-X105	VBAT10□□1-X105	VBAT20□□1-X105	VBAT38□□1-X105
Fluid	Compressed air			
Tank capacity [L]	5	10	22	38
Max. operating pressure [MPa]	2.0			
IN port size	3/8		1/2	
OUT port size	3/8	1/2	1/2	3/4
Proof pressure [MPa]	2.2			
Ambient and fluid temperature [°C]	0 to 75			
Mounting	Horizontal (Cannot be mounted to walls or ceilings.)			
Weight [kg]	4.5/3.2	9.1/8.2	15.0/13.2	20.9/20.4
Material	VBAT□□A□1	Carbon steel SA-414 (Plug for inspection port is made of carbon steel.)		
	VBAT□□S□1	Stainless steel SA-240 316 (Plug for inspection port is made of stainless steel.)		
Paint	VBAT□□A□1	Outside: Silver gray, Inside: Phosphate coated treatment		
Surface treatment	VBAT□□S□1	Outside: Acid cleaning ^(Note)		
Documents included	• Manufacturer's certificate of compliance • Operation manual			
Included parts	• Safety valve • Accessory kit			

(Note) There may be scratches, rubbing, stains, or discoloration on the surface of the product which do not affect its function or performance. The external appearance of the welded portion may also vary, but this does not affect the performance of the product.

Options/Accessory Numbers

<VBAT□□A□1-□□-X105 (Carbon steel)>

Model	VBAT05AN1-X105	VBAT10AN1-X105	VBAT20AN1-X105	VBAT38AN1-X105	VBAT05A1-X105	VBAT10A1-X105	VBAT20A1-X105	VBAT38A1-X105
Thread type	NPT				Rc			
Accessory kit	VBAT5A-Y-3N	VBAT10A-Y-3N	VBAT20A-Y-3N		VBAT5A-Y-3	VBAT10A-Y-3	VBAT20A-Y-3	
Safety valve	VBAT-E1N				VBAT-E1			
Drain valve (When selecting an option)	VBAT-V1N				VBAT-V1			

<VBAT□□S□1-□□-X105 (Stainless steel)>

Model	VBAT05SN1-X105	VBAT10SN1-X105	VBAT20SN1-X105	VBAT38SN1-X105	VBAT05S1-X105	VBAT10S1-X105	VBAT20S1-X105	VBAT38S1-X105
Thread type	NPT				Rc			
Accessory kit	VBAT5S-Y-4N	VBAT10S-Y-4N	VBAT20S-Y-4N		VBAT5S-Y-4	VBAT10S-Y-4	VBAT20S-Y-4	
Safety valve	VBAT-E1N				VBAT-E1			
Drain valve (When selecting an option)	VBAT-V1N				VBAT-V1			

The accessory kit is a set of nos. ① to ④.

No.	Description	Model		
		VBAT5A-Y-3N VBAT5S-Y-4N	VBAT10A-Y-3N VBAT10S-Y-4N	VBAT20A-Y-3N VBAT20S-Y-4N
				Quantity
①	O-ring	1	1 (VBA1□A) 1 (VBA2□A)	1
②	Hexagon socket head taper screwed plug (For drain port)	1	1	1
③	Hexagon socket head cap screw	4	4 (VBA1□A) 4 (VBA2□A)	4
④	Anchor bolt/nut	—	—	4



Keep the manufacturer's certificate of compliance in a safe place.

Drain valve: VBAT-V1N

* When thread type is NPT.

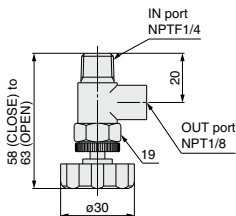

Body material: Brass

Dimensions

VBAT05AN1-E□-X105/VBAT05A1-E□-X105
VBAT05SN1-E□-X105/VBAT05S1-E□-X105

Connected to VBA10A, 11A

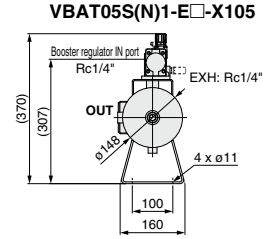
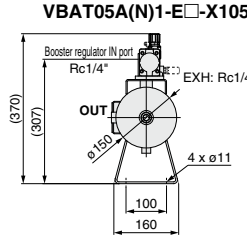
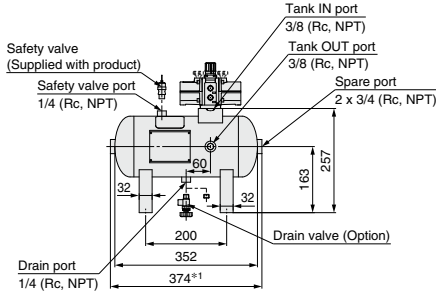

- * Order the booster regulator VBA separately.
- * The plug in the spare port has been firmly secured with adhesive. When removing the plug to use the port, be careful so as not to damage the plug.
- *1 The length may be longer than the specification if the plugs mounted on the tank are not tightly fitted to the ends.

VBAT10AN1-E□-X105/VBAT10A1-E□-X105
VBAT10SN1-E□-X105/VBAT10S1-E□-X105

Connected to VBA10A, 11A

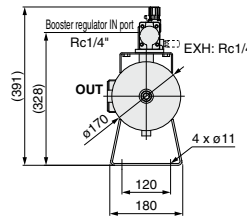
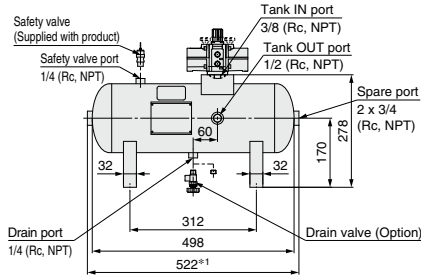

Connected to VBA20A

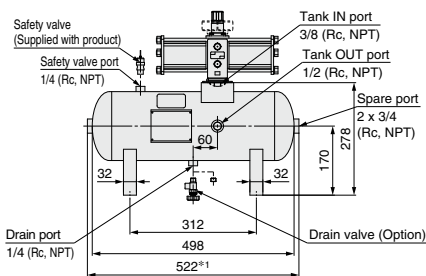

Connected to VBA22A

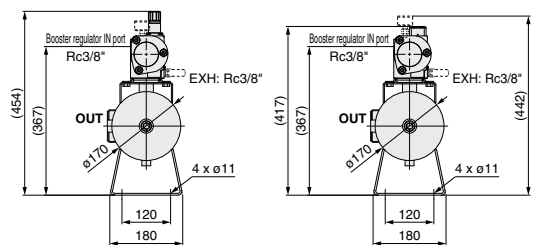

- * Order the booster regulator VBA separately.
- * The plug in the spare port has been firmly secured with adhesive. When removing the plug to use the port, be careful so as not to damage the plug.
- *1 The length may be longer than the specification if the plugs mounted on the tank are not tightly fitted to the ends.

ARJ
AR425 to 935
ARX
AMR
ARM
ARP
IR□-A
IR
IRV
VEX
SRH
SRP
SRF
ITV
IC
ITVH
ITVX
PVQ
VY1
VBA
VBAT
AP100

VBAT Series

Dimensions

VBAT20AN1-E□-X105/VBAT20A1-E□-X105
VBAT20SN1-E□-X105/VBAT20S1-E□-X105

Connected to VBA20A, 40A, 43A

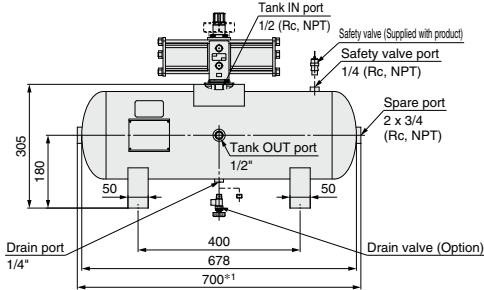

- * Order the booster regulator VBA separately.
- * The plug in the spare port has been firmly secured with adhesive. When removing the plug to use the port, be careful so as not to damage the plug.
- *1 The length may be longer than the specification if the plugs mounted on the tank are not tightly fitted to the ends.

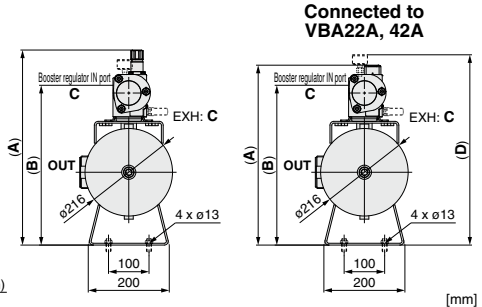

Booster regulator model	A	B	C	D*1
VBA20A	481	394	Rc3/8	—
VBA40A	520	429.8	Rc1/2	—
VBA22A	444	394	Rc3/8	469
VBA42A	477	429.8	Rc1/2	493
VBA43A	526	429.8	Rc1/2	—

*1 When option G (pressure gauge) is selected

VBAT38AN1-E□-X105/VBAT38A1-E□-X105
VBAT38SN1-E□-X105/VBAT38S1-E□-X105

Connected to VBA20A, 40A, 43A

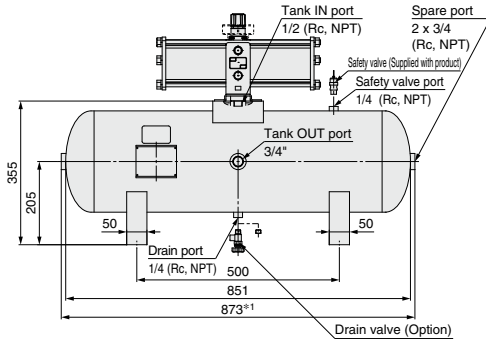

- * Order the booster regulator VBA separately.
- * The plug in the spare port has been firmly secured with adhesive. When removing the plug to use the port, be careful so as not to damage the plug.
- *1 The length may be longer than the specification if the plugs mounted on the tank are not tightly fitted to the ends.

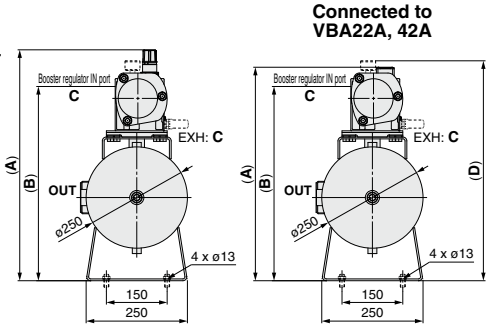

Booster regulator model	A	B	C	D*1
VBA20A	531	444	Rc3/8	—
VBA40A	570	479.8	Rc1/2	—
VBA22A	494	444	Rc3/8	519
VBA42A	527	479.8	Rc1/2	543
VBA43A	576	479.8	Rc1/2	—

*1 When option G (pressure gauge) is selected

The booster regulator is not subject to ASME standards.

Chinese Pressure Vessel Regulations Compliant Product

Specifications

Model		VBAT05□1-U-X104	VBAT10□1-U-X104	VBAT20□1-T-X104	VBAT38□1-T-X104
Fluid					
Compressed air					
Tank capacity (L)	VBAT□A1-□-X104	5	10	22	38
	VBAT□S1-□-X104				
Max. operating pressure (MPa)		1.5		1.0	
IN port size		3/8		1/2	
OUT port size		3/8	1/2	1/2	3/4
Proof pressure (MPa)	VBAT□A1-□-X104	2.39		2.05	
	VBAT□S1-□-X104	2.40		1.58	
Ambient and fluid temperature (°C)		0 to 75			
Installation					
Horizontal (Floor mounting)					
Weight (kg)	VBAT□A1-□-X104	6.6	11.5	14	26
	VBAT□S1-□-X104	4.6	8.5	13.9	19.6
Material					
Carbon steel (Equivalent to SS400)					
Stainless steel (Equivalent to stainless steel 304)					
Paint					
Outside: Silver gray, Inside: Phosphate coated treatment					
—					
Surface treatment					
—					
Outside: Acid cleaning, Sandblasting Inside: Acid cleaning					
Included parts		<ul style="list-style-type: none"> • Safety valve/Pressure gauge set: Safety valve, Pressure gauge, Piping for tank connections • Accessories: O-ring, Drain port plug, VBA connection screw (4 pcs.), Anchor bolt/nut (4 pcs.: only 22 L/38 L) • Product certificates: Product certificate, Product safety performance supervision test certificate, Product weight certificate, Manufacture license, Product manual, Completion drawing • Operation manual 			

Note) There may be scratches, rubbing, stains, or discoloration on the surface of the product which do not affect its function or performance. The external appearance of the welded portion may also vary, but this does not affect the performance of the product.

 The product certificates are required when exporting to and using the product in China. Keep them in a safe place.

Accessories/Part No.

<For VBAT□A1-□-X104(Carbon Steel)>

Model	VBAT05A1-U-X104	VBAT10A1-U-X104	VBAT20A1-T-X104	VBAT38A1-T-X104
Accessory kit	VBAT5A-Y-3	VBAT10A-Y-3	VBAT20A-Y-3	
Drain valve (Order it separately.)	VBAT-V1			

<For VBAT□S1-□-X104(Stainless Steel)>

Model	VBAT05S1-U-X104	VBAT10S1-U-X104	VBAT20S1-T-X104	VBAT38S1-T-X104
Accessory kit	VBAT5S-Y-4	VBAT10S-Y-4	VBAT20S-Y-4	
Drain valve (Order it separately.)	VBAT-V1			

The Accessory Kit is a Set of Nos. ① to ④.

No.	Description	Model	VBAT5A-Y-3	VBAT10A-Y-3	VBAT20A-Y-3
			VBAT5S-Y-4	VBAT10S-Y-4	VBAT20S-Y-4
			Quantity		
①	O-ring		1	1 (VBA1□A) 1 (VBA2□A)	1
②	Hexagon socket head taper screwed plug (for drain port)		1	1	1
③	Hexagon socket head cap screw		4	4 (VBA1□A) 4 (VBA2□A)	4
④	Anchor bolt/nut		—	4	4

ARM

AR425 to 935

ARX

AMR

ARM

ARP

IR□-A

IR

IRV

VEV

SRH

SRP

SRF

ITV

IC

ITVH

ITVX

PVQ

VY1

VBA
VBAT

AP100

VBAT-X104

Dimensions

VBAT05A1-U-X104 Material: Carbon steel

Safety valve/Pressure gauge set
(Supplied with product)

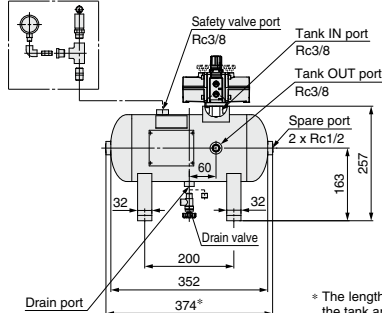

* The length may be longer than the specification if the plugs mounted on the tank are not fit to the end.
** The plug in the spare port has been firmly secured with adhesive. When removing the plug to use the port, be careful so as not to damage the plug.

VBAT10A1-U-X104 Material: Carbon steel

Safety valve/Pressure gauge set
(Supplied with product)

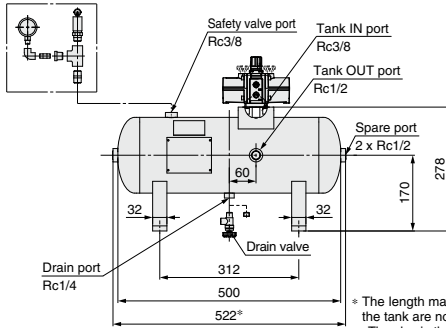

* The length may be longer than the specification if the plugs mounted on the tank are not fit to the end.
** The plug in the spare port has been firmly secured with adhesive. When removing the plug to use the port, be careful so as not to damage the plug.

Safety valve/
Pressure gauge set
(Supplied with product)

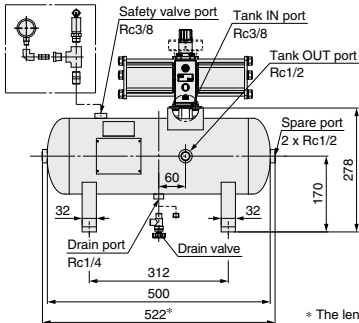

Connected to VBA20A

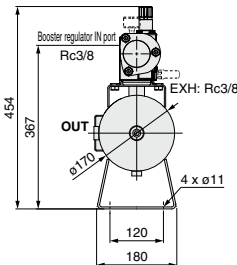

Connected to VBA22A

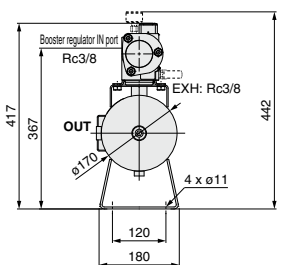

* The length may be longer than the specification if the plugs mounted on the tank are not fit to the end.
** The plug in the spare port has been firmly secured with adhesive. When removing the plug to use the port, be careful so as not to damage the plug.

Dimensions

VBAT20A1-T-X104 **Material: Carbon steel**

Safety valve/Pressure gauge set
(Supplied with product)

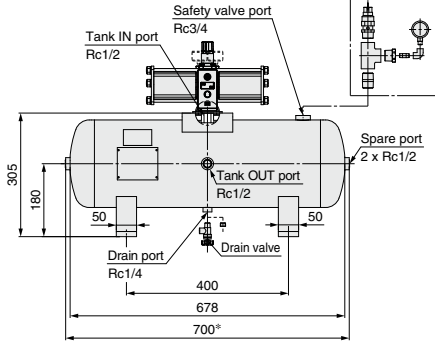

* The length may be longer than the specification if the plugs mounted on the tank are not fit to the end.
 ** The plug in the spare port has been firmly secured with adhesive. When removing the plug to use the port, be careful so as not to damage the plug.

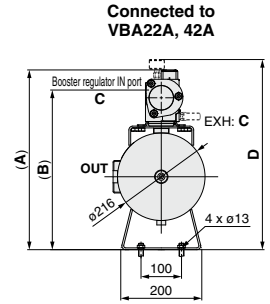
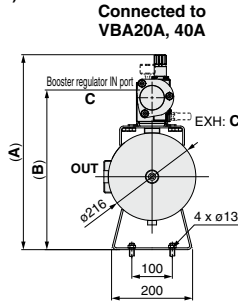

Booster regulator model	A	B	C	D
VBA20A	481	394	Rc3/8	—
VBA40A	520	429.8	Rc1/2	—
VBA22A	444	394	Rc3/8	469
VBA42A	477	429.8	Rc1/2	493

VBAT38A1-T-X104 **Material: Carbon steel**

Safety valve/Pressure gauge set
(Supplied with product)

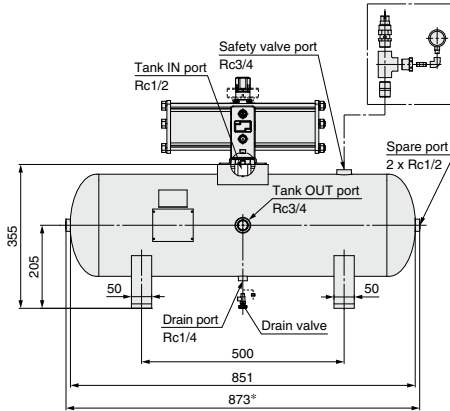

* The length may be longer than the specification if the plugs mounted on the tank are not fit to the end.
 ** The plug in the spare port has been firmly secured with adhesive. When removing the plug to use the port, be careful so as not to damage the plug.

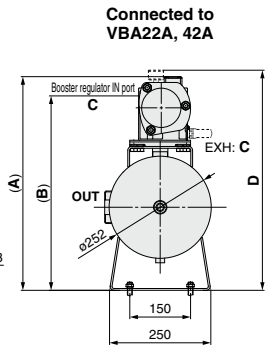
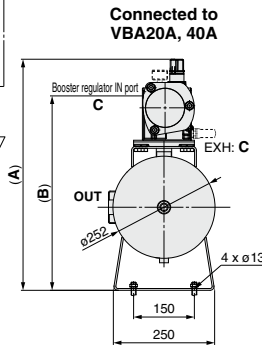

Booster regulator model	A	B	C	D
VBA20A	531	444	Rc3/8	—
VBA40A	570	479.8	Rc1/2	—
VBA22A	494	444	Rc3/8	519
VBA42A	527	479.8	Rc1/2	543

ARJ

AR425
to 935

ARX

AMR

ARM

ARP

IR□-A

IR

IRV

VEX

SRH

SRP

SRF

ITV

IC

ITVH

ITVX

PVQ

VY1

VBA

VBAT

AP100

VBAT-X104

Dimensions

VBAT05S1-U-X104 Material: Stainless steel

Safety valve/Pressure gauge set
(Supplied with product)

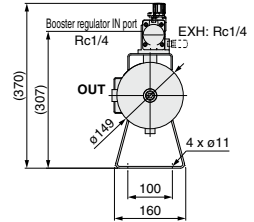
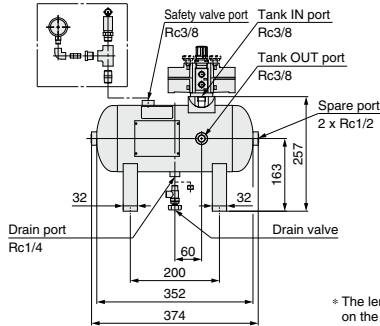

- * The length may be longer than the specification if the plugs mounted on the tank are not tightly fitted to the ends.
- ** The plug in the spare port has been firmly secured with adhesive. When removing the plug to use the port, be careful so as not to damage the plug.

VBAT10S1-U-X104 Material: Stainless steel

Safety valve/Pressure gauge set
(Supplied with product)

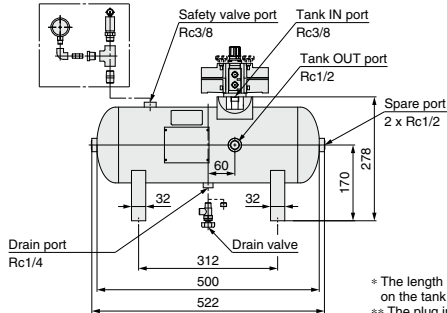

Connected to VBA10A

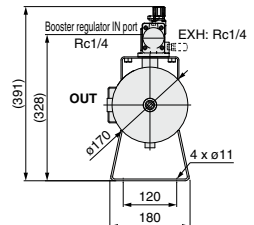

- * The length may be longer than the specification if the plugs mounted on the tank are not tightly fitted to the ends.
- ** The plug in the spare port has been firmly secured with adhesive. When removing the plug to use the port, be careful so as not to damage the plug.

Safety valve/Pressure gauge set
(Supplied with product)

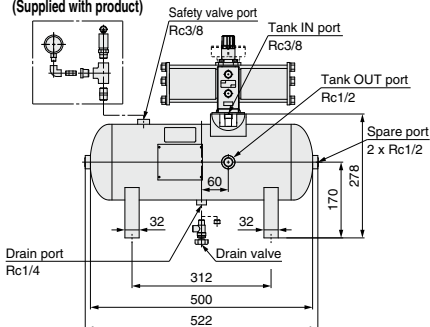

Connected to VBA20A

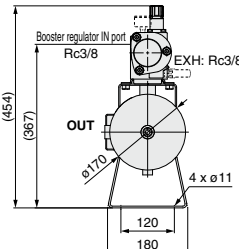

Connected to VBA22A

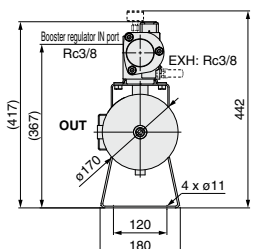

- * The length may be longer than the specification if the plugs mounted on the tank are not tightly fitted to the ends.
- ** The plug in the spare port has been firmly secured with adhesive. When removing the plug to use the port, be careful so as not to damage the plug.

Dimensions

VBAT20S1-T-X104 Material: Stainless steel

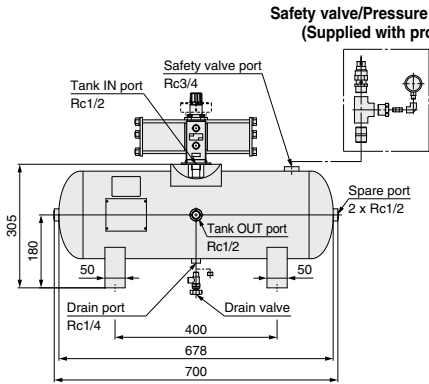

Safety valve/Pressure gauge set
(Supplied with product)

Connected to
VBA20A, 40A

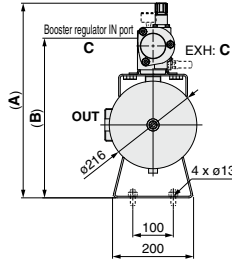

Connected to
VBA22A, 42A

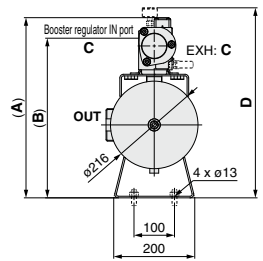

Booster regulator model	A	B	C	D
VBA20A	481	394	Rc3/8	—
VBA40A	520	429.8	Rc1/2	—
VBA22A	444	394	Rc3/8	469
VBA42A	477	429.8	Rc1/2	493

- * The length may be longer than the specification if the plugs mounted on the tank are not tightly fitted to the ends.
- ** The plug in the spare port has been firmly secured with adhesive. When removing the plug to use the port, be careful so as not to damage the plug.

VBAT38S1-T-X104 Material: Stainless steel

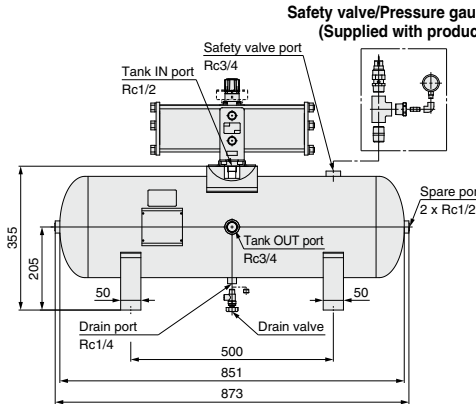

Safety valve/Pressure gauge set
(Supplied with product)

Connected to
VBA20A, 40A

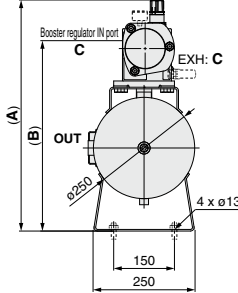

Connected to
VBA22A, 42A

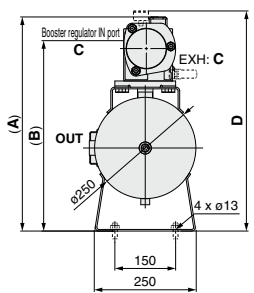

Booster regulator model	A	B	C	D
VBA20A	531	444	Rc3/8	—
VBA40A	570	479.8	Rc1/2	—
VBA22A	494	444	Rc3/8	519
VBA42A	527	479.8	Rc1/2	543

- * The length may be longer than the specification if the plugs mounted on the tank are not tightly fitted to the ends.
- ** The plug in the spare port has been firmly secured with adhesive. When removing the plug to use the port, be careful so as not to damage the plug.

ARJ
AR425 to 935
ARX
AMR
ARM
ARP
IR□-A
IR
IRV
VEX
SRH
SRP
SRF
ITV
IC
ITVH
ITVX
PVQ
VY1
VBA
VBAT
AP100

Specific Product Precautions

Be sure to read this before handling the products.
Refer to back page 50 for Safety Instructions.



Design

Warning

1. Operating pressure

- Operate this product below the maximum operating pressure. If it is necessary, take appropriate safety measures to ensure that the maximum operating pressure is not exceeded.

● When the tank alone is used

Use a pressure switch or a safety valve to ensure that the maximum operating pressure is not exceeded.

2. Connection

- The air tank (carbon steel) port portion (including the seal surface) and the mounting screws are untreated. The generation of rust on these untreated parts, as well as the inner surface of the tank, may occur to a degree that will not interfere with the performance of the product. If the generation of rust must be avoided, please consider selecting the stainless steel specification.
- Be sure to air blow (flush) the inside of the air tank before use. Dust or oil may flow out to the outlet side. After conducting air blow (flushing), install an air filter (AF series), etc., on the OUT port of the air tank.
- A VBA booster regulator can be connected directly with the tank accessories as indicated combinations below.

Air Tank Compatibility Chart

Air tank \ Booster regulator	VBA10A/11A	VBA20A/22A	VBA40A/42A	VBA43A
VBAT05A(1)	●	—	—	—
VBAT05S(1)	●	●	—	—
VBAT10A(1)	—	●	●	●
VBAT10S(1)	—	—	—	—
VBAT20A(1)	—	●	●	—
VBAT20S(1)	—	—	—	—
VBAT38A(1)	—	●	●	△*
VBAT38S(1)	—	—	—	—

* Excludes the Chinese pressure vessel regulations compliant product (X104)

Selection

Caution

- Consider the operating conditions and operate this product within the specification range.
- When using the air tank with a booster regulator, refer to "Sizing" on page 1014 or SMC Pneumatic System Energy Saving Program.

Mounting

Caution

1. Accessories

- Refer to the operation manual regarding combining booster regulators with older model air tanks.
- The accessories are secured by bands to the feet of the air tank. Once removed, make sure not to lose them.

2. Installation

- Install the tank away from people. It is dangerous if the accumulated air inside the tank were to seep out.
- Do not mount the air tank on a moving part or a place with vibration. If it must be used in such an area due to unavoidable circumstances, please contact SMC beforehand.
- When connecting a booster regulator with the tank, refer to the operation manual first, which is provided with the air tank before assembling.
- To mount the air tank on a floor surface, use the four holes to secure the tank with bolts or anchor bolts.
- Put measures into place to prevent load and vibrations from the piping from being applied to the air tank.

Maintenance

Warning

1. Inspection

- The use of pressure vessels could lead to an unexpected accident due to external damage or internal corrosion caused by drainage. Therefore, make sure to check periodically for external damage, or the extent of internal corrosion through the port hole. An ultrasonic thickness indicator may also be used to check for any reduction in material thickness.

2. Draining

- If this product is used with a large amount of drainage, the drainage could flow out, leading to equipment malfunction or corrosion inside the tank. Therefore, drain the system once a day.