

Cylinder with Lock

CNA2 Series

ø40, ø50, ø63, ø80, ø100

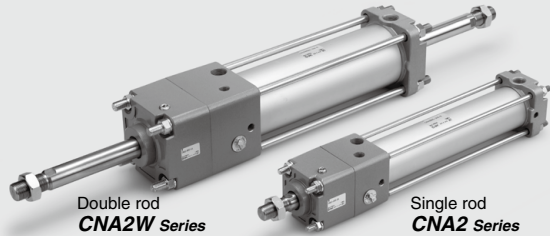

- Suitable for intermediate stops, emergency stops and drop prevention
- 2-color indicator auto switches can be mounted.
 - Small solid state type (D-M9□ series)
 - Magnetic field resistant solid state type (D-P3DWA□ series)

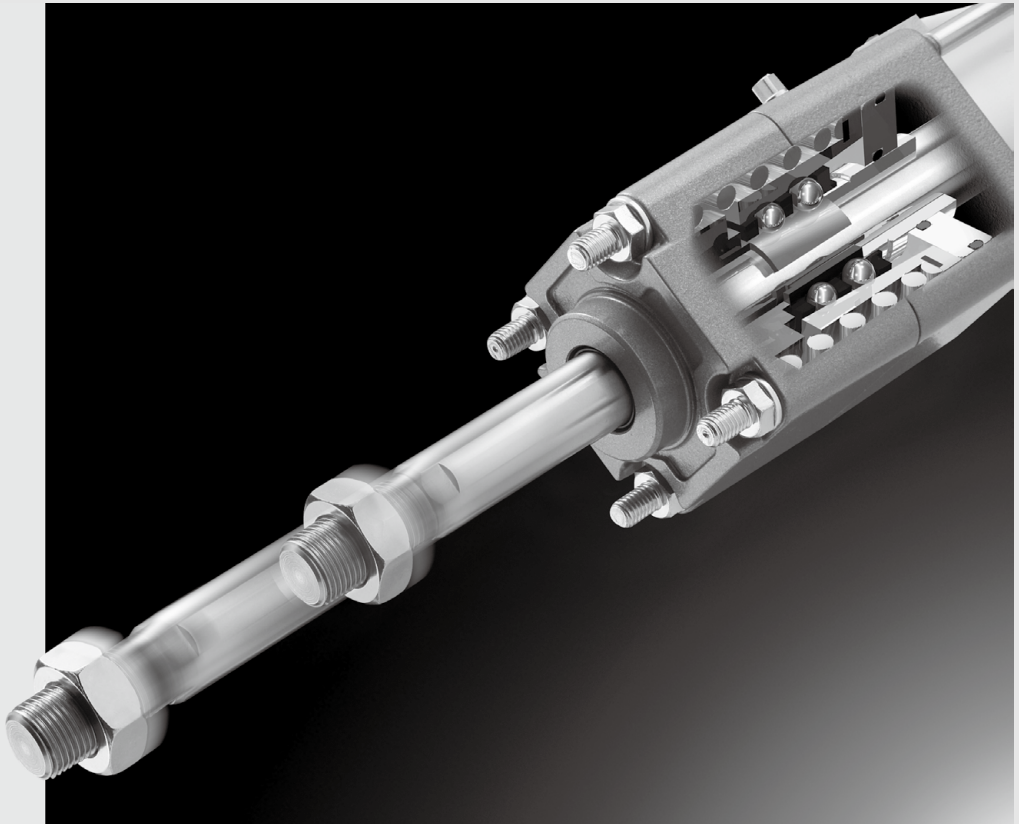

Suitable for intermediate stops,

Simple construction

A force magnifying mechanism is employed based on the wedge effect of the taper ring and steel balls.

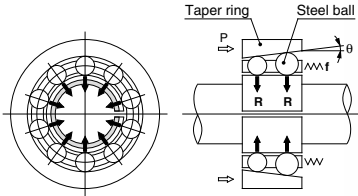

High locking efficiency

Greater locking efficiency as well as stable locking and unlocking operation has been achieved by arranging a large number of steel ball bearings in circular rows. (Unlocking pressure of 0.25 MPa 0.05 MPa lower than current SMC products) In addition, both alignability and stable locking force with respect to piston rod eccentricity are obtained by allowing the taper ring to float.

High reliability and stable holding force

Outstanding durability and stable holding force are maintained by the use of a brake shoe having superior wear resistance, which has also been substantially lengthened. (Double the current SMC product)

Compact lock unit saves space.

The lock unit is extremely compact, without a large overhang.

Cylinder with Lock

CNA2 Series

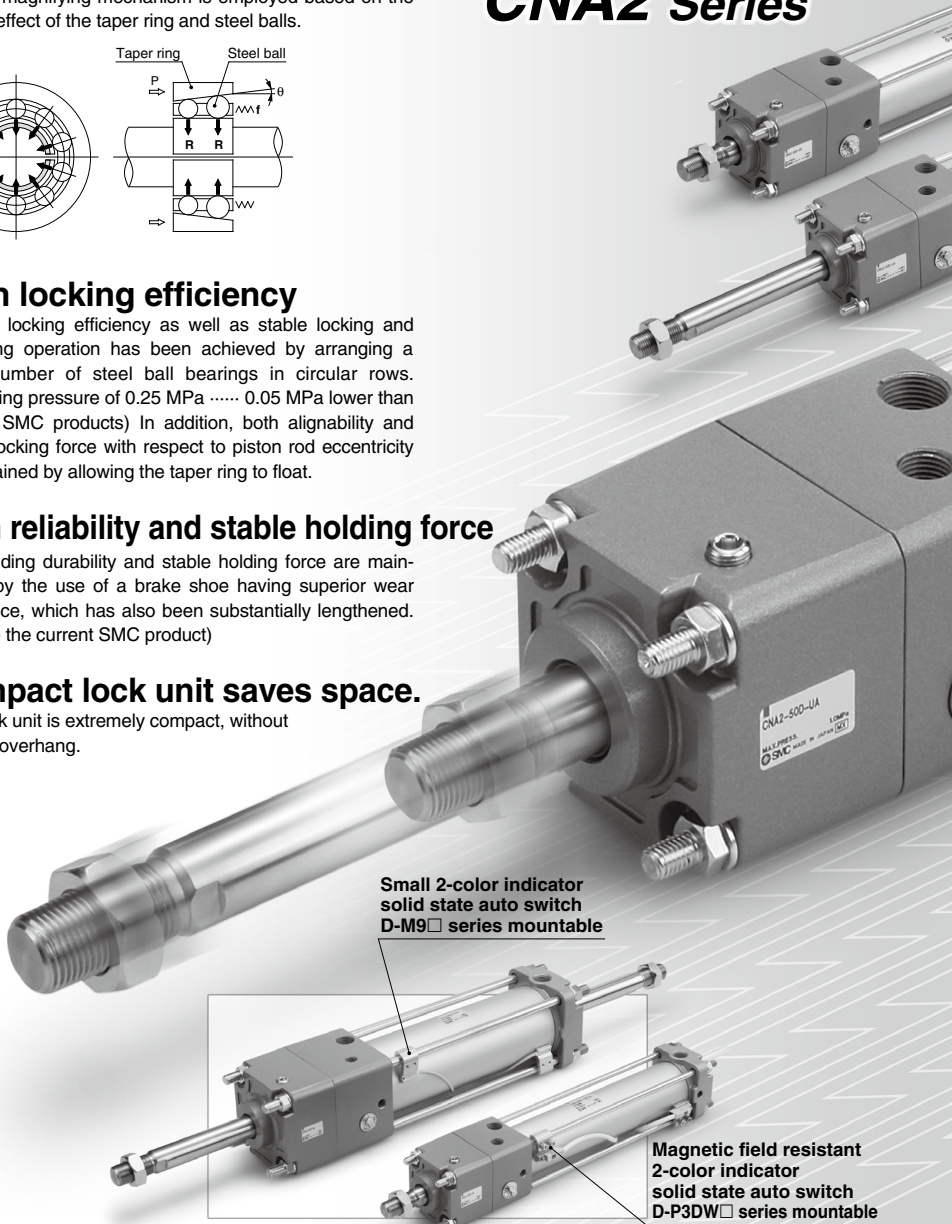

Small 2-color indicator
solid state auto switch
D-M9□ series mountable

Magnetic field resistant
2-color indicator
solid state auto switch
D-P3DW□ series mountable

emergency stops and drop prevention



● **Can be locked in both directions.**

An equal holding force can be obtained on either reciprocating stroke of the cylinder.

● **Max. piston speed: 1000 mm/s**

It can be used at 50 to 1000 mm/s provided that it is within the allowable kinetic energy range.

● **Manual override for unlocking**

Even if the air supply is blocked or exhausted, lock release is possible. The fail safe mechanism locks again when the manual override is released.

● **Design minimizes the influences of unlocking air quality.**

A construction which is strong against moisture and drainage in the compressed air has been realized by separating the locking mechanism and the unlocking chamber.

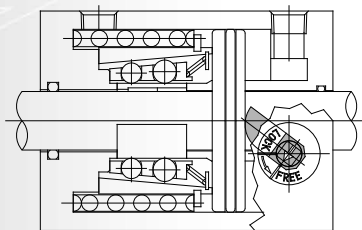

■ **Series Variations**

Series	Action	Type	Standard variations		Locking type	Bore size (mm)	Max. stroke (mm)	
			Auto switch built-in magnet	With bellows			Single rod	Double rod
Cylinder with lock CNA2 series	Double acting	Single rod CNA2 series	●	●	●	40	1800	1000
			●	●	●	50		1200
		Double rod CNA2W series	●	●	●	63	1500	1800
			●	●	●	80		1500
			●	●	●	100		

■ **Applicable Auto Switches**

Reed auto switch	Band mounting	D-B54/B64, D-B59W, D-A3□ D-A44
	Tie-rod mounting	D-A9□, D-A54/A64, D-A59W D-A3□C, D-A44C
Solid state auto switch	Band mounting	D-G5□/K59, D-G5NTL D-G5□W/K59W, D-G5BAL D-G59F, D-G39/K39
	Tie-rod mounting	D-M9□, D-M9□W, D-M9□AL D-J51, D-F5NTL, D-F59F D-G39C/K39C, D-P3DW

CNA2 Series Model Selection

Precautions on Model Selection

Warning

- In order that the originally selected maximum speed is not exceeded, be certain to use a speed controller to adjust the total movement distance of the load so that movement takes place in no less than the applicable movement time.
The movement time is the time that is necessary for the load to travel the total movement distance from the start without any intermediate stops.
- In cases where the cylinder stroke and the movement distance of the load are different (double speed mechanism, etc.), use the movement distance of the load for selection purposes.

Example)

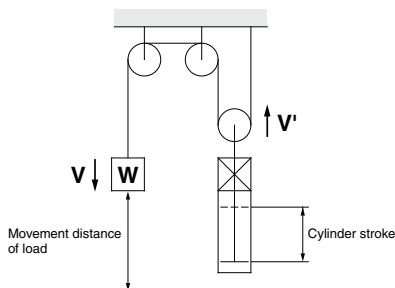

- The following selection example and procedures are based on use at the intermediate stop (including emergency stops during the operation). However, when the cylinder is in the locked state such as drop prevention, kinetic energy does not act upon it. Under these conditions, use the load weight at the maximum speed (V) of 100 mm/s shown in Chart (5) to (7) on page 761 depending on the operating pressure and select models.

Selection Example

- Load mass: $m = 50 \text{ kg}$
- Movement distance: $st = 500 \text{ mm}$
- Movement time: $t = 2 \text{ s}$
- Load condition: Vertical downward = Load in direction of rod extension
- Operating pressure: $P = 0.4 \text{ MPa}$

Step (1): From Chart (1) find the maximum movement speed of the load.

$$\therefore \text{Maximum speed } V \approx 350 \text{ mm/s}$$

Step (2): Select Chart (6) based upon the load conditions and operating pressure, and then from the intersection of the maximum speed $V = 350 \text{ mm/s}$ found in Step (1), and the load mass $m = 50 \text{ kg}$.

$\therefore \phi 63 \rightarrow$ Decided the bore size CNA2□63 or more.

Step (1) Find the maximum load speed V .

Find the maximum load speed: V (mm/s) from the load movement time: t (s) and the movement distance: st (mm).

Chart (1)

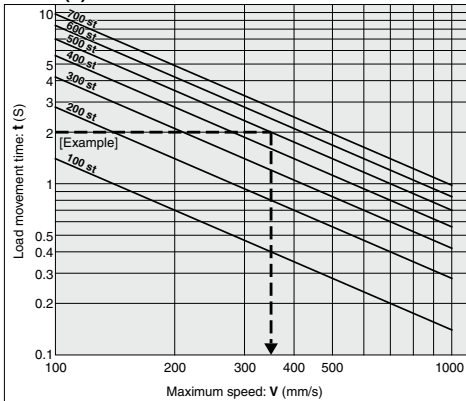

Step (2) Find the bore size.

Select a chart based upon the load condition and operating pressure, and then find the point of intersection for the maximum speed found in Step (1) and the load mass. Select the bore size on the line above the point of intersection.

Load Condition

Operating Pressure

Load in the direction at the right angle to rod
(* Being held by a guide)

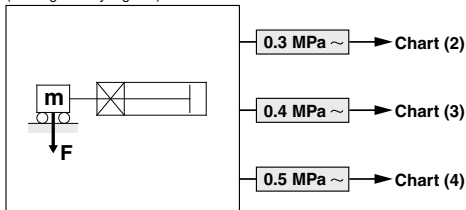

Load in the direction of rod extension
Load in the direction of rod retraction

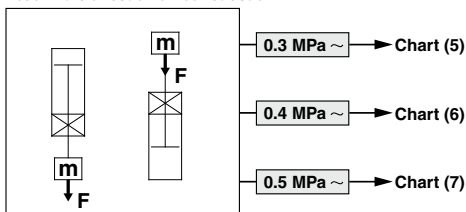

Selection Chart

Chart (2)

$0.3 \text{ MPa} \leq P < 0.4 \text{ MPa}$

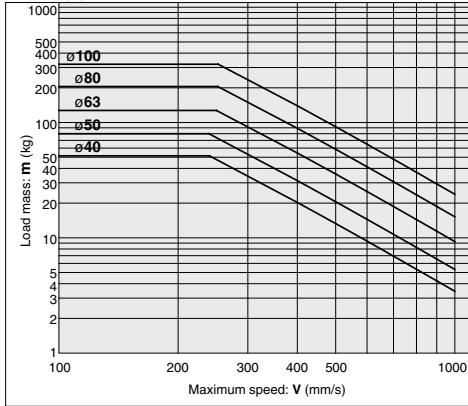

Chart (5)

$0.3 \text{ MPa} \leq P < 0.4 \text{ MPa}$

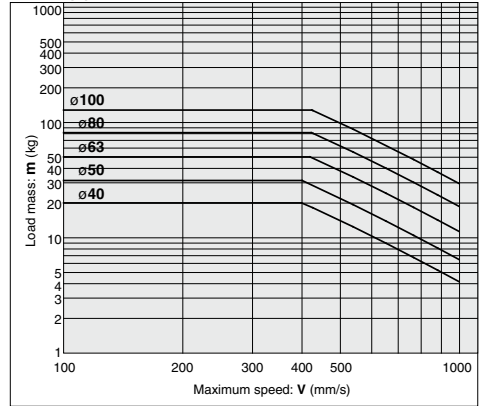

Chart (3)

$0.4 \text{ MPa} \leq P < 0.5 \text{ MPa}$

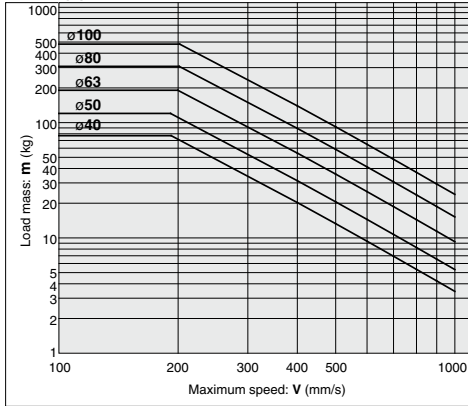

Chart (6)

$0.4 \text{ MPa} \leq P < 0.5 \text{ MPa}$

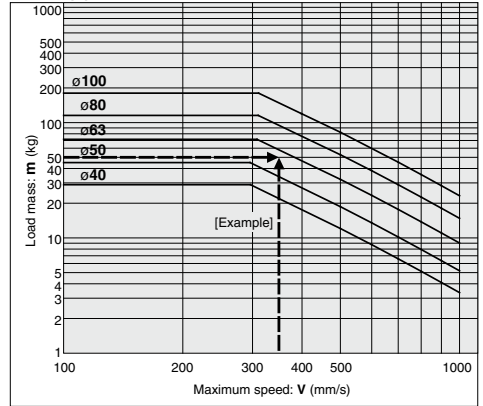

Chart (4)

$0.5 \text{ MPa} \leq P$

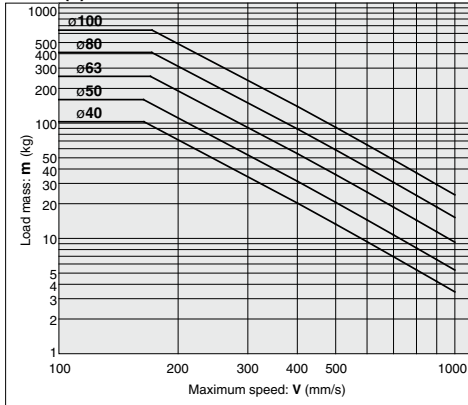
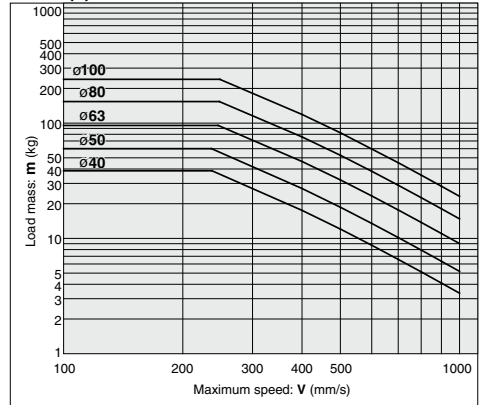

Chart (7)

$0.5 \text{ MPa} \leq P$



Cylinder with Lock

Double Acting, Single Rod

CNA2 Series

ø40, ø50, ø63, ø80, ø100

How to Order

CNA2 L 50 100 JN D

With auto switch **CDNA2 L 50 100 JN D M9BW**

With auto switch (Built-in magnet)

Mounting

B	Basic
L	Axial foot
F	Rod flange
G	Head flange
C	Single clevis
D	Double clevis
T	Center trunnion

Cylinder tube material

Nil	Aluminum tube
F*	Steel tube

* Auto switches are not available with steel tube.

Bore size

40	40 mm
50	50 mm
63	63 mm
80	80 mm
100	100 mm

Thread type

Nil	Rc
TN	NPT
TF	G

Cylinder stroke (mm)

Refer to page 763 for standard stroke.

Locking direction

D	Both directions
---	-----------------

Auto switch

Nil	Without auto switch
-----	---------------------

* For applicable auto switches, refer to the below table.

Made to Order
Refer to page for 763 details.

Number of auto switches

Nil	2 pcs.
S	1 pc.
n	"n" pcs.

With bellows/cushion

Bellows	Nil	None
	J	Nylon tarpaulin
Cushion	K	Heat resistant tarpaulin
	Nil	With double-side cushion
Cushion	N	Without cushion

* When the symbols are two or more, indicate them alphabetically.

Built-in Magnet Cylinder Model

If a built-in magnet cylinder without an auto switch is required, there is no need to enter the symbol for the auto switch.
(Example) CDNA2L40-100-D

Applicable Auto Switches/Refer to pages 1341 to 1435 for further information on auto switches.

Type	Special function	Electrical entry	Indicator light	Wiring (Output)	Load voltage		Auto switch model		Lead wire length (m)					Pre-wired connector	Applicable load	
					DC	AC	Tie-rod mounting	Band mounting	0.5 (Nil)	1 (M)	3 (L)	5 (Z)				
Solid state auto switch	—	Grommet	No	3-wire (NPN)	24 V	5 V, 12 V	—	M9N	●	●	●	○	○	IC circuit	—	
				3-wire (PNP)				G59	●	●	●	○	○			
				2-wire	M9P	●	●	●	○	○						
		Terminal conduit		3-wire (NPN)	12 V	—	G5P	●	●	●	○	○				
				2-wire			M9B	●	●	●	○	○				
				3-wire (NPN)	5 V, 12 V	—	K59	●	●	●	○	○				
	3-wire (PNP)	G39C	●	●			●	○	○							
	Diagnostic indication (2-color indicator)	Grommet	Yes	2-wire	24 V	12 V	—	K39C	●	●	●	○	○	IC circuit	Relay, PLC	
				3-wire (NPN)				M9NW	●	●	●	○	○			
				3-wire (PNP)	G59W	●	●	●	○	○						
		Terminal conduit		2-wire	24 V	12 V	—	M9PW	●	●	●	○	○			
				3-wire (NPN)				G5PW	●	●	●	○	○			
3-wire (PNP)				M9BW	●	●	●	○	○							
Water resistant (2-color indicator)	Grommet	No	2-wire	24 V	12 V	—	K59W	●	●	●	○	○	—	—		
			3-wire (NPN)				M9A*1	—	○	○	○	○				
			3-wire (PNP)	M9PA*1	—	○	○	●	○	○						
	Terminal conduit		2-wire	24 V	12 V	—	M9BA*1	—	○	○	●	○			○	
			3-wire (NPN)				G5BA*1	—	○	○	●	○			○	
			3-wire (PNP)	F59F	●	●	●	○	○							
With diagnostic output (2-color indicator) Magnetic field resistant (2-color indicator)	Grommet	Yes	4-wire (NPN)	24 V	5 V, 12 V	—	P3DWA	●	●	●	○	○	IC circuit	—		
			2-wire (Non-polar)				A96	●	●	●	○	○				
			Terminal conduit	3-wire (NPN equivalent)	24 V	12 V	—	A93	●	●	●	○			○	
	100 V			A90				●	●	●	○	○				
	100 V or less			A54	●	●	●	○	○							
	Diagnostic indication (2-color indicator)		Grommet	No	2-wire	24 V	12 V	—	B54	●	●	●			○	○
200 V or less		A64							●	●	●	○	○			
100 V, 200 V		A33C							A33	—	—	—	—	—	PLC	
DIN terminal		A34C	A34						—	—	—	—				
		A44C	A44						—	—	—	—				
		Grommet	A59W						B59W	●	●	●	○	○		

*1 Water resistant type auto switches can be mounted on the above models, but in such case SMC cannot guarantee water resistance.

Consult with SMC regarding water resistant types with the above model numbers.

* Lead wire length symbols: 0.5 m Nil (Example) M9NW * Solid state auto switches marked with "○" are produced upon receipt of order.

1 m M (Example) M9NW
3 m L (Example) M9NW
5 m Z (Example) M9NW

* Since there are other applicable auto switches than listed, refer to page 788 for details.

* For details about auto switches with pre-wired connector, refer to pages 1410 and 1411.

* The D-A9□/M9□□□/P3DWA□ auto switches are shipped together, (but not assembled). (Only auto switch mounting brackets are assembled at the time of shipment for the D-A9□/M9□□□)

Cylinder with Lock **CNA2 Series**



Symbol

Air cushion

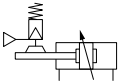

Made to Order

[Click here for details](#)

Symbol	Specifications
-XA□	Change of rod end shape
-XC3	Special port location
-XC4	With heavy duty scraper
-XC11	Dual stroke cylinder/Single rod
-XC14	Change of trunnion bracket mounting position
-XC15	Change of tie-rod length
-XC35	With coil scraper

Refer to pages 783 to 788 for cylinders with auto switches.

- Minimum stroke for auto switch mounting
- Auto switch proper mounting position (detection at stroke end) and mounting height
- Operating range
- Auto switch mounting bracket/Part no.

Minimum mountable stroke for a cylinder with auto switch(es)

⚠ Caution

- Each switch and mounting type of cylinder has different minimum mountable stroke. Be careful especially of the center trunnion type.

(Refer to pages 785 and 786 for details.)

Specifications

Bore size (mm)	40	50	63	80	100
Lubrication	Not required (Non-lube)				
Action	Double acting				
Proof pressure	1.5 MPa				
Max. operating pressure	1.0 MPa				
Min. operating pressure	0.08 MPa				
Piston speed	50 to 1000 mm/s *				
Ambient and fluid temperature	Without auto switch: -10 to 70°C (No freezing) With auto switch: -10 to 60°C (No freezing)				
Cushion	Air cushion				
Stroke length tolerance	Up to 250: $^{+1.0}_0$, 251 to 1000: $^{+1.4}_0$, 1001 to 1500: $^{+1.8}_0$, 1501 to 1800: $^{+2.2}_0$				
Mounting	Basic, Axial foot, Rod flange, Head flange, Single clevis, Double clevis, Center trunnion				

* Load limits exist depending on the piston speed when locked, mounting direction and operating pressure.

Lock Specifications

Bore size (mm)	40	50	63	80	100
Locking action	Spring locking (Exhaust locking)				
Unlocking pressure	0.25 MPa or more				
Lock starting pressure	0.20 MPa or less				
Max. operating pressure	1.0 MPa				
Locking direction	Both directions				
Holding force (Maximum static load) N*	882	1370	2160	3430	5390

* The holding force (max. static load) shows the maximum capability and does not show the normal holding capability. So, select an appropriate cylinder while referring to page 760.

Standard Stroke

For cases with auto switches, refer to the table of minimum stroke for auto switch mounting on pages 785 and 786.

Bore size (mm)	Standard stroke (mm) ^{Note 1)}		Max.m manufacturable stroke
	Stroke range ①	Stroke range ②	
40	25, 50, 100, 125, 150, 175, 200, 250 300, 350, 400, 450, 500	Up to 1800	Up to 2600
50, 63	25, 50, 100, 125, 150, 175, 200, 250 300, 350, 400, 450, 500, 600		
80, 100	25, 50, 100, 125, 150, 175, 200, 250 300, 350, 400, 450, 500, 600, 700		

Note 1) Strokes other than listed above are produced upon receipt of order.

Spacers are not used for intermediate strokes.

Note 2) Applicable strokes should be confirmed according to the usage. For details, refer to "Air Cylinders Model Selection" in the **Web Catalog**.

Note 3) Please consult with SMC for manufacturability and the part numbers when exceeding the stroke range ②.

Note 4) The stroke range with rod boot is 20 to 1800 mm. Please consult with SMC when exceeding 1800 mm strokes.

Note 5) Using a stroke of a length which is smaller than the effective cushion length may result in reduced air cushion performance. Refer to "Technical Data 1" in the **Web Catalog** for details on the effective cushion length.

Stopping Accuracy

Lock type	Piston speed (mm/s)			
	100	300	500	1000
Spring locking	±0.3	±0.6	±1.0	±2.0

Condition: Lateral, Supply pressure P = 0.5 MPa

Load weight Upper limit of allowed value

Solenoid valve for locking mounted on the unlocking port

Maximum value of stopping position dispersion from 100 measurements



CNA2 Series

Mounting Bracket/Part No.

Bore size (mm)	40	50	63	80	100
Axial foot *	CA2-L04	CA2-L05	CA2-L06	CA2-L08	CA2-L10
Flange	CA2-F04	CA2-F05	CA2-F06	CA2-F08	CA2-F10
Single clevis	CA2-C04	CA2-C05	CA2-C06	CA2-C08	CA2-C10
Double clevis **	CA2-D04	CA2-D05	CA2-D06	CA2-D08	CA2-D10

* When ordering axial foot bracket, order 2 pieces per cylinder.

** Accessories for each mounting bracket are as follows.

Foot, Flange, Single clevis: Body mounting nuts, spring washer

Double clevis: Body mounting nuts, Spring washer, Clevis pin, Cotter pin, Flat washer, Split pin

Bellows Material

Symbol	Bellows material	Max. ambient temperature
J	Nylon tarpaulin	70°C
K	Heat resistant tarpaulin	110°C *

* Maximum ambient temperature for bellows itself

Accessories

Mounting		Basic	Axial foot	Rod flange	Head flange	Single clevis	Double clevis	Center trunnion
Standard equipment	Rod end nut	●	●	●	●	●	●	●
	Clevis pin	—	—	—	—	—	●	—
Option	Single knuckle joint	●	●	●	●	●	●	●
	Double knuckle joint (With pin)	●	●	●	●	●	●	●
	With bellows	●	●	●	●	●	●	●

* For details about part numbers and dimensions, refer to page 774. (For rod boots, refer to page 767.)

Weight

Bore size (mm)			40	50	63	80	100	
Basic weight	Basic	Aluminum tube	1.65	2.59	3.94	7.05	10.37	
		Steel tube	1.70	2.65	3.98	7.21	10.58	
	Axial foot	Aluminum tube	1.84	2.63	4.28	7.72	11.36	
		Steel tube	1.89	2.67	4.32	7.88	11.57	
	Flange	Aluminum tube	2.02	2.86	4.73	8.50	12.29	
		Steel tube	2.07	2.90	4.77	8.66	12.50	
	Single clevis	Aluminum tube	1.88	2.75	4.57	8.16	12.15	
		Steel tube	1.93	2.79	4.61	8.32	12.36	
	Double clevis	Aluminum tube	1.92	2.84	4.73	8.45	12.67	
		Steel tube	1.97	2.88	4.77	8.61	12.88	
	Center trunnion	Aluminum tube	2.10	2.94	4.83	8.75	12.77	
		Steel tube	2.20	3.04	5.03	9.04	13.16	
	Additional weight per each 50 mm of stroke	Mounting bracket	Aluminum tube	0.20	0.25	0.31	0.46	0.58
			Steel tube	0.28	0.35	0.43	0.70	0.87
Accessory bracket	Single knuckle joint		0.23	0.26	0.26	0.60	0.83	
	Double knuckle joint (With pin)		0.37	0.43	0.43	0.87	1.27	

Calculation: (Example) **CNA2L40-100-D** Basic weight 1.84 (Axial foot, ø40)
 Additional weight 0.20/50 stroke
 Cylinder stroke 100 stroke
 $1.84 + 0.20 \times 100/50 = 2.24$ kg

Construction Principle

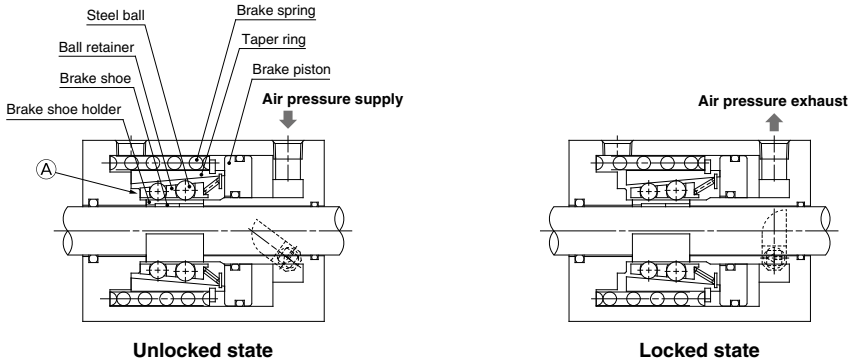

Spring locking (Exhaust locking)

The spring force which acts upon the taper ring is magnified by a wedge effect, and is conveyed to all of the numerous steel balls which are arranged in two circles. These act on the brake shoe holder and brake, which lock the piston rod by tightening against it with a large force.

Unlocking is accomplished when air pressure is supplied to the unlocking port. The brake piston and taper ring oppose the spring force, moving to the left side, and the ball retainer strikes the cover section A. The braking force is released as the steel balls are removed from the taper ring by the ball retainer.

CNA2 Series

Construction

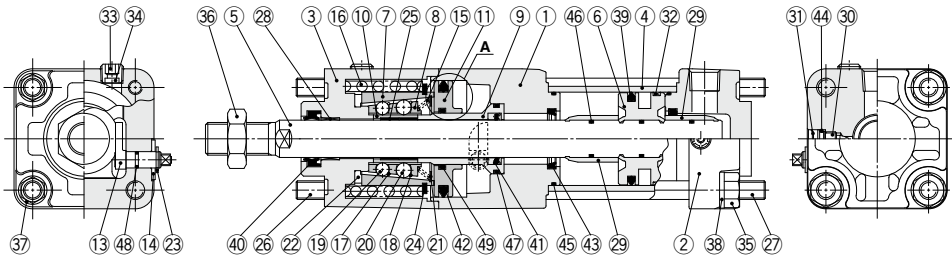

A section (Release piston bushing)

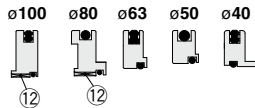

Component Parts

No.	Description	Material	Note
1	Rod cover	Aluminum alloy	Metallic painted after hard anodized
2	Head cover	Aluminum alloy	Metallic painted
3	Cover	Aluminum alloy	Metallic painted after chromated
4	Cylinder tube	Aluminum alloy	Hard anodized
5	Piston rod	Carbon steel	Hard chrome plated
6	Piston	Aluminum alloy	Chromated
7	Taper ring	Bearing steel	Heat treated
8	Ball retainer	Special resin	
9	Piston guide	Carbon steel	Zinc chromated
10	Brake shoe holder	Special steel	Heat treated
11	Release piston	Aluminum alloy	Hard anodized (ø40, ø50, ø63) Chromated (ø80, ø100)
12	Release piston bushing	Steel + Special resin	Only ø80, ø100
13	Unlocking cam	Chromium molybdenum steel	Zinc chromated
14	Washer	Rolled steel	Zinc chromated
15	Retainer pre-load spring	Stainless steel wire	
16	Brake spring	Steel wire	Zinc chromated
17	Clip A	Stainless steel	
18	Clip B	Stainless steel	
19	Steel ball A	Bearing steel	
20	Steel ball B	Bearing steel	
21	Tooth ring	Stainless steel	
22	Bumper	Urethane	
23	Type C retaining ring for unlocking cam shaft	Carbon tool steel	
24	Type C retaining ring for taper ring	Carbon tool steel	
25	Brake shoe	Special friction material	
26	Unit holding tie-rod	Carbon steel	Chromated
27	Tie-rod	Carbon steel	Zinc chromated
28	Bushing	Bearing alloy	
29	Cushion ring	Aluminum alloy	Anodized
30	Cushion valve	Steel wire	Electroless nickel plated
31	Stop ring	Steel for spring	
32	Wear ring	Special resin	
33	Hexagon socket head plug	Carbon steel	

Component Parts

No.	Description	Material	Note
34	Element	Bronze	
35	Tie-rod nut	Rolled steel	
36	Rod end nut	Rolled steel	
37	Spring washer	Steel wire	
38	Spring washer	Steel wire	
39	Piston seal	NBR	
40	Rod seal A	NBR	
41	Rod seal B	NBR	
42	Release piston seal	NBR	
43	Cushion seal	Urethane	
44	Cushion valve seal	NBR	
45	Tube gasket	NBR	
46	Piston gasket	NBR	
47	Piston guide gasket	NBR	
48	Unlocking cam gasket	NBR	
49	O-ring	NBR	

Replacement Parts/Seal Kit

Bore size (mm)	Kit no.	Contents
40	MB1-40Z-PS	
50	MB1-50Z-PS	
63	MB1-63Z-PS	Including 39, 40, 43, 45.
80	MB1-80Z-PS	
100	MB1-100Z-PS	

* Since the lock cannot be disassembled and is normally replaced as a unit, kits are for the cylinder section only. These can be ordered using the order number for each bore size.

* Seal kit includes a grease pack (ø40 and ø50: 10 g, ø63 and ø80: 20 g, ø100: 30 g).

Order with the following part number when only the grease pack is needed.
Grease pack part number: GR-S-010 (10 g), GR-S-020 (20 g)

Dimensions

Basic (B): CNA2B

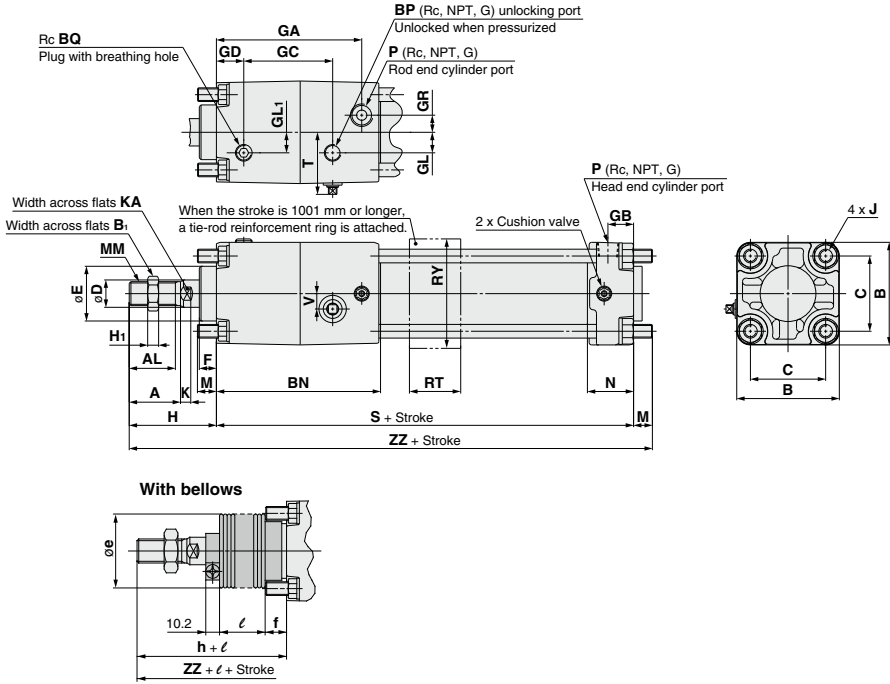

Bore size (mm)	(mm)																							
	A	AL	B	B ₁	BN	BP	BQ	C	D	E	F	GA	GB	GC	GD	GL	GL ₁	GR	H	H ₁	J	K	KA	M
40	30	27	60	22	96	1/8	1/8	44	16	32	10	85	15	50	16	12	12	10	51	8	M8 x 1.25	6	14	11
50	35	32	70	27	108	1/4	1/8	52	20	40	10	95	17	56	20	13	15	12	58	11	M8 x 1.25	7	18	11
63	35	32	86	27	115	1/4	1/4	64	20	40	10	102	17	65	20	18	12	15	58	11	M10 x 1.25	7	18	14
80	40	37	102	32	139	1/4	1/4	78	25	52	14	123	21	79.5	20	23	18	17	71	13	M12 x 1.75	10	22	17
100	40	37	116	41	160	1/4	1/4	92	30	52	14	144	21	93.5	22	25	20	19	72	16	M12 x 1.75	10	26	17

Bore size (mm)	(mm)									
	MM	N	P	RT	RY	S	T	V	ZZ	
40	M14 x 1.5	27	1/4	30	64	153	37.5	9	215	
50	M18 x 1.5	30	3/8	30	76	168	44	11	237	
63	M18 x 1.5	31	3/8	40	92	182	52.5	12	254	
80	M22 x 1.5	37	1/2	45	112	218	59.5	15	306	
100	M26 x 1.5	40	1/2	50	136	246	69.5	15	335	

Bore size (mm)	With Bellows (mm)				
	e	f	h	ℓ	ZZ
40	43	11.2	59	1/4 stroke	223
50	52	11.2	66	1/4 stroke	245
63	52	11.2	66	1/4 stroke	262
80	65	12.5	80	1/4 stroke	315
100	65	14	81	1/4 stroke	344

CNA2 Series

Dimensions

Axial foot (L): CNA2L

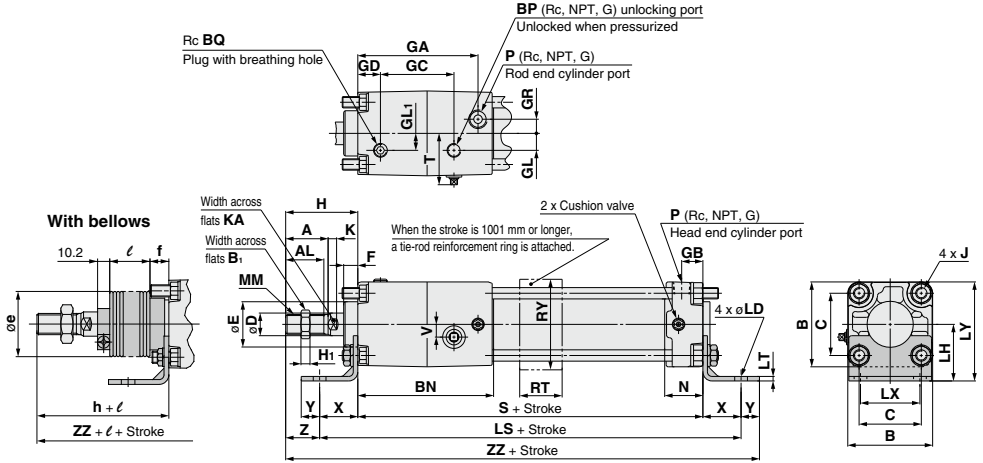

Bore size (mm)	(mm)																							
	A	AL	B	B ₁	BN	BP	BQ	C	D	E	F	GA	GB	GC	GD	GL	GL ₁	GR	H	H ₁	J	K	KA	LD
40	30	27	60	22	96	1/8	1/8	44	16	32	10	85	15	50	16	12	12	10	51	8	M8 x 1.25	6	14	9
50	35	32	70	27	108	1/4	1/8	52	20	40	10	95	17	56	20	13	15	12	58	11	M8 x 1.25	7	18	9
63	35	32	86	27	115	1/4	1/4	64	20	40	10	102	17	65	20	18	12	15	58	11	M10 x 1.25	7	18	11.5
80	40	37	102	32	139	1/4	1/4	78	25	52	14	123	21	79.5	20	23	18	17	71	13	M12 x 1.75	10	22	13.5
100	40	37	116	41	160	1/4	1/4	92	30	52	14	144	21	93.5	22	25	20	19	72	16	M12 x 1.75	10	26	13.5

Bore size (mm)	(mm)																
	LH	LS	LT	LX	LY	MM	N	P	RT	RY	S	T	V	X	Y	Z	ZZ
40	40	207	3.2	42	70	M14 x 1.5	27	1/4	30	64	153	37.5	9	27	13	24	244
50	45	222	3.2	50	80	M18 x 1.5	30	3/8	30	76	168	44	11	27	13	31	266
63	50	250	3.2	59	93	M18 x 1.5	31	3/8	40	92	182	52.5	12	34	16	24	290
80	65	306	4.5	76	116	M22 x 1.5	37	1/2	45	112	218	59.5	15	44	16	27	349
100	75	332	6.0	92	133	M26 x 1.5	40	1/2	50	136	246	69.5	15	43	17	29	378

With Bellows

Bore size (mm)	(mm)				
	e	f	h	ℓ	ZZ
40	43	11.2	59	1/4 stroke	252
50	52	11.2	66	1/4 stroke	274
63	52	11.2	66	1/4 stroke	298
80	65	12.5	80	1/4 stroke	358
100	65	14	81	1/4 stroke	387

Dimensions

Rod flange (F): CNA2F

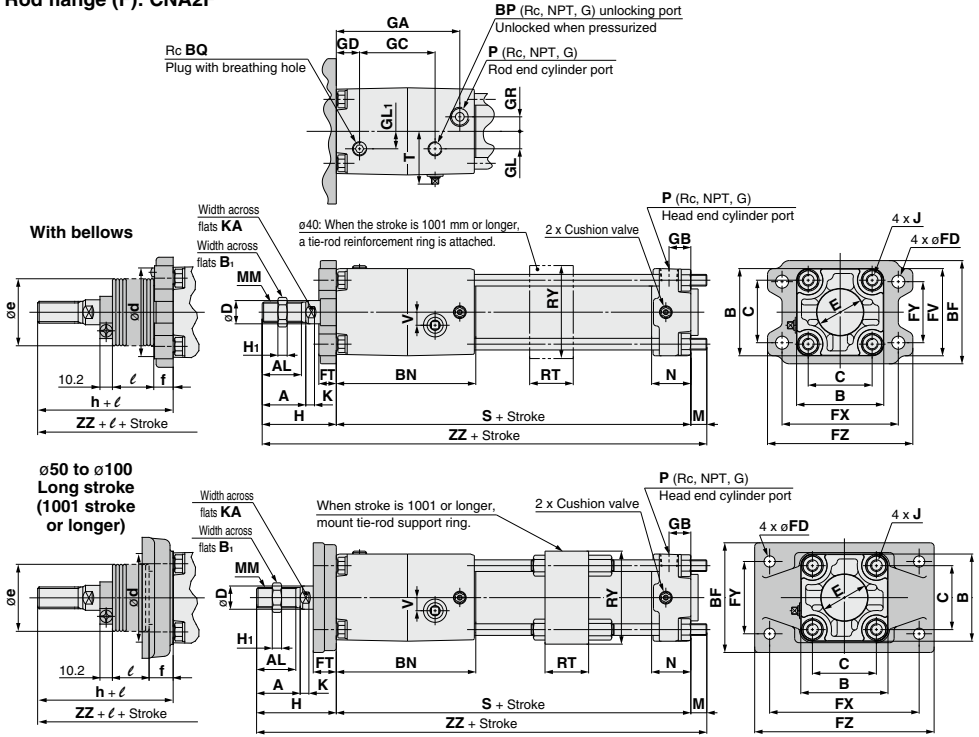

Bore size (mm)	Stroke range (mm)	A	AL	B	B ₁	BF	BN	BP	BQ	C	D	E	FD	FT	FV	FX	FY	FZ	GA	GB	GC	GD	GL	GL ₁	GR	H	H ₁
40	Up to 1800	30	27	60	22	71	96	1/8	1/8	44	16	32	9	12	60	80	42	100	85	15	50	16	12	12	10	51	8
50	Up to 1000	35	32	70	27	81	108	1/4	1/8	52	20	40	9	12	70	90	50	110	95	17	56	20	13	15	12	58	11
63	Up to 1000	35	32	86	27	101	115	1/4	1/4	64	20	40	11.5	15	86	105	59	130	102	17	65	20	18	12	15	58	11
80	Up to 1000	40	37	102	32	119	139	1/4	1/4	78	25	52	13.5	18	102	130	76	160	123	21	79.5	20	23	18	17	71	13
100	Up to 1000	40	37	116	41	133	160	1/4	1/4	92	30	52	13.5	18	116	150	92	180	144	21	93.5	22	25	20	19	72	16

Bore size (mm)	J	K	KA	M	MM	N	P	RT	RY	S	T	V	ZZ
40	M8 x 1.25	6	14	11	M14 x 1.5	27	1/4	30	64	153	37.5	9	215
50	M8 x 1.25	7	18	11	M18 x 1.5	30	3/8	-	-	168	44	11	237
63	M10 x 1.25	7	18	14	M18 x 1.5	31	3/8	-	-	182	52.5	12	254
80	M12 x 1.75	10	22	17	M22 x 1.5	37	1/2	-	-	218	59.5	15	306
100	M12 x 1.75	10	26	17	M26 x 1.5	40	1/2	-	-	246	69.5	15	335

Bore size (mm)	Stroke range (mm)	d ^f	e	f	h	ℓ	ZZ
40	20 to 1800	52	43	15	59	1/4 stroke	223
50	20 to 1000	58	52	15	66	1/4 stroke	245
63	20 to 1000	58	52	17.5	66	1/4 stroke	262
80	20 to 1000	80	65	21.5	80	1/4 stroke	315
100	20 to 1000	80	65	21.5	81	1/4 stroke	344

Bore size (mm)	Stroke range (mm)	BF	FD	FT	FX	FY	FZ	H	M	RT	RY	ZZ
50	1001 to 1800	88	9	20	120	58	144	67	6	30	76	241
63	1001 to 1800	105	11.5	23	140	64	170	71	10	40	92	263
80	1001 to 1800	124	13.5	28	164	84	198	87	12	45	112	317
100	1001 to 1800	140	13.5	29	180	100	220	89	12	50	136	347

Bore size (mm)	Stroke range (mm)	d	e ^a	f	h	ℓ	ZZ
50	1001 to 1800	58	52	19	66	1/4 stroke	240
63	1001 to 1800	58	52	19	66	1/4 stroke	258
80	1001 to 1800	80	65	21	80	1/4 stroke	310
100	1001 to 1800	80	65	21	81	1/4 stroke	339

^a When machining a hole to put a bellows through for mounting, make the hole larger than the O.D. ød of the bellows mounting bracket for the standard stroke and the bellows O.D. øe for a long stroke.

CNA2 Series

Dimensions

Head flange (G): CNA2G

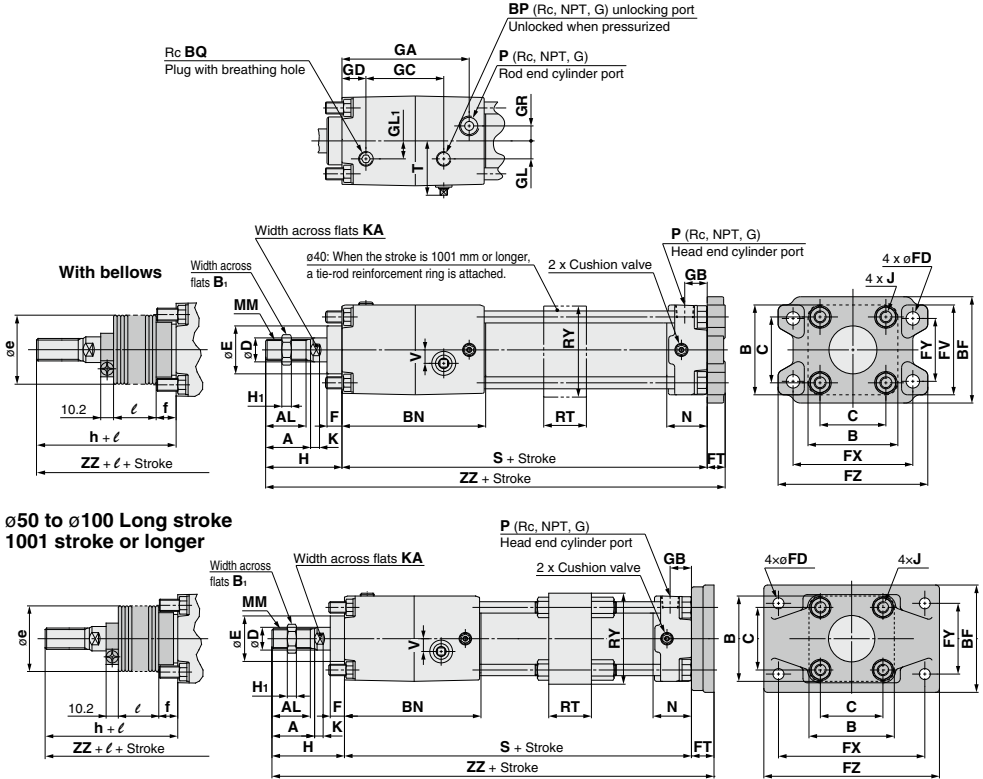

ø50 to ø100 Long stroke 1001 stroke or longer

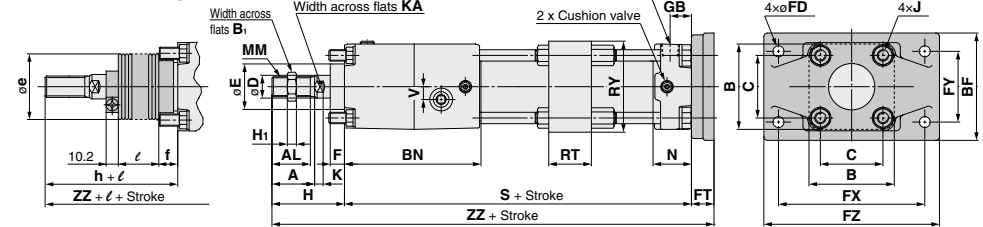

Bore size (mm)	Stroke range (mm)	A	AL	B	B ₁	BF	BN	BP	BQ	C	D	E	F	FD	FT	FV	FX	FY	FZ	GA	GB	GC	GD	GL	GL ₁	GR	H
40	Up to 1800	30	27	60	22	71	96	1/8	1/8	44	16	32	10	9	12	60	80	42	100	85	15	50	16	12	12	10	51
50	Up to 1000	35	32	70	27	81	108	1/4	1/8	52	20	40	10	9	12	70	90	50	110	95	17	56	20	13	15	12	58
63	Up to 1000	35	32	86	27	101	115	1/4	1/4	64	20	40	10	11.5	15	86	105	59	130	102	17	65	20	18	12	15	58
80	Up to 1000	40	37	102	32	119	139	1/4	1/4	78	25	52	14	13.5	18	102	130	76	160	123	21	79.5	20	23	18	17	71
100	Up to 1000	40	37	116	41	133	160	1/4	1/4	92	30	52	14	13.5	18	116	150	92	180	144	21	93.5	22	25	20	19	72

Bore size (mm)	H ₁	J	K	KA	MM	N	P	RT	RY	S	T	V	ZZ
40	8	M8 x 1.25	6	14	M14 x 1.5	27	1/4	30	64	153	37.5	9	216
50	11	M8 x 1.25	7	18	M18 x 1.5	30	3/8	—	—	168	44	11	238
63	11	M10 x 1.25	7	18	M18 x 1.5	31	3/8	—	—	182	52.5	12	255
80	13	M12 x 1.75	10	22	M22 x 1.5	37	1/2	—	—	218	59.5	15	307
100	16	M12 x 1.75	10	26	M26 x 1.5	40	1/2	—	—	246	69.5	15	336

Bore size (mm)	Stroke range (mm)	e	f	h	ℓ	ZZ
40	20 to 1800	43	11.2	59	1/4 stroke	224
50	20 to 1000	52	11.2	66	1/4 stroke	246
63	20 to 1000	52	11.2	66	1/4 stroke	263
80	20 to 1000	65	12.5	80	1/4 stroke	316
100	20 to 1000	65	14	81	1/4 stroke	345

Bore size (mm)	Stroke range (mm)	BF	FD	FT	FX	FY	FZ	RT	RY	ZZ
50	1001 to 1800	88	9	20	120	58	144	30	76	246
63	1001 to 1800	105	11.5	23	140	64	170	40	92	263
80	1001 to 1800	124	13.5	28	164	84	198	45	112	317
100	1001 to 1800	140	13.5	29	180	100	220	50	136	347

Bore size (mm)	Stroke range (mm)	e	f	h	ℓ	ZZ
50	1001 to 1800	52	11.2	66	1/4 stroke	254
63	1001 to 1800	52	11.2	66	1/4 stroke	271
80	1001 to 1800	65	12.5	80	1/4 stroke	326
100	1001 to 1800	65	14	81	1/4 stroke	356

Dimensions

Single clevis (C): CNA2C

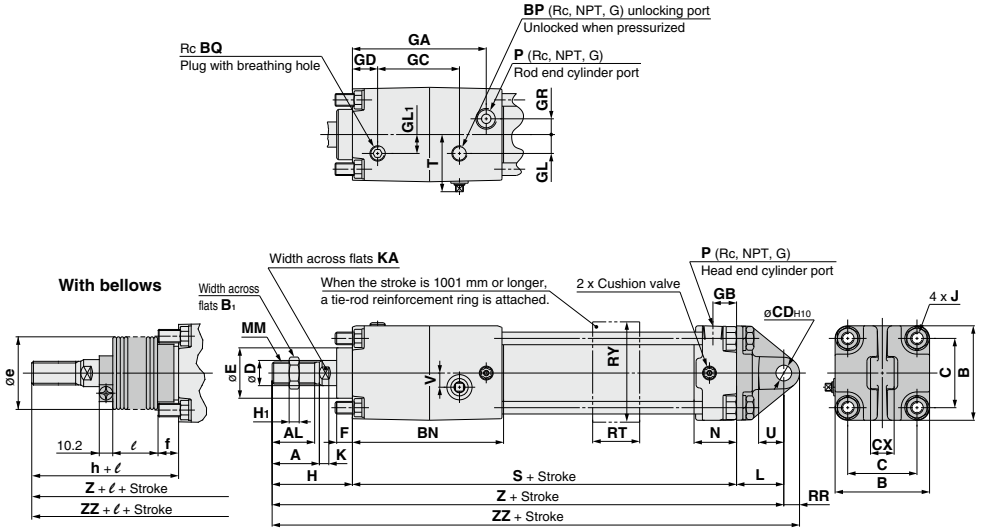

Bore size (mm)	A	AL	B	B ₁	BN	BP	BQ	C	CD _{H10}	CX	D	E	F	GA	GB	GC	GD	GL	GL ₁	GR	H	H ₁
40	30	27	60	22	96	1/8	1/8	44	10 ^{+0.058} ₀	15 ^{-0.1} _{-0.3}	16	32	10	85	15	50	16	12	12	10	51	8
50	35	32	70	27	108	1/4	1/8	52	12 ^{+0.070} ₀	18 ^{-0.1} _{-0.3}	20	40	10	95	17	56	20	13	15	12	58	11
63	35	32	86	27	115	1/4	1/4	64	16 ^{+0.070} ₀	25 ^{-0.1} _{-0.3}	20	40	10	102	17	65	20	18	12	15	58	11
80	40	37	102	32	139	1/4	1/4	78	20 ^{+0.084} ₀	31.5 ^{-0.1} _{-0.3}	25	52	14	123	21	79.5	20	23	18	17	71	13
100	40	37	116	41	160	1/4	1/4	92	25 ^{+0.084} ₀	35.5 ^{-0.1} _{-0.3}	30	52	14	144	21	93.5	22	25	20	19	72	16

Bore size (mm)	J	K	KA	L	MM	N	P	RR	RT	RY	S	T	U	V	Z	ZZ
40	M8 x 1.25	6	14	30	M14 x 1.5	27	1/4	10	30	64	153	37.5	16	9	234	244
50	M8 x 1.25	7	18	35	M18 x 1.5	30	3/8	12	30	76	168	44	19	11	261	273
63	M10 x 1.25	7	18	40	M18 x 1.5	31	3/8	16	40	92	182	52.5	23	12	280	296
80	M12 x 1.75	10	22	48	M22 x 1.5	37	1/2	20	45	112	218	59.5	28	15	337	357
100	M12 x 1.75	10	26	58	M26 x 1.5	40	1/2	25	50	136	246	69.5	36	15	376	401

Bore size (mm)	e	f	h	ℓ	Z	ZZ
40	43	11.2	59	1/4 stroke	242	252
50	52	11.2	66	1/4 stroke	269	281
63	52	11.2	66	1/4 stroke	288	304
80	65	12.5	80	1/4 stroke	346	366
100	65	14	81	1/4 stroke	385	410

CNA2 Series

Dimensions

Double clevis (D): CNA2D

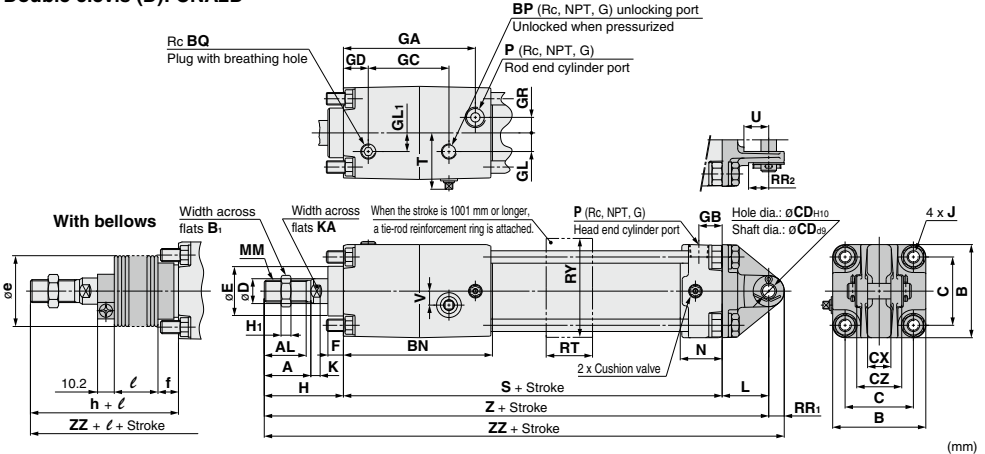

Bore size (mm)	A	AL	B	B ₁	BN	BP	BQ	C	CD _{H10}	CX	CZ	D	E	F	GA	GB	GC	GD	GL	GL ₁	GR	H	H ₁	J	K	KA	L
40	30	27	60	22	96	1/8	1/8	44	10 ^{+0.058} ₀	15 ^{+0.3} _{+0.1}	29.5	16	32	10	85	15	50	16	12	12	10	51	8	M8x1.25	6	14	30
50	35	32	70	27	108	1/4	1/8	52	12 ^{+0.070} ₀	18 ^{+0.3} _{+0.1}	38	20	40	10	95	17	56	20	13	15	12	58	11	M8x1.25	7	18	35
63	35	32	86	27	115	1/4	1/4	64	16 ^{+0.070} ₀	25 ^{+0.3} _{+0.1}	49	20	40	10	102	17	65	20	18	12	15	58	11	M10x1.25	7	18	40
80	40	37	102	32	139	1/4	1/4	78	20 ^{+0.084} ₀	31.5 ^{+0.3} _{+0.1}	61	25	52	14	123	21	79.5	20	23	18	17	71	13	M12x1.75	10	22	48
100	40	37	116	41	160	1/4	1/4	92	25 ^{+0.084} ₀	35.5 ^{+0.3} _{+0.1}	64	30	52	14	144	21	93.5	22	25	20	19	72	16	M12x1.75	10	26	58

Bore size (mm)	MM	N	P	RR ₁	RR ₂	RT	RY	S	T	U	V	Z	ZZ
40	M14x1.5	27	1/4	10	16	30	64	153	37.5	16	9	234	244
50	M18x1.5	30	3/8	12	19	30	76	168	44	19	11	261	273
63	M18x1.5	31	3/8	16	23	40	92	182	52.5	23	12	280	296
80	M22x1.5	37	1/2	20	28	45	112	218	59.5	28	15	337	357
100	M26x1.5	40	1/2	25	33.5	50	136	246	69.5	36	15	376	401

Bore size (mm)	e	f	h	ℓ	Z	ZZ
40	43	11.2	59	1/4 Stroke	242	252
50	52	11.2	66	1/4 Stroke	269	281
63	52	11.2	66	1/4 Stroke	288	304
80	65	12.5	80	1/4 Stroke	346	366
100	65	14	81	1/4 Stroke	385	410

* Clevis pin, flat washer and split pin are shipped together.

Double Clevis Pivot Bracket

Material: Cast iron

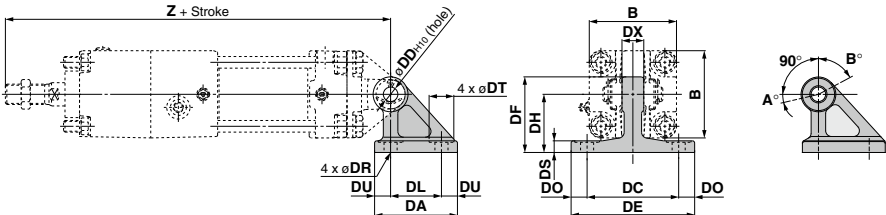

Part no.	Bore size (mm)	B	DA	DC	DD _{H10} (hole)	DE	DF	DH	DL	DO	DR	DS	DT	DU	DX	Z
CA2-B04	40	60	57	65	10 ^{+0.058} ₀	85	52	40	35	10	9	8	17	11	15	234
CA2-B05	50	70	57	65	12 ^{+0.070} ₀	85	52	40	35	10	9	8	17	11	18	261
CA2-B06	63	85	67	80	16 ^{+0.070} ₀	105	66	50	40	12.5	11	10	22	13.5	25	280
CA2-B08	80	102	93	100	20 ^{+0.084} ₀	130	90	65	60	15	13.5	12	24	16.5	31.5	337
CA2-B10	100	116	93	100	25 ^{+0.084} ₀	130	90	65	60	15	13.5	12	24	16.5	35.5	376

Rotating Angle

Bore size (mm)	A°	B°	A° + B° + 90°
40			
50			
63	12°	60°	162°
80			
100			

Note 1) There is no mention of cylinder part number. Note 2) Order it separately from cylinder.

Dimensions

Center trunnion (T): CNA2T

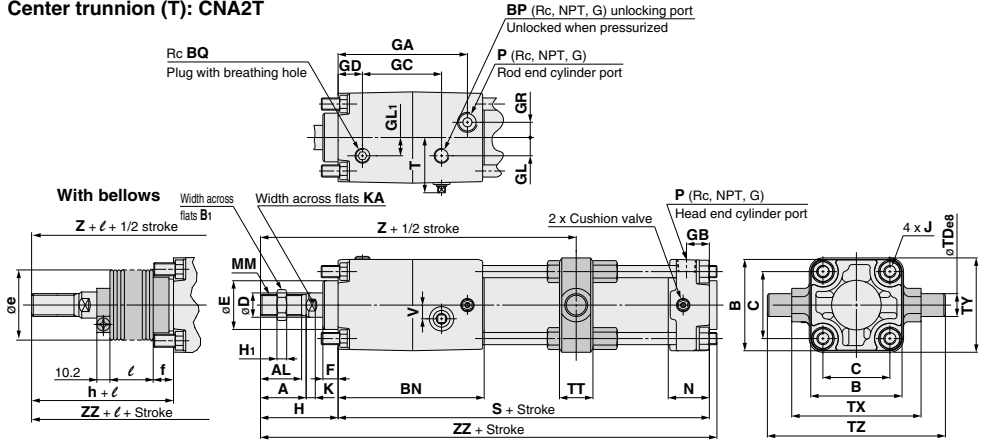

Bore size (mm)	A	AL	B	B ₁	BN	BP	BQ	C	D	E	F	GA	GB	GC	GD	GL	GL ₁	GR	H	H ₁	J	K	KA	MM	N	P
40	30	27	60	22	96	1/8	1/8	44	16	32	10	85	15	50	16	12	12	10	51	8	M8 x 1.25	6	14	M14 x 1.5	27	1/4
50	35	32	70	27	108	1/4	1/8	52	20	40	10	95	17	56	20	13	15	12	58	11	M8 x 1.25	7	18	M18 x 1.5	30	3/8
63	35	32	86	27	115	1/4	1/4	64	20	40	10	102	17	65	20	18	12	15	58	11	M10 x 1.25	7	18	M18 x 1.5	31	3/8
80	40	37	102	32	139	1/4	1/4	78	25	52	14	123	21	79.5	20	23	18	17	71	13	M12 x 1.75	10	22	M22 x 1.5	37	1/2
100	40	37	116	41	160	1/4	1/4	92	30	52	14	144	21	93.5	22	25	20	19	72	16	M12 x 1.75	10	26	M26 x 1.5	40	1/2

Bore size (mm)	S	T	TD _{e8}	TT	TX	TY	TZ	V	Z	ZZ
40	153	37.5	15 ^{+0.032} _{-0.059}	22	85	62	117	9	162	209
50	168	44	15 ^{+0.032} _{-0.059}	22	95	74	127	11	181	232
63	182	52.5	18 ^{+0.032} _{-0.059}	28	110	90	148	12	191	246
80	218	59.5	25 ^{+0.040} _{-0.073}	34	140	110	192	15	231	296
100	246	69.5	25 ^{+0.040} _{-0.073}	40	162	130	214	15	255	326

Bore size (mm)	e	f	h	ℓ	Z	ZZ
40	43	11.2	59	1/4 stroke	170	217
50	52	11.2	66	1/4 stroke	189	240
63	52	11.2	66	1/4 stroke	199	254
80	65	12.5	80	1/4 stroke	240	305
100	65	14	81	1/4 stroke	264	335

Trunnion Pivot Bracket

Material: Cast iron

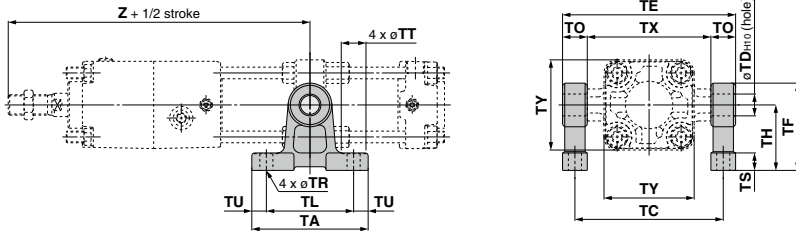

Part no.	Bore size (mm)	TA	TC	TD _{H10} (hole)	TE	TF	TH	TL	TO	TR	TS	TT	TU	TX	TY	Z
CA2-S04	40	80	102	15 ^{+0.070} ₀	119	60	45	60	17	9	12	17	10	85	62	162
	50	80	112	15 ^{+0.070} ₀	129	60	45	60	17	9	12	17	10	95	74	181
CA2-S06	63	100	130	18 ^{+0.070} ₀	150	73	55	70	20	11	14	22	15	110	90	191
	80	120	166	25 ^{+0.084} ₀	192	100	75	90	26	13.5	17	24	15	140	110	231
MB-S10	100	120	188	25 ^{+0.084} ₀	214	100	75	90	26	13.5	17	24	15	162	130	255

Note 1) There is no mention of cylinder part number.

Note 2) Order it separately from cylinder.

Note 3) Two trunnion pivot brackets are needed per one cylinder.

Accessory Bracket Dimensions

Y Type Double Knuckle Joint

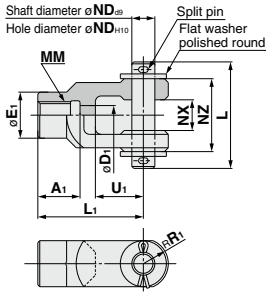

Material: Cast iron

(mm)

Part no.	Applicable bore size (mm)	A ₁	D ₁	E ₁	L	L ₁	MM	ND	NX	NZ	R ₁	U ₁	Split pin size	Flat washer size
Y-04D	40	22	10	24	55.5	55	M14 x 1.5	12	16 ^{+0.3} _{-0.1}	38	13	25	ø3 x 18 ℓ	Polished round 12
Y-05D	50, 63	27	14	28	55.5	60	M18 x 1.5	12	16 ^{+0.3} _{-0.1}	38	15	27	ø3 x 18 ℓ	Polished round 12
Y-08D	80	37	18	36	76.5	71	M22 x 1.5	18	28 ^{+0.3} _{-0.1}	55	19	28	ø4 x 25 ℓ	Polished round 18
Y-10D	100	37	21	40	83	83	M26 x 1.5	20	30 ^{+0.3} _{-0.1}	61	21	38	ø4 x 30 ℓ	Polished round 20

* Knuckle pin, split pin and flat washer are shipped together.

Clevis Pin/Knuckle Pin

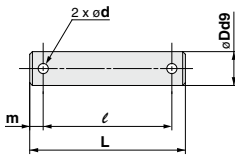

Material: Carbon steel

(mm)

Part no.	Applicable bore size		Dd9	d Drill through	L	ℓ	m	Applicable split pin	Applicable flat washer
	Clevis	Knuckle							
CDP-2A	40	—	10 ^{-0.040} _{-0.076}	3	46	38	4	ø3 x 18 ℓ	Polished round 10
CDP-3A	50	40, 50, 63	12 ^{-0.050} _{-0.093}	3	55.5	47.5	4	ø3 x 18 ℓ	Polished round 12
CDP-4A	63	—	16 ^{-0.050} _{-0.093}	4	71	61	5	ø4 x 25 ℓ	Polished round 16
CDP-5A	—	80	18 ^{-0.050} _{-0.093}	4	76.5	66.5	5	ø4 x 25 ℓ	Polished round 18
CDP-6A	80	100	20 ^{-0.065} _{-0.117}	4	83	73	5	ø4 x 30 ℓ	Polished round 20
CDP-7A	100	—	25 ^{-0.065} _{-0.117}	4	88	78	5	ø4 x 36 ℓ	Polished round 24

* Split pin and flat washer are attached.

I Type Single Knuckle Joint

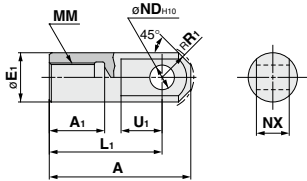

Material: Sulfur free-cutting steel

(mm)

Part no.	Applicable bore size (mm)	A	A ₁	E ₁	L ₁	MM	ND _{H10}	NX	R ₁	U ₁
I-04A	40	69	22	24	55	M14 x 1.5	12 ^{+0.070} ₀	16 ^{-0.1} _{-0.3}	15.5	20
I-05A	50, 63	74	27	28	60	M18 x 1.5	12 ^{+0.070} ₀	16 ^{-0.1} _{-0.3}	15.5	20
I-08A	80	91	37	36	71	M22 x 1.5	18 ^{+0.070} ₀	28 ^{-0.1} _{-0.3}	22.5	26
I-10A	100	105	37	40	83	M26 x 1.5	20 ^{+0.084} ₀	30 ^{-0.1} _{-0.3}	24.5	28

Rod End Nut (Standard equipment)

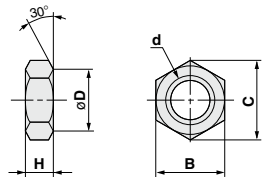

Material: Rolled steel

(mm)

Part no.	Applicable bore size (mm)	B	C	D	d	H
NT-04	40	22	25.4	21	M14 x 1.5	8
NT-05	50, 63	27	31.2	26	M18 x 1.5	11
NT-08	80	32	37.0	31	M22 x 1.5	13
NT-10	100	41	47.3	39	M26 x 1.5	16

Cylinder with Lock

Double Acting, Double Rod

CNA2W Series

ø40, ø50, ø63, ø80, ø100

How to Order

CNA2W L 50 100 JN-D

CDNA2W L 50 100 JN-D M9BW

With auto switch
 With auto switch (Built-in magnet)
 Double rod
 Mounting
 Locking direction
 Made to Order
 Number of auto switches
 Auto switch

B Basic
L Axial foot
F Rod flange
T Center trunnion

Cylinder tube material
NII Aluminum tube
F¹ Steel tube
 * Auto switches are not available with steel tube.

Bore size
40 40 mm
50 50 mm
63 63 mm
80 80 mm
100 100 mm

Port thread type
NII Rc
TN NPT
TF G

Cylinder stroke (mm)
 Refer to page 777 for standard stroke.

With bellows/cushion**
 Single side*
J Nylon tarpaulin
K Heat resistant tarpaulin
 Both sides bellows
JJ Nylon tarpaulin
KK Heat resistant tarpaulin
 Cushion
Nil With double-side cushion
N Without cushion

* In case of single side, it is in the lock side.
 ** When the symbols are two or more, indicate them alphabetically.

Number of auto switches
NII 2 pcs.
S 1 pc.
n "n" pcs.

Auto switch
Nil Without auto switch
 * For applicable auto switches, refer to the below table.

Built-in Magnet Cylinder Model

If a built-in magnet cylinder without an auto switch is required, there is no need to enter the symbol for the auto switch.
 (Example) CDNA2WL40-100-D

Applicable Auto Switches/Refer to pages 1341 to 1435 for further information on auto switches.

Type	Special function	Electrical entry	Indicator type	Wiring (Output)	Load voltage		Auto switch model		Lead wire length (m)					Pre-wired connector	Applicable load	
					DC	AC	Tie-rod mounting	Band mounting	0.5 (Nil)	1 (M)	3 (L)	5 (Z)				
Solid state auto switch		Grommet		3-wire (NPN)	24 V	5 V, 12 V	—	M9N	●	●	●	○	○	IC circuit		
				3-wire (PNP)				M9P	●	●	●	○	○			
				2-wire	M9B	●	●	●	○	○						
				2-wire	K59	●	●	●	○	○						
	Diagnostic indication (2-color indicator)	Terminal conduit	Yes	Grommet	3-wire (NPN)	24 V	12 V	—	G39C	—	—	—	—	—	IC circuit	Relay, PLC
					2-wire				K39C	—	—	—	—	—		
					3-wire (NPN)	M9NW	●	●	●	○	○					
					3-wire (PNP)	G59W	●	●	●	○	○					
					2-wire	M9PW	●	●	●	○	○					
					2-wire	G59W	●	●	●	○	○					
Water resistant (2-color indicator)	Grommet			3-wire (NPN)	24 V	12 V	—	M9BW	●	●	●	○	○	—		
				3-wire (PNP)				K59W	●	●	●	○	○			
				2-wire	M9A ^{*1}	—	○	○	●	○	○					
				2-wire	M9PA ^{*1}	—	○	○	●	○	○					
With diagnostic output (2-color indicator)	Grommet			4-wire (NPN)	24 V	5 V, 12 V	—	M9BA ^{*1}	—	○	○	●	○	IC circuit		
				2-wire (Non-polar)				G5BA ^{*1}	—	—	—	—	—			—
Reed auto switch		Grommet	Yes	3-wire (NPN equivalent)	24 V	12 V	—	A96	●	●	●	○	○	IC circuit		
								A93	●	●	●	○	○			
								A90	●	●	●	○	○			
								A54	●	●	●	○	○			
								A64	●	●	●	○	○			
								A33C	●	●	●	○	○			
								A34C	●	●	●	○	○			
								A44C	●	●	●	○	○			
								A59W	●	●	●	○	○			
								Diagnostic indication (2-color indicator)	Terminal conduit	Yes	Grommet	2-wire	24 V			12 V
B64	●	●	●	○	○											
	DIN terminal	Yes	Grommet		24 V	12 V	—	A33C	●	●	●	○	○	—	PLC	
								A34C	●	●	●	○	○			
	Grommet				24 V	12 V	—	A44C	●	●	●	○	○	—	Relay, PLC	
								A59W	●	●	●	○	○			

*1 Water resistant type auto switches can be mounted on the above models, but in such case SMC cannot guarantee water resistance.

Consult with SMC regarding water resistant types with the above model numbers.

* Lead wire length symbols: 0.5 m Nil (Example) M9NW * Solid state auto switches marked with "○" are produced upon receipt of order.

1 m M (Example) M9NWM
 3 m L (Example) M9NWL
 5 m Z (Example) M9NWZ

* Since there are other applicable auto switches than listed, refer to page 788 for details.

* For details about auto switches with pre-wired connector, refer to pages 1410 and 1411.

* The D-A9□/M9□□/P3DWA□ auto switches are shipped together, (but not assembled). (Only auto switch mounting brackets are assembled at the time of shipment for the D-A9□/M9□□.)

Cylinder with Lock Double Acting, Double Rod **CNA2W Series**



Symbol

Air cushion

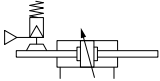

Made to Order
[Click here for details](#)

Symbol	Specifications
-XC14	Change of trunnion bracket mounting position
-XC15	Change of tie-rod length

Refer to pages 783 to 788 for cylinders with auto switches.

- Minimum stroke for auto switch mounting
- Auto switch proper mounting position (detection at stroke end) and mounting height
- Operating range
- Auto switch mounting bracket/Part no.

Minimum mountable stroke for a cylinder with auto switch(es)

⚠ Caution

1. Each switch and mounting type of cylinder has different minimum mountable stroke. Be careful especially of the center trunnion type.

(Refer to pages 785 and 786 for details.)

Specifications

Bore size (mm)	40	50	63	80	100
Fluid	Air				
Lubrication	Not required (Non-lube)				
Action	Double acting				
Lock operation	Spring locking				
Proof pressure	1.5 MPa				
Max. operating pressure	1.0 MPa				
Min. operating pressure	0.1 MPa				
Piston speed	50 to 1000 mm/s *				
Ambient and fluid temperature	Without auto switch: -10 to 70°C (No freezing) With auto switch: -10 to 60°C (No freezing)				
Cushion	Air cushion				
Stroke length tolerance	Up to 250: $^{+1.0}_0$, 251 to 1000: $^{+1.4}_0$, 1001 to 1500: $^{+1.8}_0$				
Mounting	Basic, Axial foot, Rod flange, Center trunnion				

* Load limits exist depending on the piston speed when locked, mounting direction and operating pressure.

Lock Specifications

Bore size (mm)	40	50	63	80	100
Locking action	Spring locking (Exhaust locking)				
Unlocking pressure	0.25 MPa or more				
Lock starting pressure	0.20 MPa or less				
Max. operating pressure	1.0 MPa				
Locking direction	Both directions				
Holding force (Maximum static load) N	882	1370	2160	3430	5390

* The holding force (max. static load) shows the maximum capability and does not show the normal holding capability. So, select an appropriate cylinder while referring to page 760.

Standard Stroke

For cases with auto switches, refer to the table of minimum stroke for auto switch mounting on pages 785 and 786.

Bore size (mm)	Standard stroke (mm) ^{Note 1)}		Max. m manufacturable stroke
	Stroke range ①	Stroke range ②	
40	25, 50, 100, 125, 150, 175, 200, 250 300, 350, 400, 450, 500	Up to 1000	Up to 1800
	25, 50, 100, 125, 150, 175, 200, 250 300, 350, 400, 450, 500, 600	Up to 1200	
80, 100	25, 50, 100, 125, 150, 175, 200, 250 300, 350, 400, 450, 500, 600, 700	Up to 1500	

Note 1) Strokes other than listed above are produced upon receipt of order.

Spacers are not used for intermediate strokes.

Note 2) Applicable strokes should be confirmed according to the usage. For details, refer to "Air Cylinders Model Selection" in the **Web Catalog**.

Note 3) Please consult with SMC for manufacturability and the part numbers when exceeding the stroke range ②.

Note 4) The stroke range with rod boot is 20 to 1400 mm. Please consult with SMC when exceeding 1400 mm strokes.

Note 5) Using a stroke of a length which is smaller than the effective cushion length may result in reduced air cushion performance. Refer to "Technical Data 1" in the **Web Catalog** for details on the effective cushion length.

Stopping Accuracy

Lock type	Piston speed (mm/s)			
	100	300	500	1000
Spring locking	±0.3	±0.6	±1.0	±2.0

Condition: Lateral, Supply pressure P = 0.5 MPa

Load weight Upper limit of allowed value

Solenoid valve for locking mounted on the unlocking port

Maximum value of stopping position dispersion from 100 measurements

CNA2W Series

Mounting Bracket/Part No.

Bore size (mm)	40	50	63	80	100
Axial foot *	CA2-L04	CA2-L05	CA2-L06	CA2-L08	CA2-L10
Flange	CA2-F04	CA2-F05	CA2-F06	CA2-F08	CA2-F10

* When ordering axial foot bracket, order 2 pieces per cylinder.

** Accessories for each mounting bracket are as follows.

Foot/Flange type: Body mounting nuts, Spring washer

Bellows Material

Symbol	Bellows material	Max. ambient temperature
J	Nylon tarpaulin	70°C
K	Heat resistant tarpaulin	110°C *

* Maximum ambient temperature for bellows itself

Accessories

Mounting		Basic	Axial foot	Flange	Center trunnion
Standard equipment	Rod end nut	●	●	●	●
Option	Single knuckle joint	●	●	●	●
	Double knuckle joint (With pin)	●	●	●	●
	With bellows	●	●	●	●

* Accessory bracket dimensions are same as those of double acting, single rod type of the CNA2 series. (Refer to page 774.)

* For details about part numbers and dimensions, refer to page 774. (For rod boots, refer to page 780.)

Weight

Bore size (mm)		40	50	63	80	100	
Basic weight	Basic	Aluminum tube	1.80	2.83	4.22	7.54	11.12
		Steel tube	1.85	2.89	4.26	7.70	11.33
	Axial foot	Aluminum tube	1.99	2.87	4.56	8.21	12.11
		Steel tube	2.04	2.91	4.60	8.37	12.32
	Flange	Aluminum tube	2.17	3.10	5.01	8.99	13.04
		Steel tube	2.22	3.14	5.05	9.15	13.25
	Center trunnion	Aluminum tube	2.25	3.18	5.11	9.24	13.52
		Steel tube	2.35	3.28	5.31	9.53	13.91
Additional weight per each 50 mm of stroke	Mounting bracket	Aluminum tube	0.28	0.37	0.44	0.66	0.86
		Steel tube	0.35	0.47	0.55	0.89	1.15
Accessory bracket	Single knuckle joint	0.23	0.26	0.26	0.60	0.83	
	Double knuckle joint (With pin)	0.37	0.43	0.43	0.87	1.27	

Calculation: (Example) **CNA2WL40-100-D** Basic weight 1.99 (Axial foot, ø40)

Additional weight 0.28/50 stroke

Cylinder stroke 100 stroke

$1.99 + 0.28 \times 100/50 = 2.55$ kg

Construction

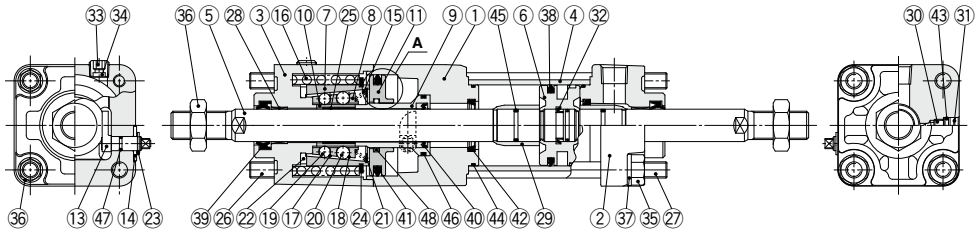

A section (Release piston bushing)

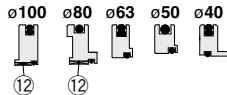

Component Parts

No.	Description	Material	Note
1	Rod cover	Aluminum alloy	Metallic painted after hard anodized
2	Rod cover	Aluminum alloy	Metallic painted
3	Cover	Aluminum alloy	Metallic painted after chromated
4	Cylinder tube	Aluminum alloy	Hard anodized
5	Piston rod	Carbon steel	Hard chrome plated
6	Piston	Aluminum alloy	Chromated
7	Taper ring	Bearing steel	Heat treated
8	Ball retainer	Special resin	
9	Piston guide	Carbon steel	Zinc chromated
10	Brake shoe holder	Special steel	Heat treated
11	Release piston	Aluminum alloy	Hard anodized (ø40, ø50, ø63) Chromated (ø80, ø100)
12	Release piston bushing	Steel + Special resin	Only ø80, ø100
13	Unlocking cam	Chromium molybdenum steel	Zinc chromated
14	Washer	Rolled steel	Zinc chromated
15	Retainer pre-load spring	Stainless steel wire	
16	Brake spring	Steel wire	Zinc chromated
17	Clip A	Stainless steel	
18	Clip B	Stainless steel	
19	Steel ball A	Bearing steel	
20	Steel ball B	Bearing steel	
21	Tooth ring	Stainless steel	
22	Bumper	Urethane	
23	Type C retaining ring for unlocking cam shaft	Carbon tool steel	
24	Type C retaining ring for taper ring	Carbon tool steel	
25	Brake shoe	Special friction material	
26	Unit holding tie-rod	Carbon steel	Chromated
27	Tie-rod	Carbon steel	Zinc chromated
28	Bushing	Bearing alloy	
29	Cushion ring	Aluminum alloy	Anodized
30	Cushion valve	Steel wire	Electroless nickel plated
31	Stop ring	Steel for spring	
32	Piston holder	Urethane	
33	Hexagon socket head plug	Carbon steel	

Component Parts

No.	Description	Material	Note
34	Element	Bronze	
35	Tie-rod nut	Rolled steel	
36	Rod end nut	Rolled steel	
37	Spring washer	Steel wire	
38	Spring washer	Steel wire	
39	Piston seal	NBR	
40	Rod seal A	NBR	
41	Rod seal B	NBR	
42	Release piston seal	NBR	
43	Cushion seal	Urethane	
44	Cushion valve seal	NBR	
45	Tube gasket	NBR	
46	Piston gasket	NBR	
47	Piston guide gasket	NBR	
48	Unlocking cam gasket	NBR	
49	O-ring	NBR	

Replacement Parts/Seal Kit

Bore size (mm)	Kit no.	Contents
40	MB1W40Z-PS	Including 39, 40, 43, 45.
50	MB1W50Z-PS	
63	MB1W63Z-PS	
80	MB1W80Z-PS	
100	MB1W100Z-PS	

* Since the lock of the CNA2 series cannot be disassembled and is normally replaced as a unit, kits are for the cylinder section only. These can be ordered using the order number for each bore size.

* Seal kit includes a grease pack (ø40 and ø50: 10 g, ø63 and ø80: 20 g, ø100: 30 g).

Order with the following part number when only the grease pack is needed.
Grease pack part number: GR-S-010 (10 g), GR-S-020 (20 g)

CNA2W Series

Dimensions

Basic (B): CNA2WB

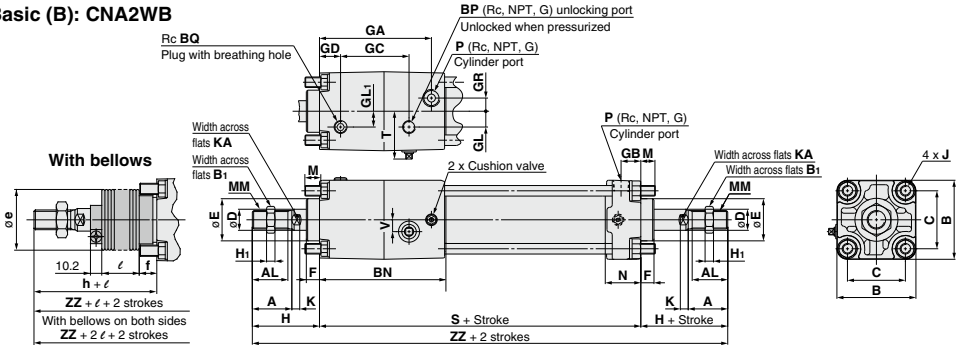

Bore size (mm)	Stroke range (mm)	A	AL	B	B ₁	BN	BP	BQ	C	D	E	F	GA	GB	GC	GD	GL	GL ₁	GR	H	H ₁	J	K
40	Up to 500	30	27	60	22	96	1/8	1/8	44	16	32	10	85	15	50	16	12	12	10	51	8	M8 x 1.25	6
50	Up to 600	35	32	70	27	108	1/4	1/8	52	20	40	10	95	17	56	20	13	15	12	58	11	M8 x 1.25	7
63	Up to 600	35	32	86	27	115	1/4	1/4	64	20	40	10	102	17	65	20	18	12	15	58	11	M10 x 1.25	7
80	Up to 750	40	37	102	32	139	1/4	1/4	78	25	52	14	123	21	79.5	20	23	18	17	71	13	M12 x 1.75	10
100	Up to 750	40	37	116	41	160	1/4	1/4	92	30	52	14	144	21	93.5	22	25	20	19	72	16	M12 x 1.75	10

Bore size (mm)	KA	M	MM	N	P	S	T	V	ZZ
40	14	11	M14 x 1.5	27	1/4	153	37.5	9	255
50	18	11	M18 x 1.5	30	3/8	168	44	11	284
63	18	14	M18 x 1.5	31	3/8	182	52.5	12	298
80	22	17	M22 x 1.5	37	1/2	218	59.5	15	360
100	26	17	M26 x 1.5	40	1/2	246	69.5	15	390

Bore size (mm)	Stroke range (mm)	e	f	h	ℓ	ZZ (Single side)	ZZ (Both sides)
40	20 to 500	43	11.2	59	1/4 stroke	263	271
50	20 to 600	52	11.2	66	1/4 stroke	292	300
63	20 to 600	52	11.2	66	1/4 stroke	306	314
80	20 to 750	65	12.5	80	1/4 stroke	369	378
100	20 to 750	65	14	81	1/4 stroke	399	408

Axial foot (L): CNA2WL

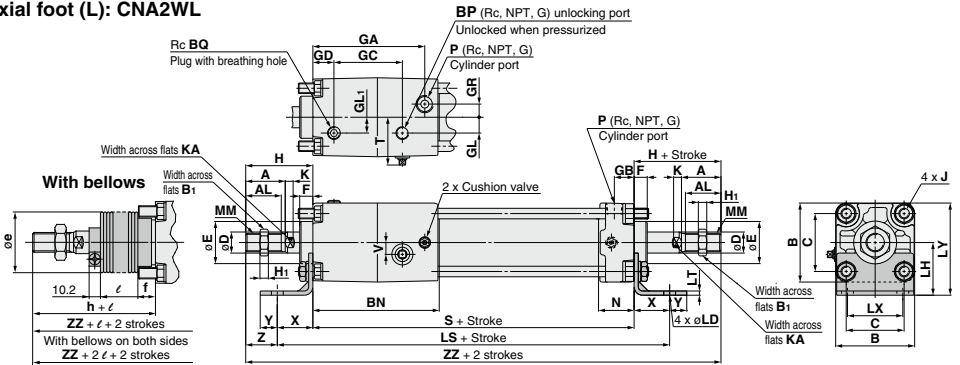

Bore size (mm)	Stroke range (mm)	A	AL	B	B ₁	BN	BP	BQ	C	D	E	F	GA	GB	GC	GD	GL	GL ₁	GR	H	H ₁	J	K	KA	LD	LH	LS
40	Up to 500	30	27	60	22	96	1/8	1/8	44	16	32	10	85	15	50	16	12	12	10	51	8	M8 x 1.25	6	14	9	40	207
50	Up to 600	35	32	70	27	108	1/4	1/8	52	20	40	10	95	17	56	20	13	15	12	58	11	M8 x 1.25	7	18	9	45	222
63	Up to 600	35	32	86	27	115	1/4	1/4	64	20	40	10	102	17	65	20	18	12	15	58	11	M10 x 1.25	7	18	11.5	50	250
80	Up to 750	40	37	102	32	139	1/4	1/4	78	25	52	14	123	21	79.5	20	23	18	17	71	13	M12 x 1.75	10	22	13.5	65	306
100	Up to 750	40	37	116	41	160	1/4	1/4	92	30	52	14	144	21	93.5	22	25	20	19	72	16	M12 x 1.75	10	26	13.5	75	332

Bore size (mm)	LT	LX	LY	MM	N	P	S	T	V	X	Y	ZZ
40	3.2	42	70	M14 x 1.5	27	1/4	153	37.5	9	27	13	255
50	3.2	50	80	M18 x 1.5	30	3/8	168	44	11	27	13	284
63	3.2	59	93	M18 x 1.5	31	3/8	182	52.5	12	34	16	298
80	4.5	76	116	M22 x 1.5	37	1/2	218	59.5	15	44	16	360
100	6.0	92	133	M26 x 1.5	40	1/2	246	69.5	15	43	17	390

Bore size (mm)	Stroke range (mm)	e	f	h	ℓ	ZZ (Single side)	ZZ (Both sides)
40	20 to 500	43	11.2	59	1/4 stroke	263	271
50	20 to 600	52	11.2	66	1/4 stroke	292	300
63	20 to 600	52	11.2	66	1/4 stroke	306	314
80	20 to 750	65	12.5	80	1/4 stroke	369	378
100	20 to 750	65	14	81	1/4 stroke	399	408

Cylinder with Lock Double Acting, Double Rod **CNA2W Series**

Dimensions

Rod flange (F): CNA2W/F

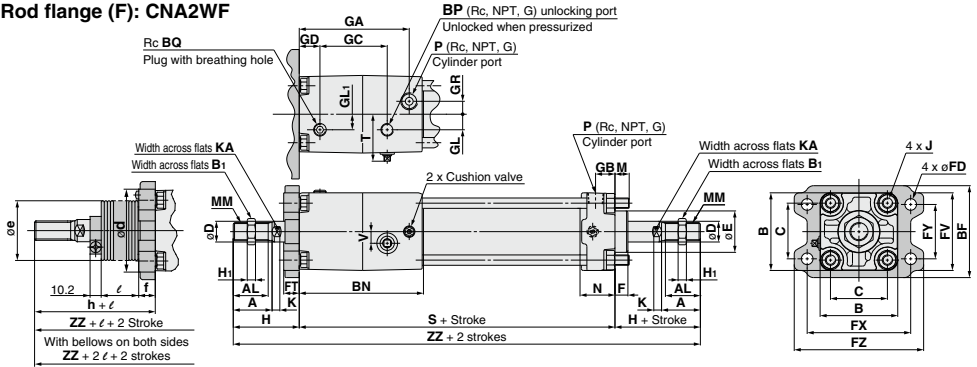

ø50 to ø100 Long stroke 1001 stroke or longer

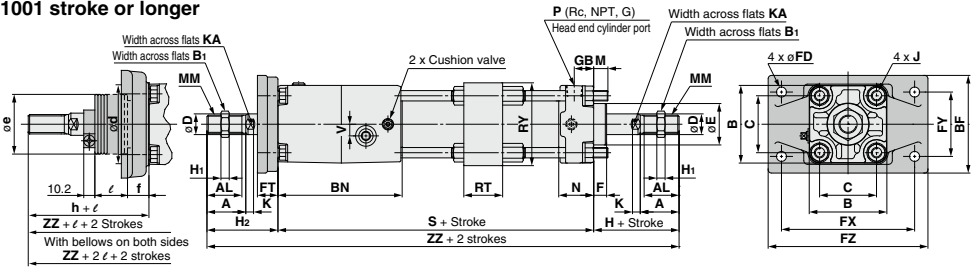

CNA2W Series

Dimensions

Center trunnion (T): CNA2WT

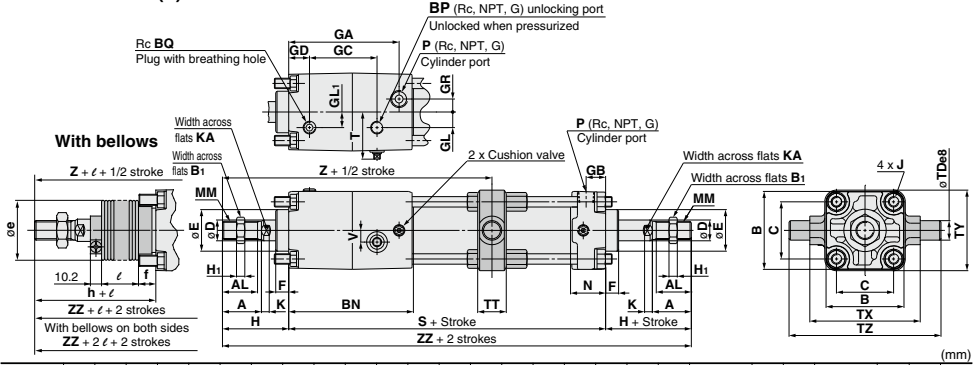

Bore size (mm)	A	AL	B	B ₁	BN	BP	BQ	C	D	E	F	GA	GB	GC	GD	GL	GL ₁	GR	H	H ₁	J	K	KA	MM	N	P	S
40	30	27	60	22	96	1/8	1/8	44	16	32	10	85	15	50	16	12	12	10	51	8	M8 x 1.25	6	14	M14 x 1.5	27	1/4	153
50	35	32	70	27	108	1/4	1/8	52	20	40	10	95	17	56	20	13	15	12	58	11	M8 x 1.25	7	18	M18 x 1.5	30	3/8	168
63	35	32	86	27	115	1/4	1/4	64	20	40	10	102	17	65	20	18	12	15	58	11	M10 x 1.25	7	18	M18 x 1.5	31	3/8	182
80	40	37	102	32	139	1/4	1/4	78	25	52	14	123	21	79.5	20	23	18	17	71	13	M12 x 1.75	10	22	M22 x 1.5	37	1/2	218
100	40	37	116	41	160	1/4	1/4	92	30	52	14	144	21	93.5	22	25	20	19	72	16	M12 x 1.75	10	26	M26 x 1.5	40	1/2	246

(mm)

Bore size (mm)	T	TD _{es}	TT	TX	TY	TZ	V	Z	ZZ
40	37.5	15 ^{+0.032} _{-0.069}	22	85	62	117	9	162	255
50	44	15 ^{+0.032} _{-0.069}	22	95	74	127	11	181	284
63	52.5	18 ^{+0.032} _{-0.069}	28	110	90	148	12	191	298
80	59.5	25 ^{+0.040} _{-0.079}	34	140	110	192	15	231	360
100	69.5	25 ^{+0.040} _{-0.079}	40	162	130	214	15	255	390

(mm)

Bore size (mm)	e	f	h	ℓ	Z (Single side)	ZZ (Single side)	Z (Both sides)	ZZ (Both sides)
40	43	11.2	59	1/4 stroke	170	263	170	271
50	52	11.2	66	1/4 stroke	189	292	189	300
63	52	11.2	66	1/4 stroke	199	306	199	314
80	65	12.5	80	1/4 stroke	240	369	240	378
100	65	14	81	1/4 stroke	264	399	264	408

Auto Switch Mounting 1

Auto Switch Proper Mounting Position (Detection at Stroke End) and Mounting Height

<Band mounting>

D-B5□/B64
D-B59W

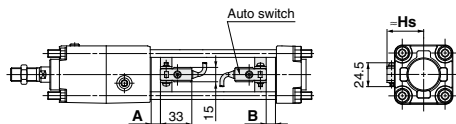

D-A3□
D-G39/K39

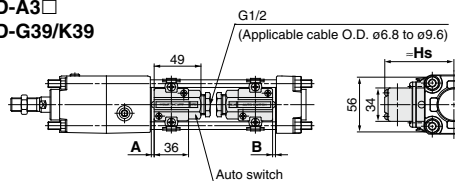

D-G5□/K59
D-G5□W/K59W
D-G5BA
D-G59F/G5NT

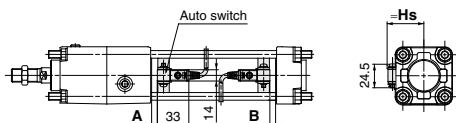

D-A44

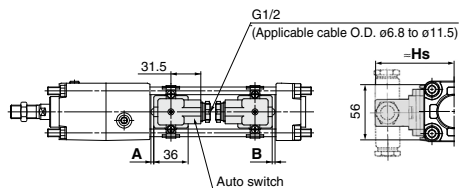

<Tie-rod mounting>

D-M9□/M9□V
D-M9□W/M9□WV
D-M9□A/M9□AV
D-A9□/A9□V
D-Z7□/Z80
D-Y59□/Y69□/Y7P/Y7PV
D-Y7□W/Y7□WV
D-Y7BA

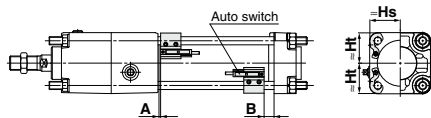

D-A5□/A6□ D-A59W

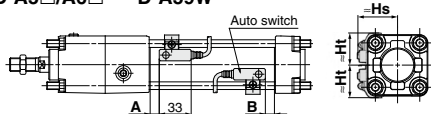

D-A3□C D-G39C/K39C

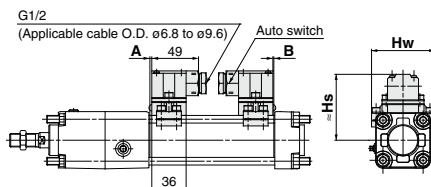

D-F5□/J59 D-F5□W/J59W
D-F5NT D-F5BA/F59F

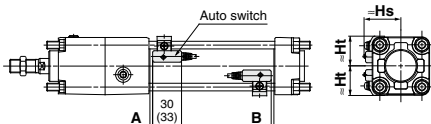

* (): Value of the D-F59F

D-A44C

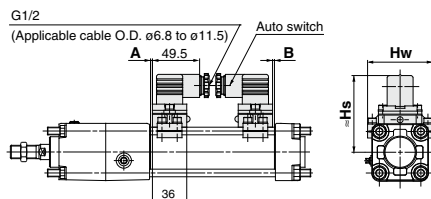

D-P3DWA



D-P4DW

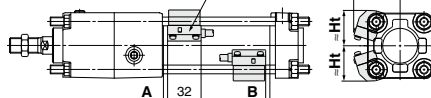

Auto Switch Proper Mounting Position (Detection at Stroke End) and Mounting Height

Auto Switch Proper Mounting Position

(mm)

Bore size (mm)	D-M9□ D-M9□V D-M9□W D-M9□WV D-M9□A D-M9□AV		D-A9□ D-A9□V		D-B59W D-Z7□ D-Z80 D-Y59□ D-Y69□ D-Y7P D-Y7PV D-Y7□WV D-Y7BA		D-P3DWA		D-P4DW		D-A5□ D-A6□ D-A3□ D-A3□C D-A44 D-A44C D-G39 D-G39C D-K39 D-K39C		D-B5□ D-B64		D-F5□ D-J59 D-F59F D-F5□W D-J59W D-F5BA		D-G5□ D-K59 D-G5NT D-G5□W D-K59W D-G5BA D-G59F		D-A59W		D-F5NT	
	A	B	A	B	A	B	A	B	A	B	A	B	A	B	A	B	A	B	A	B	A	B
40	10	8	6	4	4	1	5.5	3.5	3.5	0.5	0.5	0	1	0	7	4	2.5	0	4.5	1.5	12	9
50	10	8	6	4	3.5	1.5	5.5	3.5	3	1	0	0	0.5	0	6.5	4.5	2	0	4	2	11.5	9.5
63	12.5	11.5	8.5	7.5	6	5	8	7	5.5	4.5	2.5	1.5	3	2	9	8	4.5	3.5	6.5	5.5	14	13
80	16	14	12	10	9.5	7.5	11.5	9.5	9	7	6	4	6.5	4.5	12.5	10.5	8	6	10	8	17.5	15.5
100	17.5	16.5	13.5	12.5	11	10	13	12	10.5	9.5	7.5	6.5	8	7	14	13	9.5	8.5	11.5	10.5	19	18

Note) Adjust the auto switch after confirming the operating conditions in the actual setting.

Auto Switch Mounting Height

(mm)

Bore size (mm)	D-M9□ D-M9□W D-M9□A D-A9□		D-M9□V D-M9□WV D-M9□AV		D-A9□V		D-Z7□ D-Z80 D-Y59□ D-Y7P D-Y7BA D-Y7□W		D-Y69□ D-Y7PV D-Y7□WV		D-P3DWA		D-P4DW		D-B5□ D-B64 D-B59W D-G5□ D-K59 D-G5NT D-K59W D-G5BA D-G59F		D-A3□ D-G39 D-K39		D-A44		D-A5□ D-A6□ D-A59W	
	Hs	Ht	Hs	Ht	Hs	Ht	Hs	Ht	Hs	Ht	Hs	Ht	Hs	Ht	Hs	Hs	Hs	Hs	Hs	Ht	Hs	Ht
40	30	30	34	30	31	30	30	30	30	30	37.5	35	42.5	33	37	71.5	81.5	81.5	81.5	42	38.5	31.5
50	34	34	38	34	35	34	34	34	34	41.5	39	46.5	37.5	42	76.5	86.5	86.5	86.5	42	35.5	35.5	
63	41	41	44	41	41.5	41	41	41	41	50	41	52	43	49	83.5	93.5	93.5	93.5	46.5	43	43	
80	49.5	49	52.5	49	50	49	49.5	49	49.5	49	58	49	58.5	51.5	57.5	92	102	102	53.5	51	51	
100	56.5	56	61	56	58.5	56	56.5	55.5	57.5	55.5	66	56	66	58.5	68	102.5	112.5	112.5	61.5	57.5	57.5	

Bore size (mm)	D-F5□ D-J59 D-F5□W D-J59W D-F5BA D-F59F D-F5NT		D-A3□C D-G39C D-K39C		D-A44C	
	Hs	Ht	Hs	Hw	Hs	Hw
40	38	31.5	73	69	81	69
50	42	35.5	78.5	77	86.5	77
63	47	43	85.5	91	93.5	91
80	53.5	51	94	107	102	107
100	61	57.5	104	121	112	121

Minimum Stroke for Auto Switch Mounting

n: Number of auto switches (mm)

Auto switch model	Number of auto switches mounted	Mounting brackets other than center trunnion	Center trunnion					
			ø40	ø50	ø63	ø80	ø100	
D-A9□	2 (Different surfaces, Same surface), 1	15	75		90	100	110	
	n	$15 + 40 \frac{(n-2)}{2}$ (n = 2, 4, 6, 8, ...) Note 1)	$75 + 40 \frac{(n-4)}{2}$ (n = 4, 8, 12, 16, ...) Note 2)		$90 + 40 \frac{(n-4)}{2}$ (n = 4, 8, 12, 16, ...) Note 2)	$100 + 40 \frac{(n-4)}{2}$ (n = 4, 8, 12, 16, ...) Note 2)	$110 + 40 \frac{(n-4)}{2}$ (n = 4, 8, 12, 16, ...) Note 2)	
D-A9□V	2 (Different surfaces, Same surface), 1	10	75		90	100	110	
	n	$10 + 30 \frac{(n-2)}{2}$ (n = 2, 4, 6, 8, ...) Note 1)	$75 + 30 \frac{(n-4)}{2}$ (n = 4, 8, 12, 16, ...) Note 2)		$90 + 30 \frac{(n-4)}{2}$ (n = 4, 8, 12, 16, ...) Note 2)	$100 + 30 \frac{(n-4)}{2}$ (n = 4, 8, 12, 16, ...) Note 2)	$110 + 30 \frac{(n-4)}{2}$ (n = 4, 8, 12, 16, ...) Note 2)	
D-M9□ D-M9□W D-M9□A	2 (Different surfaces, Same surface), 1	15	80		95	110	115	
	n	$15 + 40 \frac{(n-2)}{2}$ (n = 2, 4, 6, 8, ...) Note 1)	$80 + 40 \frac{(n-4)}{2}$ (n = 4, 8, 12, 16, ...) Note 2)		$95 + 40 \frac{(n-4)}{2}$ (n = 4, 8, 12, 16, ...) Note 2)	$110 + 40 \frac{(n-4)}{2}$ (n = 4, 8, 12, 16, ...) Note 2)	$115 + 40 \frac{(n-4)}{2}$ (n = 4, 8, 12, 16, ...) Note 2)	
D-M9□V D-M9□WV D-M9□AV	2 (Different surfaces, Same surface), 1	10	80		95	110	115	
	n	$10 + 30 \frac{(n-2)}{2}$ (n = 2, 4, 6, 8, ...) Note 1)	$80 + 30 \frac{(n-4)}{2}$ (n = 4, 8, 12, 16, ...) Note 2)		$95 + 30 \frac{(n-4)}{2}$ (n = 4, 8, 12, 16, ...) Note 2)	$110 + 30 \frac{(n-4)}{2}$ (n = 4, 8, 12, 16, ...) Note 2)	$115 + 30 \frac{(n-4)}{2}$ (n = 4, 8, 12, 16, ...) Note 2)	
D-A5□/A6□ D-F5□/J5□ D-F5□W/J59W D-F5BA/F59F	2 (Different surfaces, Same surface), 1	15	90		100	110	120	
	n (Same surface)	$15 + 55 \frac{(n-2)}{2}$ (n = 2, 4, 6, 8, ...) Note 1)	$90 + 55 \frac{(n-4)}{2}$ (n = 4, 8, 12, 16, ...) Note 2)		$100 + 55 \frac{(n-4)}{2}$ (n = 4, 8, 12, 16, ...) Note 2)	$110 + 55 \frac{(n-4)}{2}$ (n = 4, 8, 12, 16, ...) Note 2)	$120 + 55 \frac{(n-4)}{2}$ (n = 4, 8, 12, 16, ...) Note 2)	
D-A59W	2 (Different surfaces, Same surface), 1	20	90		100	110	120	
	n (Same surface)	$20 + 55 \frac{(n-2)}{2}$ (n = 2, 4, 6, 8, ...) Note 1)	$90 + 55 \frac{(n-4)}{2}$ (n = 4, 8, 12, 16, ...) Note 2)		$100 + 55 \frac{(n-4)}{2}$ (n = 4, 8, 12, 16, ...) Note 2)	$110 + 55 \frac{(n-4)}{2}$ (n = 4, 8, 12, 16, ...) Note 2)	$120 + 55 \frac{(n-4)}{2}$ (n = 4, 8, 12, 16, ...) Note 2)	
	1	15	90		100	110	120	
D-F5NT	2 (Different surfaces, Same surface), 1	25	110		120	130	140	
	n (Same surface)	$25 + 55 \frac{(n-2)}{2}$ (n = 2, 4, 6, 8, ...) Note 1)	$110 + 55 \frac{(n-4)}{2}$ (n = 4, 8, 12, 16, ...) Note 2)		$120 + 55 \frac{(n-4)}{2}$ (n = 4, 8, 12, 16, ...) Note 2)	$130 + 55 \frac{(n-4)}{2}$ (n = 4, 8, 12, 16, ...) Note 2)	$140 + 55 \frac{(n-4)}{2}$ (n = 4, 8, 12, 16, ...) Note 2)	
D-B5□/B64 D-G5□/K59 D-G5□W D-K59W D-G5BA D-G59F D-G5NT	2 Different surfaces	15		90	100		110	
	Same surface	75		90			110	
	n	Different surfaces	$15 + 50 \frac{(n-2)}{2}$ (n = 2, 4, 6, 8, ...) Note 1)		$90 + 50 \frac{(n-4)}{2}$ (n = 4, 8, 12, 16, ...) Note 2)	$100 + 50 \frac{(n-4)}{2}$ (n = 4, 8, 12, 16, ...) Note 2)		$110 + 50 \frac{(n-4)}{2}$ (n = 4, 8, 12, 16, ...) Note 2)
		Same surface	$75 + 50 (n-2)$ (n = 2, 3, 4, ...)		$90 + 50 (n-2)$ (n = 2, 4, 6, 8, ...) Note 1)	$100 + 50 (n-2)$ (n = 2, 4, 6, 8, ...) Note 1)		$110 + 50 (n-2)$ (n = 2, 4, 6, 8, ...) Note 1)
	1	10		90	100		110	
D-B59W	2 Different surfaces	20		90	100		110	
	Same surface	75		90			110	
	n	Different surfaces	$20 + 50 \frac{(n-2)}{2}$ (n = 2, 4, 6, 8, ...) Note 1)		$90 + 50 \frac{(n-4)}{2}$ (n = 4, 8, 12, 16, ...) Note 2)	$100 + 50 \frac{(n-4)}{2}$ (n = 4, 8, 12, 16, ...) Note 2)		$110 + 50 \frac{(n-4)}{2}$ (n = 4, 8, 12, 16, ...) Note 2)
		Same surface	$75 + 50 (n-2)$ (n = 2, 3, 4, ...)		$90 + 50 (n-2)$ (n = 2, 4, 6, 8, ...) Note 1)	$100 + 50 (n-2)$ (n = 2, 4, 6, 8, ...) Note 1)		$110 + 50 (n-2)$ (n = 2, 4, 6, 8, ...) Note 1)
	1	15		90	100		110	
D-A3□ D-G39 D-K39	2 Different surfaces	35		100	100		110	
	Same surface	100		100			110	
	n	Different surfaces	$35 + 30 (n-2)$ (n = 2, 3, 4, ...)		$100 + 30 (n-2)$ (n = 2, 4, 6, 8, ...) Note 1)	$100 + 30 (n-2)$ (n = 2, 4, 6, 8, ...) Note 1)		$110 + 30 (n-2)$ (n = 2, 4, 6, 8, ...) Note 1)
		Same surface	$100 + 100 (n-2)$ (n = 2, 3, 4, ...)		$100 + 100 (n-2)$ (n = 2, 4, 6, 8, ...) Note 1)	$100 + 100 (n-2)$ (n = 2, 4, 6, 8, ...) Note 1)		$110 + 100 (n-2)$ (n = 2, 4, 6, 8, ...) Note 1)
	1	10		100	100		110	
D-A44	2 Different surfaces	35		100	100		110	
	Same surface	55		100			110	
	n	Different surfaces	$35 + 30 (n-2)$ (n = 2, 3, 4, ...)		$100 + 30 (n-2)$ (n = 2, 4, 6, 8, ...) Note 1)	$100 + 30 (n-2)$ (n = 2, 4, 6, 8, ...) Note 1)		$110 + 30 (n-2)$ (n = 2, 4, 6, 8, ...) Note 1)
		Same surface	$55 + 50 (n-2)$ (n = 2, 3, 4, ...)		$100 + 50 (n-2)$ (n = 2, 4, 6, 8, ...) Note 1)	$100 + 50 (n-2)$ (n = 2, 4, 6, 8, ...) Note 1)		$110 + 50 (n-2)$ (n = 2, 4, 6, 8, ...) Note 1)
1	10		100	100		110		

Note 1) When "n" is an odd number, an even number that is one larger than this odd number is used for the calculation.
 Note 2) When "n" is an odd number, a multiple of 4 that is larger than this odd number is used for the calculation.

Minimum Stroke for Auto Switch Mounting

n: Number of auto switches (mm)

Auto switch model	Number of auto switches mounted	Mounting brackets other than center trunnion	Center trunnion				
			ø40	ø50	ø63	ø80	ø100
D-A3□C D-G39C D-K39C	2	Different surfaces	20				
		Same surface	100				
	n	Different surfaces	$20 + 35(n-2)$ (n = 2, 3, 4, ...)	$100 + 35(n-2)$ (n = 2, 4, 6, 8, ...) <small>Note 1</small>	$100 + 35(n-2)$ (n = 2, 4, 6, 8, ...) <small>Note 1</small>	$120 + 35(n-2)$ (n = 2, 4, 6, 8, ...) <small>Note 1</small>	$120 + 35(n-2)$ (n = 2, 4, 6, 8, ...) <small>Note 1</small>
		Same surface	$100 + 100(n-2)$ (n = 2, 3, 4, 5-...)	$100 + 100(n-2)$ (n = 2, 4, 6, 8, ...) <small>Note 1</small>	$100 + 100(n-2)$ (n = 2, 4, 6, 8, ...) <small>Note 1</small>	$120 + 100(n-2)$ (n = 2, 4, 6, 8, ...) <small>Note 1</small>	$120 + 100(n-2)$ (n = 2, 4, 6, 8, ...) <small>Note 1</small>
	1	10	100	100	100	120	
D-A44C	2	Different surfaces	20				
		Same surface	55				
	n	Different surfaces	$20 + 35(n-2)$ (n = 2, 3, 4, ...)	$100 + 35(n-2)$ (n = 2, 4, 6, 8, ...) <small>Note 1</small>	$100 + 35(n-2)$ (n = 2, 4, 6, 8, ...) <small>Note 1</small>	$120 + 35(n-2)$ (n = 2, 4, 6, 8, ...) <small>Note 1</small>	$120 + 35(n-2)$ (n = 2, 4, 6, 8, ...) <small>Note 1</small>
		Same surface	$55 + 50(n-2)$ (n = 2, 3, 4, ...)	$100 + 50(n-2)$ (n = 2, 4, 6, 8, ...) <small>Note 1</small>	$100 + 50(n-2)$ (n = 2, 4, 6, 8, ...) <small>Note 1</small>	$120 + 50(n-2)$ (n = 2, 4, 6, 8, ...) <small>Note 1</small>	$120 + 50(n-2)$ (n = 2, 4, 6, 8, ...) <small>Note 1</small>
	1	10	100	100	100	120	
D-Z7□/Z80 D-Y59□/Y7P D-Y7□W	2 (Different surfaces, Same surface), 1	15	80	85	90	95	105
	n	$15 + 40 \frac{(n-2)}{2}$ (n = 2, 4, 6, 8-...) <small>Note 1</small>	$80 + 40 \frac{(n-4)}{2}$ (n = 4, 8, 12, 16-...) <small>Note 2</small>	$85 + 40 \frac{(n-4)}{2}$ (n = 4, 8, 12, 16-...) <small>Note 2</small>	$90 + 40 \frac{(n-4)}{2}$ (n = 4, 8, 12, 16-...) <small>Note 2</small>	$95 + 40 \frac{(n-4)}{2}$ (n = 4, 8, 12, 16-...) <small>Note 2</small>	$105 + 40 \frac{(n-4)}{2}$ (n = 4, 8, 12, 16-...) <small>Note 2</small>
D-Y69□/Y7PV D-Y7□WV	2 (Different surfaces, Same surface), 1	10	65		75	80	90
	n	$10 + 30 \frac{(n-2)}{2}$ (n = 2, 4, 6, 8-...) <small>Note 1</small>	$65 + 30 \frac{(n-4)}{2}$ (n = 4, 8, 12, 16-...) <small>Note 2</small>		$75 + 30 \frac{(n-4)}{2}$ (n = 4, 8, 12, 16-...) <small>Note 2</small>	$80 + 30 \frac{(n-4)}{2}$ (n = 4, 8, 12, 16-...) <small>Note 2</small>	$90 + 30 \frac{(n-4)}{2}$ (n = 4, 8, 12, 16-...) <small>Note 2</small>
D-Y7BA	2 (Different surfaces, Same surface), 1	20	95		100	105	110
	n	$20 + 45 \frac{(n-2)}{2}$ (n = 2, 4, 6, 8-...) <small>Note 1</small>	$95 + 45 \frac{(n-4)}{2}$ (n = 4, 8, 12, 16-...) <small>Note 2</small>		$100 + 45 \frac{(n-4)}{2}$ (n = 4, 8, 12, 16-...) <small>Note 2</small>	$105 + 45 \frac{(n-4)}{2}$ (n = 4, 8, 12, 16-...) <small>Note 2</small>	$110 + 45 \frac{(n-4)}{2}$ (n = 4, 8, 12, 16-...) <small>Note 2</small>
D-P3DWA	2 (Different surfaces, Same surface), 1	15	85			95	100
	n	$15 + 50 \frac{(n-2)}{2}$ (n = 2, 4, 6, 8-...) <small>Note 1</small>	$85 + 50 \frac{(n-4)}{2}$ (n = 4, 8, 12, 16-...) <small>Note 2</small>			$95 + 50 \frac{(n-4)}{2}$ (n = 4, 8, 12, 16-...) <small>Note 2</small>	$100 + 50 \frac{(n-4)}{2}$ (n = 4, 8, 12, 16-...) <small>Note 2</small>
D-P4DW	2 (Different surfaces, Same surface), 1	15	120		130	140	
	n	$15 + 65 \frac{(n-2)}{2}$ (n = 2, 4, 6, 8-...) <small>Note 1</small>	$120 + 65 \frac{(n-4)}{2}$ (n = 4, 8, 12, 16-...) <small>Note 2</small>		$130 + 65 \frac{(n-4)}{2}$ (n = 4, 8, 12, 16-...) <small>Note 2</small>	$140 + 65 \frac{(n-4)}{2}$ (n = 4, 8, 12, 16-...) <small>Note 2</small>	

Note 1) When "n" is an odd number, an even number that is one larger than this odd number is used for the calculation.

Note 2) When "n" is an odd number, a multiple of 4 that is larger than this odd number is used for the calculation.

Operating Range

Auto switch model	Bore size					(mm)
	40	50	63	80	100	
D-M9□/M9□V D-M9□W/M9□WV D-M9□A/M9□AV	4.5	5	5.5	5	6	
D-A9□/A9□V D-Z7□/Z80	7.5	8.5	9.5	9.5	10.5	
D-A3□/A44 D-A3□C/A44C	9	10	11	11	11	
D-A5□/A6□ D-B5□/B64						
D-A59W D-B59W	13	13	14	14	15	
D-Y59□/Y69□ D-Y7P/Y7□V D-Y7□W/Y7□WV D-Y7BA	8	7	5.5	6.5	6.5	

Auto switch model	Bore size					(mm)
	40	50	63	80	100	
D-F5□/J59/F59F D-F5□W/J59W D-F5BA/F5NT	4	4	4.5	4.5	4.5	
D-G5□/K59/G59F D-G5□W/K59W D-G5NT/G5BA	5	6	6.5	6.5	7	
D-G5NB D-G39/K39 D-G39C/K39C	35	35	40	40	40	
D-P3DWA D-P4DW	4.5	4.5	5.5	5.5	5.5	
	4	4	4.5	4	4.5	

* Since this is a guideline including hysteresis, not meant to be guaranteed. (assuming approximately ±30% dispersion)
There may be the case it will vary substantially depending on the ambient environment.

Auto Switch Mounting Bracket/Part No.

<Tie-rod mounting>

Auto switch model	Bore size (mm)				
	ø40	ø50	ø63	ø80	ø100
D-M9□/M9□V D-M9□W/M9□WV D-M9□A/M9□AV D-A9□/A9□V	BA7-040	BA7-040	BA7-063	BA7-080	BA7-080
D-A5□/A6□/A59W D-F5□/J59/F5□W/J59W D-F5NT/F5BA/F59F	BT-04	BT-04	BT-06	BT-08	BT-08
D-A3□C/A44C/G39C/K39C	BA3-040	BA3-050	BA3-063	BA3-080	BA3-100
D-Z7□/Z80 D-Y59□/Y69□ D-Y7P/Y7PV D-Y7□W/Y7□WV D-Y7BA	BA4-040	BA4-040	BA4-063	BA4-080	BA4-080
D-P3DWA D-P4DW	BK7-040S BAP2-040	BK7-040S BAP2-040	BA10-063S BAP2-063	BA10-080S BAP2-080	BA10-080S BAP2-080

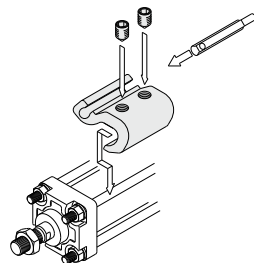

* The above figure shows the mounting example of the D-A9□(V)/M9□(V)/M9□W(V)/M9□AV.

<Band mounting>

Auto switch model	Bore size (mm)				
	40	50	63	80	100
D-A3□/A44 D-G39/K39	BDS-04M	BDS-05M	BMB1-063	BMB1-080	BMB1-100
D-B5□/B64 D-B59W D-G5□/K59 D-G5□W/K59W D-G59F D-G5NT D-G5NB	BH2-040	BA5-050	BAF-06	BAF-08	BAF-10

* Auto switch mounting bracket is attached to the D-A3□C/A44C/G39C/K39C.

To order, indicate as shown below, according to the cylinder size.

(Example) ø40: D-A3□C-4, ø50: D-A3□C-5

ø63: D-A3□C-6, ø80: D-A3□C-8, ø100: D-A3□C-10

To order the auto switch mounting bracket separately, use the part number as shown above.

[Mounting screw set made of stainless steel]

The following mounting screw set made of stainless steel (including set screw) is available. Use it in accordance with the operating environment. (Order the auto switch mounting bracket and band separately, since they are not included.)

BBA1: For D-A5/A6/F5/J5 types

BBA3: For D-B5/B6/G5/K5 types

The D-F5BA/G5BA auto switches are set on the cylinder with the stainless steel screws above when shipped. When an auto switch is shipped independently, the BBA1 or BBA3 is attached.

Note 1) Refer to pages 1439 and 1447 for details about the BBA1 and BBA3.

Note 2) When using the D-M9□A/D-M9□AV/Y7BA, do not use the steel set screws included in the auto switch mounting brackets above (BA7-□□□, BA4-□□□).

Order a stainless steel screw set (BBA1) separately, and select and use the M4 x 6L stainless steel set screws included in the BBA1.

CNA2 Series

Other than the applicable auto switches listed in "How to Order", the following auto switches can be mounted. For detailed specifications, refer to pages 1341 to 1435.

Auto switch type	Model	Electrical entry	Features
Reed	D-A93V, A96V	Grommet (Perpendicular)	—
	D-A90V		Without indicator light
	D-A53, A56, B53, Z73, Z76	Grommet (In-line)	—
	D-A67, Z80		Without indicator light
Solid state	D-M9NV, M9PV, M9BV	Grommet (Perpendicular)	—
	D-Y69A, Y69B, Y7PV		Diagnostic indication (2-color indicator)
	D-M9NWV, M9PWV, M9BWW		Water resistant (2-color indicator)
	D-Y7NWV, Y7PWV, Y7BWW		—
	D-M9NAV, M9PAV, M9BAV	Grommet (In-line)	Diagnostic indication (2-color indicator)
	D-Y59A, Y59B, Y7P		Water resistant (2-color indicator)
	D-F59, F5P, J59		—
	D-Y7NW, Y7PW, Y7BW		Diagnostic indication (2-color indicator)
	D-F59W, F5PW, J59W		Water resistant (2-color indicator)
	D-F5BA, Y7BA		With timer
	D-F5NT, G5NT		Magnetic field resistant (2-color indicator)
	D-P4DW, P5DW		

* With pre-wired connector is available for solid state auto switches. For details, refer to pages 1410 and 1411.

* Normally closed (NC = b contact) solid state auto switches (D-M9□E(V)/Y7G/Y7H) are also available. For details, refer to pages 1360 and 1362.



CNA2 Series

Specific Product Precautions 1

Be sure to read this before handling the products.

Refer to page 9 for safety instructions and pages 10 to 19 for actuator and auto switch precautions.

Design of Equipment and Machinery

⚠ Warning

1. Construct so that the human body will not come into direct contact with driven objects or the moving parts of locking cylinders.

Devise a safe structure by attaching protective covers that prevent direct contact with the human body, or in cases where there is a danger of contact, provide sensors or other devices to perform an emergency stop, etc., before contact occurs.

2. Use a balance circuit, taking cylinder lurching into consideration.

In cases such as an intermediate stop, where a lock is operated at a desired position within the stroke and air pressure is applied from only one side of the cylinder, the piston will lurch at high speed when the lock is released. In such situations, there is a danger of causing human injury by having hands or feet, etc., caught, and also a danger for causing damage to the equipment. In order to prevent this lurching, a balance circuit such as the recommended pneumatic circuits (pages 790 and 791) should be used.

Selection

⚠ Warning

1. When in the locked state, do not apply a load accompanied by an impact shock, strong vibration or turning force, etc.

Use caution, because an external action such as an impacting load, strong vibration or turning force, may damage the locking mechanism or reduce its life.

2. Consider stopping accuracy and the amount of overrun when an intermediate stop is performed.

Due to the nature of a mechanical lock, there is a momentary lag with respect to the stop signal, and a time delay occurs before stopping. The cylinder stroke resulting from this delay is the overrun amount. The difference between the maximum and minimum overrun amounts is the stopping accuracy.

- Place a limit switch before the desired stopping position, at a distance equal to the overrun amount.
- The limit switch must have a detection length (dog length) of the overrun amount + α .
- For SMC's auto switches, the operating range is between 4 and 40 mm. (It varies depending on a switch model.) When the overrun amount exceeds this range, self-holding of the contact should be performed at the auto switch load side

* For stopping accuracy, refer to page 763.

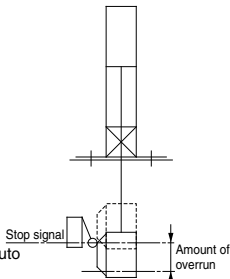

3. In order to further improve stopping accuracy, the time from the stop signal to the operation of the lock should be shortened as much as possible.

To accomplish this, use a device such as a highly responsive electric control circuit or solenoid valve driven by direct current, and place the solenoid valve as close as possible to the cylinder.

Selection

⚠ Warning

4. Note that the stopping accuracy will be influenced by changes in piston speed.

When piston speed changes during the course of the cylinder stroke due to variations in the load or disturbances, etc., the dispersion of stopping positions will increase. Therefore, consideration should be given to establishing a standard speed for the piston just before it reaches the stopping position.

Moreover, the dispersion of stopping positions will increase during the cushioned portion of the stroke and during the accelerating portion of the stroke after the start of operation, due to the large changes in piston speed.

5. The holding force (max. static load) indicates the maximum capability to hold a static load without loads, vibration and impact. This does not indicate a load that can be held in ordinary conditions.

Select the most suitable bore sizes for the operating conditions in accordance with the selection procedures. The Model Selection (pages 760 and 761) is based on use at the intermediate stop (including emergency stops during the operation). However, when the cylinder is in a locked state, kinetic energy does not act upon it. Under these conditions, use the load weight at the maximum speed (V) of 100 mm/s shown in Chart (5) to (7) on page 761 depending on the operating pressure and select models.

Mounting

⚠ Warning

1. Be certain to connect the rod end to the load with the lock released.

• If connected in the locked state, a load greater than the turning force or holding force, etc., may operate on the piston rod and cause damage to the lock mechanism. The CNA2 series is equipped with an emergency unlocking mechanism; however, when connecting the rod end to the load, this should be done with the lock released. This can be accomplished by simply connecting an air line to the unlocking port and supplying air pressure of 0.25 MPa or more.

⚠ Caution

1. Do not apply offset loads to the piston rod.

Particular care should be taken to match the load's center of gravity with the center of the cylinder shaft. When there is a large discrepancy, the piston rod may be subjected to uneven wear or damage due to the inertial moment during locking stops.

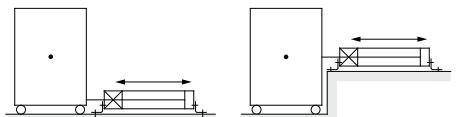

- × Load center of gravity and cylinder shaft center are not matched.
- Load center of gravity and cylinder shaft center are matched.

(Note) Can be used if all of the generated moment is absorbed by an effective guide.



CNA2 Series Specific Product Precautions 2

Be sure to read this before handling the products.
Refer to page 9 for safety instructions and pages 10 to 19 for actuator and auto switch precautions.

Mounting

⚠ Caution

2. Caution when using the basic type or replacing the mounting bracket.

The lock unit and cylinder rod cover are assembled as shown in the figure below. For this reason, it cannot be installed as in the case of common air cylinders, by using the basic type and screwing the cylinder tie-rods directly to machinery. Furthermore, when replacing mounting brackets, the unit holding tie-rods may get loosen. Tighten them once again in such a case. Use a socket wrench for replacing the mounting bracket or tightening the unit holding tie-rod.

Bore size (mm)	Mounting bracket nut		Unit holding tie-rod		
	Nut	Width across flats	Socket	Width across flats	
40, 50	JIS B 1181 Class 3 M8 x 1.25	13	JIS B 4636 socket 13	10	JIS B 4636 socket 10
				13	JIS B 4636 socket 13
63	JIS B 1181 Class 3 M10 x 1.25	17	JIS B 4636 socket 17	13	JIS B 4636 socket 13
80, 100	JIS B 1181 Class 3 M12 x 1.25	19	JIS B 4636 socket 19	17	JIS B 4636 socket 17

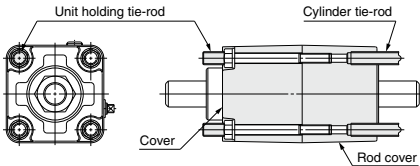

Adjustment

⚠ Caution

- Adjust air balance for cylinder. Balance the load by adjusting the air pressure in the cylinder rod end and head end after the lock is released when the load is mounted on cylinder. When you have this air balance, cylinder ejection at lock release can be avoided.
- Adjust mounting position for detection area of auto switch, etc. When intermediate stop is done, adjust the mounting position for detection area of auto switch, etc., with consideration of overrun distance to required stop position.

Operating Precautions

⚠ Caution

- Do not open the cushion valve beyond the stopper.**
A retaining ring is installed as a cushion valve retention mechanism. Do not open the cushion valve beyond it. If not operated in accordance with the above precautions, the cushion valve may be ejected from the cover when air pressure is supplied.

Bore size (mm)	Width across flats	Hexagon wrench
40,50	2.5	JIS 4648 Hexagon wrench key 2.5
63,80,100	4	JIS 4648 Hexagon wrench key 4

- Use the air cushion at the end of cylinder stroke.**
Otherwise, the tie-rod or piston rod assembly will be damaged.

⚠ Caution

- Do not rotate the piston rod when the rod boot is fixed.**
Before rotating the piston rod, loosen the band to avoid twisting the rod boot.
- Install the rod boot with the breathing hole facing downwards or in a direction suitable to prevent dust, moisture etc. from entering easily into the rod boot.**

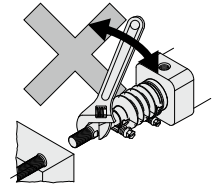

Pneumatic Circuit

⚠ Warning

- Be certain to use an pneumatic circuit which will apply balancing pressure to both sides of the piston when in a locked stop.**

In order to prevent cylinder lurching after a lock stop, when restarting or when manually unlocking, a circuit should be used to which will apply balancing pressure to both sides of the piston, thereby canceling the force generated by the load in the direction of piston movement.

- The effective area of the lock release solenoid valve should be at least 50% of the effective area of the cylinder driving solenoid valve, and it should be installed as close to the cylinder as possible so that it is closer than the cylinder driving solenoid valve.**

If the effective area of the lock release solenoid valve is smaller than the cylinder driving solenoid valve or if it is installed at a distance from the cylinder, the time required for exhausting air for releasing the lock will be longer, which may cause a delay in the locking operation.

The delay in the locking operation may result in problems such as increase of overrun when performing intermediate stop or emergency stop during operation, or if maintaining position from the operation stop state such as drop prevention, workpieces may be dropped depending on the timing of the load action to the operation delay of the lock.



CNA2 Series Specific Product Precautions 3

Be sure to read this before handling the products.
Refer to page 9 for safety instructions and pages 10 to 19 for actuator and auto switch precautions.

Pneumatic Circuit

Warning

- Avoid backflow of the exhaust pressure when there is a possibility of interference of exhaust air, for example for a common exhaust type valve manifold.**

The lock may not operate properly when the exhaust air pressure backflows due to interference of the exhaust air when exhausting air for lock release. It is recommended to use an individual exhaust type manifold or individual valves.

- Allow at least 0.5 seconds from a locked stop (intermediate stop of the cylinder) until release of the lock.**

When the locked stop time is too short, the piston rod (and load) may lurch at a speed greater than the control speed of the speed controller.

- When restarting, control the switching signal for the unlocking solenoid valve so that it acts before or at the same time as the cylinder drive solenoid valve.**

If the signal is delayed, the piston rod (and load) may lurch at a speed greater than the control speed of the speed controller.

- Carefully check for dew condensation due to repeated air supply and exhaust of the locking solenoid valve.**

The operating stroke of the lock part is very small. So, if the piping is long and the air supply and exhaust are repeated, the dew condensation caused by the adiabatic expansion accumulates in the lock part. This may corrode internal parts, causing air leak or lock release fault.

7. Basic circuit

1. [Horizontal]

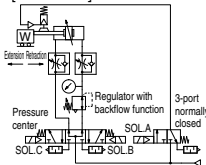

SOLA	SOLB	SOLC	Action	Time
ON	ON	OFF	Extension	0.5 s or more
OFF	OFF	OFF	Locked stop	0 to 0.5 s
ON	ON	OFF	Unlocked	0 to 0.5 s
ON	OFF	ON	Retraction	0.5 s or more
OFF	OFF	OFF	Locked stop	0 to 0.5 s
ON	OFF	OFF	Unlocked	0.5 s or more
ON	OFF	ON	Retraction	0 to 0.5 s

2. [Vertical]

[Load in the direction of rod extension]

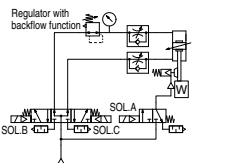

[Load in the direction of rod retraction]

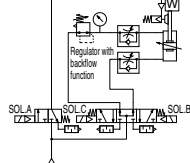

* The symbol for the cylinder with lock in the basic circuit uses SMC original symbol.

Caution

- 3-position pressure center solenoid valve and regulator with backflow function can be replaced with two 3-port normally open valves and a regulator with relief function.**

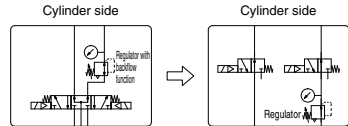

[Example]

1. [Horizontal]

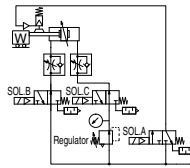

2. [Vertical]

[Load in the direction of rod extension]

[Load in the direction of rod retraction]

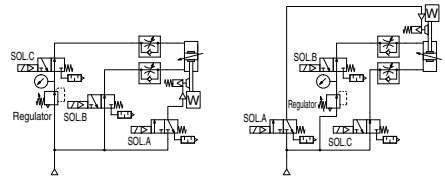

* The symbol for the cylinder with lock in the pneumatic circuit uses SMC original symbol.



CNA2 Series

Specific Product Precautions 4

Be sure to read this before handling the products.

Refer to page 9 for safety instructions and pages 10 to 19 for actuator and auto switch precautions.

Manually Unlocking

Warning

1. Never operate the unlocking cam until safety has been confirmed. (Do not turn to the FREE side.)
 - When unlocking is performed with air pressure applied to only one side of the cylinder, the moving parts of the cylinder will lurch at high speed causing a serious hazard.
 - When unlocking is performed, be sure to confirm that personnel are not within the load movement range and that no other problems will occur if the load moves.
2. Before operating the unlocking cam, exhaust any residual pressure which is in the system.
3. Take measures to prevent the load from dropping when unlocking is performed.
 - Perform work with the load in its lowest position.
 - Take measures for drop prevention by strut, etc.

Caution

1. The unlocking cam is an emergency unlocking mechanism only. During an emergency when the air supply is stopped or cut off, this is used to alleviate a problem by forcibly pushing back the release piston and brake spring to release the lock.
2. When installing the cylinder into equipment or performing adjustments, etc., be sure to apply air pressure of 0.25 MPa or more to the unlocking port, and do not perform work using the unlocking cam.
3. When releasing the lock with the unlocking cam, it must be noted that the internal resistance of the cylinder will be high, unlike normally unlocking with air pressure.

Bore size (mm)	Cylinder internal resistance (N)	Cam operating torque (guide) (N·m)	Width across flats dimension (mm)
40	108	5.9	5
50	275	11.8	6
63	432	12.8	7
80	686	20.6	7
100	765	23.5	9

4. Be sure to operate the unlocking cam (the arrow or mark on the head part of the unlocking cam) on the FREE side and do not turn with a torque greater than the maximum cam operating torque. There is a danger of damaging the unlocking cam if it is turned excessively.
5. For safety reasons, the unlocking cam is constructed so that it cannot be fixed in the unlocked state.

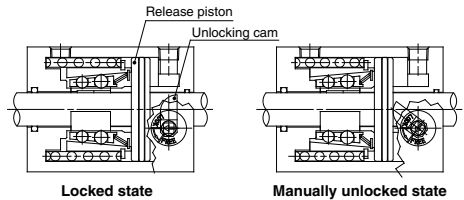

[Principle]

If the unlocking cam is turned counterclockwise with a tool such as an adjustable angle wrench, the release piston is pushed back and the lock is released. Since the lever will return to its original position when released and become locked again, it should be held in this position for as long as unlocking is needed.



CNA2 Series Specific Product Precautions 5

Be sure to read this before handling the products.
Refer to page 9 for safety instructions and pages 10 to 19 for actuator and auto switch precautions.

Maintenance

⚠ Caution

1. Never disassemble the lock unit.

It is very dangerous to disassemble the lock unit of the CNA2 series because it has a strong spring installed inside, so never disassemble the lock unit. Replace the lock unit if the seal or other internal parts need to be replaced.

2. Lock unit model

To order the CNA2 series lock units for maintenance, use the order numbers given in the below table.

How to Order

CNA2 - 40 TN D - UA

Bore size (mm) ↓

Port type	
Nil	Rc port
TN	NPT port
TF	G port

Locking direction
(Both directions)

Suffix	
Nil	Standard
L*	For long stroke

* The lock unit for long stroke is applicable only to the flange type with 1001 stroke or longer whose bore size is $\phi 50$ to $\phi 100$.
(Example: CNA2-100D-UAL)

2. How to replace lock units

1) Loosen the tie-rod nuts (4 pcs.) on the cylinder head cover side by using a socket wrench.

For applicable socket, refer to the below table.

Bore size (mm)	Nut	Width across flats dimension	Socket
40, 50	JIS B 1181 Class 2 M8 x 1.25	13	JIS B 4636 socket 13
63	JIS B 1181 Class 2 M10 x 1.25	17	JIS B 4636 socket 17
80, 100	JIS B 1181 Class 2 M12 x 1.75	19	JIS B 4636 socket 19

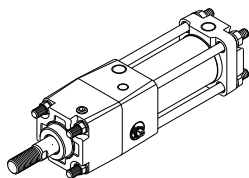

2) Remove the tie-rods, head cover and cylinder tube.

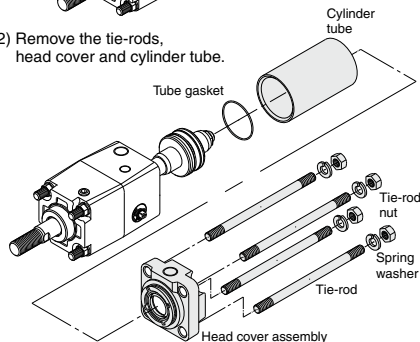

3) Apply 0.3 MPa or more of compressed air to the unlocking port, and pull out the piston rod assembly.

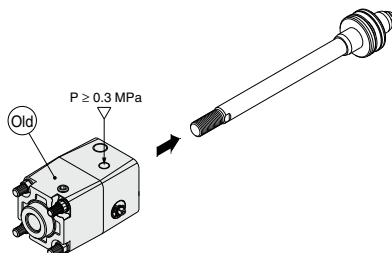

4) Similarly, apply 0.3 MPa or more of compressed air to the unlocking port of the new lock unit, and replace the new lock unit's temporary axis with the previous piston rod assembly.

Note) Be sure to keep applying compressed air with a pressure of at least 0.3 MPa to the lock releasing port when replacing the temporary rod of a new lock unit with a piston rod assembly.

If the compressed air applied to the lock releasing port is released (when it is in the lock condition) while the temporary rod and the piston rod assembly are removed from the lock unit, the brake shoe will be deformed and it will become impossible to insert the piston rod assembly, which will make the lock unit impossible to use.

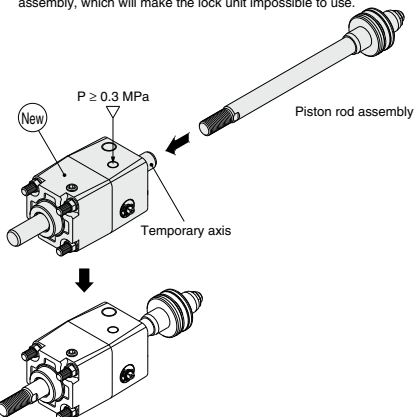

5) Reassemble in reverse order from step 2) to 1).

Disassembly/Replacement

⚠ Caution

1. Do not disassemble the trunnion type cylinder, as it requires accuracy in assembly.

For the trunnion type cylinder, it is difficult to align the axial center of the trunnion with that of the cylinder. If the trunnion type cylinder is disassembled and reassembled, the specified dimensional accuracy cannot be obtained, causing malfunction. So, it is recommended to ask SMC for repair.