

**2-Color Display**

# Digital Flow Switch



**Applicable fluid** Dry air, N<sub>2</sub>, Ar, CO<sub>2</sub>

**IO-Link**<sup>\*1</sup>  
\*1 For the PF2M7-L

A wide range of flow measurement is possible with 1 product.

**Flow ratio**<sup>\*2</sup> **100:1** \*2 Excludes the PF2M725 \*3 Made to order (Produced upon receipt of order)

Port size	Flow range [L/min]											Smallest settable increment				
	0.02	0.01	0.05	0.1	0.3	0.5	1	2	3	5	10		25	50	100	200
PF2M701							1									0.001
PF2M702								2								0.01
PF2M705									5							
PF2M710										10						0.1
PF2M725											25					
PF2M750												50				1
PF2M711													100			
New PF2M721															200	1

## IO-Link Compatible

The flow rate value and the device status can be figured out easily via the process data.

PF2M7-L Series [p. 4](#)

<b>Diagnosis items</b>	Over current error, Outside of rated flow range, Accumulated flow error, Internal product malfunction
<b>Made to order</b>	Compatible with argon (Ar) and carbon dioxide (CO <sub>2</sub> ) mixed gas <a href="#">p. 26</a>

## Improved resistance to moisture and foreign matter [p. 1](#)

The bypass construction reduces sensor accuracy deterioration and damage.

\* There is no bypass construction for the 1 and 2 L ranges.



**New**

A 2 to 200 L/min flow range option has been added.



A rear ported type has been added.



A flow adjustment valve (0.05 to 5 L/min) has been added.



# PF2M7(-L) Series



CAT.ES100-127C

### Improved resistance to moisture and foreign matter

The bypass construction reduces the moist air or foreign matter in contact with the sensor, reducing sensor accuracy deterioration and damage.

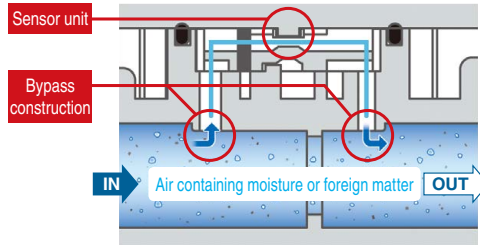

\* There is no bypass construction for the 1 and 2 L ranges.

### Compact, Lightweight

**Weight 27.3% lighter** (55 g → 40 g)

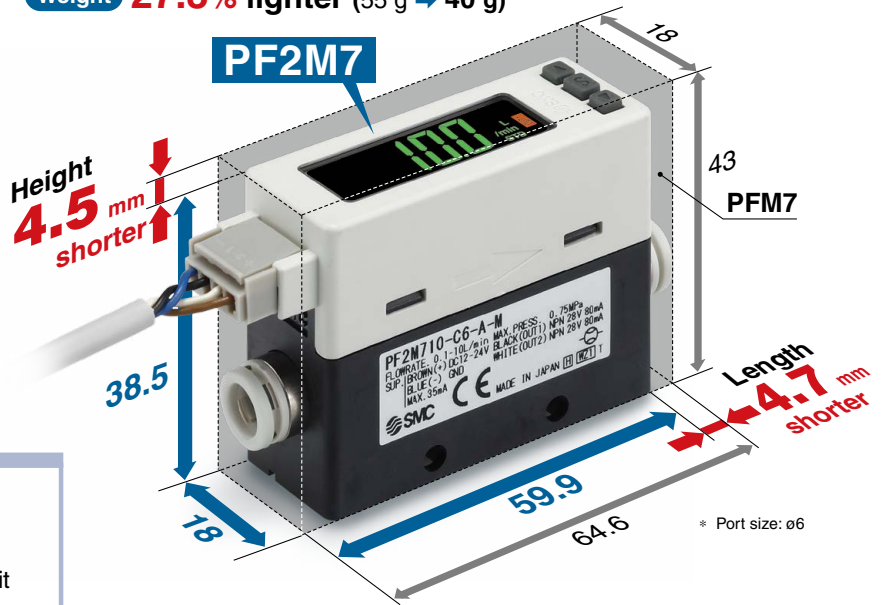

### Reversible display mode

When the product is mounted upside down, the orientation of the display can be rotated to make it easier to read.

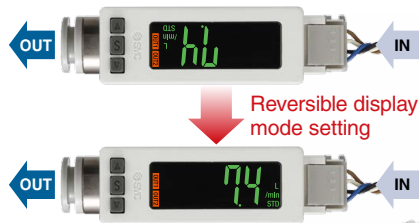

### A flow adjustment valve is integrated into the product.

- Space-saving design
- Reduced piping labor

Flow adjustment valve

### Piping variations

#### • One-touch fitting



Straight	ø4*, ø6, ø8, ø1/4"
<b>New</b> Rear ported	

#### • Female thread



Straight	(Rc, NPT, G) 1/8, 1/4
<b>New</b> Rear ported	

\* Made to order (Produced upon receipt of order)

### Display OFF mode



LEDs can be turned off and checked when necessary. The product can also be used as a remote sensor.

### Mounting variations

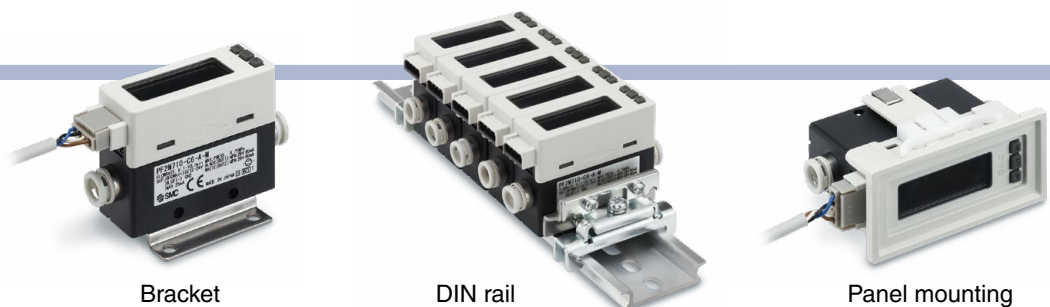

The digital display allows for the visualization of the flow rate.

2-color display, Improved visibility



Select a model according to the fluid to be used.



## Recommended pneumatic circuit examples

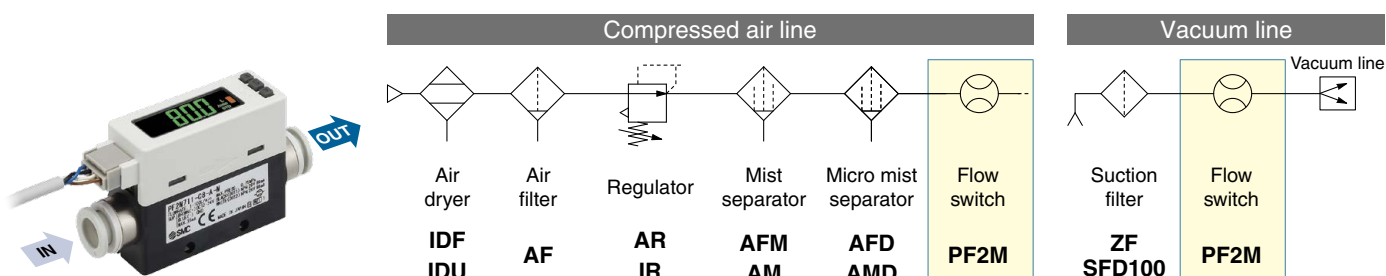

\* Recommended air quality class: JIS B 8392-1 1.1.2 to 1.6.2 (ISO 8753-1 1.1.2 to 1.6.2)

## Analog free span function

The analog span point (5 V (10 V), 20 mA) can be changed within 10 to 105% of the rated flow rate with respect to the displayed value.

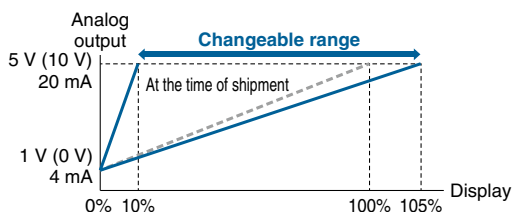

### Application example

When 5 V output is required from the flow switch at 75 L/min, use a sensor that outputs 1 to 5 V at 1 to 100 L/min.

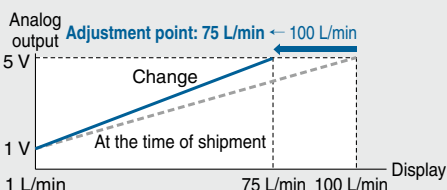

## Selectable analog output function

1 to 5 V or 0 to 10 V can be selected.

Low current consumption: **35 mA<sup>\*1</sup> or less**

\*1 PFM7: 55 mA or less

## Delay time setting

Can be set between 0 and 60 s

The delay time can be set according to the application.

## Grease-free

## Functions pp. 27, 28

Output operation	Key-lock function
Forced output function	Reset to the default settings
Analog free span function	Delay time setting
Display color	Error display function
Display OFF mode	Setting of a security code
Selectable analog output function	Display mode
Reference condition	Zero cut-off function
Peak/Bottom value display	Accumulated value hold
Reversible display mode	Simple setting mode
Digital filter setting	Zero-clear function

Power supply voltage: **12 to 24 V**

\* For the IO-Link device: 18 to 30 V

## Select a digital flow switch to increase energy savings!

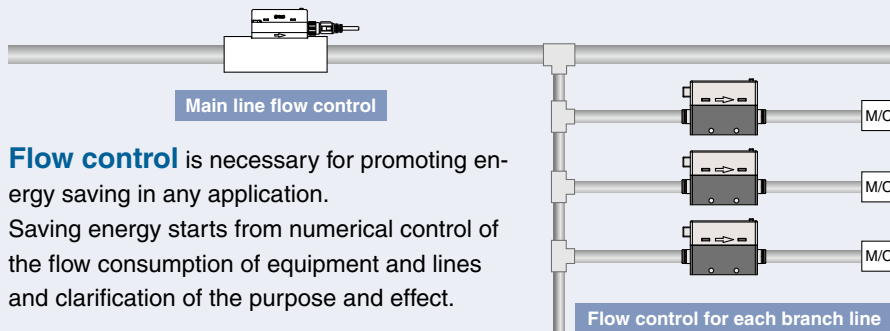

**Flow control** is necessary for promoting energy saving in any application. Saving energy starts from numerical control of the flow consumption of equipment and lines and clarification of the purpose and effect.

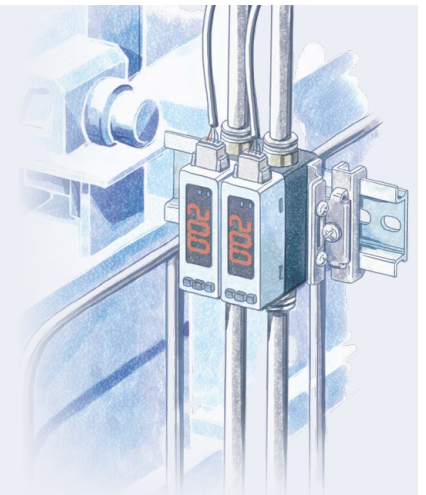

## Applications

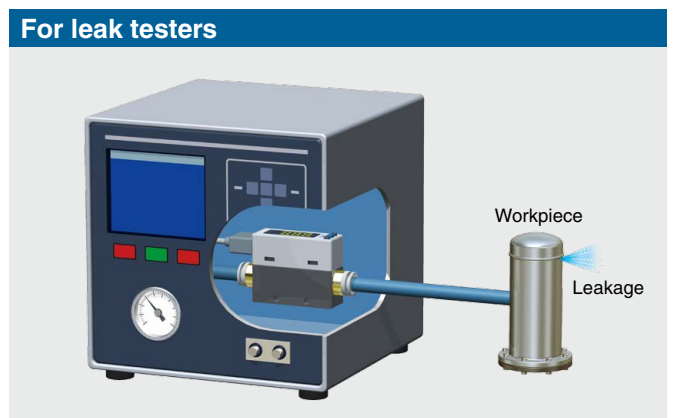
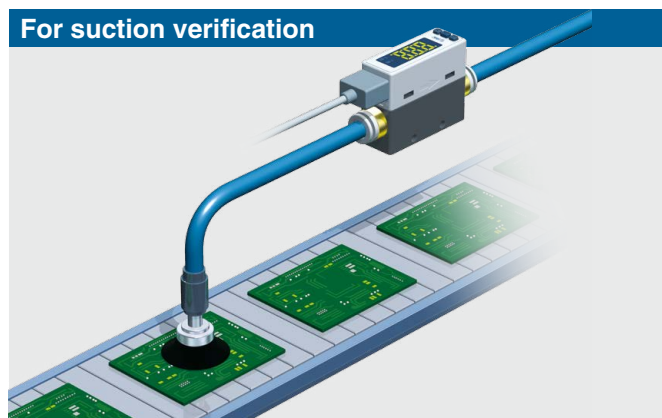
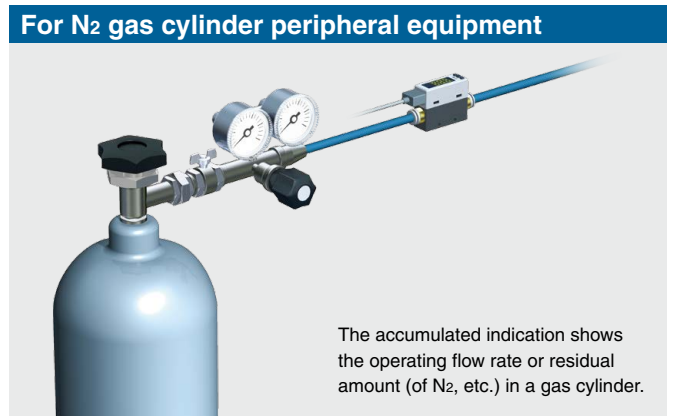
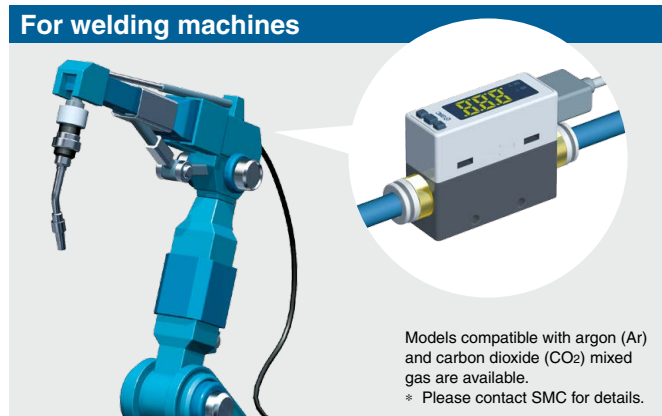
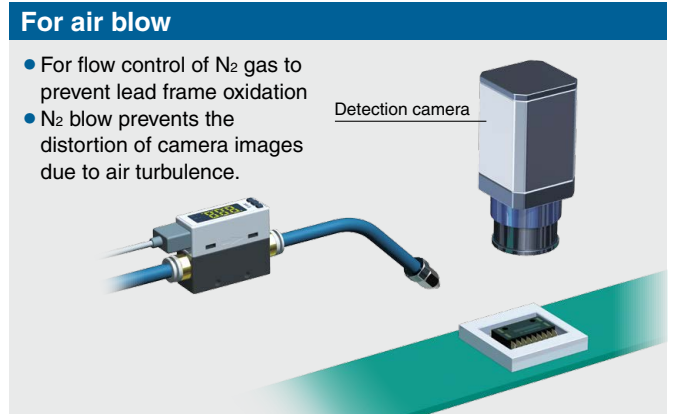
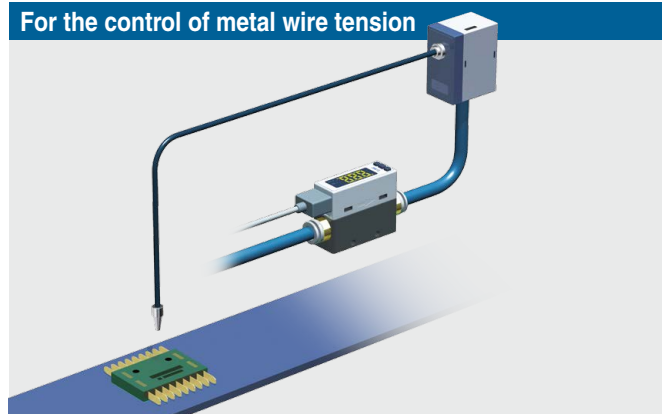

IO-Link Compatible PF2M7□□-□-L□-□□□

Supports the IO-Link communication protocol



IO-Link is an open communication interface technology between the sensor/ actuator and the I/O terminal that is an international standard: IEC61131-9.

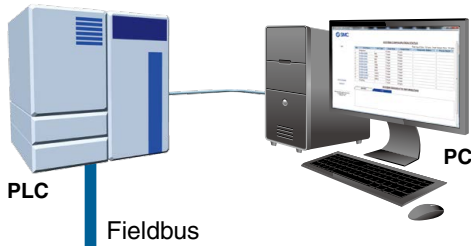

Configuration File (IODD File\*1)

- Manufacturer · Product part no.
- Set value

\*1 IODD File:  
IODD is an abbreviation of IO Device Description. This file is necessary for setting the device and connecting it to a master. Save the IODD file on the PC to be used to set the device prior to use.

Device settings can be set by the master.

- Threshold value
- Operation mode, etc.

Read the device data.

- Switch ON/OFF signal and analog value
- Device information: Manufacturer, Product part number, Serial number, etc.
- Normal or abnormal device status
- Cable breakage



IO-Link Compatible Device: Digital Flow Switch

Implement diagnostic bits in the process data.

The diagnostic bit in the cyclic process data makes it easy to find problems with the equipment. It is possible to find problems with the equipment in real time using the cyclic (periodic) data and to monitor such problems in detail with the noncyclic (aperiodic) data.

Process Data

Bit offset	Item	Note
0	OUT1 output	0: OFF 1: ON
1	OUT2 output	0: OFF 1: ON
8	Diagnosis (flow rate)	0: OFF 1: ON
14	Fixed output	0: OFF 1: ON
15	Diagnosis (error)	0: OFF 1: ON
16 to 31	Measured flow rate value	Signed 16 bit

Diagnosis items
· Over current error
· Outside of rated flow range
· Accumulated flow error
· Internal product malfunction

Bit offset	31	30	29	28	27	26	25	24	23	22	21	20	19	18	17	16
Item	Measured flow rate value (PD)															
Bit offset	15	14	13	12	11	10	9	8	7	6	5	4	3	2	1	0
Item	Error	Fixed	Reservation				Flow rate	Reservation				OUT2	OUT1			
	Diagnosis	Output					Diagnosis					Switch output				

Application Example

For the predictive maintenance of suction verification

The flow rate "switch ON/OFF signals" and "analog values" are monitored to determine the suction status. The process and suction status can then be compared.

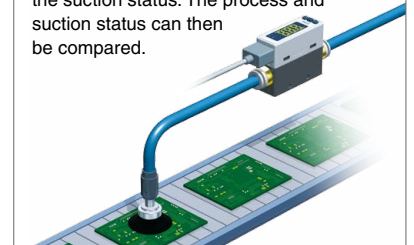







Operation and Display

Communication with master	IO-Link status indicator light	Status	Screen display*2	Description		
Yes	*1	Normal	Operate	oPE	Normal communication status (readout of measured value)	
			Start up	St r t		At the start of communication
			Preoperate	P r E		
No	*1 (Flashing)	Abnormal	Version does not match	E r 1 5	The IO-Link version does not match that of the master. The master uses version 1.0.	
			Communication disconnection	oPE	Normal communication was not received for 1 s or longer.	
				St r t		
				P r E		
	OFF	SIO mode	S i o	General switch output		

\*1 In IO-Link mode, the IO-Link indicator is ON or flashing.  
\*2 "LoC" is displayed when the data storage lock is enabled. (Except for when the version does not match or when in SIO mode)  
The display color can be set to red or green.

# Flow Switch Flow Rate Variations

Series	Applicable fluid	Detection method	Rated flow range [L/min]										
			-3	-2	-1	-0.5	0	0.5	1	2	3		
<b>PFMV</b> 	Dry air N <sub>2</sub>	Thermal type (MEMS)	0					0.5					
			0					1					
			0									3	
						-0.5			0.5				
							-1				1		

Series	Applicable fluid	Detection method	Smallest settable increment	Rated flow range [L/min]																								
				0.02	0.01	0.05	0.1	0.3	0.5	1	2	5	10	25	50	100	150	200	300	500	600	1000	2000	3000	6000	12000		
<b>PF2M7(-L)</b> 	Dry air N <sub>2</sub> Ar CO <sub>2</sub>	Thermal type (MEMS)	0.001 L/min	0.01	1																							
			0.01 L/min	0.02	2																							
				0.05	5																							
			0.1 L/min	0.1	10																							
				0.3	25																							
			1 L/min	0.5	50																							
	1	100																										
<b>PFMB</b> 	Dry air N <sub>2</sub>	Thermal type (MEMS)	1 L/min	2	200																							
				5	500																							
<b>PFMC(-L)</b> 	Dry air N <sub>2</sub>	Thermal type (MEMS)	1 L/min	10	1000																							
				20	2000																							
<b>PF2A</b> 	Air N <sub>2</sub>	Thermal type (Thermistor)	0.1 L/min	1	10																							
			0.5 L/min	5	50																							
			1 L/min	10	100																							
			2 L/min	20	200																							
			5 L/min	50	500																							
<b>PF3A□H(-L)</b>  Body ported type  Modular type	Air N <sub>2</sub>	Thermal type (Platinum sensor)	2 L/min	30	Body ported type	3000																						
			5 L/min	60	Body ported type	6000																						
			10 L/min	120	Body ported type	12000																						
			1 L/min	10	Modular type	1000																						
			2 L/min	20	Modular type	2000																						

# Flow Switch Variations / Basic Performance Table

Series	PFMV	PF2M7(-L)	PFMB	PFMC(-L)	PF2A	PF3A7□H(-L)
Enclosure	IP40	IP40	IP40	IP65 [Monitor unit IP40]	IP65	IP65 [Monitor unit IP40]
Fluid	Dry air, N <sub>2</sub>	Dry air, N <sub>2</sub> , Ar, CO <sub>2</sub>	Dry air, N <sub>2</sub>	Dry air, N <sub>2</sub>	Air, N <sub>2</sub>	Air, N <sub>2</sub>
Setting	Digital	Digital	Digital	Digital	Digital	Digital
Rated flow range [L/min]	0 to 0.5    -0.5 to 0.5 0 to 1       -1 to 1 0 to 3       -3 to 3	0.01 to 1 0.02 to 2 0.05 to 5 0.1 to 10 0.3 to 25 0.5 to 50 1 to 100 2 to 200	2 to 200    5 to 500 10 to 1000 20 to 2000	5 to 500 10 to 1000 20 to 2000	1 to 10 5 to 50 10 to 100 20 to 200 50 to 500	30 to 3000    10 to 1000 60 to 6000    20 to 2000 120 to 12000
Power supply voltage	12 to 24 VDC ±10%	PF2M7    12 to 24 VDC ±10% PF2M7-L 18 to 30 VDC ±10%	12 to 24 VDC ±10%	PFMC    12 to 24 VDC ±10% PFMC-L 18 to 30 VDC ±10%	12 to 24 VDC ±10%	PF3A7□H    24 VDC ±10% PF3A7□H-L 18 to 30 VDC ±10% PF3A701H/ 702H-L    21.6 to 30 VDC PF3A8□H-L 21.6 to 30 VDC
Temperature characteristics (25°C standard)	±2% F.S. (15 to 35°C)    [Monitor unit] ±5% F.S.        ±0.5% F.S. (0 to 50°C)     (0 to 50°C)	±3% F.S. ±1 digit (15 to 35°C) ±5% F.S. ±1 digit (0 to 50°C)	±2% F.S. (15 to 35°C)    [Monitor unit] ±5% F.S.        ±0.5% F.S. (0 to 50°C)     (0 to 50°C)	±2% F.S. (15 to 35°C)    [Monitor unit] ±5% F.S.        ±0.5% F.S. (0 to 50°C)     (0 to 50°C)	±3% F.S. (15 to 35°C) ±5% F.S. (0 to 50°C)	±5% F.S.    [Monitor unit] (0 to 50°C) ±0.5% F.S. (0 to 50°C)
Repeatability	±2% F.S. (Fluid: Dry air)    [Monitor unit] Analog output:    ±0.1% F.S. ±5% F.S.            Analog output: ±0.3% F.S.	±1% F.S. ±1 digit (Fluid: Dry air)	±1% F.S.    [Monitor unit] (Fluid: Dry air) ±0.1% F.S.	±1% F.S.    [Monitor unit] (Fluid: Dry air) ±0.1% F.S.	±1% F.S. (PF2A7□0) ±2% F.S. (PF2A7□1)	±1% F.S.    [Monitor unit] ±0.1% F.S.
Hysteresis	Hysteresis mode: Variable Window comparator mode: Variable	Hysteresis mode: Variable Window comparator mode: Variable	Hysteresis mode: Variable Window comparator mode: Variable	Hysteresis mode: Variable Window comparator mode: Variable	Hysteresis mode: Variable Window comparator mode: Fixed (3 digits)	Hysteresis mode: Variable Window comparator mode: Variable
Output	NPN/PNP open collector Analog voltage output Analog current output	NPN/PNP open collector Accumulated pulse output Analog voltage output Analog current output IO-Link	NPN/PNP open collector Accumulated pulse output Analog voltage output Analog current output	NPN/PNP open collector Accumulated pulse output Analog voltage output Analog current output IO-Link	NPN/PNP open collector Accumulated pulse output	NPN/PNP open collector Accumulated pulse output Analog voltage output Analog current output IO-Link
Display	[Monitor unit 2-color LCD display]	2-color LCD display	2-color LED display    2-color LCD display [Monitor unit 3-color LCD display]	3-color LCD display	LED display	3-color LCD display

\* The monitor unit values are for the PFG300 and PFMV3.





# CONTENTS

## **2-Color Display** Digital Flow Switch *PF2M7(-L) Series*

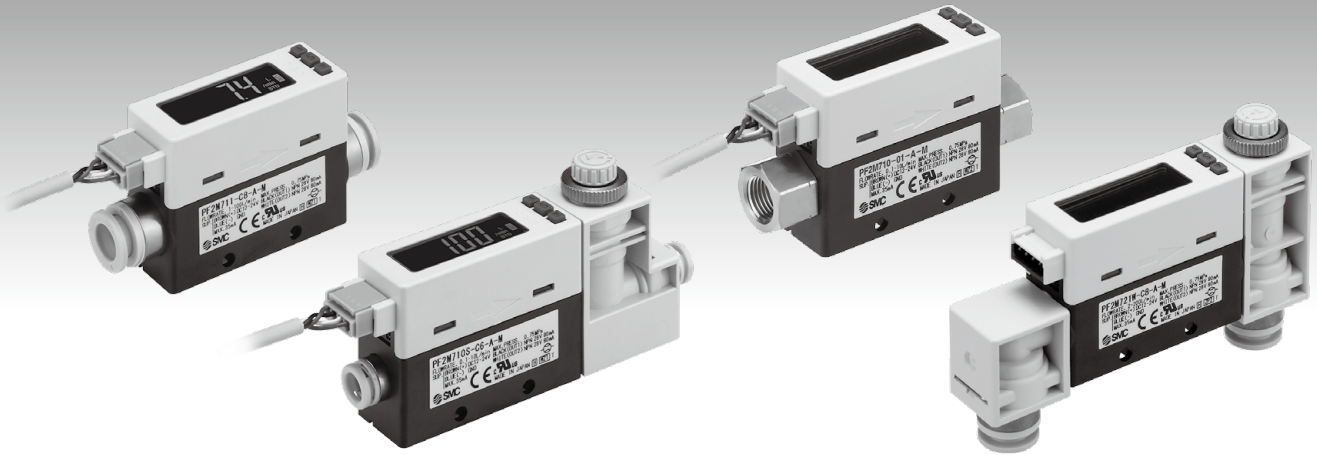

How to Order .....	p. 9
Specifications .....	p. 11
Set Point Range and Rated Flow Range .....	p. 13
Flow/Analog Output .....	p. 13
Pressure Loss (Reference Data): Without Flow Adjustment Valve .....	p. 14
Flow Rate Characteristics (Reference Data) .....	p. 14
Flow Rate Characteristics at Negative Pressure (Reference Data) .....	p. 15
Internal Circuits and Wiring Examples .....	p. 16
Construction: Parts in Contact with Fluid .....	p. 18
Dimensions .....	p. 19
Made to Order .....	p. 26
Function Details .....	p. 27
Safety Instructions .....	Back cover

2-Color Display Digital Flow Switch

# PF2M7 Series

## How to Order

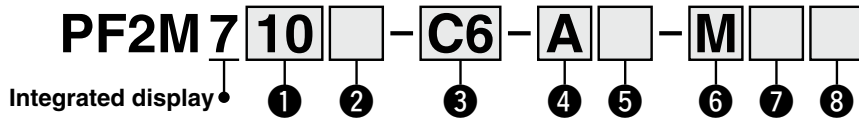

### 1 Rated flow range

01	0.01 to 1 L/min	25	0.2 to 25 L/min
02	0.02 to 2 L/min	50	0.5 to 50 L/min
05	0.05 to 5 L/min	11	1 to 100 L/min
10	0.1 to 10 L/min	21	2 to 200 L/min

### 2 Flow adjustment valve/Piping entry direction

Symbol	Flow adjustment valve	Piping entry direction	Rated flow range										
			1	2	5	10	25	50	100	200			
Nil	None	Straight	●	●	●	●	●	●	●	●	●	●	●
S	Yes	Straight	—	—	●	●	●	●	●	●	●	●	●
L	None	Rear ported	●	●	●	●	●	●	●	●	●	●	●
W	Yes	Rear ported	—	—	●	●	●	●	●	●	●	●	●

\* 1 and 2 L/min type products are not available with a flow adjustment valve.

### 3 Port size

Symbol	Port size	Rated flow range							
		1	2	5	10	25	50	100	200
01	Rc1/8	●	●	●	●	●	●	—	—
N1	NPT1/8	●	●	●	●	●	●	—	—
F1	G1/8	—	—	●	●	●	●	—	—
02	Rc1/4	—	—	—	—	—	—	●	●
N2	NPT1/4	—	—	—	—	—	—	●	●
F2	G1/4	—	—	—	—	—	—	●	●
C4*1	ø4	●	●	●	●	—	—	—	—
C6	ø6	●	●	●	●	●	●	—	—
C8	ø8	—	—	—	—	—	—	●	●
N7	ø1/4"	—	—	—	—	—	—	●	●

\*1 Made to order (Produced upon receipt of order)

### Piping variations

With One-touch fitting	Female thread
C4*2, C6, C8, N7	01, 02, N1, N2, F1, F2
Straight	Straight
Rear ported	Rear ported

\*2 Made to order (Produced upon receipt of order)

### 4 Output specification

Symbol	OUT1	OUT2
A	NPN	NPN
B	PNP	PNP
C	NPN	Analog 1 to 5 V ⇔ Analog 0 to 10 V*3
D	NPN	Analog 4 to 20 mA
E	PNP	Analog 1 to 5 V ⇔ Analog 0 to 10 V*3
F	PNP	Analog 4 to 20 mA

\*3 1 to 5 V or 0 to 10 V can be selected by pressing the button. The default setting is 1 to 5 V.

### 7 Option 2

Nil	R	S
Without bracket	Bracket (For the type without a flow adjustment valve) <b>ZS-33-M</b> With 2 tapping screws	Bracket (For the type with a flow adjustment valve) <b>ZS-33-MS</b> With 3 tapping screws
	* Interchangeable with the existing PFM series	* Interchangeable with the existing PFM series
T	V	
Panel mount adapter (For the type without a flow adjustment valve) <b>ZS-33-2J</b> Panel mount adapter Panel mount adapter B Panel	Panel mount adapter (For the type with a flow adjustment valve) <b>ZS-33-2JS</b> Panel mount adapter S Panel mount adapter B Panel	
Mounting bracket	Mounting bracket	

\* Options are shipped together with the product but do not come assembled.

### 5 Option 1

Nil	W
Lead wire with connector (2 m) <b>ZS-33-D</b>	Lead wire with connector (2 m) + Connector cover (Silicone rubber) <b>ZS-33-F</b> <b>ZS-33-D</b> +
* Interchangeable with the existing PFM7 series	* Interchangeable with the existing PFM7 series
N	
Without lead wire with connector	

### 6 Unit specification

M	SI unit only*4
Nil	Unit selection function*5

\*4 Fixed unit: Instantaneous flow: L/min  
Accumulated flow: L

\*5 This product is for overseas use only. (The SI unit type is provided for use in Japan in accordance with the New Measurement Act.) The unit can be changed.  
Instantaneous flow: L/min ⇔ cfm  
Accumulated flow: L ⇔ ft<sup>3</sup>

### 8 Calibration certificate\*6

Nil	None
A	Yes

\*6 Made to order. The certificate is in both English and Japanese.

### DIN Rail Mounting Bracket (To Be Ordered Separately)

#### ZS-33-R 3

Stations	
1	1 station
2	2 stations
3	3 stations
4	4 stations
5	5 stations

DIN rail part number: **AXT100-DR-□**

\* Refer to page 25 for the DIN rail mounting dimensions.

# PF2M7-L Series

## How to Order

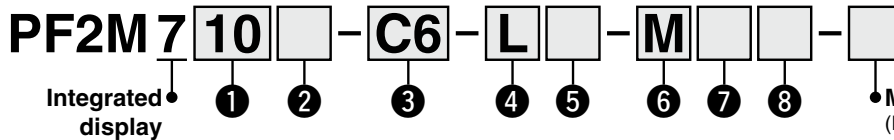

### 1 Rated flow range

01	0.01 to 1 L/min	25	0.2 to 25 L/min
02	0.02 to 2 L/min	50	0.5 to 50 L/min
05	0.05 to 5 L/min	11	1 to 100 L/min
10	0.1 to 10 L/min	21	2 to 200 L/min

### 2 Flow adjustment valve/Piping entry direction

Symbol	Flow adjustment valve	Piping entry direction	Rated flow range										
			1	2	5	10	25	50	100	200			
Nil	None	Straight	●	●	●	●	●	●	●	●	●	●	●
S	Yes	Straight	—	—	●	●	●	●	●	●	●	●	●
L	None	Rear ported	●	●	●	●	●	●	●	●	●	●	●
W	Yes	Rear ported	—	—	●	●	●	●	●	●	●	●	●

\* 1 and 2 L/min type products are not available with a flow adjustment valve.

### 3 Port size

Symbol	Port size	Rated flow range							
		1	2	5	10	25	50	100	200
01	Rc1/8	●	●	●	●	●	●	—	—
N1	NPT1/8	●	●	●	●	●	●	—	—
F1	G1/8	—	—	●	●	●	●	—	—
02	Rc1/4	—	—	—	—	—	—	●	●
N2	NPT1/4	—	—	—	—	—	—	●	●
F2	G1/4	—	—	—	—	—	—	●	●
C4*1	ø4	●	●	●	●	—	—	—	—
C6	ø6	●	●	●	●	●	●	—	—
C8	ø8	—	—	—	—	—	—	●	●
N7	ø1/4"	—	—	—	—	—	—	●	●

\*1 Made to order (Produced upon receipt of order)

### Piping variations

With One-touch fitting	Female thread
C4*2, C6, C8, N7	01, 02, N1, N2, F1, F2
Straight	Straight
Rear ported	Rear ported

\*2 Made to order (Produced upon receipt of order)

### 4 Output specification

Symbol	OUT1	OUT2
L	IO-Link/ NPN/PNP	—
L2	IO-Link/ NPN/PNP	NPN/PNP/External input
L3	IO-Link/ NPN/PNP	Analog 1 to 5 V ⇔ Analog 0 to 10 V*3
L4	IO-Link/ NPN/PNP	Analog 4 to 20 mA

\*3 1 to 5 V or 0 to 10 V can be selected by pressing the button. The default setting is 1 to 5 V.

### 6 Unit specification

M	SI unit only*4
Nil	Unit selection function*5

\*4 Fixed unit: Instantaneous flow: L/min  
Accumulated flow: L

\*5 This product is for overseas use only. (The SI unit type is provided for use in Japan in accordance with the New Measurement Act.)  
The unit can be changed.  
Instantaneous flow: L/min ⇔ cfm  
Accumulated flow: L ⇔ ft<sup>3</sup>

### 5 Option 1

Nil	W
Lead wire with connector (2 m)	Lead wire with connector (2 m) + Connector cover (Silicone rubber)
ZS-33-D	ZS-33-F ZS-33-D +
* Interchangeable with the existing PFM7 series	* Interchangeable with the existing PFM7 series
N	Q
Without lead wire with connector	M12 conversion lead wire (0.1 m)

### 8 Calibration certificate\*6

Nil	None
A	Yes

\*6 Made to order  
The certificate is in both English and Japanese.

### Made to Order

Symbol	Specification
X731	Compatible with argon (Ar) and carbon dioxide (CO <sub>2</sub> ) mixed gas

For details, refer to page 26.

### 7 Option 2

Nil	R	S
Without bracket	Bracket (For the type without a flow adjustment valve) <b>ZS-33-M</b>	Bracket (For the type with a flow adjustment valve) <b>ZS-33-MS</b>
	With 2 tapping screws	With 3 tapping screws
	* Interchangeable with the existing PFM series	* Interchangeable with the existing PFM series
T	V	
Panel mount adapter (For the type without a flow adjustment valve) <b>ZS-33-2J</b>	Panel mount adapter (For the type with a flow adjustment valve) <b>ZS-33-2JS</b>	
Panel mount adapter B	Panel mount adapter S	
Mounting bracket	Mounting bracket	

\* Options are shipped together with the product but do not come assembled.

### DIN Rail Mounting Bracket (To Be Ordered Separately)

Refer to page 9.

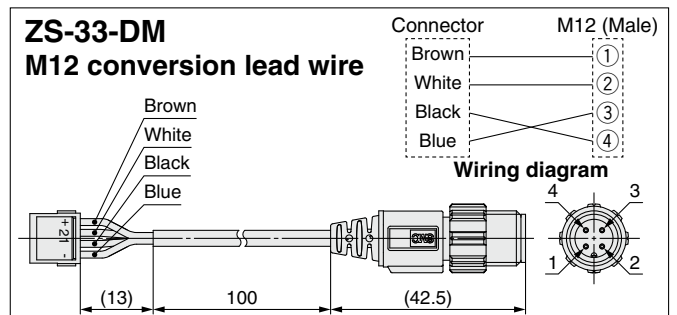

# PF2M7(-L) Series

For flow switch precautions and specific product precautions, refer to the Operation Manual on the SMC website.

## Specifications

Model		PF2M701	PF2M702	PF2M705	PF2M710	PF2M725	PF2M750	PF2M711	PF2M721	
Fluid	Applicable fluid*1	Dry air, N <sub>2</sub> , Ar, CO <sub>2</sub> (JIS B 8392-1 1.1.2 to 1.6.2, ISO 8573-1 1.1.2 to 1.6.2)								
	Fluid temperature range	0 to 50°C								
Flow	Detection method	Thermal type (Main flow type)			Thermal type (Bypass flow type)					
	Rated flow range [L/min]	Dry air, N <sub>2</sub> , Ar	0.01 to 1	0.02 to 2	0.05 to 5	0.1 to 10	0.3 to 25	0.5 to 50	1 to 100	2 to 200
		CO <sub>2</sub>	0.01 to 0.5	0.02 to 1	0.05 to 2.5	0.1 to 5	0.3 to 12.5	0.5 to 25	1 to 50	2 to 100
	Set point range	Instantaneous flow [L/min]	-0.05 to 1.05	-0.1 to 2.1	-0.25 to 5.25	-0.5 to 10.5	-1.3 to 26.3	-2.5 to 52.5	-5 to 105	-10 to 210
		Accumulated flow [L]	0.00 to 9999999.99							
	Smallest settable increment	Instantaneous flow [L/min]	0.001	0.01			0.1			1
		Accumulated flow [L]	0.01		0.1			1		1
Accumulated volume per pulse [L/pulse]	0.01		0.1			1		1		
Accumulated value hold function*2	Intervals of 2 or 5 minutes can be selected.									
Pressure	Operating pressure range	-0.1 to 0.75 MPa								
	Rated pressure range*3	-0.07 to 0.75 MPa								
	Proof pressure	1.0 MPa								
	Pressure loss	Refer to the "Pressure Loss" graph.								
	Pressure characteristics	±5% F.S. ±1 digit (0.35 MPa standard)								
Electrical	Power supply voltage*4	For the switch output device	12 to 24 VDC ±10%							
		For the IO-Link device	18 to 30 VDC ±10%							
	Current consumption	35 mA or less								
Protection	Polarity protection									
Accuracy*5	Display accuracy	±3% F.S. ±1 digit								
	Analog output accuracy	±3% F.S.								
	Repeatability	±1% F.S. ±1 digit (±2% F.S. ±1 digit when the digital filter is set to 0.05 s)								
	Temperature characteristics	±3% F.S. ±1 digit (15 to 35°C: 25°C standard) ±5% F.S. ±1 digit (0 to 50°C: 25°C standard)								
Switch output	Output type	NPN/PNP open collector								
	Output mode	Select from Hysteresis, Window comparator, Accumulated output, Accumulated pulse output, Error output, or Switch output OFF modes.								
	Switch operation	Select from Normal or Reversed output.								
	Max. load current	80 mA								
	Max. applied voltage	Standard	28 VDC (NPN only)							
		IO-Link compatible	30 VDC (NPN only)							
	Internal voltage drop	Standard	NPN: 1 V or less (Load current: 80 mA)			PNP: 1.5 V or less (Load current: 80 mA)				
		IO-Link compatible	1.5 V or less (Load current: 80 mA)							
	Response time*6	50 ms or less								
	Delay time*7	Select from 0 to 0.10 s (increment of 0.01 s), 0.1 to 1.0 s (increment of 0.1 s), 1 to 10 s (increment of 1 s), 20 s, 30 s, 40 s, 50 s, or 60 s.								
Hysteresis*8	Variable from 0									
Protection	Short circuit protection									
Analog output*9	Output type	Voltage output: 1 to 5 V, 0 to 10 V (only when the power supply voltage is 24 VDC)*10, Current output: 4 to 20 mA								
	Impedance	Voltage output	Output impedance: Approx. 1 kΩ							
		Current output	Maximum load impedance: 600 Ω at power supply voltage of 24 V, 300 Ω at power supply voltage of 12 V							
Response time*6	50 ms ±40%									
Display	Reference condition*11	Select from Standard condition (STD) or Normal condition (NOR).								
	Display mode	Select from Instantaneous flow or Accumulated flow.								
	Unit*12	Instantaneous flow	L/min, cfm							
		Accumulated flow	L, ft <sup>3</sup>							
	Display range	Instantaneous flow [L/min]	-0.05 to 1.05	-0.1 to 2.1	-0.25 to 5.25	-0.5 to 10.5	-1.3 to 26.3	-2.5 to 52.5	-5 to 105	-10 to 210
		Zero cut-off range	0 to ±10% F.S. (Select per 1% F.S. for the maximum rated flow rate.)							
	Accumulated flow [L]*13	0.00 to 9999999.99	0.0 to 99999999.9			0 to 999999999				
Display	LCD, Color: Red/Green, 4 digits, 7 segments									
Indicator LED	LED ON when switch output is ON (OUT1/2: Orange)									
Digital filter*14	Select from 0.05 s, 0.1 s, 0.5 s, 1 s, 2 s, or 5 s.									
Environmental resistance	Enclosure	IP40								
	Withstand voltage	1000 VAC for 1 minute between terminals and housing								
	Insulation resistance	50 MΩ or more (500 VDC measured via megohmmeter) between terminals and housing								
	Operating temperature range	Operating: 0 to 50°C, Stored: -10 to 60°C (No condensation or freezing)								
	Operating humidity range	Operating/Stored: 35 to 85% RH (No condensation or freezing)								
Standards	CE marking (EMC Directive, RoHS Directive)									
Piping*15	Piping specification	One-touch fitting	C4 (ø4)/C6 (ø6)			C6 (ø6)/N7 (ø1/4")		C8 (ø8)/N7 (ø1/4")		
		Screw-in (Rc, NPT, G)	01 (Rc1/8)/N1 (NPT1/8)/F1 (G1/8)			02 (Rc1/4)/N2 (NPT1/4)/F2 (G1/4)				
	Piping entry direction	Straight, Rear								
Main materials of parts in contact with fluid	PPS, PBT, FKM, Stainless steel 304, Brass (Electroless nickel plating), Si, Au, GE4F									
Weight	Body	One-touch fitting	Straight: 40 g Rear: 55 g				Straight: 48 g Rear: 63 g			
		Screw-in	Straight: 60 g Rear: 75 g				Straight: 72 g (G1/4: 117 g) Rear: 87 g (G1/4: 132 g)			
	Flow adjustment valve	—		+34 g						
	Lead wire	+35 g								
	Bracket	+20 g								
	Panel mount adapter	+15 g								
DIN rail mounting bracket	+65 g									

- \*1 Refer to the "Recommended pneumatic circuit examples" on page 2.
- \*2 When using the accumulated value hold function, use the operating conditions to calculate the product life, and do not exceed it. The maximum access limit of the memory device is 3.7 million times. If the product is operated 24 hours per day, the product life will be as follows:
  - 5 min interval: life is calculated as 5 min x 3.7 million = 18.5 million min = 35 years
  - 2 min interval: life is calculated as 2 min x 3.7 million = 7.4 million min = 14 years
- \*3 Negative pressure indicates the pressure value on the IN side (inlet side).
- \*4 When multiple products are installed closely, the upper limit of the power supply voltage is 24 VDC.
- \*5 The accuracy value is based on dry air as a fluid. For other fluids, it is a reference value.
- \*6 Value when the digital filter is set at 0.05 s
- \*7 The time from when the instantaneous flow reaches the set value to when the switch output operates can be set.
- \*8 If the flow fluctuates around the set value, the hysteresis must be set to a value more than the fluctuating width. Otherwise, chattering will occur.
- \*9 When using a product with an analog output
- \*10 When selecting 0 to 10 V, refer to the analog output graph for the allowable load current.
- \*11 Standard condition (STD): 20 [°C], 101.3 [kPa] (Absolute pressure), 65 [% RH] (The flow rate given in the specifications is the value under standard conditions.)  
Normal condition (NOR): 0 [°C], 101.3 [kPa] (Absolute pressure), 0 [% RH]
- \*12 Setting is only possible for models with the unit selection function.
- \*13 Power value is displayed for accumulated flow. The first 4 digits of the measurement value are always displayed.
- \*14 The time for the digital filter can be set to the sensor input. The response time indicates when the set value is 90% in relation to the step input.
- \*15 Check the precautions for One-touch fitting before use. When the piping condition is changed, for example due to piping on the back of the product, use a general purpose fitting (KQ□□ series). Some piping conditions may have negative effects on the flow accuracy.
- \* Products with tiny scratches, marks, or display color or brightness variations which do not affect the performance of the product are verified as conforming products.

### Communication Specifications (IO-Link mode)

IO-Link type	Device	
IO-Link version	V1.1	
Communication speed	COM2 (38.4 kbps)	
Minimum cycle time	3.4 ms	
Process data length	Input data: 4 bytes, Output data: 0 byte	
On request data communication	Yes	
Data storage function	Yes	
Event function	Yes	
Vendor ID	131 (0 x 0083)	
Device ID	PF2M701-□-L□-□□□ : 0 x 00016D (365) PF2M701-□-L2□-□□□ : 0 x 00016E (366) PF2M701-□-L3□-□□□ : 0 x 00016F (367) PF2M701-□-L4□-□□□ : 0 x 000170 (368)	PF2M725-□-L□-□□□ : 0 x 00017D (381) PF2M725-□-L2□-□□□ : 0 x 00017E (382) PF2M725-□-L3□-□□□ : 0 x 00017F (383) PF2M725-□-L4□-□□□ : 0 x 000180 (384)
	PF2M702-□-L□-□□□ : 0 x 000171 (369) PF2M702-□-L2□-□□□ : 0 x 000172 (370) PF2M702-□-L3□-□□□ : 0 x 000173 (371) PF2M702-□-L4□-□□□ : 0 x 000174 (372)	PF2M750-□-L□-□□□ : 0 x 000181 (385) PF2M750-□-L2□-□□□ : 0 x 000182 (386) PF2M750-□-L3□-□□□ : 0 x 000183 (387) PF2M750-□-L4□-□□□ : 0 x 000184 (388)
	PF2M705-□-L□-□□□ : 0 x 000175 (373) PF2M705-□-L2□-□□□ : 0 x 000176 (374) PF2M705-□-L3□-□□□ : 0 x 000177 (375) PF2M705-□-L4□-□□□ : 0 x 000178 (376)	PF2M711-□-L□-□□□ : 0 x 000185 (389) PF2M711-□-L2□-□□□ : 0 x 000186 (390) PF2M711-□-L3□-□□□ : 0 x 000187 (391) PF2M711-□-L4□-□□□ : 0 x 000188 (392)
	PF2M710-□-L□-□□□ : 0 x 000179 (377) PF2M710-□-L2□-□□□ : 0 x 00017A (378) PF2M710-□-L3□-□□□ : 0 x 00017B (379) PF2M710-□-L4□-□□□ : 0 x 00017C (380)	PF2M721-□-L□-□□□ : 0 x 00023B (571) PF2M721-□-L2□-□□□ : 0 x 00023C (572) PF2M721-□-L3□-□□□ : 0 x 00023D (573) PF2M721-□-L4□-□□□ : 0 x 00023E (574)

# PF2M7(-L) Series

## Set Point Range and Rated Flow Range

### Set the flow rate within the rated flow range.

The set point range is the range of flow rate that can be set in the switch.

The rated flow range is the range that satisfies the switch specifications (accuracy, linearity, etc.).

It is possible to set a value outside of the rated flow range if it is within the set point range, however, the satisfaction of specifications can not be guaranteed. The flow range if using CO<sub>2</sub> is given in brackets.

Model	Flow range [L/min]										
	-10	-5	0	1	2	5	10	25	50	100	200
PF2M701(-L)			0.01 L/min	1.0 L/min (0.5 L/min)							
			-0.05 L/min	1.05 L/min (0.525 L/min)							
			-0.05 L/min	1.05 L/min (0.525 L/min)							
PF2M702(-L)			0.02 L/min	2.0 L/min (1 L/min)							
			-0.1 L/min	2.1 L/min (1.05 L/min)							
			-0.1 L/min	2.1 L/min (1.05 L/min)							
PF2M705(-L)			0.05 L/min	5.0 L/min (2.5 L/min)							
			-0.25 L/min	5.25 L/min (2.63 L/min)							
			-0.25 L/min	5.25 L/min (2.63 L/min)							
PF2M710(-L)			0.1 L/min	10.0 L/min (5 L/min)							
			-0.5 L/min	10.5 L/min (5.25 L/min)							
			-0.5 L/min	10.5 L/min (5.25 L/min)							
PF2M725(-L)			0.3 L/min	25.0 L/min (12.5 L/min)							
			-1.3 L/min	26.3 L/min (13.1 L/min)							
			-1.3 L/min	26.3 L/min (13.1 L/min)							
PF2M750(-L)			0.5 L/min	50.0 L/min (25 L/min)							
			-2.5 L/min	52.5 L/min (26.3 L/min)							
			-2.5 L/min	52.5 L/min (26.3 L/min)							
PF2M711(-L)			1.0 L/min	100.0 L/min (50 L/min)							
			-5.0 L/min	105.0 L/min (52.5 L/min)							
			-5.0 L/min	105.0 L/min (52.5 L/min)							
PF2M721(-L)			2 L/min	200 L/min (100 L/min)							
			-10 L/min	210 L/min (105 L/min)							
			-10 L/min	210 L/min (105 L/min)							

Rated flow range    Set point range    Display range

## Flow/Analog Output

	A	B		C
		PF2M701/02/05/10/50/11/21(-L)	PF2M725(-L)	
Voltage output (1 to 5 V)	1 V	1.04 V	1.05 V	5 V
Current output (4 to 20 mA)	4 mA	4.16 mA	4.19 mA	20 mA

	E	F		G
		PF2M701/02/05/10/50/11/21(-L)	PF2M725(-L)	
Voltage output (0 to 10 V)*1	0 V	0.10 V	0.12 V	10 V

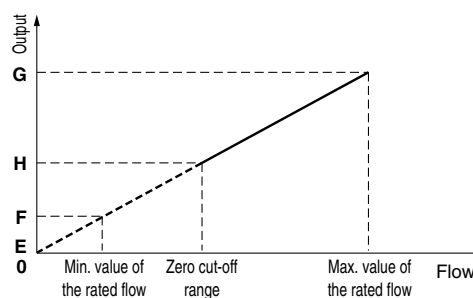
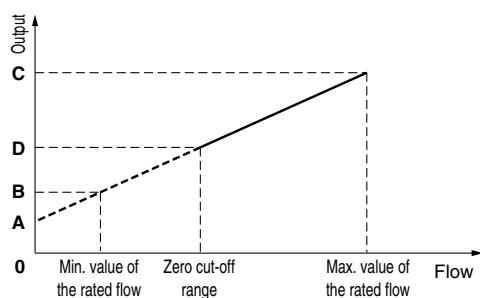

\*1 The analog output current from the connected equipment should be 20  $\mu$ A or less when selecting 0 to 10 V.

When 20  $\mu$ A or more current flows, it is possible that the accuracy is not satisfied at less than or equal to 0.5 V.

\* D or H fluctuates depending on the setting of the zero cut-off function.

When the zero cut-off function is set to "0," the flow rate display value starts from 0 L/min., but in conditions other than horizontal installation and supply pressure of 0.35 MPa, the output may not be 0 L/min.

**Pressure Loss (Reference Data): Without Flow Adjustment Valve**

**PF2M701(-L)**

1 L/min

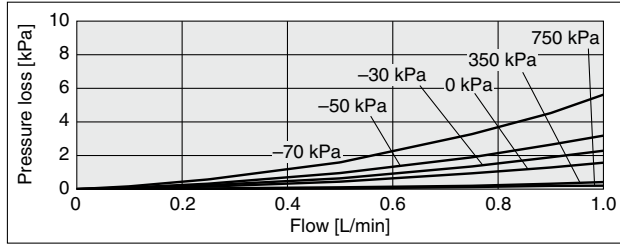

**PF2M702(-L)**

2 L/min

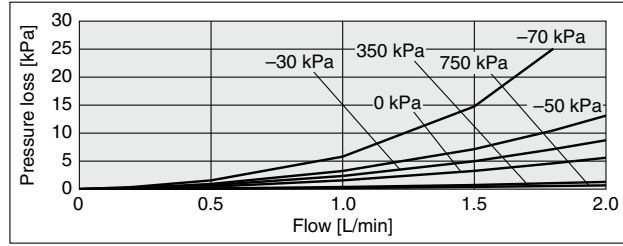

**PF2M705(-L)**

5 L/min

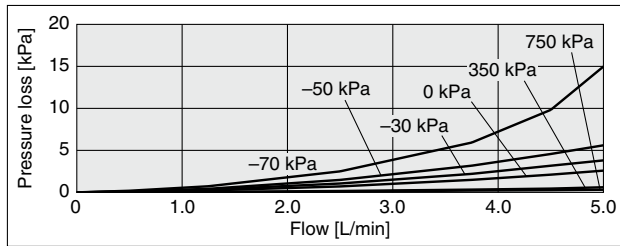

**PF2M710(-L)**

10 L/min

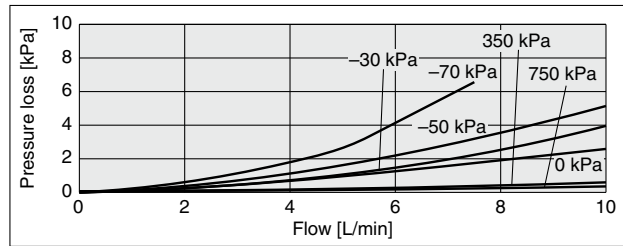

**PF2M725(-L)**

25 L/min

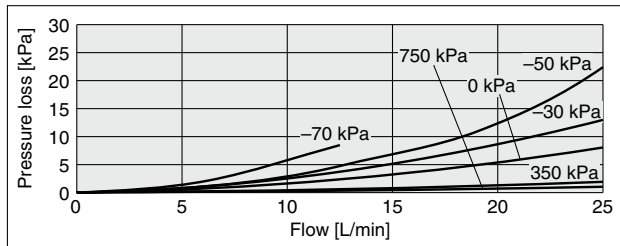

**PF2M750(-L)**

50 L/min

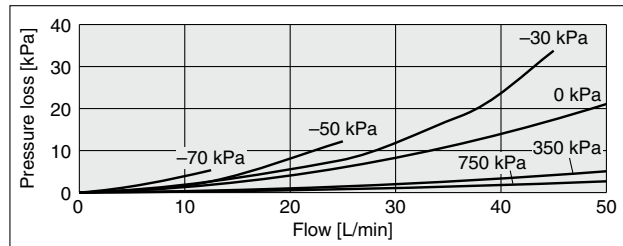

**PF2M711(-L)**

100 L/min

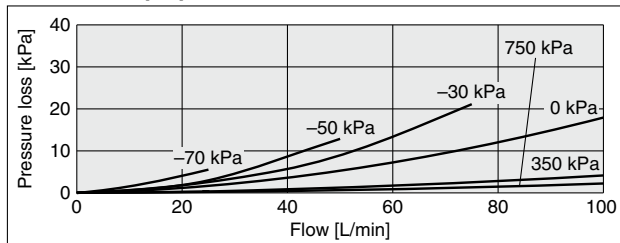

**PF2M721(-L)**

200 L/min

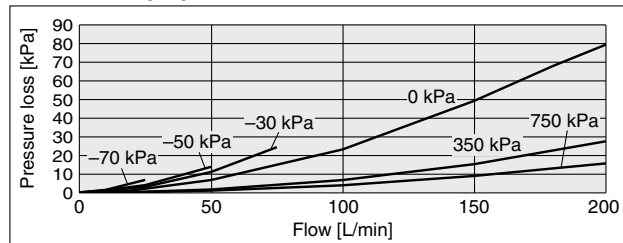

**Flow Rate Characteristics (Reference Data)**

**PF2M705(-L)**

5 L/min

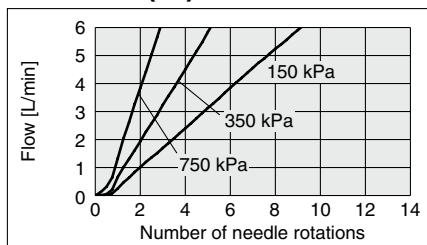

**PF2M710(-L)**

10 L/min

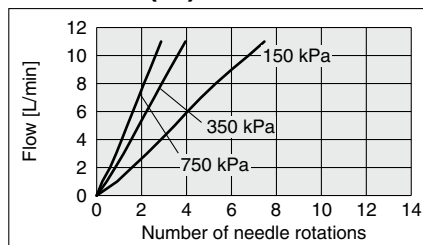

**PF2M725(-L)**

25 L/min

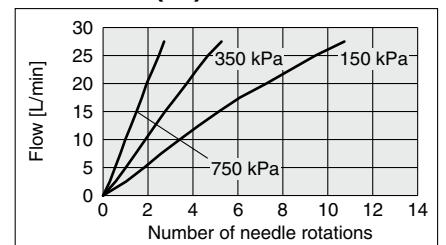

**PF2M750(-L)**

50 L/min

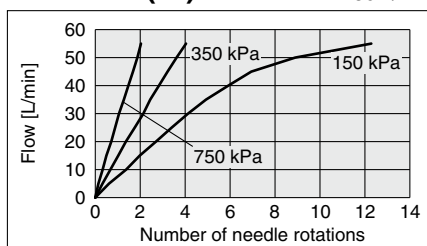

**PF2M711(-L)**

100 L/min

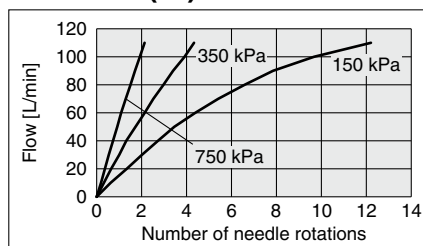

**PF2M721(-L)**

200 L/min

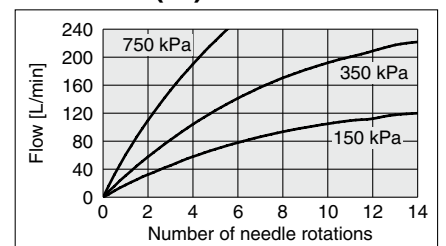

# PF2M7(-L) Series

## Flow Rate Characteristics at Negative Pressure (Reference Data)

When the PF2M series is used with negative pressure (-70 to 0 kPa), the measurable range (warranty range of the specifications including pressure characteristics) varies depending on the flow range. Select the flow range referring to the graph below.

**PF2M701(-L)**

1 L/min

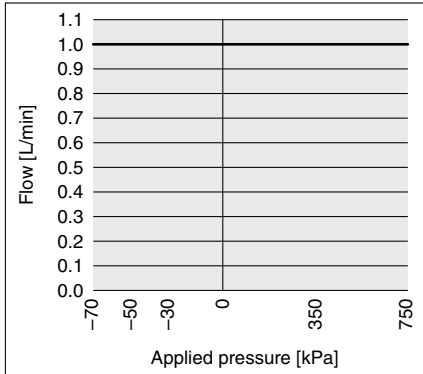

**PF2M702(-L)**

2 L/min

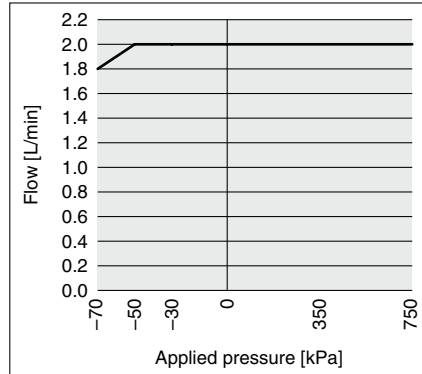

**PF2M705(-L)**

5 L/min

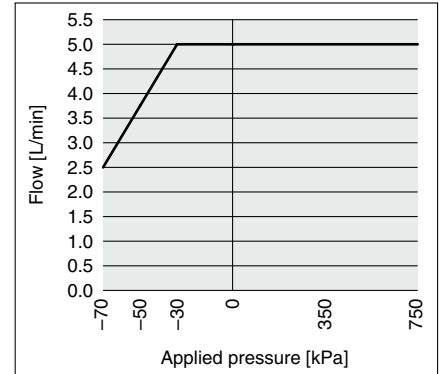

**PF2M710(-L)**

10 L/min

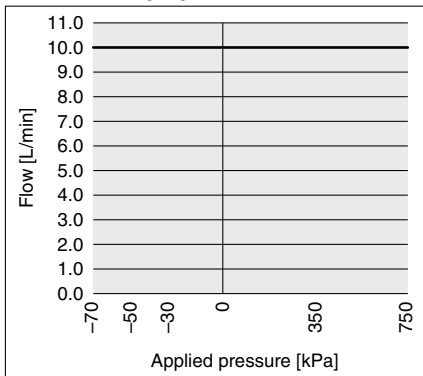

**PF2M725(-L)**

25 L/min

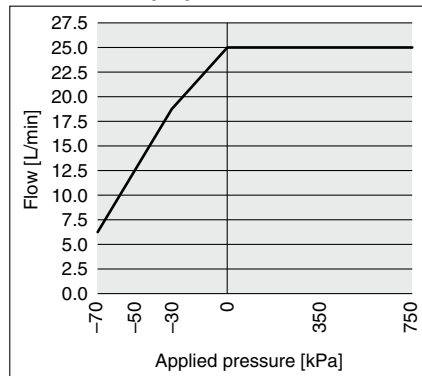

**PF2M750(-L)**

50 L/min

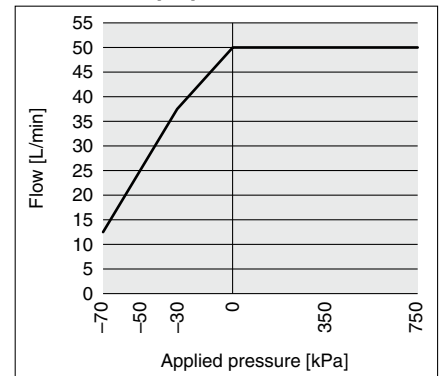

**PF2M711(-L)**

100 L/min

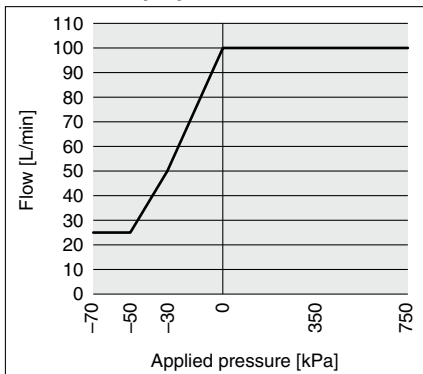

**PF2M721(-L)**

200 L/min

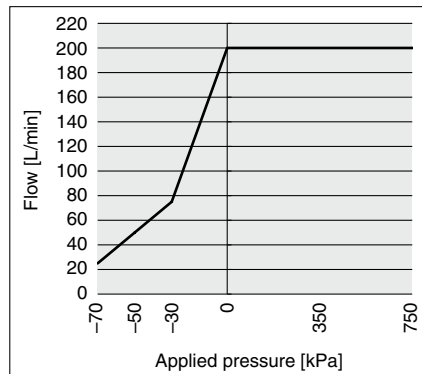



## Internal Circuits and Wiring Examples

### NPN + NPN output type

PF2M7□□-□-**A**□-□□□

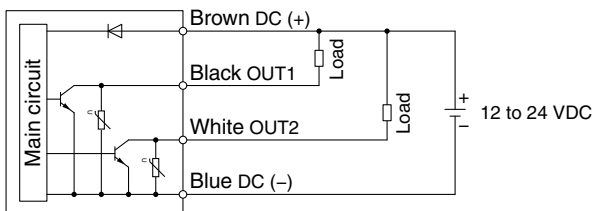

Max. applied voltage: 28 V, Max. load current: 80 mA,  
Internal voltage drop: 1 V or less

### PNP + PNP output type

PF2M7□□-□-**B**□-□□□

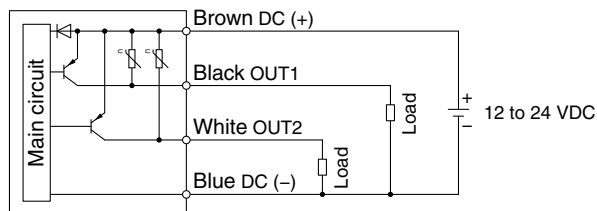

Max. load current: 80 mA, Internal voltage drop: 1.5 V or less

### NPN + Analog output type

PF2M7□□-□-**C/D**□-□□□

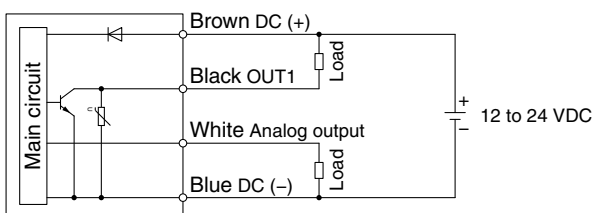

Max. applied voltage: 28 V, Max. load current: 80 mA,  
Internal voltage drop: 1 V or less

**C:** Analog output: 1 to 5 V or 0 to 10 V can be selected.

Output impedance: 1 k $\Omega$

**D:** Analog output: 4 to 20 mA

Load impedance: 50 to 600  $\Omega$

### PNP + Analog output type

PF2M7□□-□-**E/F**□-□□□

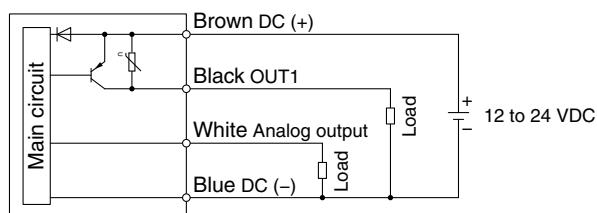

Max. load current: 80 mA, Internal voltage drop: 1.5 V or less

**E:** Analog output: 1 to 5 V or 0 to 10 V can be selected.

Output impedance: 1 k $\Omega$

**F:** Analog output: 4 to 20 mA

Load impedance: 50 to 600  $\Omega$

## Accumulated pulse output wiring examples

### NPN + NPN output type

PF2M7□□-□-**A**□-□□□

### NPN + Analog output type

PF2M7□□-□-**C**□-□□□

PF2M7□□-□-**D**□-□□□

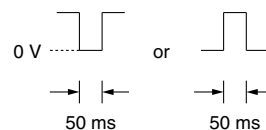
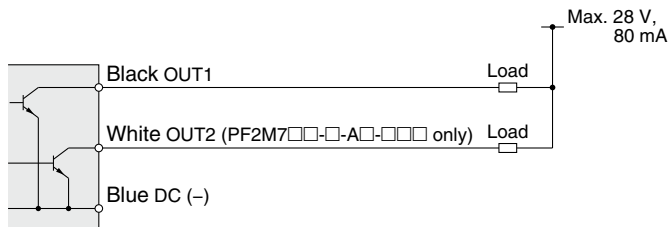

### PNP + PNP output type

PF2M7□□-□-**B**□-□□□

### PNP + Analog output type

PF2M7□□-□-**E**□-□□□

PF2M7□□-□-**F**□-□□□

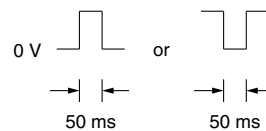
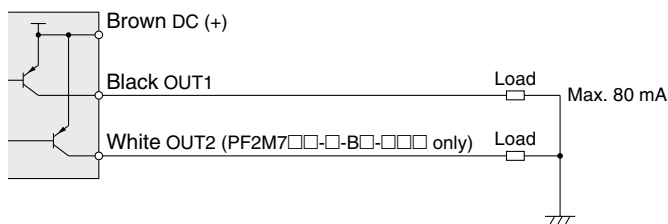

# PF2M7(-L) Series

## Internal Circuits and Wiring Examples

PF2M7□□-□-□-□□□

### NPN output type

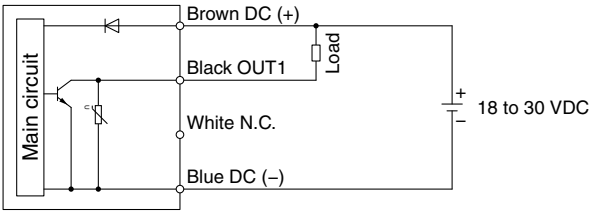

Max. applied voltage: 30 V, Max. load current: 80 mA,  
Internal voltage drop: 1.5 V or less

### PNP output type

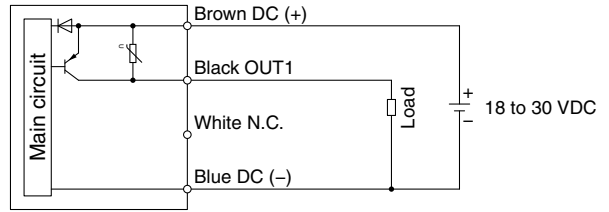

Max. load current: 80 mA, Internal voltage drop: 1.5 V or less

PF2M7□□-□-□-□□□

### NPN 2 output type

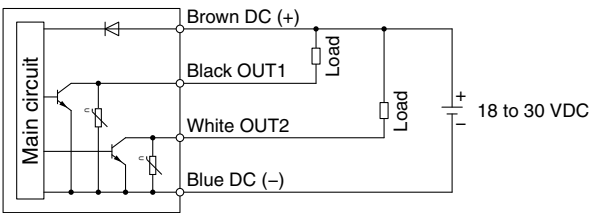

Max. applied voltage: 30 V, Max. load current: 80 mA,  
Internal voltage drop: 1.5 V or less

### PNP 2 output type

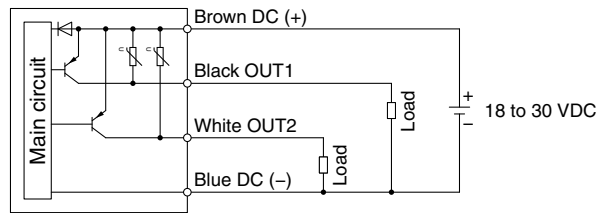

Max. load current: 80 mA, Internal voltage drop: 1.5 V or less

### NPN + External input type

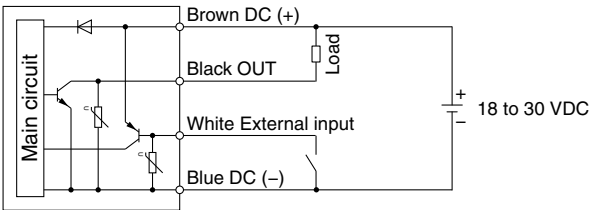

Max. applied voltage: 30 V, Max. load current: 80 mA,  
Internal voltage drop: 1.5 V or less

### PNP + External input type

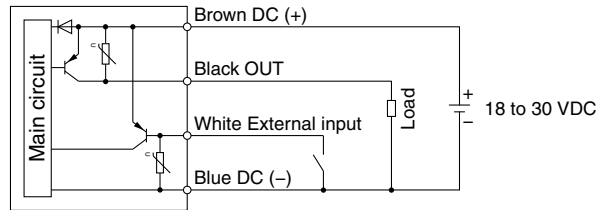

Max. load current: 80 mA, Internal voltage drop: 1.5 V or less

PF2M7□□-□-□-□□□

### L3: NPN + Analog voltage output type

### L4: NPN + Analog current output type

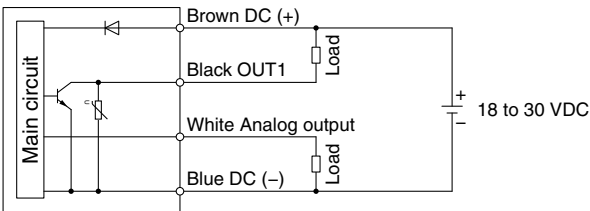

Max. applied voltage: 30 V, Max. load current: 80 mA,  
Internal voltage drop: 1.5 V or less

**L3:** Analog output: 1 to 5 V or 0 to 10 V can be selected.  
Output impedance: 1 kΩ

**L4:** Analog output: 4 to 20 mA  
Load impedance: 50 to 600 Ω

### L3: PNP + Analog voltage output type

### L4: PNP + Analog current output type

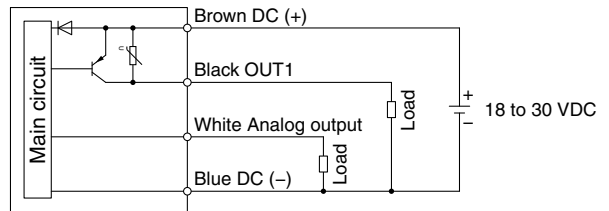

Max. load current: 80 mA, Internal voltage drop: 1.5 V or less

**L3:** Analog output: 1 to 5 V or 0 to 10 V can be selected.

Output impedance: 1 kΩ

**L4:** Analog output: 4 to 20 mA

Load impedance: 50 to 600 Ω

### When used as an IO-Link device

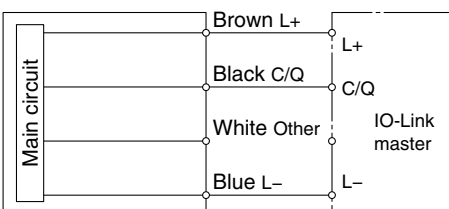

**Construction: Parts in Contact with Fluid**

**PF2M701/702/705/710/725/750/711(-L)**

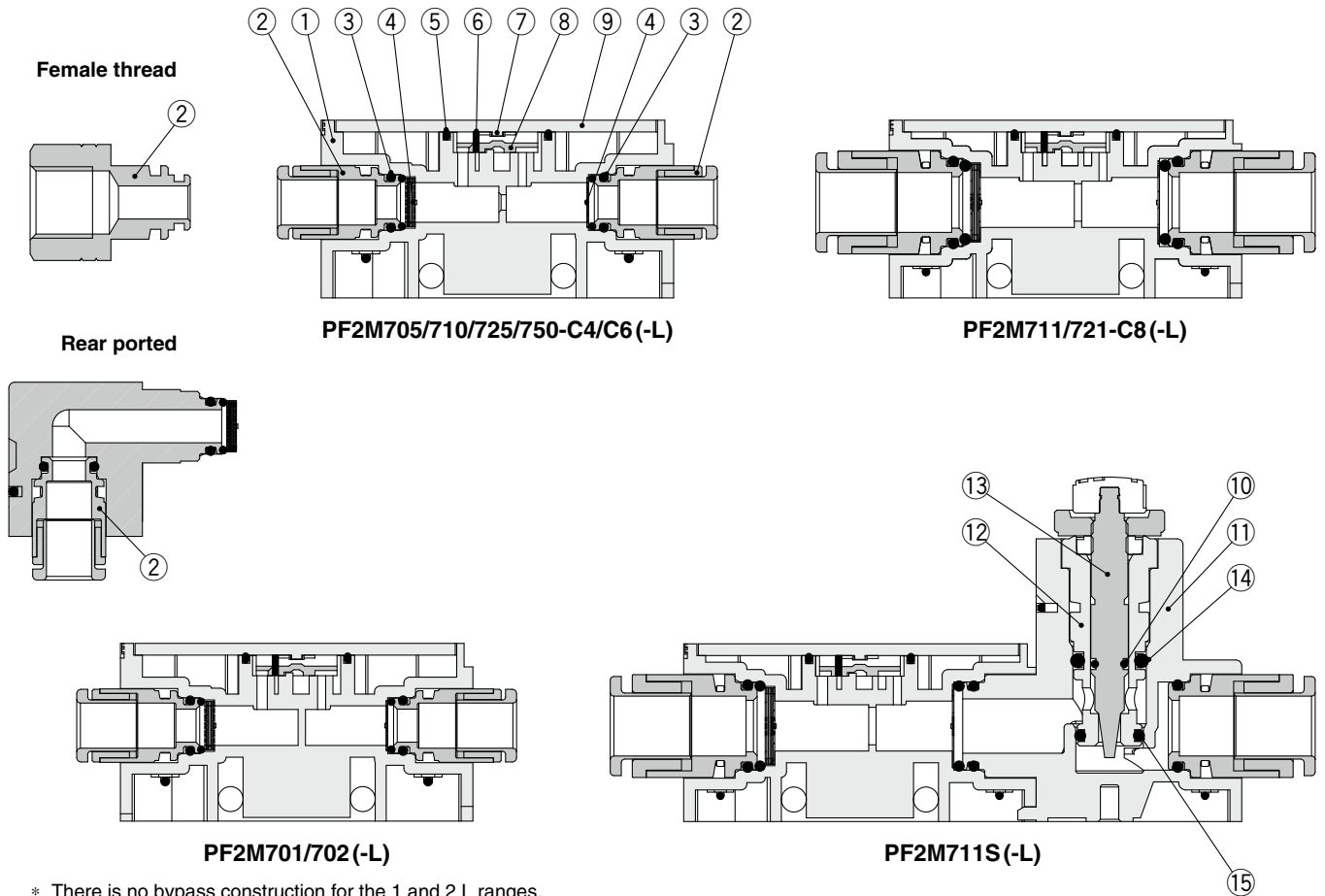

**Component Parts**

No.	Description	Material	Note
1	Body	PPS	
2	Fitting for piping	Brass	Electroless nickel plating
3	O-ring	FKM	
4	Flow rectifier	Stainless steel 304	
5	Seal	FKM	
6	Flow rectifier	Stainless steel 304	
7	Sensor chip	Silicon	
8	Body B	PPS	
9	Printed circuit board	GE4F	
10	O-ring	FKM	Fluoro coating
11	Flow adjustment valve body	PBT	
12	Body	Brass	Electroless nickel plating
13	Needle	Brass	Electroless nickel plating
14	O-ring	FKM	Fluoro coating
15	O-ring	FKM	Fluoro coating

# PF2M7(-L) Series

## Dimensions

### PF2M7□-C4/C6/C8/N7(-L)

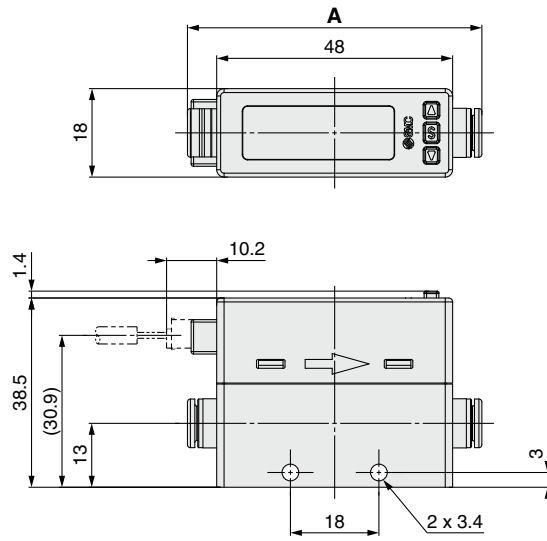
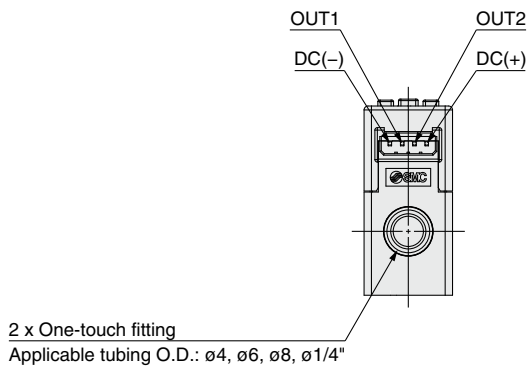

Model	A	P
PF2M701/702/705/710-C4(-L)	59.1	$\phi 2.8$ depth 8.4
PF2M701/702/705/710/725/750-C6(-L)	59.9	$\phi 2.8$ depth 8.4
PF2M725/750-N7(-L)	67.5	$\phi 2.8$ depth 8.4
PF2M711/721-C8(-L)	68	$\phi 2.8$ depth 6.2
PF2M711/721-N7(-L)	64.6	$\phi 2.8$ depth 6.2

[mm]

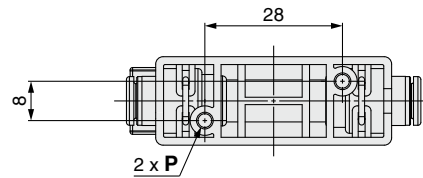

### PF2M7□L-C4/C6/C8/N7(-L)

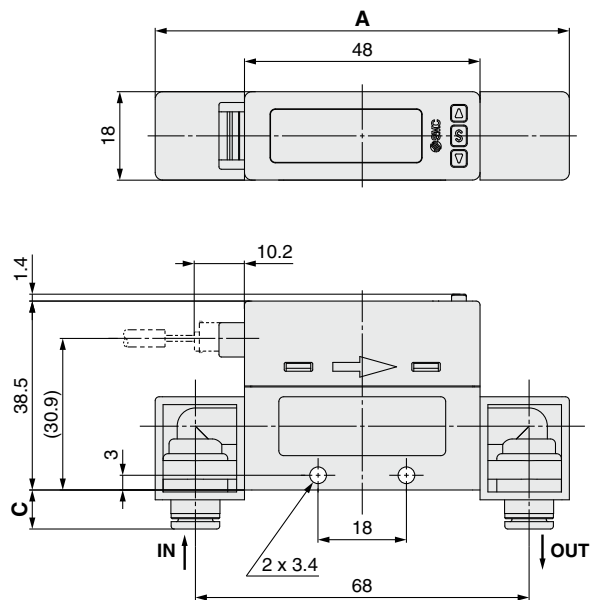
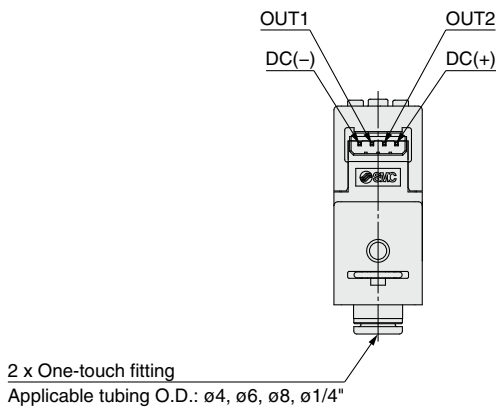

Model	A	C	P
PF2M701/702/705/710L-C4(-L)	84.4	7.6	$\phi 2.8$ depth 8.4
PF2M701/702/705/710/725/750L-C6(-L)	84.4	8	$\phi 2.8$ depth 8.4
PF2M725/750L-N7(-L)	84.4	11.8	$\phi 2.8$ depth 8.4
PF2M711/721L-C8(-L)	88	12	$\phi 2.8$ depth 6.2
PF2M711/721L-N7(-L)	88	10.3	$\phi 2.8$ depth 6.2

[mm]

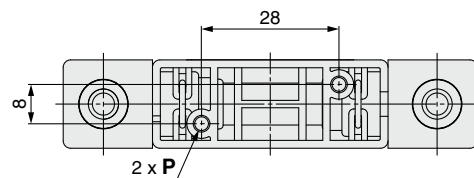

## Dimensions

### PF2M7□-□1/2(-L)

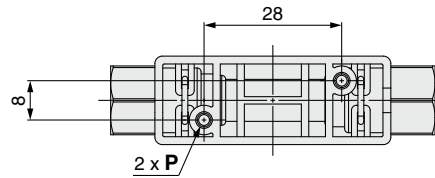
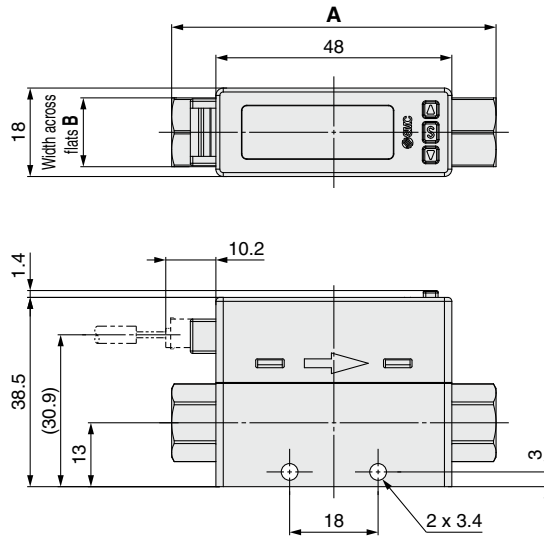
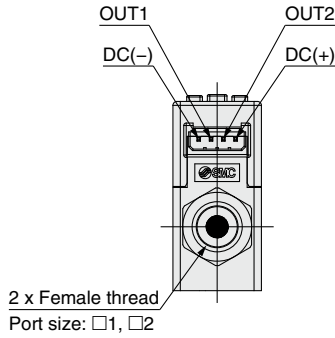

Model	A	B	P
PF2M701/702/705/710/ 725/750-01(-L)	66	14	ø2.8 depth 8.4
PF2M701/702/705/710/ 725/750-N1(-L)	68	14	ø2.8 depth 8.4
PF2M701/702/705/710/ 725/750-F1(-L)	70	14	ø2.8 depth 8.4
PF2M711/721-02(-L)	70	17	ø2.8 depth 6.2
PF2M711/721-N2(-L)	70	17	ø2.8 depth 6.2
PF2M711/721-F2(-L)	78	21	ø2.8 depth 6.2

### PF2M□L-□1/2(-L)

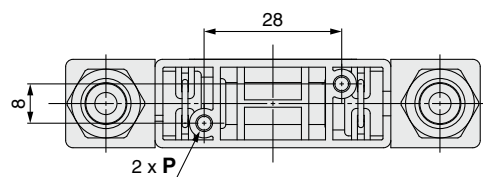
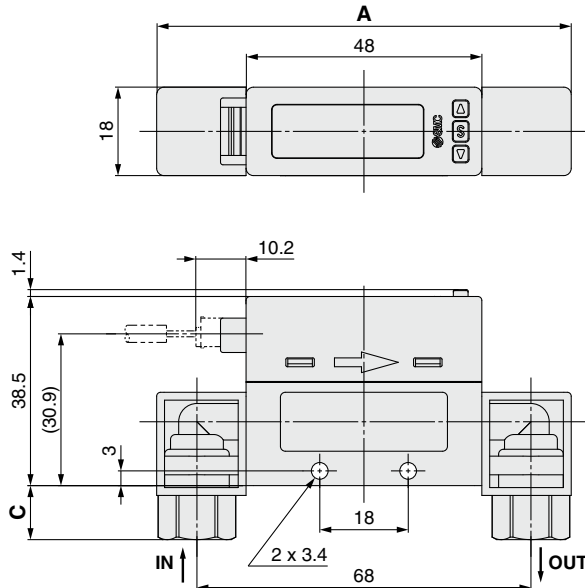
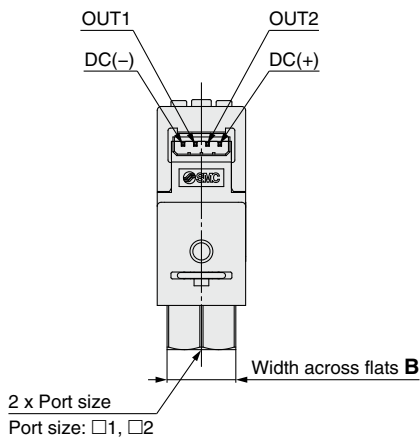

Model	A	C	B	P
PF2M701/702/705/710/ 725/750L-01(-L)	84.4	11	14	ø2.8 depth 8.4
PF2M701/702/705/710/ 725/750L-N1(-L)	84.4	12	14	ø2.8 depth 8.4
PF2M701/702/705/710/ 725/750L-F1(-L)	84.4	13	14	ø2.8 depth 8.4
PF2M711/721L-02(-L)	88	13	17	ø2.8 depth 6.2
PF2M711/721L-N2(-L)	88	13	17	ø2.8 depth 6.2
PF2M711/721L-F2(-L)	88	17	21	ø2.8 depth 6.2

# PF2M7(-L) Series

## Dimensions

### PF2M7□S-C4/C6/C8/N7(-L)

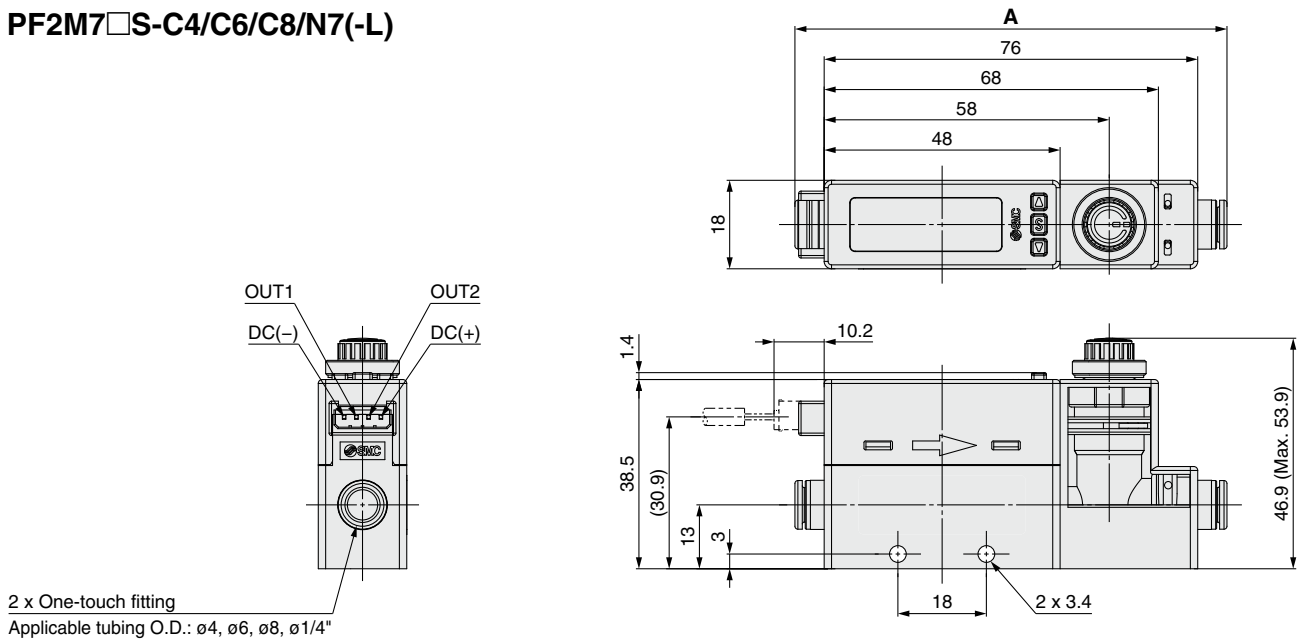

Model	A	P	Q
PF2M705/710S-C4(-L)	87.1	$\phi 2.8$ depth 8.4	$\phi 2.5$ depth 6
PF2M705/710/725/750S-C6(-L)	87.9	$\phi 2.8$ depth 8.4	$\phi 2.5$ depth 6
PF2M725/750S-N7(-L)	95.5	$\phi 2.8$ depth 8.4	$\phi 2.5$ depth 6
PF2M711/721S-C8(-L)	96	$\phi 2.8$ depth 6.2	$\phi 2.5$ depth 5
PF2M711/721S-N7(-L)	92.6	$\phi 2.8$ depth 6.2	$\phi 2.5$ depth 5

### PF2M7□W-C4/C6/C8/N7(-L)

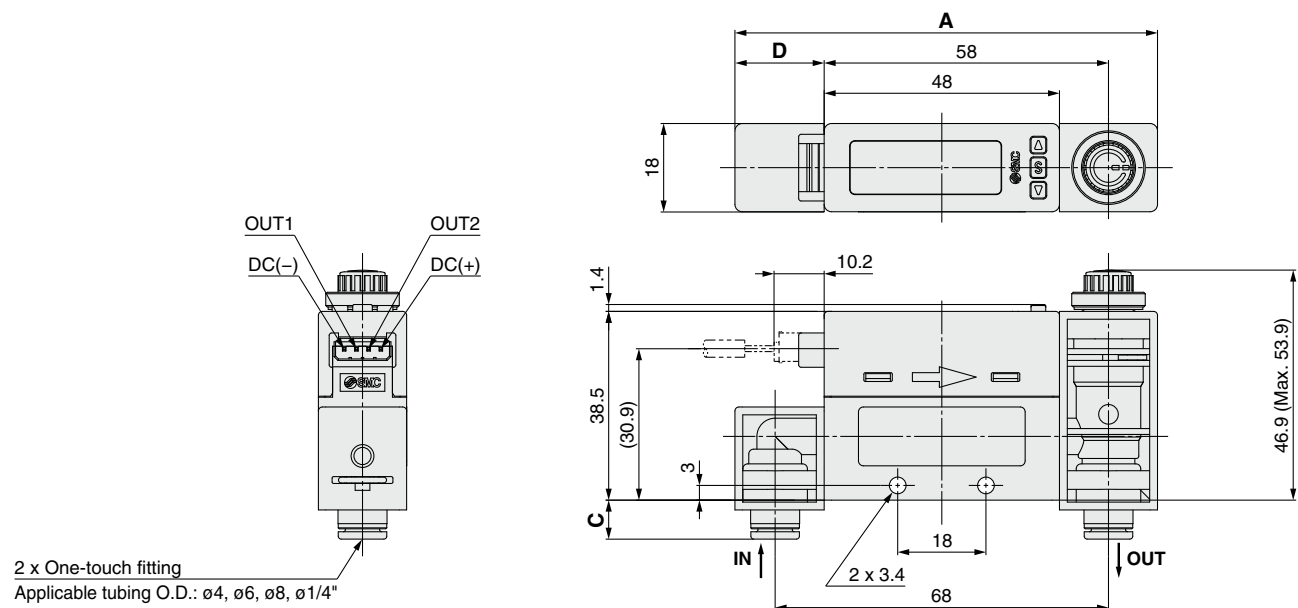

Model	A	C	D	P
PF2M705/710W-C4(-L)	86.2	7.6	18.2	$\phi 2.8$ depth 8.4
PF2M705/710/725/750W-C6(-L)	86.2	8	18.2	$\phi 2.8$ depth 8.4
PF2M725/750W-N7(-L)	86.2	11.8	18.2	$\phi 2.8$ depth 8.4
PF2M711/721W-C8(-L)	88	12	20	$\phi 2.8$ depth 6.2
PF2M711/721W-N7(-L)	88	10.3	20	$\phi 2.8$ depth 6.2

## Dimensions

### PF2M7□S-□1/2(-L)

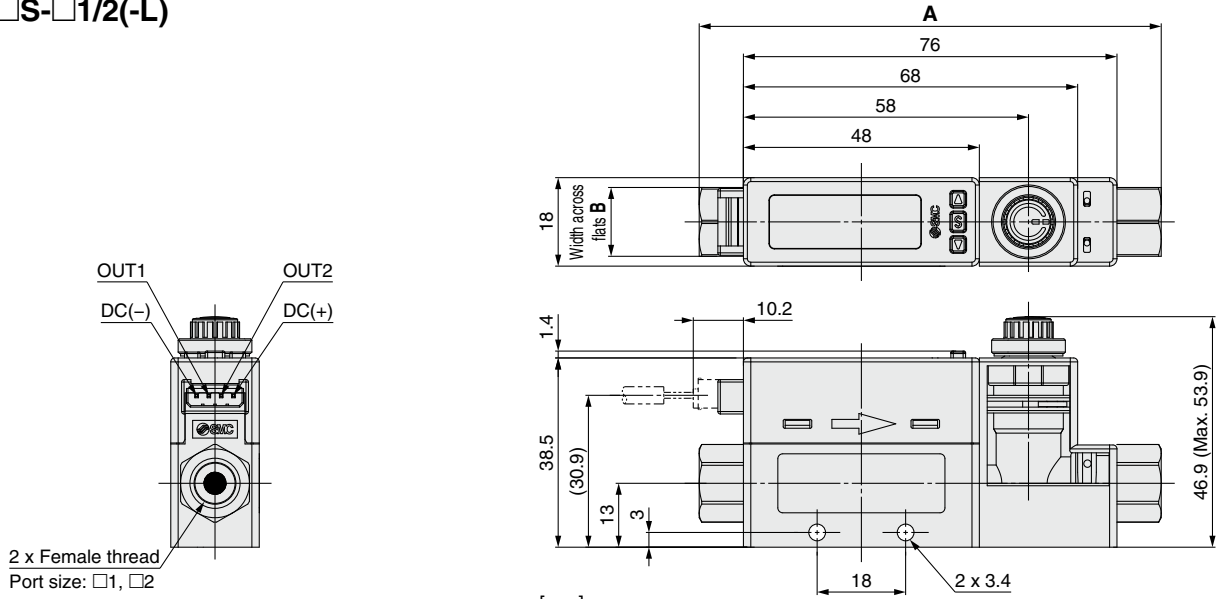

Model	A	B	P	Q
PF2M705/710/725/750S-01(-L)	94	14	ø2.8 depth 8.4	ø2.5 depth 6
PF2M705/710/725/750S-N1(-L)	96	14	ø2.8 depth 8.4	ø2.5 depth 6
PF2M705/710/725/750S-F1(-L)	98	14	ø2.8 depth 8.4	ø2.5 depth 6
PF2M711/721S-02(-L)	98	17	ø2.8 depth 6.2	ø2.5 depth 5
PF2M711/721S-N2(-L)	98	17	ø2.8 depth 6.2	ø2.5 depth 5
PF2M711/721S-F2(-L)	106	21	ø2.8 depth 6.2	ø2.5 depth 5

### PF2M7□W-□1/2(-L)

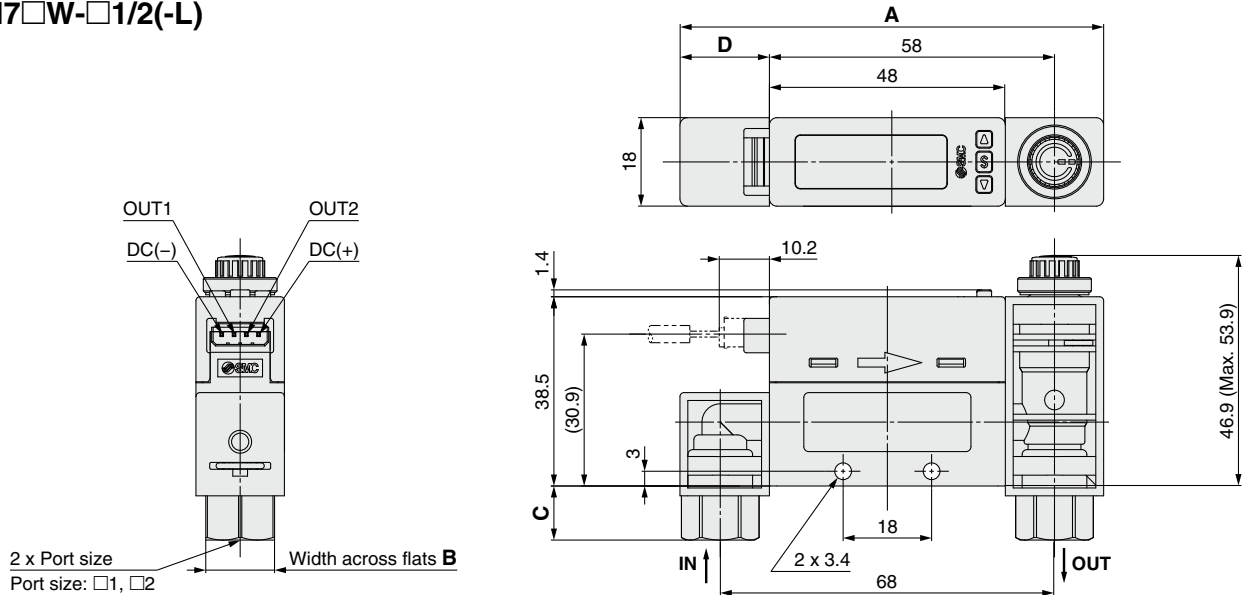

Model	A	C	B	D	P
PF2M705/710/725/750W-01(-L)	86.2	11	14	18.2	ø2.8 depth 8.4
PF2M705/710/725/750W-N1(-L)	86.2	12	14	18.2	ø2.8 depth 8.4
PF2M705/710/725/750W-F1(-L)	86.2	13	14	18.2	ø2.8 depth 8.4
PF2M711/721W-02(-L)	88	13	17	20	ø2.8 depth 6.2
PF2M711/721W-N2(-L)	88	13	17	20	ø2.8 depth 6.2
PF2M711/721W-F2(-L)	88	17	21	20	ø2.8 depth 6.2

# PF2M7(-L) Series

## Dimensions

### PF2M701/702/705/710/725/750/711/721(-L)

Panel mounting/Without flow adjustment valve/Straight

With bracket/Without flow adjustment valve

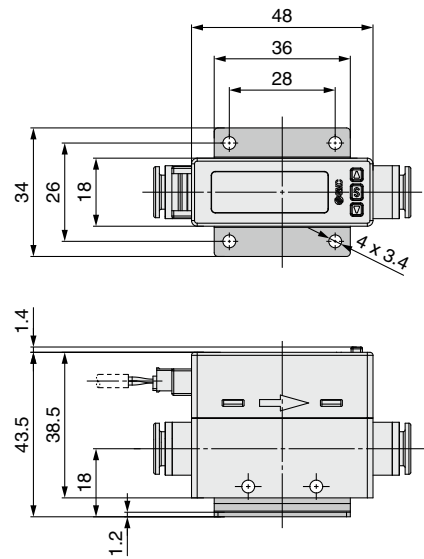
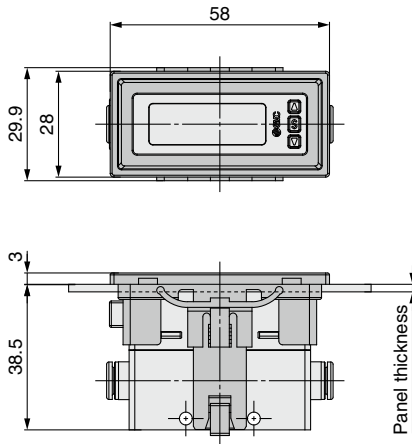

### Panel mount adapter/Without flow adjustment valve

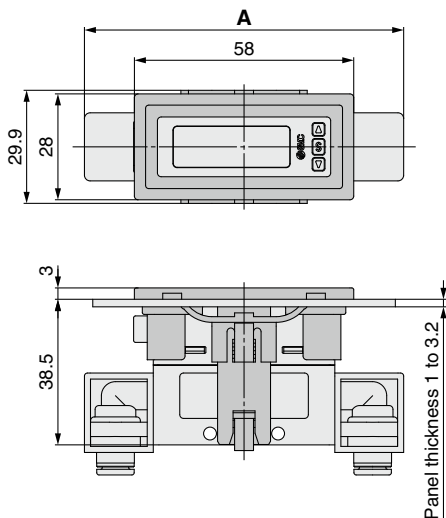

Model	A [mm]
PF2M701/702/705/710/725/750L-□(-L)	84.4
PF2M711/721L-□(-L)	88

### Panel Fitting Dimensions

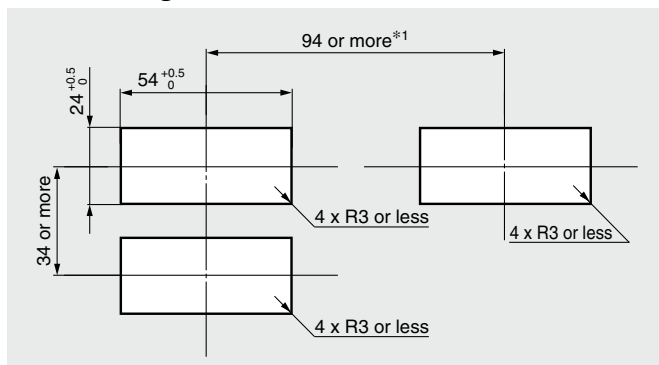

Panel thickness 1 to 3.2 mm

\*1 This is the minimum value when the rear ported type is selected for the piping entry direction. For the straight type, please design the layout with consideration to the piping material and tubing length. If a bend (R) is used, limit it to R3 or less.



## Dimensions

### PF2M705/710/725/750/711/721(-L)

Panel mounting/With flow adjustment valve/Straight

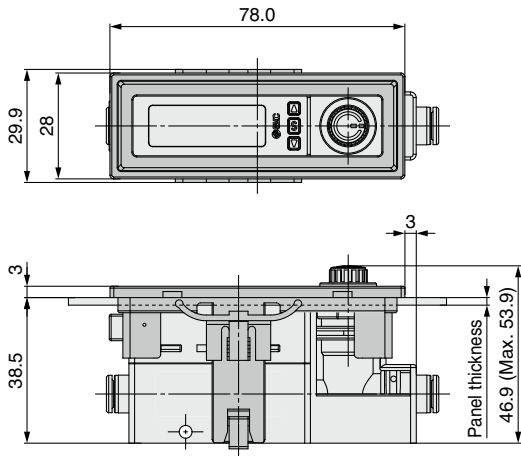

With bracket/With flow adjustment valve

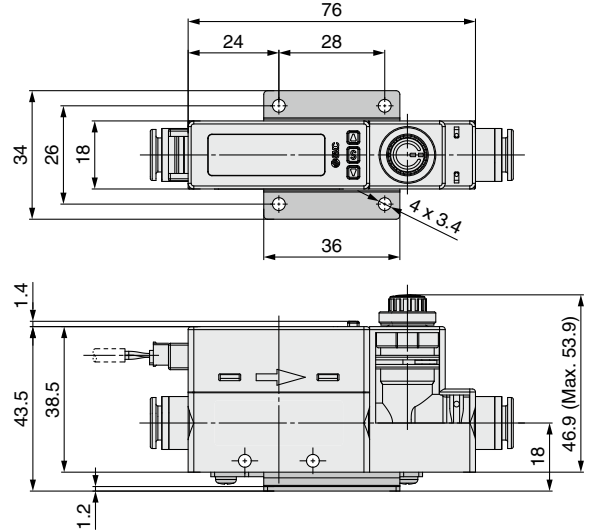

Panel mount adapter/With flow adjustment valve

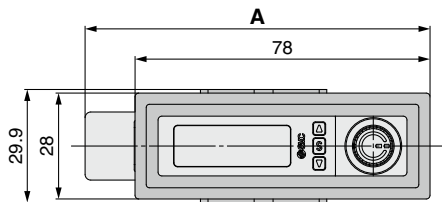

Model	A [mm]
PF2M705/710/725/750W-□(-L)	91.2
PF2M711/721W-□(-L)	93

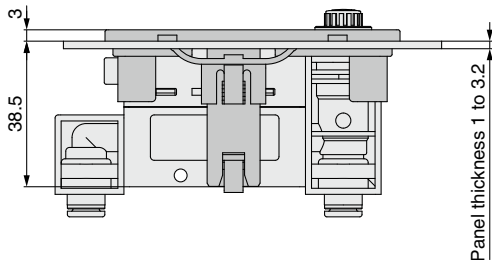

## Panel Fitting Dimensions

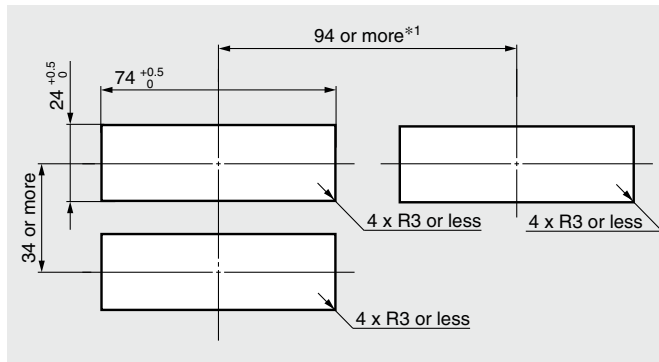

Panel thickness 1 to 3.2 mm

\*1 This is the minimum value when the rear ported type is selected for the piping entry direction. For the straight type, please design the layout with consideration to the piping material and tubing length. If a bend (R) is used, limit it to R3 or less.

# PF2M7(-L) Series

## Dimensions

### PF2M701/702/705/710/725/750/711/721(-L)

#### DIN rail mounting bracket

#### ZS-33-R□

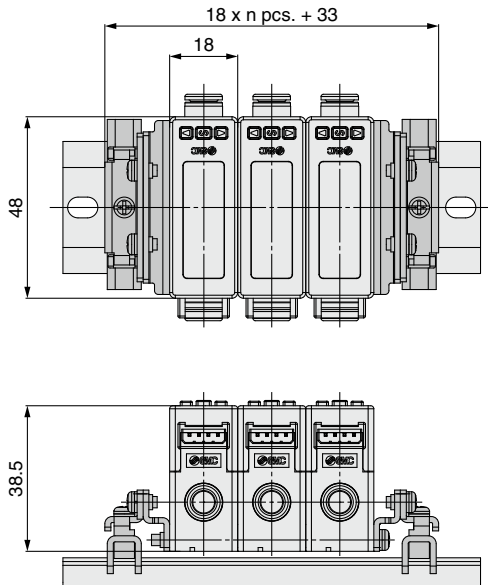

#### DIN rail

#### AXT100-DR-□

\* For □, enter a number from the No. line in the table below.

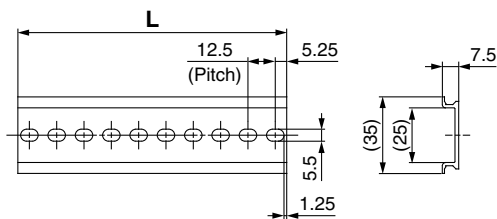

#### L Dimensions [mm]

No.	1	2	3	4	5	6	7	8	9	10	11	12	13	14	15	16	17	18	19	20
<b>L</b>	23	35.5	48	60.5	73	85.5	98	110.5	123	135.5	148	160.5	173	185.5	198	210.5	223	235.5	248	260.5

#### Lead wire with connector

#### ZS-33-D

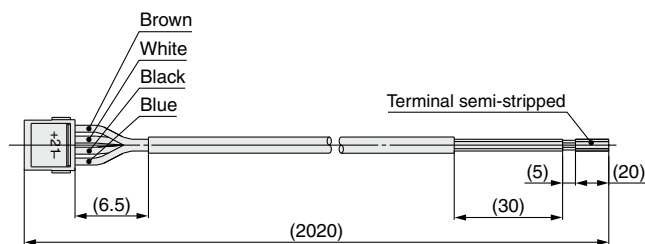

#### Cable Specifications

<b>Conductor</b>	Nominal cross section	AWG 26
	Outside diameter	Approx. 0.50 mm
<b>Insulator</b>	Outside diameter	Approx. 1.00 mm
	Color	Brown, White, Black, Blue
<b>Sheath</b>	Material	Oil-resistant PVC
<b>Finished outside diameter</b>		ø3.5

\* For wiring, refer to the Operation Manual from the SMC website Documents/Download --> Instruction Manuals.

# PF2M7-L Series IO-Link Compatible Products

## Made to Order

Please contact SMC for detailed specifications, delivery times, and prices.



### Compatible with Argon (Ar) and Carbon Dioxide (CO<sub>2</sub>) Mixed Gas

Symbol  
**X731**

The argon-carbon dioxide gas ratio (Ar : CO<sub>2</sub>) can be selected using the push-buttons from among the following: 92 : 8, 90 : 10, 80 : 20, 70 : 30, 60 : 40, 40 : 60, and 30 : 70. The dimensions are the same as those of the standard model.

PF2M 7   -  - **L**    - X731

7 Integrated display

#### Output specification

Symbol	OUT1	OUT2
<b>L</b>	IO-Link/NPN/PNP	—
<b>L2</b>	IO-Link/NPN/PNP	NPN/PNP/External input
<b>L3</b>	IO-Link/NPN/PNP	Analog 1 to 5 V ↔ Analog 0 to 10 V
<b>L4</b>	IO-Link/NPN/PNP	Analog 4 to 20 mA

For "How to Order," refer to page 10.

\* Only applicable to the IO-Link output specification

Model	Gas ratio		Rated flow range	Display/Set point range	Max. analog output	
	Ar	CO <sub>2</sub>			Voltage (Vmax)	Current (Imax)
PF2M701	92%	8%	0.01 to 1 L/min	-0.05 to 1.05 L/min	5 V	20 mA
	90%	10%				
	80%	20%				
	70%	30%				
	60%	40%				
	40%	60%				
PF2M702	30%	70%	0.01 to 0.6 L/min	-0.03 to 0.63 L/min	5 V	20 mA
	92%	8%	0.02 to 2 L/min	-0.1 to 2.1 L/min	5 V	20 mA
	90%	10%				
	80%	20%				
	70%	30%				
	60%	40%				
40%	60%					
PF2M705	30%	70%	0.02 to 1.2 L/min	-0.06 to 1.26 L/min	5 V	20 mA
	92%	8%	0.05 to 5 L/min	-0.25 to 5.25 L/min	5 V	20 mA
	90%	10%				
	80%	20%				
	70%	30%				
	60%	40%				
40%	60%					
PF2M710	30%	70%	0.05 to 3 L/min	-0.15 to 3.15 L/min	5 V	20 mA
	92%	8%	0.1 to 10 L/min	-0.5 to 10.5 L/min	5 V	20 mA
	90%	10%				
	80%	20%				
	70%	30%				
	60%	40%				
40%	60%					
PF2M710	30%	70%	0.1 to 6 L/min	-0.3 to 6.3 L/min	5 V	20 mA
	92%	8%	0.3 to 25 L/min	-1.3 to 26.3 L/min	5 V	20 mA
	90%	10%				
	80%	20%				
	70%	30%				
	60%	40%				
40%	60%					
PF2M725	30%	70%	0.3 to 15 L/min	-0.8 to 15.8 L/min	5 V	20 mA
	92%	8%	0.5 to 50 L/min	-2.5 to 52.5 L/min	5 V	20 mA
	90%	10%				
	80%	20%				
	70%	30%				
	60%	40%				
40%	60%					
PF2M750	30%	70%	0.5 to 30 L/min	-1.5 to 31.5 L/min	5 V	20 mA
	92%	8%	1 to 100 L/min	-5 to 105 L/min	5 V	20 mA
	90%	10%				
	80%	20%				
	70%	30%				
	60%	40%				
40%	60%					
PF2M711	30%	70%	1 to 60 L/min	-3 to 63 L/min	5 V	20 mA

\* When changing the max. analog output, use the analog free span function on page 28.

# PF2M7(-L) Series Function Details

For the setting of functions and operation methods, refer to the "Operation Manual" on the SMC website Documents/Download --> Instruction Manuals.

## ■ Output operation

The output operation can be selected from the following:

Output corresponding to instantaneous flow (Hysteresis mode, Window comparator mode)

- Hysteresis mode is the mode where the switch output will turn ON when the flow is greater than the set value, and will turn OFF when the flow falls below the set value by the amount of hysteresis or more.
- Window comparator mode is the mode where an operating mode in which the switch output is turned on and off depending on whether the flow is inside or outside the range of two set values.

Output corresponding to accumulated flow (Accumulated output mode, Accumulated pulse output mode)

- In accumulated output mode, the switch output will start at the set accumulated flow rate value.
- Accumulated pulse output is a pulse signal which is output every time a predefined accumulated flow has passed.

Others (Error output, Switch output OFF)

- The error output function outputs the switch output when an error is displayed.
- The switch output off function turns off the switch output.

\* Default setting: Hysteresis mode, Normal output

## ■ Simple setting mode

Only the set values for instantaneous flow and accumulated flow can be changed. The output mode, output type, display color, and accumulated pulse output cannot be changed.

## ■ Display color

The display color can be selected for each output status. The selection of the display color provides visual identification of abnormal values.

Green for ON, Red for OFF
Red for ON, Green for OFF
Red all the time
Green all the time

## ■ Reference condition

The display unit can be selected from standard condition or normal condition.

Standard condition: Flow rate converted to a volume at 20°C, 101.3 kPa (absolute pressure), and 65% RH
Normal condition: Flow rate converted to a volume at 0°C, 101.3 kPa (absolute pressure), and 0% RH

## ■ Delay time setting

The time from when the instantaneous flow reaches the set value to when the switch output operates can be set. Setting the delay time can prevent the switch output from chattering.

The total switching time is the switch operation time and the set delay time. (Default setting: 0 s)

0 to 0.10 s (Increments of 0.01 s)
0.1 to 1.0 s (Increments of 0.1 s)
1 to 10 s (Increments of 1 s)
20 s
30 s
40 s
50 s
60 s

## ■ Digital filter setting

The time for the digital filter can be set to the sensor input. Setting the digital filter can reduce chattering of the switch output and flickering of the analog output and the display.

The response time indicates when the set value is 90% in relation to the step input. (Default setting: 1 s)

0.05 s
0.1 s
0.5 s
1 s
2 s
5 s

## ■ Selectable analog output function

1 to 5 V or 0 to 10 V can be selected for the analog voltage output type. (Default setting: 1 to 5 V)

## ■ Forced output function

The output is forced ON/OFF when starting the system or during maintenance. This enables the confirmation of wiring and prevents system errors due to unexpected output.

For the analog output type: When ON, the output will be 5 V (or 10 V when 0 to 10 V is selected) or 20 mA, and when OFF, 1 V (or 0 V when 0 to 10 V is selected) or 4 mA.

\* Also, an increase or decrease of the flow will not change the ON/OFF status of the output while the forced output function is activated.

## ■ Accumulated value hold

The accumulated value will be stored even if the power supply is turned OFF. The accumulated value is memorized every 2 or 5 minutes during measurement and continues from the last memorized value when the power supply is turned ON again.

The max. writable limit of the memory device is 3.7 million times, which should be taken into consideration.

## ■ Peak/Bottom value display

The max. (min.) flow rate is detected and updated from when the power supply is turned ON. In peak (bottom) value display mode, this max. (min.) flow rate is displayed.

## ■ Display OFF mode

This function will turn the display OFF. In this mode, " \_ \_ \_ " will flash on the main screen. If any button is pressed during this mode, the display reverts to normal for 30 seconds to allow the flow, etc., to be quickly checked.

## ■ Setting of a security code

The user can select whether a security code must be entered to release the key lock. At the time of shipment from the factory, it is set such that a security code is not required.

## ■ Key-lock function

Prevents operation errors such as accidentally changing setting values

## ■ Reset to the default settings

The product can be returned to its factory default settings.

## ■ Reversible display mode

When the switch is used upside down, the orientation of the display can be rotated to make it easier to read by using the reversible display function.

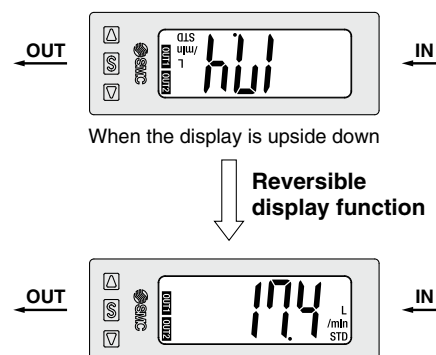

## ■ Zero cut-off function

When the flow is close to 0 L/min, the product will round the value down and zero will be displayed. A flow value may be displayed even when the flow rate is 0 L/min due to high pressure or depending on the installation. The zero cut-off function will force the display to zero.

## ■ Zero-clear function

The measured flow rate indication can be adjusted to zero.

The adjustment range is  $\pm 5\%$  F.S. of the initial factory setting.

## ■ Analog free span function

This function allows a flow that generates an output of 5 V (or 10 V when 0 to 10 V is selected) or 20 mA to be changed. The value can be changed between 10% of the max. value of the rated flow and the max. value of the display range.

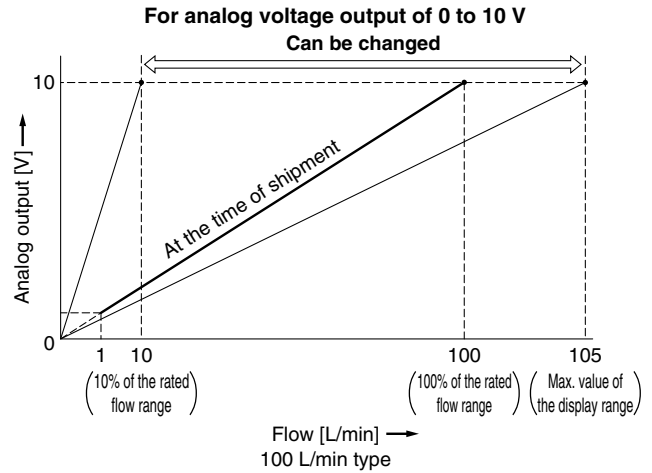
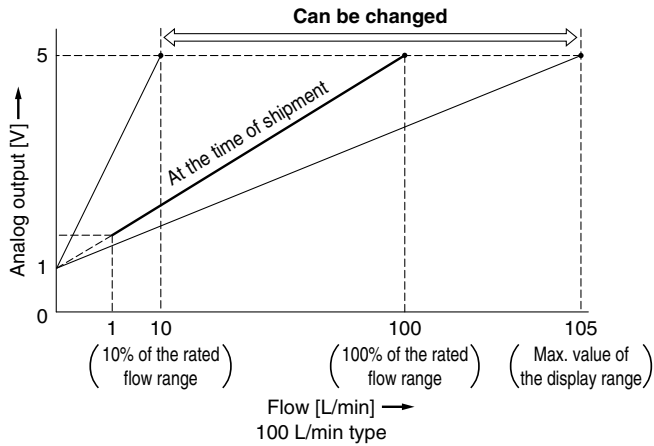

## ■ Error display function

When an error or abnormality arises, the location and contents are displayed.

Display	Error name	Description	Action
Er 1	OUT1 over current error	The switch output (OUT1) load current of 80 mA or more flows.	Turn the power OFF and remove the cause of the over current. Then turn the power ON again.
Er 2	OUT2 over current error	The switch output (OUT2) load current of 80 mA or more flows.	
HHH	Instantaneous flow error	The flow has exceeded the upper limit of the flow display range.	Decrease the flow rate.
LLL		The flow has exceeded the lower limit of the flow display range.	Change the flow to the correct direction.
999	Accumulated flow error*1	The accumulated flow has exceeded the accumulated flow range. (For accumulated increment) (The decimal point position varies depending on the flow range or measurement unit setting.)	Reset the accumulated flow. (Press the SET and DOWN buttons simultaneously for 1 s or longer.)
0		The accumulated flow has reached the set accumulated flow value. (For accumulated decrement) (The decimal point position varies depending on the flow range or measurement unit setting.)	
Er 3	Outside of zero-clear range	During zero-clear operation, the flow rate of $\pm 5\%$ F.S. or more is applied. (The mode is returned to measurement mode after 1 s.)	Retry the zero-clear operation without applying fluid.
Er 0	System error	An internal data error has occurred.	Turn the power OFF and turn it ON again.
Er 4			
Er 6			
Er 7			
Er 8			
Er 14			
Er 16			
Er 40			
Er 15	Version does not match*2	The IO-Link version does not match that of the master. The master uses version 1.0.	Ensure that the master IO-Link version matches the device version.

\*1 A decimal point will be displayed depending on the flow range or measurement unit setting.

\*2 Only for the IO-Link compatible products

\* If the error cannot be solved after the instructions above are performed, please contact SMC for investigation.

## ■ Unit display function

The unit displayed on the screen differs depending on the unit setting in measurement mode.

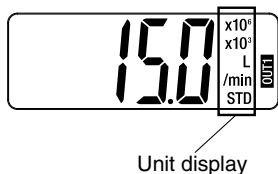



Standard condition (STD)	Instantaneous flow unit L/min	Accumulated flow unit L
<p>[STD] turns on.</p>	<p>[L] and [/min] turn on.</p>	<p>[L] turns on. At the upper right of the display, the index [x10<sup>3</sup>] or [x10<sup>6</sup>] will turn on based on the accumulated flow.</p>
<p>[STD] turns off.</p>	<p>[L] turns off and [/min] turns on.</p>	<p>[L] turns off. At the upper right of the display, the index [x10<sup>3</sup>] or [x10<sup>6</sup>] will turn on based on the accumulated flow.</p>

## Safety Instructions

These safety instructions are intended to prevent hazardous situations and/or equipment damage. These instructions indicate the level of potential hazard with the labels of “**Caution**,” “**Warning**” or “**Danger**.” They are all important notes for safety and must be followed in addition to International Standards (ISO/IEC)\*1), and other safety regulations.

 **Caution:** **Caution** indicates a hazard with a low level of risk which, if not avoided, could result in minor or moderate injury.

 **Warning:** **Warning** indicates a hazard with a medium level of risk which, if not avoided, could result in death or serious injury.

 **Danger :** **Danger** indicates a hazard with a high level of risk which, if not avoided, will result in death or serious injury.

\*1) ISO 4414: Pneumatic fluid power – General rules relating to systems.  
ISO 4413: Hydraulic fluid power – General rules relating to systems.  
IEC 60204-1: Safety of machinery – Electrical equipment of machines.  
(Part 1: General requirements)  
ISO 10218-1: Manipulating industrial robots – Safety.  
etc.

### Warning

#### 1. The compatibility of the product is the responsibility of the person who designs the equipment or decides its specifications.

Since the product specified here is used under various operating conditions, its compatibility with specific equipment must be decided by the person who designs the equipment or decides its specifications based on necessary analysis and test results. The expected performance and safety assurance of the equipment will be the responsibility of the person who has determined its compatibility with the product. This person should also continuously review all specifications of the product referring to its latest catalog information, with a view to giving due consideration to any possibility of equipment failure when configuring the equipment.

#### 2. Only personnel with appropriate training should operate machinery and equipment.

The product specified here may become unsafe if handled incorrectly. The assembly, operation and maintenance of machines or equipment including our products must be performed by an operator who is appropriately trained and experienced.

#### 3. Do not service or attempt to remove product and machinery/equipment until safety is confirmed.

1. The inspection and maintenance of machinery/equipment should only be performed after measures to prevent falling or runaway of the driven objects have been confirmed.
2. When the product is to be removed, confirm that the safety measures as mentioned above are implemented and the power from any appropriate source is cut, and read and understand the specific product precautions of all relevant products carefully.
3. Before machinery/equipment is restarted, take measures to prevent unexpected operation and malfunction.

#### 4. Contact SMC beforehand and take special consideration of safety measures if the product is to be used in any of the following conditions.

1. Conditions and environments outside of the given specifications, or use outdoors or in a place exposed to direct sunlight.
2. Installation on equipment in conjunction with atomic energy, railways, air navigation, space, shipping, vehicles, military, medical treatment, combustion and recreation, or equipment in contact with food and beverages, emergency stop circuits, clutch and brake circuits in press applications, safety equipment or other applications unsuitable for the standard specifications described in the product catalog.
3. An application which could have negative effects on people, property, or animals requiring special safety analysis.
4. Use in an interlock circuit, which requires the provision of double interlock for possible failure by using a mechanical protective function, and periodical checks to confirm proper operation.

### Caution

#### 1. The product is provided for use in manufacturing industries.

The product herein described is basically provided for peaceful use in manufacturing industries.  
If considering using the product in other industries, consult SMC beforehand and exchange specifications or a contract if necessary.  
If anything is unclear, contact your nearest sales branch.

### Limited warranty and Disclaimer/ Compliance Requirements

The product used is subject to the following “Limited warranty and Disclaimer” and “Compliance Requirements”.

Read and accept them before using the product.

#### Limited warranty and Disclaimer

1. The warranty period of the product is 1 year in service or 1.5 years after the product is delivered, whichever is first.\*2)  
Also, the product may have specified durability, running distance or replacement parts. Please consult your nearest sales branch.
2. For any failure or damage reported within the warranty period which is clearly our responsibility, a replacement product or necessary parts will be provided.  
This limited warranty applies only to our product independently, and not to any other damage incurred due to the failure of the product.
3. Prior to using SMC products, please read and understand the warranty terms and disclaimers noted in the specified catalog for the particular products.

##### \*2) Vacuum pads are excluded from this 1 year warranty.

A vacuum pad is a consumable part, so it is warranted for a year after it is delivered.  
Also, even within the warranty period, the wear of a product due to the use of the vacuum pad or failure due to the deterioration of rubber material are not covered by the limited warranty.

#### Compliance Requirements

1. The use of SMC products with production equipment for the manufacture of weapons of mass destruction (WMD) or any other weapon is strictly prohibited.
2. The exports of SMC products or technology from one country to another are governed by the relevant security laws and regulations of the countries involved in the transaction. Prior to the shipment of a SMC product to another country, assure that all local rules governing that export are known and followed.

### Caution

#### SMC products are not intended for use as instruments for legal metrology.

Measurement instruments that SMC manufactures or sells have not been qualified by type approval tests relevant to the metrology (measurement) laws of each country. Therefore, SMC products cannot be used for business or certification ordained by the metrology (measurement) laws of each country.

#### Revision History

**Edition B** \* The PF2M701, 702, and 705 have been added.  
\* A female thread type has been added.  
\* The IO-Link compatible PF2M7-L series has been added.  
\* Internal circuits and wiring examples have been revised.  
\* A made-to-order option (Compatible with argon (Ar) and carbon dioxide (CO<sub>2</sub>) mixed gas) has been added.  
\* Number of pages has been increased from 20 to 28. YU

**Edition C** \* A flow adjustment valve (0.05 to 5 L/min) has been added.  
\* A 2 to 200 L/min flow range option has been added.  
\* A rear ported type has been added.  
\* Number of pages has been increased from 28 to 32. ZV

## Safety Instructions

Be sure to read the “Handling Precautions for SMC Products” (M-E03-3) and “Operation Manual” before use.

# Low Particle Generation 2-Color Display Digital Flow Switch



0.1 to 10 L/min **PF2M710-X300**  
0.3 to 25 L/min **PF2M725-X300**  
0.5 to 50 L/min **PF2M750-X300**

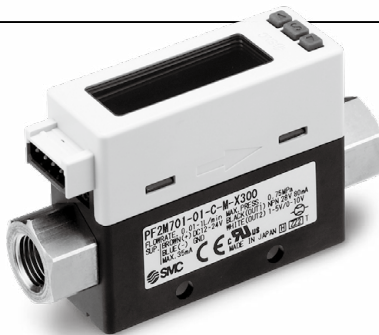

0.01 to 1 L/min **PF2M701-X300**  
0.02 to 2 L/min **PF2M702-X300**  
0.05 to 5 L/min **PF2M705-X300**



1 to 100 L/min **PF2M711-X300**  
2 to 200 L/min **PF2M721-X300**

## ● Particle Generation Characteristics (Reference Data)

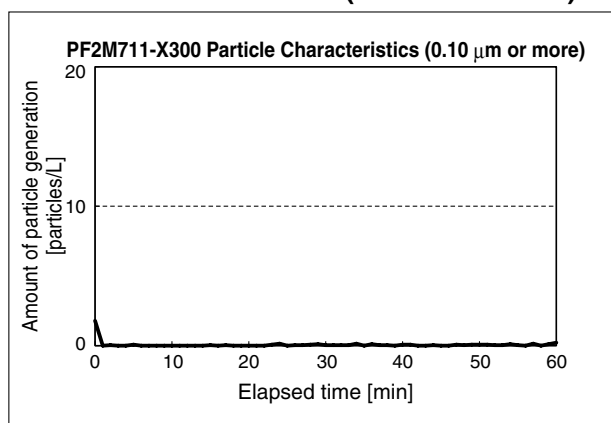

## ● Metal Material of Parts in Contact with Fluid: Stainless Steel 304

### <Application Example>

Flow control of a clean air blow in clean room environments



\* When the product is used for blowing, use caution to prevent the workpiece from being damaged by air entrained from the surrounding area.

## ● Specifications

<b>Ultrasonic cleaning</b>	Metal parts in contact with fluid: Fitting, Mesh
<b>Degreasing treatment</b>	Body, O-ring
<b>Air blow</b>	Air blow of the fluid passage*1
<b>Clean packaging</b>	Antistatic bag (Double packaged)

\*1 With Class 100 air in a Class 10000 clean room

## ● IO-Link Compatible

The flow rate value and the device status can be figured out easily via the process data.

<b>Diagnosis items</b>	Over current error, Outside of rated flow range, Accumulated flow error, Internal product malfunction
------------------------	---

Series	Applicable fluid	Detection method	Smallest settable increment	Rated flow range [L/min]															
				0.01	0.02	0.05	0.1	0.3	0.5	1	2	5	10	20	25	50	100	150	200
<b>PF2M7-X300</b> 	Dry air N <sub>2</sub> Ar CO <sub>2</sub>	Thermal type (MEMS)	0.001 L/min	0.01	0.02	0.05	0.1	0.3	0.5	1	2	5	10	20	25	50	100	150	200
			0.01 L/min	0.01	0.02	0.05	0.1	0.3	0.5	1	2	5	10	20	25	50	100	150	200
			0.1 L/min	0.01	0.02	0.05	0.1	0.3	0.5	1	2	5	10	20	25	50	100	150	200
			1 L/min	0.01	0.02	0.05	0.1	0.3	0.5	1	2	5	10	20	25	50	100	150	200

# PF2M7-X300



# PF2M7-X300

# Particle Generation Characteristics

## Measuring Method

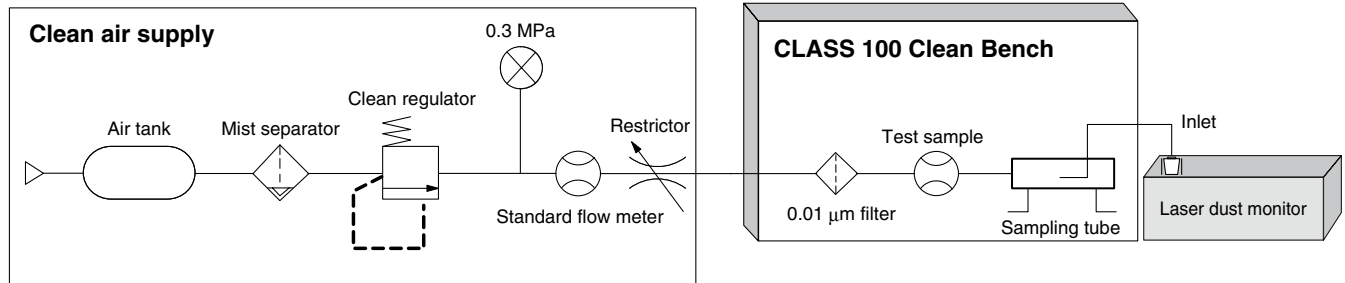

### [Test Method]

Place a sampling tube at the latter stage of the test sample and measure the number of generated particles with a laser dust monitor.

### [Measuring Conditions]

Measuring instrument	Description	Automatic particle counter using the light scattering method
		Minimum measurable particle diameter
	Suction flow rate	28 L/min
Setting conditions	Sampling time	1 min
	Interval time	4 min
	Sampling air flow	28 L

\* The flow rate used during measuring is the max. rated flow of the test sample.

## Particle Generation Characteristics (Reference Data)

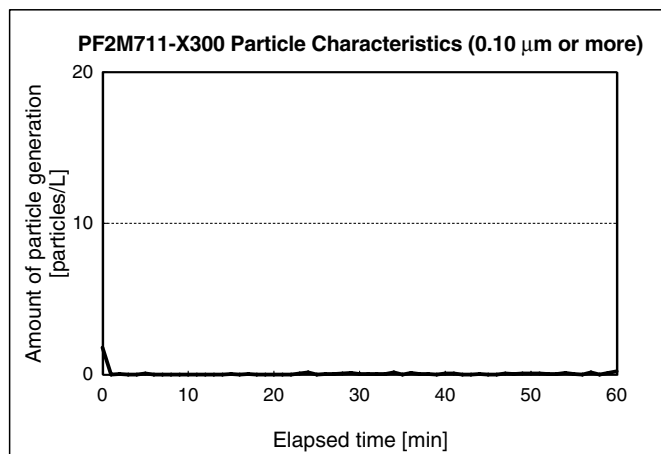
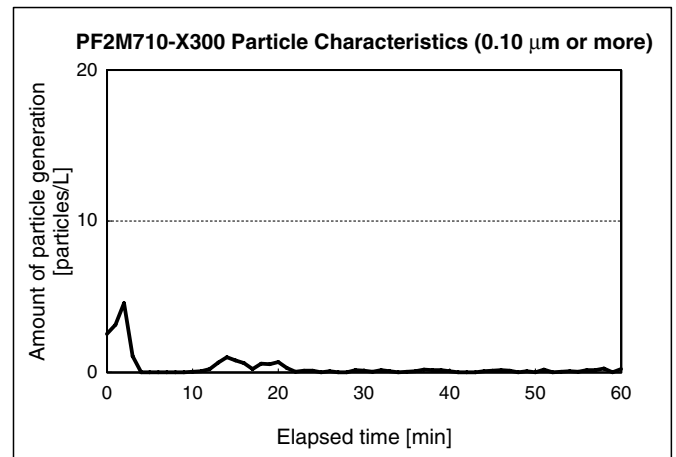
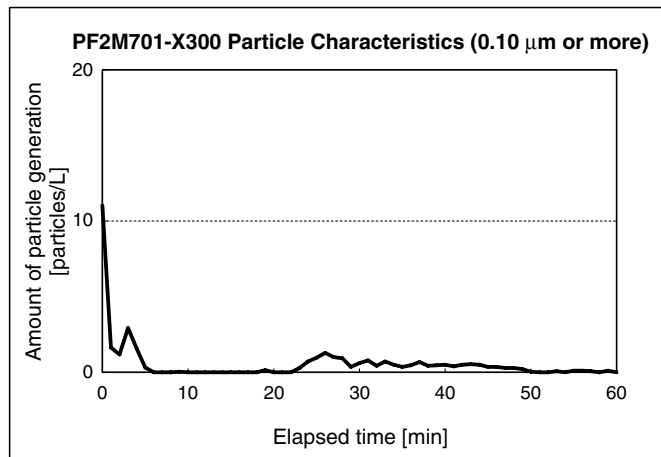



# Low Particle Generation 2-Color Display

## Digital Flow Switch

# PF2M7-X300



### How to Order

PF2M7 **10** - **01** - **A** **□** - **M** **□** **□** - X300

Integrated display ● ① ② ③ ④ ⑤ ⑥ ⑦

#### ① Rated flow range

01	0.01 to 1 L/min	25	0.3 to 25 L/min
02	0.02 to 2 L/min	50	0.5 to 50 L/min
05	0.05 to 5 L/min	11	1 to 100 L/min
10	0.1 to 10 L/min	21	2 to 200 L/min

#### ② Port size

Symbol	Port size	Rated flow range							
		01	02	05	10	25	50	11	21
01	Rc1/8	●	●	●	●	●	●	—	—
02	Rc1/4	—	—	—	—	—	—	—	●

#### ③ Output specification

Symbol	OUT1	OUT2
A	NPN	NPN
B	PNP	PNP
C	NPN	Analog 1 to 5 V ⇔ Analog 0 to 10 V*1
D	NPN	Analog 4 to 20 mA
E	PNP	Analog 1 to 5 V ⇔ Analog 0 to 10 V*1
F	PNP	Analog 4 to 20 mA
L	IO-Link/NPN/PNP	—
L2	IO-Link/NPN/PNP	NPN/PNP/External input
L3	IO-Link/NPN/PNP	Analog 1 to 5 V ⇔ Analog 0 to 10 V*1
L4	IO-Link/NPN/PNP	Analog 4 to 20 mA

\*1 1 to 5 V or 0 to 10 V can be selected by pressing the button.  
The default setting is 1 to 5 V.

#### ④ Option 1

Nil	W
Lead wire with connector (2 m)	Lead wire with connector (2 m) + Connector cover (Silicone rubber)
<b>10-ZS-33-D</b>	<b>10-ZS-33-F</b> + <b>10-ZS-33-D</b>
* Interchangeable with the existing PFM7 series	* Interchangeable with the existing PFM7 series
N	Q
Without lead wire with connector	M12 conversion lead wire (0.1 m)

#### ⑤ Unit specification

M	SI unit only*2
Nil	Unit selection function*3

\*2 Fixed unit: Instantaneous flow: L/min  
Accumulated flow: L

\*3 This product is for overseas use only. (The SI unit type is provided for use in Japan in accordance with the New Measurement Act.)  
The unit can be changed.  
Instantaneous flow: L/min ⇔ cfm  
Accumulated flow: L ⇔ ft<sup>3</sup>

#### ⑦ Calibration certificate\*4

Nil	None
A	Yes

\*4 Made to order  
The certificate is in both English and Japanese.

#### ⑥ Option 2

Nil	R	T
Without bracket	Bracket (For the type without a flow adjustment valve) <b>10-ZS-33-M</b>	Panel mount adapter (For the type without a flow adjustment valve) <b>10-ZS-33-2J</b>
	With 2 tapping screws (3 x 6)	Panel mount adapter Panel mount adapter B Panel Mounting bracket
	* Interchangeable with the existing PFM series	

\* Options are shipped together with the product but do not come assembled.

### DIN Rail Mounting Bracket (Ordered Separately)

**10-ZS-33-R** **3**

\* Interchangeable with the existing PFM series

Stations	
1	1 station
2	2 stations
3	3 stations
4	4 stations
5	5 stations

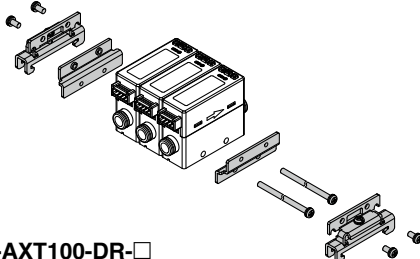

DIN rail part number: 10-AXT100-DR-□

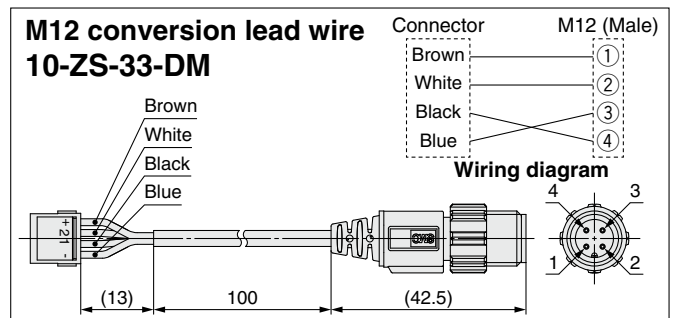

# PF2M7-X300

Refer to the **Web Catalog** for flow switch precautions. For details on the specific product precautions, refer to the "Operation Manual" on the SMC website.

## Specifications/PF2M7-X300

Model		PF2M701-X300	PF2M702-X300	PF2M705-X300	PF2M710-X300	PF2M725-X300	PF2M750-X300	PF2M711-X300	PF2M721-X300		
Fluid	Applicable fluid*1	Dry air, N <sub>2</sub> , Ar, CO <sub>2</sub> (JIS B 8392-1 1.1.2 to 1.6.2, ISO 8573-1 1.1.2 to 1.6.2)									
	Fluid temperature range	0 to 50°C									
Flow	Detection method	Thermal type (Main flow type)			Thermal type (Bypass flow type)						
	Rated flow range [L/min]	Dry air, N <sub>2</sub> , Ar	0.01 to 1	0.02 to 2	0.05 to 5	0.1 to 10	0.3 to 25	0.5 to 50	1 to 100	2 to 200	
		CO <sub>2</sub>	0.01 to 0.5	0.02 to 1	0.05 to 2.5	0.1 to 5	0.3 to 12.5	0.5 to 25	1 to 50	2 to 100	
	Set point range	Instantaneous flow [L/min]	-0.05 to 1.05	-0.1 to 2.1	-0.25 to 5.25	-0.5 to 10.5	-1.3 to 26.3	-2.5 to 52.5	-5 to 105	-10 to 210	
		Accumulated flow [L]	0.00 to 9999999.99								
	Smallest settable increment	Instantaneous flow [L/min]	0.001			0.01			0.1		1
		Accumulated flow [L]	0.01		0.1			1		1	
Accumulated volume per pulse [L/pulse]	0.01			0.1			1		1		
Accumulated value hold function*2	Intervals of 2 or 5 minutes can be selected.										
Pressure	Operating pressure range	-0.1 to 0.75 MPa									
	Rated pressure range*3	-0.07 to 0.75 MPa									
	Proof pressure	1.0 MPa									
	Pressure loss	Refer to the "Pressure Loss" graph.									
	Pressure characteristics	±5% F.S. ±1 digit (0.35 MPa standard)									
Electrical	Power supply voltage*4	For the switch output device	12 to 24 VDC ±10%								
		For the IO-Link device	18 to 30 VDC ±10%								
	Current consumption	35 mA or less									
Protection	Polarity protection										
Accuracy*5	Display accuracy	±3% F.S. ±1 digit									
	Analog output accuracy	±3% F.S.									
	Repeatability	±1% F.S. ±1 digit (±2% F.S. ±1 digit when the digital filter is set to 0.05 s)									
	Temperature characteristics	±3% F.S. ±1 digit (15 to 35°C: 25°C standard) ±5% F.S. ±1 digit (0 to 50°C: 25°C standard)									
Switch output	Output type	NPN/PNP open collector									
	Output mode	Select from Hysteresis, Window comparator, Accumulated output, Accumulated pulse output, Error output, or Switch output OFF modes.									
	Switch operation	Select from Normal or Reversed output.									
	Max. load current	80 mA									
	Max. applied voltage	Standard	28 VDC (NPN only)								
		IO-Link compatible	30 VDC (NPN only)								
	Internal voltage drop	Standard	NPN: 1 V or less (Load current: 80 mA)			PNP: 1.5 V or less (Load current: 80 mA)					
		IO-Link compatible	1.5 V or less (Load current: 80 mA)								
	Response time*6	50 ms or less									
	Delay time*7	Select from 0 to 0.10 s (increment of 0.01 s), 0.1 to 1.0 s (increment of 0.1 s), 1 to 10 s (increment of 1 s), 20 s, 30 s, 40 s, 50 s, or 60 s.									
Hysteresis*8	Variable from 0										
Protection	Short circuit protection										
Analog output*9	Output type	Voltage output: 1 to 5 V, 0 to 10 V (only when the power supply voltage is 24 VDC)*10, Current output: 4 to 20 mA									
	Impedance	Voltage output	Output impedance: Approx. 1 kΩ								
		Current output	Maximum load impedance: 600 Ω at power supply voltage of 24 V, 300 Ω at power supply voltage of 12 V								
	Response time*6	50 ms ±40%									
Display	Reference condition*11	Select from Standard condition (STD) or Normal condition (NOR).									
	Display mode	Select from Instantaneous flow or Accumulated flow.									
	Unit*12	Instantaneous flow	L/min, cfm								
		Accumulated flow	L, ft <sup>3</sup>								
	Display range	Instantaneous flow [L/min]	-0.05 to 1.05	-0.1 to 2.1	-0.25 to 5.25	-0.5 to 10.5	-1.3 to 26.3	-2.5 to 52.5	-5 to 105	-10 to 210	
		Zero cut-off range	0 to ±10% F.S. (Select per 1% F.S. for the maximum rated flow rate.)								
	Accumulated flow [L]*13	0.00 to 9999999.99	0.0 to 99999999.9	0.0 to 999999999.9	0 to 999999999						
Display	LCD, Color: Red/Green, 4 digits, 7 segments										
Indicator LED	LED ON when switch output is ON (OUT1/2: Orange)										
Digital filter*14	Select from 0.05 s, 0.1 s, 0.5 s, 1 s, 2 s, or 5 s.										
Environmental resistance	Enclosure	IP40									
	Withstand voltage	1000 VAC for 1 minute between terminals and housing									
	Insulation resistance	50 MΩ or more (500 VDC measured via megohmmeter) between terminals and housing									
	Operating temperature range	Operating: 0 to 50°C, Stored: -10 to 60°C (No condensation or freezing)									
	Operating humidity range	Operating/Stored: 35 to 85% RH (No condensation or freezing)									
Standards	CE marking (EMC Directive, RoHS Directive), UL (CSA)										
Piping*15	Piping specification	Screw-in (Rc)						01 (Rc1/8)		02 (Rc1/4)	
	Piping entry direction	Straight									
Main materials of parts in contact with fluid	PPS, FKM, Stainless steel 304, Si, Au, GE4F										
Weight	Body	Screw-in						60 g		72 g	
	Lead wire	+35 g									
	Bracket	+20 g									
	Panel mount adapter	+15 g									
	DIN rail mounting bracket	+65 g									
Cleanliness class (ISO class)	Class 4										

- \*1 Refer to the "Recommended pneumatic circuit examples" on page 4.
- \*2 When using the accumulated value hold function, use the operating conditions to calculate the product life, and do not exceed it. The maximum access limit of the memory device is 3.7 million times. If the product is operated 24 hours per day, the product life will be as follows:
  - 5 min interval: life is calculated as 5 min x 3.7 million = 18.5 million min = 35 years
  - 2 min interval: life is calculated as 2 min x 3.7 million = 7.4 million min = 14 years
- \*3 Negative pressure indicates the pressure value on the IN side (inlet side).
- \*4 When multiple products are installed closely, the upper limit of the power supply voltage is 24 VDC.
- \*5 The accuracy value is based on dry air as a fluid. For other fluids, it is a reference value.
- \*6 Value when the digital filter is set at 0.05 s
- \*7 The time from when the instantaneous flow reaches the set value to when the switch output operates can be set.
- \*8 If the flow fluctuates around the set value, the hysteresis must be set to a value more than the fluctuating width. Otherwise, chattering will occur.
- \*9 When using a product with an analog output
- \*10 When selecting 0 to 10 V, refer to the analog output graph for the allowable load current.
- \*11 Standard condition (STD): 20 [°C], 101.3 [kPa] (Absolute pressure), 65 [% RH] (The flow rate given in the specifications is the value under standard conditions.)  
Normal condition (NOR): 0 [°C], 101.3 [kPa] (Absolute pressure), 0 [% RH]
- \*12 Setting is only possible for models with the unit selection function.
- \*13 Power value is displayed for accumulated flow. The first 4 digits of the measurement value are always displayed.
- \*14 The time for the digital filter can be set to the sensor input. The response time indicates when the set value is 90% in relation to the step input.
- \*15 Some piping conditions may have negative effects on the flow accuracy.
- \* Products with tiny scratches, marks, or display color or brightness variations which do not affect the performance of the product are verified as conforming products.

**Communication Specifications (IO-Link mode)**

<b>IO-Link type</b>	Device	
<b>IO-Link version</b>	V1.1	
<b>Communication speed</b>	COM2 (38.4 kbps)	
<b>Minimum cycle time</b>	3.4 ms	
<b>Process data length</b>	Input data: 4 bytes, Output data: 0 byte	
<b>On request data communication</b>	Yes	
<b>Data storage function</b>	Yes	
<b>Event function</b>	Yes	
<b>Vendor ID</b>	131 (0 x 0083)	
<b>Device ID</b>	PF2M701-□-L□-□□□-X300 : 0 x 00016D (365) PF2M701-□-L2□-□□□-X300: 0 x 00016E (366) PF2M701-□-L3□-□□□-X300: 0 x 00016F (367) PF2M701-□-L4□-□□□-X300: 0 x 000170 (368)  PF2M702-□-L□-□□□-X300 : 0 x 000171 (369) PF2M702-□-L2□-□□□-X300: 0 x 000172 (370) PF2M702-□-L3□-□□□-X300: 0 x 000173 (371) PF2M702-□-L4□-□□□-X300: 0 x 000174 (372)  PF2M705-□-L□-□□□-X300 : 0 x 000175 (373) PF2M705-□-L2□-□□□-X300: 0 x 000176 (374) PF2M705-□-L3□-□□□-X300: 0 x 000177 (375) PF2M705-□-L4□-□□□-X300: 0 x 000178 (376)  PF2M710-□-L□-□□□-X300 : 0 x 000179 (377) PF2M710-□-L2□-□□□-X300: 0 x 00017A (378) PF2M710-□-L3□-□□□-X300: 0 x 00017B (379) PF2M710-□-L4□-□□□-X300: 0 x 00017C (380)	PF2M725-□-L□-□□□-X300 : 0 x 00017D (381) PF2M725-□-L2□-□□□-X300: 0 x 00017E (382) PF2M725-□-L3□-□□□-X300: 0 x 00017F (383) PF2M725-□-L4□-□□□-X300: 0 x 000180 (384)  PF2M750-□-L□-□□□-X300 : 0 x 000181 (385) PF2M750-□-L2□-□□□-X300: 0 x 000182 (386) PF2M750-□-L3□-□□□-X300: 0 x 000183 (387) PF2M750-□-L4□-□□□-X300: 0 x 000184 (388)  PF2M711-□-L□-□□□-X300 : 0 x 000185 (389) PF2M711-□-L2□-□□□-X300: 0 x 000186 (390) PF2M711-□-L3□-□□□-X300: 0 x 000187 (391) PF2M711-□-L4□-□□□-X300: 0 x 000188 (392)  PF2M721-□-L□-□□□-X300 : 0 x 00023B (571) PF2M721-□-L2□-□□□-X300: 0 x 00023C (572) PF2M721-□-L3□-□□□-X300: 0 x 00023D (573) PF2M721-□-L4□-□□□-X300: 0 x 00023E (574)

**Process Data**

Bit offset	Item	Note
0	OUT1 output	0: OFF 1: ON
1	OUT2 output	0: OFF 1: ON
8	Diagnosis (flow rate)	0: Within range 1: Out of range (HHH/LLL)
14	Fixed output	0: Normal output 1: Fixed output
15	Diagnosis (error)	0: Error not generated 1: Error generated
16 to 31	Measured flow rate value	Signed 16 bit

Diagnosis items
<ul style="list-style-type: none"> <li>· Over current error</li> <li>· Outside of rated flow range</li> <li>· Accumulated flow error</li> <li>· Internal product malfunction</li> </ul>

Bit offset	31	30	29	28	27	26	25	24	23	22	21	20	19	18	17	16
Item	Measured flow rate value (PD)															
Bit offset	15	14	13	12	11	10	9	8	7	6	5	4	3	2	1	0
Item	Error	Fixed	Reservation				Flow rate	Reservation				OUT2	OUT1			
	Diagnosis	Output					Diagnosis					Switch output				

# PF2M7-X300

## Recommended Pneumatic Circuit Examples

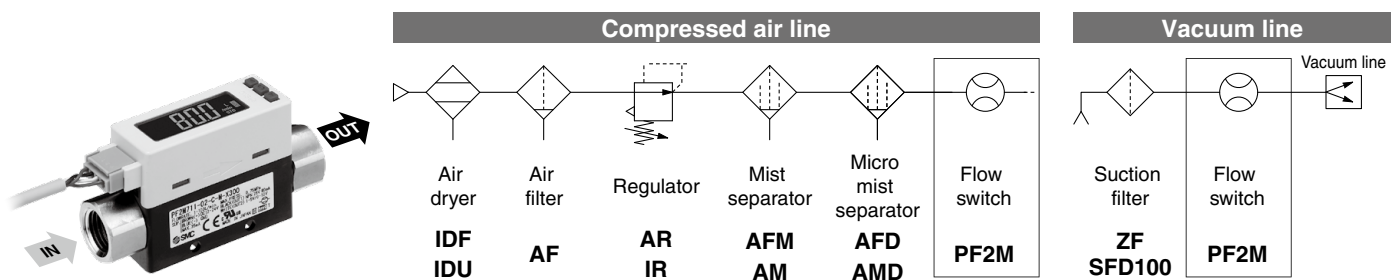

\* Recommended air quality class: JIS B 8392-1 1.1.2 to 1.6.2 (ISO 8753-1 1.1.2 to 1.6.2)

## Set Point Range and Rated Flow Range

### Set the flow rate within the rated flow range.

The set point range is the range of flow rate that can be set in the switch.

The rated flow range is the range that satisfies the switch specifications (accuracy, linearity, etc.).

It is possible to set a value outside of the rated flow range if it is within the set point range, however, the satisfaction of specifications can not be guaranteed. The flow range if using CO<sub>2</sub> is given in brackets.

### PF2M7-X300

Model	Flow range [L/min]										
	-10	-5	0	1	2	5	10	25	50	100	200
PF2M701			0.01 L/min	1.0 L/min (0.5 L/min)							
			-0.05 L/min	1.05 L/min (0.525 L/min)							
			-0.05 L/min	1.05 L/min (0.525 L/min)							
PF2M702			0.02 L/min	2.0 L/min (1 L/min)							
			-0.1 L/min	2.1 L/min (1.05 L/min)							
			-0.1 L/min	2.1 L/min (1.05 L/min)							
PF2M705			0.05 L/min	5.0 L/min (2.5 L/min)							
			-0.25 L/min	5.25 L/min (2.63 L/min)							
			-0.25 L/min	5.25 L/min (2.63 L/min)							
PF2M710			0.1 L/min	10.0 L/min (5 L/min)							
			-0.5 L/min	10.5 L/min (5.25 L/min)							
			-0.5 L/min	10.5 L/min (5.25 L/min)							
PF2M725			0.3 L/min	25.0 L/min (12.5 L/min)							
			-1.3 L/min	26.3 L/min (13.1 L/min)							
			-1.3 L/min	26.3 L/min (13.1 L/min)							
PF2M750			0.5 L/min	50.0 L/min (25 L/min)							
			-2.5 L/min	52.5 L/min (26.3 L/min)							
			-2.5 L/min	52.5 L/min (26.3 L/min)							
PF2M711			1.0 L/min	100.0 L/min (50 L/min)							
			-5.0 L/min	105.0 L/min (52.5 L/min)							
			-5.0 L/min	105.0 L/min (52.5 L/min)							
PF2M721			2 L/min	200 L/min (100 L/min)							
			-10 L/min	210 L/min (105 L/min)							
			-10 L/min	210 L/min (105 L/min)							

## Flow/Analog Output

	A	B		C
		PF2M701/02/05 /10/50/11/21-X300	PF2M725-X300	
Voltage output (1 to 5 V)	1 V	1.04 V	1.05 V	5 V
Current output (4 to 20 mA)	4 mA	4.16 mA	4.19 mA	20 mA

	E	F		G
		PF2M701/02/05 /10/50/11/21-X300	PF2M725-X300	
Voltage output (0 to 10 V)*1	0 V	0.10 V	0.12 V	10 V

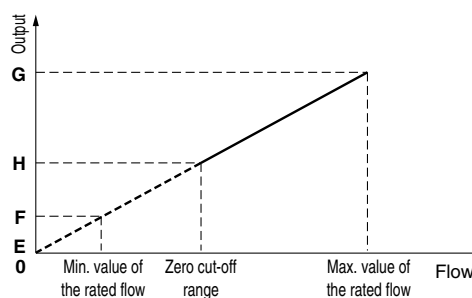
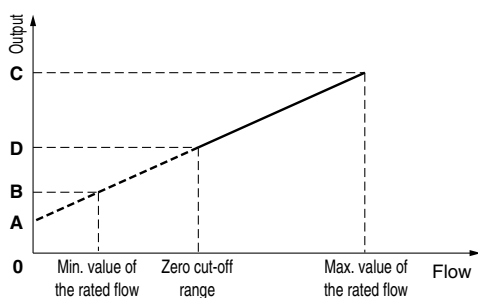

\*1 The analog output current from the connected equipment should be 20 μA or less when selecting 0 to 10 V.

When 20 μA or more current flows, it is possible that the accuracy is not satisfied at less than or equal to 0.5 V.

\* D or H fluctuates depending on the setting of the zero cut-off function.

When the zero cut-off function is set to "0," the flow rate display value starts from 0 L/min., but in conditions other than horizontal installation and supply pressure of 0.35 MPa, the output may not be 0 L/min.

# PF2M7-X300

## Internal Circuits and Wiring Examples

### NPN + NPN output type

PF2M7□□-□-A□-□□□-X300

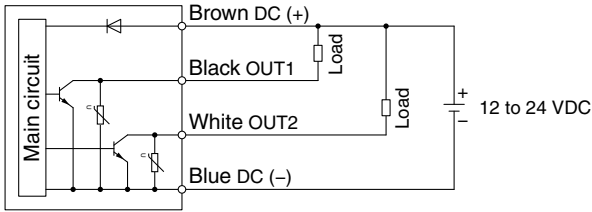

Max. applied voltage: 28 V, Max. load current: 80 mA,  
Internal voltage drop: 1 V or less

### PNP + PNP output type

PF2M7□□-□-B□-□□□-X300

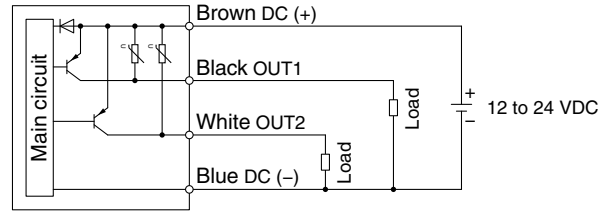

Max. load current: 80 mA, Internal voltage drop: 1.5 V or less

### NPN + Analog output type

PF2M7□□-□-C/D□-□□□-X300

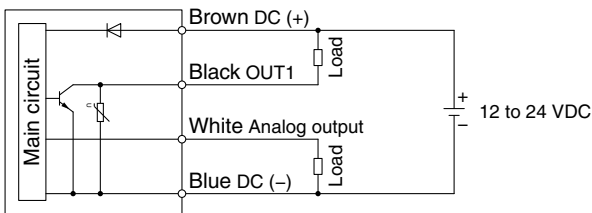

Max. applied voltage: 28 V, Max. load current: 80 mA,  
Internal voltage drop: 1 V or less

**C:** Analog output: 1 to 5 V or 0 to 10 V can be selected.

Output impedance: 1 k $\Omega$

**D:** Analog output: 4 to 20 mA

Load impedance: 50 to 600  $\Omega$

### PNP + Analog output type

PF2M7□□-□-E/F□-□□□-X300

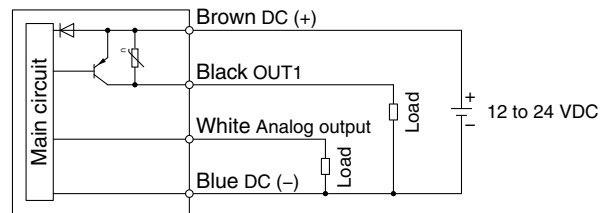

Max. load current: 80 mA, Internal voltage drop: 1.5 V or less

**E:** Analog output: 1 to 5 V or 0 to 10 V can be selected.

Output impedance: 1 k $\Omega$

**F:** Analog output: 4 to 20 mA

Load impedance: 50 to 600  $\Omega$

## Accumulated pulse output wiring examples

### NPN + NPN output type

PF2M7□□-□-A□-□□□-X300

### NPN + Analog output type

PF2M7□□-□-C□-□□□-X300

PF2M7□□-□-D□-□□□-X300

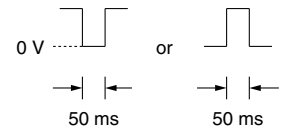
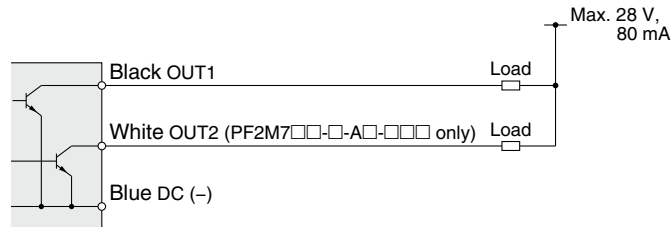

### PNP + PNP output type

PF2M7□□-□-B□-□□□-X300

### PNP + Analog output type

PF2M7□□-□-E□-□□□-X300

PF2M7□□-□-F□-□□□-X300

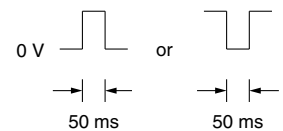
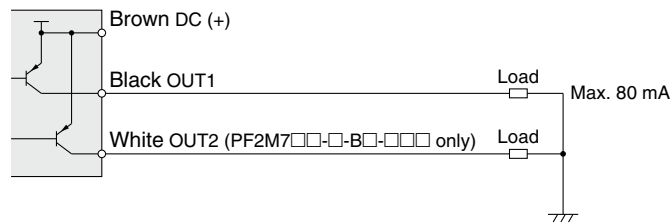

## Internal Circuits and Wiring Examples

### PF2M7□□-□-□-□□□-X300

#### NPN output type

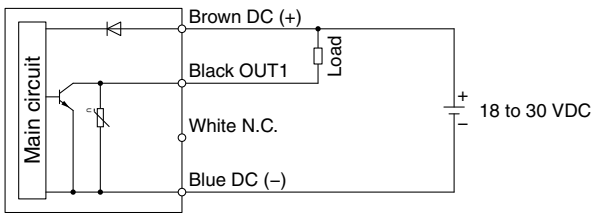

Max. applied voltage: 30 V, Max. load current: 80 mA,  
Internal voltage drop: 1.5 V or less

#### PNP output type

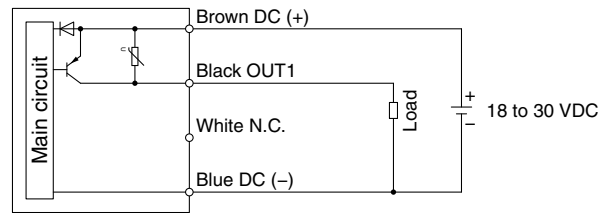

Max. load current: 80 mA, Internal voltage drop: 1.5 V or less

### PF2M7□□-□-□-□□□-X300

#### NPN 2 output type

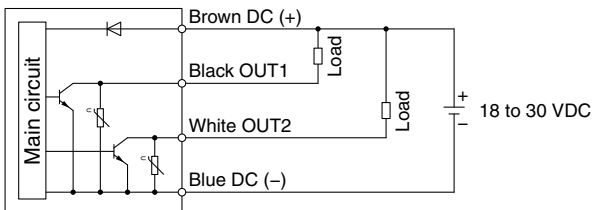

Max. applied voltage: 30 V, Max. load current: 80 mA,  
Internal voltage drop: 1.5 V or less

#### PNP 2 output type

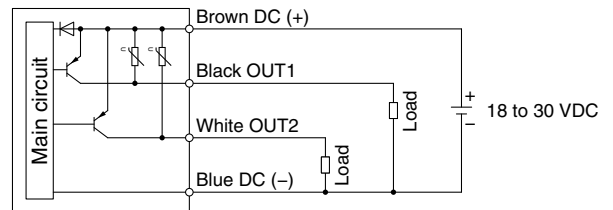

Max. load current: 80 mA, Internal voltage drop: 1.5 V or less

#### NPN + External input type

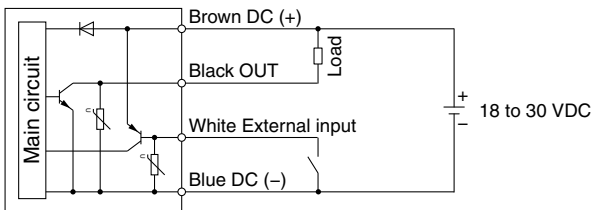

Max. applied voltage: 30 V, Max. load current: 80 mA,  
Internal voltage drop: 1.5 V or less

#### PNP + External input type

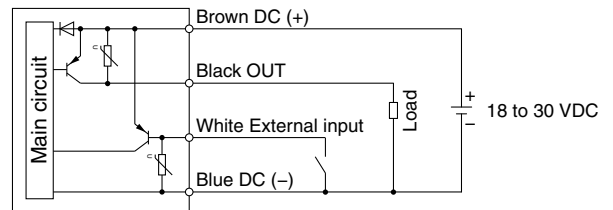

Max. load current: 80 mA, Internal voltage drop: 1.5 V or less

### PF2M7□□-□-□-□□□-X300

#### L3: NPN + Analog voltage output type

#### L4: NPN + Analog current output type

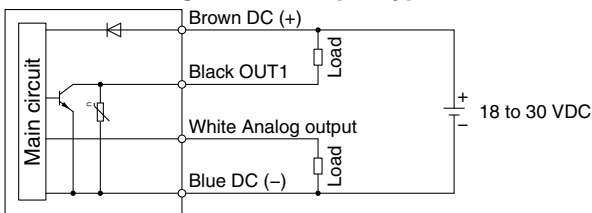

Max. applied voltage: 30 V, Max. load current: 80 mA,  
Internal voltage drop: 1.5 V or less

**L3:** Analog output: 1 to 5 V or 0 to 10 V can be selected.  
Output impedance: 1 kΩ

**L4:** Analog output: 4 to 20 mA  
Load impedance: 50 to 600 Ω

#### L3: PNP + Analog voltage output type

#### L4: PNP + Analog current output type

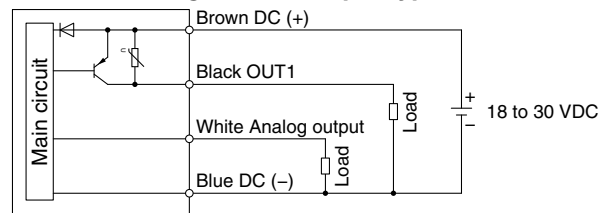

Max. load current: 80 mA, Internal voltage drop: 1.5 V or less

**L3:** Analog output: 1 to 5 V or 0 to 10 V can be selected.

Output impedance: 1 kΩ

**L4:** Analog output: 4 to 20 mA

Load impedance: 50 to 600 Ω

#### When used as an IO-Link device

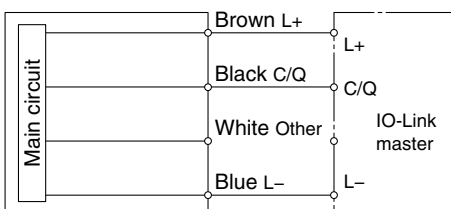





### Construction: Parts in Contact with Fluid

#### PF2M□-01/02-X300

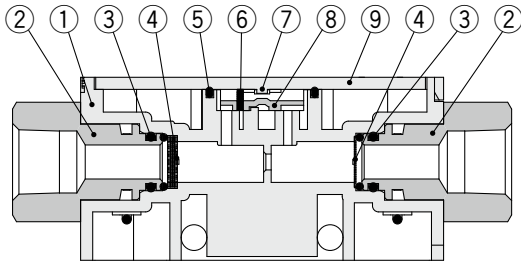

PF2M705/710/725/750-01-X300

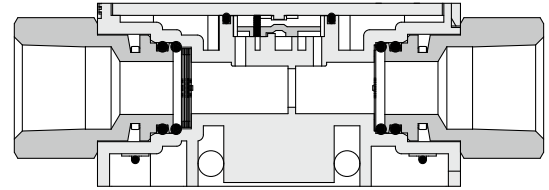

PF2M711/721-02-X300

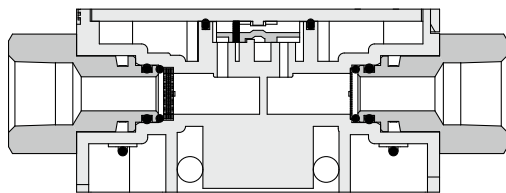

PF2M701/702-01-X300

\* There is no bypass construction for the 1 and 2 L ranges.

#### Component Parts

No.	Description	Material	Note
1	Body	PPS	
2	Fitting for piping	Stainless steel 304	
3	O-ring	FKM	
4	Flow rectifier	Stainless steel 304	
5	Seal	FKM	
6	Flow rectifier	Stainless steel 304	
7	Sensor chip	Silicon	
8	Body B	PPS	
9	Printed circuit board	GE4F	

### Dimensions

#### PF2M□-01/02-X300

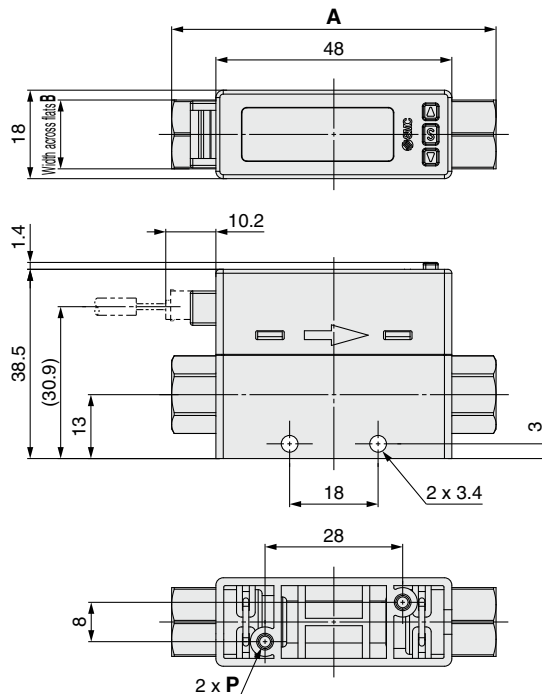
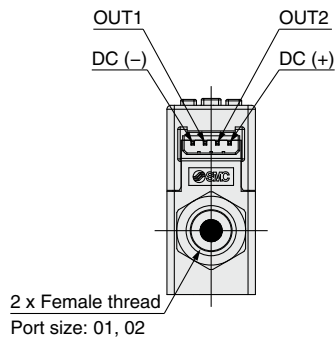

Model	A	B	P
PF2M701/702/705/710/725/750-01-X300	66	14	ø2.8 depth 8.4
PF2M711/721-02-X300	70	17	ø2.8 depth 6.2

### ⚠ Precautions

Flush the piping line before when the product for the first time and after it has been replaced. Also, if piping, etc., is to be connected, flush (air blow) using this product for the first time in order to reduce the effects of the dust generated from the connection, etc. Flushing the line is also required to eliminate contamination resulting from the installation of piping lines. Therefore, be sure to flush the line before running the system. Make sure all mounting parts are secure before use.

 **Safety Instructions** Be sure to read the "Handling Precautions for SMC Products" (M-E03-3) and "Operation Manual" before use.

## SMC Corporation

Akihabara UDX 15F,  
4-14-1, Sotokanda, Chiyoda-ku, Tokyo 101-0021, JAPAN  
Phone: 03-5207-8249 Fax: 03-5298-5362  
<http://www.smcworld.com>  
© 2017 SMC Corporation All Rights Reserved

Specifications are subject to change without prior notice  
and any obligation on the part of the manufacturer.

D-G

# Low Particle Generation 2-Color Display Digital Flow Switch



0.1 to 10 L/min **PF2M710-X300**  
 0.3 to 25 L/min **PF2M725-X300**  
 0.5 to 50 L/min **PF2M750-X300**

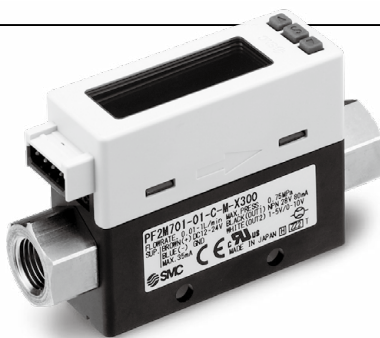

0.01 to 1 L/min **PF2M701-X300**  
 0.02 to 2 L/min **PF2M702-X300**  
 0.05 to 5 L/min **PF2M705-X300**

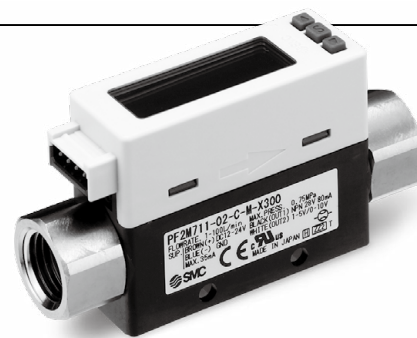

1 to 100 L/min **PF2M711-X300**  
 2 to 200 L/min **PF2M721-X300**

## ● Particle Generation Characteristics (Reference Data)

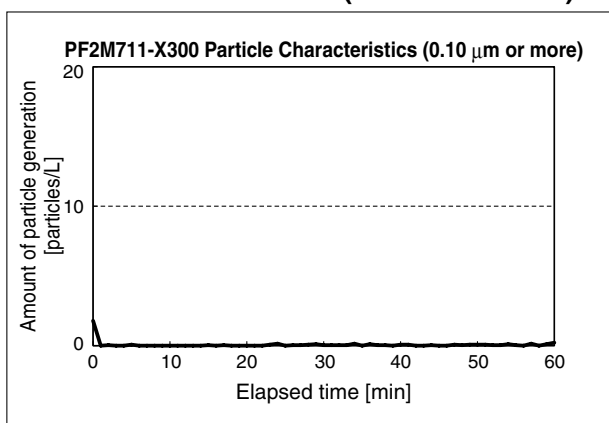

## ● Metal Material of Parts in Contact with Fluid: Stainless Steel 304

### <Application Example>

Flow control of a clean air blow in clean room environments



\* When the product is used for blowing, use caution to prevent the workpiece from being damaged by air entrained from the surrounding area.

## ● Specifications

<b>Ultrasonic cleaning</b>	Metal parts in contact with fluid: Fitting, Mesh
<b>Degreasing treatment</b>	Body, O-ring
<b>Air blow</b>	Air blow of the fluid passage*1
<b>Clean packaging</b>	Antistatic bag (Double packaged)

\*1 With Class 100 air in a Class 10000 clean room

## ● IO-Link Compatible

The flow rate value and the device status can be figured out easily via the process data.

<b>Diagnosis items</b>	Over current error, Outside of rated flow range, Accumulated flow error, Internal product malfunction
------------------------	---

Series	Applicable fluid	Detection method	Smallest settable increment	Rated flow range [L/min]															
				0.02	0.01	0.05	0.1	0.3	0.5	1	2	5	10	20	25	50	100	150	200
<b>PF2M7-X300</b> 	Dry air N <sub>2</sub> Ar CO <sub>2</sub>	Thermal type (MEMS)	0.001 L/min	0.01	1														
			0.01 L/min	0.02	2														
				0.05	5														
			0.1 L/min	0.1	10														
0.3	25																		
1 L/min	0.5	50																	
	1	100																	
			2	200															

# PF2M7-X300



# PF2M7-X300

# Particle Generation Characteristics

## Measuring Method

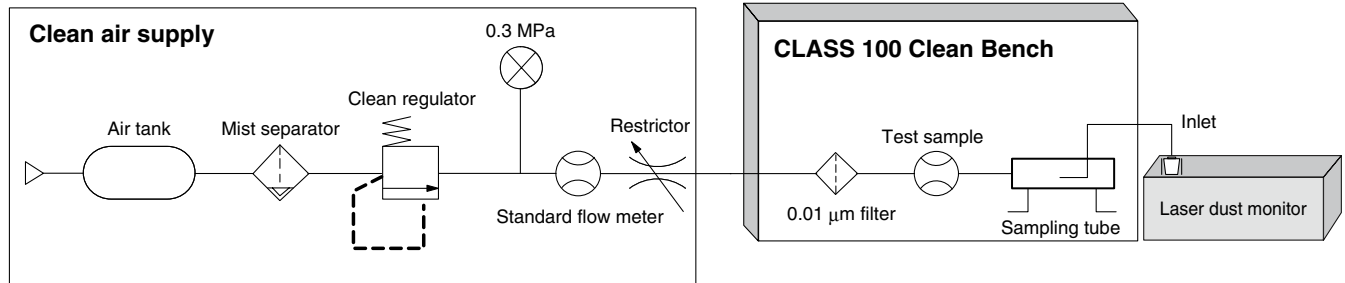

### [Test Method]

Place a sampling tube at the latter stage of the test sample and measure the number of generated particles with a laser dust monitor.

### [Measuring Conditions]

Measuring instrument	Description	Automatic particle counter using the light scattering method
		Minimum measurable particle diameter
	Suction flow rate	28 L/min
Setting conditions	Sampling time	1 min
	Interval time	4 min
	Sampling air flow	28 L

\* The flow rate used during measuring is the max. rated flow of the test sample.

## Particle Generation Characteristics (Reference Data)

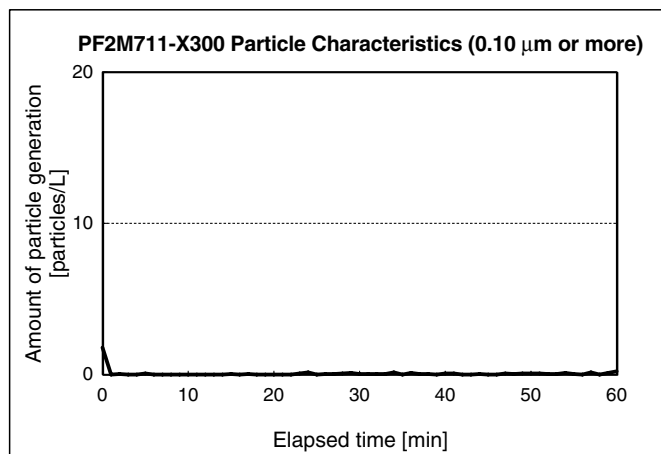
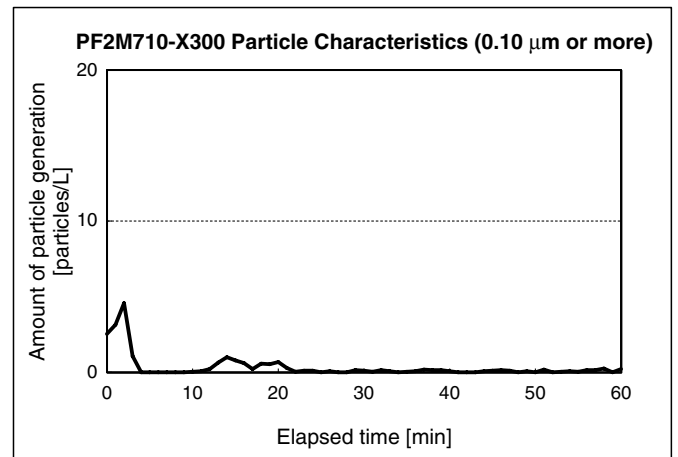
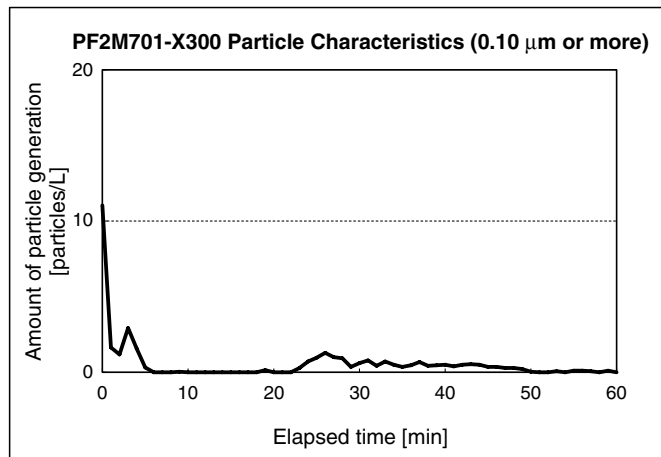

# Low Particle Generation 2-Color Display

## Digital Flow Switch

# PF2M7-X300

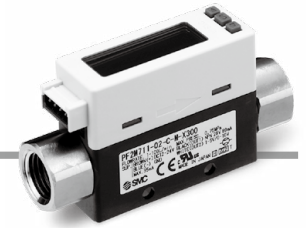

### How to Order

PF2M7 **10** - **01** - **A** **□** - **M** **□** **□** - X300

Integrated display ● ① ② ③ ④ ⑤ ⑥ ⑦

#### ① Rated flow range

01	0.01 to 1 L/min	25	0.3 to 25 L/min
02	0.02 to 2 L/min	50	0.5 to 50 L/min
05	0.05 to 5 L/min	11	1 to 100 L/min
10	0.1 to 10 L/min	21	2 to 200 L/min

#### ② Port size

Symbol	Port size	Rated flow range							
		01	02	05	10	25	50	11	21
01	Rc1/8	●	●	●	●	●	●	—	—
02	Rc1/4	—	—	—	—	—	—	—	●

#### ③ Output specification

Symbol	OUT1	OUT2
A	NPN	NPN
B	PNP	PNP
C	NPN	Analog 1 to 5 V ⇔ Analog 0 to 10 V*1
D	NPN	Analog 4 to 20 mA
E	PNP	Analog 1 to 5 V ⇔ Analog 0 to 10 V*1
F	PNP	Analog 4 to 20 mA
L	IO-Link/NPN/PNP	—
L2	IO-Link/NPN/PNP	NPN/PNP/External input
L3	IO-Link/NPN/PNP	Analog 1 to 5 V ⇔ Analog 0 to 10 V*1
L4	IO-Link/NPN/PNP	Analog 4 to 20 mA

\*1 1 to 5 V or 0 to 10 V can be selected by pressing the button.  
The default setting is 1 to 5 V.

#### ④ Option 1

Nil	W
Lead wire with connector (2 m)	Lead wire with connector (2 m) + Connector cover (Silicone rubber)
<b>10-ZS-33-D</b>	<b>10-ZS-33-F</b> <b>10-ZS-33-D</b> +
* Interchangeable with the existing PFM7 series	* Interchangeable with the existing PFM7 series
N	Q
Without lead wire with connector	M12 conversion lead wire (0.1 m)

#### ⑤ Unit specification

M	SI unit only*2
Nil	Unit selection function*3

\*2 Fixed unit: Instantaneous flow: L/min  
Accumulated flow: L

\*3 This product is for overseas use only. (The SI unit type is provided for use in Japan in accordance with the New Measurement Act.)  
The unit can be changed.  
Instantaneous flow: L/min ⇔ cfm  
Accumulated flow: L ⇔ ft<sup>3</sup>

#### ⑦ Calibration certificate\*4

Nil	None
A	Yes

\*4 Made to order  
The certificate is in both English and Japanese.

#### ⑥ Option 2

Nil	R	T
Without bracket	Bracket (For the type without a flow adjustment valve) <b>10-ZS-33-M</b>	Panel mount adapter (For the type without a flow adjustment valve) <b>10-ZS-33-2J</b>
	With 2 tapping screws (3 x 6)	Panel mount adapter Panel mount adapter B Panel Mounting bracket
	* Interchangeable with the existing PFM series	

\* Options are shipped together with the product but do not come assembled.

### DIN Rail Mounting Bracket (Ordered Separately)

**10-ZS-33-R** **3**

\* Interchangeable with the existing PFM series

Stations	
1	1 station
2	2 stations
3	3 stations
4	4 stations
5	5 stations

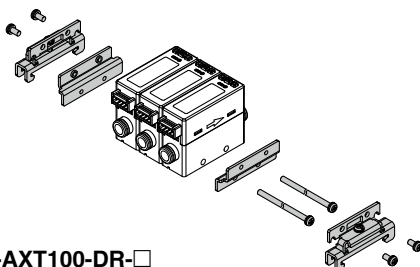

DIN rail part number: 10-AXT100-DR-□

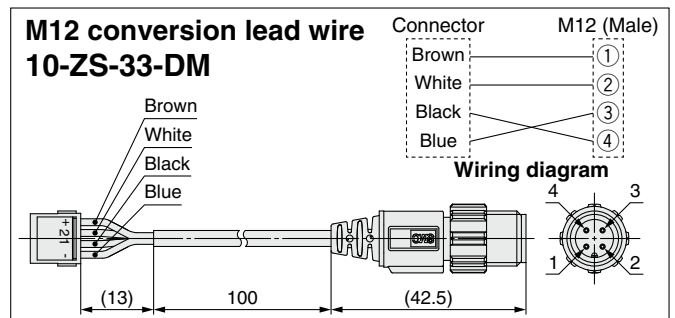

# PF2M7-X300

Refer to the **Web Catalog** for flow switch precautions. For details on the specific product precautions, refer to the "Operation Manual" on the SMC website.

## Specifications/PF2M7-X300

Model		PF2M701-X300	PF2M702-X300	PF2M705-X300	PF2M710-X300	PF2M725-X300	PF2M750-X300	PF2M711-X300	PF2M721-X300		
Fluid	Applicable fluid*1	Dry air, N <sub>2</sub> , Ar, CO <sub>2</sub> (JIS B 8392-1 1.1.2 to 1.6.2, ISO 8573-1 1.1.2 to 1.6.2)									
	Fluid temperature range	0 to 50°C									
Flow	Detection method	Thermal type (Main flow type)			Thermal type (Bypass flow type)						
	Rated flow range [L/min]	Dry air, N <sub>2</sub> , Ar	0.01 to 1	0.02 to 2	0.05 to 5	0.1 to 10	0.3 to 25	0.5 to 50	1 to 100	2 to 200	
		CO <sub>2</sub>	0.01 to 0.5	0.02 to 1	0.05 to 2.5	0.1 to 5	0.3 to 12.5	0.5 to 25	1 to 50	2 to 100	
	Set point range	Instantaneous flow [L/min]	-0.05 to 1.05	-0.1 to 2.1	-0.25 to 5.25	-0.5 to 10.5	-1.3 to 26.3	-2.5 to 52.5	-5 to 105	-10 to 210	
		Accumulated flow [L]	0.00 to 9999999.99								
	Smallest settable increment	Instantaneous flow [L/min]	0.001			0.01			0.1		1
		Accumulated flow [L]	0.01		0.1			1		1	
Accumulated volume per pulse [L/pulse]	0.01		0.1			1		1			
Accumulated value hold function*2	Intervals of 2 or 5 minutes can be selected.										
Pressure	Operating pressure range	-0.1 to 0.75 MPa									
	Rated pressure range*3	-0.07 to 0.75 MPa									
	Proof pressure	1.0 MPa									
	Pressure loss	Refer to the "Pressure Loss" graph.									
	Pressure characteristics	±5% F.S. ±1 digit (0.35 MPa standard)									
Electrical	Power supply voltage*4	For the switch output device	12 to 24 VDC ±10%								
		For the IO-Link device	18 to 30 VDC ±10%								
	Current consumption	35 mA or less									
Protection	Polarity protection										
Accuracy*5	Display accuracy	±3% F.S. ±1 digit									
	Analog output accuracy	±3% F.S.									
	Repeatability	±1% F.S. ±1 digit (±2% F.S. ±1 digit when the digital filter is set to 0.05 s)									
	Temperature characteristics	±3% F.S. ±1 digit (15 to 35°C: 25°C standard) ±5% F.S. ±1 digit (0 to 50°C: 25°C standard)									
Switch output	Output type	NPN/PNP open collector									
	Output mode	Select from Hysteresis, Window comparator, Accumulated output, Accumulated pulse output, Error output, or Switch output OFF modes.									
	Switch operation	Select from Normal or Reversed output.									
	Max. load current	80 mA									
	Max. applied voltage	Standard	28 VDC (NPN only)								
		IO-Link compatible	30 VDC (NPN only)								
	Internal voltage drop	Standard	NPN: 1 V or less (Load current: 80 mA)			PNP: 1.5 V or less (Load current: 80 mA)					
		IO-Link compatible	1.5 V or less (Load current: 80 mA)								
	Response time*6	50 ms or less									
	Delay time*7	Select from 0 to 0.10 s (increment of 0.01 s), 0.1 to 1.0 s (increment of 0.1 s), 1 to 10 s (increment of 1 s), 20 s, 30 s, 40 s, 50 s, or 60 s.									
Hysteresis*8	Variable from 0										
Protection	Short circuit protection										
Analog output*9	Output type	Voltage output: 1 to 5 V, 0 to 10 V (only when the power supply voltage is 24 VDC)*10, Current output: 4 to 20 mA									
	Impedance	Voltage output	Output impedance: Approx. 1 kΩ								
		Current output	Maximum load impedance: 600 Ω at power supply voltage of 24 V, 300 Ω at power supply voltage of 12 V								
	Response time*6	50 ms ±40%									
Display	Reference condition*11	Select from Standard condition (STD) or Normal condition (NOR).									
	Display mode	Select from Instantaneous flow or Accumulated flow.									
	Unit*12	Instantaneous flow	L/min, cfm								
		Accumulated flow	L, ft <sup>3</sup>								
	Display range	Instantaneous flow [L/min]	-0.05 to 1.05	-0.1 to 2.1	-0.25 to 5.25	-0.5 to 10.5	-1.3 to 26.3	-2.5 to 52.5	-5 to 105	-10 to 210	
		Zero cut-off range	0 to ±10% F.S. (Select per 1% F.S. for the maximum rated flow rate.)								
	Accumulated flow [L]*13	0.00 to 9999999.99	0.0 to 99999999.9			0 to 999999999					
Display	LCD, Color: Red/Green, 4 digits, 7 segments										
Indicator LED	LED ON when switch output is ON (OUT1/2: Orange)										
Digital filter*14	Select from 0.05 s, 0.1 s, 0.5 s, 1 s, 2 s, or 5 s.										
Environmental resistance	Enclosure	IP40									
	Withstand voltage	1000 VAC for 1 minute between terminals and housing									
	Insulation resistance	50 MΩ or more (500 VDC measured via megohmmeter) between terminals and housing									
	Operating temperature range	Operating: 0 to 50°C, Stored: -10 to 60°C (No condensation or freezing)									
	Operating humidity range	Operating/Stored: 35 to 85% RH (No condensation or freezing)									
Standards	CE marking (EMC Directive, RoHS Directive), UL (CSA)										
Piping*15	Piping specification	Screw-in (Rc)						01 (Rc1/8)		02 (Rc1/4)	
	Piping entry direction	Straight									
Main materials of parts in contact with fluid	PPS, FKM, Stainless steel 304, Si, Au, GE4F										
Weight	Body	Screw-in						60 g		72 g	
	Lead wire	+35 g									
	Bracket	+20 g									
	Panel mount adapter	+15 g									
	DIN rail mounting bracket	+65 g									
Cleanliness class (ISO class)	Class 4										

- \*1 Refer to the "Recommended pneumatic circuit examples" on page 4.
- \*2 When using the accumulated value hold function, use the operating conditions to calculate the product life, and do not exceed it. The maximum access limit of the memory device is 3.7 million times. If the product is operated 24 hours per day, the product life will be as follows:
  - 5 min interval: life is calculated as 5 min x 3.7 million = 18.5 million min = 35 years
  - 2 min interval: life is calculated as 2 min x 3.7 million = 7.4 million min = 14 years
- \*3 Negative pressure indicates the pressure value on the IN side (inlet side).
- \*4 When multiple products are installed closely, the upper limit of the power supply voltage is 24 VDC.
- \*5 The accuracy value is based on dry air as a fluid. For other fluids, it is a reference value.
- \*6 Value when the digital filter is set at 0.05 s
- \*7 The time from when the instantaneous flow reaches the set value to when the switch output operates can be set.
- \*8 If the flow fluctuates around the set value, the hysteresis must be set to a value more than the fluctuating width. Otherwise, chattering will occur.
- \*9 When using a product with an analog output
- \*10 When selecting 0 to 10 V, refer to the analog output graph for the allowable load current.
- \*11 Standard condition (STD): 20 [°C], 101.3 [kPa] (Absolute pressure), 65 [% RH] (The flow rate given in the specifications is the value under standard conditions.)  
Normal condition (NOR): 0 [°C], 101.3 [kPa] (Absolute pressure), 0 [% RH]
- \*12 Setting is only possible for models with the unit selection function.
- \*13 Power value is displayed for accumulated flow. The first 4 digits of the measurement value are always displayed.
- \*14 The time for the digital filter can be set to the sensor input. The response time indicates when the set value is 90% in relation to the step input.
- \*15 Some piping conditions may have negative effects on the flow accuracy.
- \* Products with tiny scratches, marks, or display color or brightness variations which do not affect the performance of the product are verified as conforming products.

**Communication Specifications (IO-Link mode)**

<b>IO-Link type</b>	Device	
<b>IO-Link version</b>	V1.1	
<b>Communication speed</b>	COM2 (38.4 kbps)	
<b>Minimum cycle time</b>	3.4 ms	
<b>Process data length</b>	Input data: 4 bytes, Output data: 0 byte	
<b>On request data communication</b>	Yes	
<b>Data storage function</b>	Yes	
<b>Event function</b>	Yes	
<b>Vendor ID</b>	131 (0 x 0083)	
<b>Device ID</b>	PF2M701-□-L□-□□□-X300 : 0 x 00016D (365) PF2M701-□-L2□-□□□-X300: 0 x 00016E (366) PF2M701-□-L3□-□□□-X300: 0 x 00016F (367) PF2M701-□-L4□-□□□-X300: 0 x 000170 (368)  PF2M702-□-L□-□□□-X300 : 0 x 000171 (369) PF2M702-□-L2□-□□□-X300: 0 x 000172 (370) PF2M702-□-L3□-□□□-X300: 0 x 000173 (371) PF2M702-□-L4□-□□□-X300: 0 x 000174 (372)  PF2M705-□-L□-□□□-X300 : 0 x 000175 (373) PF2M705-□-L2□-□□□-X300: 0 x 000176 (374) PF2M705-□-L3□-□□□-X300: 0 x 000177 (375) PF2M705-□-L4□-□□□-X300: 0 x 000178 (376)  PF2M710-□-L□-□□□-X300 : 0 x 000179 (377) PF2M710-□-L2□-□□□-X300: 0 x 00017A (378) PF2M710-□-L3□-□□□-X300: 0 x 00017B (379) PF2M710-□-L4□-□□□-X300: 0 x 00017C (380)	PF2M725-□-L□-□□□-X300 : 0 x 00017D (381) PF2M725-□-L2□-□□□-X300: 0 x 00017E (382) PF2M725-□-L3□-□□□-X300: 0 x 00017F (383) PF2M725-□-L4□-□□□-X300: 0 x 000180 (384)  PF2M750-□-L□-□□□-X300 : 0 x 000181 (385) PF2M750-□-L2□-□□□-X300: 0 x 000182 (386) PF2M750-□-L3□-□□□-X300: 0 x 000183 (387) PF2M750-□-L4□-□□□-X300: 0 x 000184 (388)  PF2M711-□-L□-□□□-X300 : 0 x 000185 (389) PF2M711-□-L2□-□□□-X300: 0 x 000186 (390) PF2M711-□-L3□-□□□-X300: 0 x 000187 (391) PF2M711-□-L4□-□□□-X300: 0 x 000188 (392)  PF2M721-□-L□-□□□-X300 : 0 x 00023B (571) PF2M721-□-L2□-□□□-X300: 0 x 00023C (572) PF2M721-□-L3□-□□□-X300: 0 x 00023D (573) PF2M721-□-L4□-□□□-X300: 0 x 00023E (574)

**Process Data**

Bit offset	Item	Note
0	OUT1 output	0: OFF 1: ON
1	OUT2 output	0: OFF 1: ON
8	Diagnosis (flow rate)	0: Within range 1: Out of range (HHH/LLL)
14	Fixed output	0: Normal output 1: Fixed output
15	Diagnosis (error)	0: Error not generated 1: Error generated
16 to 31	Measured flow rate value	Signed 16 bit

Diagnosis items
<ul style="list-style-type: none"> <li>· Over current error</li> <li>· Outside of rated flow range</li> <li>· Accumulated flow error</li> <li>· Internal product malfunction</li> </ul>

Bit offset	31	30	29	28	27	26	25	24	23	22	21	20	19	18	17	16
Item	Measured flow rate value (PD)															
Bit offset	15	14	13	12	11	10	9	8	7	6	5	4	3	2	1	0
Item	Error	Fixed	Reservation				Flow rate	Reservation				OUT2	OUT1			
	Diagnosis	Output					Diagnosis					Switch output				

# PF2M7-X300

## Recommended Pneumatic Circuit Examples

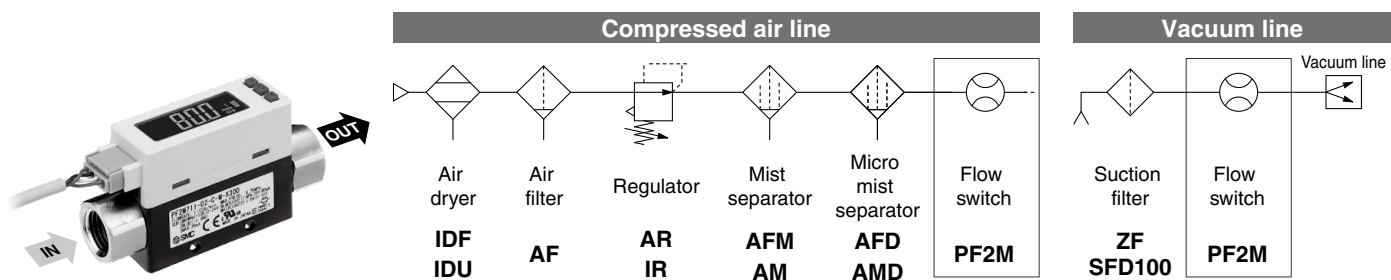

\* Recommended air quality class: JIS B 8392-1 1.1.2 to 1.6.2 (ISO 8753-1 1.1.2 to 1.6.2)



## Set Point Range and Rated Flow Range

### Set the flow rate within the rated flow range.

The set point range is the range of flow rate that can be set in the switch.

The rated flow range is the range that satisfies the switch specifications (accuracy, linearity, etc.).

It is possible to set a value outside of the rated flow range if it is within the set point range, however, the satisfaction of specifications can not be guaranteed. The flow range if using CO<sub>2</sub> is given in brackets.

### PF2M7-X300

Model	Flow range [L/min]										
	-10	-5	0	1	2	5	10	25	50	100	200
PF2M701			0.01 L/min	1.0 L/min (0.5 L/min)							
			-0.05 L/min	1.05 L/min (0.525 L/min)							
			-0.05 L/min	1.05 L/min (0.525 L/min)							
PF2M702			0.02 L/min	2.0 L/min (1 L/min)							
			-0.1 L/min	2.1 L/min (1.05 L/min)							
			-0.1 L/min	2.1 L/min (1.05 L/min)							
PF2M705			0.05 L/min	5.0 L/min (2.5 L/min)							
			-0.25 L/min	5.25 L/min (2.63 L/min)							
			-0.25 L/min	5.25 L/min (2.63 L/min)							
PF2M710			0.1 L/min	10.0 L/min (5 L/min)							
			-0.5 L/min	10.5 L/min (5.25 L/min)							
			-0.5 L/min	10.5 L/min (5.25 L/min)							
PF2M725			0.3 L/min	25.0 L/min (12.5 L/min)							
			-1.3 L/min	26.3 L/min (13.1 L/min)							
			-1.3 L/min	26.3 L/min (13.1 L/min)							
PF2M750			0.5 L/min	50.0 L/min (25 L/min)							
			-2.5 L/min	52.5 L/min (26.3 L/min)							
			-2.5 L/min	52.5 L/min (26.3 L/min)							
PF2M711			1.0 L/min	100.0 L/min (50 L/min)							
			-5.0 L/min	105.0 L/min (52.5 L/min)							
			-5.0 L/min	105.0 L/min (52.5 L/min)							
PF2M721			2 L/min	200 L/min (100 L/min)							
			-10 L/min	210 L/min (105 L/min)							
			-10 L/min	210 L/min (105 L/min)							

## Flow/Analog Output

	A	B		C
		PF2M701/02/05 /10/50/11/21-X300	PF2M725-X300	
Voltage output (1 to 5 V)	1 V	1.04 V	1.05 V	5 V
Current output (4 to 20 mA)	4 mA	4.16 mA	4.19 mA	20 mA

	E	F		G
		PF2M701/02/05 /10/50/11/21-X300	PF2M725-X300	
Voltage output (0 to 10 V)*1	0 V	0.10 V	0.12 V	10 V

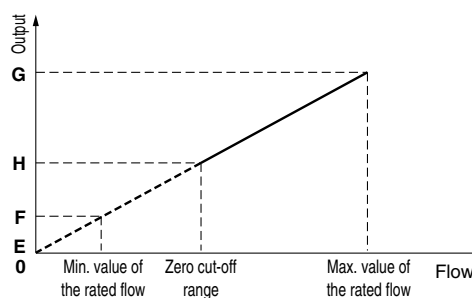
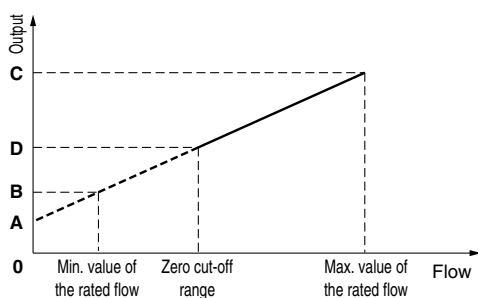

\*1 The analog output current from the connected equipment should be 20 μA or less when selecting 0 to 10 V.

When 20 μA or more current flows, it is possible that the accuracy is not satisfied at less than or equal to 0.5 V.

\* D or H fluctuates depending on the setting of the zero cut-off function.

When the zero cut-off function is set to "0," the flow rate display value starts from 0 L/min., but in conditions other than horizontal installation and supply pressure of 0.35 MPa, the output may not be 0 L/min.

# PF2M7-X300

## Internal Circuits and Wiring Examples

### NPN + NPN output type

PF2M7□□-□-A□-□□□-X300

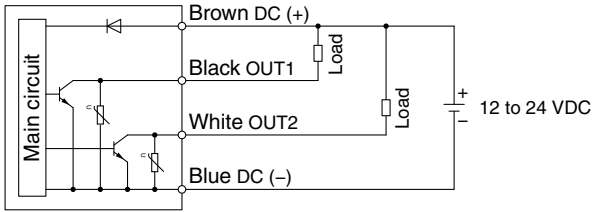

Max. applied voltage: 28 V, Max. load current: 80 mA,  
Internal voltage drop: 1 V or less

### PNP + PNP output type

PF2M7□□-□-B□-□□□-X300

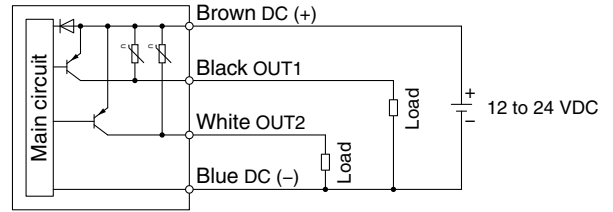

Max. load current: 80 mA, Internal voltage drop: 1.5 V or less

### NPN + Analog output type

PF2M7□□-□-C/D□-□□□-X300

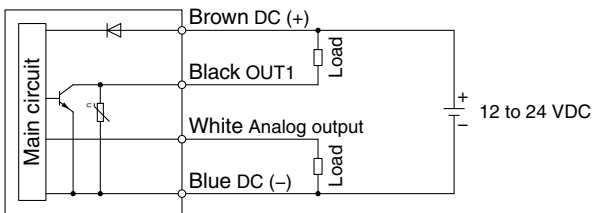

Max. applied voltage: 28 V, Max. load current: 80 mA,  
Internal voltage drop: 1 V or less

**C:** Analog output: 1 to 5 V or 0 to 10 V can be selected.

Output impedance: 1 kΩ

**D:** Analog output: 4 to 20 mA

Load impedance: 50 to 600 Ω

### PNP + Analog output type

PF2M7□□-□-E/F□-□□□-X300

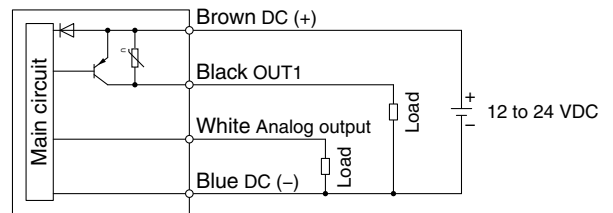

Max. load current: 80 mA, Internal voltage drop: 1.5 V or less

**E:** Analog output: 1 to 5 V or 0 to 10 V can be selected.

Output impedance: 1 kΩ

**F:** Analog output: 4 to 20 mA

Load impedance: 50 to 600 Ω

## Accumulated pulse output wiring examples

### NPN + NPN output type

PF2M7□□-□-A□-□□□-X300

### NPN + Analog output type

PF2M7□□-□-C□-□□□-X300

PF2M7□□-□-D□-□□□-X300

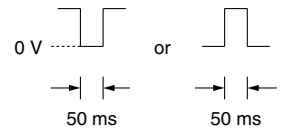
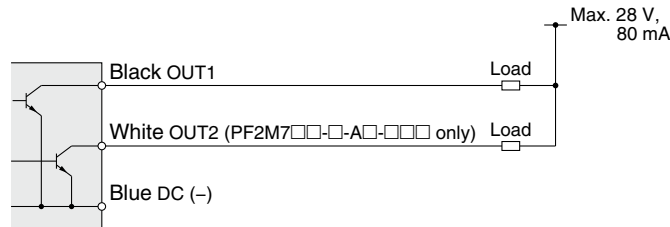

### PNP + PNP output type

PF2M7□□-□-B□-□□□-X300

### PNP + Analog output type

PF2M7□□-□-E□-□□□-X300

PF2M7□□-□-F□-□□□-X300

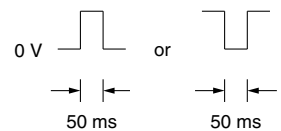
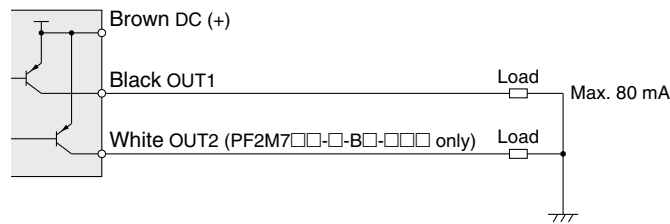

**Internal Circuits and Wiring Examples**

**PF2M7□□-□-L□-□□□-X300**

**NPN output type**

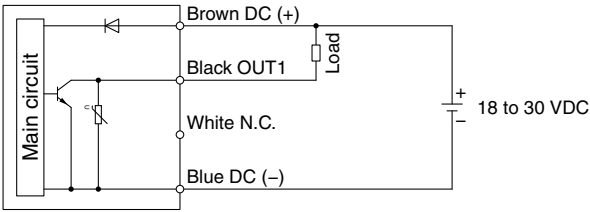

Max. applied voltage: 30 V, Max. load current: 80 mA,  
Internal voltage drop: 1.5 V or less

**PNP output type**

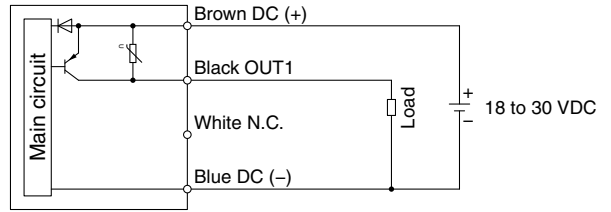

Max. load current: 80 mA, Internal voltage drop: 1.5 V or less

**PF2M7□□-□-L2□-□□□-X300**

**NPN 2 output type**

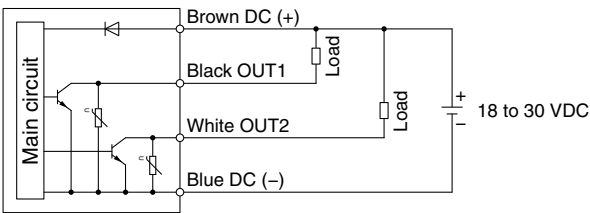

Max. applied voltage: 30 V, Max. load current: 80 mA,  
Internal voltage drop: 1.5 V or less

**PNP 2 output type**

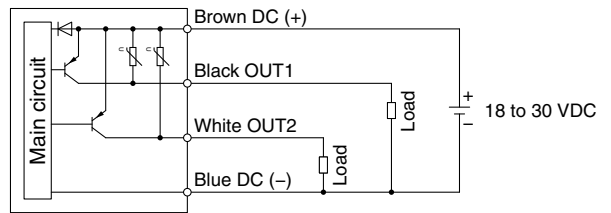

Max. load current: 80 mA, Internal voltage drop: 1.5 V or less

**NPN + External input type**

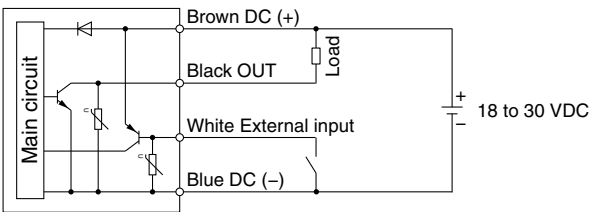

Max. applied voltage: 30 V, Max. load current: 80 mA,  
Internal voltage drop: 1.5 V or less

**PNP + External input type**

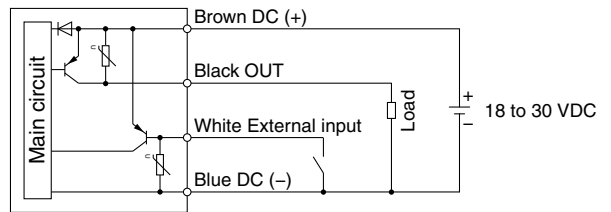

Max. load current: 80 mA, Internal voltage drop: 1.5 V or less

**PF2M7□□-□-L3/4□-□□□-X300**

**L3: NPN + Analog voltage output type**

**L4: NPN + Analog current output type**

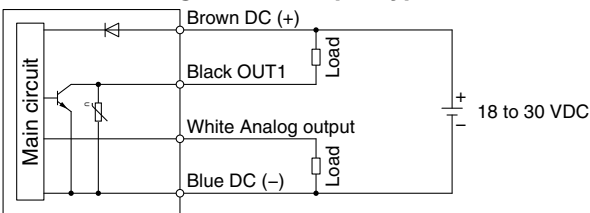

Max. applied voltage: 30 V, Max. load current: 80 mA,  
Internal voltage drop: 1.5 V or less

**L3:** Analog output: 1 to 5 V or 0 to 10 V can be selected.  
Output impedance: 1 kΩ

**L4:** Analog output: 4 to 20 mA  
Load impedance: 50 to 600 Ω

**L3: PNP + Analog voltage output type**

**L4: PNP + Analog current output type**

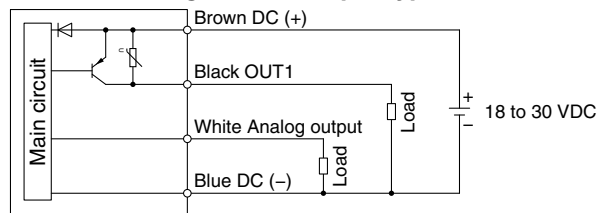

Max. load current: 80 mA, Internal voltage drop: 1.5 V or less

**L3:** Analog output: 1 to 5 V or 0 to 10 V can be selected.  
Output impedance: 1 kΩ

**L4:** Analog output: 4 to 20 mA  
Load impedance: 50 to 600 Ω

**When used as an IO-Link device**

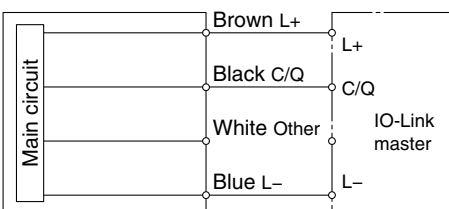



**Construction: Parts in Contact with Fluid**

**PF2M□-01/02-X300**

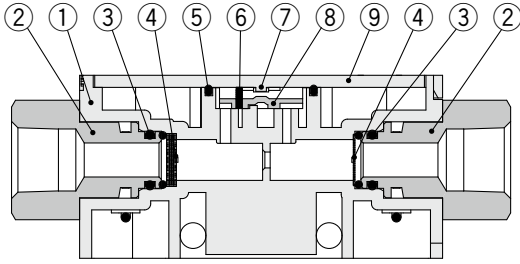

**PF2M705/710/725/750-01-X300**

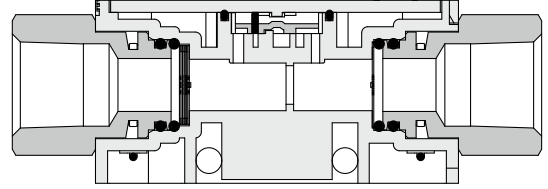

**PF2M711/721-02-X300**

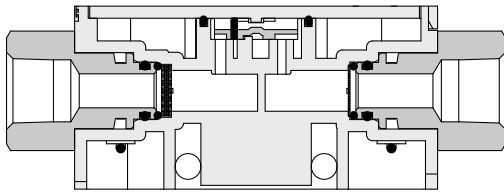

**PF2M701/702-01-X300**

\* There is no bypass construction for the 1 and 2 L ranges.

**Component Parts**

No.	Description	Material	Note
1	<b>Body</b>	PPS	
2	<b>Fitting for piping</b>	Stainless steel 304	
3	<b>O-ring</b>	FKM	
4	<b>Flow rectifier</b>	Stainless steel 304	
5	<b>Seal</b>	FKM	
6	<b>Flow rectifier</b>	Stainless steel 304	
7	<b>Sensor chip</b>	Silicon	
8	<b>Body B</b>	PPS	
9	<b>Printed circuit board</b>	GE4F	

**Dimensions**

**PF2M□-01/02-X300**

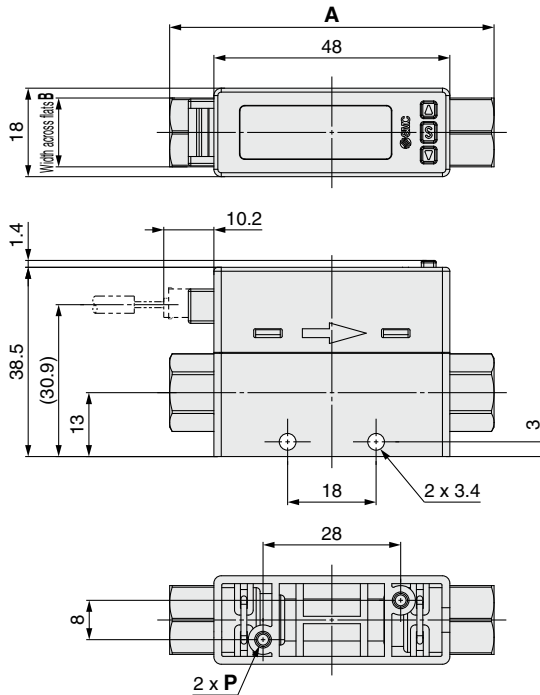
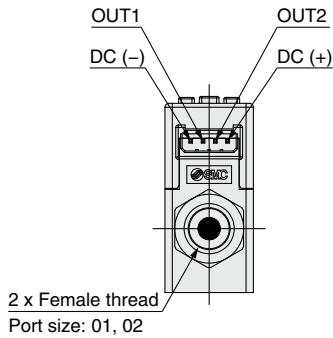

Model	A	B	P
<b>PF2M701/702/705/710/725/750-01-X300</b>	66	14	ø2.8 depth 8.4
<b>PF2M711/721-02-X300</b>	70	17	ø2.8 depth 6.2

**⚠ Precautions**

Flush the piping line before when the product for the first time and after it has been replaced. Also, if piping, etc., is to be connected, flush (air blow) using this product for the first time in order to reduce the effects of the dust generated from the connection, etc. Flushing the line is also required to eliminate contamination resulting from the installation of piping lines. Therefore, be sure to flush the line before running the system. Make sure all mounting parts are secure before use.

 **Safety Instructions** Be sure to read the "Handling Precautions for SMC Products" (M-E03-3) and "Operation Manual" before use.

## SMC Corporation

Akihabara UDX 15F,  
4-14-1, Sotokanda, Chiyoda-ku, Tokyo 101-0021, JAPAN  
Phone: 03-5207-8249 Fax: 03-5298-5362  
<http://www.smcworld.com>  
© 2017 SMC Corporation All Rights Reserved

Specifications are subject to change without prior notice  
and any obligation on the part of the manufacturer.



D-G