

# Digital Flow Switch for Air

## PF2A Series



For Air

### PF2A Series



### 4-channel Flow Monitor



### PF2□200 Series

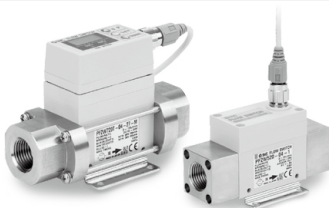

### For Water PF2W Series

New digital flow switch product, **PF3W series**, with the **compact design and expanded flow rate range** has been launched. Please examine to use **PF3W series (page 329)**. For details about PF2W series, refer to the catalog at SMC website.

PFM
PFMB
PFMC
PFMV
<b>PF2A</b>
PF3W
LFE
PF2D
IF

- 1 Flow rate setting and monitoring are possible with the digital display.
- 2 Two types are available: Integrated and Remote type.
- 3 Three types of output: Switch, accumulated pulse, and analog outputs.

- 4 Switching from instantaneous flow rate to accumulated flow is possible.  
(Accumulated flow rate is reset when the power supply turns OFF.)
- 5 Two independent flow rate settings are possible.
- 6 Water resistant construction conforming to IP65



**For Air**  
**PF2A Series**

**A single controller can monitor the flow rate of 4 different sensors.**

4 independent flow rate ranges can be monitored by a single controller.

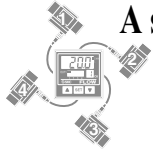

4-channel Flow Monitor  
**PF2□200 Series**

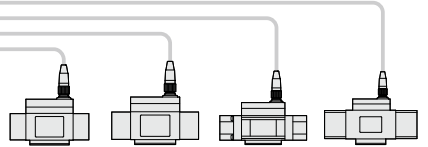

**76% reduced installation space**  
(Compared with a PF2A3□□ and PF2W3□□, when panel mounted.)

**Reduced panel fitting labor**

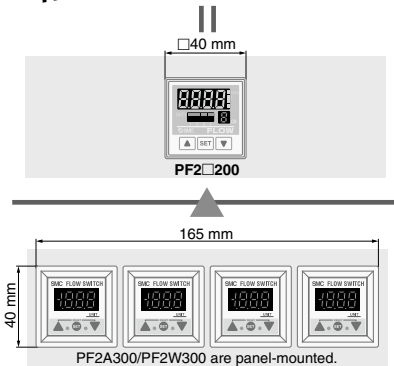

**● Connection**

**e-CON CONNECTOR**  
No tools required!

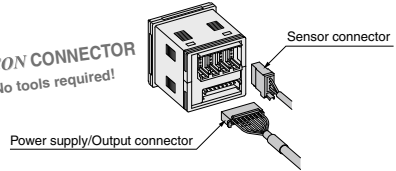

**● Function**

**● Copy function**

Possible to copy information from one channel to one or more other channels.

Copying CH1 setting to CH2, 3 and 4.



**● Channel scan function**

Allows constant monitoring of the displayed pressure value for each channel.

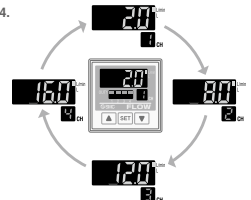

- Keylock function
- Unit switching function
- Peak value and lowest value holding

**Application Examples**

**Flow control of N<sub>2</sub> gas to prevent detection camera shimmering and lead frame oxidation**

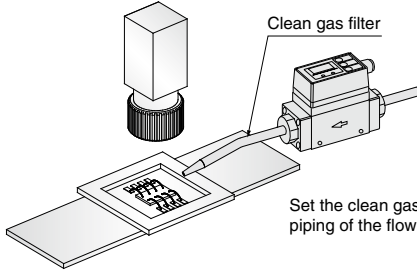

**Makes it possible to monitor the air flow from the main line to each branch line.**

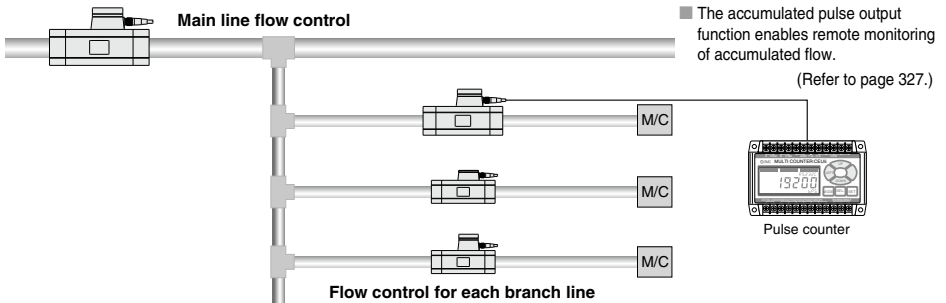

PFM
PFMB
PFMC
PFMV
<b>PF2A</b>
PF3W
LFE
PF2D
IF

# For Air

## Digital Flow Switch

# PF2A Series



### How to Order

Integrated Display Type

PF2A7 10 - [ ] 01 - 27 [ ] - M

#### Flow rate range

10	1 to 10 L/min
50	5 to 50 L/min
11	10 to 100 L/min
21	20 to 200 L/min
51	50 to 500 L/min

#### Thread type

Nil	Rc
N	NPT
F	G*

\* Conforming to ISO228-1.

#### Port size

Symbol	Port size	Flow rate (L/min)				Applicable model
		10	50	100	200	
01	1/8	●	●			PF2A710/750
02	1/4	●	●			PF2A711/721
03	3/8			●	●	PF2A751
04	1/2				●	PF2A751

#### Lead wire (Refer to page 326.)

Symbol	Lead wire with M12 connector (3 m)
N	Without lead wire

#### Output specifications

Symbol	Output specification
27	NPN open collector 2 outputs
67	PNP open collector 2 outputs

#### Unit specifications

Nil	[With unit switching function (Note1)]
M	Fixed SI unit (Note2)

Note1) Under Japan's new Measurement Act, this is only for overseas sales (SI units are to be used inside Japan).

Note2) Fixed units:  
Instantaneous flow rate: L/min  
Accumulated flow: L

## Specifications

Refer to pages 202 and 203 for Flow Switch Precautions. For details about the Specific Product Precautions, refer to the Operation Manual on the SMC website, <http://www.smworld.com>

Model	PF2A710	PF2A750	PF2A711	PF2A721	PF2A751
Measured fluid			Air, Nitrogen		
Flow rate measurement range	0.5 to 10.5 L/min	2.5 to 52.5 L/min	5 to 105 L/min	10 to 210 L/min	25 to 525 L/min
Set flow rate range	0.5 to 10.5 L/min	2.5 to 52.5 L/min	5 to 105 L/min	10 to 210 L/min	25 to 525 L/min
Rated flow range	1 to 10 L/min	5 to 50 L/min	10 to 100 L/min	20 to 200 L/min	50 to 500 L/min
Minimum set unit	0.1 L/min	0.5 L/min	1 L/min	2 L/min	5 L/min
Accumulated pulse flow rate exchange value (Pulse width: 50 ms)	0.1 L/pulse	0.5 L/pulse	1 L/pulse	2 L/pulse	5 L/pulse
Note 1, 2) Display units	L/min, CFM x 10 <sup>-2</sup>		L, ft <sup>3</sup> x 10 <sup>-1</sup>		
Instantaneous flow rate	L/min, CFM x 10 <sup>-2</sup>		L/min, CFM x 10 <sup>-1</sup>		
Accumulated flow	L/min, CFM x 10 <sup>-2</sup>		L/min, CFM x 10 <sup>-1</sup>		
Operating fluid temperature	0 to 50°C		0 to 50°C		
Accuracy (Note 3)	±1% F.S.		±5% F.S.		
Repeatability	±1% F.S.		±2% F.S.		
Temperature characteristics	±3% F.S. (15 to 35°C, 25°C reference), ±5% F.S. (0 to 50°C, 25°C reference)				
Current consumption	150 mA or less		160 mA or less		170 mA or less
Weight (Note 4)	250 g		290 g		
Port size (Rc, NPT, G)	1/8, 1/4		3/8		1/2
Detection type	Heater type				
Indicator light	3-digit, 7-segment LED				
Operating pressure range	-50 kPa to 0.5 MPa		-50 kPa to 0.75 MPa		
Proof pressure	1.0 MPa				
Accumulated flow range (Note 5)	0 to 999999 L				
Output specifications (Note 6)	Switch output	NPN open collector			
		Maximum load current: 80 mA; Internal voltage drop: 1 V or less (with load current of 80 mA) Maximum applied voltage: 30 V; 2 outputs			
	Accumulated pulse output	PNP open collector			
		Maximum load current: 80 mA Internal voltage drop: 1.5 V or less (with load current of 80 mA); 2 outputs			
		NPN or PNP open collector (same as switch output)			
Status LED's	Lights up when output is turned ON OUT1: Green; OUT2: Red				
Response time	1 sec. or less				
Hysteresis	Hysteresis mode: Variable (can be set from 0), Window comparator mode (Note 7): 3-digit fixed				
Power supply voltage	12 to 24 VDC ±10%				
Enclosure	IP65				
Operating temperature range	Operating: 0 to 50°C, Stored: -25 to 85°C (with no freezing and condensation)				
Withstand voltage	1000 VAC for 1 minute between terminals and housing				
Insulation resistance	50 MΩ or more (500 VDC measured via megohmmeter between terminals and housing)				
Standards and regulations	CE, RoHS				

Note 1) For digital flow switch with unit switching function. (Fixed SI unit [(L/min, or L, m<sup>3</sup> or m<sup>3</sup> x 10<sup>3</sup>)] will be set for switch type without the unit switching function.)

Note 2) Flow rate display can be switched between the basic condition of 0°C, 101.3 kPa and the standard condition (ANR) of 20°C, 101.3 kPa, and 65% RH.

Note 3) The piping on the IN side must have a straight section of piping whose length is 8 times the piping diameter or more. If a straight section of piping is not installed, the accuracy may vary by ±5% F.S. or more.

Note 4) Without lead wire.

Note 5) Accumulated flow rate is reset when the power supply turns OFF.

Note 6) Switch output and accumulated pulse output can be selected during initial setting.

Note 7) Window comparator mode — Since hysteresis will reach 3 digits, keep P\_1 and P\_2 or n\_1 and n\_2 apart by 7 digits or more. (In case of output OUT2, n\_1, 2 to be n\_3, 4 and P\_1, 2 to be P\_3, 4.)

Note 8) The flow switch conforms to the CE marking.

Note 9) For details about wiring and thread type, refer to the Operation Manual that can be downloaded from SMC website (<http://www.smworld.com>).

Note 10) Any products with tiny scratches, smears, or display color variation or brightness which does not affect the performance are verified as conforming products.

## Set Flow Rate Range and Rated Flow Range

Set the flow rate within the rated flow range.

The set flow range is the range of flow rate that is possible in setting.

The rated flow range is the range that satisfies the sensor's specifications (accuracy, linearity etc.).

It is possible to set a value outside off the rated flow range, however, the specification is not guaranteed.

<For Air/PF2A>

Sensor	Flow rate range							
	1L/min	5L/min	10L/min	20L/min	50L/min	100L/min	200L/min	500L/min
PF2A710 PF2A510	1L/min — 10L/min		0.5L/min — 10.5L/min					
PF2A750 PF2A550	5L/min — 50L/min		2.5L/min — 52.5L/min					
PF2A711 PF2A511	10L/min — 100L/min		5L/min — 105L/min					
PF2A721 PF2A521	20L/min — 200L/min		10L/min — 210L/min					
PF2A751 PF2A551	50L/min — 500L/min		25L/min — 525L/min					

■ Rated flow range of sensor  
▒ Set flow rate range of sensor

## Internal Circuits and Wiring Examples

PF2A7□□

-27  
NPN (2 outputs)

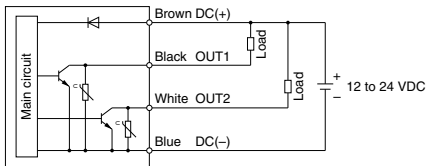

-67  
PNP (2 outputs)

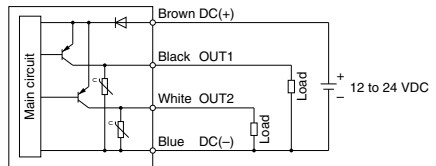

PFM

PFMB

PFMC

PFMV

PF2A

PF3W

LFE

PF2D

IF

## How to Order



Remote Type  
Sensor Unit

PF2A5 10 - [ ] 01 [ ] - [ ] - C

Flow rate range

10	1 to 10 L/min
50	5 to 50 L/min
11	10 to 100 L/min
21	20 to 200 L/min
51	50 to 500 L/min

Thread type

Nil	Rc
N	NPT
F	G*

\* Conforming to ISO228-1.

Port size

Symbol	Port size	Flow rate (L/min)					Applicable model
		10	50	100	200	500	
01	1/8	●	●				PF2A510/550
02	1/4	●	●				
03	3/8			●	●		PF2A511/521
04	1/2					●	PF2A551

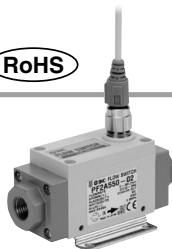

Option (Only for output specifications "1")  
(Refer to page 326.)

Nil	None
C	e-con connector (1 pc.)

The cable and connector are shipped unassembled.

Lead wire (Refer to page 326.)

Nil	Lead wire with M12 connector (3 m)
N	Without lead wire

Output specifications

Symbol	Specification	Applicable monitor unit model
Nil	Output for monitor unit	PF2A300 series
1	Output for monitor unit + analog output (1 to 5 V)	PF2A200/300 series
2	Output for monitor unit + analog output (4 to 20 mA)	PF2A300 series

## Specifications

Refer to pages 202 and 203 for Flow Switch Precautions. For details about the Specific Product Precautions, refer to the Operation Manual on the SMC website, <http://www.smcworld.com>

Model	PF2A510	PF2A550	PF2A511	PF2A521	PF2A551
Measured fluid	Air, Nitrogen				
Detection type	Heater type				
Rated flow range	1 to 10 L/min	5 to 50 L/min	10 to 100 L/min	20 to 200 L/min	50 to 500 L/min
Operating pressure range	-50 kPa to 0.5 MPa		-50 kPa to 0.75 MPa		
Proof pressure	1.0 MPa				
Operating fluid temperature	0 to 50°C				
Accuracy <sup>Note 1, 2)</sup>	±5% F.S.				
Repeatability <sup>Note 1)</sup>	±1% F.S. (Connected with PF2A3□□), ±3% F.S. (Connected with PF2A2□□)				
Temperature characteristics	±2% F.S. (15 to 35°C, 25°C reference) ±3% F.S. (0 to 50°C, 25°C reference)				
Output specifications <sup>Note 3)</sup>	Output for monitor unit	Analog voltage output (non-linear) output impedance 1 kΩ output for monitor unit PF2A3□□			
	Analog output	Voltage output 1 to 5 V (within the flow rate range) Accuracy: ±5% F.S., Min. load impedance: 100 kΩ (Output impedance: 1 kΩ)			
		Current output 4 to 20 mA (within the flow rate range) Accuracy: ±5% F.S., Max. load impedance: 300 Ω or less (at 12 VDC), 600 Ω or less (at 24 VDC)			
Power supply voltage	12 to 24 VDC ±10%				
Current consumption	100 mA or less				110 mA or less
Environment	Enclosure IP65				
Operating temperature range	Operating: 0 to 50°C, Stored: -25 to 85°C (with no freezing and condensation)				
Withstand voltage	1000 VAC for 1 minute between terminals and housing				
Insulation resistance	50 MΩ or more (500 VDC measured via megohmmeter) between terminals and housing				
Standards and regulations	CE, RoHS				
Weight <sup>Note 4)</sup>	200 g		240 g		
Port size (Rc, NPT, G)	1/8, 1/4		3/8		1/2

Note 1) The system accuracy when combined with PF2A2□□/3□□.  
 Note 2) The piping on the IN side must have a straight section of piping whose length is 8 times the piping diameter or more. If a straight section of piping is not installed, the accuracy may vary by ±5% F.S. or more.  
 Note 3) Output system can be selected during initial setting.  
 Note 4) Without lead wire. (Add 20 g for the types of analog output, whether voltage or current output selected.)  
 Note 5) Flow rate unit measured under the following conditions: 0°C and 101.3 kPa.  
 Note 6) The sensor unit conforms to the CE marking.  
 Note 7) For details about wiring and thread type, refer to the Operation Manual that can be downloaded from SMC website (<http://www.smcworld.com>).  
 Note 8) Any products with tiny scratches, smears, or display color variation or brightness which does not affect the performance are verified as conforming products.



### How to Order

Remote Type  
Monitor Unit

PF2A3 0 0 - A - M

#### Flow rate range

Symbol	Flow rate range	Type for sensor unit
0	1 to 10 L/min	PF2A510
	5 to 50 L/min	PF2A550
1	10 to 100 L/min	PF2A511
	50 to 500 L/min	PF2A551

#### Mounting

A	Panel mounting
---	----------------

#### Output specifications

Symbol	Output specification	Applicable model
0	NPN open collector 2 outputs	PF2A300, 310
1	PNP open collector 2 outputs	PF2A301, 311

#### Unit specifications

NII	With unit switching function <sup>Note1)</sup>
M	Fixed SI unit <sup>Note2)</sup>

Note1) Since the unit for Japan is fixed to SI due to new measurement law, this option is for overseas.

Note2) Fixed units:  
Instantaneous flow rate: L/min  
Accumulated flow: L

## Specifications

Refer to pages 202 and 203 for Flow Switch Precautions. For details about the Specific Product Precautions, refer to the Operation Manual on the SMC website, <http://www.smcworld.com>

Model	PF2A300/301			PF2A310/311	
Flow rate measurement range <sup>Note 1)</sup>	0.5 to 10.5 L/min	2.5 to 52.5 L/min	5 to 105 L/min	10 to 210 L/min	25 to 525 L/min
Set flow rate range <sup>Note 1)</sup>	0.5 to 10.5 L/min	2.5 to 52.5 L/min	5 to 105 L/min	10 to 210 L/min	25 to 525 L/min
Minimum set unit <sup>Note 1)</sup>	0.1 L/min	0.5 L/min	1 L/min	2 L/min	5 L/min
Accumulated pulse flow rate exchange value (Pulse width: 50 ms) <sup>Note 1)</sup>	0.1 L/pulse	0.5 L/pulse	1 L/pulse	2 L/pulse	5 L/pulse
<sup>Note 2, 3)</sup> Display units	L/min, CFM x 10 <sup>-2</sup>		L/min, CFM x 10 <sup>-1</sup>		
Accumulated flow range <sup>Note 4)</sup>	0 to 999999 L				
Accuracy <sup>Note 5)</sup>	±5% F.S.				
Repeatability <sup>Note 5)</sup>	±1% F.S.				
Temperature characteristics	±1% F.S. (15 to 35°C, 25°C reference) ±2% F.S. (0 to 50°C, 25°C reference)				
Current consumption	50 mA or less		60 mA or less		
Weight	45 g				
<sup>Note 6)</sup> Output specifications	Switch output		NPN open collector (PF2A300, PF2A310) Maximum load current: 80 mA Internal voltage drop: 1 V or less (with load current of 80 mA) Maximum applied voltage: 30 V 2 outputs		
	Switch output		PNP open collector (PF2A301, PF2A311) Maximum load current: 80 mA Internal voltage drop: 1.5 V or less (with load current of 80 mA) 2 outputs		
	Accumulated pulse output		NPN or PNP open collector (same as switch output)		
Indicator light	3-digit, 7-segment LED				
Status LED's	Lights up when output is turned ON OUT1: Green; OUT2: Red				
Power supply voltage	12 to 24 VDC ±10%				
Response time	1 sec. or less				
Hysteresis	Hysteresis mode: Variable (can be set from 0), Window comparator mode <sup>Note 7)</sup> ; Fixed (3-digits)				
Enclosure	IP40				
Operating temperature range	Operating: 0 to 50°C, Stored: -25 to 85°C (with no freezing and condensation)				
Withstand voltage	1000 VAC for 1 minute between terminals and housing				
Insulation resistance	50 MΩ or more (500 VDC measured via megohmmeter) between terminals and housing				
Standards and regulations	CE, RoHS				

Note 1) The flow rate measurement range can be modified depending on the setting.

Note 2) For digital flow switch with unit switching function. (Fixed SI unit [L/min or L] will be set for switch types without the unit switching function.)

Note 3) Flow rate display can be switched between the basic condition of 0°C, 101.3 kPa and the standard condition (ANR) of 20°C, 101.3 kPa, and 65% RH.

Note 4) Accumulated flow rate is reset when the power supply turns OFF.

Note 5) The system accuracy when combined with PF2A5□□.

Note 6) Switch output and accumulated pulse output can be selected during initial setting.

Note 7) Window comparator mode — Since hysteresis will reach 3 digits, keep P\_1 and P\_2 or n\_1 and n\_2 apart by 7 digits or more. (In case of output OUT2, n\_1, 2 to be n\_3, 4 and P\_1, 2 to be P\_3, 4.)

Note 8) The monitor unit conforms to the CE marking.

Note 9) For details about wiring, refer to the Operation Manual that can be downloaded from SMC website (<http://www.smcworld.com>).

Note 10) Any products with tiny scratches, smears, or display color variation or brightness which does not affect the performance are verified as conforming products.

PFM

PFMB

PFMC

PFMV

PF2A

PF3W

LFE

PF2D

IF



### 4-channel Flow Monitor Remote Type Monitor Unit

# PF2A20 0 - M

#### Output specifications

0	NPN 4 outputs
1	PNP 4 outputs

#### Unit specifications

Nil	With unit switch function <sup>Note 1)</sup>
M	Fixed SI unit <sup>Note 2)</sup>

Note 1) Under the new Measurement Act, devices with unit switching functions cannot be used inside Japan.

Note 2) Fixed units:  
Instantaneous flow rate: L/min  
Accumulated flow: L

#### Option 2 (Refer to page 326.)

Nil	None
4C	Sensor connector (4 pc.)

#### Option 1 (Refer to page 326.)

Nil	None
A	Panel mounting
B	Front protective cover + Panel mounting

Accessory/Power supply output cable (2 m)

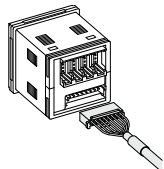

Connectable remote type sensor unit is PF2A5□□-□-1 (with analog output 1 to 5 V).

## Specifications

Refer to pages 202 and 203 for Flow Switch Precautions. For details about the Specific Product Precautions, refer to the Operation Manual on the SMC website, <http://www.smworld.com>

Model		PF2A200/201				
<b>Applicable flow rate sensor</b>		PF2A510-□-1	PF2A550-□-1	PF2A511-□-1	PF2A521-□-1	PF2A551-□-1
<b>Flow rate measurement range</b> <sup>Note 1)</sup>		0.5 to 10.5 L/min	2.5 to 52.5 L/min	5 to 105 L/min	10 to 210 L/min	25 to 525 L/min
<b>Set flow rate range</b> <sup>Note 1)</sup>		0.5 to 10.5 L/min	2.5 to 52.5 L/min	5 to 105 L/min	10 to 210 L/min	25 to 525 L/min
<b>Minimum set unit</b> <sup>Note 1)</sup>		0.1 L/min	0.5 L/min	1 L/min	2 L/min	5 L/min
<b>Accumulated pulse flow rate exchange value (Pulse width: 50 ms)</b> <sup>Note 1)</sup>		0.1 L/pulse	0.5 L/pulse	1 L/pulse	2 L/pulse	5 L/pulse
<sup>Note 1, 2)</sup> <b>Display units</b>	<b>Instantaneous flow rate</b>	L/min, CFM x 10 <sup>-2</sup>				L/min, CFM x 10 <sup>-1</sup>
	<b>Accumulated flow</b>	L, ft <sup>3</sup> x 10 <sup>-2</sup>				L, ft <sup>3</sup> x 10 <sup>-1</sup>
<b>Accumulated flow range</b> <sup>Note 1)</sup>		0 to 999999 L, 0 to 999999 ft <sup>3</sup> x 10 <sup>-2</sup>		0 to 999999 L, 0 to 999999 ft <sup>3</sup> x 10 <sup>-1</sup>		
<b>Power supply voltage</b>		24 VDC ±10% (With power supply polarity protection)				
<b>Current consumption</b>		55 mA or less (Not including the current consumption of the sensor)				
<b>Power supply voltage for sensor</b>		Same as [Power supply voltage]				
<b>Power supply current for sensor</b> <sup>Note 3)</sup>		Max. 110 mA (However, the total current for the 4 inputs is 440 mA maximum or less.)				
<b>Sensor input</b>		1 to 5 VDC (Input impedance: Approx. 800K Ω)				
<sup>Note 4)</sup> <b>Output specifications</b>	<b>No. of inputs</b>	4 inputs				
	<b>Input protection</b>	Excess voltage protection				
	<b>Switch output (Real-time switch output, Accumulated switch output)</b>	NPN open collector (PF2A200)	Maximum load current: 80 mA Internal voltage drop: 1 V or less (with load current of 80 mA) Maximum applied voltage: 30 V			
	<b>Accumulated pulse output</b>	PNP open collector (PF2A201)	Maximum load current: 80 mA Internal voltage drop: 1 V or less (with load current of 80 mA)			
	<b>No. of outputs</b>	NPN open collector or PNP open collector (same as switch output)				
	<b>Output protection</b>	4 outputs (1 output per 1 sensor input) With short circuit protection				
<b>Hysteresis</b>		Hysteresis mode: Variable (can be set from 0), Window comparator mode: Fixed (3-digits)				
<b>Response time</b> <sup>Note 5)</sup>		1s or less				
<b>Accuracy</b> <sup>Note 5)</sup>		±5% F.S.				
<b>Repeatability</b> <sup>Note 5)</sup>		±3% F.S.				
<b>Temperature characteristics</b>		±2% F.S. (0 to 50°C, 25°C reference)				
<b>Display method</b>		For measured value display: 4-digits, 7-segment LED (Orange) For channel display: 1-digit, 7-segment LED (Red)				
<b>Status LED's</b>		Lights up when output is turned ON OUT1: Red				
<b>Environment</b>	<b>Enclosure</b>	IP65 for the front face only, and IP40 for the remaining parts.				
	<b>Operating temperature range</b>	Operating: 0 to 50°C, Stored: -10 to 60°C (with no freezing and condensation)				
	<b>Operating humidity range</b>	Operating or Stored: 35 to 85%RH (with no condensation)				
<b>Standards and regulations</b>		CE, RoHS				
<b>Connection</b>		Power supply/Output connection: 8P connector, Sensor connection: 4P connector (e-con)				
<b>Material</b>		Housing: PBT, Monitor: PET, Backside rubber: CR				
<b>Weight</b>		60 g (Except for any accessories that are shipped together)				

Note 1) Fixed SI unit [L/min or L] will be set for switch types without the unit switching function, ("M" is suffixed at the end of part number.) Accumulated flow is reset when the power supply turns OFF.  
 Note 2) Flow rate display can be switched between the basic condition of 0°C, 101.3 kPa and the standard condition (ANR) of 20°C, 101.3 kPa, and 65% RH.  
 Note 3) If Voc side on sensor input connector part is short-circuited with the 0V side, the flow monitor inside will be damaged.  
 Note 4) Switch output and accumulated pulse output can be selected during initial setting.  
 Note 5) The system accuracy when combined with an applicable flow sensor.  
 Note 6) This product conforms to the CE marking.  
 Note 7) For details about wiring, refer to the Operation Manual that can be downloaded from SMC website (<http://www.smworld.com>).  
 Note 8) Any products with tiny scratches, smears, or display color variation or brightness which does not affect the performance are verified as conforming products.



### Flow Rate Characteristics (Pressure Loss)

PF2A710, 510

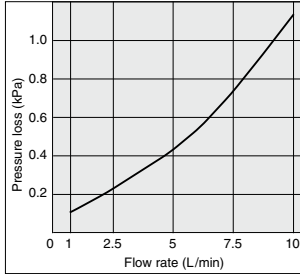

PF2A750, 550

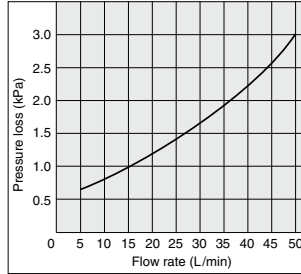

PF2A711, 511

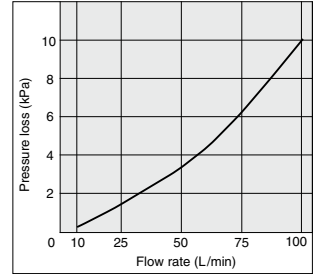

PF2A721, 521

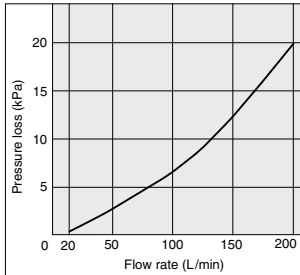

PF2A751, 551

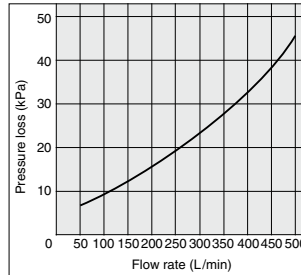

### Wetted Parts Construction/Sensor Unit

PF2A710/750  
PF2A510/550

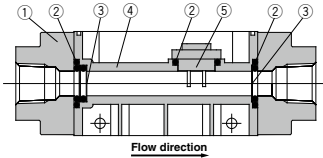

PF2A711/721/751  
PF2A511/521/551

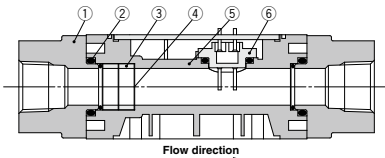

#### Parts list

No.	Description	Material
1	Attachment	ADC
2	Seal	NBR
3	Mesh	Stainless steel
4	Body	PBT
5	Sensor	PBT

#### Parts list

No.	Description	Material
1	Attachment	ADC
2	Seal	NBR
3	Spacer	PBT
4	Mesh	Stainless steel
5	Body	PBT
6	Sensor	PBT

PFM

PFMB

PFMC

PFMV

PF2A

PF3W

LFE

PF2D

IF

# PF2A Series

## Internal Circuits and Wiring Examples

### For PF2A5□□/PF2A3

Nii

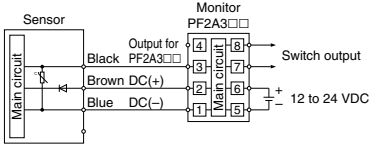

-1/2

### Analog voltage output Analog current output

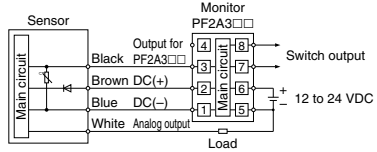

### For PF2A5□□/PF2A2

-1

### Analog voltage output

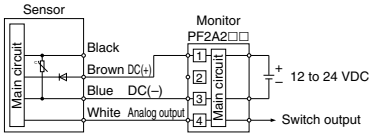

### PF2A3□

-0

### PNP (2 outputs)

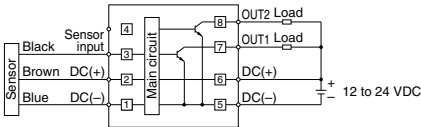

-1

### PNP (2 outputs)

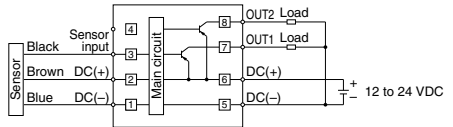

### PF2A200

### PNP (4 outputs)

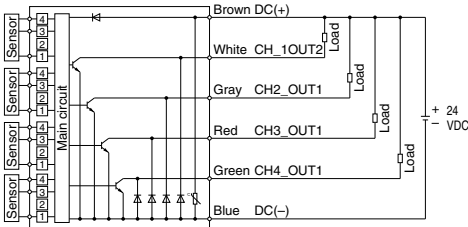

### PF2A201

### PNP (4 outputs)

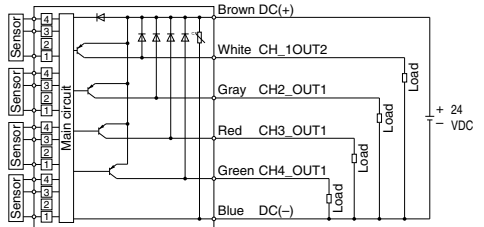

**Dimensions: Integrated Display Type For Air**

**PF2A710, 750**

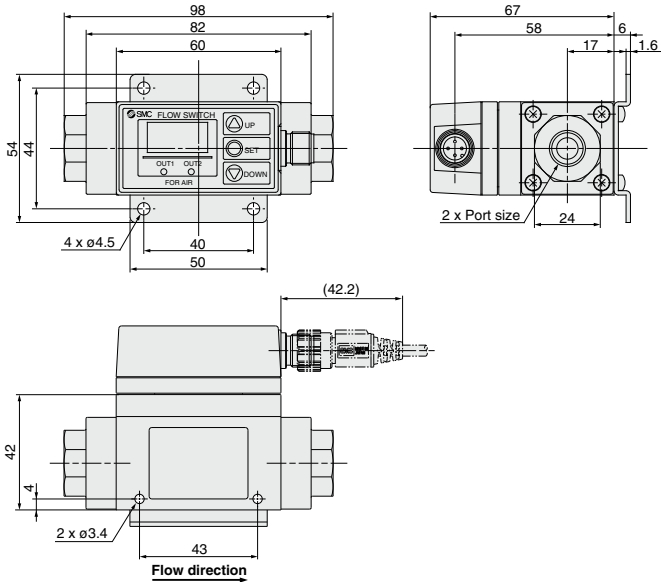

Connector pin numbers



Pin no.	Pin description
1	DC(+)
2	OUT2
3	DC(-)
4	OUT1

**PF2A711, 721, 751**

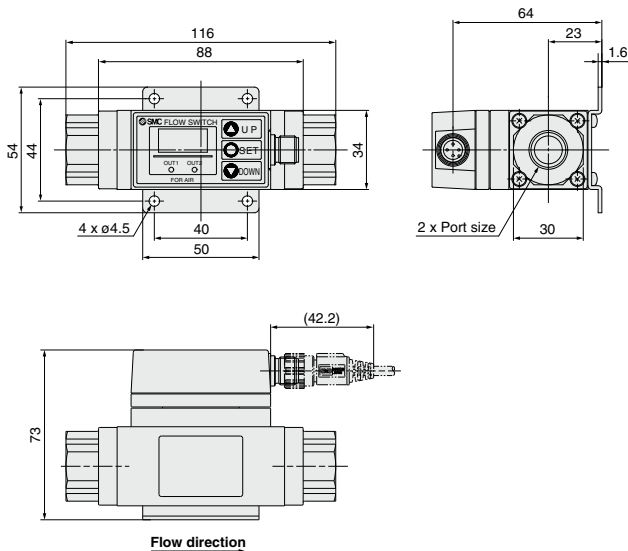

- PFM
- PFMB
- PFMC
- PFMV
- PF2A**
- PF3W
- LFE
- PF2D
- IF

Be sure to allow straight pipe length that is minimum 8 times the port size upstream and downstream of the switch piping.

# PF2A Series

## Dimensions: Remote Type Sensor Unit **For Air**

### PF2A510, 550

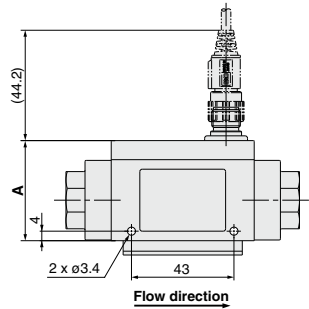
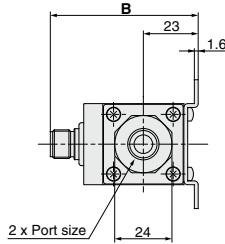
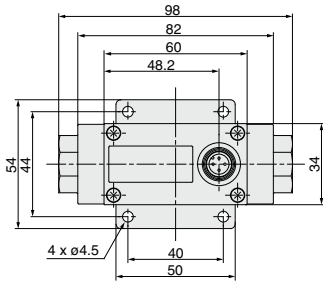

#### Connector pin numbers



Pin no.	Pin description
1	DC(+)
2	NC/Analog output
3	DC(-)
4	OUT

Output specifications	(mm)	
	A	B
Output for monitor unit only	42	62
Output for monitor unit + Analog output	52	72

### PF2A511, 521, 551

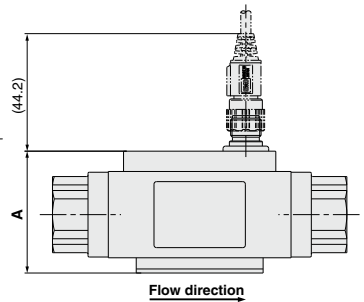
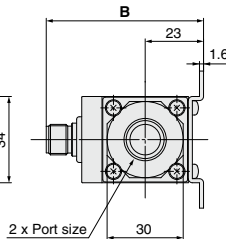
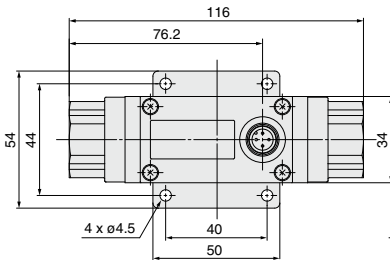

Output specifications	(mm)	
	A	B
Output for monitor unit only	48	62
Output for monitor unit + Analog output	58	72

Be sure to allow straight pipe length that is minimum 8 times the port size upstream and downstream of the switch piping.

### ZS-37-A Lead wire with M12 connector

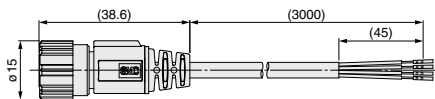
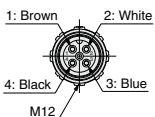

#### Lead Wire Specifications

Conductor	Nominal cross section	AWG23
	O.D.	Approx. 0.7 mm
Insulator	Material	Cross-linked vinyl
	O.D.	Approx. 1.1 mm
Sheath	Color	Brown, White, Black, Blue
	Material	Oil-resistant vinyl
Finished O.D.	ø4	

**Dimensions: Remote Type Monitor Unit For Air**

**PF2A3□□-A**

**Panel mount adapter type**

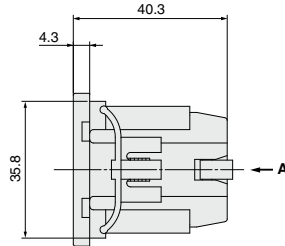
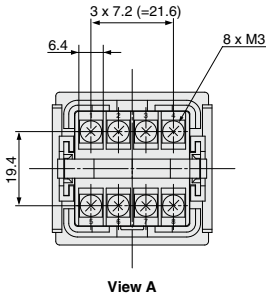
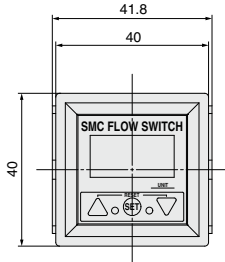

**Panel fitting dimensions**

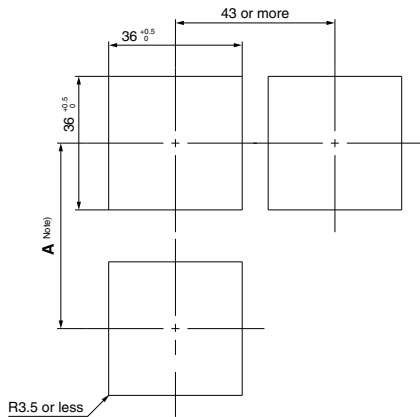

Note) Decide the length of A taking into account the size of terminal you use.  
\* The applicable panel thickness is 1 to 3.2 mm.

**Analog output  
1 to 5 VDC**

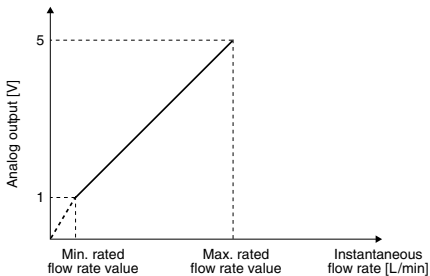

**4 to 20 mA DC**

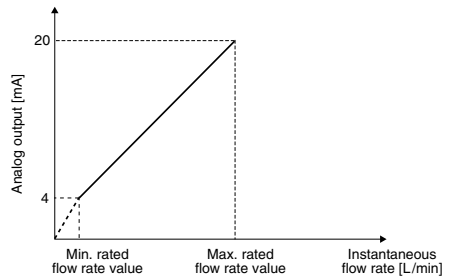

Part no.	Normal condition		Standard condition	
	Min. rated flow rate value [L/min]	Max. rated flow rate value [L/min]	Min. rated flow rate value [L/min]	Max. rated flow rate value [L/min]
PF2A510-□-1	1	10	1.1	10.7
PF2A550-□-1	5	50	5.4	53.5
PF2A511-□-1	10	100	11	107
PF2A521-□-1	20	200	21	214
PF2A551-□-1	50	500	54	535

Part no.	Normal condition		Standard condition	
	Min. rated flow rate value [L/min]	Max. rated flow rate value [L/min]	Min. rated flow rate value [L/min]	Max. rated flow rate value [L/min]
PF2A510-□-2	1	10	1.1	10.7
PF2A550-□-2	5	50	5.4	53.5
PF2A511-□-2	10	100	11	107
PF2A521-□-2	20	200	21	214
PF2A551-□-2	50	500	54	535

PFM

PFMB

PFMC

PFMV

**PF2A**

PF3W

LFE

PF2D

IF

# PF2A Series

## Dimensions: Remote Type Monitor Unit **For Air** (4-channel Flow Monitor)

PF2A200, 201

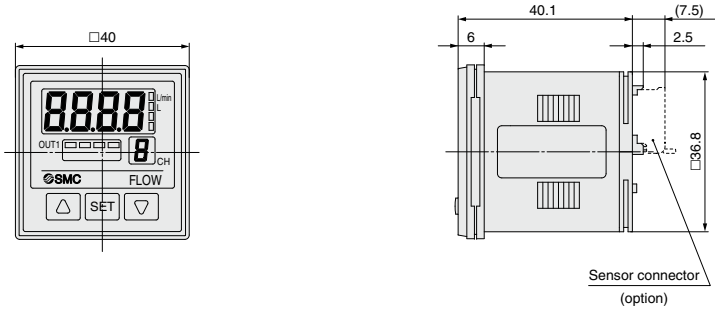

### Front protective cover + Panel mount adapter

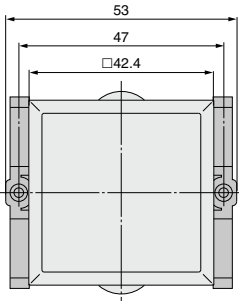

Panel fitting dimensions

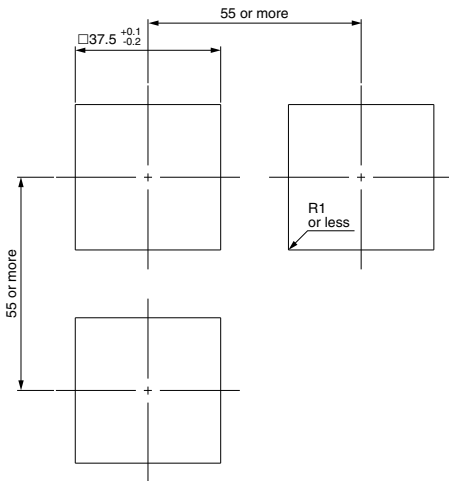
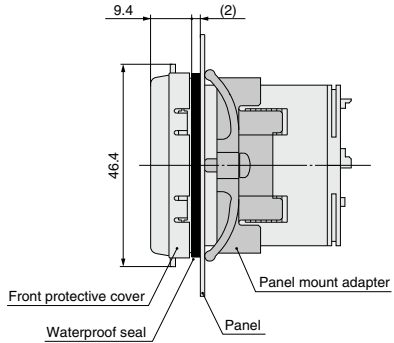

\* Applicable panel thickness: 0.5 to 8 mm

**Dimensions: Remote Type Monitor Unit For Air (4-channel Flow Monitor)**

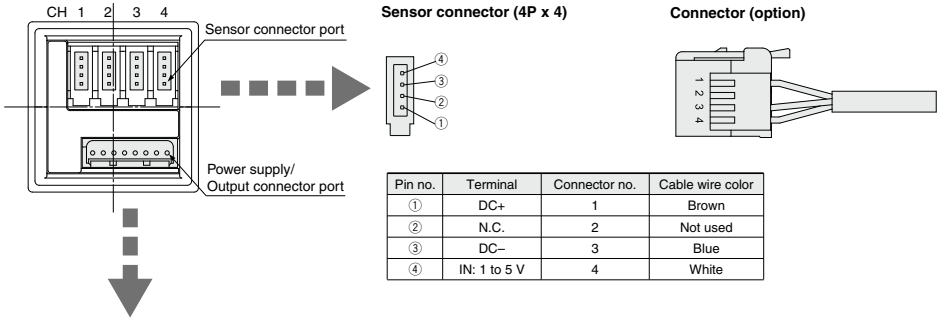

**Power supply/Output connector (8P)**

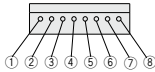

Pin no.	Terminal
①	DC (+)
②	DC (-)
③	CH1_OUT1
④	N.C.
⑤	CH2_OUT1
⑥	CH3_OUT1
⑦	CH4_OUT1
⑧	N.C.

**Power supply/Output connector (accessory)**

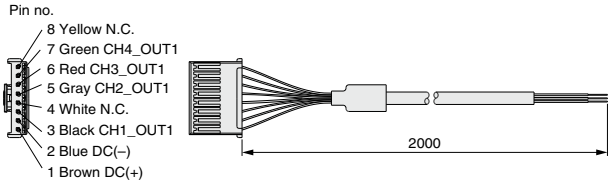

**Cable Specifications**

<b>Conductor</b>	<b>No. of cable wire</b>	8
	<b>Nominal cross-sectional area</b>	0.15 mm <sup>2</sup>
	<b>Dimension</b>	Approx. 0.5 mm
<b>Insulator</b>	<b>Dimension</b>	Approx. 0.9 mm Brown, White, Blue, Black, Gray, Red, Green, Yellow
	<b>Material</b>	Heat-resistant polyethylene
<b>Sheath</b>	<b>O.D.</b>	4.8 mm

PFM

PFMB

PFMC

PFMV

**PF2A**

PF3W

LFE

PF2D

IF

# For Air

## Digital Flow Switch/High Flow Rate Type

# PF2A Series



### How to Order



Integrated Display Type

PF2A7 [ ] H - [ ] - [ ] - [ ] - [ ] - M - [ ]

**Flow rate range**

03	150 to 3000 L/min
06	300 to 6000 L/min
12	600 to 12000 L/min

High flow rate type

**Port specifications**

Nil	Rc
N	NPT
F	G*

\* Conforming to ISO228-1.

**Port size**

Symbol	Port size	Flow rate (L/min)			Applicable model
		3000	6000	12000	
10	1	●			PF2A703H
14	1 1/2		●		PF2A706H
20	2			●	PF2A712H

**Lead wire** (Refer to page 326.)

Nil	Lead wire with M12 connector (3 m)
N	Without lead wire

**Made to Order**

X795	Wide range
------	------------

Refer to page 323 for details.

**Unit specifications**

Nil	With unit switching function <sup>Note1)</sup>
M	Fixed SI unit <sup>Note2)</sup>

Note1) Under Japan's new Measurement Act, this is only for overseas sales (SI units are to be used inside Japan).

Note2) Fixed units: Instantaneous flow rate: L/min  
Accumulated flow: L, m<sup>3</sup>, m<sup>3</sup> x 10<sup>3</sup>

**Output specifications**

28	NPN open collector 1 output + Analog output (1 to 5 V)
29	NPN open collector 1 output + Analog output (4 to 20 mA)
68	PNP open collector 1 output + Analog output (1 to 5 V)
69	PNP open collector 1 output + Analog output (4 to 20 mA)

Switching of switch output and accumulated pulse output is possible with NPN or PNP open collector outputs.

### Specifications

Refer to pages 202 and 203 for Flow Switch Precautions. For details about the Specific Product Precautions, refer to the Operation Manual on the SMC website, <http://www.smcworld.com>

Model	PF2A703H	PF2A706H	PF2A712H
<b>Measured fluid</b>		Dry air, Nitrogen	
<b>Detection type</b>		Heater type	
<b>Rated flow range</b> <sup>Note 1)</sup>	150 to 3000 L/min	300 to 6000 L/min	600 to 12000 L/min
<b>Minimum set unit</b> <sup>Note 1)</sup>	5 L/min		10 L/min
<b>Display units</b> <sup>Note 2)</sup>	L/min, CFM		
<b>Accumulated flow</b>	L, m <sup>3</sup> , m <sup>3</sup> x 10 <sup>3</sup> , ft <sup>3</sup> , ft <sup>3</sup> x 10 <sup>3</sup> , ft <sup>3</sup> x 10 <sup>6</sup>		
<b>Operating pressure range</b>	0.1 to 1.5 MPa		
<b>Proof pressure</b>	2.25 MPa		
<b>Pressure loss</b>	20 kPa (at maximum flow rate)		
<b>Accumulated flow range</b> <sup>Note 3)</sup>	0 to 9,999,999,999 L		
<b>Accuracy</b> <sup>Note 4, 5)</sup>	±1.5% F.S. (0.7 MPa, at 20°C)		
<b>Repeatability</b>	±1.0% F.S. (0.7 MPa, at 20°C), ±3.0% of F.S. in case of analog output		
<b>Pressure characteristics</b>	±1.5% F.S. (0.1 to 1.5 MPa, 0.7 MPa reference)		
<b>Temperature characteristics</b>	±2.0% F.S. (0 to 50°C, 25°C reference)		
<b>Output specifications</b>	<b>Switch output</b> <sup>Note 6)</sup>	NPN open collector Max. load current: 80 mA; Max. applied voltage: 30 V; Internal voltage drop: 1 V or less (with load current of 80 mA) PNP open collector Max. load current: 80 mA; Internal voltage drop: 1.5 V or less (with load current of 80 mA)	
	<b>Accumulated pulse output</b> <sup>Note 6)</sup>	NPN or PNP open collector Flow rate per pulse: 100 L/pulse, 10.0 ft <sup>3</sup> /pulse ON time per pulse width: 50 msec	
	<b>Analog output</b> <sup>Note 7)</sup>	Output voltage: 1 to 5 V; Min. load impedance: 100 kΩ (Output impedance: 1 kΩ) Output current: 4 to 20 mA; Max. load impedance: 250 Ω	
<b>Response time</b>	1 sec. or less		
<b>Hysteresis</b>	Hysteresis mode: Variable (can be set from 0); Window comparator mode: (can be set from 0 to 3% F.S.)		
<b>Power supply voltage</b>	24 VDC ±10%		
<b>Current consumption</b>	150 mA or less		
<b>Environment</b>	<b>Enclosure</b>	IP65	
	<b>Operating temperature range</b>	0 to 50°C (with no freezing and condensation)	
	<b>Withstand voltage</b>	1000 VAC for 1 minute between terminals and housing	
	<b>Insulation resistance</b>	50 MΩ or more (500 VDC measured via megohmmeter) between terminals and housing	
<b>Leakage resistance</b>	1000 Vp-p, Pulse width 1 μs, Rise time 1 ns		
<b>Standards and regulations</b>	CE, RoHS		
<b>Weight</b>	1.1 kg (without lead wire)	1.3 kg (without lead wire)	2.0 kg (without lead wire)
<b>Port size (Rc, NPT, G)</b>	1	1 1/2	2

Note 1) Flow rate display can be switched between the basic condition of 0°C, 101.3 kPa and the standard condition (ANR) of 20°C, 101.3 kPa, and 65% RH.  
 Note 2) For digital flow switch with unit switching function. (Fixed SI unit (L/min, or L<sup>3</sup> or m<sup>3</sup> x 10<sup>3</sup>) will be set for switch type without the unit switching function.)  
 Note 3) Accumulated flow rate is reset when the power supply turns OFF. It is possible to select a function that holds the accumulated value so it is not reset. In such cases, data is written on EEPROM (electrically erasable programmable read-only memory) at approximately four-minute intervals. When using, please take into consideration that the EEPROM writing is guaranteed up to 1 million times (four minutes x 1 million = 4 million ≈ 7.9 years).  
 Note 4) The piping on the IN side must have a straight section of piping whose length is 8 times the piping diameter or more. If a straight section of piping is not installed, the accuracy may vary by ±1.5% F.S. or more.  
 Note 5) The high flow rate type is CE marking compatible; however, the linearity with applied noise is ±5% F.S. or less.  
 Note 6) Switch output and accumulated pulse output selections are made using the button controls. Note 7) The analog output operates only for instantaneous flow rate, and does not vary for accumulated flow.  
 Note 8) For details about wiring and thread type, refer to the Operation Manual that can be downloaded from SMC website (<http://www.smcworld.com>).  
 Note 9) Any products with tiny scratches, smears, or display color variation or brightness which does not affect the performance are verified as conforming products.



## Flow Rate Characteristics (Pressure Loss)

PF2A703H

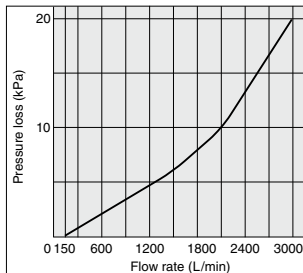

PF2A706H

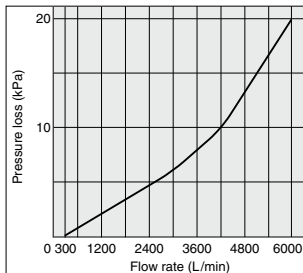

PF2A712H

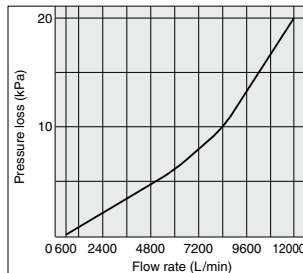

## Wetted Parts Construction

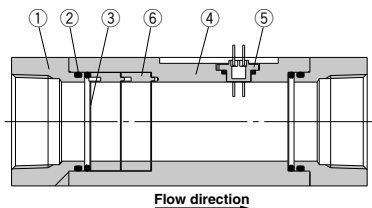

### Parts list

No.	Description	Material	Note
1	Attachment	Aluminum alloy	Anodized
2	Seal	HNBR	—
3	Mesh	Stainless steel	—
4	Body	Aluminum alloy	Anodized
5	Sensor	PPS	—
6	Spacer	PBT	—

## Internal Circuits and Wiring Examples

-28/29

28: NPN (1 output) + Analog voltage output  
29: NPN (1 output) + Analog current output

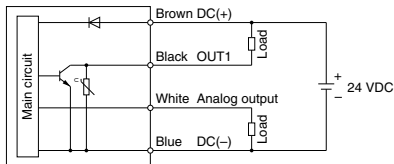

-68/69

68: PNP (1 output) + Analog voltage output  
69: PNP (1 output) + Analog current output

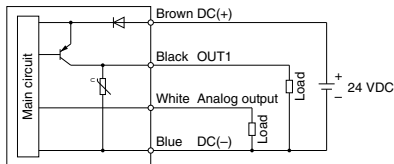

## Accumulated pulse output wiring examples

-28/29

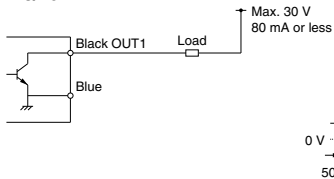

-68/69

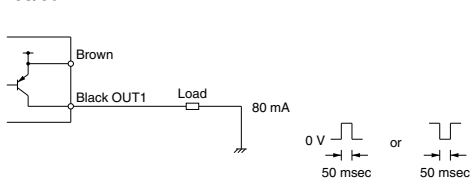

PFM

PFMB

PFMC

PFMV

PF2A

PF3W

LFE

PF2D

IF

# PF2A Series

## Dimensions

### PF2A703H, 706H, 712H

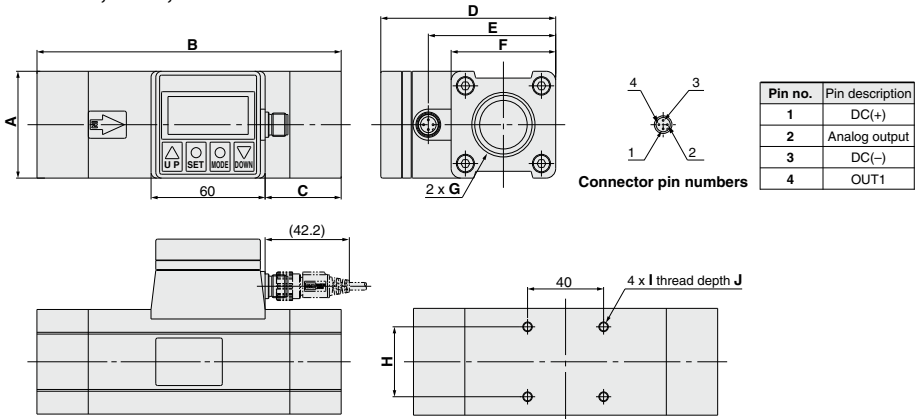

Be sure to allow straight pipe length that is minimum 8 times the port size upstream and downstream of the switch piping.

Model	A	B	C	D	E	F	G	H	I	J
PF2A703H	55	160	40	92	67	55	Rc1, NPT1, G1	36	M5 x 0.8	8
PF2A706H	65	180	45	104	79	65	Rc1 $\frac{1}{2}$ , NPT1 $\frac{1}{2}$ , G1 $\frac{1}{2}$	46	M6 x 1	9
PF2A712H	75	220	55	114	89	75	Rc2, NPT2, G2	56	M6 x 1	9

## ZS-37-A

### Lead wire with M12 connector

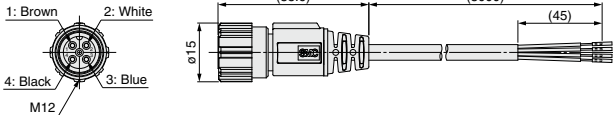

### Lead Wire Specifications

Conductor	Nominal cross section	AWG23
	O.D.	Approx. 0.7 mm
Insulator	Material	Cross-linked vinyl
	O.D.	Approx. 1.1 mm
Sheath	Color	Brown, White, Black, Blue
	Material	Oil-resistant vinyl
Finished O.D.	$\phi 4$	

### Analog output 1 to 5 VDC

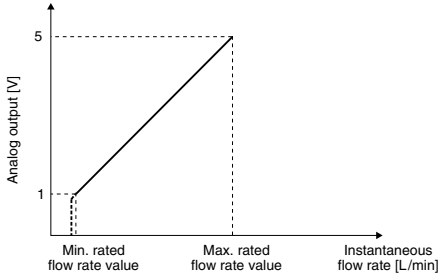

Part no.	Min. rated flow rate value [L/min]	Max. rated flow rate value [L/min]
PF2A703H-□-28 PF2A703H-□-68	150	3000
PF2A706H-□-28 PF2A706H-□-68	300	6000
PF2A712H-□-28 PF2A712H-□-68	600	12000

### 4 to 20 mA DC

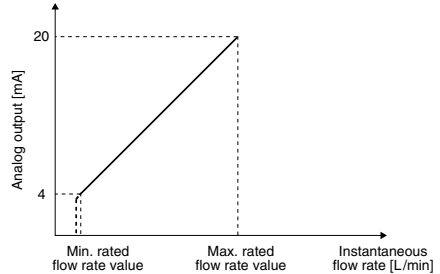

Part no.	Min. rated flow rate value [L/min]	Max. rated flow rate value [L/min]
PF2A703H-□-29 PF2A703H-□-69	150	3000
PF2A706H-□-29 PF2A706H-□-69	300	6000
PF2A712H-□-29 PF2A712H-□-69	600	12000

# PF2A7 Series Made to Order

Please contact SMC for detailed dimensions, specifications and lead times.



## 1 Wide Range Specifications

**-X795**

One flow switch can measure small flows to large flows by enlarging the lower limit of the flow rate measurement range.

Dynamic range 1:100 (Lower limit of the flow rate measurement: Upper limit of the flow rate measurement)

### How to Order

**Integrated Display Type** PF2A7 **03** H - **10** - **28** **M** - X795

**Flow rate range**

<b>03</b>	30 to 3000 L/min
<b>06</b>	60 to 6000 L/min
<b>12</b>	120 to 12000 L/min

**High flow rate type**

**Port specifications**

<b>Nil</b>	<b>Rc</b>
------------	-----------

**Port size**

Symbol	Port size	Flow rate (L/min)			Applicable model
		3000	6000	12000	
<b>10</b>	1	●			PF2A703H
<b>14</b>	1 1/2		●		PF2A706H
<b>20</b>	2			●	PF2A712H

**Unit specifications**

<b>M</b>	Fixed SI unit <sup>Note)</sup>
----------	--------------------------------

Note) Fixed units:  
Instantaneous flow rate: L/min  
Accumulated flow: L, m<sup>3</sup>, m<sup>3</sup> x 10<sup>3</sup>

**Lead wire** (Refer to page 326.)

<b>Nil</b>	Lead wire with M12 connector (3 m)
<b>N</b>	Without lead wire

**Output specifications**

<b>28</b>	NPN open collector 1 output + Analog output (1 to 5 V)
-----------	--

Switching of switch output and accumulated pulse output is possible with NPN outputs.

### Specifications

Model	Rated flow range	Displayable range	Settable range
<b>PF2A703H</b>	30 to 3000 L/min	20 to 3025 L/min	0 to 3025 L/min
<b>PF2A706H</b>	60 to 6000 L/min	40 to 6050 L/min	0 to 6050 L/min
<b>PF2A712H</b>	120 to 12000 L/min	80 to 12050 L/min	0 to 12050 L/min

### Dimensions

The PF2A7□□H series dimensions are the same as the standard models. Refer to page 322.

PFM  
PFMB  
PFMC  
PFMV  
PF2A  
PF3W  
LFE  
PF2D  
IF

# PF2A Series

## Functions

Refer to the operation manual for information on setting and operating.

### Flow rate measurement selection

Instantaneous flow rate and accumulated flow rate can be selected. A flow rate of up to 999999 can be accumulated. The accumulated flow rate is reset when the power supply turns OFF. (With PF2A7□H, it is possible to select a holding function.)

### Unit switching

For Air

Display	Instantaneous flow rate	Accumulated flow
U.1	L/min	L
U.2	CFM x 10 <sup>-2</sup> , CFM x 10 <sup>-1</sup>	ft <sup>3</sup> x 10 <sup>-1</sup>

CFM = ft<sup>3</sup>/min

High Flow Rate Type (For Air)

Display	Instantaneous flow rate	Accumulated flow
U.1	L/min	L, m <sup>3</sup> , m <sup>3</sup> x 10 <sup>3</sup>
U.2	CFM	ft <sup>3</sup> , ft <sup>3</sup> x 10 <sup>3</sup> , ft <sup>3</sup> x 10 <sup>6</sup>

For Water/High Temperature Fluid Type (For Water)

Display	Instantaneous flow rate	Accumulated flow
U.1	L/min	L
U.2	GPM	gal (US)

GPM = gal (US)/min

Note) Fixed SI unit (L/min, or L, m<sup>3</sup>, m<sup>3</sup> x 10<sup>3</sup>) will be set for the type without the display unit switching function.

### Flow rate conversion

Normal condition: 0°C, 101.3 kPa, dry air  
Standard condition: 20°C, 101.3 kPa, 65%RH (ANR)  
Switchable between these conditions.

### Flow rate measuring unit confirmation

This function allows for the confirmation of the accumulated flow rate when instantaneous flow rate is selected and to confirm the instantaneous flow rate when accumulated flow rate is selected.

### Keylock

This function prevents accidental operations such as changing the set value.

### Accumulation clearance

This function clears the accumulated value.

### Initialization of setting (only for PF2A7□□H series)

This function restores the setting to the original state, just as it had been shipped from the factory.

### Output types

Real-time switch output, accumulated switch output, or accumulated pulse output can be selected as an output type.

#### Real-time switch output

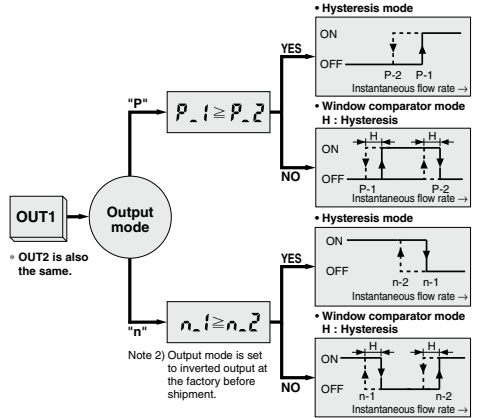

#### Accumulated switch output

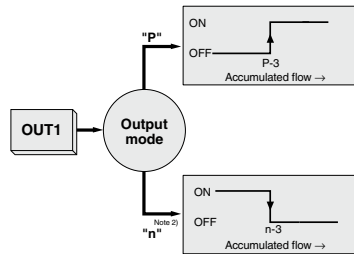

#### Accumulated pulse output

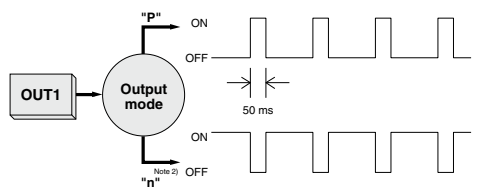

## Functions

### Copy function (PF2□200, 201 only)

Information to be copied is:

- ① Flow rate range
- ② Display mode
- ③ Display unit (Only available when the unit specification is nil.)
- ④ Output method
- ⑤ Output mode
- ⑥ Flow rate display unit (available with PF2A20□ only)
- ⑦ Flow rate value

### Peak hold, Bottom hold display function (PF2□200, 201 only)

The maximum or minimum value can be held in the case where the instantaneous flow rate display mode is selected during the initial setting. The hold value is reset when the power supply turns OFF or the hold is released.

### Error correction

LED display	Contents	Action
Er1 <small>Note 1)</small>	A current of more than 80 mA is flowing to OUT1.	Check the load and the wiring for OUT1.
Err1 <small>Note 2)</small>	A current of more than 80 mA is flowing to OUT2.	Check the load and the wiring for OUT2.
Err3 <small>Note 2)</small>	The set data has changed for some reason.	Perform the RESET operation, and reset all the data again.
Er4 <small>Note 1)</small>	The flow rate is over the flow rate measurement range.	Use an adjustment valve, etc. to reduce the flow rate until it is within the flow rate range.
--- <small>Note 1)</small>		
--- <small>Note 2)</small>		

Note 1) Applicable to monitor integrated type and remote type except the PF2A7□□H series.

Note 2) Applicable to the PF2A7□□H series only.

### For PF2A200, 201

LED display	Contents	Action
Er1	Over current is flowing to the load of a switch output.	Eliminate the cause of the over current by turning off the power supply, and then turn on it again.
Er0	Internal data error.	Please contact SMC for investigation.
Er7	Internal data error.	
Er10	Internal data error.	
Er5	Internal data error.	Turn off the power supply and then turn on it again.
Er6	Internal data error.	
---	The flow rate is over the flow rate measurement range.	Use an adjustment valve, etc. to reduce the flow rate until it is within the flow rate range.

### Channel select function (PF2□200, 201 only)

Every pushing the  $\Delta$  button, channel selection "1→2→3→4→1..." is available. The flow rate measurement of each selected channel is shown in the monitor unit.

### Channel scan function (PF2□200, 201 only)

Changes displaying the channel shown every about 2 seconds and its detected flow rate.

## Detection principle of digital flow switch for air

A heated thermistor is installed in the passage, and fluid absorbs heat from the thermistor as it is introduced to the passage. The thermistor's resistance value increases as it loses heat. Since the resistance value increase ratio has a uniform relationship to the flow velocity, the flow velocity can be detected by measuring the resistance value. To further compensate the fluid and ambient temperature, the temperature sensor is also built into the switch to allow stable measurement within the operating temperature range.

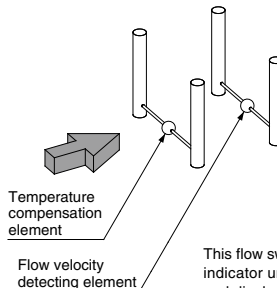

This flow switch uses L/min as the flow rate indicator unit. The mass flow is converted and displayed under the conditions of 0°C and 101.3 kPa and 20°C and 101.3 kPa.

Contact SMC regarding the specifications for clean environment.

PFM

PFMB

PFMC

PFMV

PF2A

PF3W

LFE

PF2D

IF

# PF2A Series

## Option

When only optional parts are required, order with the part numbers listed below.

### Lead wire with M12 connector

Part no.	Qty.	Lead wire length
ZS-37-A	1	3 m

### e-con connector

Part no.	Qty.
ZS-28-CA-4	1

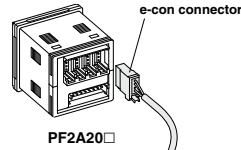
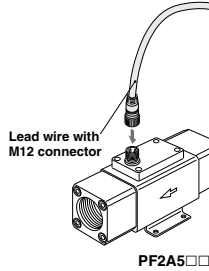
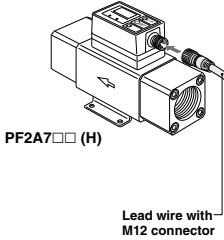

In addition to the lead wire assembly shown above, those listed below (female contact) can be connected. However, they cannot be connected with an e-con connector because the diameter of the core wire and its coverage diameter are different. For details, contact each manufacturer. Contact each manufacturer for details including RoHS compliance.

Connector size	Pin no.	Manufacturer	Applicable series
M12	4	Correns Corp.	VA-4D
		OMRON Corp.	XS2
		Azbil Corp.	PA5-4I
		HIROSE ELECTRIC CO., LTD.	HR24
		DDK Ltd.	CM01-8DP4S

In addition to the connectors shown above, those listed below (e-con) can be connected.

Manufacturer	Model
3M Japan Limited	37104-3122-000FL
Tyco Electronics Japan G.K.	2-1473562-4
OMRON Corp.	XN2A-1430

## Cable Specifications

No. of cable wire	4	
Conductor	Nominal cross-sectional area	AWG23
	Dimension	0.72 mm
Insulator	Dimension	1.14 mm Brown, White, Blue, Black
	Material	Heat-resistant and oil-resistant lead-free PVC
Sheath	O.D.	4.00 mm

## Panel mounting

Pin no.	Description	Note
ZS-22-E	Panel mount adapter A, B	With mounting bracket

Part no.	Description	Note
ZS-26-B	Panel mount adapter	With waterproof seal, mounting screw
ZS-26-C	Front protective cover + Panel mount adapter	With waterproof seal, mounting screw

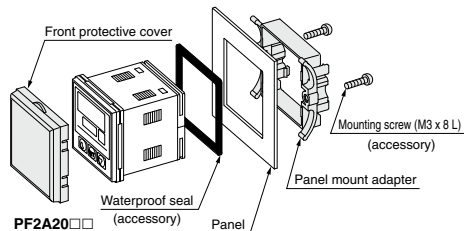
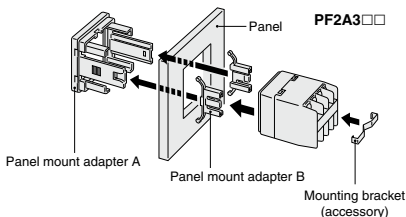

# Related Product

## Multi Counter/*CEU5* Series



### How to Order

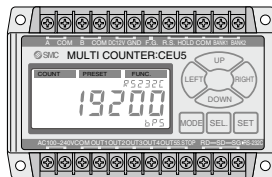
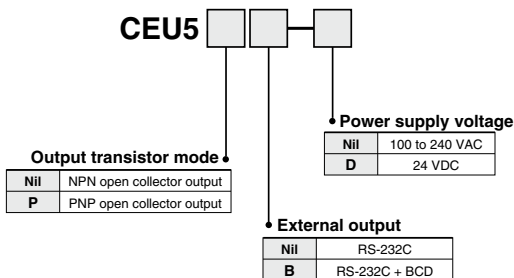

### Connection Method

#### Connection with the Digital Flow Switch (PF2 series)

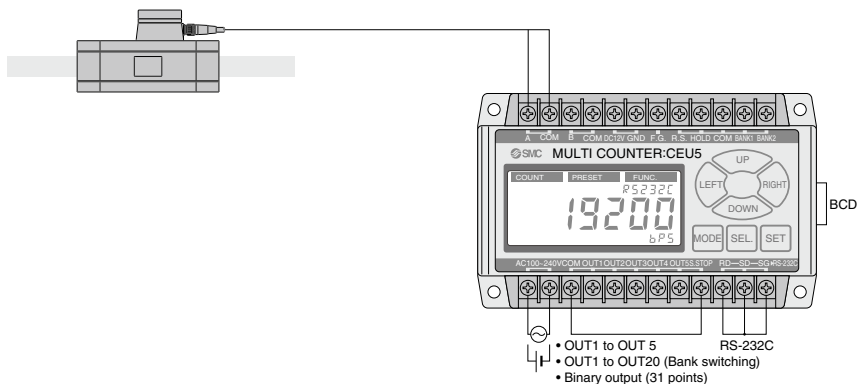

- PFM
- PFMB
- PFMC
- PFMV
- PF2A
- PF3W
- LFE
- PF2D
- IF

- Possible to measure accumulated pulse output of a Digital Flow Switch by an unit of 100 L (liter) and 10 ft<sup>3</sup> (cube foot) using the pre-scaling function\* of the multi counter (When inputting to the multi counter, Up or Down is selected as input method.)
- Possible to take advantage of all CEU5 functions using preset mode and function mode.

\* The set value is calculated by selecting manual mode. By multiplication by 4, then, per pulse value is set.

#### <Connection with other manufacturers' encoders>

- Possible to switch multi counter side input method to 2-phase or Up/Down.
- Possible to connect to an encoder if the output method is Open Collector.
- When selecting UP or DOWN, phase A to COM input is counted toward addition direction, phase B to COM input is counted toward subtraction direction.

#### ⚠ Caution

When connecting the CEU5 with an encoder from another manufacturer, please thoroughly confirm the specification beforehand. Please note that the CEU5 may not count normally depending on the output method, output frequency and connecting cable length, etc. of the encoders.