

Process Pump (Diaphragm Pump)

PB Series

Compact, large capacity diaphragm pump, suitable for transferring and collecting a wide range of fluids

palmtop size



* Built-in solenoid valve only
RoHS

Smaller, lighter, **25%*** reduction in volume

* PB1013A/Air-operated type without foot

(Comparison with current PB series)

Long service life **1.5 times**

(Comparison with current PB series)

Discharge

8 to 2000 mL/min*

* PB1013A and PB1313A are available up to 1000 mL/min.

Weight **0.11 kg**

* PB1013A/Air-operated type without foot

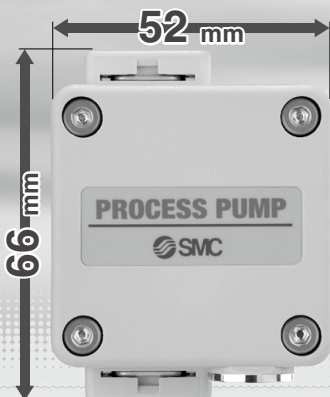

Space saving (Air operated)

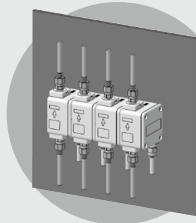

Reagents transfer in a pathological inspection device

- Low particle generation due to the diaphragm structure
- Flammable fluids can be used. (Air operated)
- Self-priming makes priming unnecessary. Sucks the liquid even if the pump is dry.
- Assembled in a clean room. Double packaged (PB1313A)
- Easy to adjust the flow rate by the frequency of ON/OFF of the solenoid valve.

Application Examples

Car washing machine

Water/detergents supply

Printing machine

Ink/solutions supply

Semiconductor/LCD equipment

DI water/solutions supply, Waste fluid collection

Analyzer for medical and biochemistry

Reagents supply

Machine tool

Oil supply

Cleaning device

DI water/hydro-carbonic cleaning liquid supply

Devices related to solar cell/secondary battery

Electrolyte/ DI water supply

Body wetted parts

Polypropylene
Stainless steel 316

Wetted materials

Body: New PFA
Diaphragm: PTFE



PB1011A
Built-in solenoid valve



PB1013A
Air operated



PB1313A
Air operated

Process Pump

Built-in Solenoid Valve/Air Operated *PB1000A Series*

Ease of maintenance improved

Piping connection port can be removed. The check ball can be replaced for maintenance easily.

The port can be removed by pulling out the clip.

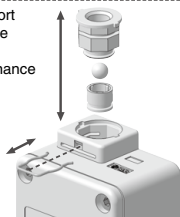

Check valve is resistant against foreign matter.

Flow passage around the check ball is enlarged and improved for better resistance against foreign matter.

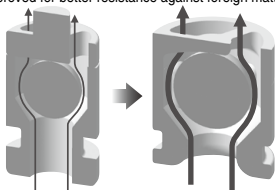

Fluid passage area comparison

1.5 times (Comparison with current PB series)

Discharge port
<FLUID OUT>



<AIR SUP>
Air supply port

<FLUID IN>
Suction port

Smaller, lighter, 25% reduction in volume
(Air operated/PB1013A)

Power consumption reduced

0.45 W → **0.35 W**

CE-compliant
(Built-in solenoid valve/PB1011A)

Longer life [Life is 1.5 times longer than the current product.]

Longer life is realized by changing PTFE diaphragm to modified PTFE with better resistance.

RoHS

Mounting Variations Note) Mounting orientation: <FLUID OUT> port on top only

■ Front mounting (with foot)

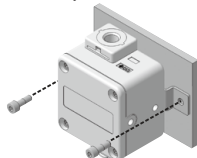

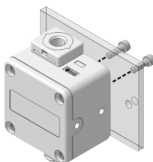

■ Rear mounting

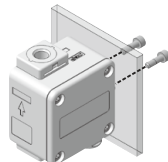

■ Side mounting * PB1013A only



Series Variations

Series	Actuation	Discharge (mL/min)	Material				Port size	Made to Order
			Body wetted parts	Diaphragm	Check valve	Liquid contact seals		
 PB1011A	Built-in solenoid valve	8 to 2000	Polypropylene (PP) Stainless steel (SUS316)	PTFE	PTFE PP	FKM	1/8 female thread	—
 PB1013A	Air operated	8 to 1000						Liquid contact seals SF7000 With bracket which is interchangeable with previous type
 PB1313A	Air operated	8 to 1000	New PFA	PTFE	PTFE New PFA	PTFE	1/8 female thread, 1/4" tube extension, With nut (LQ1/LQ3)	—

Note) Refer to page 625 for applicable fluids.

Air Operated/Wetted Materials: Fluoropolymer PB1313A Series

Compact pump for DI water/chemical liquids

- For transferring and collecting DI water/chemical liquids* ● Wetted materials: **Body** New PFA **Diaphragm** PTFE
- * Refer to page 625 for applicable fluids.
- Assembled in a clean room. Double packaged



Variation on fittings with nut (PB1313A only)

Insert bushing type (LQ1 fittings)



Triple seal construction

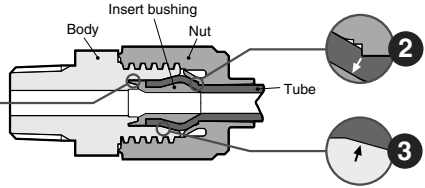

Flare type (LQ3 fittings)



Triple seal construction

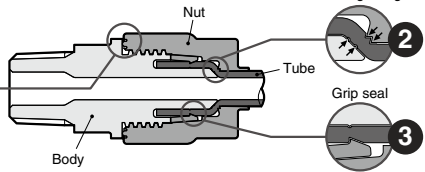

PA
PA(P)
PAX
PB
PAF
PA <input type="checkbox"/>
PB <input type="checkbox"/>

Application Examples

■ Car washing machine

Detergents transfer

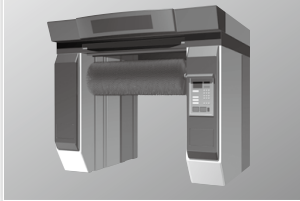

■ Printing machine

Head cleaning liquid transfer

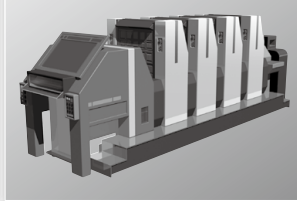

■ Machine tool

Coolant liquid collection

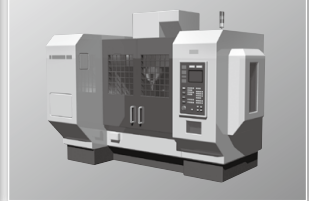

■ Analyzer (For medical/biochemical industry)

Reagents transfer



■ Related to semiconductor/solar cell

Cleaning liquid (e.g. DI water) collection



Installation Examples

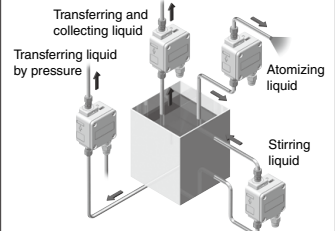

Process Pump (Diaphragm Pump)

Body Wetted Parts: Polypropylene/Stainless Steel
Built-in Solenoid Valve/Air Operated (External switching type)

PB1000A Series



How to Order

* Built-in solenoid valve only

Built-in Solenoid Valve
PB1011A



Air Operated
PB1013A



PB101 1 A - 01 - - -

Actuation

Symbol	Actuation
1	Built-in solenoid valve
3	Air operated

Thread type

Symbol	Type
Nil	Rc
N	NPT
F	G

Port size

Symbol	Port size
01	1/8

Made to Order

(For details, refer to page 588.)

Nil	None
X16	Liquid contact seals SF7000
X47	With bracket which is interchangeable with previous type

* Only PB1013A, air-operated type is available to be made to order.

Option

Symbol	Option	Applicable actuation	
		Built-in solenoid valve	Air operated
Nil	None	●	●
B	With foot	●	●
N	With silencer **	●	—

* When option is more than one, suffix in alphabetical order.

** For AIR EXH: AN120-M5

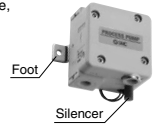

Specifications

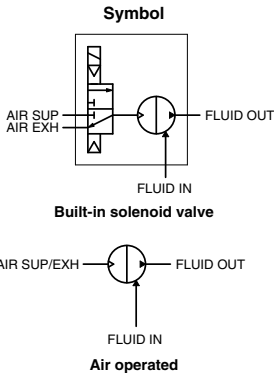

Model	PB1011A	PB1013A
Actuation	Built-in solenoid valve	Air operated
Port size	Main fluid suction/discharge port	Rc, NPT, G 1/8 female thread
	Pilot air	Rc, NPT, G 1/8 female thread
	Supply port Exhaust port	M5 x 0.8 female thread
Material	Body wetted parts	Polypropylene (PP), Stainless steel (SUS316)
	Diaphragm	PTFE
	Check valve	PTFE, Polypropylene (PP)
	Liquid contact seals	FKM
Discharge ^{Note 1)}	8 to 2000 mL/min	8 to 1000 mL/min ^{Note 2)}
Average discharge pressure	0 to 0.6 MPa	—
Pilot air pressure	0.2 to 0.7 MPa	—
Air consumption	40 L/min (ANR) or less	—
Suction head ^{Note 1)}	Up to 2.5 m (dry state inside the pump)	—
Noise	64 dB (A) or less (Option: With silencer AN120-M5)	—
Withstand pressure	1.05 MPa	—
Diaphragm life (Reference)	30 million cycles	—
Fluid temperature	0 to 50°C (No freezing, heat cycle not applied)	—
Ambient temperature	0 to 50°C (No freezing, heat cycle not applied)	—
Recommended operating cycle	1 to 10 Hz	—
Pilot air solenoid valve recommended Cv value	—	0.2 ^{Note 3)}
Weight	0.18 kg	0.11 kg
Mounting orientation	FLUID OUT port upside	
Packaging	General environment	
Maximum viscosity	100 mPa·s	
Power supply voltage	24 VDC	—
Power consumption	0.35 W	—

* Each of the values above are for normal temperatures and clear water.

* For related products, refer to pages 622 to 623.

* Faulty sealing of the check valves or accumulation of dust may cause operation to stop, so slurry processing is not available.

* Refer to page 586 for maintenance parts.

Note 1) The values given for discharge and suction head are for no piping. Values will depend on piping conditions.

Note 2) Applicable up to 2000 mL/min by using a solenoid valve with a large Cv value (Cv value of 0.5 or more).

Note 3) With low operating cycles, even a valve with a small Cv value can be operated.

Flow Rate Characteristics

Built-in Solenoid Valve (PB1011A)

Cycle (1 Hz)

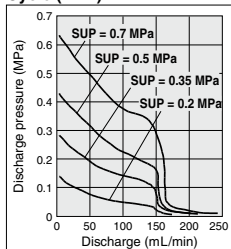

Cycle (5 Hz)

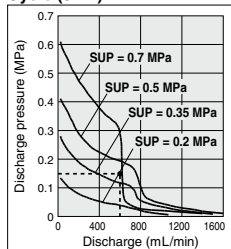

Cycle (7 Hz)

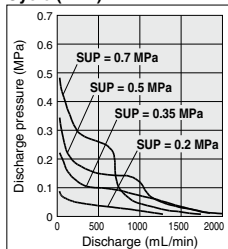

Selection from Flow Rate Characteristic Graph

■ Required specification example

Find the pilot air pressure for a discharge rate of 600 mL/min and a discharge pressure of 0.15 MPa for built-in solenoid valve type.

<The transferred fluid is clear water (viscosity of 1 mPa·s, specific gravity of 1.0) and solenoid valve cycle is 5 Hz.>

* When the total pump head is required instead of the discharge pressure, a discharge pressure of 0.1 MPa corresponds to a total pump head of 10 m.

■ Selection procedure

1. First, mark the intersection point for a discharge rate of 600 mL/min and a discharge pressure of 0.15 MPa.
2. Find the pilot air pressure for the marked point. In this case, the point is between the discharge curves for 0.35 MPa and 0.5 MPa, and based on the proportional relationship to these lines, the pilot air pressure for this point is approximately 0.4 MPa.

⚠ Caution

1. Flow rate characteristics are for clear water (viscosity of 1 mPa·s, specific gravity of 1.0), no piping for suction and discharge.
2. The amount of discharge differs greatly depending on properties (viscosity, specific gravity) of the fluid being transferred and operating conditions (pump head, transfer distance), etc.

PA

PA(P)

PAX

PB

PAF

PA□

PB

Air Operated (PB1013A)

Cycle (1 Hz)

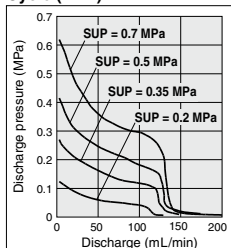

Cycle (5 Hz)

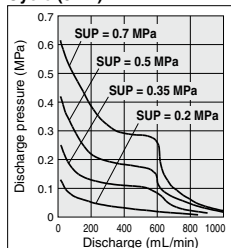

Cycle (7 Hz)

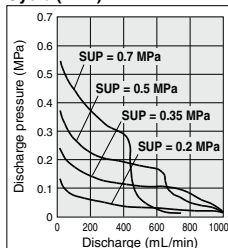

Air Consumption: Built-in Solenoid Valve/Air Operated

Air Consumption

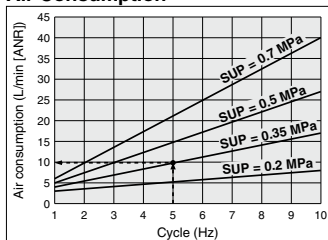

Calculation of Air Consumption

Find the air consumption for operation with a 5 Hz switching cycle and pilot air pressure of 0.35 MPa from the air consumption graph.

■ Selection procedure

1. Look up from the 5 Hz switching cycle to find the intersection with SUP = 0.35 MPa.
2. From the point just found, draw a line to the Y-axis to find the air consumption. The result is approximately 10 L/min (ANR).

⚠ Caution

1. The air consumption differs greatly depending on properties (viscosity, specific gravity) of the transferred fluid and operating conditions (pump head, transfer distance), etc.

Viscosity Characteristics: Built-in Solenoid Valve/Air Operated

Viscosity Characteristics

(Flow rate correction for viscous fluids)

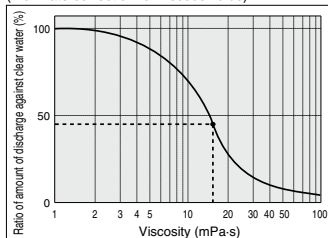

* Transfer is possible up to about 100 mPa·s.

Selection from Viscosity Characteristic Graph

■ Required specification example

Find the pilot air pressure and pilot air consumption for a discharge rate of 270 mL/min, discharge pressure of 0.15 MPa, and a viscosity of 15 mPa·s.

■ Selection procedure

1. First, find the ratio of the amount of discharge against clear water when viscosity is 15 mPa·s from the graph to the left. It is determined to be 45%.
2. Next, the viscosity of 15 mPa·s and the discharge rate of 270 mL/min in the required specification example are converted to the amount of discharge for clear water. Since 45% of the clear water discharge is equivalent to 270 mL/min in the required specifications, 270 mL/min [] 0.45 = approximately 600 mL/min, indicating that a discharge rate of 600 mL/min is required for clear water.
3. Finally, find the pilot air pressure and pilot air consumption based on the flow rate characteristic graphs.

■ Relationship between the kinematic viscosity

Kinematic viscosity ν [m²/s] = Viscosity μ [Pa·s]/Density [kg/m³]

$$\begin{pmatrix} \cdot 1 \text{ cP} = 1 \text{ mPa}\cdot\text{s} = 10^{-3} \text{ Pa}\cdot\text{s} \\ \cdot 1 \text{ cSt} = 1 \text{ mm}^2/\text{s} = 10^{-6} \text{ m}^2/\text{s} \end{pmatrix}$$

PB1000A Series

Working Principle: Built-in Solenoid Valve/Air Operated

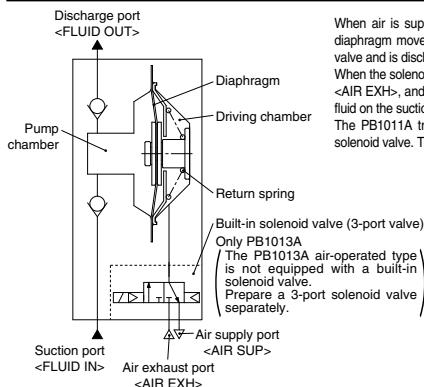

When air is supplied with the built-in solenoid valve turned ON (energized), air enters the driving chamber and the diaphragm moves to the left. Due to this movement, the fluid in the pump chamber passes through the upper check valve and is discharged to the discharge port <FLUID OUT>.

When the solenoid valve is turned OFF (de-energized), the air inside the driving chamber is evacuated to air exhaust port <AIR EXH>, and the diaphragm is moved to the right by the return force of the return spring. Due to this movement, the fluid on the suction port <FLUID IN> passes through the check valve and is sucked into the pump chamber.

The PB1011A transfers the fluid continuously by suction and discharge in turn by repeating ON/OFF of the built-in solenoid valve. The PB1013A air-operated type is operated by the ON/OFF operation of an external solenoid valve.

Maintenance Parts

- ⚠ Basically, it is not recommended to disassemble the process pump. However, if this is necessary, be sure to follow the instructions in the maintenance procedure.
- When carrying out this work, wear appropriate protective equipment.

PB1000A Series

Description	PB1000A series	
	PB1011A	PB1013A
Diaphragm kit	KT-PB1A-9	KT-PB1A-2
Check valve kit	KT-PB1A-1	
Port set	KT-PB1A-7□ (Note)	
Packing kit	KT-PB1A-4	
Foot kit	KT-PB1-3	KT-PB1A-5
Solenoid valve kit	SYJ314M-5H-Q	—

(Note) One of Nil, F or N is entered as a thread symbol.

Piping and Operation: Built-in Solenoid Valve/Air Operated

Piping diagram

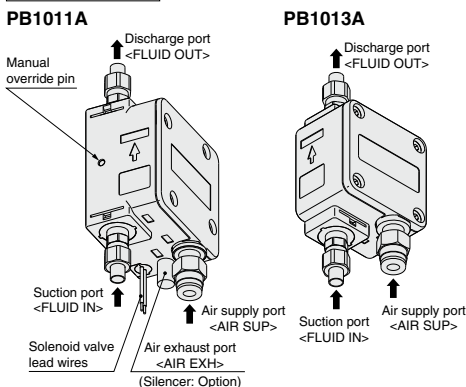

Caution

Be sure that the discharge port <FLUID OUT> is on top when the pump is mounted. Supply clean air that has passed through a filter or mist separator, etc., to the air supply port <AIR SUP>. Air that contains debris or drainage, etc., will have an adverse effect on the built-in solenoid valve, and will cause malfunction of the pump. Maintain the proper tightening torque for fittings or mounting bolts. Looseness can cause problems such as liquid or air leakage, while over-tightening can cause damage to threads or parts, etc.

Operation

1. Connect air piping to the air supply port <AIR SUP>, and connect piping for transferred fluid to the suction port <FLUID IN> and the discharge port <FLUID OUT>.
2. Connect the solenoid valve lead wires to a 24 VDC power supply. Red is (+) and Black is (-). (The PB1013A air-operated type must be equipped with a separate 3-port solenoid valve.)
3. Using a regulator, set the pilot air pressure within the range of 0.2 to 0.7 MPa. By continuously turning the 24 VDC power ON/OFF, the fluid flows from the suction port <FLUID IN> to the discharge port <FLUID OUT>. The pump performs suction with its own power even without priming. Idle run of the pump shall be 3 minutes or less for the intake of the liquid.
4. To stop the pump turn OFF the 24 VDC power. Also, be sure to turn OFF the power when the discharge side is closed. If the pump is stopped for a long time, exhaust the air from the <AIR SUP> port. The manual override pin is used for manual operation when there is no electric power. Each time it is pressed, there is one reciprocal operation. For the PB1013A air-operated type, stop the 3-port solenoid valve, and be sure to discharge air from the pump. Although the pump can be stopped by closing the throttle installed in the discharge side, avoid stopping operation for a long time. If the valve opens/closes suddenly, surge is generated, shortening the pump life. When the tank for fluid suction side is empty, stop operating the pump immediately.

Recommended Valve (Air operated)

PB1013A	SYJ5□4
---------	--------

Circuit example/Built-in solenoid valve

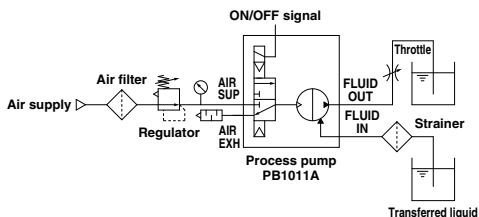

Circuit example/Air operated

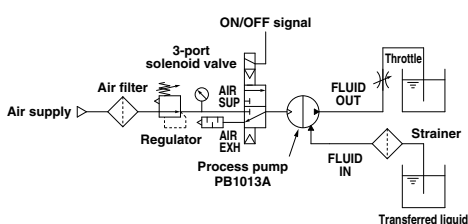

Dimensions

Built-in Solenoid Valve PB1011A

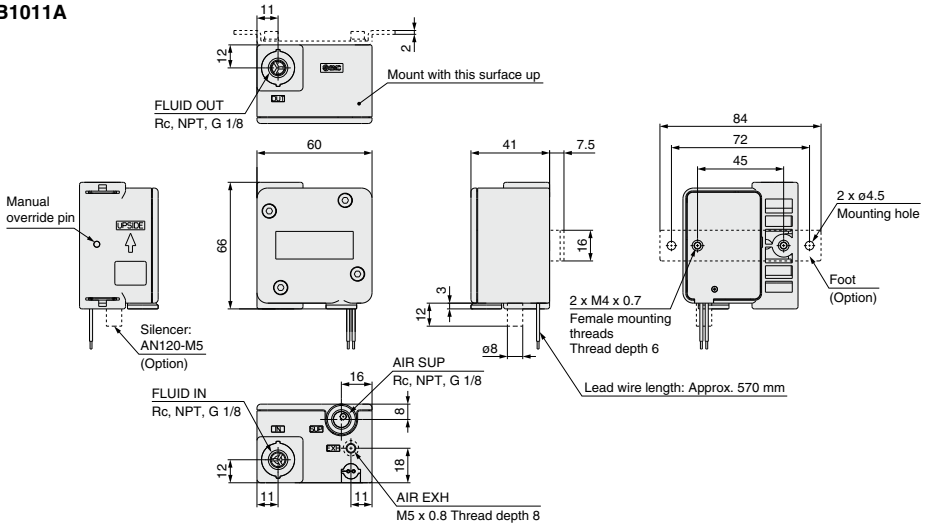

Air Operated PB1013A

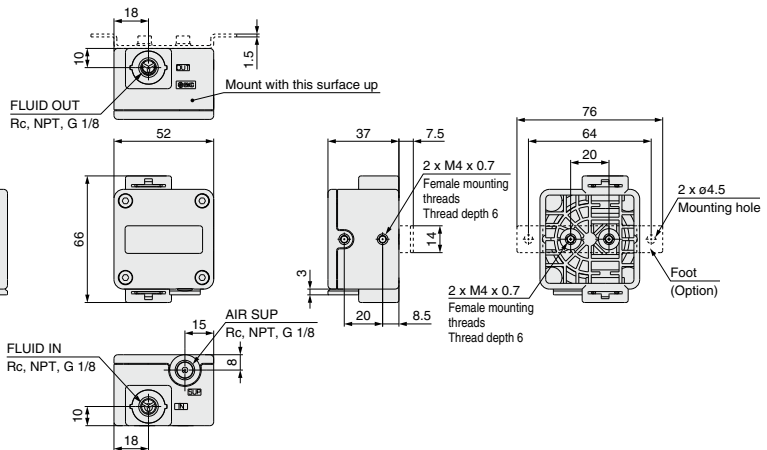

⚠ Caution

1. Check the mounting orientation of the product.
Mount the product vertically so that the <FLUID OUT> port faces upward.
Also, secure all specified mounting positions when using the product. If the propagation of the vibration of the pump is not acceptable, insert vibro-isolating rubber when mounting.

PA
PA(P)
PAX
PB
PAF
PA <input type="checkbox"/>
PB <input type="checkbox"/>

PB1000A Series Made to Order

Please contact SMC for detailed dimensions, specifications and lead times.



1 Liquid contact seals SF7000 (Perfluoropolyether rubber)

X16

PB101 3 A - [] 01 - [] - X16

Actuation	
Symbol	Actuation
3	Air operated

Thread type	
Symbol	Type
Nil	Rc
N	NPT
F	G

• Made to Order

X16 Liquid contact seals SF7000

• Option

Symbol	Option
Nil	None
B	With foot
C	With bracket which can be mounted to the back of the previous type
F	With bracket which can be mounted to the foot at the back of the previous type

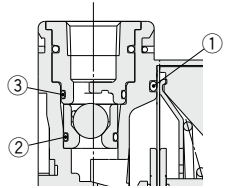

①-③: O-rings (SF7000)

Seal material of the liquid contact parts is changed to SF7000 (Perfluoropolyether rubber). Has better resistance against chemicals.

2 With bracket which is interchangeable with previous type

X47

Bracket which is interchangeable with previous PB1000 series is mounted.

PB101 3 A - [] 01 - C - X47

Actuation	
Symbol	Actuation
3	Air operated

Thread type	
Symbol	Type
Nil	Rc
N	NPT
F	G

• Made to Order

X47 With bracket which is interchangeable with previous type

• Interchangeable bracket type

Symbol	Interchangeable bracket type
C	With bracket which can be mounted to the back of the previous type
F	With bracket which can be mounted to the foot at the back of the previous type

With bracket which can be mounted to the back of the previous type: C

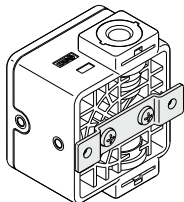
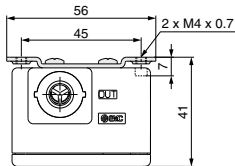

With bracket which can be mounted to the foot at the back of the previous type: F

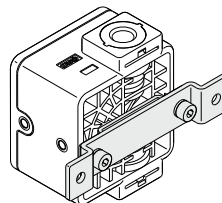
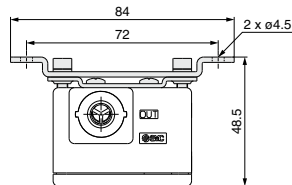

Process Pump (Diaphragm Pump)

Wetted Materials: Fluoropolymer

Air Operated (External switching type)

PB1313A Series



How to Order

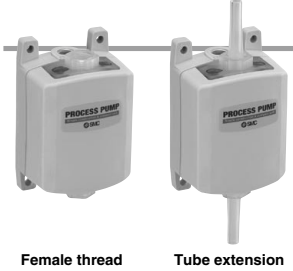

Female thread

Tube extension

Actuation	
Symbol	Actuation
3	Air operated

Diaphragm material	
Symbol	Material
1	PTFE

Port size		
Symbol	Main fluid connection size	Connection size in the air side
Female thread		
01		Rc1/8
N01		NPT1/8
F01		G1/8
Tube extension		
P07		Rc1/8
P07N	1/4" tube extension	NPT1/8
P07F		G1/8

Female thread/
Tube extension

PB13 1 3 A - P07

With nut*

PB13 1 3 A S -

* The pump with nut is recommended when SMC fitting, LQ series, is used.

Connection method	
Symbol	Connection method
S	With nut (Note)

(Note) Refer to page 590 for details of the connection of the nut.

Port size		
Symbol	Main fluid connection size	Connection size in the air side
With nut		
1S07		Rc1/8
1S07N	With LQ1 size 2 nut	NPT1/8
1S07F		G1/8
3S07		Rc1/8
3S07N	With LQ3 size 2 nut	NPT1/8
3S07F		G1/8



With nut (LQ1 fittings)

With nut (LQ3 fittings)

Specifications

Model		PB1313A
Actuation		Air operated
Port size	Main fluid suction/discharge port	Rc, NPT, G 1/8 female thread, 1/4" tube extension, With nut (LQ1/LQ3)
	Pilot air supply/exhaust port	Rc, NPT, G 1/8 female thread
Material	Body wetted parts	New PFA
	Diaphragm	PTFE
	Check valve	PTFE, New PFA
	Liquid contact seals	PTFE
Discharge ^{Note 1)}		8 to 1000 mL/min
Average discharge pressure		0 to 0.4 MPa
Pilot air pressure		0.2 to 0.5 MPa
Air consumption		15 L/min (ANR) or less
Suction head ^{Note 1)}		Up to 0.5 m
Noise		71 dB (A) or less
Withstand pressure		0.75 MPa
Diaphragm life (Reference)		50 million cycles
Fluid temperature		0 to 50°C (No freezing, heat cycle not applied)
Ambient temperature		0 to 50°C (No freezing, heat cycle not applied)
Recommended operating cycle		1 to 5 Hz
Pilot air solenoid valve recommended Cv value		0.2 ^{Note 2)}
Weight		0.3 kg
Mounting orientation		FLUID OUT port upside
Packaging		Double clean package
Maximum viscosity		100 mPa·s

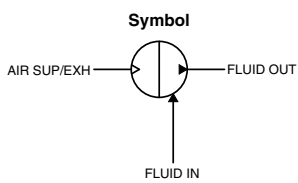

* Each of the values above are for normal temperatures and clear water.
 * For related products, refer to pages 622 to 623.
 * Faulty sealing of the check valves or accumulation of dust may cause operation to stop, so slurry processing is not available.
 * Refer to page 592 for maintenance parts.
 Note 1) The values given for discharge and suction head are for no piping. Values will depend on piping conditions.
 Note 2) With low operating cycles, even a valve with a small Cv value can be operated.



- PA
- PA(P)
- PAX
- PB
- PAF
- PA□
- PB

PB1313A Series

How to Order Fittings for Products with Nut (PB1313AS)

Fittings compatible for the process pump with nut/PB1313AS.

Product without nut (insert bushing), 1 piece nut removed, which is not necessary in cases when using the products with nut.

LQ1 fittings

LQ1 E 21 -SN

Fitting type

Nut (including insert bushing), 1 location removed

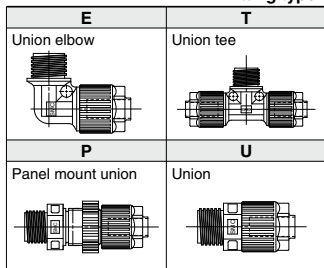

• Applicable tube size

Metric

Size	No.	Applicable tube size (mm)	Reducing*
2	1	6 x 4	○
2	2	4 x 3	●

* ○: Basic size ●: With reducer

Inch

Size	Symbol	Applicable tube (inch)	Reducing*
2	A	1/4" x 5/32"	○
2	B	3/16" x 1/8"	●
2	C	1/8" x 0.086"	○

* ○: Basic size ●: With reducer

Note) Check the IN/OUT side fitting size and fitting type for selecting the fitting.

LQ3 fittings

LQ3 E 2A -SN

Fitting type

Nut, 1 location removed

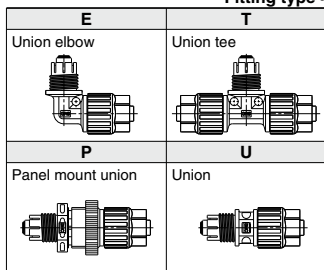

• Applicable tube size

Size	Symbol	Applicable tube size (inch)
2	A	1/4" x 5/32"

Note) Check the IN/OUT side fitting size and fitting type for selecting the fitting.

⚠ Caution

- For detailed specifications and Specific Product Precautions about fittings (LQ1, LQ3), refer to "Best Pneumatics No. 7."
- Refer to the pamphlet "High-Purity Fluoropolymer Fittings Hyper Fittings/LQ1, 2 series Work Procedure Instructions" (M-E05-1) or "High Purity Fluoropolymer Fittings Hyper Fittings/Flare Type LQ3 series Fitting Procedure" (M-E06-4) for connecting tube. (Downloadable from our website.)

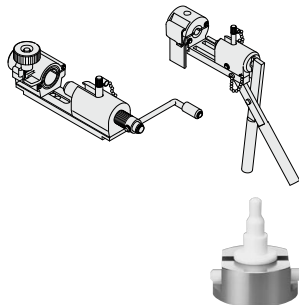

Ordering Example

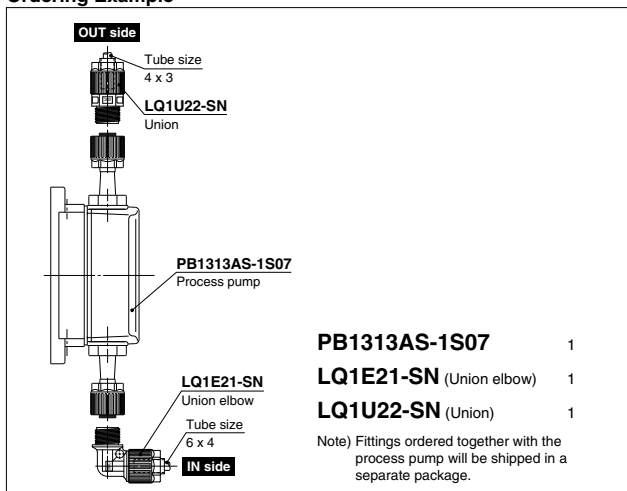

Flow Rate Characteristics: Air Operated (PB1313A)

Cycle (1 Hz)

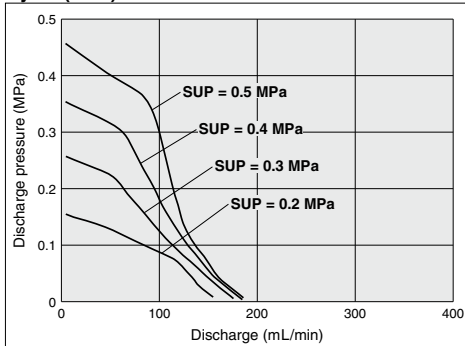

Cycle (5 Hz)

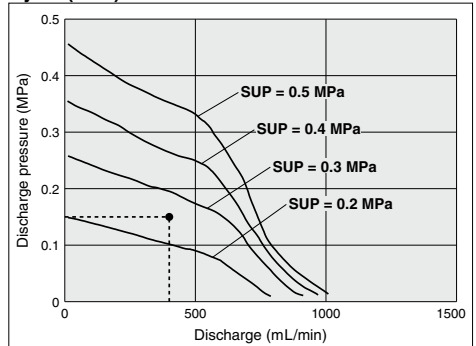

Air Consumption

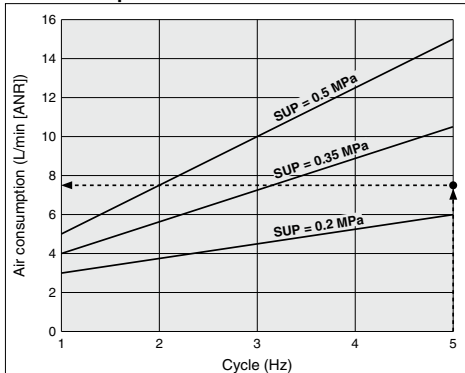

Viscosity Characteristics (Flow rate correction for viscous fluids)

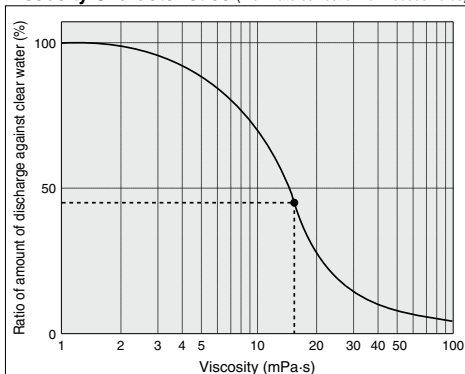

* Transfer is possible up to about 100 mPa·s.

Selection from Flow Rate Characteristic Graph

■ Required specification example

Find the pilot air pressure for a discharge rate of 400 mL/min and a discharge pressure of 0.15 MPa.

<The transferred fluid is clear water (viscosity 1 mPa·s, specific gravity of 1.0) and solenoid valve cycle is 5 Hz.>

* When the total pump head is required instead of the discharge pressure, a discharge pressure of 0.1 MPa corresponds to a total pump head of 10 m.

■ Selection procedure

1. First, mark the intersection point for a discharge rate of 400 mL/min and a discharge pressure of 0.15 MPa.
2. Find the pilot air pressure for the marked point. In this case, the point is between the discharge curves for 0.2 MPa and 0.3 MPa, and based on the proportional relationship to these lines, the pilot air pressure for this point is approximately 0.25 MPa.

Calculation of Air Consumption

Find the air consumption for operation with a 5 Hz switching cycle and pilot air pressure of 0.25 MPa from the air consumption graph.

■ Selection procedure

1. Look up from the 5 Hz switching cycle to find the intersection with SUP = 0.25 MPa.
2. From the point just found, draw a line to the Y-axis to find the air consumption. The result is approximately 7.5 L/min (ANR).

⚠ Caution

1. Flow rate characteristics are for clear water (viscosity of 1 mPa·s, specific gravity of 1.0).
2. The amount of discharge differs greatly depending on properties (viscosity, specific gravity) of the transferred fluid and operating conditions (pump head, transfer distance), etc.

Selection from Viscosity Characteristic Graph

■ Required specification example

Find the pilot air pressure and pilot air consumption for a discharge rate of 180 mL/min, discharge pressure of 0.15 MPa, and a viscosity of 15 mPa·s.

■ Selection procedure

1. First, find the ratio of the amount of discharge against clear water when viscosity is 15 mPa·s from the graph to the left. It is determined to be 45%.
2. Next, the viscosity of 15 mPa·s and the discharge rate of 180 mL/min in the required specification example are converted to the discharge rate for clear water. Since 45% of the amount of clear water discharge is equivalent to 180 mL/min in the required specifications, $180 \text{ mL/min} \div 0.45 = \text{approximately } 400 \text{ mL/min}$, indicating that a discharge rate of 400 mL/min is required for clear water.
3. Finally, find the pilot air pressure and pilot air consumption based on the flow rate characteristic graphs.

■ Relationship between the kinematic viscosity

Kinematic viscosity ν [m^2/s] = Viscosity μ [$\text{Pa}\cdot\text{s}$]/Density [kg/m^3]

$$\begin{aligned} \cdot 1 \text{ cP} &= 1 \text{ mPa}\cdot\text{s} = 10^{-3} \text{ Pa}\cdot\text{s} \\ \cdot 1 \text{ cSt} &= 1 \text{ mm}^2/\text{s} = 10^{-6} \text{ m}^2/\text{s} \end{aligned}$$

PA
PA(P)
PAX
PB
PAF
PA
PB

PB1313A Series

Working Principle: Air Operated

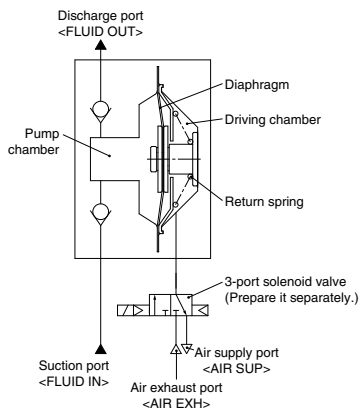

When air is supplied with the external 3-port solenoid valve turned ON (energized), air enters the driving chamber and the diaphragm moves to the left. Due to this movement, the fluid in the pump chamber passes through the upper check valve and is discharged to the discharge port <FLUID OUT>.

When the solenoid valve is turned OFF (de-energized), the air inside the driving chamber is evacuated to air exhaust port <AIR EXH>, and the diaphragm is moved to the right by the return force of the return spring. Due to this movement, the fluid on the suction port <FLUID IN> passes through the check valve and is sucked into the pump chamber.

The fluid is transferred continuously by suction and discharge in turn by repeating ON/OFF of the built-in solenoid valve.

Maintenance Parts

⚠ Basically, it is not recommended to disassemble the process pump. However, if this is necessary, be sure to follow the instructions in the maintenance procedure.

● When carrying out this work, wear appropriate protective equipment.

PB1313A Series

Description	PB1313A series
Check valve kit	KT-PB1A-501
Diaphragm kit	KT-PB1A-502

Piping and Operation: Air Operated

Piping diagram

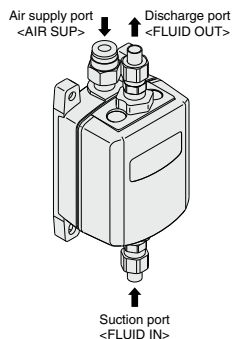

⚠ Caution

Be sure that the discharge port <FLUID OUT> is on top when the pump is mounted. Supply clean air that has passed through a mist separator etc., to the air supply port <AIR SUP>. When air needs additional purification, use a mist separator (AM series) and a micro mist separator (AMD series) together. Maintain the proper tightening torque for fittings or mounting bolts. Looseness can cause problems such as liquid or air leakage, while over-tightening can cause damage to threads or parts, etc.

Operation

1. Connect air piping to the air supply port <AIR SUP>, and connect piping for transferred fluid to the suction port <FLUID IN> and the discharge port <FLUID OUT>.
2. Set the pilot air pressure within the range of 0.2 to 0.5 MPa. If air is supplied or discharged intermittently using a 3-port solenoid valve, the pump operates, then after a short time the fluid flows from suction port <FLUID IN> to the discharge port <FLUID OUT>. The pump performs suction with its own power even without priming. Idle run of the pump shall be 3 minutes or less for the intake of the liquid.
3. To stop the pump, stop the 3-port solenoid valve, and be sure to discharge air from the pump. Although the pump can be stopped by closing the throttle installed in the discharge side, avoid stopping operation for a long time. If the valve opens/closes suddenly, surge is generated, shortening the pump life. When the tank for fluid suction side is empty, stop operating the pump immediately.

Recommended Valve (Air operated)

PB1313A	SYJ5□4
---------	--------

Circuit example/Air operated

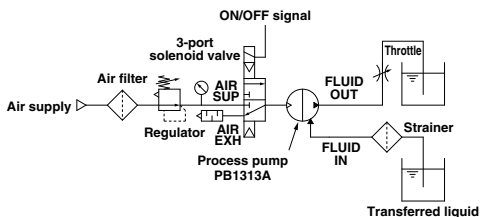

Dimensions

Air Operated PB1313A

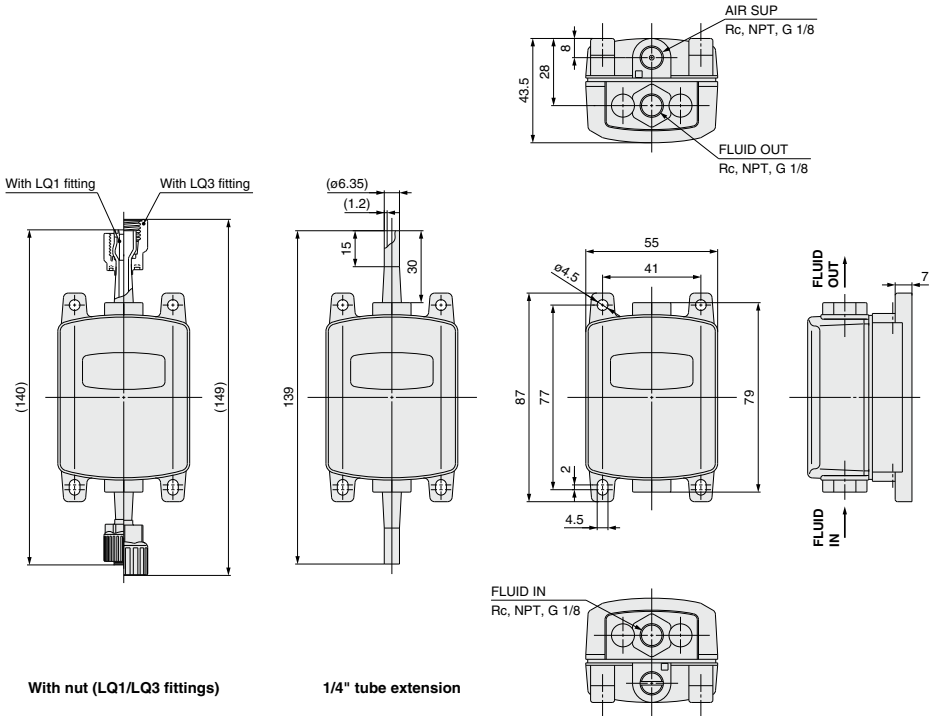

PA
PA(P)
PAX
PB
PAF
PA <input type="checkbox"/>
PB <input type="checkbox"/>

⚠ Caution

1. Check the mounting orientation of the product.

Mount the product vertically so that the <FLUID OUT> port faces upward.

Also, secure all specified mounting positions when using the product. If the propagation of the vibration of the pump is not acceptable, insert vibro-isolating rubber when mounting.

2. Open the sealed package inside a clean room.

Products specified for clean room (PB1313A) are sealed and double packaged inside a clean room. We recommend that the inner package should be opened inside a clean room or clean environment.