

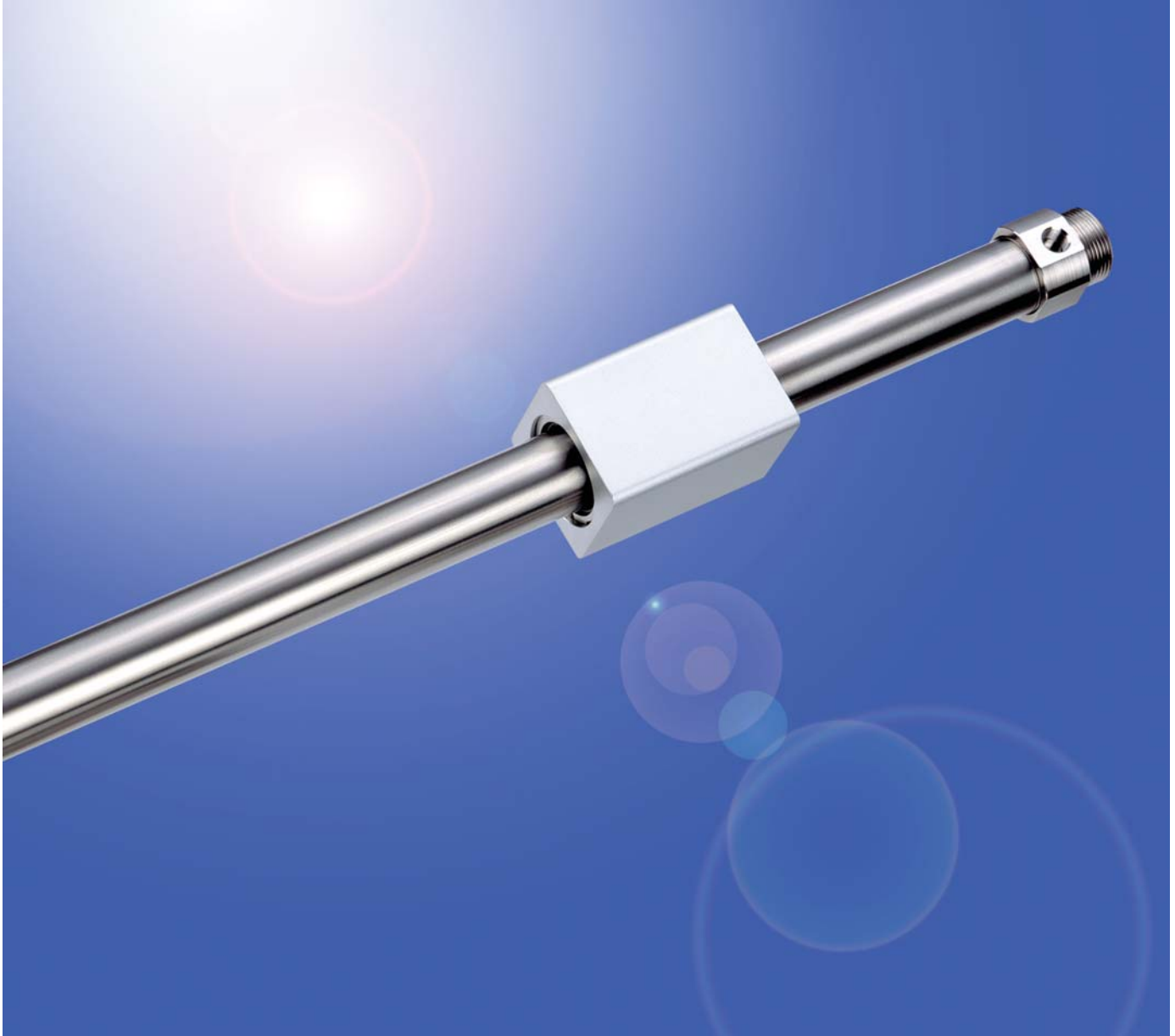

Magnetically Coupled Rodless Cylinder



Upgraded version of space saving magnetically coupled rodless cylinder

Basic type
Series NCY3B

Series NCY3B

Improved durability

Improved bearing performance

A 70% longer wear ring length achieving an improvement in bearing performance compared to the NCY2B.

Improved lubrication by using a lubretainer

A special resin lubretainer is installed on the dust seal to achieve ideal lubrication on the external surface of the cylinder tube.

Basic type *Series NCY3B*



Mounting dimensions are identical to those of the NCY2B series.

The mounting dimensions (in the drawing below) are identical with those of existing NCY2B series, allowing easy replacement.

(* For bore size of $\phi 6(1/4")$, the mounting is not directly interchangeable with the NCY2B series because the piping port has been reduced to a M3 size.)

Series NCY3B

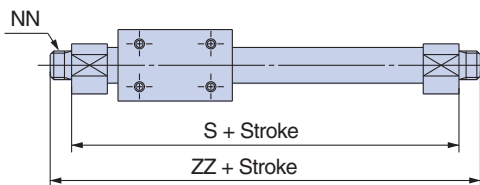

Series NCY3B6

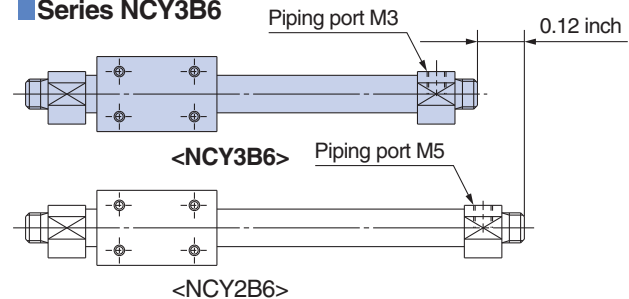

■ Nine bore sizes ranging from 6 mm (1/4") to 63 mm (2-1/2") are available.

■ Broad range of made-to-order options.

Note) When ordering a product that is interchangeable with a NCY2B6, add the suffix, X1468 to the end of the NCY3B6 model number (Refer to page 12).

Upgraded version of space saving magnetically rodless cylinder!

Reduction of sliding resistance

Minimum operating pressure reduced by 30%

By using a lubretainer, the minimum operating pressure is reduced by 30%.
(NCY3B40 compared with the NCY2B40)

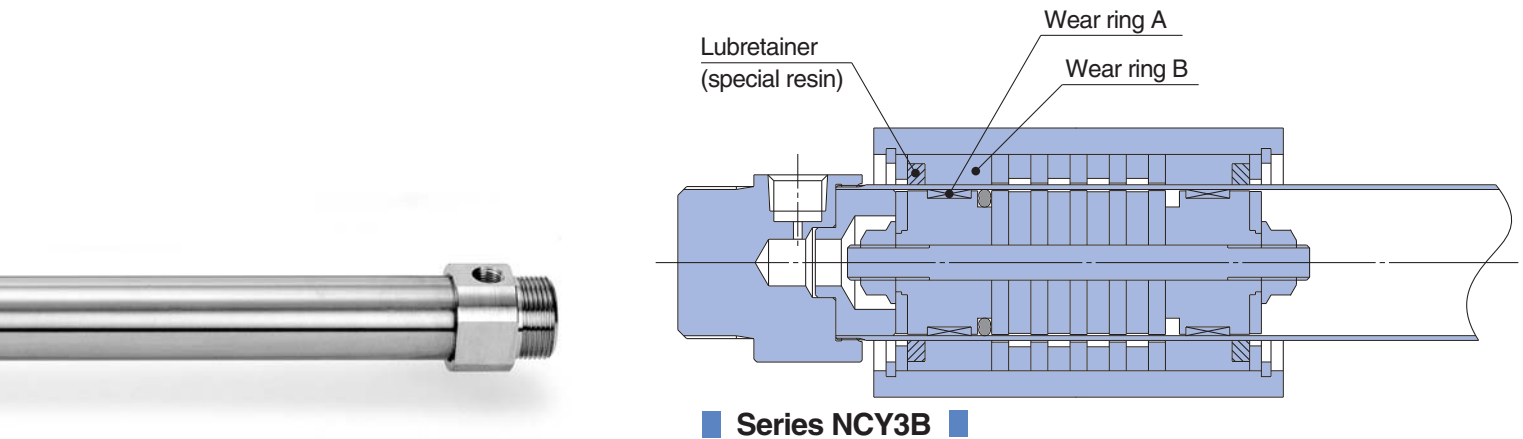

Lightweight

The body weight has been reduced by approximately 10% by eliminating unnecessary body weight and by reducing the outer diameter of the cylinder tube. (Compared with previous $\phi 50(2\text{'})$ and $\phi 63(2\text{-}1/2\text{'})$ models)

Series variations

Series	Bore size	Standard stroke (inch)										Max. available stroke (inch)	Made to Order				
		2	3	4	5	6	8	10	15	20	25		30	40			
NCY3B	$\phi 6$ (1/4")	●	●	●	●	●	●	●							12	Heat resistant specification	(XB6)
	$\phi 10$ (3/8")	●	●	●	●	●	●	●							20	Low speed specification (0.6 to 2.0 inch/s)	(XB9)
	$\phi 15$ (5/8")				●	●	●	●	●	●	●	●	●		40	Low speed specification (0.3 to 2.0 inch/s)	(XB13)
	$\phi 20$ (3/4")					●	●	●	●	●	●	●	●	●	60	Air Hydro specification	(X116)
	$\phi 25$ (1")				●	●	●	●	●	●	●	●	●	●	80	Axial ports	(X132)
	$\phi 32$ (1-1/4")				●	●	●	●	●	●	●	●	●	●	80	High speed specification	(X160)
	$\phi 40$ (1-1/2")				●	●	●	●	●	●	●	●	●	●	80	Helical insert thread specification	(X168)
	$\phi 50$ (2")				●	●	●	●	●	●	●	●	●	●	80	Added mounting tap positions for slider	(X206)
	$\phi 63$ (2-1/2")				●	●	●	●	●	●	●	●	●	●	80	Oil-free exterior specification	(X210)
																	Outside of cylinder tube with hard chrome plating
																Oil-free exterior specification (with dust seal)	(X324)
																Interchangeable specification with NCY2B6	(X1468)
																With magnetic shielding plate	(XC24)
																With floating joint	(XC57)

Note) The ● mark indicates the available combination of bore size and standard stroke.

Availability of made-to-order products varies with the series and the bore size. For more information, please refer to page 9.

Series NCY3B

Model Selection Criteria

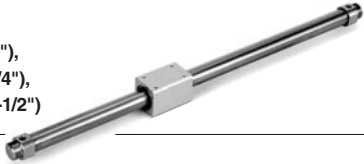
Model selection point	Recommended cylinder	
	Appearance	Features
<ul style="list-style-type: none"> When used with many different types of guides. When a long stroke is necessary. 	Non-integrated guide type Series NCY3B Size: $\phi 6(1/4")$, $\phi 10(3/8")$, $\phi 15(5/8")$, $\phi 20(3/4")$, $\phi 25(1")$, $\phi 32(1-1/4")$, $\phi 40(1-1/2")$, $\phi 50(2")$, $\phi 63(2-1/2")$	 A long stroke is possible.

Model Selection

E: Kinetic energy of load (J)

$$E = \frac{(W + W_B)}{2 \times 2.2} \times \left(\frac{V}{39.4} \right)^2$$

Es: Allowable kinetic energy for intermediate stop using an air pressure circuit (J)

F_n: Allowable driving force (lbf)

Ps: Operating pressure limit for intermediate stop using an external stopper, etc. (PSI)

P_v: Maximum operating pressure for vertical operation (PSI)

W_{Bmax}: Maximum load weight (lbf) when loaded directly on the body

W_v: Allowable load weight for vertical operation (lbf)

ϕD : Bore size (inch)

Operating conditions

- W: Load weight (lbf)
- W_B: Connection bracket weight (lbf)
- μ : Guide's coefficient of friction
- L_o: Distance from cylinder shaft center to workpiece point of application (inch)
- L₁: Distance from cylinder shaft center to connection fitting, etc.
- Switches
- P: Operating pressure (PSI)
- V: Speed (inch/s)
- Stroke (inch)
- Mode of operation (horizontal, inclined, vertical)

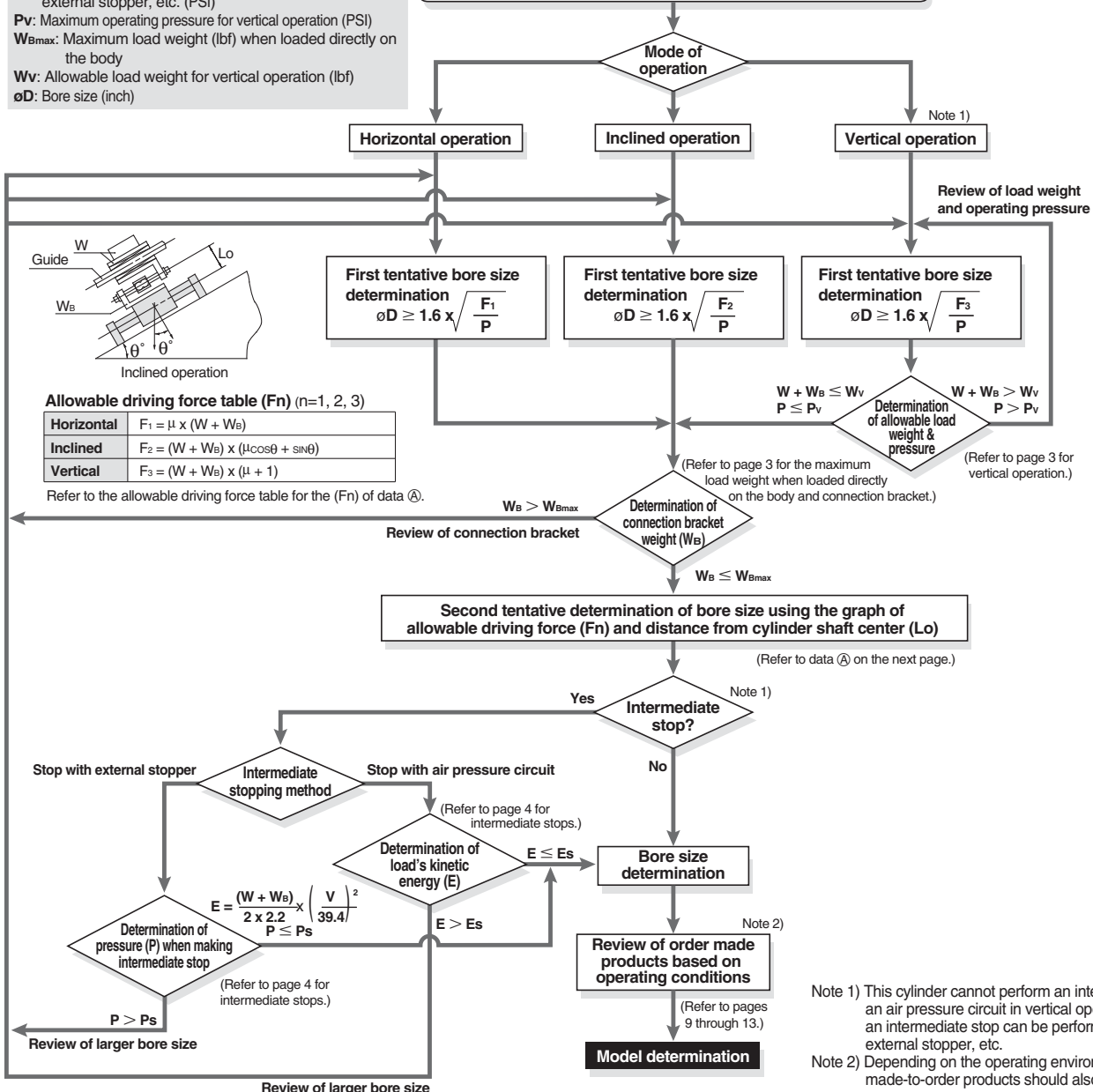

Note 1) This cylinder cannot perform an intermediate stop using an air pressure circuit in vertical operation. In this case, an intermediate stop can be performed only by using an external stopper, etc.

Note 2) Depending on the operating environment, etc., made-to-order products should also be reviewed.

Series NCY3B

Model Selection

Precautions on Design 1

Selection Procedure

Selection procedure

1. Find the drive resisting force F_n (lbf) when moving the load horizontally.
2. Find the distance L_o (inch) from the point of the load where driving force is applied, to the center of the cylinder shaft.
3. Select the bore size from L_o and F_n based on data ①.

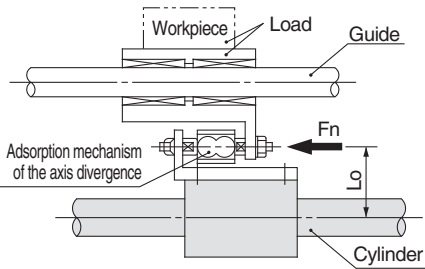

Selection example

Given a load drive resisting force of $F_n = 20$ (lbf) and a distance from the cylinder shaft center to the load application point of $L_o = 3$ inch find the intersection point by extending upward from the horizontal axis of data ① where the distance from the shaft center is 3 inch, and then extending to the side, find the allowable driving force on the vertical axis.

Models suitable in satisfying the requirement of 20 (lbf) are **NCY3B32** or **NCY3B40**.

* The point of the distance L_o from the center of the cylinder shaft indicates the moment point of the cylinder and the load section.

<Data ①: Distance from cylinder shaft center — Allowable driving capacity>

NCY3B6

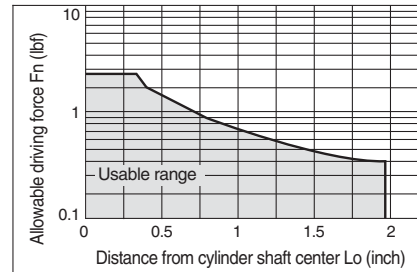

NCY3B32

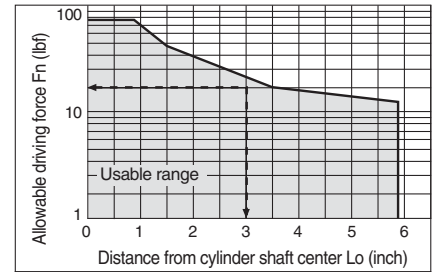

NCY3B10

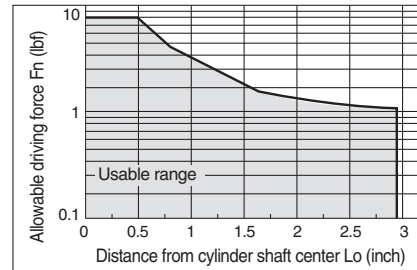

NCY3B40

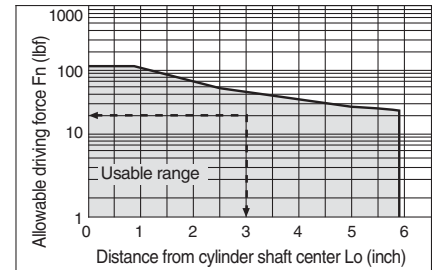

NCY3B15

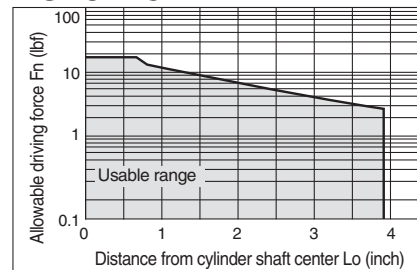

NCY3B50

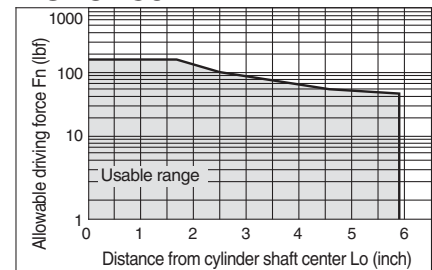

NCY3B20

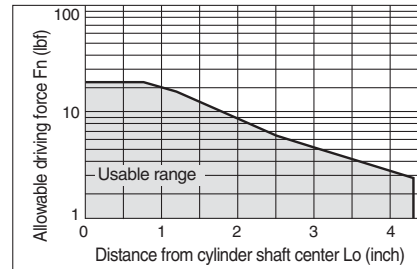

NCY3B63

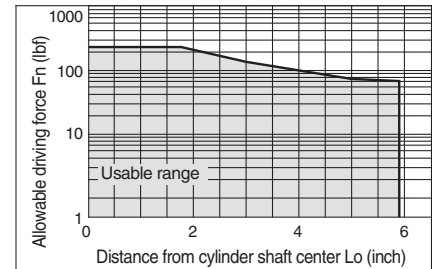

NCY3B25

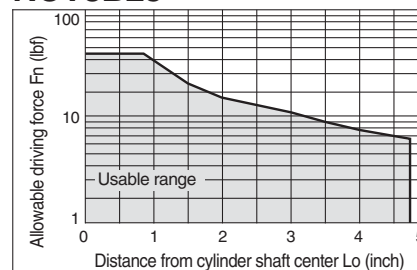

Series NCY3B

Model Selection

Precautions on Design 2

Cylinder Dead Weight Deflection

When the cylinder is mounted horizontally, deflection appears due to its own weight as shown in the data, and the longer the stroke is, the greater the amount of variation in the shaft center. Therefore, a connection method should be considered which can assimilate this deflection.

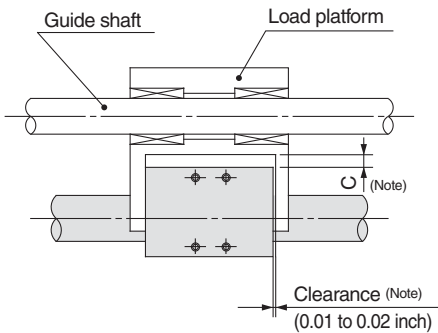

The above clearance amount is a reference value.

Note 1) According to the dead weight deflection in the figure on the right, provide clearance so that the cylinder does not touch the mounting surface or the load, etc., and is able to operate smoothly within the minimum operating pressure range for a full stroke. For more information, refer to instruction manual.

Note 2) Adjust the clearance value by referring to the dead weight deflection as shown in the table on the right.

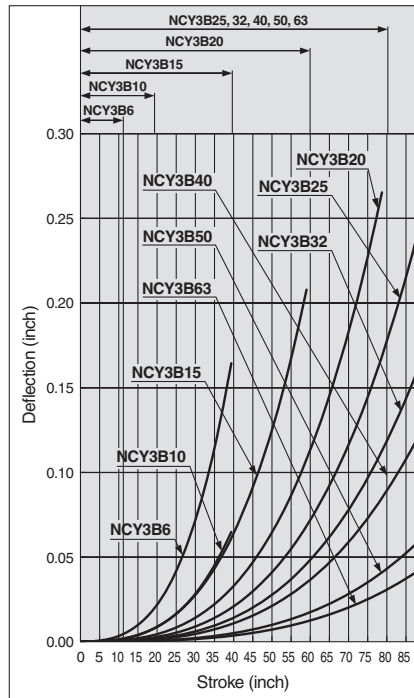
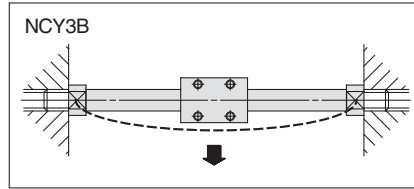

* The above deflection data represent values at the time when the external sliding part moves to the middle of the stroke.

Vertical Operation

The load should be guided by a ball type bearing (linear guide, etc.). If a slide bearing is used, sliding resistance increases due to the load weight and load moment, which can cause malfunction.

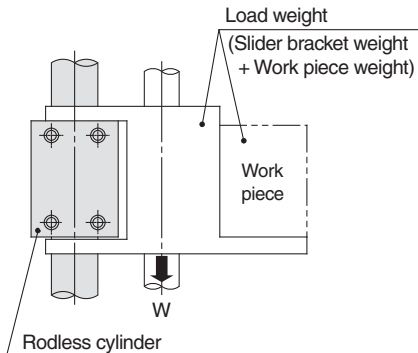

Model	Allowable load weight W_v (lbf)	Max. operating pressure P_v (PSI)
NCY3B6	2.2	79.8
NCY3B10	6.0	79.8
NCY3B15	15.4	94.3
NCY3B20	24.3	94.3
NCY3B25	40.8	94.3
NCY3B32	66.1	94.3
NCY3B40	103.6	94.3
NCY3B50	165.3	94.3
NCY3B63	253.5	94.3

* Use caution, as there is a danger of decoupling the piston if operated above the maximum operating pressure.

Max. Weight of Connection Bracket to the Body

The NCY3B series is guided by an external axis (such as a linear guide) without directly mounting the load. When designing a metal bracket to connect the load, see to it that its weight will not exceed the value in the table below.

Max. Connection Bracket Weight

Model	Max. connection bracket weight W_{Bmax} (oz)
NCY3B6	7.1
NCY3B10	14.1
NCY3B15	35.3
NCY3B20	38.8
NCY3B25	42.3
NCY3B32	52.9
NCY3B40	70.5
NCY3B50	88.2
NCY3B63	105.8

Please consult with SMC in case a bracket with weight exceeding the above value is to be mounted.

Precautions on Design 3

Intermediate Stop

(1) Intermediate stopping of a load with an external stopper, etc.

When stopping a load in mid-stroke using an external stopper, etc., operate within the operating pressure limits shown in the table below. Use caution, as operation at a pressure exceeding these limits can result in decoupling the piston.

Model	Operating pressure limit for intermediate stop Ps (PSI)
NCY3B6	79.8
NCY3B10	79.8
NCY3B15	94.3
NCY3B20	94.3
NCY3B25	94.3
NCY3B32	94.3
NCY3B40	94.3
NCY3B50	94.3
NCY3B63	94.3

(2) Intermediate stopping of a load with an air pressure circuit

When performing an intermediate stop of a load using an air pressure circuit, operate at or below the kinetic energy shown in the table below. Use caution, as operation when exceeding the allowable value can result in decoupling the piston.

(Reference values)

Model	Allowable kinetic energy for intermediate stop Es (J)
NCY3B6	0.007
NCY3B10	0.03
NCY3B15	0.13
NCY3B20	0.24
NCY3B25	0.45
NCY3B32	0.88
NCY3B40	1.53
NCY3B50	3.12
NCY3B63	5.07

Stroke End Stopping Method

When stopping a load having a large inertial force at the stroke end, tilting of the body and damage to the bearings and cylinder tube may occur. (Refer to the left hand drawing below.) As shown in the right hand drawing below, a shock absorber should be used together with the stopper, and thrust should also be transmitted from the center of the body so that tilting will not occur.

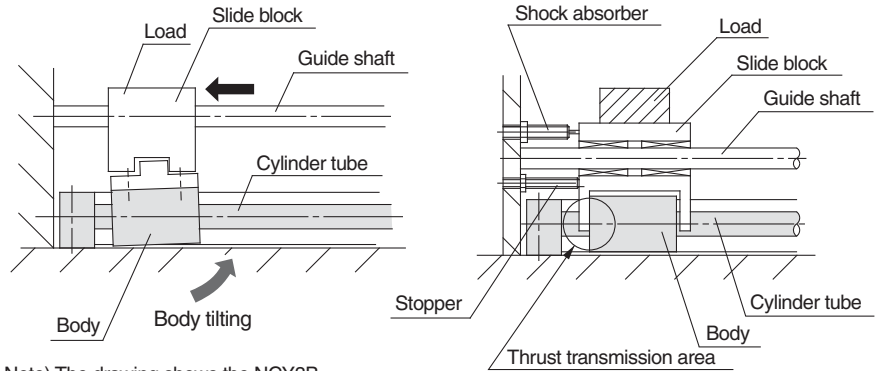

Note) The drawing shows the NCY3B.

Magnetically Coupled Rodless Cylinder Basic Type

Series **NCY3B**

ø6(1/4"), ø10(3/8"), ø15(5/8"), ø20(3/4"), ø25(1"), ø32(1-1/4"), ø40(1-1/2"), ø50(2"), ø63(2-1/2")

How to Order

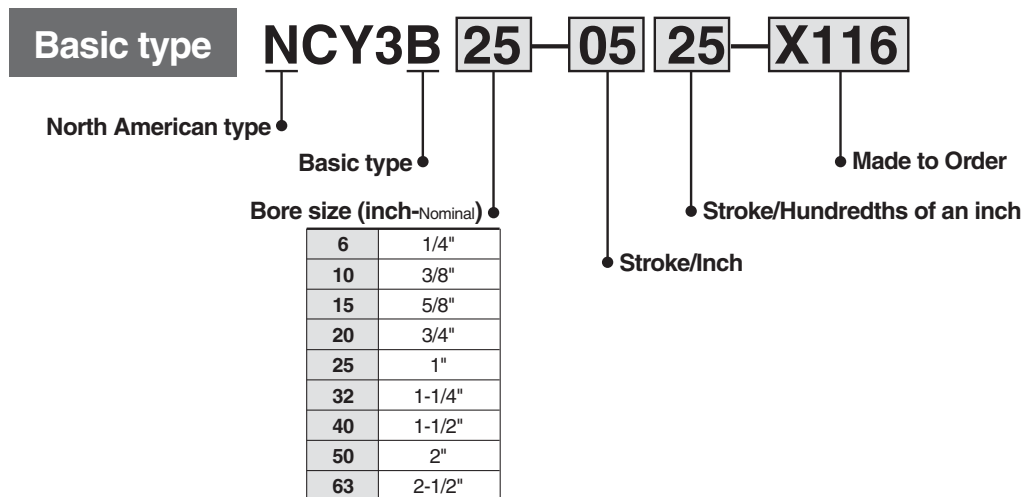

Standard Stroke

Bore size		Standard stroke (inch)	Max. stroke (inch)
(mm)	(inch-Nominal)		
6	1/4"	2, 3, 4, 5, 6, 8, 10	12
10	3/8"	2, 3, 4, 5, 6, 8, 10	20
15	5/8"	5, 10, 15, 20, 25, 30	40
20	3/4"	5, 10, 15, 20, 25, 30, 40	60
25	1"	5, 10, 15, 20, 25, 30, 40	80
32	1-1/4"	5, 10, 15, 20, 25, 30, 40	80
40	1-1/2"	5, 10, 15, 20, 25, 30, 40	80
50	2"	5, 10, 15, 20, 25, 30, 40	80
63	2-1/2"	5, 10, 15, 20, 25, 30, 40	80

Note) The longer the stroke, the larger the amount of deflection in a cylinder tube. Pay attention to the mounting bracket and clearance value.

Magnetic Holding Force (lbf)

Bore size	(mm)	6	10	15	20	25	32	40	50	63
	(inch-Nominal)	1/4"	3/8"	5/8"	3/4"	1"	1-1/4"	1-1/2"	2"	2-1/2"
Magnetic holding force		4.41	12.12	30.80	51.93	81.60	132.18	207.27	330.68	507.15

Specifications



JIS symbol

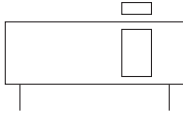

Made to Order
(Refer to pages 9 for details.)

Symbol	Specifications
XB6	Heat resistant specification
XB9	Low speed specification (0.6 to 2.0 inch/s)
XB13	Low speed specification (0.3 to 2.0 inch/s)
X116	Air Hydro specification
X132	Axial ports
X160	High speed specification
X168	Helical insert thread specification
X206	Added mounting tap positions for slider
X210	Oil-free exterior specification
X322	Outside of cylinder tube with hard chrome plating
X324	Oil-free exterior specification (with dust seal)
X1468	Interchangeable specification with NCY2B6
XC24	With magnetic shielding plate
XC57	With floating joint

Fluid	Air
Proof pressure	152 PSI (1.05 MPa)
Max. operating pressure	101 PSI (0.7MPa)
Min. operating pressure	Refer to the minimum operating pressure table.
Ambient and fluid temperature	14 to 140°F (-10 to 60°C) (No freezing)
Piston speed	2 to 20 inch/s (50 to 500 mm/s)
Cushion	Rubber bumper on both ends
Lubrication	Non-lube
Stroke length tolerance	0 to 10 st (inch): 0 to 0.04 inch (1.0 mm) 10.01 to 40 st (inch): 0 to 0.06 inch (1.4 mm) 40.01 st (inch): 0 to 0.07 inch (1.8 mm)
Mounting orientation	Horizontal, Inclined, Vertical ^{Note}
Mounting nut (2 pcs.)	Standard equipment (accessory)

Note) When vertically mounting, it is impossible to perform an intermediate stop by pneumatic circuit.

Theoretical Cylinder Thrust **⚠ Caution** When calculating the actual thrust, design should consider the minimum actuating pressure.

ø6, ø10

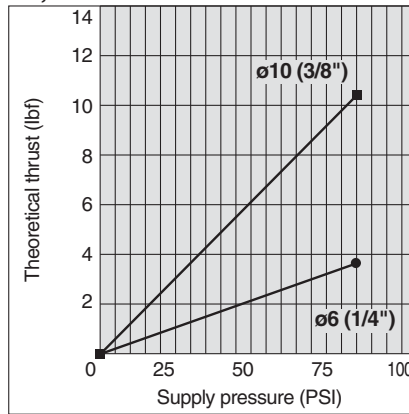

ø15, ø20, ø25, ø32, ø40

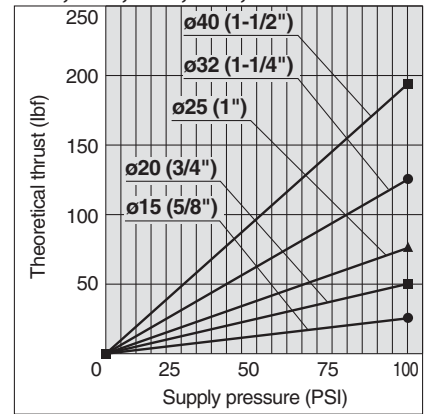

Minimum Operating Pressure

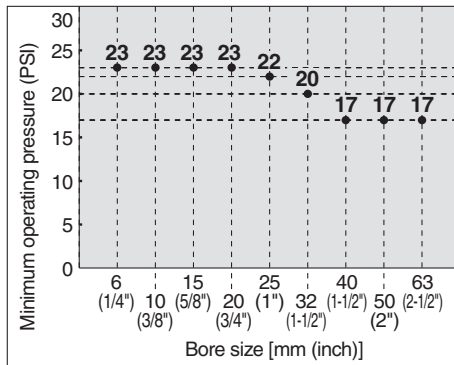

Note) Values show when the cylinder is driving without load.

ø50, ø60

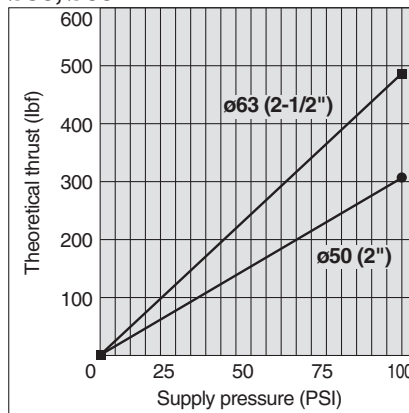

Main Material

Description	Material	Note
Head cover	Aluminum alloy	Electroless nickel plated
Cylinder tube	Stainless steel	
Body	Aluminum alloy	Hard anodized
Magnet	Rare earth magnet	

Note) For details, refer to the construction drawings on page 7.

Weight

Bore size	Unit: oz									
	(mm)	6	10	15	20	25	32	40	50	63
(inch-nominal)	1/4"	3/8"	5/8"	3/4"	1"	1-1/4"	1-1/2"	2"	2-1/2"	
Basic weight (at 0 st)	1.83	2.82	9.70	12.38	23.70	45.40	73.02	112.88	186.95	
Additional weight per 1 inch stroke	0.07	0.25	0.27	0.36	0.41	0.59	0.72	1.38	1.72	

Calculation method/Example: NCY3B32-2000

$$\left. \begin{array}{l}
 \text{Basic weight} \dots\dots\dots 45.40 \text{ (oz)} \\
 \text{Additional weight} \dots\dots 0.59 \text{ (oz/inch)} \\
 \text{Cylinder stroke} \dots\dots\dots 20 \text{ (inch)}
 \end{array} \right\} 45.40 + (0.59 \times 20) = 57.20 \text{ (oz)}$$



Series NCY3B

Construction

Basic type

NCY3B6

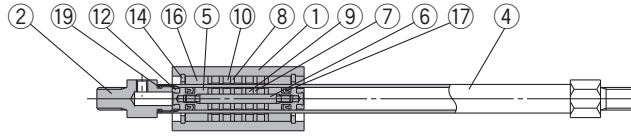

NCY3B10, 15

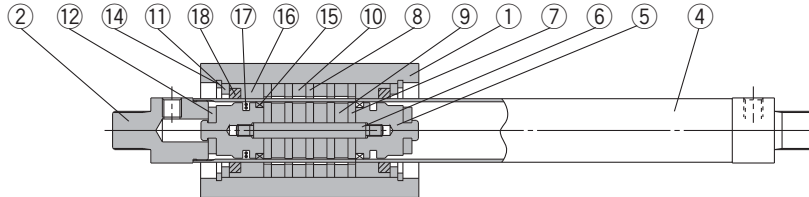
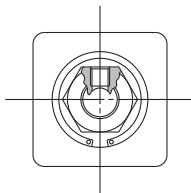

* The above drawing is $\phi 15$. (3 magnets are used in $\phi 10$.)

NCY3B20 to 40

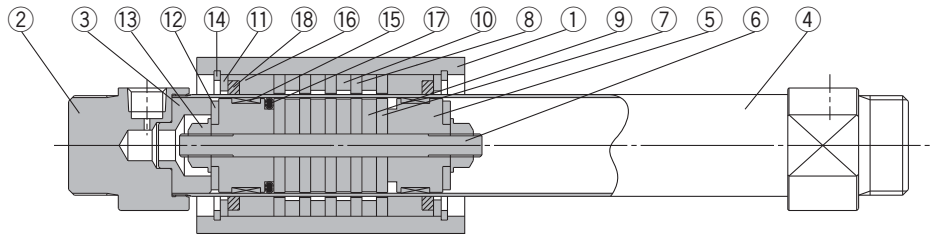
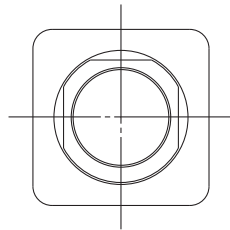

NCY3B50, 63

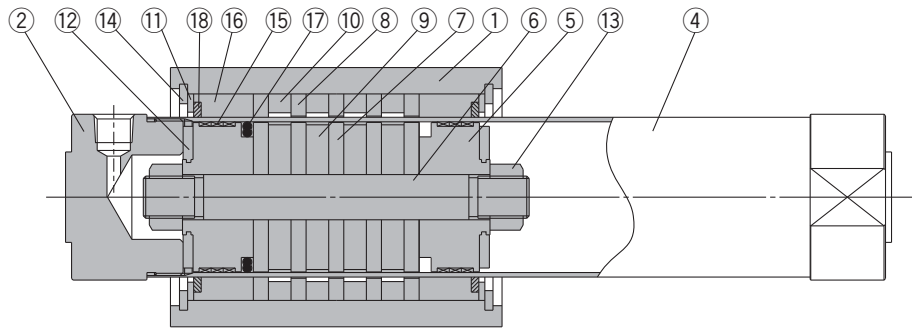
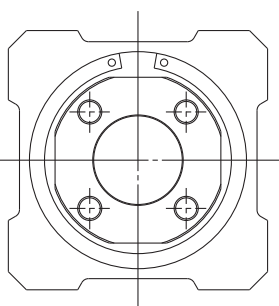

Component Parts

No.	Description	Material	Note
1	Body	Aluminum alloy	Hard anodized
2	Head cover	$\phi 6, \phi 10$ Brass	Electroless Ni plated
		$\phi 15$ to $\phi 63$ Aluminum alloy	
3	End collar	Aluminum alloy	$\phi 20$ to $\phi 40$ only
4	Cylinder tube	Stainless steel	
5	Piston	$\phi 6$ to $\phi 15$ Brass	$\phi 6$ to $\phi 15$ Electroless Ni plated
		$\phi 20$ to $\phi 63$ Aluminum alloy	$\phi 20$ to $\phi 63$ Chromated
6	Shaft	Stainless steel	
7	Piston side yoke	Rolled steel	Zinc chromated
8	External slider side yoke	Rolled steel	Zinc chromated
9	Magnet A	Rare earth magnet	
10	Magnet B	Rare earth magnet	
11	Spacer	Aluminum alloy	$\phi 6$: not available
12	Damper	Urethane rubber	
13	Piston nut	Carbon steel	$\phi 6$ to $\phi 15$: not available
14	C type snap ring for hole	Carbon tool steel	Nickel plated
15	Wear ring A	Special resin	
16	Wear ring B	Special resin	
17	Piston seal	NBR	
18	Lubretainer	Special resin	$\phi 6$: not available
19	Cylinder tube gasket	NBR	$\phi 6, \phi 10$ only

Replacement Parts: Seal Kit

Bore size (mm)	Bore size (inch-nominal)	Kit no.	Contents
10	3/8"	CY3B10-PS	Numbers 15, 16, 17, 18, 19 above
15	5/8"	CY3B15-PS	Numbers 15, 16, 17, 18 above
20	3/4"	CY3B20-PS	
25	1"	CY3B25-PS	
32	1-1/4"	CY3B32-PS	
40	1-1/2"	CY3B40-PS	
50	2"	CY3B50-PS	
63	2-1/2"	CY3B63-PS	

Note 1) Seal kits are sets consisting of numbers 15 through 19. Order using the kit number corresponding to each bore size.

Note 2) Adhesives are applied to the secured portion of the head cover and the cylinder tube. For bore sizes of more than $\phi 32(1-1/4")$ of the cylinder removing the head cover can be difficult.

Dimensions

Basic type

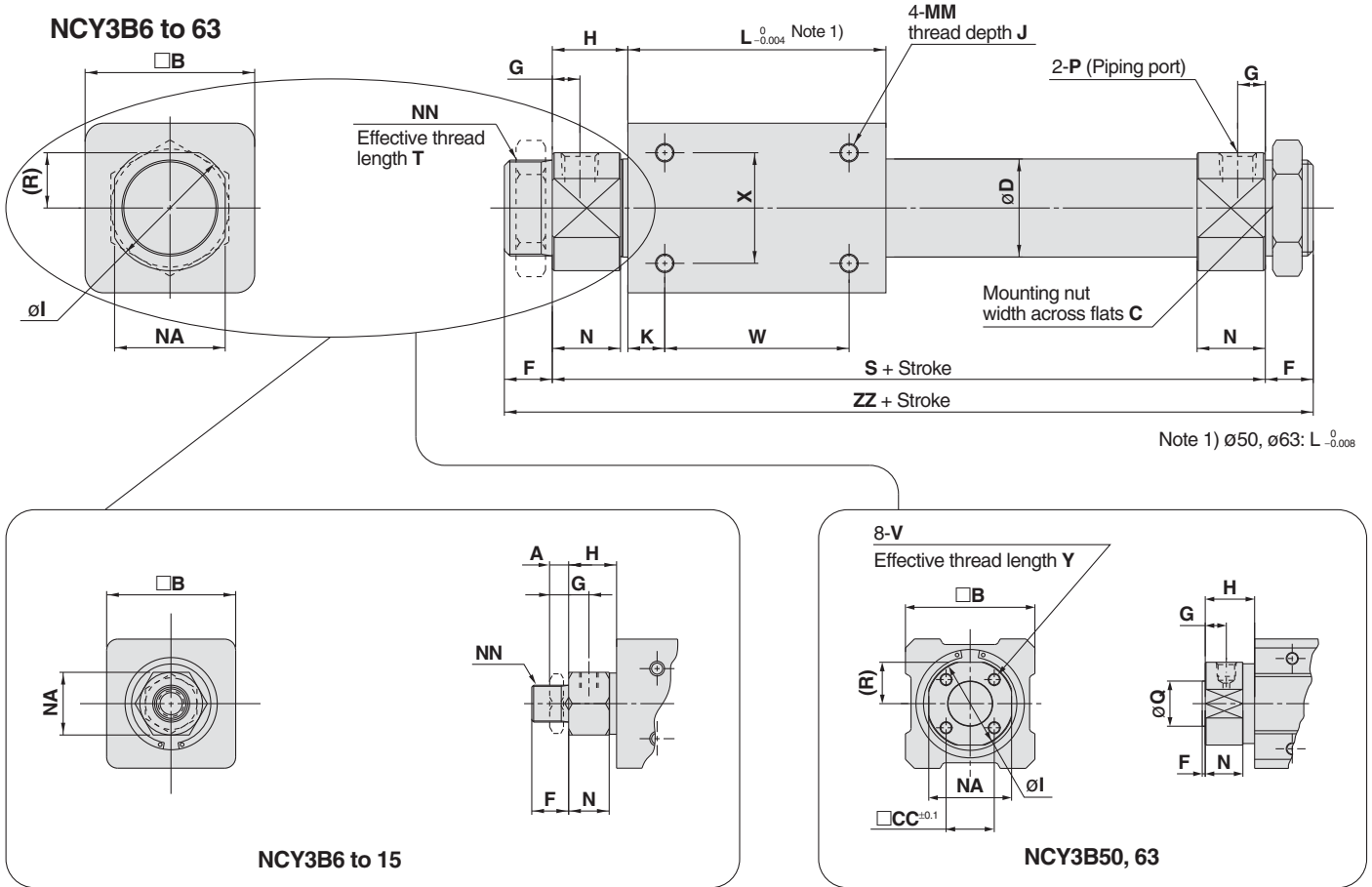

Model	Symbol	A	B	C	CC	D	F	G	H	I	J	K	L	MM	N	NA	NN	P
NCY3B6		0.16	0.67	0.44*	—	0.30	0.31*	0.20	0.53*	—	0.16	0.19	1.38	5-40UNC	0.37*	0.39*	1/4-28UNF*	M3 x 0.5 *
NCY3B10		0.12	0.98	0.55	—	0.47	0.37	0.20	0.50	—	0.18	0.19	1.50	5-40UNC	0.44	0.55	3/8-24UNF	10-32UNF
NCY3B15		0.12	1.38	0.55	—	0.65*	0.37	0.21	0.50	—	0.24	0.37	2.24	8-32UNC	0.43	0.67	3/8-24UNF	10-32UNF
NCY3B20		0.38	1.42	0.94	—	0.85*	0.51	0.30*	0.79	1.10	0.24	0.31	2.60	8-32UNC	0.71*	0.94	5/8-18UNF	NPT1/8
NCY3B25		0.31	1.81	1.22	—	1.04*	0.50	0.30*	0.81	1.34	0.31	0.38	2.76	10-32UNF	0.73*	1.18	1-12UNF	NPT1/8
NCY3B32		0.31	2.36	1.22	—	1.32*	0.63	0.31*	0.87	1.58	0.31	0.51	3.15	1/4-28UNF	0.79*	1.42	1-12UNF	NPT1/8
NCY3B40		0.43	2.76	1.61	—	1.64*	0.63	0.41*	1.13	1.97	0.39	0.56	3.62	1/4-28UNF	1.00*	1.81	1-1/4-12UNF	NPT1/4
NCY3B50		—	3.39	—	1.26	2.06*	0.08	0.55	1.25	2.28*	0.47	1.00	4.50	5/16-24UNF	1.02	2.17	—	NPT1/4
NCY3B63		—	3.94	—	1.50	2.57*	0.08	0.55	1.25	2.83*	0.47	1.00	5.00	5/16-24UNF	1.02	2.72	—	NPT1/4

Model	Symbol	Q	R	S	T	V	W	X	Y	ZZ
NCY3B6		—	—	2.44*	0.26	—	1.00	0.39	—	3.07*
NCY3B10		—	—	2.50	0.30	—	1.13	0.63	—	3.24
NCY3B15		—	—	3.25	0.30	—	1.50	0.75	—	3.99
NCY3B20		—	0.47*	4.17	0.39	—	2.00	1.00	—	5.19
NCY3B25		—	0.59*	4.38	0.39	—	2.00	1.25	—	5.38
NCY3B32		—	0.71*	4.88	0.51	—	2.13	1.63	—	6.14
NCY3B40		—	0.91*	5.88	0.51	—	2.50	1.63	—	7.14
NCY3B50		1.18	1.08*	7.00	—	5/16-24UNF	2.50	2.25	0.63	7.16
NCY3B63		1.26	1.36*	7.50	—	3/8-24UNF	3.00	2.75	0.63	7.66

Note 1) The asterisk denotes the dimensions which are different from the NCY2B series.
Note 2) When installing cylinder, a mounting bracket may be used.

Mounting Nut/Included in the package (2 pcs).

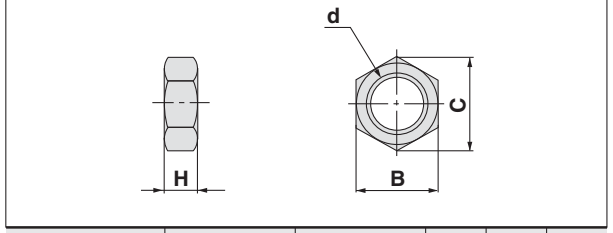

Applicable model	Part no.	d	H	B	C
NCY3B6	JM-025	1/4-28UNF	0.16	0.44	0.51
NCY3B10, 15	NSNJ-015	3/8-24UNF	0.12	0.55	0.64
NCY3B20	JM-08	5/8-18UNF	0.38	0.94	1.09
NCY3B25, 32	NSN-03	1-12UNF	0.31	1.22	1.41
NCY3B40	NSN-04	1-1/4-12UNF	0.43	1.61	1.86

Note) Not available for ø50 and ø63.

Series **NCY3B**

Made to Order

Please contact SMC for detailed specifications, lead times and prices.

Symbol	Contents	Model	Bore size (mm/inch-nominal)									
			(1/4") 6	(3/8") 10	(5/8") 15	(3/4") 20	(1") 25	(1-1/4") 32	(1-1/2") 40	(2") 50	(2-1/2") 63	
XB6	Heat resistant cylinder (150°C (302°F) specification)	NCY3B	●	●	●	●	●	●	●	●	●	●
XB13 <small>Note 1)</small>	Low speed cylinder (0.3 to 2.0 inch/s)	NCY3B	●	●	●	●	●	●	●	●	●	●
X116	Hydro specification	NCY3B					●	●	●	●	●	●
X132	Axial ports	NCY3B	●	●	●	●	●	●	●	●	●	●
X160	High speed specification	NCY3B				●	●	●	●	●	●	●
X168	Helical insert thread specification	NCY3B				●	●	●	●	●	●	●
X206	Added mounting tap positions for slider	NCY3B	●	●	●	●	●	●	●	●	●	●
X210	Oil-free exterior specification	NCY3B	●	●	●	●	●	●	●	●	●	●
X322	Outside of cylinder tube with hard chrome plating	NCY3B			●	●	●	●	●	●	●	●
X324	Oil-free exterior specification (with dust seal)	NCY3B		●	●	●	●	●	●	●	●	●
X1468	Interchangeable specification with NCY2B6	NCY3B	●									
XC24	With magnetic shielding plate	NCY3B	●	●	●	●	●	●	●	●	●	●
XC57	With floating joint	NCY3B	●	●	●	●	●	●	●	●	●	●

Note 1) XB9, Low speed cylinder (0.6 to 2.0 inch/s) can also be produced (NCY3B6 to 63).

Series NCY3B

Made to Order 1

Please contact SMC for detailed specifications, lead times and prices.

1 Heat resistant cylinder [150°C (302°F) specification]

Symbol

XB6

NCY3B **Bore size** **Stroke** **XB6**

Heat resistant cylinder

Specifications

Bore size	ø6 to ø63 (1/4" to 2-1/2")
Ambient and fluid temperature	50 to 150°C* (122 to 302°F)
Max. operating pressure	72.5 PSI
Piston speed	2.0 to 16 inch/s (50 to 400 mm/s)

* When using in less than 100°C (212°F) range, since it could make a difference in the maintenance cycle, depending on the operating speed, use it at 200 mm/s (7.9 inch/s) or less.

Operating Pressure Limit for Intermediate Stop and Vertical Operation

Max. operating pressure for intermediate stop	58.0 PSI
---	----------

* Decoupling of the piston can occur if the cylinder is used to stop in an intermediate stroke by an external stopper with the operating pressure over 58.0 PSI.

Magnetic Holding Force

(lbf)

Bore size	(mm)	6	10	15	20	25	32	40	50	63
	(inch nominal)	1/4"	3/8"	5/8"	3/4"	1"	1-1/4"	1-1/2"	2"	2-1/2"
Holding force (at 302°F)		3.2	9.0	20.3	36.0	56.2	92.2	144.1	224.8	357.4
Holding force (at 212°F)		3.9	10.8	24.1	43.2	67.2	110.2	172.2	267.5	427.1

Temperature range for operating cylinder and piston speed

- (1) When using with an operating temperature from 60°C to 100°C (140°F to 212°F), and a piston speed of more than 200 mm/s (7.87 inch/s), please consult with SMC separately.
- (2) When using with an operating temperature from 50°C to 100°C (122°F to 212°F), and a piston speed of less than 200 mm/s (7.87 inch/s), the XB6 specifications can be used.
- (3) As for XB6, regarding the temperature range (over 50°C to 60°C (122°F to 140°F) which overlaps the one of standard products, consider the tendency of operating temperature (upper, lower limits), then choose a model.

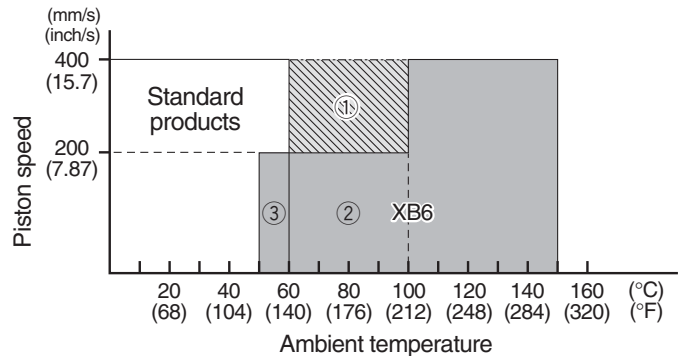

When using with the operating temperature fluctuated between 50°C (122°F) or less and 100°C (212°F) or more, the operating speed, etc. will be largely restricted by the durability. Prior to use, please contact SMC.

<Reference>

Maintenance cycle for XB6 could vary substantially, depending on the operating condition and the ambient temperature. Even if using in our recommended range, as a guide, conduct it in around 1/2 intervals, compared to the standard products.

2 Low speed [0.3 to 2.0 inch/s (7 to 50 mm/s)] specification

Symbol

XB13

NCY3B **Bore size** **Stroke** **XB13**

Low speed
[0.3 to 2.0 inch/s (7 to 50 mm/s)]
specifications

There is no sticking and slipping even at very low drive speeds of 0.3 to 2.0 inch/s (7 to 50 mm/s). Furthermore, there is no lurching at start-up, allowing smooth drive through the entire stroke.

Specifications

Applicable series	NCY3B
Bore size	ø6 to ø63 (1/4" to 2-1/2")
Piston speed	0.3 to 2.0 inch/s (7 to 50 mm/s)

Series NCY3B

Made to Order 2

Please contact SMC for detailed specifications, lead times and prices.

3 Air Hydro specification

Symbol
X116

NCY3B **Bore size** — **Stroke** — **X116**
Air hydro specification

Suitable for precision low speed feeding, intermediate stopping and skip feeding of the cylinder.

Specifications

Bore size	ø25 to ø63 (1" to 2-1/2")
Fluid	Turbine oil
Piston speed	0.6 to 12 inch/s (15 to 300 mm/s)

Note 1) When performing intermediate stops with an air-hydro circuit, set the kinetic energy of the load so that it does not exceed the allowable value. (Regarding the allowable value, refer to the section "Intermediate stops" for each series.)

4 Axial ports

Symbol
X132

NCY3B **Bore size** — **Stroke** — **X132**
Axial ports

The air supply port has been changed to an axial position on the head cover.

Specifications

Bore size	ø6 to ø63 (1/4" to 2-1/2")
-----------	----------------------------

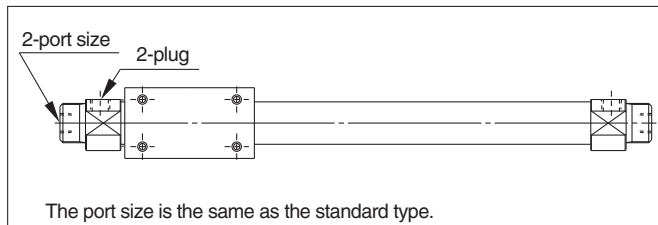

5 High speed specification

Symbol
X160

NCY3B **Bore size** — **Stroke** — **X160**
High speed specification

Makes possible high speed piston drive of 1500mm/s (59.1 inch/s) (without load).

Specifications

Bore size	ø20 to ø63 (3/4" to 2-1/2")
Piston speed (no load)	59.1 inch/s (1500 mm/s)

Note 1) When operating this cylinder at high speed, a shock absorber must be provided.

6 Helical insert thread specification

Symbol
X168

NCY3B **Bore size** — **Stroke** — **X168**
Helical insert thread specification

The standard mounting threads have been changed to the helical insert thread specifications.

Specifications

Bore size	ø20 to ø63 (3/4" to 2-1/2")
-----------	-----------------------------

7 Added mounting tap positions for slider

Symbol
X206

NCY3B **Bore size** — **Stroke** — **X206**
Added mounting tap positions for slider

Mounting taps have been added on the surface opposite the standard positions.

Specifications

Bore size	ø6 to ø63 (1/4" to 2-1/2")
-----------	----------------------------

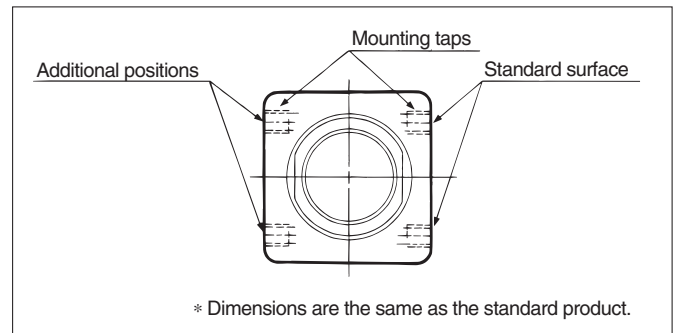

Series NCY3B

Made to Order 3

Please contact SMC for detailed specifications, lead times and prices.

8 Oil-free exterior specification Symbol X210

NCY3B **Bore size** **Stroke** **X210**
Oil-free exterior specification

Suitable for environments where oil is not tolerated. A lubretainer is not installed. A separate version X324 (with dust seal) is available in cases in which dust, etc. is dispersed throughout the environment.

Specifications

Bore size	ø6 to ø63 (1/4" to 2-1/2")
-----------	----------------------------

Construction

NCY3B

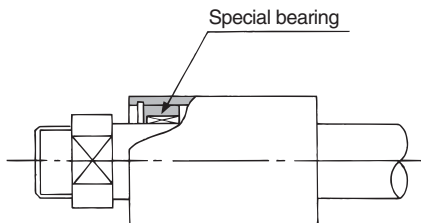

9 Outside of cylinder tube with hard chrome plating Symbol X322

NCY3B **Bore size** **Stroke** **X322**
Outside of cylinder tube with hard chrome plating

The outside of the cylinder tube has been plated with hard chromium for reducing wear on the bearings.

Specifications

Bore size	ø15 to ø63 (5/8" to 2-1/2")
-----------	-----------------------------

Construction

NCY3B

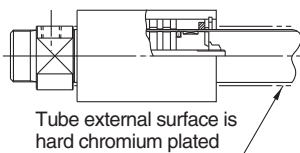

10 Oil-free exterior specification (with dust seal) Symbol X324

NCY3B **Bore size** **Stroke** **X324**
Oil-free exterior specification (with dust seal)

This unit has oil-free exterior specifications, with a dust seal provided on the cylinder body.

Specifications

Bore size	ø10 to ø63 (3/8" to 2-1/2")
-----------	-----------------------------

Construction

NCY3B

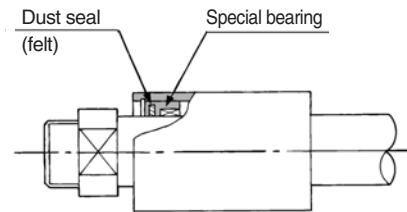

11 Interchangeable specification with NCY2B6 Symbol X1468

NCY3B **6** **Stroke** **X1468**

Bore size Interchangeable specification with the NCY2B6

Bore size (mm)	Bore size (inch)
6	1/4"

Mounting dimensions are interchangeable with the NCY2B6.

12 With magnetic shielding plate Symbol XC24

NCY3B **Bore size** **Stroke** **XC24**

With magnetic shielding plate
Protective shields to minimize external influence of carriage magnet assembly.

Specifications

Bore size	ø6 to ø63 (1/4" to 2-1/2")
-----------	----------------------------

Dimensions

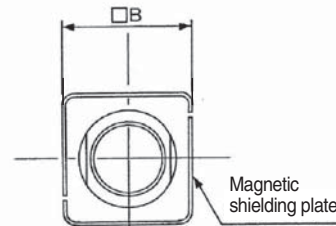

Bore size	(mm)	ø6	ø10	ø15	ø20	ø25	ø32	ø40	ø50	ø63
	(inch)	1/4"	3/8"	5/8"	3/4"	1"	1-1/4"	1-1/2"	2"	2-1/2"
□B		0.75	1.06	1.46	1.50	1.89	2.44	2.83	3.46	4.02
Standard external (□B)		0.67	0.98	1.38	1.42	1.81	2.36	2.76	3.39	3.94

* Dimensions other than above are the same as the standard type.

Series NCY3B

Made to Order 4

Please contact SMC for detailed specifications, lead times and prices.

Symbol

XC57

13 With floating joint

NCY3B Bore size — Stroke — **XC57**
 With floating joint

Specifications

Bore size	ø6 to ø63 (1/4" to 2-1/2")
-----------	----------------------------

Note) Since the body of this cylinder is designed for connection with a floating joint, and cannot be connected to the bodies of standard products, please contact SMC if necessary.

A special floating joint is added to the NCY3B series, and the number of connections to the guide on the other axis (the load side) is reduced. The attachment of the bolt to the floating joint and the load is not limited to the top or bottom.

Dimensions

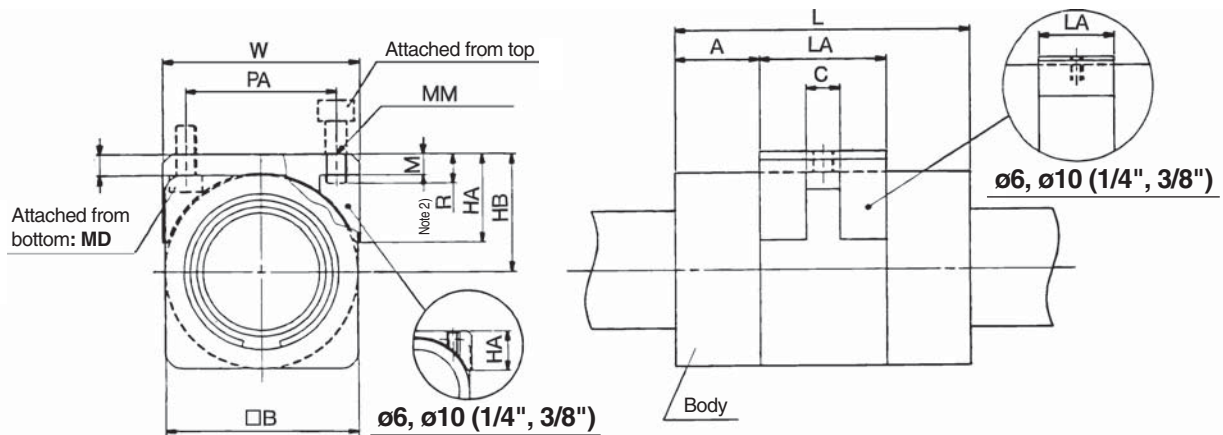

(inch)

Model	A	B	C	F ^{Note 1)}	HA	HB	L	LA	MM	MD	M	PA	R ^{Note 2)}	W
NCY3B6 (1/4")	0.39	0.67	—	0.10	0.25	0.43	1.38	0.59	No.5-40UNC	—	—	0.47	—	0.71
NCY3B10 (3/8")	0.39	0.98	—	0.10	0.37	0.59	1.50	0.71	No.5-40UNC	—	—	0.67	—	1.02
NCY3B15 (5/8")	0.63	1.38	0.26	0.22	0.65	0.91	2.24	0.98	No.8-32UNC	No.5-40UNC	0.16	0.98	0.24	1.42
NCY3B20 (3/4")	0.71	1.42	0.26	0.22	0.67	0.93	2.60	1.18	No.8-32UNC	No.5-40UNC	0.16	1.06	0.24	1.46
NCY3B25 (1")	0.79	1.81	0.31	0.22	0.83	1.12	2.76	1.18	No.10-32UNF	No.6-40UNF	0.20	1.42	0.28	1.85
NCY3B32 (1-1/4")	0.89	2.36	0.37	0.24	1.08	1.42	3.15	1.38	1/4-28UNF	No.10-32UNF	0.24	1.85	0.31	2.40
NCY3B40 (1-1/2")	1.02	2.76	0.37	0.24	1.12	1.61	3.62	1.57	1/4-28UNF	No.10-32UNF	0.24	2.17	0.31	2.80
NCY3B50 (2")	1.46	3.39	0.43	0.24	1.38	1.93	4.50	1.57	5/16-24UNF	1/4-28UNF	0.31	2.56	0.43	3.43
NCY3B63 (2-1/2")	1.51	3.94	0.71	0.28	1.65	2.24	5.00	1.97	5/16-24UNF	1/4-28UNF	0.39	3.15	0.43	3.98

Note 1) Dimension F provides a clearance of 0.04 inch between the body and the floating joint, but does not consider dead weight deflection of the cylinder tube, etc. When put into operation, an appropriate value should be set which considers dead weight deflection and alignment variations with respect to the other axis. (Refer to the dead weight deflection table on page 5.)

Note 2) Use caution when attached from the top and operated at or above dimension R (0.12 inch or more for ø6 (1/4") and ø10 (3/8")), because the end of the screw will contact the body, and floating cannot be maintained in some cases.





Series **NCY3B**

Safety Instructions

These safety instructions are intended to prevent a hazardous situation and/or equipment damage. These instructions indicate the level of potential hazard by labels of "**Caution**", "**Warning**" or "**Danger**". To ensure safety, be sure to observe ISO 4414 ^{Note 1)}, JIS B 8370 ^{Note 2)} and other safety practices.

■ Explanation of the Labels

Labels	Explanation of the labels
 Danger	In extreme conditions, there is a possible result of serious injury or loss of life.
 Warning	Operator error could result in serious injury or loss of life.
 Caution	Operator error could result in injury or equipment damage.

Note 1) ISO 4414: Pneumatic fluid power – General rules relating to systems

Note 2) JIS B 8370: General Rules for Pneumatic Equipment

Note 3) Injury indicates light wounds, burns and electrical shocks that do not require hospitalization or hospital visits for long-term medical treatment.

Note 4) Equipment damage refers to extensive damage to the equipment and surrounding devices.

■ Selection/Handling/Applications

1. The compatibility of the pneumatic equipment is the responsibility of the person who designs the pneumatic system or decides its specifications.

Since the products specified here are used in various operating conditions, their compatibility for the specific pneumatic system must be based on specifications or post analysis and/or tests to meet the specific requirements. The expected performance and safety assurance are the responsibility of the person who has determined the compatibility of the system. This person should continuously review the suitability of all items specified, referring to the latest catalog information with a view to giving due consideration to any possibility of equipment failure when configuring a system.

2. Only trained personnel should operate pneumatically operated machinery and equipment.

Compressed air can be dangerous if handled incorrectly. Assembly, handling or repair of pneumatic systems should be performed by trained and experienced operators.

3. Do not service machinery/equipment or attempt to remove components until safety is confirmed.

1. Inspection and maintenance of machinery/equipment should only be performed once measures to prevent falling or runaway of the driver objects have been confirmed.
2. When equipment is removed, confirm that safety process as mentioned above. Turn off the supply pressure for this equipment and exhaust all residual compressed air in the system.
3. Before machinery/equipment is restarted, take measures to prevent quick extension of a cylinder piston rod, etc.

4. Contact SMC if the product will be used in any of the following conditions:

1. Conditions and environments beyond the given specifications, or if product is used outdoors.
2. Installation on equipment in conjunction with atomic energy, railway, air navigation, vehicles, medical equipment, food and beverages, recreation equipment, emergency stop circuits, clutch and brake circuits in press applications, or safety equipment.
3. An application which has the possibility of having negative effects on people, property, or animals, requiring special safety analysis.
4. If the products are used in an interlock circuit, prepare a double interlock style circuit with a mechanical protection function for the prevention of a breakdown. And, examine the devices periodically if they function normally or not.

■ Exemption from Liability

1. SMC, its officers and employees shall be exempted from liability for any loss or damage arising out of earthquakes or fire, action by a third person, accidents, customer error with or without intention, product misuse, and any other damages caused by abnormal operating conditions.

2. SMC, its officers and employees shall be exempted from liability for any direct or indirect loss or damage, including consequential loss or damage, loss of profits, or loss of chance, claims, demands, proceedings, costs, expenses, awards, judgments and any other liability whatsoever including legal costs and expenses, which may be suffered or incurred, whether in tort (including negligence), contract, breach of statutory duty, equity or otherwise.

3. SMC is exempted from liability for any damages caused by operations not contained in the catalogs and/or instruction manuals, and operations outside of the specification range.

4. SMC is exempted from liability for any loss or damage whatsoever caused by malfunctions of its products when combined with other devices or software.



Series NCY3B

Specific Product Precautions

Be sure to read this before handling. For Safety Instructions, Actuators Precautions, refer to “Precautions for Handling Pneumatic Devices” (M-03-E3A).

Mounting

⚠ Caution

1. Take care to avoid nicks or other damage on the outside surface of the cylinder tube.

This can lead to damage of the scraper and wear ring, which in turn can cause malfunction.

2. Take care regarding rotation of the external slider.

Rotation should be controlled by connecting it to another shaft (linear guide, etc.).

3. Do not operate with the magnetic coupling out of position.

In case the magnetic coupling is out of position, push the external slider back into the correct position by hand at the end of the stroke (or correct the piston slider with air pressure).

4. Be sure that both end covers are secured to the mounting surface before operating the cylinder.

Avoid operation with the external slider secured to the surface.

5. Do not apply a lateral load to the external slider.

When a load is mounted directly to the cylinder, variations in the alignment of each shaft center cannot be assimilated, which results in the generation of a lateral load that can cause malfunction. (Figure 1) The cylinder should be operated using a connection method which allows for assimilation of shaft alignment variations and deflection due to the cylinder's own weight. A drawing of a recommended mounting is shown in Figure 2.

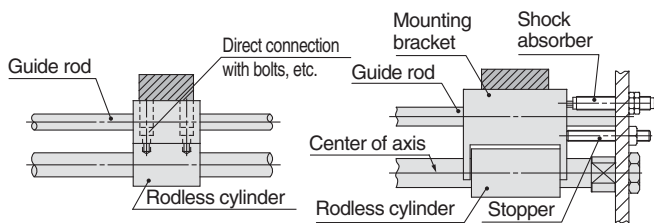

Variations in the load and cylinder shaft alignment cannot be assimilated, resulting in malfunction.

Shaft alignment variations are assimilated by providing clearance for the mounting bracket and cylinder. Moreover, the mounting bracket is extended above the cylinder shaft center, so that the cylinder is not subjected to moment.

Fig. 1. Incorrect mounting

Fig. 2. Recommended mounting

6. Use caution regarding the allowable load weight when operating in a vertical direction.

The allowable load weight when operating in a vertical direction (reference values on page 3) is determined by the model selection method, however, if a load greater than the allowable value is applied, the magnetic coupling may break and there is a possibility of dropping the load. When using this type of application, please contact SMC regarding the operating conditions (pressure, load, speed, stroke, frequency, etc.).

Mounting

⚠ Caution

7. Careful alignment is necessary when connecting to a load having an external guide mechanism.

As the stroke becomes longer, variations in the center axis become larger. Consider using a connection method (floating mechanism) that is able to absorb these variations. Furthermore, use the special floating brackets (XC57) which have been provided for the NCY3B series (page 13).

Disassembly & Maintenance

⚠ Warning

1. Use caution as the attractive power of the magnets is very strong.

When removing the external slider and piston slider from the cylinder tube for maintenance, etc., handle with caution, since the magnets installed in each slider have very strong attractive power.

⚠ Caution

1. When reattaching the head covers after disassembly, confirm that they are tightened securely. (NCY3B)

When disassembling, hold the wrench flat section of one head cover with a vise, and remove the other cover using a spanner or adjustable angle wrench on its wrench flat section. When retightening, first coat with Loctite® (No. 542 red), and retighten 3 to 5° past the original position prior to removal.

2. Use caution when taking off the external slider, as the piston slider will be directly attracted to it.

When removing the external slider or piston slider from the cylinder tube, first force the sliders out of their magnetically coupled positions and then remove them individually while there is no longer any holding force. If they are removed when still magnetically coupled, they will be directly attracted to one another and will not come apart.

3. Do not disassemble the magnetic components (piston slider, external slider).

This can cause a loss of holding force and malfunction.

4. When disassembling to replace the seals and wear ring, refer to the separate disassembly instructions.

Global Manufacturing, Distribution and Service Network

Worldwide Subsidiaries

EUROPE

AUSTRIA
SMC Pneumatik GmbH (Austria)

BELGIUM
SMC Pneumatics N.V./S.A.

BULGARIA
SMC Industrial Automation Bulgaria EOOD

CROATIA
SMC Industrijska Automatika d.o.o.

CZECH
SMC Industrial Automation CZ s.r.o.

DENMARK
SMC Pneumatik A/S

ESTONIA
SMC Pneumatics Estonia

FINLAND
SMC Pneumatics Finland OY

FRANCE
SMC Pneumatique S.A.

GERMANY
SMC Pneumatik GmbH

GREEK
SMC Hellas EPE

HUNGARY
SMC Hungary Ipari Automatizálási Kft.

IRELAND
SMC Pneumatics (Ireland) Ltd.

ITALY
SMC Italia S.p.A.

LATVIA
SMC Pneumatics Latvia SIA

LIETUVA
SMC Pneumatics Lietuva, UAB

NETHERLANDS
SMC Pneumatics BV

NORWAY
SMC Pneumatics Norway A/S

POLAND
SMC Industrial Automation Polska Sp.z.o.o.

ROMANIA
SMC Romania S.r.l.

RUSSIA
SMC Pneumatik LLC.

SLOVAKIA
SMC Priemyselná Automatizácia, s.r.o.

SLOVENIA
SMC Industrijska Avtomatika d.o.o.

SPAIN/PORTUGAL
SMC España, S.A.

SWEDEN
SMC Pneumatics Sweden AB

SWITZERLAND
SMC Pneumatik AG

UK
SMC Pneumatics (U.K.) Ltd.

ASIA

CHINA
SMC (China) Co., Ltd.

HONG KONG
SMC Pneumatics (Hong kong) Ltd.

INDIA
SMC Pneumatics (India) Pvt. Ltd.

JAPAN
SMC Corporation

MALAYSIA
SMC Pneumatics (S.E.A.) Sdn. Bhd.

PHILIPPINES
SMC Pneumatics (Philippines), Inc.

SINGAPORE
SMC Pneumatics (S.E.A.) Pte. Ltd.

SOUTH KOREA
SMC Pneumatics Korea Co., Ltd.

TAIWAN
SMC Pneumatics (Taiwan) Co., Ltd.

THAILAND
SMC Thailand Ltd.

NORTH AMERICA

CANADA
SMC Pneumatics (Canada) Ltd.

MEXICO
SMC Corporation (Mexico) S.A. DE C.V.

USA
SMC Corporation of America

SOUTH AMERICA

ARGENTINA
SMC Argentina S.A.

BOLIVIA
SMC Pneumatics Bolivia S.R.L.

BRAZIL
SMC Neumaticos do Brazil Ltda.

CHILE
SMC Pneumatics (Chile) S.A.

VENEZUELA
SMC Neumatica Venezuela S.A.

OCEANIA

AUSTRALIA
SMC Pneumatics (Australia) Pty. Ltd.

NEW ZEALAND
SMC Pneumatics (N.Z.) Ltd.

U.S. & Canadian Sales Offices

EAST

Atlanta
Boston
Charlotte
Nashville
New Jersey
Richmond
Rochester
Tampa

WEST

Austin
Dallas
Los Angeles
Phoenix
Portland
San Francisco

MIDWEST

Chicago
Cincinnati
Cleveland
Detroit
Indianapolis
Milwaukee
Minneapolis
St. Louis

CANADA

Montreal
Tel: (514) 733-9595
Fax: (514) 733-1771

Toronto
Tel: (905) 812-0400
Fax: (905) 812-8686

Vancouver
Tel: (604) 517-1646
Fax: (604) 517-1647

Windsor
Tel: (519) 944-0555
Fax: (519) 944-1870

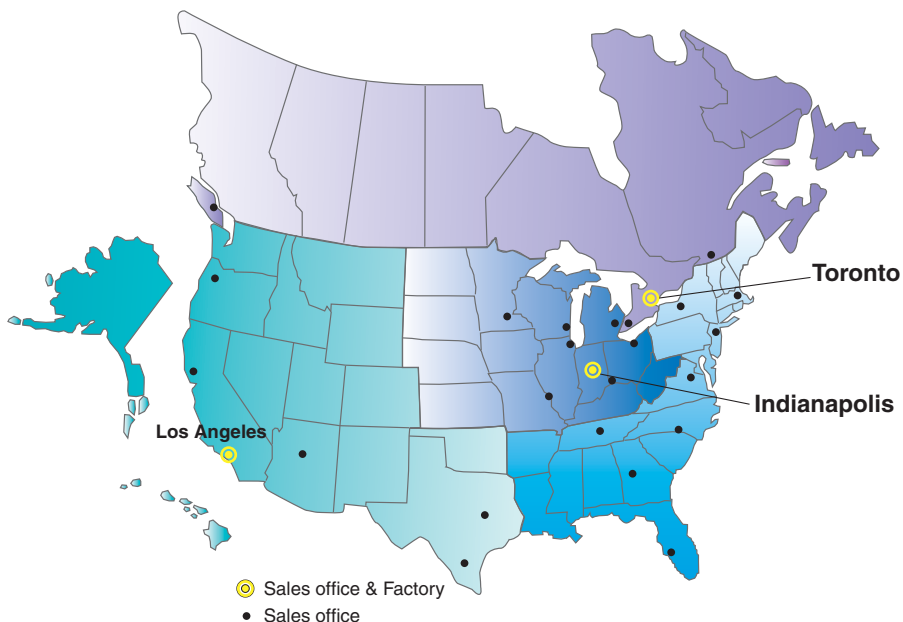

SMC Corporation of America
3011 N. Franklin Road
Indianapolis, IN 46226

SMC Pneumatics (Canada) Ltd.
6768 Financial Drive Mississauga
Ontario, L5N 7J6 Canada

(800) 762-7621 (SMC.SMC1) (905) 812-0400
www.smcusa.com www.smc Pneumatics.ca
For International inquires: www.smcworld.com

