

# Mechanically Jointed Rodless Cylinder with Protective Cover

## MY1□W Series

ø16, ø20, ø25, ø32, ø40, ø50, ø63

**Protective cover offers excellent dust and water resistance**



MY1B  
MY1H  
MY1B  
MY1M  
MY1C  
MY1H  
MY1HT  
MY1□W  
MY2C  
MY2H/HT  
MY3A  
MY3B  
MY3M

Series	Guide type	Cover	Bore size (mm)							Option
			16	20	25	32	40	50	63	
MY1MW	Slide bearing guide	With protective cover	●	●	●	●	●	●	●	<ul style="list-style-type: none"> <li>• Centralized piping</li> <li>• Stroke adjusting unit</li> <li>• Side support</li> </ul>
MY1MWK		With protective cover With side seal	●	●	●	●	●			
MY1CW	Cam follower guide	With protective cover	●	●	●	●	●	●	●	
MY1CWK		With protective cover With side seal	●	●	●	●	●			

D-  
-X  
Technical Data

# MY1□W Series

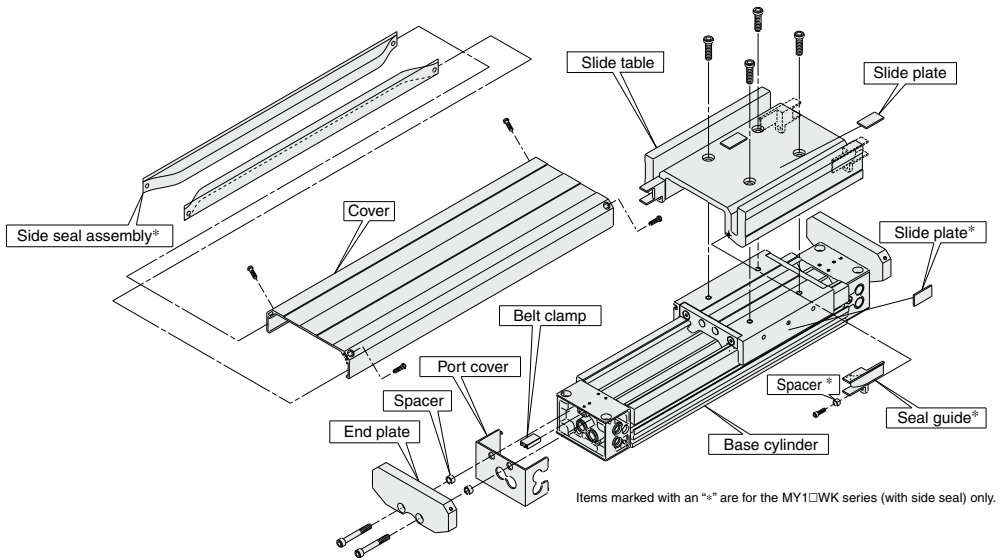

**1** Dustproof and water resistant features are improved for using in locations where the cylinder is exposed to powder dust and water drop or splash.

**2** Side seals provide greater lateral dustproof and water resistance.

**3** The cover in no way interferes with the installation of base cylinder option.

**4** Cover units and side seal units can be installed on the already current MY1M/MY1C series.

**5** Protective cover only minimally adds to overall length.

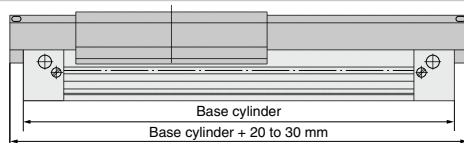

**6** Water-resistant solid state switches can be mounted.

# MY1□W Series Model Selection 1

This section illustrates the standard model selection procedure to help you choose the most suitable cylinders from the MY1MW/MY1CW series for your application needs.

## Standards for Tentative Model Selection

Cylinder model	Guide type	Standards for guide selection	Graphs for related allowable values
<b>MY1MW</b>	Slide bearing guide type	Slide table (2) accuracy approx. $\pm 0.12$ mm	P.1344
<b>MY1CW</b>	Cam follower guide type	Slide table (2) accuracy approx. $\pm 0.05$ mm	P.1345

Note 1) These accuracy values for each guide should be used only as a guide during selection. Please contact SMC when guaranteed accuracy for MY1CW is required.

Note 2) "Accuracy" here means displacement of the slide table (at stroke end) when 50% of the allowable moment shown in the catalog is applied. (reference value).

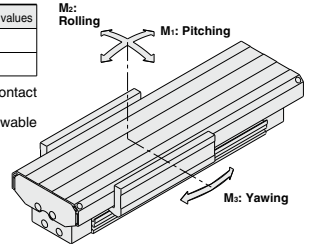

## Selection Flow Chart

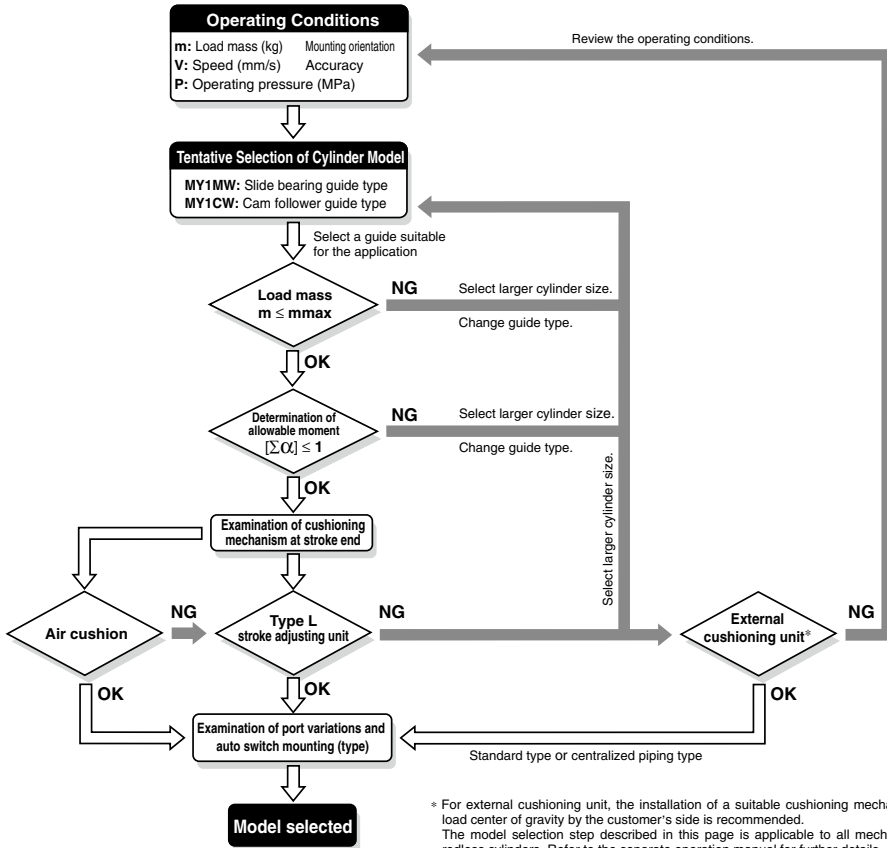

\* For external cushioning unit, the installation of a suitable cushioning mechanism near the load center of gravity by the customer's side is recommended. The model selection step described in this page is applicable to all mechanically jointed rodless cylinders. Refer to the separate operation manual for further details. If you have any questions, please contact SMC.

- MY1B
- MY1H
- MY1B
- MY1M
- MY1C
- MY1H
- MY1 HT
- MY1 □W
- MY2C
- MY2 H/HT
- MY3A
- MY3B
- MY3M

- D-□
- X□
- Technical Data

## Types of Moment Applied to Rodless Cylinders

Multiple moments may be generated depending on the mounting orientation, load, and position of the center of gravity.

### Coordinates and Moments

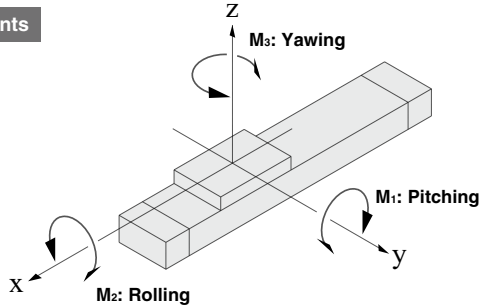

### Static Moment

**Horizontal mounting**

**Ceiling mounting**

**Wall mounting**

**Vertical mounting**

**g: Gravitational acceleration**

Mounting orientation	Horizontal mounting	Ceiling mounting	Wall mounting	Vertical mounting
Static load (m)	$m_1$	$m_2$	$m_3$	$m_4$ (Note)
Static moment	$M_1$	$M_2$	$M_3$	$M_4$
	$m_1 \times g \times X$	$m_2 \times g \times X$	—	$m_4 \times g \times Z$
	$m_1 \times g \times Y$	$m_2 \times g \times Y$	$m_3 \times g \times Z$	—
	—	—	$m_3 \times g \times X$	$m_4 \times g \times Y$

Note) "m<sub>4</sub>" is a mass movable by thrust. Use 0.3 to 0.7 times the thrust (varies depending on the operating speed) as a guide for actual use.

### Dynamic Moment

Mounting orientation	Horizontal mounting	Ceiling mounting	Wall mounting	Vertical mounting
Dynamic load $F_E$	$\frac{1.4}{100} \times v_a \times m_n \times g$			
Dynamic moment	$M_{1E}$	$\frac{1}{3} \times F_E \times Z$		
	$M_{2E}$	Dynamic moment $M_{2E}$ is not generated.		
	$M_{3E}$	$\frac{1}{3} \times F_E \times Y$		

Note) Regardless of the mounting orientation, dynamic moment is calculated using the formulas above.

**g: Gravitational acceleration,  $v_a$ : Average speed**

## Maximum Allowable Moment/Maximum Load Mass

Model	Bore size (mm)	Maximum allowable moment (N-m)			Maximum load mass (kg)		
		M1	M2	M3	m1	m2	m3
MY1MW	16	6.0	3.0	1.0	18	7	2.1
	20	10	5.2	1.7	26	10.4	3
	25	15	9.0	2.4	38	15	4.5
	32	30	15	5.0	57	23	6.6
	40	59	24	8.0	84	33	10
	50	115	38	15	120	48	14
MY1CW	16	6.0	3.0	2.0	18	7	2.1
	20	10	5.0	3.0	25	10	3
	25	15	8.5	5.0	35	14	4.2
	32	30	14	10	49	21	6
	40	60	23	20	68	30	8.2
	50	115	35	35	93	42	11.5
63	150	50	50	130	60	16	

The above values are the maximum allowable values for moment and load. Refer to each graph regarding the maximum allowable moment and maximum allowable load for a particular piston speed.

### Maximum Allowable Moment

Select the moment from within the range of operating limits shown in the graphs. Note that the maximum allowable load value may sometimes be exceeded even within the operating limits shown in the graphs. Therefore, also check the allowable load for the selected conditions.

### Load mass (kg)

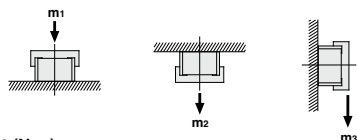

### Caution

- The cylinder should be mounted in m1 orientation if maximum dustproofing is required.

### Moment (N-m)

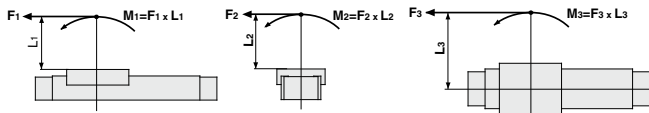

### <Calculation of guide load factor>

- Three factors must be considered when computing calculations for selection: (1) Maximum load mass, (2) Static moment, (3) Dynamic moment (at the time of impact with stopper).  
 \* To evaluate, use  $\bar{v}_a$  (average speed) for (1) and (2), and  $v$  (collision speed  $v = 1.4 \bar{v}_a$ ) for (3). Calculate  $m_{max}$  for (1) from the maximum allowable load graph ( $m_1, m_2, \text{ and } m_3$ ), and  $M_{max}$  for (2) and (3) from the maximum allowable moment graph ( $M_1, M_2, \text{ and } M_3$ ).

### Maximum Load Mass

Select the load from within the range of limits shown in the graphs. Note that the maximum allowable moment value may sometimes be exceeded even within the operating limits shown in the graphs. Therefore, also check the allowable moment for the selected conditions.

$$\text{Sum of guide load factors } \Sigma \alpha = \frac{\text{Load mass [m]}}{\text{Maximum allowable load [mmax]}} + \frac{\text{Static moment [M] (Note 1)}}{\text{Allowable static moment [Mmax]}} + \frac{\text{Dynamic moment [ME] (Note 2)}}{\text{Allowable dynamic moment [MEMax]}} \leq 1$$

Note 1) Moment caused by the load, etc., with cylinder in resting condition.

Note 2) Moment caused by the impact load equivalent at the stroke end (at the time of impact with stopper).

Note 3) Depending on the shape of the workpiece, multiple moments may occur. When this happens, the sum of the load factors ( $\Sigma \alpha$ ) is the total of all such moments.

### 2. Reference formula [Dynamic moment at impact]

Use the following formulae to calculate dynamic moment when taking stopper impact into consideration.

- |   |   |
|---|---|
| m: Load mass (kg)   | v: Collision speed (mm/s)                             |
| F: Load (N)   | L: Distance to the load's center of gravity (m)       |
| F <sub>E</sub> : Load equivalent to impact (at impact with stopper) (N) | ME: Dynamic moment (N-m)                              |
| $\bar{v}_a$ : Average speed (mm/s)                                      | g: Gravitational acceleration (9.8 m/s <sup>2</sup> ) |
| M: Static moment (N-m)  |   |

$$v = 1.4 \bar{v}_a \text{ (mm/s)} \quad F_E = \frac{1.4}{100} \bar{v}_a \cdot g \cdot m \text{ (Note 4)}$$

$$\therefore ME = \frac{1}{3} F_E \cdot L = 0.05 \bar{v}_a \cdot m \cdot L \text{ (N-m) (Note 5)}$$

Note 4)  $\frac{1.4}{100} \bar{v}_a$  is a dimensionless coefficient for calculating impact force.

Note 5) Average load coefficient ( $= \frac{1}{3}$ ): This coefficient is for averaging the maximum load moment at the time of stopper impact according to service life calculations.

3. For detailed selection procedures, refer to pages 1348 and 1349.

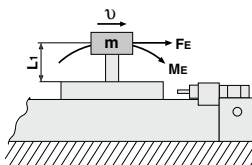

MY1B

MY1H

MY1B

MY1M

MY1C

MY1H

MY1HT

MY1

□W

MY2C

MY2H/HT

MY3A

MY3B

MY3M

MY3M

D-□

-X□

Technical Data

## Maximum Allowable Moment/Maximum Load Mass

### Maximum Allowable Moment: MY1MW

MY1MW/M<sub>1</sub>

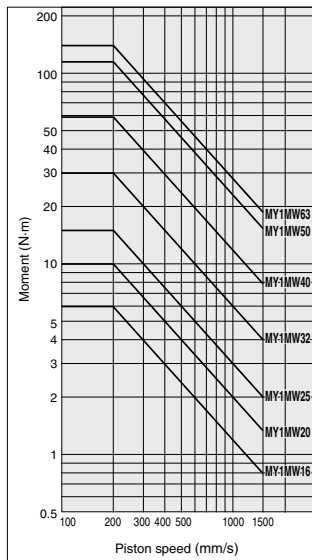

MY1MW/M<sub>2</sub>

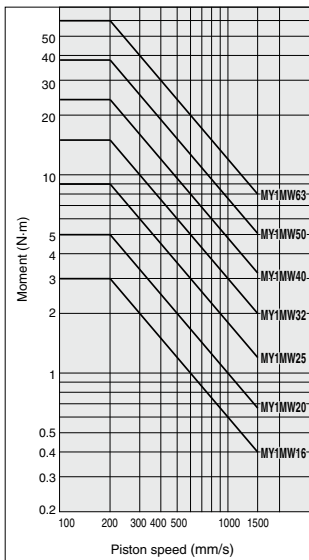

MY1MW/M<sub>3</sub>

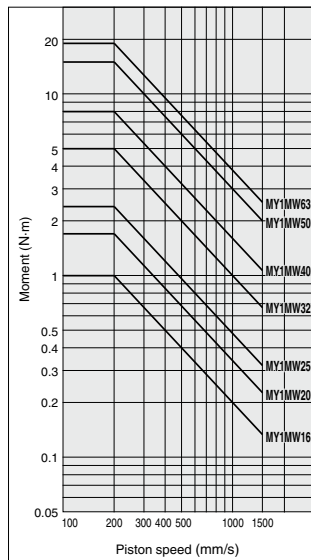

### Maximum Load Mass: MY1MW

MY1MW/m<sub>1</sub>

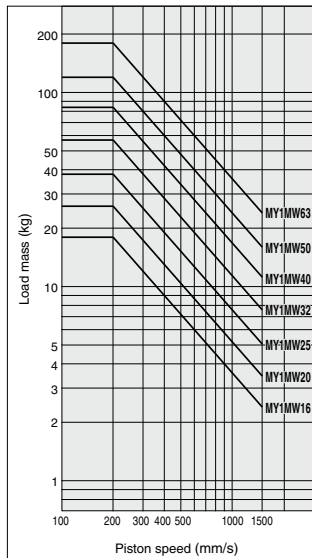

MY1MW/m<sub>2</sub>

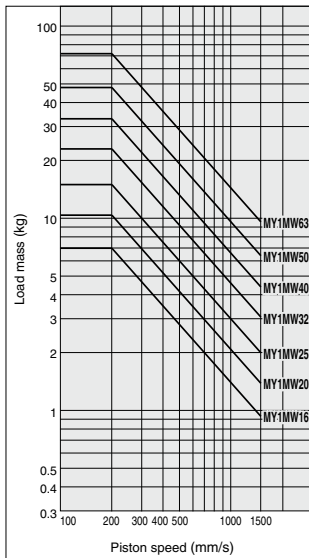

MY1MW/m<sub>3</sub>

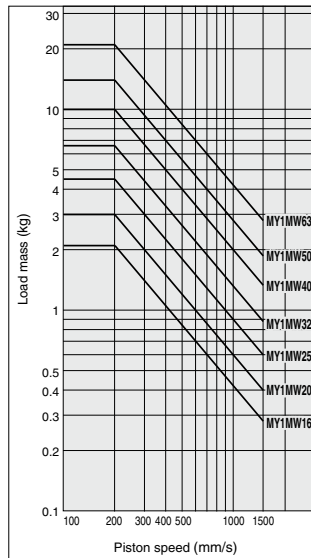

**Maximum Allowable Moment: MY1CW**

**MY1CW/M1**

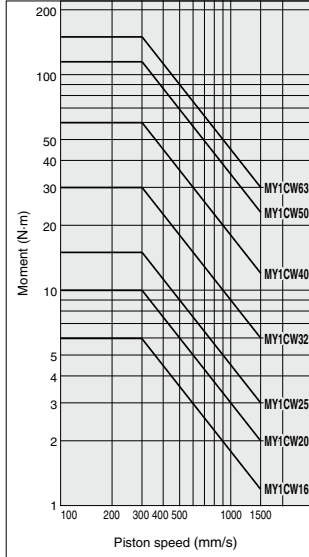

**MY1CW/M2**

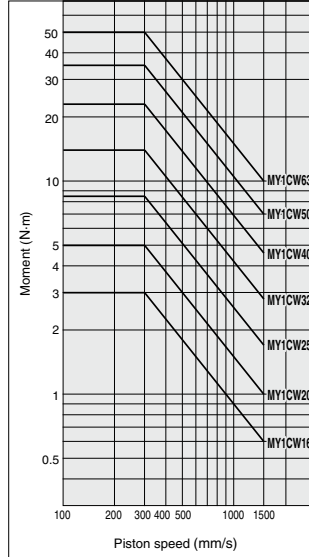

**MY1CW/M3**

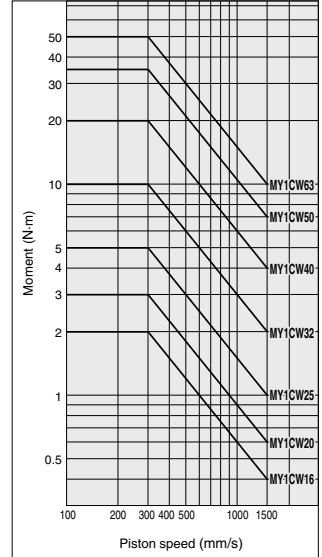

**Maximum Load Mass: MY1CW**

**MY1CW/m1**

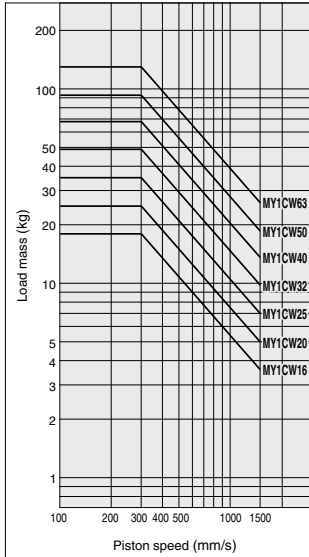

**MY1CW/m2**

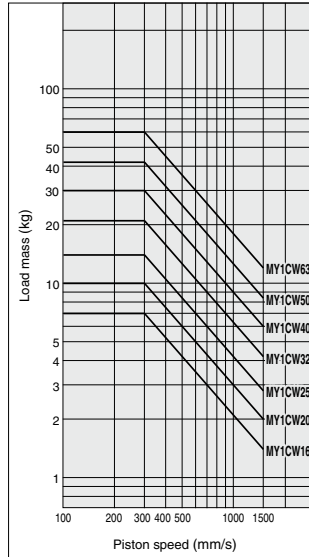

**MY1CW/m3**

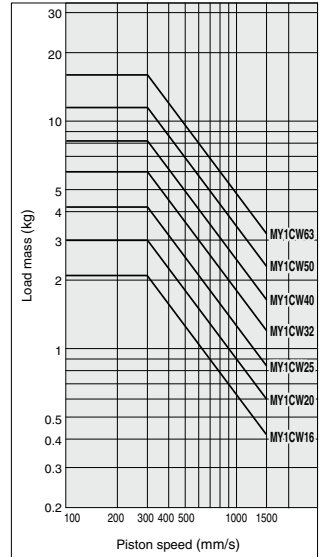

- MY1B
- MY1H
- MY1B
- MY1M
- MY1C
- MY1H
- MY1 HT
- MY1□W
- MY2C
- MY2 H/HT
- MY3A
- MY3B
- MY3M

- D-□
  - X□
- Technical Data

## Cushion Capacity

### Cushion Selection

#### <Air cushion>

Air cushions are a standard feature on mechanically jointed rodless cylinders.

The air cushion mechanism is incorporated to prevent excessive impact of the piston at the stroke end during high speed operation. The purpose of air cushion, thus, is not to decelerate the piston near the stroke end.

The ranges of load and speed that air cushions can absorb are within the air cushion limit lines shown in the graphs.

#### <Stroke adjusting unit with shock absorber>

Use this unit when operating with a load or speed exceeding the air cushion limit line, or when cushioning is required outside of the effective air cushion stroke range due to stroke adjustment.

#### L unit

Use this unit when the cylinder stroke is outside of the effective air cushion range even if the load and speed are within the air cushion limit line, or when the cylinder is operated in a load and speed range above the air cushion limit line or below the L unit limit line.

### ⚠ Caution

1. Refer to the figure below when using the adjusting bolt to perform stroke adjustment.

When the effective stroke of the shock absorber decreases as a result of stroke adjustment, the absorption capacity decreases dramatically. Secure the adjusting bolt at the position where it protrudes approximately 0.5 mm from the shock absorber.

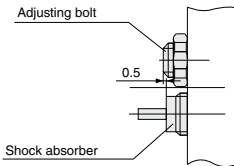

2. Do not use a shock absorber together with air cushion.

#### Air Cushion Stroke

Bore size (mm)	Cushion stroke (mm)
16	12
20	15
25	15
32	19
40	24
50	30
63	37

### Absorption Capacity of Air Cushion and Stroke Adjusting Units

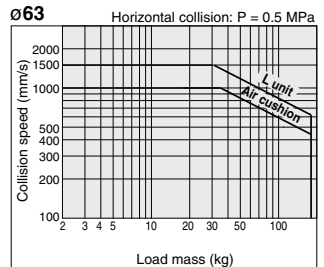
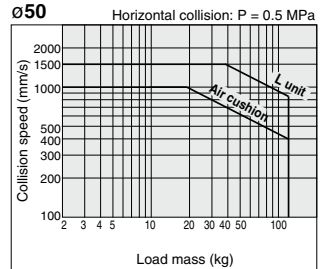
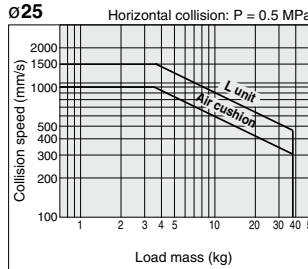
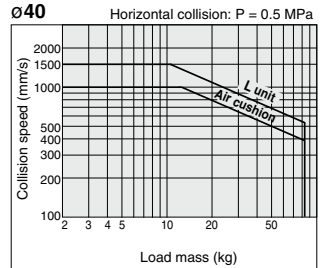
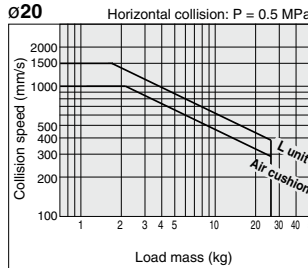
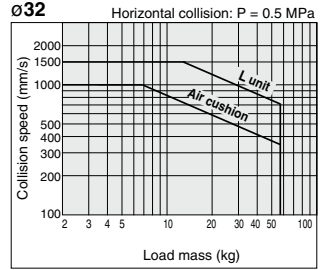
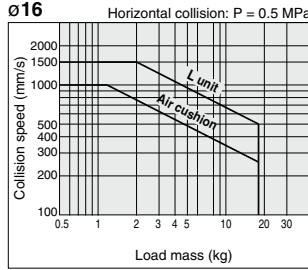



**Tightening Torque for Stroke Adjusting Unit Holding Bolts** (N·m)

Bore size (mm)	Unit	Tightening torque
16	A	0.7
	L	
20	A	1.8
	L	
25	A	3.5
	L	
32	A	5.8
	L	
40	A	13.8
	L	
50	A	13.8
	L	
63	A	27.5
	L	

**Tightening Torque for Stroke Adjusting Unit Lock Plate Holding Bolts** (N·m)

Bore size (mm)	Unit	Tightening torque
25	L	1.2
32	L	3.3
40	L	3.3

**Calculation of Absorbed Energy for Stroke Adjusting Unit with Shock Absorber** (N·m)

Type of impact	Horizontal collision	Vertical (Downward)	Vertical (Upward)
Kinetic energy E <sub>1</sub>	$\frac{1}{2} m \cdot v^2$		
Thrust energy E <sub>2</sub>	F·s	F·s + m·g·s	F·s - m·g·s
Absorbed energy E	E <sub>1</sub> + E <sub>2</sub>		

Symbol  
 v: Speed of impact object (m/s)  
 m: Mass of impact object (kg)  
 F: Cylinder thrust (N)  
 g: Gravitational acceleration (9.8 m/s<sup>2</sup>)  
 s: Shock absorber stroke (m)

Note) The speed of the impact object is measured at the moment of impact with the shock absorber.

**⚠ Precautions**

Be sure to read this before handling the products. Refer to back page 50 for Safety Instructions and pages 3 to 12 for Actuator and Auto Switch Precautions.

**⚠ Caution**

Use caution not to get your hands caught in the unit.

- When using a product with stroke adjusting unit, the space between the slide table (slider) and the stroke adjusting unit becomes narrow at the stroke end, causing a danger of hands getting caught. When operating with the protective cover removed (in the case of installation, etc.), be careful not to get your hands caught in the unit.

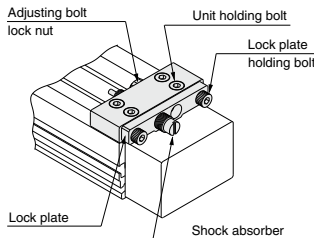

**<Fastening of unit>**  
 The unit can be secured by evenly tightening the four unit holding bolts.

**⚠ Caution**

**Do not operate with the stroke adjusting unit fixed in an intermediate position.**

When the stroke adjusting unit is fixed in an intermediate position, slippage can occur depending on the amount of energy released at the time of an impact. In such cases, the use of the adjusting bolt mounting brackets, available per made-to-order specifications -X416 and -X417, is recommended.

For other lengths, please consult with SMC (Refer to the "Tightening Torque for Stroke Adjusting Unit Holding Bolts" values in the chart at the upper left corner of this page.)

**<Stroke adjustment with adjusting bolt>**  
 Loosen the adjusting bolt lock nut, and adjust the stroke from the lock plate side using a hexagon wrench. Retighten the lock nut.

**<Stroke adjustment with shock absorber>**  
 Loosen the two lock plate holding bolts, turn the shock absorber and adjust the stroke. Then, uniformly tighten the lock plate holding bolts to secure the shock absorber.

Avoid excessive tightening of the holding bolts (except for ø16, ø20, ø50, and ø63). (Refer to "Tightening Torque for Stroke Adjusting Unit Lock Plate Holding Bolts" above left.)

Note)  
 Although the lock plate may slightly bend due to tightening of the lock plate holding bolt, this does not affect the shock absorber and locking function.

- MY1B
- MY1H
- MY1B
- MY1M
- MY1C
- MY1H
- MY1 HT
- MY1 □W
- MY2C
- MY2 H/HT
- MY3A
- MY3B
- MY3M

- D-□
- X□
- Technical Data

# MY1□W Series Model Selection 2

This section illustrates the standard model selection procedure using the actual operating conditions as one of the examples.

## Calculation of Guide Load Factor

### 1 Operating Conditions

Cylinder .....MY1MW40-500

Average operating speed  $v_a$  .....200 mm/s

Mounting orientation .....Horizontal mounting

Wd: Workpiece (500 g)

Wc: MHL2-16D1(795 g)

Wa: Connection plate  $t = 10$  (880 g)

MY1MW40-500

Wb: MGGLB25-200 (4.35 kg)

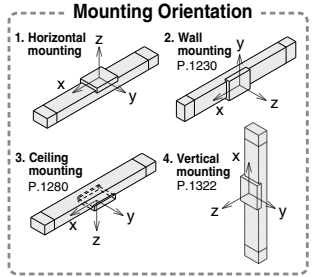
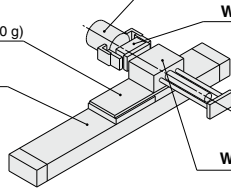

For actual examples of calculation for each orientation, refer to the pages above.

### 2 Load Blocking

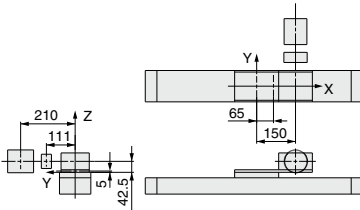

### Mass and Center of Gravity for Each Workpiece

Workpiece no. W <sub>n</sub>	Mass m <sub>n</sub>	Center of gravity		
		X-axis X <sub>n</sub>	Y-axis Y <sub>n</sub>	Z-axis Z <sub>n</sub>
W <sub>a</sub>	0.88 kg	65 mm	0 mm	5 mm
W <sub>b</sub>	4.35 kg	150 mm	0 mm	42.5 mm
W <sub>c</sub>	0.795 kg	150 mm	111 mm	42.5 mm
W <sub>d</sub>	0.5 kg	150 mm	210 mm	42.5 mm

n = a, b, c, d

### 3 Composite Center of Gravity Calculation

$$m_1 = \sum m_n$$

$$= 0.88 + 4.35 + 0.795 + 0.5 = 6.525 \text{ kg}$$

$$X = \frac{1}{m_1} \times \sum (m_n \times x_n)$$

$$= \frac{1}{6.525} (0.88 \times 65 + 4.35 \times 150 + 0.795 \times 150 + 0.5 \times 150) = 138.5 \text{ mm}$$

$$Y = \frac{1}{m_1} \times \sum (m_n \times y_n)$$

$$= \frac{1}{6.525} (0.88 \times 0 + 4.35 \times 0 + 0.795 \times 111 + 0.5 \times 210) = 29.6 \text{ mm}$$

$$Z = \frac{1}{m_1} \times \sum (m_n \times z_n)$$

$$= \frac{1}{6.525} (0.88 \times 5 + 4.35 \times 42.5 + 0.795 \times 42.5 + 0.5 \times 42.5) = 37.4 \text{ mm}$$

### 4 Calculation of Load Factor for Static Load

m<sub>1</sub>: Mass

m<sub>1</sub>.max (from 1 of graph MY1MW/m<sub>1</sub>) = 84 (kg) .....

Load factor  $\alpha_1 = m_1/m_{1,max} = 6.525/84 = 0.08$

M<sub>1</sub>: Moment

M<sub>1</sub>.max (from (2) of graph MY1MW/M<sub>1</sub>) = 59 (N-m) .....

M<sub>1</sub> = m<sub>1</sub> × g × X = 6.525 × 9.8 × 138.5 × 10<sup>-3</sup> = 8.86 (N-m)

Load factor  $\alpha_2 = M_1/M_{1,max} = 8.86/59 = 0.15$

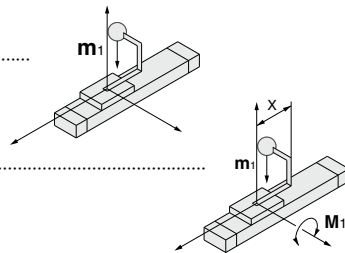

**Calculation of Guide Load Factor**

**M<sub>2</sub>: Moment**

**M<sub>2max</sub>** (from 3 of graph MY1MW: **M<sub>2</sub>**) = 24 (N·m) .....

**M<sub>3</sub>** = **m<sub>1</sub>** × **g** × **Y** = 6.525 × 9.8 × 29.6 × 10<sup>-3</sup> = 1.89 (N·m)

Load factor **α<sub>3</sub>** = **M<sub>2</sub>/M<sub>2max</sub>** = 1.89/24 = **0.08**

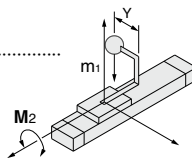

**5 Calculation of Load Factor for Dynamic Moment**

**Equivalent load F<sub>E</sub> at impact**

$$F_E = \frac{1.4}{100} \times U_a \times g \times m = \frac{1.4}{100} \times 200 \times 9.8 \times 6.525 = 179.1 \text{ (N)}$$

**M<sub>1E</sub>: Moment**

**M<sub>1Emax</sub>** (from 4 of graph MY1MW: **M<sub>1</sub>** where 1.4U<sub>a</sub> = 280 mm/s) = 42.1 (N·m) .....

$$M_{1E} = \frac{1}{3} \times F_E \times Z = \frac{1}{3} \times 179.1 \times 37.4 \times 10^{-3} = 2.23 \text{ (N·m)}$$

Load factor **α<sub>4</sub>** = **M<sub>1E</sub>/M<sub>1Emax</sub>** = 2.23/42.1 = **0.05**

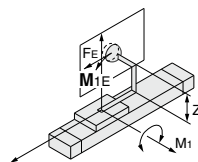

**M<sub>3E</sub>: Moment**

**M<sub>3Emax</sub>** (from 5 of graph MY1MW: **M<sub>3</sub>** where 1.4U<sub>a</sub> = 280 mm/s) = 5.7 (N·m) .....

$$M_{3E} = \frac{1}{3} \times F_E \times Y = \frac{1}{3} \times 179.1 \times 29.6 \times 10^{-3} = 1.77 \text{ (N·m)}$$

Load factor **α<sub>5</sub>** = **M<sub>3E</sub>/M<sub>3Emax</sub>** = 1.77/5.7 = **0.31**

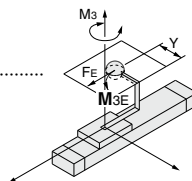

**6 Sum and Examination of Guide Load Factors**

$$\sum \alpha = \alpha_1 + \alpha_2 + \alpha_3 + \alpha_4 + \alpha_5 = 0.67 \leq 1$$

The above calculation is within the allowable value, and therefore the selected model can be used.

Select a shock absorber separately.

In an actual calculation, when the total sum of guide load factors  $\sum \alpha$  in the formula above is more than 1, consider either decreasing the speed, increasing the bore size, or changing the product series. This calculation can be easily made using the "SMC Pneumatics CAD System".

- MY1B
- MY1H
- MY1B
- MY1M
- MY1C
- MY1H
- MY1 HT
- MY1 □W
- MY2C
- MY2 H/HT
- MY3A
- MY3B
- MY3M

**Load Mass**

**MY1MW/m<sub>1</sub>**

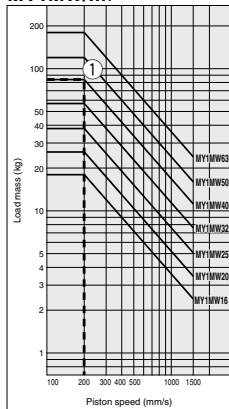

**Allowable Moment**

**MY1MW/M<sub>1</sub>**

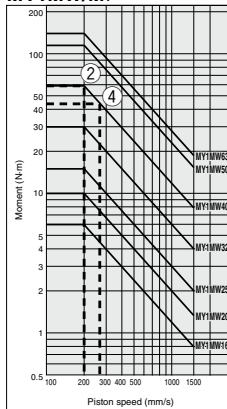

**MY1MW/M<sub>2</sub>**

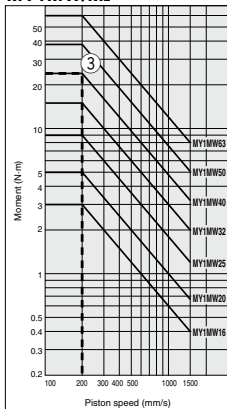

**MY1MW/M<sub>3</sub>**

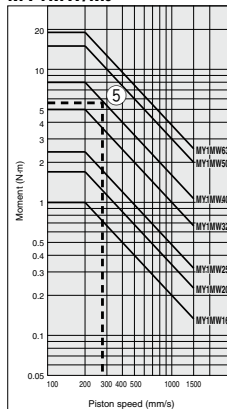

- D
- X
- Technical Data

# Mechanically Jointed Rodless Cylinder with Protective Cover Slide Bearing Guide Type, Cam Follower Guide Type

## MY1□W Series

ø16, ø20, ø25, ø32, ø40, ø50, ø63

### How to Order

**MY1 M W K 32** - **300** - **M9BW**

**Guide type**

M	Slide bearing guide type
C	Cam follower guide type

**With protective cover**

**Side seal**

Nil	None
K	With side seal

Note) Cylinders with side seal are available for ø16 to ø40.

**Bore size**

16	16 mm
20	20 mm
25	25 mm
32	32 mm
40	40 mm
50	50 mm
63	63 mm

**Port thread type**

Symbol	Type	Bore size
Nil	M thread	ø16, ø20
Rc	Rc	ø25, ø32, ø40, ø50, ø63
TN	NPT	
TF	G	

**Piping**

Nil	Standard type
G	Centralized piping type

**Auto switch**

Nil	Without auto switch (Built-in magnet)
-----	---------------------------------------

Applicable auto switches vary depending on the bore size. Select an applicable one referring to the table below.

**Number of auto switches**

Nil	2 pcs
S	1 pc
n	"n" pcs

**Stroke adjustment unit symbol**  
Refer to "Stroke adjustment unit" on page 1351.

**Made to Order Specifications**  
For details, refer to page 1351.

**Cylinder stroke (mm)**

Bore size (mm)	Standard stroke (mm)*	Maximum manufacturable stroke (mm)
16, 20, 25, 32, 40, 50, 63	100, 200, 300, 400, 500, 600, 700, 800, 900, 1000, 1200, 1400, 1600, 1800, 2000	3000

\* The stroke can be manufactured up to the maximum stroke from 1 mm stroke in 1 mm increments. However, when the stroke is 49 mm or less, the air cushion capability lowers and multiple auto switches cannot be mounted. Pay special attention to this point. Also when exceeding a 2000 mm stroke, specify "XB11" at the end of the model number. For details, refer to the "Made to Order Specifications".

### Applicable Auto Switches

Refer to pages 1575 to 1701 for further information on auto switches.

Type	Special function	Electrical entry	Indicator light	Wiring (Output)	Load voltage		Auto switch model						Lead wire length (m)					Pre-wired connector	Applicable load
					DC	AC	Perpendicular			In-line			0.5 (Nil)	1 (M)	3 (L)	5 (Z)			
							ø16, ø20	ø25 to ø40	ø50, ø63	ø16, ø20	ø25 to ø63	ø16, ø20					ø25 to ø63		
Solid state auto switch	Diagnostic indication (2-color indicator)	Grommet	Yes	3-wire (NPN)	24 V	5 V, 12 V	—	—	M9NV	—	M9N	●	●	○	○	IC circuit	Relay, PLC		
				3-wire (PNP)				—	M9PV	—	M9P	●	●	○	○				
				2-wire				—	M9BV	—	M9B	●	●	○	○				
				3-wire (NPN)				—	M9NVV	—	M9NW	●	●	○	○				
				3-wire (PNP)				—	M9PVV	—	M9PW	●	●	○	○				
				2-wire				—	M9BWW	—	M9BWW	●	●	○	○				
	Water resistant (2-color indicator)	Grommet	No	3-wire (NPN)	24 V	5 V, 12 V	—	—	M9NAV*1	—	M9NA*1	○	○	○	○	IC circuit	Relay, PLC		
				3-wire (PNP)				—	M9PAV*1	—	M9PA*1	○	○	○	○				
				2-wire				—	M9BAV*1	—	M9BA*1	○	○	○	○				
				2-wire				—	—	—	—	—	—	—	—				
Reed auto switch	Grommet	Yes	3-wire (NPN equivalent)	24 V	12 V	100 V 100 V or less	—	A96	Z76	●	—	●	—	IC circuit	—				
			2-wire				—	A93	Z73*2	●	●	●	—						
			2-wire				—	A90	Z80	●	—	●	—						

\*1 Water resistant type auto switches can be mounted on the above models, but in such case SMC cannot guarantee water resistance.

\* Lead wire length symbols: 0.5 m.....Nil (Example) M9NV  
1 m.....M (Example) M9NVM  
3 m.....L (Example) M9NWL  
5 m.....Z (Example) M9NVZ

\* Solid state auto switches marked with "C" are produced upon receipt of order.

\* Separate switch spacers (BMG2-012) are required to retrofit auto switches (M9 type) on cylinders ø25 to ø63.

\*2 1 m type lead wire is only applicable to D-A93.

\* Refer to page 1360 for details on other applicable auto switches than listed above.

\* For details about auto switches with pre-wired connector, refer to pages 1648 and 1649.

\* Auto switches are shipped together (not assembled). (Refer to pages 1359 to 1361 for the details of auto switch mounting.)

# Mechanically Jointed Rodless Cylinder With Protective Cover **MY1□W Series**

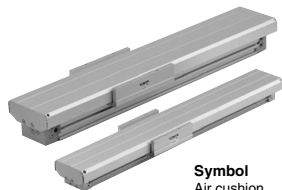

Symbol  
Air cushion

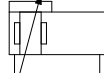

**Made to Order Specifications**  
Click here for details

Symbol	Specifications
-XB11	Long stroke
-XB22	Shock absorber soft type RJ series type
-XC67	NBR rubber lining in dust seal band

## Specifications

Bore size (mm)	16	20	25	32	40	50	63
Fluid	Air						
Action	Double acting						
Operating pressure range	MY1MW: 0.15 to 0.8 MPa; MY1CW: 0.1 to 0.8 MPa						
Proof pressure	1.2 MPa						
Ambient and fluid temperature	5 to 60°C						
Cushion	Air cushion						
Lubrication	Non-lube						
Stroke length tolerance	1000 or less <sup>+1.8</sup> <sub>0</sub> 1001 to 3000 <sup>+2.8</sup> <sub>0</sub>			2700 or less <sup>+1.8</sup> <sub>0</sub> , 2701 to 3000 <sup>+2.8</sup> <sub>0</sub>			
Piping port size	Front/Side port M5 x 0.8		Rc 1/8		Rc 1/4		Rc 3/8
	Bottom port		ø4		ø6		ø8
							ø10

## Piston Speed

Bore size (mm)		16 to 63
Without stroke adjustment unit		100 to 1000 mm/s
Stroke adjustment unit	A unit	100 to 1000 mm/s <sup>(1)</sup>
	L unit	100 to 1500 mm/s <sup>(2)</sup>

Note 1) Be aware that when the stroke adjustment range is increased by manipulating the adjustment bolt, the air cushion capacity decreases. Also, when exceeding the air cushion stroke ranges on page 1346, the piston speed should be 100 to 200 mm per second.

Note 2) The piston speed is 100 to 1000 mm/s for centralized piping.

Note 3) Use at a speed within the absorption capacity range. Refer to page 1346.

## Stroke Adjustment Unit Specifications

Bore size (mm)		16		20		25		32		40		50		63	
Unit symbol		A	L	A	L	A	L	A	L	A	L	A	L	A	L
Configuration		With adjustment bolt		With adjustment bolt		With adjustment bolt		With adjustment bolt		With adjustment bolt		With adjustment bolt		With adjustment bolt	
Shock absorber model		RB 0806 + with adjustment bolt		RB 0806 + with adjustment bolt		RB 1007 + with adjustment bolt		RB 1412 + with adjustment bolt		RB 1412 + with adjustment bolt		RB 2015 + with adjustment bolt		RB 2015 + with adjustment bolt	
Stroke adjustment range by intermediate fixing spacer (mm)	Without spacer	0 to -5.6	0 to -6	0 to -11.5	0 to -12	0 to -16	0 to -16	0 to -20	0 to -20	0 to -25	0 to -25	0 to -25	0 to -25	0 to -25	0 to -25
	With short spacer	-5.6 to -11.2	-6 to -12	-11.5 to -23	-12 to -24	-16 to -32	-16 to -32	-20 to -40	-20 to -40	-25 to -50	-25 to -50	-25 to -50	-25 to -50	-25 to -50	-25 to -50
	With long spacer	-11.2 to -16.8	-12 to -18	-23 to -34.5	-24 to -36	-32 to -48	-32 to -48	-40 to -60	-40 to -60	-50 to -75	-50 to -75	-50 to -75	-50 to -75	-50 to -75	-50 to -75

\* Stroke adjustment range is applicable for one side when mounted on a cylinder.

## Stroke Adjustment Unit Symbol

Left side stroke adjustment unit		Right side stroke adjustment unit													
		Without unit		A: With adjustment bolt				L: With low load shock absorber + Adjustment bolt							
				With short spacer		With long spacer		With short spacer		With long spacer		With short spacer		With long spacer	
Without unit		Nil	SA	SA6	SA7	SL	SL6	SL7							
A: With adjustment bolt		AS	A	AA6	AA7	AL	AL6	AL7							
With short spacer		A6S	A6A	A6	A6A7	A6L	A6L6	A6L7							
With long spacer		A7S	A7A	A7A6	A7	A7L	A7L6	A7L7							
L: With low load shock absorber + Adjustment bolt		LS	LA	LA6	LA7	L	LL6	LL7							
With short spacer		L6S	L6A	L6A6	L6A7	L6L	L6L6	L6L7							
With long spacer		L7S	L7A	L7A6	L7A7	L7L	L7L6	L7L7							

\* Spacers are used to fix the stroke adjustment unit at an intermediate stroke position.

## Shock Absorbers for L Unit

Type	Stroke adjustment unit	Bore size (mm)						
		16	20	25	32	40	50	63
Standard (Shock absorber/RB series)	L	RB0806	RB1007	RB1412	RB2015			
Shock absorber/soft type RJ series mounted (-XB22)	L	RJ0806H	RJ1007H	RJ1412H				

\* The shock absorber service life is different from that of the MY1□W cylinder depending on operating conditions. Refer to the RB Series Specific Product Precautions for the replacement period.

\* Mounted shock absorber soft type RJ series (-XB22) is made to order specifications. For details, refer to page 1752.

## Stroke adjustment unit mounting diagram

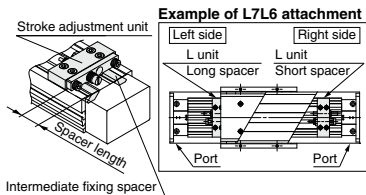

Intermediate fixing spacer

Spacer length

## Example of L7L6 attachment

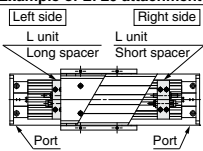

Port

Port

## Shock Absorber Specifications

Model		RB 0806	RB 1007	RB 1412	RB 2015
Max. energy absorption (J)		2.9	5.9	19.6	58.8
Stroke absorption (mm)		6	7	12	15
Max. collision speed (mm/s)		1500			
Max. operating frequency (cycle/min)		80	70	45	25
Spring force (N)	Extended	1.96	4.22	6.86	8.34
	Retracted	4.22	6.86	15.98	20.50
Operating temperature range (°C)		5 to 60			

\* The shock absorber service life is different from that of the MY1□W cylinder depending on operating conditions. Refer to the RB Series Specific Product Precautions for the replacement period.

MY1B

MY1H

MY1B

MY1M

MY1C

MY1H

MY1 HT

MY1 CW

MY2C

MY2 H/HT

MY3A

MY3B

MY3M

D-□

-X□

Technical Data

# MY1□W Series

## Theoretical Output

Bore size (mm)	Piston area (mm <sup>2</sup> )	Operating pressure (MPa)						(N)
		0.2	0.3	0.4	0.5	0.6	0.7	0.8
16	200	40	60	80	100	120	140	160
20	314	62	94	125	157	188	219	251
25	490	98	147	196	245	294	343	392
32	804	161	241	322	402	483	563	643
40	1256	251	377	502	628	754	879	1005
50	1962	392	588	784	981	1177	1373	1569
63	3115	623	934	1246	1557	1869	2180	2492

## Weight

Bore size (mm)	MY1MW			MY1CW			Side support bracket weight (per set)	Stroke adjustment unit weight (per unit)		(kg)
	Basic weight	Additional weight per each 50 mm of stroke	Weight of moving parts	Basic weight	Additional weight per each 50 mm of stroke	Weight of moving parts		Type A and B	A unit weight	L unit weight
16	1.25	0.16	0.54	1.25	0.16	0.57	0.01	0.03	0.04	
20	1.90	0.19	0.75	1.85	0.18	0.78	0.02	0.04	0.05	
25	2.56	0.28	1.00	2.50	0.28	1.02	0.02	0.07	0.11	
32	4.75	0.43	1.71	4.62	0.42	1.76	0.04	0.14	0.23	
40	7.79	0.61	2.56	7.51	0.57	2.64	0.08	0.25	0.34	
50	13.53	0.83	5.19	13.61	0.82	5.27	0.08	0.36	0.51	
63	21.84	1.18	8.23	21.94	1.17	8.50	0.17	0.68	0.83	

Calculation: (Example) **MY1MW25-300A**

- Basic weight..... 2.56 kg
- Cylinder stroke..... 300 stroke
- Additional weight..... 0.28/50 stroke
- $2.56 + 0.28 \times 300/50 + 0.07 \times 2 \approx 4.38$  kg
- Weight of A unit..... 0.07 kg

## Option

### Stroke Adjustment Unit Part No.

**MYM-A 25 L2 - 6N**

Bore size	Stroke adjustment unit	Unit no.
16	16 mm	
20	20 mm	
25	25 mm	
32	32 mm	
40	40 mm	
50	50 mm	
63	63 mm	

Symbol	Stroke adjustment unit	Mounting position
A1	A unit	Left
A2	A unit	Right
L1	L unit	Left
L2	L unit	Right

(Note) Refer to page 1351 for details about adjustment range.

### Intermediate fixing spacer

Nil	Without spacer
6	Short spacer
7	Long spacer

### Spacer delivery type

Nil	Unit installed
N	Spacer only

- Spacers are used to fix the stroke adjustment unit at an intermediate stroke position.
- Spacers are shipped for a set of two.

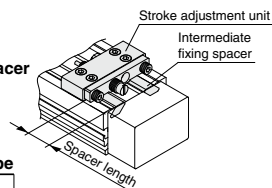

## Component Parts

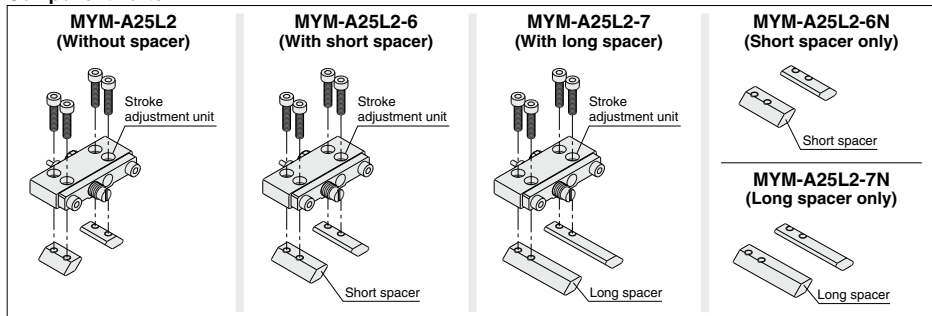

## Side Support Part No.

Bore size (mm)	16	20	25	32	40	50	63
Side support A	MY-S16A	MY-S20A	MY-S25A	MY-S32A	MY-S40A	MY-S63A	
Side support B	MY-S16B	MY-S20B	MY-S25B	MY-S32B	MY-S40B	MY-S63B	

For details about dimensions, etc., refer to page 1358.

A set of side supports consists of a left support and a right support.

# Mechanically Jointed Rodless Cylinder With Protective Cover **MY1□W Series**

## Construction

### MY1□W

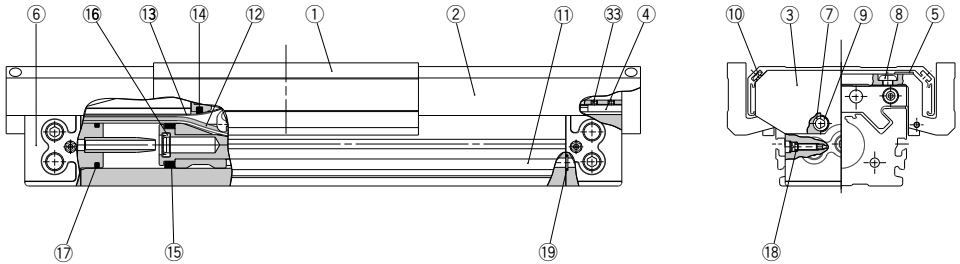

### MY1□WK with side seal

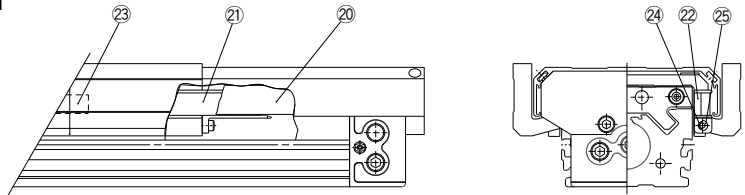

## Component Parts

No.	Description	Material	Note	ø16	ø20	ø25	ø32	ø40	ø50	ø63
1	Slide table	Aluminum alloy	Hard anodized	MYMW-16-Stroke	MYMW-20-Stroke	MYMW-25-Stroke	MYMW-32-Stroke	MYMW-40-Stroke	MYMW-50-Stroke	MYMW-63-Stroke
2	Cover	Aluminum alloy	Hard anodized							
3	End plate	Aluminum alloy	Hard anodized							
4	Belt clamp	Special resin								
5	Slide plate	Special resin								
6	Port cover	Special resin (ø25 to ø40)								
7	Spacer	Stainless steel (ø25 to ø40)								
8	Hexagon socket button head screw	Chromium molybdenum steel	Chromated							
9	Hexagon socket head cap screw	Chromium molybdenum steel	Chromated							
10	Hexagon socket button head screw	Chromium molybdenum steel	Chromated							
11	Rodless cylinder	—	MY1M/MY1C	—	—	—	—	—	—	
21	Seal guide A	Special resin		MYMK-16-A	MYMK-16-A	MYMK-25-A	MYMK-25-A	MYMK-25-A	—	—
22	Seal guide B	Special resin								
23	Slide plate	Special resin								
24	Spacer	Stainless steel								
25	Hexagon socket head cap screw	Chromium molybdenum steel	Chromated							

## Replacement Parts: Seal Kit

No.	Description	Qty.	ø16	ø20	ø25	ø32	ø40	ø50	ø63
12	Seal belt	1	MY16-16A-Stroke	MY20-16A-Stroke	MY25-16A-Stroke	MY32-16A-Stroke	MY40-16A-Stroke	MY50-16A-Stroke	MY63-16A-Stroke
13	Dust seal band <sup>(Note)</sup>	1	MY16-16B-Stroke	MY20-16B-Stroke	MY25-16B-Stroke	MY32-16B-Stroke	MY40-16B-Stroke	MY50-16B-Stroke	MY63-16B-Stroke
18	O-ring	2	KA00309 (ø4 x ø1.8 x ø1.1)	KA00311 (ø5.1 x ø3 x ø1.05)	KA00311 (ø5.1 x ø3 x ø1.05)	KA00320 (ø7.15 x ø3.75 x ø1.7)	KA00402 (ø8.3 x ø4.5 x ø1.9)	KA00777	KA00777
20	Side seal assembly	2	MYMK-16-Stroke	MYMK-20-Stroke	MYMK-25-Stroke	MYMK-32-Stroke	MYMK-40-Stroke	—	—
14	Scraper	2	—	—	—	—	—	—	—
15	Piston seal	2	—	—	—	—	—	—	—
16	Cushion seal	2	MY1M16-PS	MY1M20-PS	MY1M25-PS	MY1M32-PS	MY1M40-PS	MY1M50-PS	MY1M63-PS
17	Tube gasket	2	—	—	—	—	—	—	—
19	O-ring	4	—	—	—	—	—	—	—

Note) Two kinds of dust seal bands are available. Verify the type to use, since the part number varies depending on the treatment of the hexagon socket head set screw 33 (Refer to the Construction of MY1M on pages 1268 and 1269).

A Black zinc chromated → MY□□-16B-Stroke B Nickel plated → MY□□-16BW-Stroke

\* Seal kit includes 14, 15, 16, 17 and 19. Order the seal kit based on each bore size.

\* Seal kit includes a grease pack (10 g).

When 12 and 13 are shipped as single units, a grease pack (10 g per 1000 strokes) is included.

Order with the following part number when only the grease pack is needed. GR-S-010 (10 g), GR-S-020 (20 g)

MY1B

MY1H

MY1B

MY1M

MY1C

MY1H

MY1HT

MY1□W

MY2C

MY2H/HT

MY3A

MY3B

MY3M

D-□

-X□

Technical Data

# MY1□W Series

Dimensions:  $\phi 16, \phi 20$

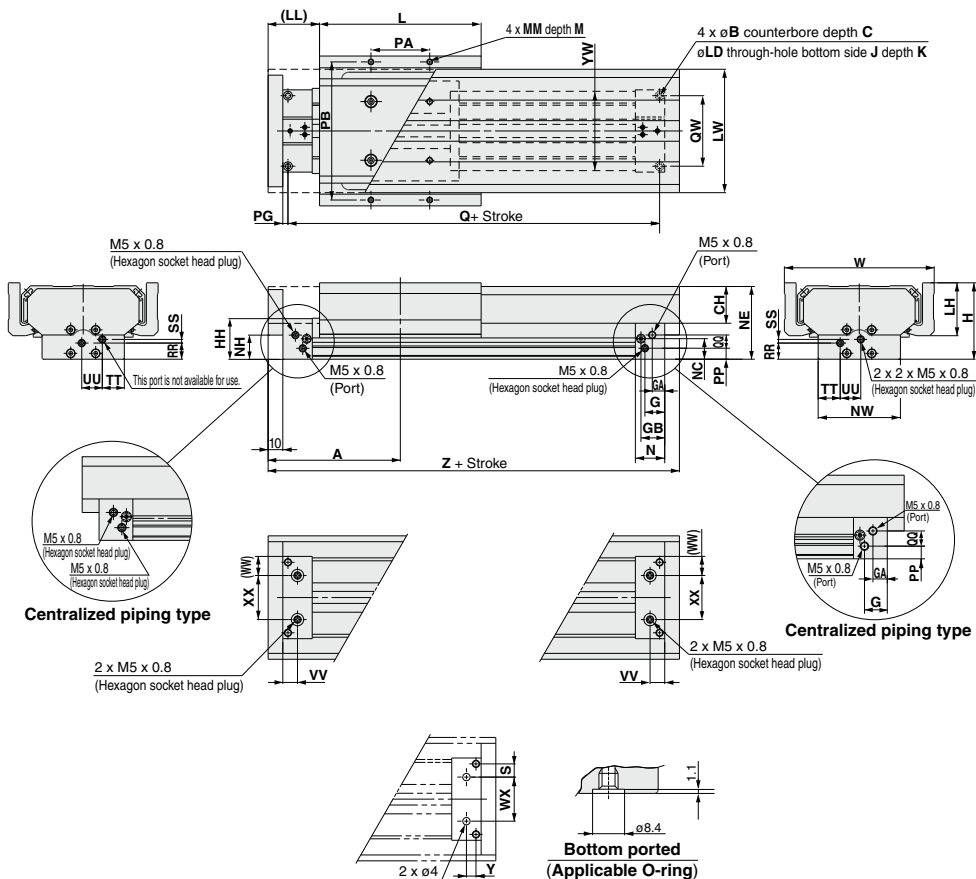

Bore size (mm)	A	B	C	CH	G	GA	GB	H	HH	J	K	L	LD	LH	LL	LW	M	MM	N	NC	NE	NH
16	90	6	3.5	25	13.5	8.5	16.2	52	27.7	M5 x 0.8	10	110	3.6	38	35	84	6	M4 x 0.7	20	14	49.5	16.5
20	110	7.5	4.5	26	12.5	12.5	20	58	33.7	M6 x 1	12	130	4.8	39	45	88	7.5	M5 x 0.8	25	17	55.5	21.7
Bore size (mm)	NW	PA	PB	PG	PP	Q	QQ	QW	RR	SS	TT	UU	VV	W	WW	YW	Z	XX				
16	56	40	94	3.5	7.5	153	9	48	11	2.5	15	14	10	102	13	54	180	30				
20	60	50	100	4.5	11.5	191	10	45	14.5	5	18	12	12.5	110	14	58	220	32				

## Hole Size for Centralized Piping on the Bottom

(Mounting side should be machined to these dimensions.)

Bore size (mm)	S	WX	Y	Applicable O-ring
16	9	30	6.5	C6
20	6.5	32	8	C6



# Mechanically Jointed Rodless Cylinder With Protective Cover **MY1□W Series**

**Dimensions:  $\varnothing 25$ ,  $\varnothing 32$ ,  $\varnothing 40$**

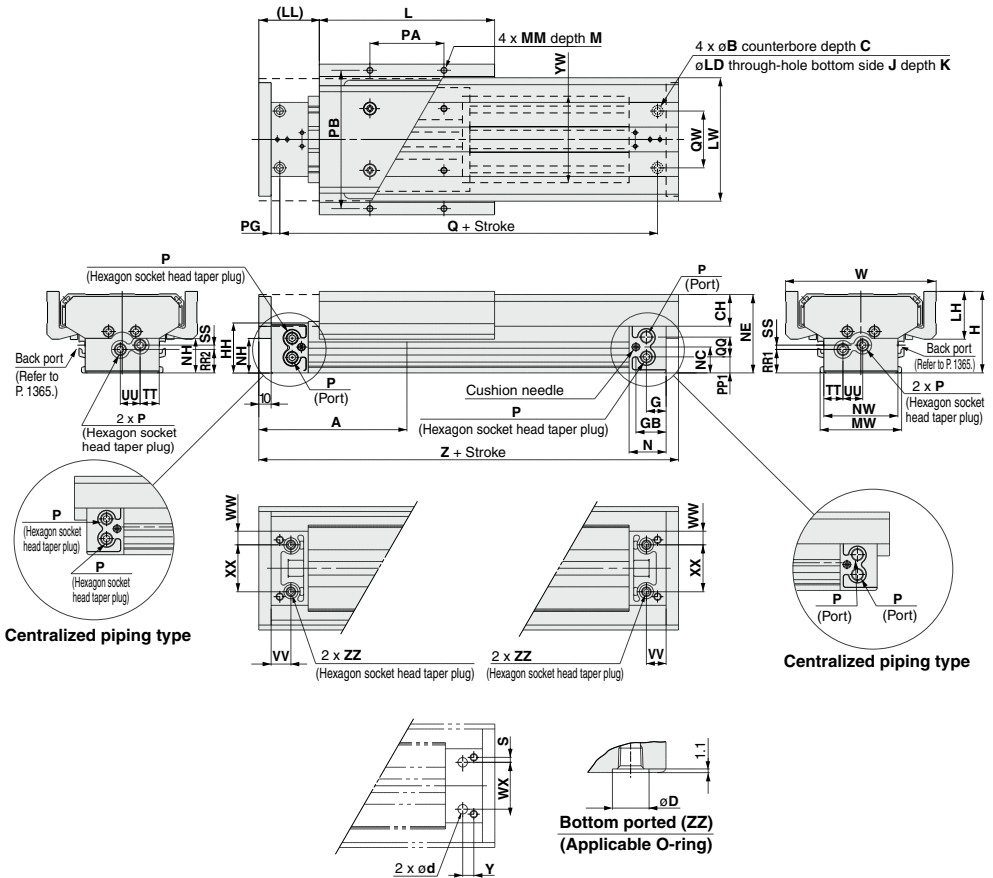

- MY1B
- MY1H
- MY1B
- MY1M
- MY1C
- MY1H
- MY1 HT
- MY1□W
- MY2C
- MY2 H/HT
- MY3A
- MY3B
- MY3M

Bore size (mm)	A	B	C	CH	G	GB	H	HH	J	K	L	LD	LH	LL	LW	M	MM	MW	N	NC	NE	NH
25	120	9	5.5	25.7	17	24.5	66	40.5	M6 x 1	9.5	142	5.6	38.7	49	100	10	M5 x 0.8	66	30	21	64	28
32	150	11	6.5	31.5	19	30	82	50	M8 x 1.25	16	172	6.8	44.2	64	122	13	M6 x 1	80	37	26	80	37
40	180	14	8.5	34.8	23	36.5	98	63.5	M10 x 1.5	15	202	8.6	47.2	79	138	13	M6 x 1	96	45	32	96	48

Bore size (mm)	NW	P	PA	PB	PG	PP1	PP2	Q	QQ	QW	RR1	RR2	SS	TT	UU	VV	W	WW	YW	Z	ZZ	XX
25	60	Rc1/8	60	112	7	12.7	12.7	206	16	46	18.9	17.9	5.1	15.5	16	16	122	11	70	240	Rc1/16	38
32	74	Rc1/8	80	134	8	15.5	18.5	264	16	60	22	24	4	21	16	19	144	13	88	300	Rc1/16	48
40	94	Rc1/4	100	150	9	17.5	20	322	26	72	25.5	29	9	26	21	23	160	20	104	360	Rc1/8	54

**Hole Size for Centralized Piping on the Bottom**  
(Mounting side should be machined to these dimensions.)

Bore size (mm)	D	d	WX	Y	S	Applicable O-ring
25	11.4	6	38	9	4	C9
32	11.4	6	48	11	6	C9
40	13.4	8	54	14	9	C11.2

- D-□
- X□
- Technical Data

# MY1□W Series

Dimensions:  $\phi 50, \phi 63$

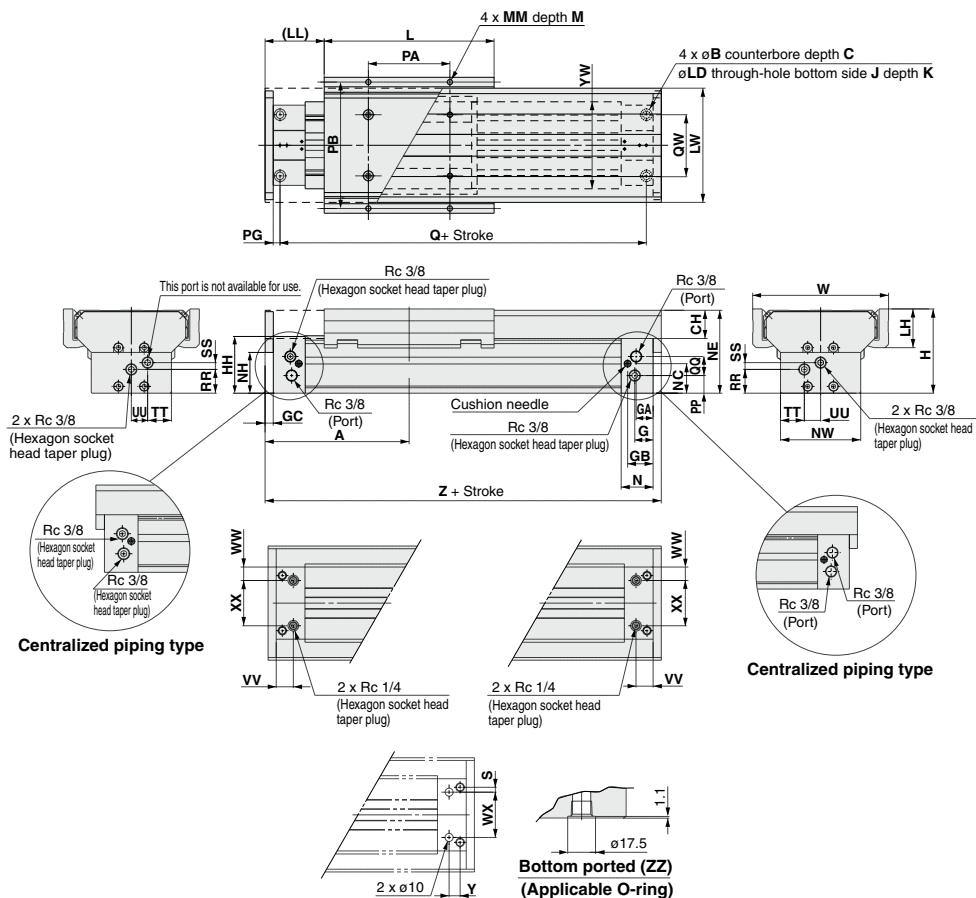

Bore size (mm)	A	B	C	CH	G	GA	GB	GC	H	HH	J	K	L	LD	LH	LL	LW	M	MM	N	NC	NE
50	212	17	10.5	41.5	27	25	37.5	12	124	83.5	M14 x 2	28	250	11	57	87	168	15	M8 x 1.25	47	44	122
63	245	19	12.5	47	29.5	27.5	39.5	15	149	105	M16 x 2	32	290	14	65	100	200	16	M10 x 1.5	50	60	147
Bore size (mm)	NH	NW	PA	PB	PG	PP	Q	QQ	QW	RR	SS	TT	UU	VV	W	WW	YW	Z	XX			
50	60	118	120	186	10	26	380	28	90	35	10	35	24	28	200	22	128	424	74			
63	70	142	140	220	12	42	436	30	110	49	13	43	28	30	236	25	152	490	92			

## Hole Size for Centralized Piping on the Bottom

(Mounting side should be machined to these dimensions.)

Bore size (mm)	S	WX	Y	Applicable O-ring
50	8	74	18	C15
63	9	92	18	C15

### Stroke Adjusting Unit

With adjusting bolt

MY1□W **□** Bore size – **□** Stroke **A**

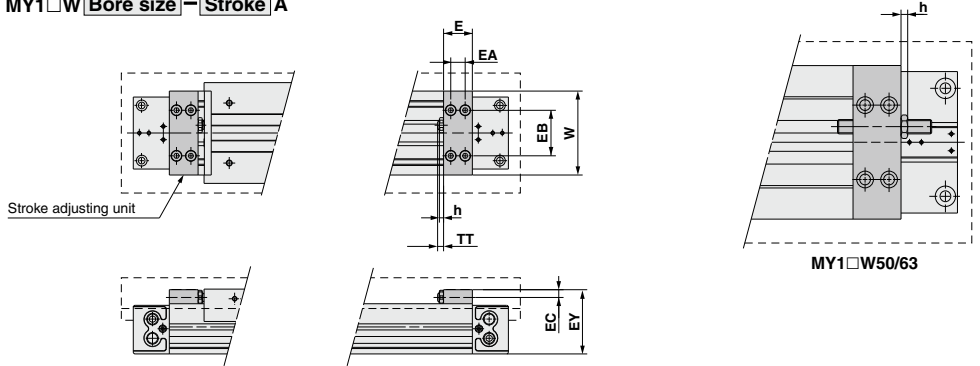

Model	E	EA	EB	EC	EY	h	TT	W
MY1□W16	14.6	7	30	5.8	39.5	3.6	5.4 (Max.11)	58
MY1□W20	20	10	32	5.8	45.5	3.6	5 (Max.11)	58
MY1□W25	24	12	38	6.5	53.5	3.5	5 (Max.16.5)	70
MY1□W32	29	14	50	8.5	67	4.5	8 (Max.20)	88
MY1□W40	35	17	57	10	83	4.5	9 (Max.25)	104
MY1□W50	40	20	66	14	106	5.5	13 (Max.33)	128
MY1□W63	52	26	77	14	129	5.5	13 (Max.39)	152

With low load shock absorber + Adjusting bolt

MY1□W **□** Bore size – **□** Stroke **L**

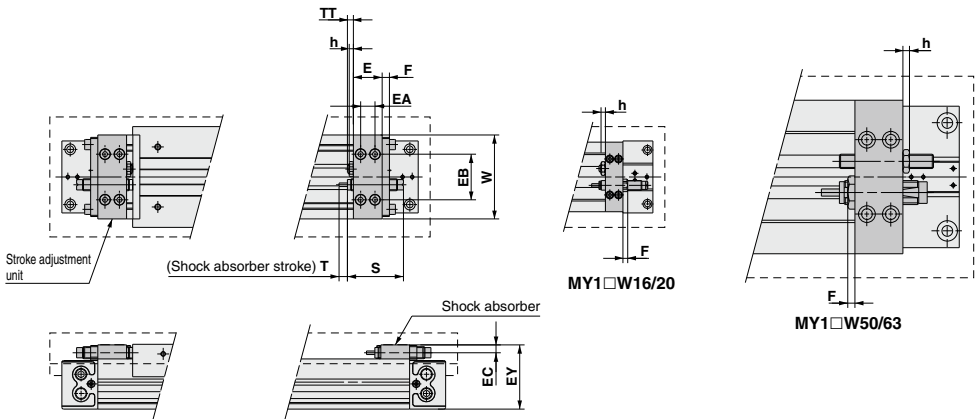

Model	E	EA	EB	EC	EY	F	h	S	T	TT	W	Shock absorber model
MY1□W16	14.6	7	30	5.8	39.5	4	3.6	40.8	6	5.4 (Max.11)	58	RB0806
MY1□W20	20	10	32	5.8	45.5	4	3.6	40.8	6	5 (Max.11)	58	RB0806
MY1□W25	24	12	38	6.5	53.5	6	3.5	46.7	7	5 (Max.16.5)	70	RB1007
MY1□W32	29	14	50	8.5	67	6	4.5	67.3	12	8 (Max.20)	88	RB1412
MY1□W40	35	17	57	10	83	6	4.5	67.3	12	9 (Max.25)	104	RB1412
MY1□W50	40	20	66	14	106	6	5.5	73.2	15	13 (Max.33)	128	RB2015
MY1□W63	52	26	77	14	129	6	5.5	73.2	15	13 (Max.39)	152	RB2015

- MY1B
- MY1H
- MY1B
- MY1M
- MY1C
- MY1H
- MY1 HT
- MY1 □W
- MY2C
- MY2 H/HT
- MY3A
- MY3B
- MY3M

- D-□
- X□
- Technical Data

# MY1□W Series

## Side Support

Side support A  
MY-S□A

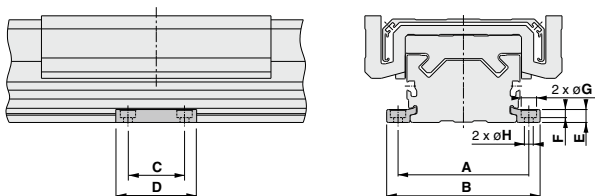

Side support B  
MY-S□B

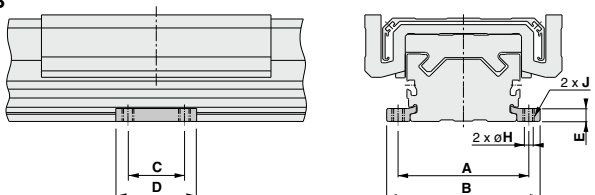

Model	Applicable cylinder	A	B	C	D	E	F	G	H	J
MY-S16 <sup>A</sup> <sub>B</sub>	MY1□W16	61	71.6	15	26	4.9	3	6.5	3.4	M4 x 0.7
MY-S20 <sup>A</sup> <sub>B</sub>	MY1□W20	67	79.6	25	38	6.4	4	8	4.5	M5 x 0.8
MY-S25 <sup>A</sup> <sub>B</sub>	MY1□W25	81	95	35	50	8	5	9.5	5.5	M6 x 1
MY-S32 <sup>A</sup> <sub>B</sub>	MY1□W32	100	118	45	64	11.7	6	11	6.6	M8 x 1.25
MY-S40 <sup>A</sup> <sub>B</sub>	MY1□W40	120	142	55	80	14.8	8.5	14	9	M10 x 1.5
MY-S63 <sup>A</sup> <sub>B</sub>	MY1□W50	142	164	70	100	18.3	10.5	17.5	11.5	M12 x 1.75

\* A set of side supports consists of a left support and a right support.

## Guide for Side Support Application

For long stroke operation, the cylinder tube may be deflected depending on its own weight and the load. In such a case, use a side support in the middle section. The spacing (L) of the support must be no more than the values shown in the graph on the right.

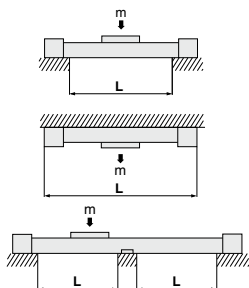

### Caution

- If the cylinder mounting surfaces are not measured accurately, using a side support may cause poor operation. Therefore, be sure to level the cylinder tube when mounting. Also, for long stroke operation involving vibration and impact, use of a side support is recommended even if the spacing value is within the allowable limits shown in the graph.
- Support brackets are not for mounting; use them solely for providing support.

MY1MW

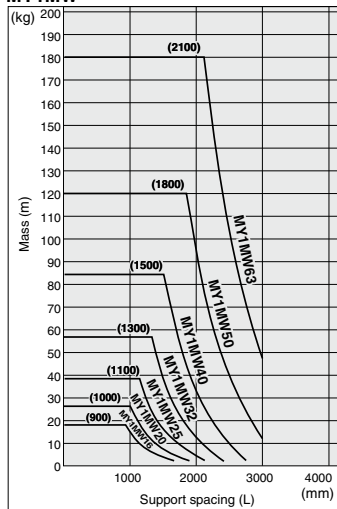

MY1CW

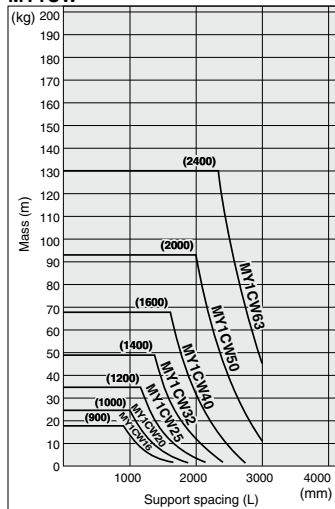

# MY1□W Series Auto Switch Mounting 1

## Proper Auto Switch Mounting Position (Detection at stroke end)

### MY1MW (Slide bearing guide type)

ø16, ø20

ø25, ø32, ø40, ø50, ø63

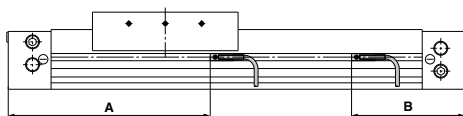
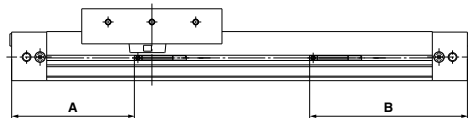

### Proper Auto Switch Mounting Position

(mm)

Bore size (mm)	D-M9□ D-M9□W D-M9□A		D-M9□V D-M9□WV D-M9□AV		D-A9□		D-Y69□/Y7PV D-Y7□WV		D-Z7□/Z80 D-Y59□/Y7P D-Y7□W D-Y7BA	
	A	B	A	B	A	B	A	B	A	B
16	74	86	—	—	70	90	—	—	—	—
20	94	106	—	—	90	110	—	—	—	—
25	144.5	75.5	144.5	75.5	—	—	139.5	80.5	139.5	80.5
32	189.5	90.5	189.5	90.5	—	—	184.5	95.5	184.5	95.5
40	234.5	105.5	234.5	105.5	—	—	229.5	110.5	229.5	110.5
50	283.5	116.5	—	—	—	—	—	—	278.5	121.5
63	328.5	131.5	—	—	—	—	—	—	323.5	136.5

Note 1) Perpendicular electrical entry type and D-Y7BA cannot be mounted on ø16, 20, 50 and 63. Consider using the in-line electrical entry type.  
Note 2) Adjust the auto switch after confirming the operating conditions in the actual setting.

### MY1CW (Cam follower guide type)

ø16, ø20

ø25, ø32, ø40, ø50, ø63

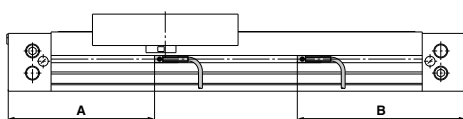
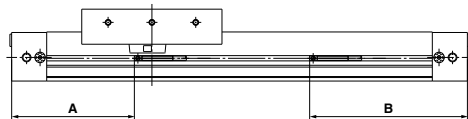

### Proper Auto Switch Mounting Position

(mm)

Bore size (mm)	D-M9□ D-M9□W D-M9□A		D-M9□V D-M9□WV D-M9□AV		D-A9□		D-Y69□/Y7PV D-Y7□WV		D-Z7□/Z80 D-Y59□/Y7P D-Y7□W D-Y7BA	
	A	B	A	B	A	B	A	B	A	B
16	74	86	—	—	70	90	—	—	—	—
20	94	106	—	—	90	110	—	—	—	—
25	102	118	102	118	—	—	97	123	97	123
32	132	148	132	148	—	—	127	153	127	153
40	162.5	177.5	162.5	177.5	—	—	157.5	182.5	157.5	182.5
50	283.5	116.5	—	—	—	—	—	—	278.5	121.5
63	328.5	131.5	—	—	—	—	—	—	323.5	136.5

Note 1) Perpendicular electrical entry type and D-Y7BA cannot be mounted on ø16, 20, 50 and 63. Consider using the in-line electrical entry type.  
Note 2) Adjust the auto switch after confirming the operating conditions in the actual setting.

MY1B

MY1H

MY1B

MY1M

MY1C

MY1H

MY1  
HT

MY1  
□W

MY2C

MY2  
H/HT

MY3A

MY3B

MY3M

D-□

-X□

Technical  
Data

# MY1□W Series

# Auto Switch Mounting 2

(Note) Since the operating range is provided as a guideline including hysteresis, it cannot be guaranteed. (Assuming approximately ±30% dispersion.) It may vary substantially depending on an ambient environment.

## Operating range

### MY1MW (Slide bearing guide type)

(mm)

Auto switch model	Bore size						
	16	20	25	32	40	50	63
D-A9□	11	7.5	—	—	—	—	—
D-M9□/M9□V D-M9□W/M9□WV D-M9□A/M9□AV	7.5	7.5	8.5	8.5	9.5	7	6
D-Z7□/Z80	—	—	12	12	12	11.5	11.5
D-Y59□/Y69□ D-Y7P/Y7PV D-Y7□W/Y7□WV D-Y7BA	—	—	5	5	5	5.5	5.5

Perpendicular electrical entry type and D-Y7BAL cannot be mounted on ø16, 20, 50 and 63. Consider using the in-line electrical entry type.

### MY1CW (Cam follower guide type)

(mm)

Auto switch model	Bore size						
	16	20	25	32	40	50	63
D-A9□	11	7.5	—	—	—	—	—
D-M9□/M9□V D-M9□W/M9□WV D-M9□A/M9□AV	7.5	7.5	7	8	8.5	7	6
D-Z7□/Z80	—	—	12	12	12	11.5	11.5
D-Y59□/Y69□ D-Y7P/Y7PV D-Y7□W/Y7□WV D-Y7BA	—	—	5	5	5	5.5	5.5

Perpendicular electrical entry type and D-Y7BAL cannot be mounted on ø16, 20, 50 and 63. Consider using the in-line electrical entry type.

## Switch Mounting Bracket: Part No.

Auto switch model	Bore size (mm)	
	ø16, ø20	ø25 to ø63
D-M9□/M9□V D-M9□W/M9□WV D-M9□A/M9□AV	—	BMG2-012

ø25 to ø63: M9□(V)/M9□W(V)/M9□A(V)

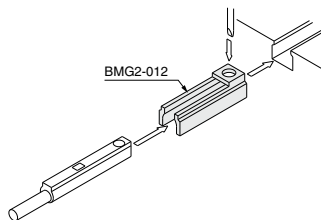

Besides the models listed in How to Order, the following auto switches are applicable. Refer to pages 1263 and 1371 for details. For detailed specifications, refer to pages 1575 to 1701.

Type	Model	Electrical entry (Fetching direction)	Features	Applicable bore size
Solid state auto switch	D-Y69A, Y69B, Y7PV	Grommet (Perpendicular)	—	ø25 to ø40
	D-Y7NWV, Y7PWV, Y7BWV		Diagnostic indication (2-color indicator)	
	D-Y59A, Y59B, Y7P	Grommet (In-line)	—	ø25 to ø63
	D-Y7NW, Y7PW, Y7BW		Diagnostic indication (2-color indicator)	

\* For solid state auto switches, auto switches with a pre-wired connector are also available. Refer to pages 1648 and 1649 for details.

\* Normally closed (NC = b contact) solid state auto switches (D-F9G/F9H/Y7G/Y7H types) are also available. Refer to pages 1593 and 1595 for details.

**Mounting of Auto Switch & Installation of Lead Wire Cover (ø50, ø63)**

**! Caution**

**Be sure to install a lead wire cover on the auto switches for size ø50 and ø63 cylinders.**

Install a lead wire cover following the procedures provided below to prevent the lead wire from interfering with the slider.

Lead wire cover is packaged together with size ø50 and ø63 cylinders equipped with auto switches.

For ordering the lead wire cover separately, use the following part number:

**MYM63GAR6386-1640** (Length: 2 m)

**1. Auto switch mounting position**

Up to 4 auto switches can be mounted on one side of the cylinder (total of 8 switches on both sides).

When multiple auto switches are used, be sure to use the lead wire groove and pull the lead wires out from the edge of the cylinder. (Bold lines in Fig. (1) indicate lead wires.)

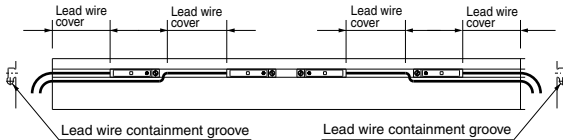

**Fig. (1) Auto switch mounting position**

**2. How to mount auto switch/install lead wire cover**

- 1) Insert and slide in the auto switch from the side of the cylinder and secure it with the screw provided. (Refer to Fig. (2).)
- 2) Cut the lead wire cover to the desired length using a cutter or tube cutter. (Refer to Fig. (1).)
- 3) First place the lead wires into the lead wire cover. Then, install a lead wire cover onto a cylinder body. (Refer to Fig. (3).)
- 4) Make sure that the lead wires do not interfere with the slide table at any stroke range.

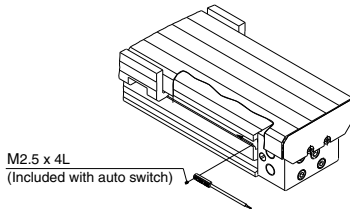

**Fig. (2) Auto switch mounting**

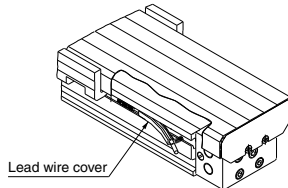

**Fig. (3) Installation of lead wire cover**

MY1B
MY1H
MY1B
MY1M
MY1C
MY1H
MY1 HT
MY1 □W
MY2C
MY2 H/HT
MY3A
MY3B
MY3M

D-□
-X□
Technical Data



# MY1□W Series

## Specific Product Precautions 1

Be sure to read this before handling the products.

Refer to back page 50 for Safety Instructions and pages 3 to 12 for Actuator and Auto Switch Precautions.

### Selection

#### ⚠ Caution

##### 1. When using a cylinder with long strokes, implement an intermediate support.

- When using a cylinder with long strokes, implement an intermediate support to prevent the tube from sagging and being deflected by vibration or an external load. Refer to the Guide for Side Support Application on page 1358.

##### 2. For intermediate stops, use a dual-side pressure control circuit.

- Since the mechanically jointed rodless cylinders have a unique seal structure, slight external leakage may occur. Controlling intermediate stops with a 3 position valve cannot hold the stopping position of the slide table (slider). The speed at the restarting state also may not be controllable. Use the dual-side pressure control circuit with a PAB-connected 3 position valve for intermediate stops.

##### 3. Constant speed

- Since the mechanically jointed rodless cylinders have a unique seal structure, a slight speed change may occur. For applications that require constant speed, select an applicable equipment for the level of demand.

##### 4. Load factor of 0.5 or less

- When the load factor is high against the cylinder output, it may adversely affect the cylinder (condensation, etc.) and cause malfunctions. Select a cylinder to make the load factor less than 0.5. (Mainly when using an external guide)

##### 5. Cautions on less frequent operation

- When the cylinder is used extremely infrequently, operation may be interrupted in order for anchoring and a change lubrication to be performed or service life may be reduced.

##### 6. Consider uncalculated loads such as piping, cableveyor, etc., when selecting a load moment

- Calculation does not include the external acting force of piping, cableveyor, etc. Select load factors taking into account the external acting force of piping, cableveyor, etc.

##### 7. Accuracy

- The mechanical jointed rodless cylinder does not guarantee traveling parallelism. When accuracy in traveling parallelism and a middle position of stroke is required, please consult with SMC.

### Mounting

#### ⚠ Caution

##### 1. To obtain the best results from the cover, horizontal mounting is recommended.

- With horizontal mounting (shown below), the entry of dirt and dust from the bottom of the cover is much less compared to other mounting orientations, making it much more efficient.

Horizontal mounting

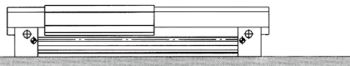

### Mounting

#### ⚠ Caution

##### 2. When the cylinder is mounted from the top side or when strokes are to be adjusted by installing a stroke adjusting unit, the protective cover must be removed for these purposes.

- For detailed assembly step, refer to page 1364.

##### 3. Do not apply a strong impact or moment on the slide table (slider).

- Since the slide table (slider) is supported by precision bearings, do not subject it to strong impact or excessive moment when mounting workpieces.

##### 4. When connecting to a load which has an external guide mechanism, use a discrepancy absorption mechanism.

- A mechanically jointed rodless cylinder can be used with a direct load within the allowable range for each guide type, however, align carefully when connecting to a load with an external guide mechanism.

Mount the external guide mounting brackets and floating brackets in a place where the required degree of freedom for the floating Y and Z axes can be secured.

The thrust transmission area of the floating bracket must be fixed so that it does not partially contact the body.

\*Refer to the Coordinates and Moment in Model Selection on page 1342 for the details of floating Y and Z axes.

##### 5. Do not mount cylinders as they are twisted.

- When mounting, be sure for a cylinder tube not to be twisted. The flatness of the mounting surface is not appropriate, the cylinder tube is twisted, which may cause air leakage due to the detachment of a seal belt, damage a dust seal band, and cause malfunctions.

##### 6. Do not mount a slide table on the fixed equipment surface.

- It may cause damage or malfunctions since an excessive load is applied to the bearing.

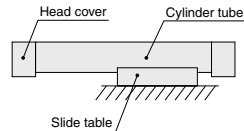

Mounting with a slide table (slider)

##### 7. Consult SMC when mounting in a cantilevered way.

- Since the cylinder body deflects, it may cause malfunctions. Please consult with SMC when using it this way.

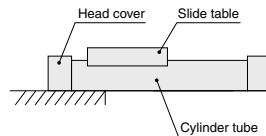

Mounting in a cantilevered way





# MY1□W Series

## Specific Product Precautions 2

Be sure to read this before handling the products.

Refer to back page 50 for Safety Instructions and pages 3 to 12 for Actuator and Auto Switch Precautions.

### Handling

#### ⚠ Caution

- Fixed parts of the cylinder on both ends must have at least 5 mm of contact between where the bottom of the cylinder tube and the equipment surface.

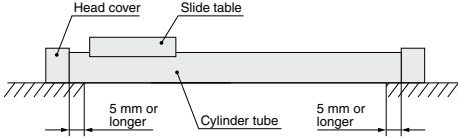

- Do not generate negative pressure in the cylinder tube.

- Take precautions under operating conditions in which negative pressure is generated inside the cylinder by external forces or inertial forces. Air leakage may occur due to separation of the seal belt. Do not generate negative pressure in the cylinder by forcibly moving it with an external force during the trial operation or dropping it with self-weight under the non-pressure state, etc. When the negative pressure is generated, slowly move the cylinder by hand and move the stroke back and forth. After doing so, if air leakage still occurs, please consult with SMC.

- Accuracy

- The mechanical jointed rodless cylinder does not guarantee traveling parallelism. When accuracy in traveling parallelism and a middle position of stroke is required, consult with SMC.

- Cautions on less frequent operation

- When the cylinder is used extremely infrequently, operation may be interrupted in order for anchoring and a change lubrication to be performed or service life may be reduced.

### Handling

#### ⚠ Caution

- Do not unnecessarily alter the guide adjustment setting.

- The adjustment of the guide is preset and does not require readjustment under normal operating conditions. Therefore, do not unnecessarily alter the guide adjustment setting. However, series other than the MY1□W series can be readjusted and their bearings can be replaced. To perform these operations, refer to the bearing replacement procedure given in the operation manual.

- Avoid operation that causes negative pressure inside the cylinder.

- Take precautions under operating conditions in which negative pressure is increased inside the cylinder by external forces or inertial forces. Air leakage may occur due to separation of the seal belt.

- Do not get your hands caught during cylinder operation.

- For the cylinder with a stroke adjusting unit, the space between the slide table and stroke adjusting unit is very small, and your hands may get caught. When operating without a protective cover, be careful not to get your hands caught.

### Operating Environment

#### ⚠ Caution

- Because of floating particles such as paper dust and coolant mist that may enter the inside of the cover.

- Since there is a gap between the bottom of the cover and cylinder tube, take precautions when operating cylinders in environments where there is exposure to excessive amount of floating particles, water/oil splash, or chip spattering. If they enter inside the cover, malfunction may occur.

- Carry out cleaning and grease application suitable for the operating environment.

- Carry out cleaning regularly when using in an operating environment in which the product is likely to get dirty. After cleaning, be sure to apply grease to the top side of the cylinder tube and the rotating part of the dust seal band. Apply grease to these parts regularly even if not after cleaning. Please consult with SMC for the cleaning of the slide table (slider) interior and grease application.

### Service Life and Replacement Period of Shock Absorber

#### ⚠ Caution

- Allowable operating cycle under the specifications set in this catalog is shown below.

- 1.2 million times RB08□□
- 2 million times RB10□□ to RB2725

- Note) Specified service life (suitable replacement period) is the value at room temperature (20 to 25°C). The period may vary depending on the temperature and other conditions. In some cases the absorber may need to be replaced before the allowable operating cycle above.

MY1B

MY1H

MY1B

MY1M

MY1C

MY1H

MY1 HT

MY1 □W

MY2C

MY2 H/HT

MY3A

MY3B

MY3M

D-□

-X□

Technical Data



# MY1□W Series

## Specific Product Precautions 3

Be sure to read this before handling the products.

Refer to back page 50 for Safety Instructions and pages 3 to 12 for Actuator and Auto Switch Precautions.

### Assembly Procedure

#### 1 Component check

Check the components.

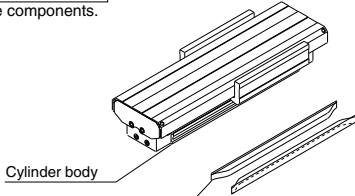

Cylinder body

Side seal assembly  
(Applies to models that come with side seal only)

Note) When auto switches are included with a cylinder order, they are packaged together with the cylinder.

#### 2 Body mounting procedures

##### 1. Removal of cover

Remove the hexagon socket head button bolts and cover.

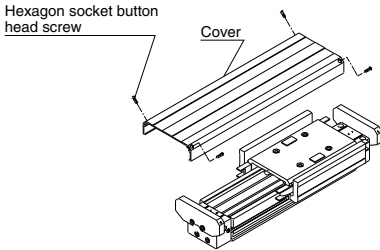

Hexagon socket button head screw

Cover

##### 2. Body mounting/adjustment

Mount the cylinder body.

For cylinders with protective cover only (i.e., without side seal), reinstall the cover after the cylinder is mounted and adjusted. (Refer to Step 3-3 "Cover installation".)

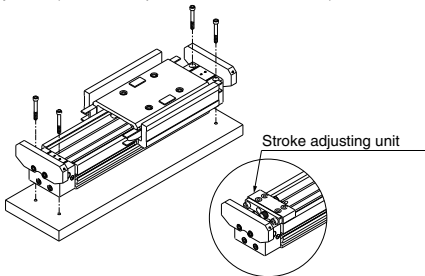

Stroke adjusting unit

Note) The adjustment of the stroke adjusting unit (optional) should also be done at this time.

#### 3 Side seal installation procedures

##### 1. Temporary cover installation

- 1) Remove the hexagon socket head cap screws and one of the end plates.
- 2) Place the cover and temporarily secure it with the hexagon socket button head bolts.

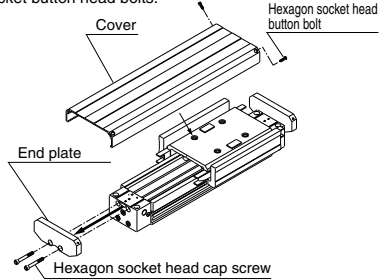

Cover

Hexagon socket head button bolt

End plate

Hexagon socket head cap screw

##### 2. Side seal installation

Slide the side seal assembly into the place from one end of the cylinder.

Stainless steel portions of the side seal assembly are very sharp. Take extra precautions when handling.

Note) Move the slide table to the end of the insertion side.

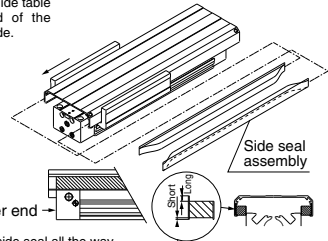

Side seal assembly

Head cover end

Note) Slide the side seal all the way to the end of the head cover.

Note) Make sure the side seal assembly is facing in the right direction.



# MY1□W Series

## Specific Product Precautions 4

Be sure to read this before handling the products.

Refer to back page 50 for Safety Instructions and pages 3 to 12 for Actuator and Auto Switch Precautions.

### Assembly Procedure

#### 4 Side seal installation procedures (Continued)

##### 3. Cover installation

\* Be sure to confirm Note 1) and Note 2). (When adjustment is not correctly done, it may cause malfunctions and parts damage (cover collision).)

- 1) The end plate is fixed with hexagon socket head cap screws.
- 2) The cover is fixed with hexagon socket button head screws.

Hexagon socket button head screw

Cover tightening torque [N·m]

Bore	Thread size	Torque
φ16 to φ40	M3	0.6
φ50, φ63	M4	1.4

End plate

Note 1) Do not move the end plate upward inadvertently.

Hexagon socket head cap screw

End plate tightening torque [N·m]

Bore	Thread size	Torque
φ16	M3	0.7
φ20	M4	1.8
φ25	M5	3.5
φ32	M6	5.8
φ40	M6	5.8
φ50	M8	14
φ63	M10	28

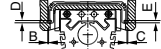

Note 2) If there is no gap (clearance) between the slide table and cover (B, C and D, E in the drawing above) throughout the stroke range, loosen the hexagon socket head cap screw to fix the end plate, then retighten it after adjusting the end plate position.

### Centralized Piping Port Variations

#### ⚠ Caution

- Head cover piping connection can be freely selected to best suit different piping conditions.

Applicable cylinder	Port variation
<b>MY1MW16, 20, 50, 63</b> <b>MY1CW16, 20, 50, 63</b>	<p>This port cannot be used. (Except φ50)</p> <p>Slide table operating direction</p>
<b>MY1MW25, 32, 40</b> <b>MY1CW25, 32, 40</b>	<p>This port cannot be used. (Except φ32, φ40)</p> <p>Slide table operating direction</p>

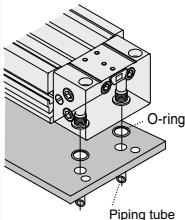

For bottom piping, refer to the figure above.

MY1B

MY1H

MY1B

MY1M

MY1C

MY1H

MY1HT

MY1□W

MY2C

MY2H/HT

MY3A

MY3B

MY3M

D-□

-X□

Technical Data