

Air Slide Table

MXW Series

ø8, ø12, ø16, ø20, ø25

RoHS

Linear guide table provides long stroke.
Table rigidity is constant throughout entire stroke.

Long stroke (Max. 300 mm)

Linear guide provides long stroke,
and it obtains smooth operation without vibration.

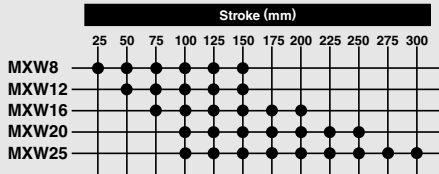

Dual piston rod

• Slim design provides 2 times the force of standard cylinder.

MXW8: ø8 x 2 MXW20: ø20 x 2
MXW12: ø12 x 2 MXW25: ø25 x 2
MXW16: ø16 x 2

Shock absorber

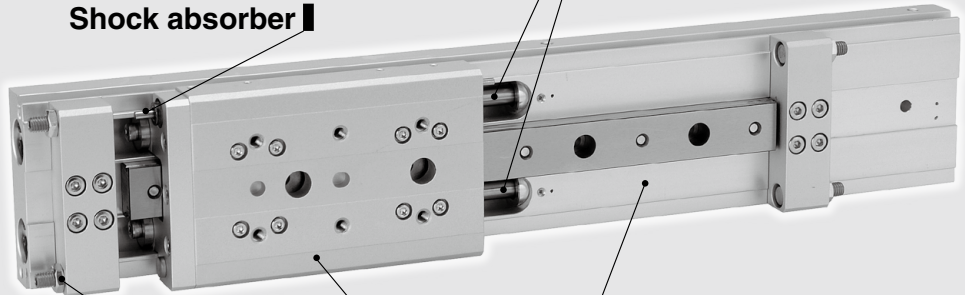

Table for mounting of workpiece

Body mounting

Stroke adjuster

Piping, Wiring

- Piping is possible from 2 directions.
- Can pipe and wire switches from the same surface.
- Auto switch can be attached to either side of body.

Lateral piping/wiring



Axial piping

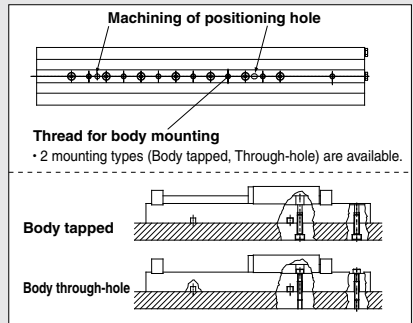
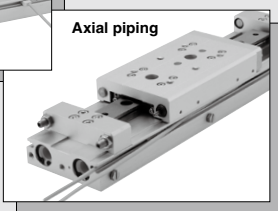

- MXH
- MXS
- MXQ
- MXQ
- MXF
- MXW
- MXJ
- MXP
- MXY
- MTS

- D-□
- X□

MXW Series Model Selection

Selection

⚠ Caution

① Operate loads within the range of the operating limits.

Select the model from the maximum allowable load and allowable moment. For details, refer to the following selection procedures. When actuator is used outside of operating limit, eccentric loads on the guide in excess, will cause vibration on guide, inaccuracy and shorten its life.

② If intermediate stops by external stopper are done, avoid ejection.

If ejection occurs, it may cause damage. In the case slide table is stopped at intermediate positions by the external stopper then forwarded to the front, after slide table is returned to the back for just a moment to retract the stopper, supply pressure to the opposite port to operate slide table.

③ Do not use it in such a way that excessive external force or impact force could work on it.

This could result in damage.

Maximum allowable load and allowable moment will vary depending on workpiece mounting methods, mounting orientation and operating speed. In making a determination of usability, the load mass and moment should be within the operating range of the graph with respect to operating conditions and the total ($\Sigma\alpha n$) of the load factors (αn) for load mass and moment should not exceed 1.

$$\Sigma\alpha n = \frac{\text{Load (W)}}{\text{Maximum load mass (Wmax)}} + \frac{\text{Static moment (M)}}{\text{Allowable static moment (Mmax)}} + \frac{\text{Dynamic moment (Me)}}{\text{Allowable dynamic moment (Memax)}} < 1$$

Wmax, Mmax and Memax values are according to graph (1), (2) and (3) below.

Load Weight

Maximum Load

Model	W (kg)
MXW8	1.8
MXW12	4
MXW16	7
MXW20	11
MXW25	17

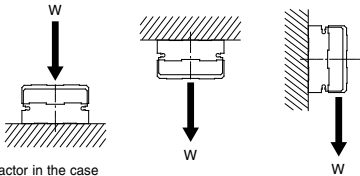

Note) No need to consider this load factor in the case of using perpendicularly in a vertical position.

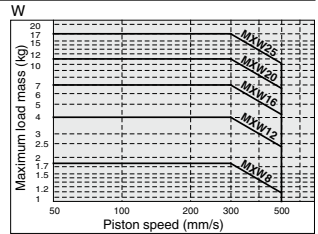

Graph (1)

Moment

Allowable Moment

(Static moment/Dynamic moment)

Model	(N·m)		
	Pitch moment Mp/Mep	Yaw moment My/Mey	Roll moment Mr
MXW8	5	5	3
MXW12	10	10	6
MXW16	20	20	12
MXW20	40	40	25
MXW25	110	110	65

Mp/Mep (Pitch moment) My/Mey (Yaw moment)

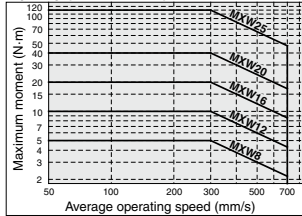

Graph (2)

Mr (Roll moment)

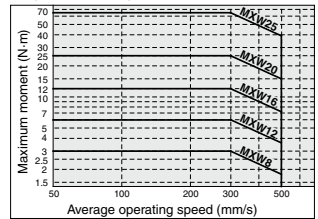

Graph (3)

Static Moment

Moment generated by the workpiece weight even when the cylinder is stopped

■ Pitch moment

$$M_p = W \times 9.8 (L_1 + A)$$

A1: Moment center position distance compensation amount (mm)

MXW8	39
MXW12	48
MXW16	58
MXW20	75
MXW25	97

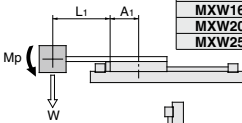

■ Yaw moment

$$M_y = W \times 9.8 (L_2 + B)$$

B1: Moment center position distance compensation amount (mm)

MXW8	23
MXW12	29
MXW16	37
MXW20	49
MXW25	63

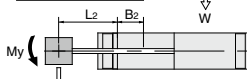

A2: Moment center position distance compensation amount (mm)

MXW8	10
MXW12	10
MXW16	14
MXW20	20
MXW25	28

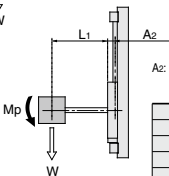

■ Roll moment

$$M_r = W \times 9.8 (L_3 + C)$$

C1: Moment center position distance compensation amount (mm)

MXW8	10
MXW12	10
MXW16	14
MXW20	20
MXW25	28

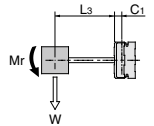

C2: Moment center position distance compensation amount (mm)

MXW8	23
MXW12	29
MXW16	37
MXW20	49
MXW25	63

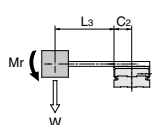

Dynamic Moment Moment due to impact of load at end of stroke.

$$We = \delta \cdot W \cdot V$$

$$V = 1.4 \cdot Va$$

*) Correction factor (Reference value)

We: Equivalent mass for impact (kg)
 δ : Bumper coefficient
 With urethane bumper (standard) = 4/100
 With shock absorber = 1/100
 W: Weight (kg)
 V: Collision speed (mm/s)
 Va: Average operating speed (mm/s)

■ Pitch moment

$$Mep = 1/3 \cdot We \times 9.8 (L_3 + C)$$

*) Average load coefficient

C: Moment center position distance compensation amount (mm)

MXW8	10
MXW12	10
MXW16	14
MXW20	20
MXW25	28

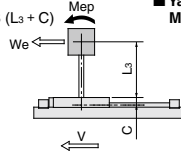

■ Yaw moment

$$Mey = 1/3 \cdot We \times 9.8 (L_2 + B)$$

B: Moment center position distance compensation amount (mm)

MXW8	23
MXW12	29
MXW16	37
MXW20	49
MXW25	63

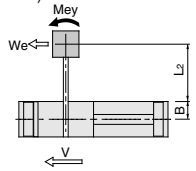

Selection Calculation

For selection of a proper model, the items shown below should be within the operating range of the graph. Furthermore, find load factors (αn) and make sure that their sum total ($\sum \alpha n$) does not exceed 1.

$$\sum \alpha n = \alpha_1 + \alpha_2 + \alpha_3 < 1$$

Item	Load factor αn	Note
1 Max. load mass	$\alpha_1 = W/W_{max}$	Examine W . W_{max} is maximum load mass at V_a .
2 Static moment	$\alpha_2 = M/M_{max}$	Examine M_p , M_y , and M_r . M_{max} is the allowable moment for V_a .
3 Dynamic moment	$\alpha_3 = M_e/M_{e_{max}}$	Examine M_{ep} and M_{ey} . $M_{e_{max}}$ is the allowable moment for V_a .

V: Collision speed, V_a : Average speed

<Operating conditions>

Cylinder: MXW16
 Cushion: Standard (Urethane bumper)
 Mounting: Horizontal wall mounting
 Average operating speed: $V_a = 300$ [mm/s]
 Weight: $W = 1$ [kg]
 $L_3 = 50$ [mm]
 $L_2 = 50$ [mm]

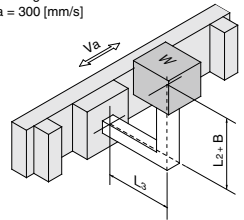

- MXH
- MXS
- MXQ
- MXQ
- MXF
- MXW
- MXJ
- MXP
- MXY
- MTS

Item	Load factor αn	Note
1 Max. load mass	$\alpha_1 = W/W_{max}$ $= 1/7$ $= 0.14$	Examine W . Find the value of W_{max} when $V_a = 300$ mm/s from Graph (1). Note) No need to consider this load factor in the case of using perpendicularly in a vertical position. (Define $\alpha_1 = 0$.)
2 Static moment	$M_r = W \times 9.8 (L_3 + C)$ $= 1 \times 9.8 (0.05 + 0.014)$ $= 0.63$ [N·m] $\alpha_2 = M_r/M_{r_{max}}$ $= 0.63/12$ $= 0.053$	Examine M_r . (M_p , M_y values do not apply to this example.) $M_{r_{max}}$ value is from Graph (3) at $V_a = 300$ mm/s.
3 Dynamic moment	$M_{ey} = 1/3 \cdot We \times 9.8 (L_2 + B)$ $V = 1.4 V_a$ $We = \delta \cdot W \cdot V$ $= 4/100 \cdot 1 \cdot 1.4 \cdot 300$ $= 16.8$ [kg] $\therefore M_{ey} = 1/3 \times 16.8 \times 9.8 (0.05 + 0.037)$ $= 4.8$ [N·m] $\alpha_3 = M_{ey}/M_{ey_{max}}$ $= 4.8/14.3$ $= 0.34$	Examine M_{ey} . Find the equivalent mass for impact, W . Bumper coefficient $\delta = 4/100$ (With urethane bumper) $M_{ey_{max}}$ value is from Graph (2) at $V = 1.4 V_a = 420$ mm/s.
	$M_{ep} = 1/3 \cdot We \times 9.8 (L_3 + C)$ $= 1/3 \cdot 16.8 \times 9.8 (0.05 + 0.014)$ $= 3.5$ [N·m] $\alpha_3' = M_{ep}/M_{ep_{max}}$ $= 3.5/14.3$ $= 0.24$	Examine M_{ep} . From above formula $We = 16.8$ $M_{ep_{max}}$ value is from Graph (2) at $V = 1.4 V_a = 420$ mm/s.

$$\sum \alpha n = \alpha_1 + \alpha_2 + \alpha_3 + \alpha_3'$$

$$= 0.14 + 0.053 + 0.34 + 0.24$$

$$= 0.773 \quad \sum \alpha n = 0.773 < 1, \text{ Application is approved.}$$

- D-□
- X□

Air Slide Table MXW Series

RoHS

How to Order

MXW **16** — **100** **B** — **M9BW** — —

● **Port thread type**

Nil	M thread	ø8 to ø16
	Rc	
TN	NPT	ø20, ø25
TF	G	

● **Bore size (Stroke (mm))**

ø8	25, 50, 75, 100, 125, 150
ø12	50, 75, 100, 125, 150
ø16	75, 100, 125, 150, 175, 200
ø20	100, 125, 150, 175, 200, 225, 250
ø25	100, 125, 150, 175, 200, 225, 250, 275, 300

● **Made to Order**
Refer to page 285 for details.

● **Number of auto switches**

Nil	2 pcs.
S	1 pc.
n	"n" pcs.

● **Auto switch**

Nil	Without auto switch (Built-in magnet)
-----	---------------------------------------

* For the applicable auto switch model, refer to the table below.

● **Option**

Nil	Standard (with urethane bumper)
B	With shock absorbers 2 pcs.

Applicable Auto Switches

Refer to pages 1119 to 1245 for the detailed specifications of auto switches.

Type	Special function	Electrical entry	Indicator light	Wiring (Output)	Load voltage		Auto switch model		Lead wire length (m)				Pre-wired connector	Applicable load		
					DC	AC	Perpendicular	In-line	0.5 (Nil)	1 (M)	3 (L)	5 (Z)		IC circuit	Relay, PLC	
Solid state auto switch	—	Grommet	Yes	3-wire (NPN)	24 V	—	M9NV	M9N	●	●	●	○	○	IC circuit	Relay, PLC	
				3-wire (PNP)			5 V, 12 V	M9PV	M9P	●	●	●	○			○
				2-wire			12 V	M9BV	M9B	●	●	○	○			○
				3-wire (NPN)			5 V, 12 V	M9NVW	M9NW	●	●	●	○			○
	Diagnostic indication (2-color indicator)			3-wire (PNP)	12 V	M9PVW	M9PW	●	●	●	○	○	IC circuit			
				2-wire	—	M9BWW	M9BW	●	●	○	○	○				
				3-wire (NPN)	5 V, 12 V	M9NAV *1	M9NA *1	○	○	●	○	○		IC circuit		
				3-wire (PNP)	—	M9PAV *1	M9PA *1	○	○	●	○	○				
Water resistant (2-color indicator)	2-wire	12 V	M9BAV *1	M9BA *1	○	○	●	○	○	—						
	—	—	—	—	—	—	—	—	—	—						
Reed auto switch	—	Grommet	Yes	3-wire (Equiv. to NPN)	—	5 V	—	A96V	A96	●	—	—	—	IC circuit	—	
				2-wire	24 V	12 V	100 V	A93V *2	A93	●	●	●	—	—	Relay, PLC	
					100 V or less	A90V	A90	●	—	●	—	—	—	IC circuit		

*1 Water resistant type auto switches can be mounted on the above models, but in such case SMC cannot guarantee water resistance.

*2 1 m type lead wire is only applicable to D-A93.

* Lead wire length symbols: 0.5 m..... Nil (Example) M9NW
 1 m..... M (Example) M9NWM
 3 m..... L (Example) M9NWL
 5 m..... Z (Example) M9NWZ

* Solid state auto switches marked with "○" are produced upon receipt of order.

* Since there are other applicable auto switches than listed, refer to page 301 for details.
 * For details about auto switches with pre-wired connector, refer to pages 1192 and 1193.
 * Auto switches are shipped together (not assembled).

Specifications



Model	MXW8	MXW12	MXW16	MXW20	MXW25
Bore size (mm)	ø8 x 2 (ø11 or its equivalent)	ø12 x 2 (ø17 or its equivalent)	ø16 x 2 (ø23 or its equivalent)	ø20 x 2 (ø28 or its equivalent)	ø25 x 2 (ø35 or its equivalent)
Piping port size	M5 x 0.8			Rc 1/8	
Fluid	Air				
Action	Double acting				
Operating pressure	0.15 to 0.7 MPa				
Proof pressure	1.05 MPa				
Ambient and fluid temperature	-10 to +60°C				
Operating speed range (Average operating speed) ^{Note)}	50 to 500 mm/s				
Cushion	Both ends urethane bumper (Standard) Shock absorber at both ends (Option)				
Lubrication	Non-lube				
Auto switch (Option)	Reed auto switch Solid state auto switch (2-wire, 3-wire) 2-color indicator solid state auto switch (2-wire, 3-wire)				
Stroke length tolerance	+1 0 mm				
Stroke adjustment range	One side: 5 mm (Both sides: 10 mm)				

(None) Average operating speed: Speed that the stroke is divided by a period of time from starting the operation to reaching the end.

<Operating direction>
When viewed from side
with lateral ports.
R: Right (OUT side)
L: Left (IN side)

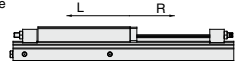

Made to Order: Individual Specifications

(For details, refer to pages 302 and 303.)

Symbol	Specifications
-X7	PTFE grease
-X9	Grease for food processing machines
-X11	Adjusting bolt, long specification (Adjustment range: 15 mm)
-X33	Without built-in auto switch magnet
-X39	Fluororubber seal
-X42	Anti-corrosive specifications for guide unit
-X45	EPDM seal

Theoretical Output

Dual rod cylinder produces double the thrust of standard cylinder.

(N)

Bore size (mm)	Rod size (mm)	Operating direction	Piston area (mm ²)	Operating pressure (MPa)					
				0.2	0.3	0.4	0.5	0.6	0.7
8	4	R	101	20	30	40	51	61	71
		L	75	15	23	30	38	45	53
12	6	R	226	45	68	90	113	136	158
		L	170	34	51	68	85	102	119
16	8	R	402	80	121	161	201	241	281
		L	302	60	91	121	151	181	211
20	10	R	628	126	188	251	314	377	440
		L	471	94	141	188	236	283	330
25	12	R	982	196	295	393	491	589	687
		L	756	151	227	302	378	454	529

(Note) Theoretical output (N) = Pressure (MPa) x Piston area (mm²)

Standard Stroke (mm)/Weight (g)

Model	Standard stroke (mm)												Additional weight of option Shock absorber
	25	50	75	100	125	150	175	200	225	250	275	300	
MXW8	550	610	700	790	880	980	—	—	—	—	—	—	15
MXW12	—	930	1010	1140	1270	1400	—	—	—	—	—	—	15
MXW16	—	—	1850	1970	2150	2350	2540	2740	—	—	—	—	20
MXW20	—	—	—	4440	4640	5000	5360	5710	6070	6430	—	—	65
MXW25	—	—	—	9300	9620	9970	10500	11100	11700	12200	12800	13400	140

Moisture Control Tube IDK Series



When operating an actuator with a small diameter and a short stroke at a high frequency, the dew condensation (water droplet) may occur inside the piping depending on the conditions.

Simply connecting the moisture control tube to the actuator will prevent dew condensation from occurring. For details, refer to [the IDK series in the Best Pneumatics No. 6](#).

MXH

MXS

MXQ

MXQ

MXF

MXW

MXJ

MXP

MXV

MTS

D-□

-X□

The graphs below show the table displacement when the static moment load is applied to the table.
The graphs do not show the loadable mass. Refer to the Model Selection for the loadable mass.

Table Deflection (Reference Values)

Table displacement due to pitch moment load

Amount of displacement on A when the load is applied at F.

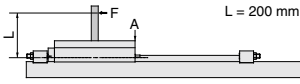

Table displacement due to yaw moment load

Amount of displacement on A when the load is applied at F.

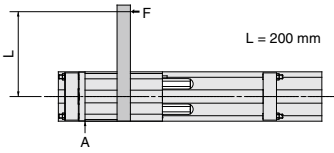
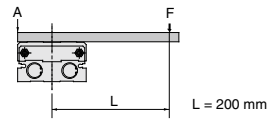
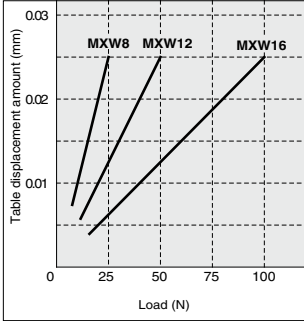

Table displacement due to roll moment load

Amount of displacement on A when the load is applied at F.



MXW8, MXW12, MXW16



MXW8, MXW12, MXW16

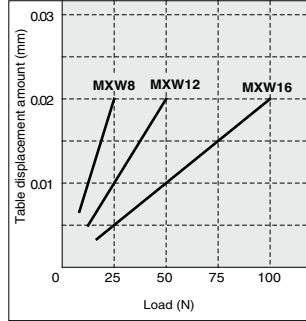

MXW8, MXW12, MXW16

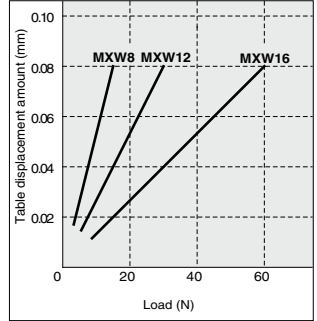

MXW20, MXW25

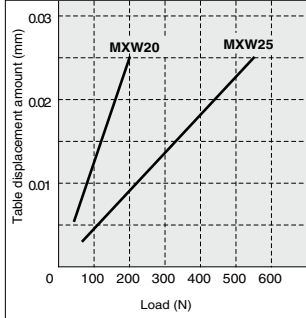

MXW20, MXW25

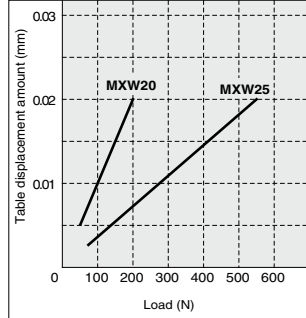

MXW20, MXW25

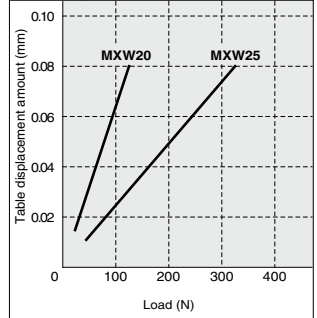

Option Specifications

Stopper Bolt Assembly

Stopper bolt assembly can be ready for the following manner.

Change of adjuster assembly		Qty. needed for stopper bolt assembly		Parts to be Changed (Refer to the figure below.)
		Standard	Semi-standard (-X11)	
Changing the stroke adjustment range from 5 mm to 15 mm for one side	W/o shock absorber	—	2	Replace (A)
	With shock absorber	—	4	Replace (A)(B)
Changing to the one with shock absorber		2	—	Add (B)
Changing to the one with shock absorber and stroke adjustment range of 15 mm		—	4	Replace (A)
				Add (B)

Note 1) When only one side of stroke is changed, the quantity needed is the half of the above.

Note 2) Shock absorber must be ordered separately.

For the shock absorber model numbers, refer to page 288.

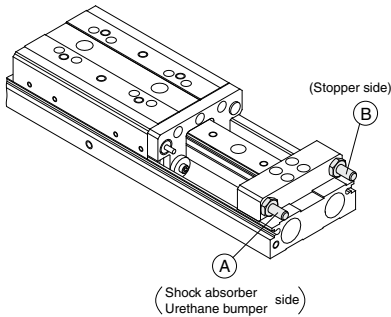

Dimensions

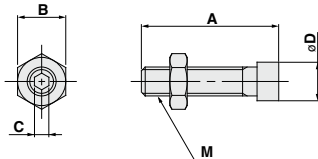

Applicable size	Model	Stroke adjustable range (mm)	A	B	C	D	M
MXW8	MXW-A812	5	21	8	2.5	6	M5 x 0.5
	MXW-A812-X11	15	31				
MXW12	MXW-A1212	5	23.5	8	2.5	6	M5 x 0.8
	MXW-A1212-X11	15	33.5				
MXW16	MXW-A1612	5	28.5	10	3	8	M6 x 1
	MXW-A1612-X11	15	38.5				
MXW20	MXW-A2012	5	34.5	13	4	10	M8 x 1.25
	MXW-A2012-X11	15	44.5				
MXW25	MXW-A2512	5	40	17	5	14	M10 x 1.5
	MXW-A2512-X11	15	50				

How to Order Stopper Bolt Assembly

MXW - A 16 12 - X11

Applicable bore size

8	ø8
12	ø12
16	ø16
20	ø20
25	ø25

Adjustment range

Nil	5 mm	Standard
X11	15 mm	Option

Note 1) The above model number is one adjuster bolt assembly only.

⚠ Precautions

Mounting/Adjustment

⚠ Caution

① Do not operate within 1 mm.

The effectiveness of the shock absorber and urethane bumper will not be brought into full play, and could be adversely affected.

How to mount

1. Thread in the adjuster bolt from the direction of the arrow.
2. Fasten the lock nut from the direction of the arrow.

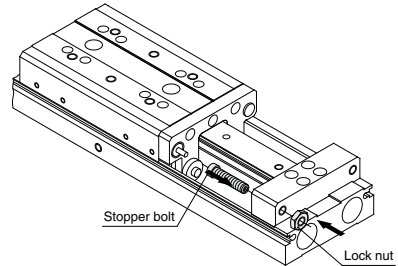

Avoid operating within 1 mm.

The effectiveness of the shock absorber and urethane damper will not be brought into full play, and could be adversely affected.

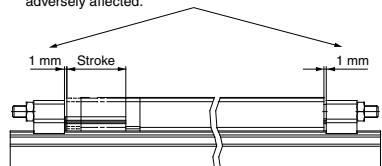

MXH

MXS

MXQ □

MXQ

MXF

MXW

MXJ

MXP

MXY

MTS

D-□

-X□

MXW Series

Option Specifications

Shock Absorber

Specifications

Shock absorber model	RB0805 -X552	RB0806 -X552	RB1007 -X552	RB1412 -X552	RB2015 -X552	
Applicable slide table	MXW8	MXW12	MXW16	MXW20	MXW25	
Max. absorbing energy (J)	0.98	2.94	5.88	19.6	58.8	
Stroke absorption (mm)	5	6	7	12	15	
Max. collision speed (m/sec)	0.05 to 5					
Max. operating frequency (cycle/min)	80	80	70	45	25	
Max. allowable thrust (N)	245	245	422	814	1961	
Ambient temperature range (°C)	-10 to 80					
Spring force (N)	Extended	1.96	1.96	4.22	6.86	8.34
	Retracted	3.83	4.22	6.86	15.98	20.50
Weight (g)	15	15	25	65	150	

Note) The shock absorber service life is different from that of the MXW cylinder depending on operating conditions. Refer to the Specific Product Precautions for the replacement period.

How to Replace

① How to Remove

Shock adjuster block *

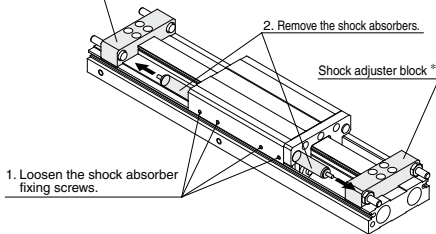

* In the case of MXW8-25, first take out the adjuster block, and then the shock absorber. Tighten the mounting bolt with the torque 0.3 N·m when assembling the adjuster block.

② How to Mount

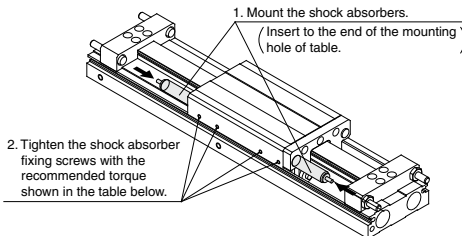

Recommended Tightening Torque

Model	Shock absorber fixing thread size	Recommended tightening torque (N·m)	Hexagon wrench width across flats (mm)
MXW8	M3 x 4	0.6	1.5
MXW12	M3 x 4	0.6	1.5
MXW16	M3 x 4	0.6	1.5
MXW20	M4 x 5	0.8	2
MXW25	M5 x 6	1	2.5

⚠ Precautions

Adjustment

⚠ Caution

- Do not operate in such a state that the stopper blocks and stopper bolts on both sides are removed.

Doing so could create shocks, which could loosen and cause damage.

Stroke adjustment

1. Standard

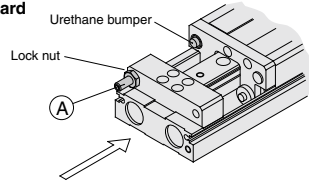

Loosen the stopper bolt lock nut on side (A), insert a wrench in the direction of the arrow to adjust the stroke, and then tighten the lock nut.

2. With shock absorber (Option)

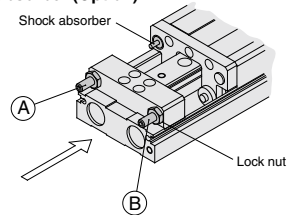

Stroke adjustment

- Loosen the stopper bolt lock nut on side (B), insert a wrench in the direction of the arrow to adjust the stroke, and then tighten the lock nut.

Stroke absorption adjustment for shock absorber

- Loosen the stopper bolt lock nut on side (A), insert a wrench in the direction of the arrow to adjust the stroke, and then tighten the lock nut.

Service Life and Replacement Period of Shock Absorber

⚠ Caution

1. Allowable operating cycle under the specifications set in this catalog is shown below.

- 1.2 million cycles RB08□□
- 2 million cycles RB1007 to RB2015

Note) Specified service life (suitable replacement period) is the value at room temperature (20 to 25°C). The period may vary depending on the temperature and other conditions. In some cases the absorber may need to be replaced before the allowable operating cycle above.

Construction

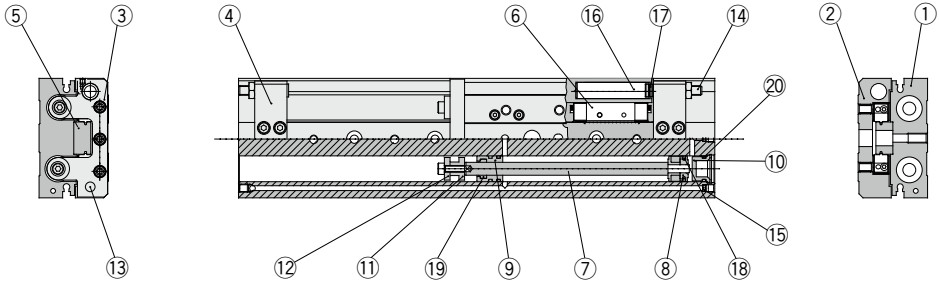

- MXH
- MXS
- MXQ
- MXQ
- MXF
- MXW
- MXJ
- MXP
- MXY
- MTS

Component Parts

No.	Description	Material	Note
1	Body	Aluminum alloy	Hard anodized
2	Table	Aluminum alloy	Hard anodized
3	End plate	Aluminum alloy	Hard anodized
4	Stopper block	Aluminum alloy	Hard anodized
5	Rail	High carbon chrome bearing steel	Heat treated
6	Guide block	High carbon chrome bearing steel	Heat treated
7	Rod	Stainless steel	
8	Piston assembly	—	With magnet
9	Rod cover	Aluminum alloy	
10	Head cap	Resin	
11	Floating bushing A	Stainless steel	
12	Floating bushing B	Stainless steel	
13	Stopper	Stainless steel	Heat treated
14	Stopper bolt	Carbon steel	Heat treated, Electroless nickel plated
15	Orifice	Brass	Electroless nickel plated
16	Absorber shaft	Aluminum alloy	Chromate treated
17	Adjusting bumper	Polyurethane	
18	Piston seal	NBR	
19	Rod seal	NBR	
20	O-ring	NBR	

Replacement Parts: Seal Kit

Bore size (mm)	Kit no.	Contents
8	MXW8-PS	Set of nos. above ⑱, ⑲, ⑳
12	MXW12-PS	
16	MXW16-PS	
20	MXW20-PS	
25	MXW25-PS	

* Seal kit includes ⑱, ⑲, ⑳. Order the seal kit, based on each bore size.

Replacement Part: Grease Pack

Applied part	Grease pack part no.
Guide	GR-S-010 (10 g)
	GR-S-020 (20 g)
Cylinder	GR-L-005 (5 g)
	GR-L-010 (10 g)

- D-
- X

MXW Series

MXW8/Stroke: 25, 50 mm

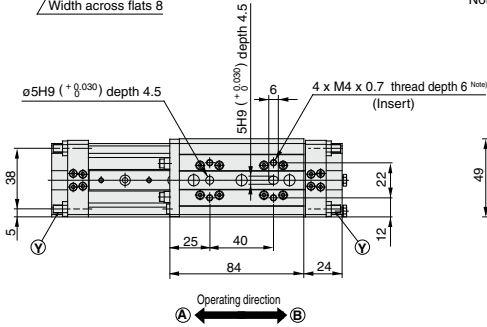
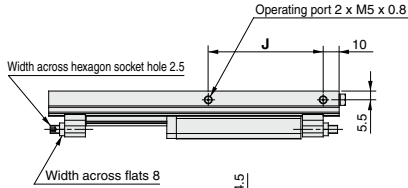

Note) If long bolts are used, they can touch the guide block and cause malfunction, etc. Refer to the Specific Product Precautions.

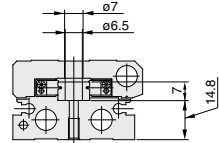
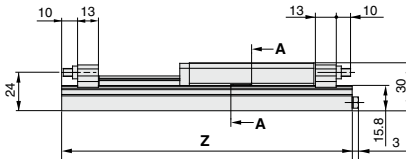
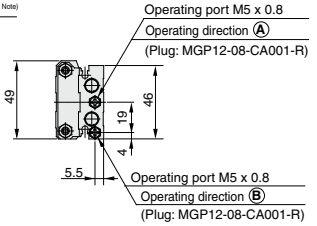

Cross section AA

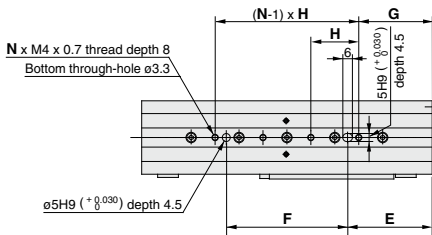

Model	E	F	G	H	J	N	Z
MXW8-25	55	48	47	32	64	3	157
MXW8-50	53	76	46	30	71	4	182

Note) Stopper bolt (Y) shown in the section above is attached only on B type (with shock absorber).

MXW8/Stroke: 75, 100, 125, 150 mm

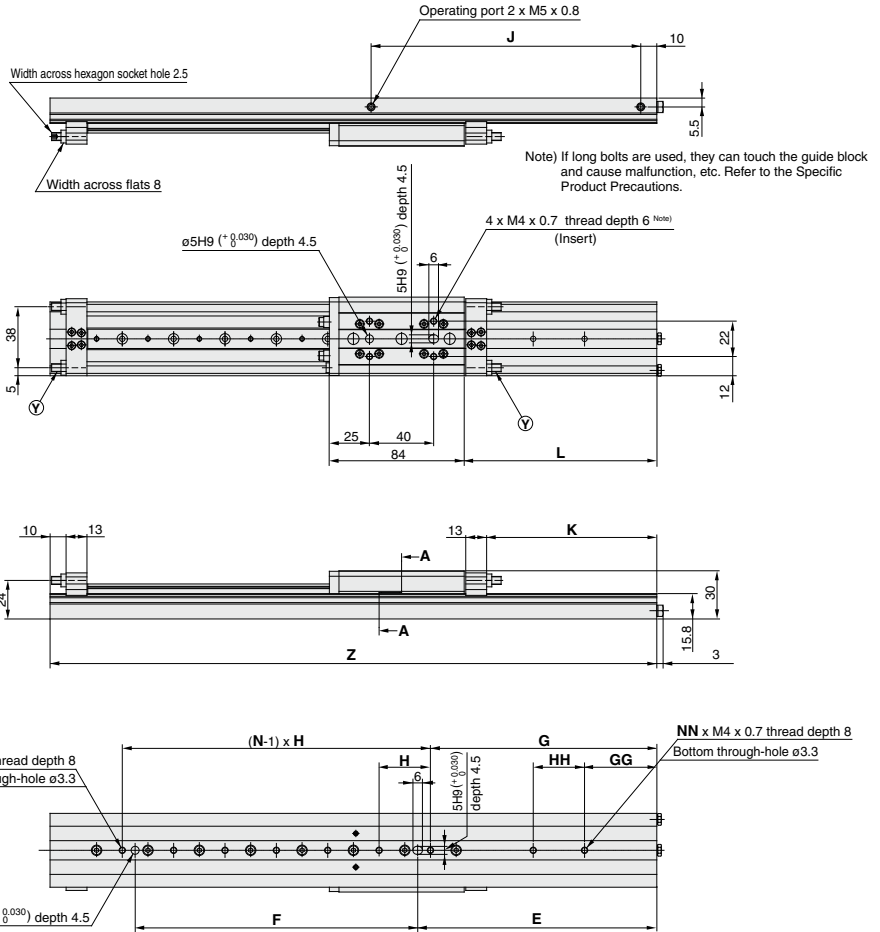

- MXH
- MXS
- MXQ
- MXQ
- MXF
- MXW
- MXJ
- MXP
- MXY
- MTS

Model	E	F	G	GG	H	HH	J	K	L	N	NN	Z
MXW8-75	71	106	64	19	30	—	92	31	45	5	1	228
MXW8-100	106	112	98	34	32	—	115	56	70	5	1	278
MXW8-125	129	144	121	25	32	32	138	81	95	6	2	328
MXW8-150	149	176	141	45	32	32	168	106	120	7	2	378

- D-
- X

MXW Series

MXW12/Stroke: 50, 75 mm

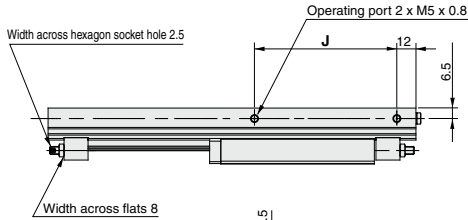

Note) If long bolts are used, they can touch the guide block and cause malfunction, etc. Refer to the Specific Product Precautions.

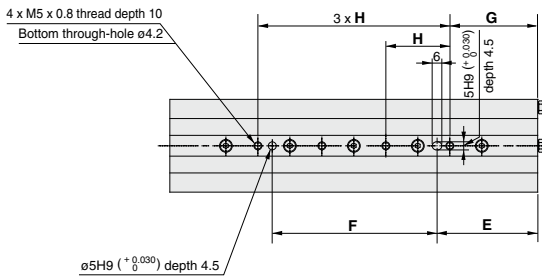
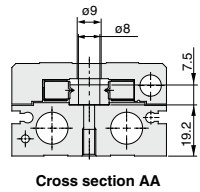
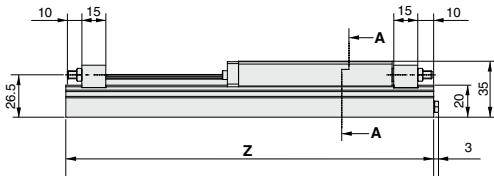
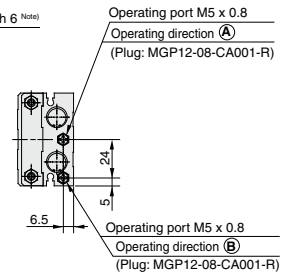
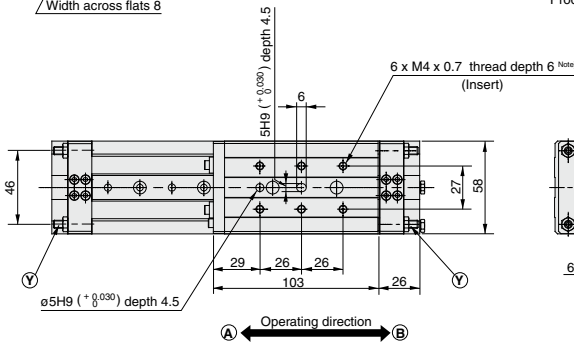

Model	E	F	G	H	J	Z
MXW12-50	58	88	50	35	84	205
MXW12-75	63	103	55	40	89	230

Note) Stopper bolt (Y) shown in the section above is attached only on B type (with shock absorber).

MXW12/Stroke: 100, 125, 150 mm

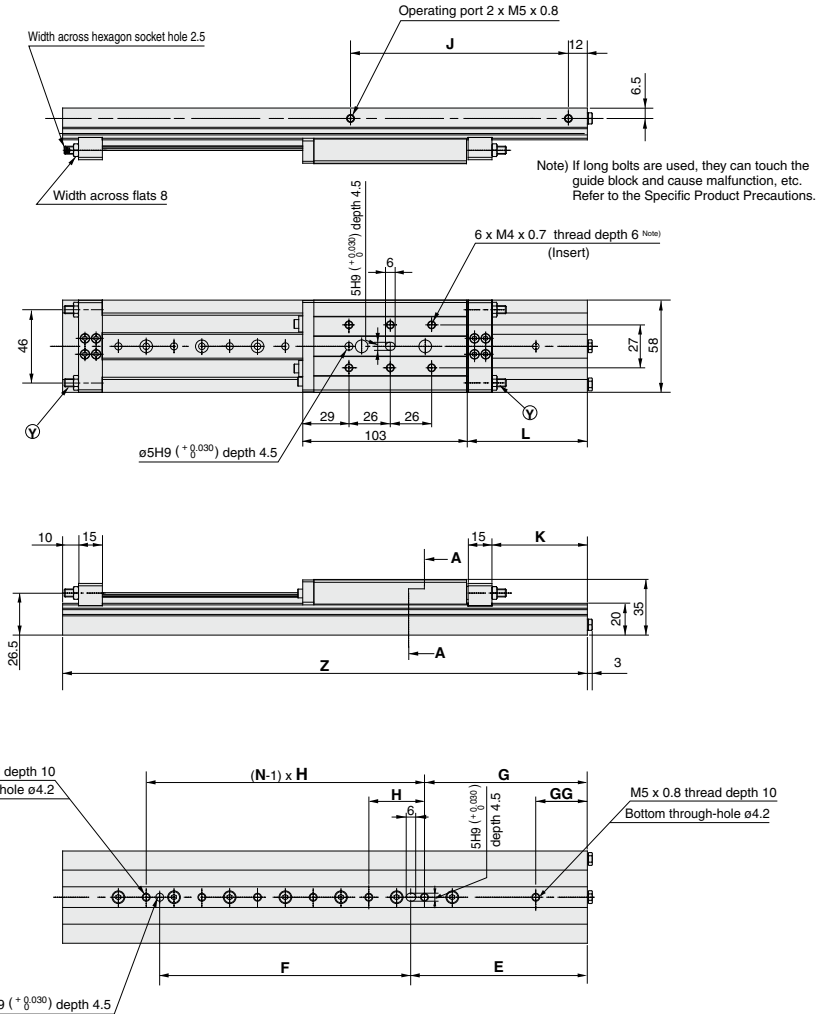

- MXH
- MXS
- MXQ
- MXQ
- MXF
- MXW**
- MXJ
- MXP
- MXY
- MTS

(mm)

Model	E	F	G	GG	H	J	K	L	N	Z
MXW12-100	91	123	82.5	30	35	114	35	51	5	280
MXW12-125	111	158	102.5	32.5	35	137	60	76	6	330
MXW12-150	136	182	127.5	47.5	40	164	85	101	6	380

- D-□
- X□

MXW Series

MXW16/Stroke: 75, 100 mm

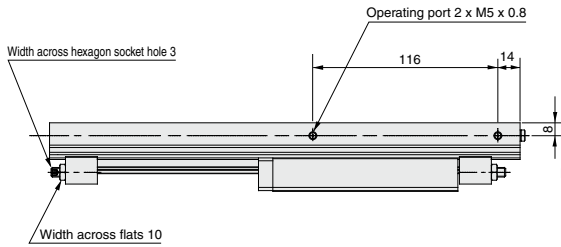

Note) If long bolts are used, they can touch the guide block and cause malfunction, etc. Refer to the Specific Product Precautions.

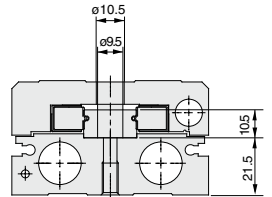
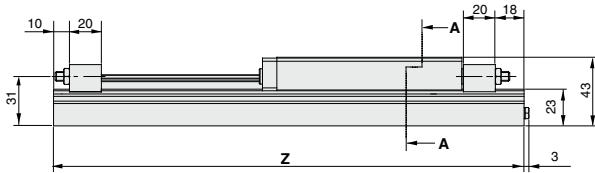
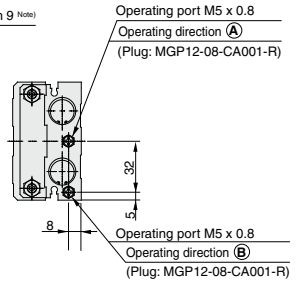
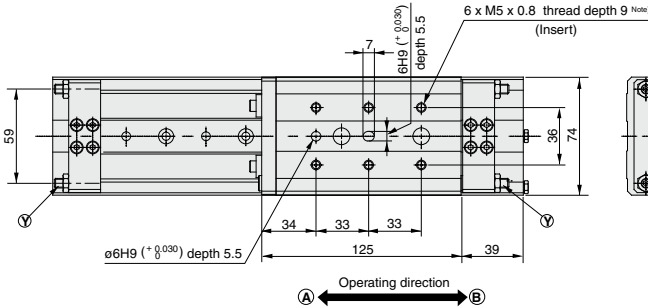

Cross section AA

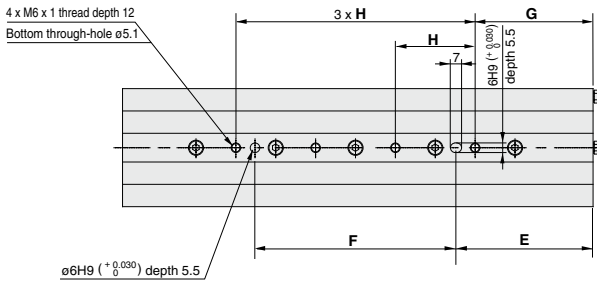

(mm)

Model	E	F	G	H	Z
MXW16-75	83	112	71.5	45	270
MXW16-100	86	126	74	50	295

Note) Stopper bolt (Y) shown in the section above is attached only on B type (with shock absorber).

MXW16/Stroke: 125, 150, 175, 200 mm

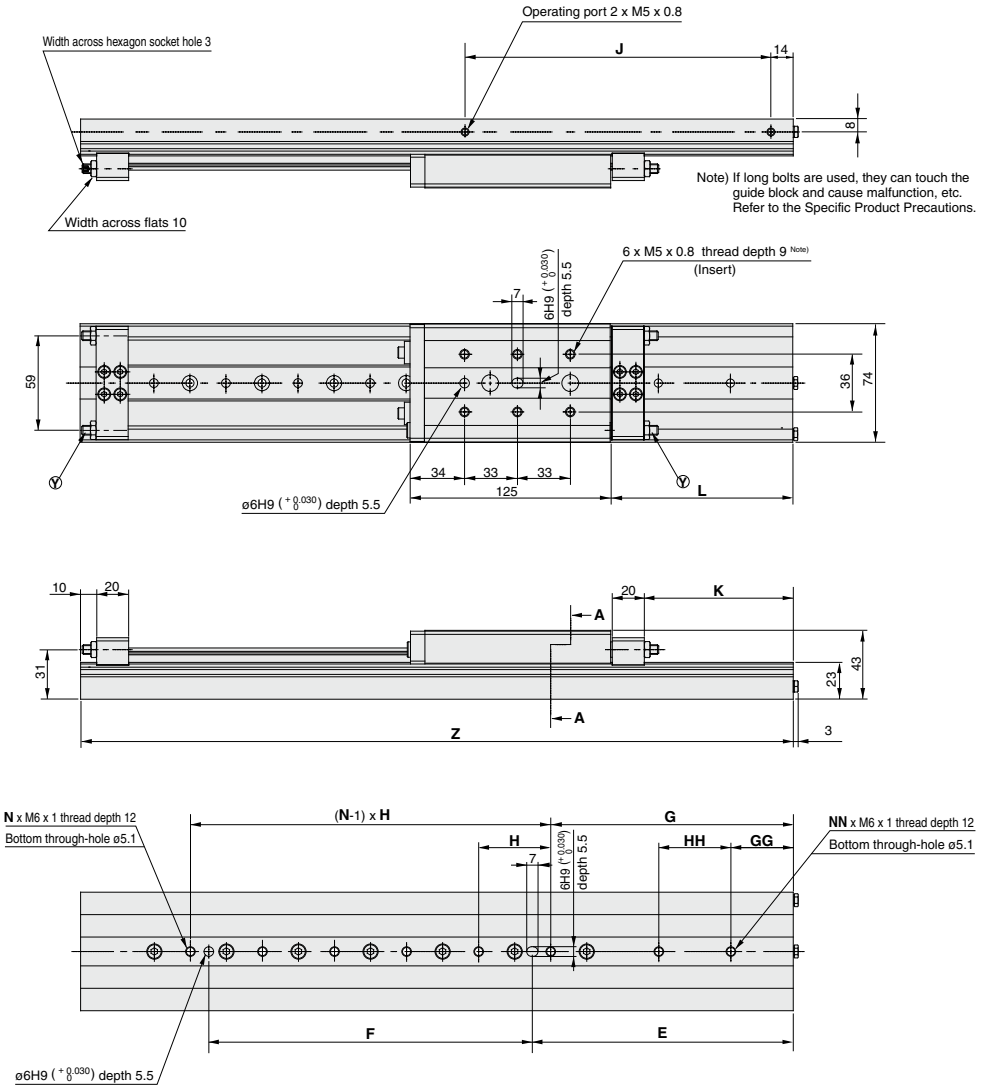

(mm)

Model	E	F	G	GG	H	HH	J	K	L	N	NN	Z
MXW16-125	110	157	99	31.5	45	—	141	43	64	5	1	345
MXW16-150	136	176	124	24	50	—	166	68	89	5	1	395
MXW16-175	163	202	151.5	39	45	45	191	93	114	6	2	445
MXW16-200	186	226	174	24	50	50	216	118	139	6	2	495

- MXH
- MXS
- MXQ □
- MXQ
- MXF
- MXW**
- MXJ
- MXP
- MXY
- MTS

- D-□
- X□

MXW Series

MXW20/Stroke: 100, 125 mm

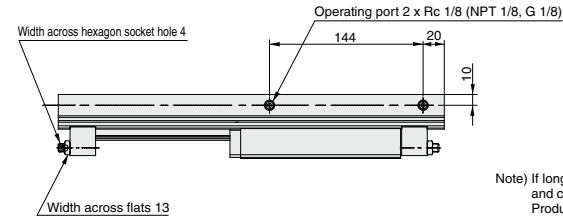

Note) If long bolts are used, they can touch the guide block and cause malfunction, etc. Refer to the Specific Product Precautions.

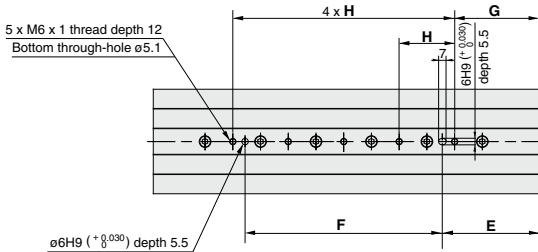
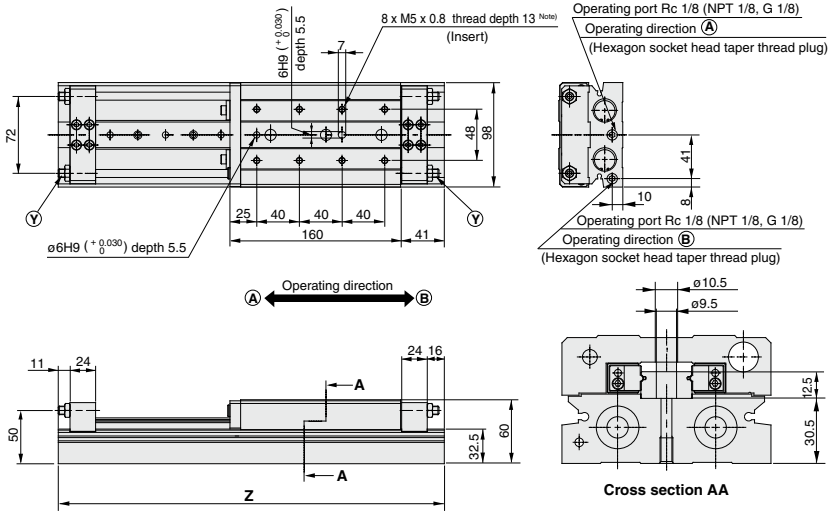

(mm)

Model	E	F	G	H	Z
MXW20-100	87	168	75	48	337
MXW20-125	91	185	79.5	52	362

Note) Stopper bolt (Y) shown in the section above is attached only on B type (with shock absorber).

MXW20/Stroke: 150, 175, 200, 225, 250 mm

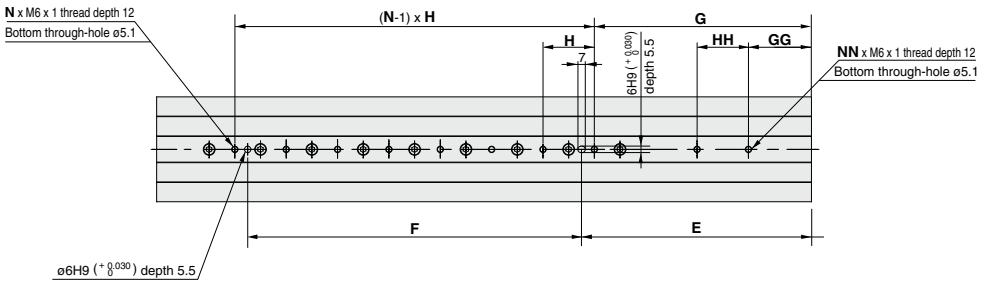
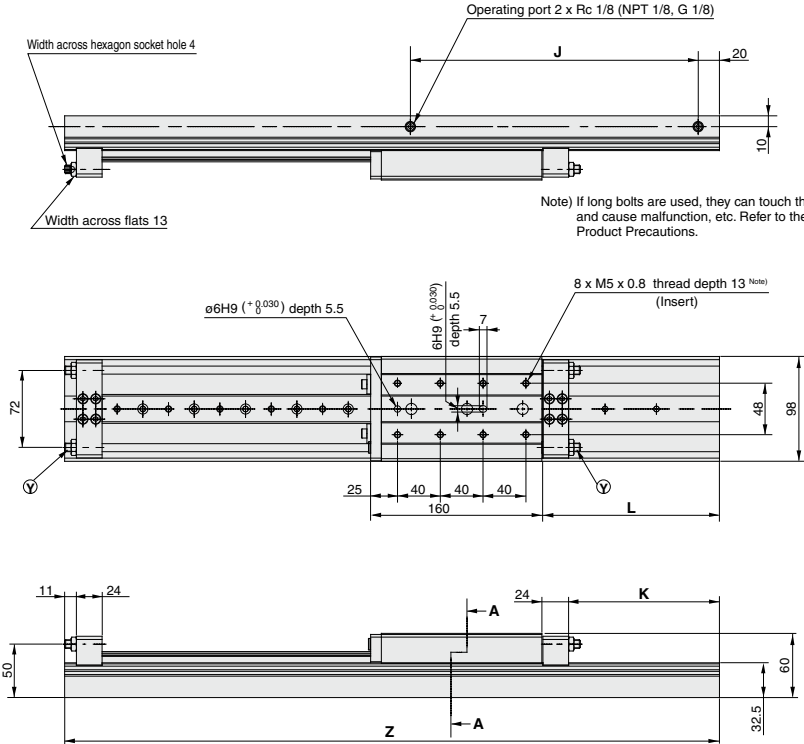

(mm)

Model	E	F	G	GG	H	HH	J	K	L	N	NN	Z
MXW20-150	113	216	101	29	48	—	169	41	66	6	1	412
MXW20-175	140	237	128.5	50.5	52	—	194	66	91	6	1	462
MXW20-200	164	264	152	56	48	—	219	91	116	7	1	512
MXW20-225	189	288	177.5	73.5	52	—	244	116	141	7	1	562
MXW20-250	215	312	203	59	48	48	269	141	166	8	2	612

MXH

MXS

MXQ □

MXQ

MXF

MXW

MXJ

MXP

MXY

MTS

D-□

-X□

MXW Series

MXW25/Stroke: 100, 125, 150 mm

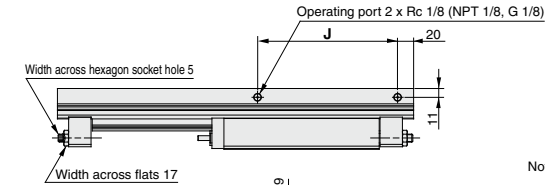

Note) If long bolts are used, they can touch the guide block and cause malfunction, etc. Refer to the Specific Product Precautions.

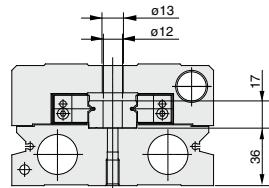
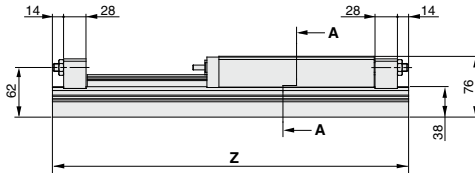
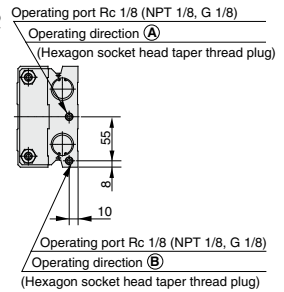
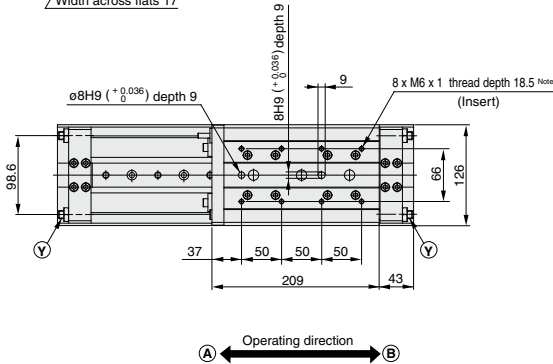

Cross section AA

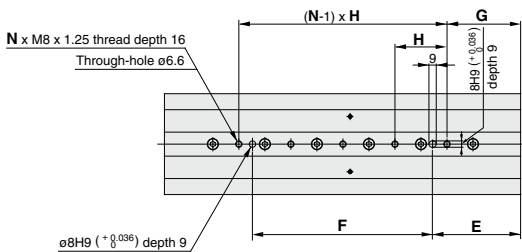

(mm)

Model	E	F	G	H	J	N	Z
MXW25-100	115	165	100	65	165	4	395
MXW25-125	105	210	90	60	180	5	420
MXW25-150	110	225	92	65	180	5	445

Note) Stopper bolt (Y) shown in the section above is attached only on B type (with shock absorber).

MXW25/Stroke: 175, 200, 225, 250, 275, 300 mm

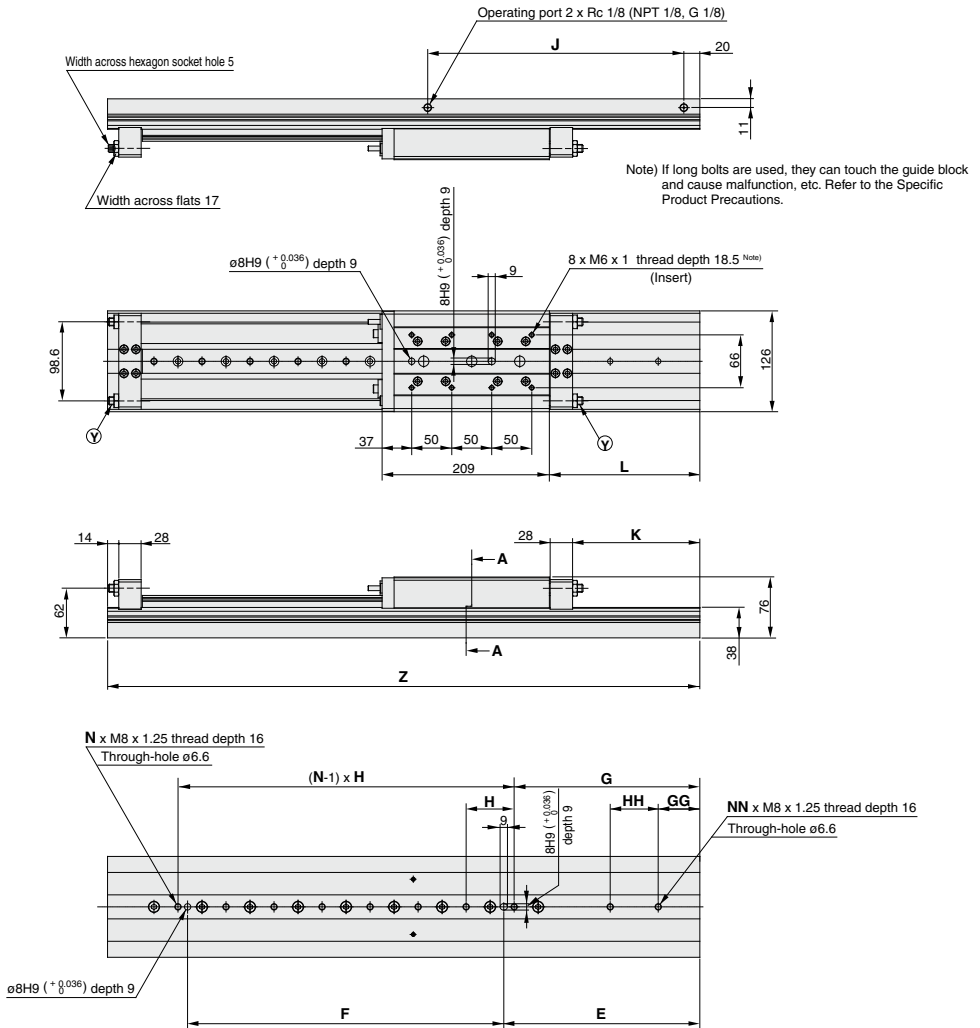

- MXH
- MXS
- MXQ
- MXQ
- MXF
- MXW
- MXJ
- MXP
- MXY
- MTS

Model	E	F	G	GG	H	HH	J	K	L	N	NN	Z
MXW25-175	120	270	105	—	60	—	195	34	63	6	—	490
MXW25-200	155	275	142	—	60	—	225	59	88	6	—	540
MXW25-225	175	305	165	55	55	—	245	84	113	7	1	590
MXW25-250	200	335	187	67	60	—	275	109	138	7	1	640
MXW25-275	225	360	210	80	65	—	300	134	163	7	1	690
MXW25-300	245	395	232	52	60	60	320	159	188	8	2	740

(mm)

- D
- X

Auto Switch Mounting

Auto Switch Proper Mounting Position (Detection at Stroke End)

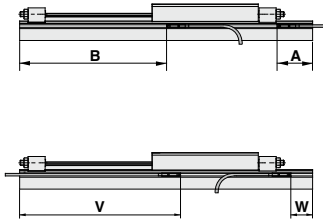

Reed Auto Switch: D-A90 (V), D-A93 (V), D-A96 (V)

Model	Stroke (mm)												
	25	50	75	100	125	150	175	200	225	250	275	300	
MXW8	A	52.5	31.5	27.5	27.5	27.5	27.5	—	—	—	—	—	—
	B	79.5	100.5	125.5	150.5	175.5	200.5	—	—	—	—	—	—
	W	32.5	11.5	7.5	7.5	7.5	7.5	—	—	—	—	—	—
	V	99.5	120.5	145.5	170.5	195.5	220.5	—	—	—	—	—	—
MXW12	A	—	51	31	31	31	31	—	—	—	—	—	—
	B	—	104	124	149	174	199	—	—	—	—	—	—
	W	—	31	11	11	11	11	—	—	—	—	—	—
	V	—	124	144	169	194	219	—	—	—	—	—	—
MXW16	A	—	—	59.5	34.5	34.5	34.5	34.5	34.5	—	—	—	—
	B	—	—	135.5	160.5	185.5	210.5	235.5	260.5	—	—	—	—
	W	—	—	39.5	14.5	14.5	14.5	14.5	14.5	—	—	—	—
	V	—	—	155.5	180.5	205.5	230.5	225.5	280.5	—	—	—	—
MXW20	A	—	—	—	68.5	43.5	43.5	43.5	43.5	43.5	43.5	—	—
	B	—	—	—	168.5	193.5	218.5	243.5	268.5	293.5	318.5	—	—
	W	—	—	—	48.5	23.5	23.5	23.5	23.5	23.5	23.5	—	—
	V	—	—	—	188.5	213.5	238.5	263.5	288.5	313.5	338.5	—	—
MXW25	A	—	—	—	86.5	74.5	44.5	44.5	44.5	44.5	44.5	44.5	44.5
	B	—	—	—	208.5	220.5	250.5	270.5	295.5	320.5	345.5	370.5	395.5
	W	—	—	—	66.5	54.5	24.5	24.5	24.5	24.5	24.5	24.5	24.5
	V	—	—	—	228.5	240.5	270.5	290.5	315.5	340.5	365.5	390.5	415.5

Solid State Auto Switch: D-M9B (V), D-M9N (V), D-M9P (V)

2-Color Indicator Solid State Auto Switch: D-M9BW (V), D-M9NW (V), D-M9PW (V), D-M9□A (V)

Model	Stroke (mm)												
	25	50	75	100	125	150	175	200	225	250	275	300	
MXW8	A	48.5	27.5	23.5	23.5	23.5	23.5	—	—	—	—	—	—
	B	83.5	104.5	129.5	154.5	179.5	204.5	—	—	—	—	—	—
	W	36.5	15.5	11.5	11.5	11.5	11.5	—	—	—	—	—	—
	V	95.5	116.5	141.5	166.5	191.5	216.5	—	—	—	—	—	—
MXW12	A	—	47	27	27	27	27	—	—	—	—	—	—
	B	—	108	128	153	178	203	—	—	—	—	—	—
	W	—	35	15	15	15	15	—	—	—	—	—	—
	V	—	120	140	165	190	215	—	—	—	—	—	—
MXW16	A	—	—	55.5	30.5	30.5	30.5	30.5	30.5	—	—	—	—
	B	—	—	140	165	190	215	240	265	—	—	—	—
	W	—	—	43.5	18.5	18.5	18.5	18.5	18.5	—	—	—	—
	V	—	—	152	177	202	227	252	277	—	—	—	—
MXW20	A	—	—	—	64.5	39.5	39.5	39.5	39.5	39.5	39.5	—	—
	B	—	—	—	172.5	197.5	222.5	247.5	272.5	297.5	322.5	—	—
	W	—	—	—	52.5	27.5	27.5	27.5	27.5	27.5	27.5	—	—
	V	—	—	—	184.5	209.5	234.5	259.5	284.5	309.5	334.5	—	—
MXW25	A	—	—	—	82.5	70.5	40.5	40.5	40.5	40.5	40.5	40.5	40.5
	B	—	—	—	212.5	224.5	254.5	274.5	299.5	324.5	349.5	374.5	399.5
	W	—	—	—	70.5	58.5	28.5	28.5	28.5	28.5	28.5	28.5	28.5
	V	—	—	—	224.5	236.5	266.5	286.5	311.5	336.5	361.5	386.5	411.5

Note) Adjust the auto switch after confirming the operating conditions in the actual setting.

Operating Range

Auto switch model	Applicable bore size (mm)				
	8	12	16	20	25
D-A9□ D-A9□V	6	6	8.5	10	10
D-M9□ D-M9□V D-M9□W D-M9□WV D-M9□A D-M9□AV	3.5	3.5	5	6	5.5

* Since the operating range is provided as a guideline including hysteresis, it cannot be guaranteed (assuming approximately ±30% dispersion). It may vary substantially depending on an ambient environment.

⚠ Caution

Caution on Handling Auto Switches/For MXW8 only

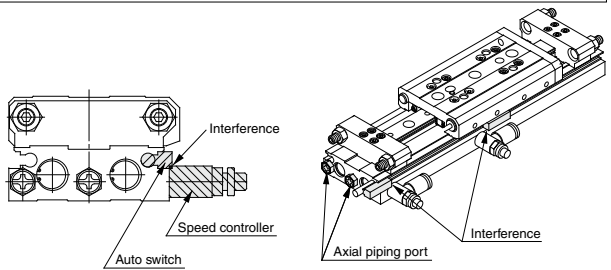

When an auto switch is installed on the port side of MXW8, some switches could interfere with the speed controller or a fitting. Therefore, use one of the methods described below for installing the auto switch.

1. Use the port for piping in the axial direction.
 2. Install an auto switch on the opposite side of the port.
 3. Use a pipe fitting with 7 mm width across flats or ø8 external diameter or less.
- **M-5J** (Extension fittings) + **AS1201F-M5-04** (Speed controller with One-touch fittings, Elbow type)
 - **KJL04-M5** (One-touch fitting) + **AS1001F-04** (Speed controller with One-touch fittings, In-line type)

Table for Auto Switch Interference with Speed Controller and Fittings

Auto switch model	Electrical entry direction	Wiring type	Auto switch model
Solid state auto switch D-M9□V	Perpendicular	3-wire	D-M9NV, D-M9PV
		2-wire	D-M9BV
2-color indicator solid state auto switch D-M9□WV	Perpendicular	3-wire	D-M9NWV, D-M9PWV
		2-wire	D-M9BWV
Water resistant 2-color indicator solid state auto switch D-M9□AV	Perpendicular	3-wire	D-M9NAV, D-M9PAV
		2-wire	D-M9BAV

Auto Switch Mounting

⚠ Caution

Auto Switch Mounting Tool

- * When adjusting the auto switch mounting screw (included with auto switch), use a watchmaker's screwdriver with a handle about 5 to 6 mm in diameter.

Tightening torque

Tightening Torque of Auto Switch Mounting Screw (N·m)

Auto switch model	Tightening torque
D-A9□ (V)	0.10 to 0.20
D-M9□ (V) D-M9□W (V) D-M9□A (V)	0.05 to 0.15

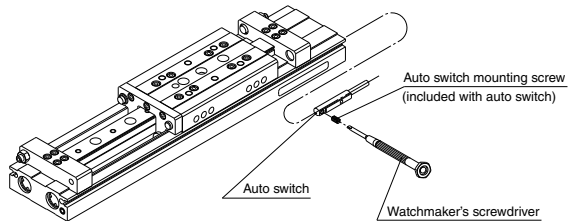

Other than the models listed in "How to Order", the following auto switches are applicable.

- * Normally closed (NC = b contact) solid state auto switches (D-F9G/F9H types) and solid state auto switch D-F8 are also available. For details, refer to pages 1136 and 1137.

MXH

MXS

MXQ□

MXQ

MXF

MXW

MXJ

MXP

MXY

MTS

D-□

-X□



1 PTFE Grease Symbol -X7

MXW Standard model no. — X7

 ● PTFE grease

PTFE grease is used for all parts that grease is applied.

Specifications

Type	PTFE grease
Bore size (mm)	8, 12, 16, 20, 25

* Dimensions other than the above is the same as the standard type.

⚠ Warning Precautions

Be aware that smoking cigarettes, etc. after your hands have come into contact with the grease used in this cylinder can create a gas that is hazardous to humans.

2 Grease for Food Processing Machines Symbol -X9

MXW Standard model no. — X9

 ● Grease for food processing machines

Grease for food processing machines is used for all parts that grease is applied.

Specifications

Type	Grease for Food Processing Machines (NSF-H1 certified)/ Aluminum Complex Soap Base Grease
Bore size (mm)	8, 12, 16, 20, 25

* Dimensions other than the above is the same as the standard type.

⚠ Caution

Do not use this cylinder in a food-related environment.

<Cannot be mounted>

Food zone

Food may directly contact with this cylinder, and is treated as food products.

<Can be mounted>

Splash zone

Food may directly contact with this cylinder, but is not treated as food products.

Non-food zone

This cylinder do not directly contact food.

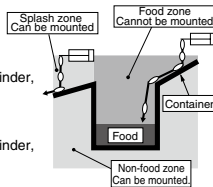

3 Without Built-in Auto Switch Magnet Symbol -X33

MXW Standard model no. — X33

 ● Without built-in auto switch magnet

Auto switch magnet is not built in.

Specifications

Type	Without built-in auto switch magnet
Bore size (mm)	8, 12, 16, 20, 25
Auto switch	Not mountable

* Dimensions other than the above is the same as the standard type.

4 Fluororubber Seal Symbol -X39

MXW Standard model no. — X39

 ● Fluororubber seal

Change the materials for the piston seal, rod seal, O-rings and scrapers (rubber lined parts) to fluororubber.

Specifications

Type	Fluororubber seal
Bore size (mm)	8, 12, 16, 20, 25
Seal material	Fluororubber

* Dimensions other than the above is the same as the standard type.

5 Anti-corrosive Specifications for Guide Unit Symbol -X42

MXW Standard model no. — X42

 ● Anti-corrosive Specifications for Guide Unit

Rail and guide are given anti-corrosive treatment.

Specifications

Type	Anti-corrosive guide unit
Bore size (mm)	8, 12, 16, 20, 25
Surface treatment	Special anti-corrosive treatment (2)

* 1 Dimensions other than the above is the same as the standard type.
 * 2 Special anti-corrosive treatment makes the rail and the guide black.

6 EPDM Seal Symbol -X45

MXW Standard model no. — X45

 ● EPDM seal

Change the materials for the piston seal, rod seal, O-rings and scrapers (rubber lined parts) to EPDM.

Specifications

Type	EPDM seal
Bore size (mm)	8, 12, 16, 20, 25
Seal material	EPDM
Grease	PTFE grease

* Dimensions other than the above is the same as the standard type.

⚠ Warning Precautions

Be aware that smoking cigarettes, etc. after your hands have come into contact with the grease used in this cylinder can create a gas that is hazardous to humans.



Please contact SMC for detailed dimensions, specifications and lead times.

7 Adjusting Bolt, Long Specification (Adjustment range: 15 mm)

Symbol
-X11

MXW Standard model no. — X11

- Adjusting bolt, long specification (Adjustment range: 15 mm)

The average adjusting stroke range was extended from 5 mm to 15 mm with a long adjusting bolt.

Dimensions

Standard product

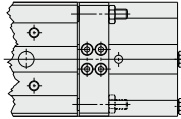
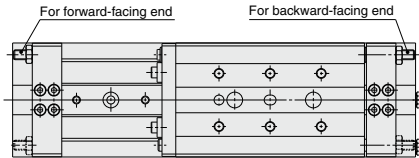

-X11

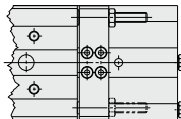
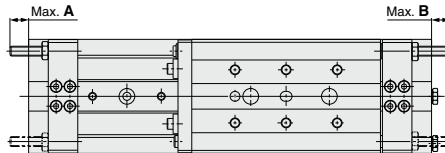

(mm)

Model	Stroke	A	B
MXW8	25, 50	9	9
	75 to 150	9	—
MXW12	50, 75	9.5	9.5
	100 to 150	9.5	—
MXW16	75, 100	9.5	9.5
	125 to 200	9.5	—
MXW20	100, 125	10	10
	150 to 250	10	—
MXW25	100 to 150	9	9
	175 to 300	9	—

MXH

MXS

MXQ

MXQ

MXF

MXW

MXJ

MXP

MXY

MTS

D-

-X



MXW Series

Specific Product Precautions

Be sure to read this before handling the products.

Refer to back page 50 for Safety Instructions and pages 3 to 12 for Actuator and Auto Switch Precautions.

Mounting

⚠ Caution

1. Do not apply scratches and dents on mounting side of body and table (guide table).

The damage will decrease parallelism, increase vibration of guide and increase moving part resistance.

2. Do not scratch or dent on the forward side of the rail.

This could result in looseness and increased operating resistance, etc.

3. Keep away from objects which are influenced by magnets.

As the piston part has magnets built-in, do not allow close contact with a magnetic disk, magnetic card, or magnetic tape. Data might be erased.

4. When mounting the body, use screws with appropriate length and do not exceed the maximum tightening torque.

Tightening with a torque above the limit could malfunction. Whereas tightening insufficiently could result in misalignment or come to a drop.

Mounting of Body

The slide table can be mounted from 2 directions.

Select the best direction according to application requirement.

1. Body tapped

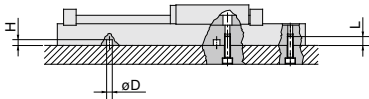

Model	Bolt	Max. tightening torque (N-m)	Max. screw-in depth L (mm)	Positioning hole $\phi D \times H$ (mm)
MXW8	M4 x 0.7	2.1	8	$\phi 5H9^{+0.030}_0$ depth 4.5
MXW12	M5 x 0.8	4.4	10	$\phi 5H9^{+0.030}_0$ depth 4.5
MXW16	M6 x 1	7.4	12	$\phi 6H9^{+0.030}_0$ depth 5.5
MXW20	M6 x 1	7.4	12	$\phi 6H9^{+0.030}_0$ depth 5.5
MXW25	M8 x 1.25	18	16	$\phi 8H9^{+0.036}_0$ depth 9

2. Through-hole

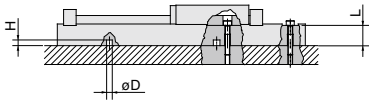

Model	Bolt	Max. tightening torque (N-m)	Depth L (mm)	Positioning hole $\phi D \times H$ (mm)
MXW8	M3 x 0.5	1.2	14.8	$\phi 5H9^{+0.030}_0$ depth 4.5
MXW12	M4 x 0.7	2.1	19.2	$\phi 5H9^{+0.030}_0$ depth 4.5
MXW16	M5 x 0.8	4.4	21.5	$\phi 6H9^{+0.030}_0$ depth 5.5
MXW20	M5 x 0.8	4.4	30.5	$\phi 6H9^{+0.030}_0$ depth 5.5
MXW25	M6 x 1	7.4	36	$\phi 8H9^{+0.036}_0$ depth 9

Mounting of Workpiece

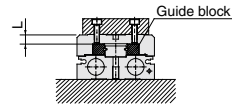
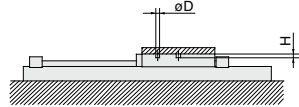

⚠ Caution

1. To prevent the workpiece holding bolts from touching the guide block, use bolts that are 0.5 mm or more shorter than the maximum screw-in depth.

If the bolts are too long, they come in contact with the guide block, which could lead to a malfunction.

Model	Bolt	Max. tightening torque (N-m)	Max. screw-in depth L (mm)	Positioning hole $\phi D \times H$ (mm)
MXW8	M4 x 0.7	2.1	6	$\phi 5H9^{+0.030}_0$ depth 4.5
MXW12	M4 x 0.7	2.1	6	$\phi 5H9^{+0.030}_0$ depth 4.5
MXW16	M5 x 0.8	4.4	9	$\phi 6H9^{+0.030}_0$ depth 5.5
MXW20	M5 x 0.8	4.4	13	$\phi 6H9^{+0.030}_0$ depth 5.5
MXW25	M6 x 1	7.4	18.5	$\phi 8H9^{+0.036}_0$ depth 9

2. 0.02 mm or less of flatness is recommended for the body mounting surface.

Insufficient flatness of workpiece or base to which Air Slide Table is mounted can generate play in guide section or increase of sliding resistance.

3. The positioning hole on the table and on the bottom of the body does not have the same center.

Use these holes during reinstallation after the table has been removed for the maintenance of an identical product.