

Low Profile Slide Table

MXF Series

ø8, ø12, ø16, ø20

RoHS

Low-profile and compact type, air slide table with the construction of guide and cylinder aligned in parallel.

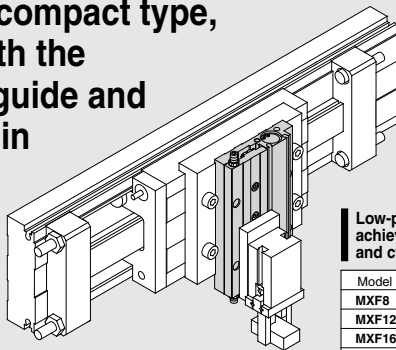

Low-profile and compactness have been achieved with the construction of guide and cylinder aligned in parallel.

Model	Height x Width (mm)	Height comparison to MXS
MXF8	16 x 58	67%
MXF12	18.5 x 68	59%
MXF16	21 x 80	53%
MXF20	27 x 92	54%

Neat appearance

Protecting stopper section with cover realizes neat appearance.

Standard stroke adjustment

Stroke can be adjusted at each stroke end within 5 mm each end and 10 mm is total.

Body mounting (Body tapped)

Auto switch is mountable

Auto switch is recessed in the groove to save space.

Slim body

Low-profile has been achieved with the construction of guide and cylinder aligned in parallel.

Reproducibility for mounting and dismounting

Positioning pin holes on table top allows precise and easy mounting to change workpiece.

High rigidity

Cross roller guide allows smooth operation without vibration.

Optional porting

Lateral and axial piping from 2 directions is possible.

Stronger thread for mounting work

Insert thread for mounting work.

Reproducibility for mounting and dismounting

Pin holes for positioning on bottom of slide allows precise and accurate mounting of actuator.

Body mounting (Body tapped)

Mounting can be done from 2 directions top side (through-hole) and bottom side (body tapped).

1. Body tapped



2. Body through-hole



Series Variations

Model	Bore size (mm)	Stroke (mm)					Auto switch
		10	20	30	50	75	
MXF8	8	●	●	●	●	●	●
MXF12	12	●	●	●	●	●	●
MXF16	16	●	●	●	●	●	●
MXF20	20	●	●	●	●	●	●

Reed auto switch
D-A9□, D-A9□V
Solid state auto switch
D-M9□, D-M9□V
2-color indicator
solid state auto switch
D-M9□W, D-M9□WV

MXH

MXS

MXQ□

MXQ

MXF

MXW

MXJ

MXP

MXY

MTS

D-□

-X□

Model Selection Step	Formula/Data	Selection Example				
<p>1 Operating Conditions</p> <p>Enumerate the operating conditions considering the mounting position and workpiece configuration. Check that the load weight does not exceed the maximum allowable load weight and that the average operating speed does not exceed the operating speed range.</p>	<ul style="list-style-type: none"> • Model to be used • Type of cushion • Workpiece mounting position • Mounting orientation • Average operating speed Va (mm/s) • Load mass W (kg): Fig. (1) - Table (2) • Overhang Ln (mm): Fig. (2) 	 <p>Cylinder: MXF20-50 Cushion: Rubber bumper Workpiece table mounting Mounting: Horizontal wall mounting Average operating speed: Va = 300 [mm/s] Allowable load: W = 0.5 [kg] L1 = 10 mm L2 = 30 mm L3 = 30 mm</p>				
<p>2 Kinetic Energy</p> <p>Find the kinetic energy E (J) of the load. Find the allowable kinetic energy Ea (J). Confirm that the kinetic energy of the load does not exceed the allowable kinetic energy.</p>	$E = \frac{1}{2} \cdot W \left(\frac{V}{1000} \right)^2$ <p>Collision speed $V = 1.4 \cdot Va$ (Correction factor (Reference values)) Ea = K·Emax Workpiece mounting coefficient K: Fig. (3) Max. allowable kinetic energy Emax: Table (1) Kinetic energy (E) ≤ Allowable kinetic energy (Ea)</p>	$E = \frac{1}{2} \cdot 0.5 \left(\frac{420}{1000} \right)^2 = 0.044$ <p>$V = 1.4 \times 300 = 420$</p> <p>Ea = 1 · 0.16 = 0.16 Can be used based on E = 0.044 ≤ Ea = 0.16</p>				
<p>3 Load Factor</p>						
<p>3-1 Load factor of load mass</p> <p>Find the allowable load mass Wa (kg). Note) No need to consider this load factor in the case of using perpendicularly in a vertical position. (Define $\alpha_1 = 0$.) Find the load factor of the load mass α_1.</p>	<p>Wa = K·β·Wmax Workpiece mounting coefficient K: Fig. (3) Allowable load mass coefficient β: Graph (1) Max. allowable load mass Wmax: Table (2) $\alpha_1 = W/Wa$</p>	<p>Wa = 1 × 1 × 4 = 4 K = 1 β = 1 Wmax = 4 $\alpha_1 = 0.5/4 = 0.125$</p>				
<p>3-2 Load factor of the static moment</p> <p>Find the static moment M (N·m). Find the allowable static moment Ma (N·m). Find the load factor α_2 of the static moment.</p>	<p>$M = W \times 9.8 (Ln + An)/1000$ Moment center position distance compensation amount An: Table (3) Ma = K·γ·Mmax Workpiece mounting coefficient K: Fig. (3) Allowable moment coefficient γ: Graph (2) Maximum allowable moment Mmax: Table (4) $\alpha_2 = M/Ma$</p>	<table border="0"> <tr> <td style="border: 1px solid black; padding: 2px;">Yawing</td> <td style="border: 1px solid black; padding: 2px;">Rolling</td> </tr> <tr> <td> <p>Examine My. My = 0.5 × 9.8 (10 + 11)/1000 = 0.11 A3 = 11 May = 1 × 1 × 9.14 = 9.14 Mymax = 9.14 K = 1 γ = 1 $\alpha_2 = 0.11/9.14 = 0.012$</p> </td> <td> <p>Examine Mr. Mr = 0.5 × 9.8 (30 + 17)/1000 = 0.23 A6 = 17 Mar = 9.14 (Same as May) $\alpha_2' = 0.23/9.14 = 0.025$</p> </td> </tr> </table>	Yawing	Rolling	<p>Examine My. My = 0.5 × 9.8 (10 + 11)/1000 = 0.11 A3 = 11 May = 1 × 1 × 9.14 = 9.14 Mymax = 9.14 K = 1 γ = 1 $\alpha_2 = 0.11/9.14 = 0.012$</p>	<p>Examine Mr. Mr = 0.5 × 9.8 (30 + 17)/1000 = 0.23 A6 = 17 Mar = 9.14 (Same as May) $\alpha_2' = 0.23/9.14 = 0.025$</p>
Yawing	Rolling					
<p>Examine My. My = 0.5 × 9.8 (10 + 11)/1000 = 0.11 A3 = 11 May = 1 × 1 × 9.14 = 9.14 Mymax = 9.14 K = 1 γ = 1 $\alpha_2 = 0.11/9.14 = 0.012$</p>	<p>Examine Mr. Mr = 0.5 × 9.8 (30 + 17)/1000 = 0.23 A6 = 17 Mar = 9.14 (Same as May) $\alpha_2' = 0.23/9.14 = 0.025$</p>					
<p>3-3 Load factor of dynamic moment</p> <p>Find the dynamic moment Me (N·m). Find the allowable dynamic moment Mea (N·m). Find the load factor α_3 of the dynamic moment.</p>	<p>$Me = 1/3 \cdot We \times 9.8 \frac{(Ln + An)}{1000}$ Collision equivalent to impact We = δ·W·V δ: Bumper coefficient With urethane bumper (Standard) = 4/100 Corrected value for moment center position distance An: Table (3) Mea = K·γ·Mmax Workpiece mounting coefficient K: Fig. (3) Allowable moment coefficient γ: Graph (2) Max. allowable moment Mmax: Graph (4) $\alpha_3 = Me/Mea$</p>	<table border="0"> <tr> <td style="border: 1px solid black; padding: 2px;">Pitching</td> <td>Examine Mep. Mep = 1/3 × 8.4 × 9.8 × $\frac{(30 + 17)}{1000} = 1.3$ We = 4/100 × 0.5 × 420 = 8.4 A2 = 17 Meap = 1 × 0.7 × 9.14 = 6.40 K = 1 γ = 0.7 Mpmmax = 9.14 α3 = 1.3/6.40 = 0.20</td> </tr> <tr> <td style="border: 1px solid black; padding: 2px;">Yawing</td> <td>Examine Mey. Mey = 1/3 × 8.4 × 9.8 × $\frac{(30 + 34)}{1000} = 1.8$ We = 8.4 A4 = 34 Meay = 6.40 (Same value as Meap) α3' = 1.8/6.4 = 0.28</td> </tr> </table>	Pitching	Examine Mep. Mep = 1/3 × 8.4 × 9.8 × $\frac{(30 + 17)}{1000} = 1.3$ We = 4/100 × 0.5 × 420 = 8.4 A2 = 17 Meap = 1 × 0.7 × 9.14 = 6.40 K = 1 γ = 0.7 Mpmmax = 9.14 α3 = 1.3/6.40 = 0.20	Yawing	Examine Mey. Mey = 1/3 × 8.4 × 9.8 × $\frac{(30 + 34)}{1000} = 1.8$ We = 8.4 A4 = 34 Meay = 6.40 (Same value as Meap) α3' = 1.8/6.4 = 0.28
Pitching	Examine Mep. Mep = 1/3 × 8.4 × 9.8 × $\frac{(30 + 17)}{1000} = 1.3$ We = 4/100 × 0.5 × 420 = 8.4 A2 = 17 Meap = 1 × 0.7 × 9.14 = 6.40 K = 1 γ = 0.7 Mpmmax = 9.14 α3 = 1.3/6.40 = 0.20					
Yawing	Examine Mey. Mey = 1/3 × 8.4 × 9.8 × $\frac{(30 + 34)}{1000} = 1.8$ We = 8.4 A4 = 34 Meay = 6.40 (Same value as Meap) α3' = 1.8/6.4 = 0.28					
<p>3-4 Sum of the load factors</p> <p>Use is possible if the sum of the load factors does not exceed 1.</p>	$\sum \alpha_n = \alpha_1 + \alpha_2 + \alpha_3 \leq 1$	$\sum \alpha_n = \alpha_1 + \alpha_2 + \alpha_2' + \alpha_3 + \alpha_3' = 0.125 + 0.012 + 0.025 + 0.20 + 0.28 = 0.642 \leq 1$ <p>And it is possible to use.</p>				

Fig. (1) Load Mass: W (kg)



Note) No need to consider this load factor in the case of using perpendicularly in a vertical position.

Fig. (3) Workpiece Mounting Coefficient: K

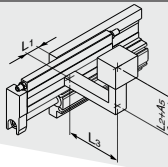
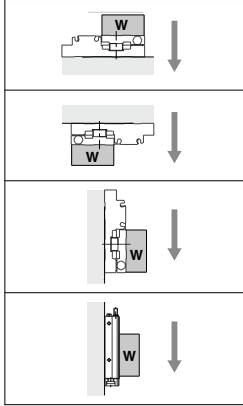
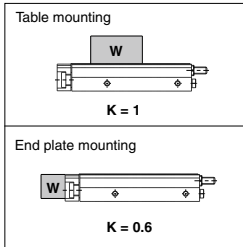

Table (2) Maximum Allowable Load Mass: Wmax (kg)

Model	Maximum allowable load mass
MXF8	0.6
MXF12	1
MXF16	2
MXF20	4

Table (4) Maximum Allowable Moment: Mmax (N·m)

Model	Stroke (mm)					
	10	20	30	50	75	100
MXF8	0.56	0.78	0.98	—	—	—
MXF12	—	1.65	2.22	3.34	—	—
MXF16	—	—	3.41	5.69	7.96	—
MXF20	—	—	6.66	9.14	13.70	18.27

Symbol

Symbol	Definition	Unit
An (n = 1 to 6)	Correction values of moment center position distance	mm
E	Kinetic energy	J
Ea	Allowable kinetic energy	J
Emax	Max. allowable kinetic energy	J
Ln (l = 1 to 3)	Overhang	mm
M (Mp, My, Mr)	Static moment (pitch, yaw, roll)	N·m
Ma (Map, May, Mar)	Allowable static moment (pitch, yaw, roll)	N·m
Me (Mep, Mey)	Dynamic moment (pitch, yaw)	N·m
Mea (Meap, Meay)	Allowable dynamic moment (pitch, yaw)	N·m
Mmax (Mpmax, Mymax, Mrmax)	Maximum allowable moment (pitch, yaw, roll)	N·m
V	Collision speed	mm/s

Fig. (2) Overhang: Ln (mm), Correction Values for Moment Center Distance: An (mm)

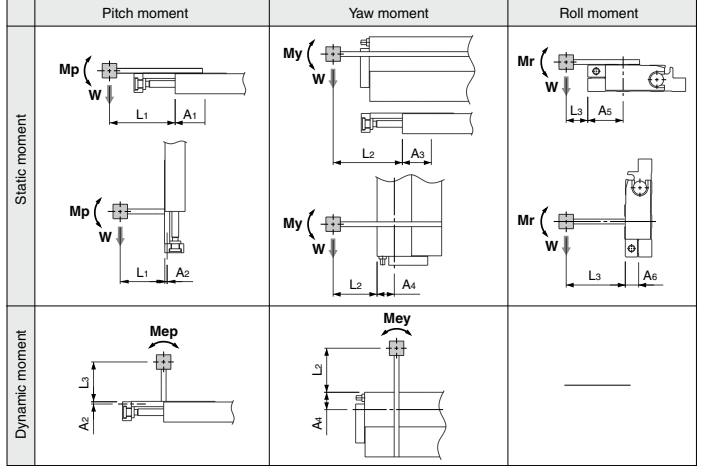

Note) Static moment: Moment generated by gravity
Dynamic moment: Moment generated by impact when colliding with stopper

Table (1) Maximum Allowable Kinetic Energy: Emax (J)

Model	Allowable kinetic energy
	Rubber bumper
MXF8	0.027
MXF12	0.055
MXF16	0.11
MXF20	0.16

Table (3) Moment Center Position Distance Compensation Amount: An (mm)

Model	Moment center position distance compensation amount. (Refer to Fig. (2).)					
	A1	A2	A3	A4	A5	A6
MXF8	6 ^(Note)	10	6 ^(Note)	21	21	10
MXF12	10	11	10	23	23	11
MXF16	10	12	10	28	28	12
MXF20	11	17	11	34	34	17

Note) 16 mm for MXF8-10 only.

Graph (1) Allowable Load Mass Coefficient: β

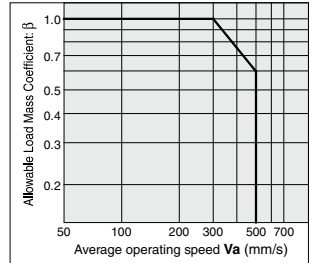

Graph (2) Allowable Moment Coefficient: γ

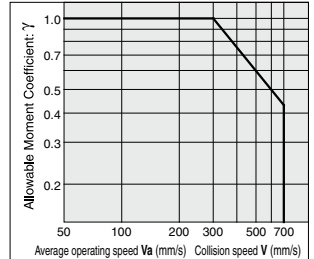

Note) Use the average operating speed when calculating static moment.
Use the collision speed when calculating dynamic moment.

Symbol	Definition	Unit
Va	Average operating speed	mm/s
W	Load mass	kg
Wa	Allowable load mass	kg
We	Mass equivalent to impact	kg
Wmax	Max. allowable load mass	kg
α	Load factor	—
β	Allowable load mass coefficient	—
γ	Allowable moment coefficient	—
δ	Damper coefficient	—
K	Workpiece mounting coefficient	—

- MXH
- MXS
- MXQ
- MXQ
- MXF
- MXW
- MXJ
- MXP
- MXY
- MTS

- D-
- X

Low Profile Slide Table MXF Series



How to Order

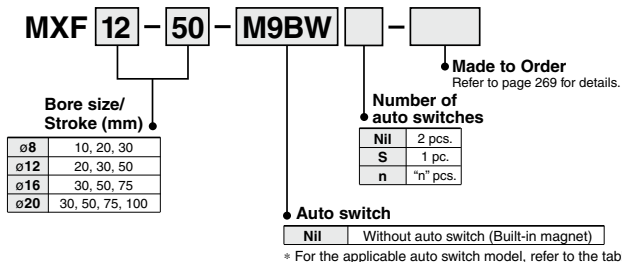

How to Order Stroke Adjusting Bolt (Accessory)

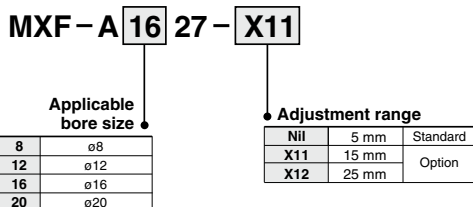

* -X12 (adjustable range 25 mm) is not available in the MXF8/MXF12 series.

Applicable Auto Switches

Refer to pages 1119 to 1245 for the detailed specifications of auto switches.

Type	Special function	Electrical entry	Indicator light	Wiring (Output)	Load voltage		Auto switch model		Lead wire length (m)			Pre-wired connector	Applicable load			
					DC	AC	Perpendicular	In-line	0.5 (Nil)	1 (M)	3 (L)			5 (Z)		
Solid state auto switch	—	Grommet	Yes	3-wire (NPN)	5V, 12V	—	M9NV	M9N	●	●	●	○	○	IC circuit		
				3-wire (PNP)			M9PV	M9P	●	●	●	○	○			
				2-wire	M9BV		M9B	●	●	○	○	○	—			
				3-wire (NPN)	M9NVV		M9NV	●	●	●	○	○	IC circuit			
	3-wire (PNP)			M9PVV	M9PV		●	●	●	○	○					
	Diagnostic indication (2-color indicator)			2-wire	M9BWW		M9BW	●	●	○	○	○	—			
				3-wire (NPN)	M9NAV ^{*1}		M9NA ^{*1}	○	○	●	○	○	IC circuit			
	Water resistant (2-color indicator)			3-wire (PNP)	M9PAV ^{*1}		M9PA ^{*1}	○	○	●	○	○				
				2-wire	M9BAV ^{*1}		M9BA ^{*1}	○	○	●	○	○	—			
	Reed auto switch			—	Grommet		Yes	3-wire (Equiv. to NPN)	—	5V	A96V	A96	●	—	—	—
None		2-wire	24V			12V		100V	A93V ^{*2}	A93	●	●	●	—	—	Relay, PLC
								100V or less	A90V	A90	●	—	—	—	—	

*1 Water resistant type auto switches can be mounted on the above models, but in such case SMC cannot guarantee water resistance.

*2 1 m type lead wire is only applicable to D-A93.

* Lead wire length symbols: 0.5 m Nil (Example) M9NW
 1 m M (Example) M9NWM
 3 m L (Example) M9NWL
 5 m Z (Example) M9NWX

* Solid state auto switches marked with " " are produced upon receipt of order.

* Since there are other applicable auto switches than listed, refer to page 277 for details.

* For details about auto switches with pre-wired connector, refer to pages 1192 and 1193.

* Auto switches are shipped together (not assembled).

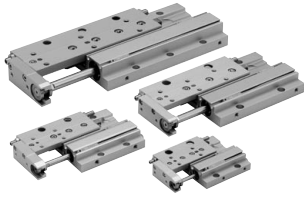

Specifications

Bore size (mm)	8	12	16	20
Piping port size	M3 x 0.5	M5 x 0.8		
Fluid	Air			
Action	Double acting			
Operating pressure	0.15 to 0.7 MPa			
Proof pressure	1.05 MPa			
Ambient and fluid temperature	-10 to 60°C			
Operating speed range (Average operating speed) ^(Note)	50 to 500 mm/s			
Cushion	Rubber bumper on both sides			
Lubrication	Non-lube			
Auto switch (Option)	Reed auto switch Solid state auto switch (2-wire, 3-wire) 2-color indicator solid state auto switch (2-wire, 3-wire)			
Stroke length tolerance	+ ₀ ¹ mm			
Stroke adjustment range	Extension end 5 mm/Retraction end 5 mm			

Note) Average operating speed: Speed that the stroke is divided by a period of time from starting the operation to reaching the end.

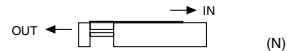

Theoretical Output

Bore size (mm)	Rod size (mm)	Operating direction	Piston area (mm ²)	Operating pressure (MPa)						
				0.2	0.3	0.4	0.5	0.6	0.7	
8	4	OUT	50	10	15	20	25	30	35	
		IN	38	8	11	15	19	23	27	
12	6	OUT	113	23	34	45	57	68	79	
		IN	85	17	26	34	43	51	60	
16	8	OUT	201	40	60	80	101	121	141	
		IN	151	30	45	60	76	91	106	
20	10	OUT	314	63	94	126	157	188	220	
		IN	236	47	71	94	118	142	165	

Note) Theoretical output (N) = Pressure (MPa) x Piston area (mm²)



Made to Order: Individual Specifications
(For details, refer to pages 278 and 279.)

Symbol	Specifications
-X7	PTFE grease
-X9	Grease for food processing machines
-X11	Adjusting bolt, long specification (Adjustment range: 15 mm)
-X33	Without built-in auto switch magnet
-X39	Fluororubber seal
-X42	Anti-corrosive specifications for guide unit
-X45	EPDM seal

Standard Stroke

Model	Standard stroke (mm)
MXF8	10, 20, 30
MXF12	20, 30, 50
MXF16	30, 50, 75
MXF20	30, 50, 75, 100

Weight

Model	Standard stroke (mm)					
	10	20	30	50	75	100
MXF8	120	130	170	—	—	—
MXF12	—	210	250	360	—	—
MXF16	—	—	360	500	690	—
MXF20	—	—	600	750	1060	1370

Moisture Control Tube IDK Series



When operating an actuator with a small diameter and a short stroke at a high frequency, the dew condensation (water droplet) may occur inside the piping depending on the conditions. Simply connecting the moisture control tube to the actuator will prevent dew condensation from occurring. For details, refer to [the IDK series in the Best Pneumatics No. 6](#).

MXH

MXS

MXQ

MXQ

MXF

MXW

MXJ

MXP

MXY

MTS

D-

-X

MXF Series

Table Deflection (Reference Values)

Table displacement due to pitch moment load

Table displacement when loads are applied to the section marked with the arrow at the full stroke.



Table displacement due to yaw moment load

Table displacement when loads are applied to the section marked with the arrow at the full stroke.

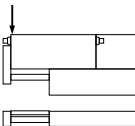
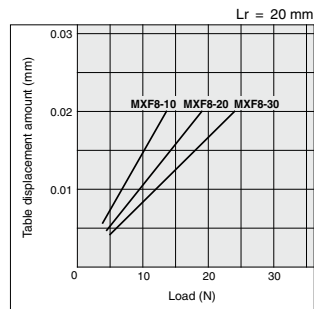
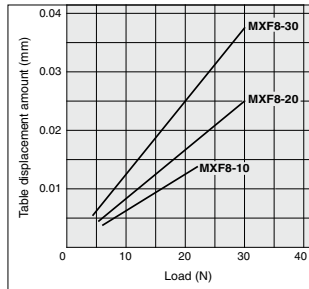
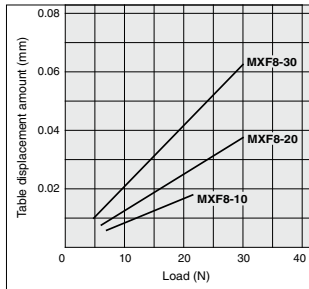

Table displacement due to roll moment load

Table displacement of section A when loads are applied to the section F with the slide table retracted.



MXF8



MXF12

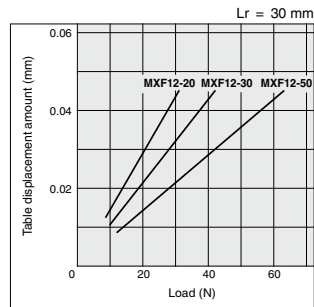
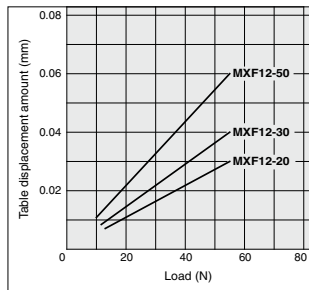
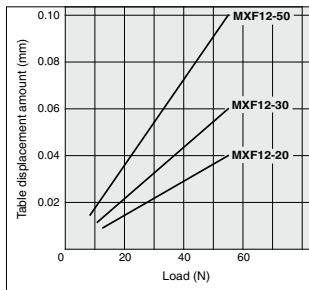

The graphs below show the table displacement when the static moment load is applied to the table. The graphs do not show the loadable mass. Refer to the Model Selection for the loadable mass.

Table displacement due to pitch moment load

Table displacement when loads are applied to the section marked with the arrow at the full stroke.

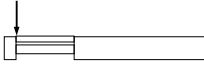

MXF16

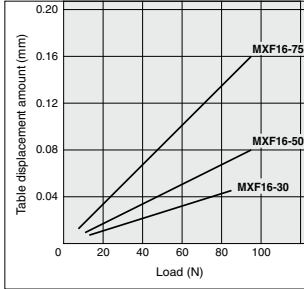

Table displacement due to yaw moment load

Table displacement when loads are applied to the section marked with the arrow at the full stroke.

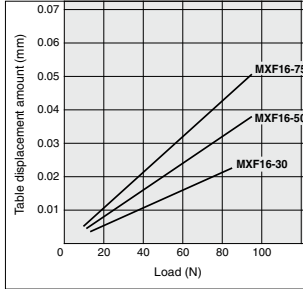
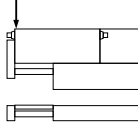
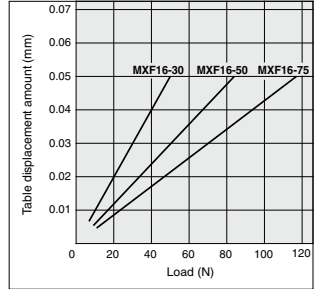
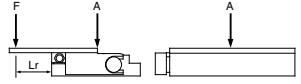
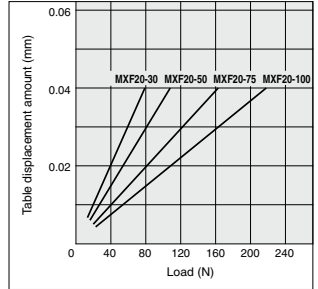
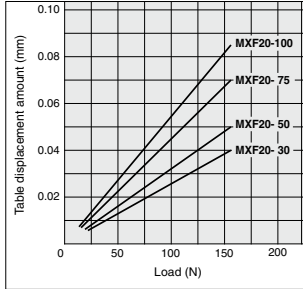
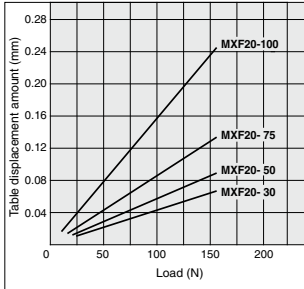

Table displacement due to roll moment load

Table displacement of section A when loads are applied to the section F with the slide table retracted.



MXF20



MXH

MXS

MXQ

MXQ

MXF

MXW

MXJ

MPX

MXV

MTS

D-

-X

MXF Series

Construction

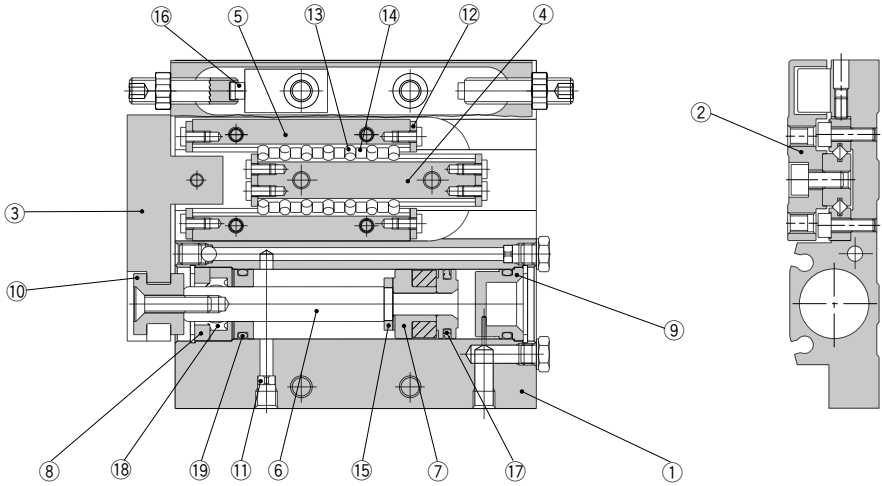

Component Parts

No.	Description	Material	Note
1	Body	Aluminum alloy	Hard anodized
2	Table	Aluminum alloy	Hard anodized
3	End plate	Aluminum alloy	Hard anodized
4	Rail	Carbon tool steel	Heat treated
5	Guide	Carbon tool steel	Heat treated
6	Rod	Stainless steel	
7	Piston assembly	—	With magnet
8	Seal support	Brass	Electroless nickel plated
9	Head cap	Resin	
10	Floating bushing	Stainless steel	
11	Orifice	Brass	Electroless nickel plated
12	Roller stopper	Stainless steel	
13	Cylindrical roller	High carbon chrome bearing steel	
14	Roller spacer	Resin	
15	Rod bumper	Polyurethane	

Component Parts

No.	Description	Material	Note
16	Adjust bumper	Polyurethane	
17	Piston seal	NBR	
18	Rod seal	NBR	
19	O-ring	NBR	

Replacement Parts: Seal Kit

Bore size (mm)	Kit no.	Contents
8	MXF8-PS	Set of nos. above 17 to 19
12	MXF12-PS	
16	MXF16-PS	
20	MXF20-PS	

* Seal kit includes 17, 18, 19. Order the seal kit, based on each bore size.

Replacement Part: Grease Pack

Applied part	Grease pack part no.
Guide	GR-S-010 (10g) GR-S-020 (20g)
Cylinder	GR-L-005 (5g) GR-L-010 (10g)

Dimensions: Stroke Adjustment Bolt

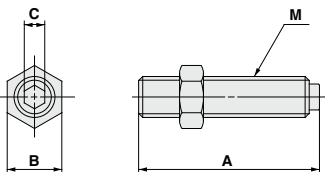

Applicable size	Model	Stroke adjustment range (mm)	A	B	C	M
MXF8	MXF-A827	5	17	6	2	M4 x 0.7
	MXF-A827-X11	15	27			
MXF12	MXF-A1227	5	23.5	7	2.5	M5 x 0.8
	MXF-A1227-X11	15	33.5			
	MXF-A1627	5	26.5			
MXF16	MXF-A1627-X11	15	36.5	8	3	M6 x 1
	MXF-A1627-X12	25	46.5			
	MXF-A2027	5	30			
MXF20	MXF-A2027-X11	15	40	12	4	M8 x 1
	MXF-A2027-X12	25	50			

Dimensions: **MXF8**

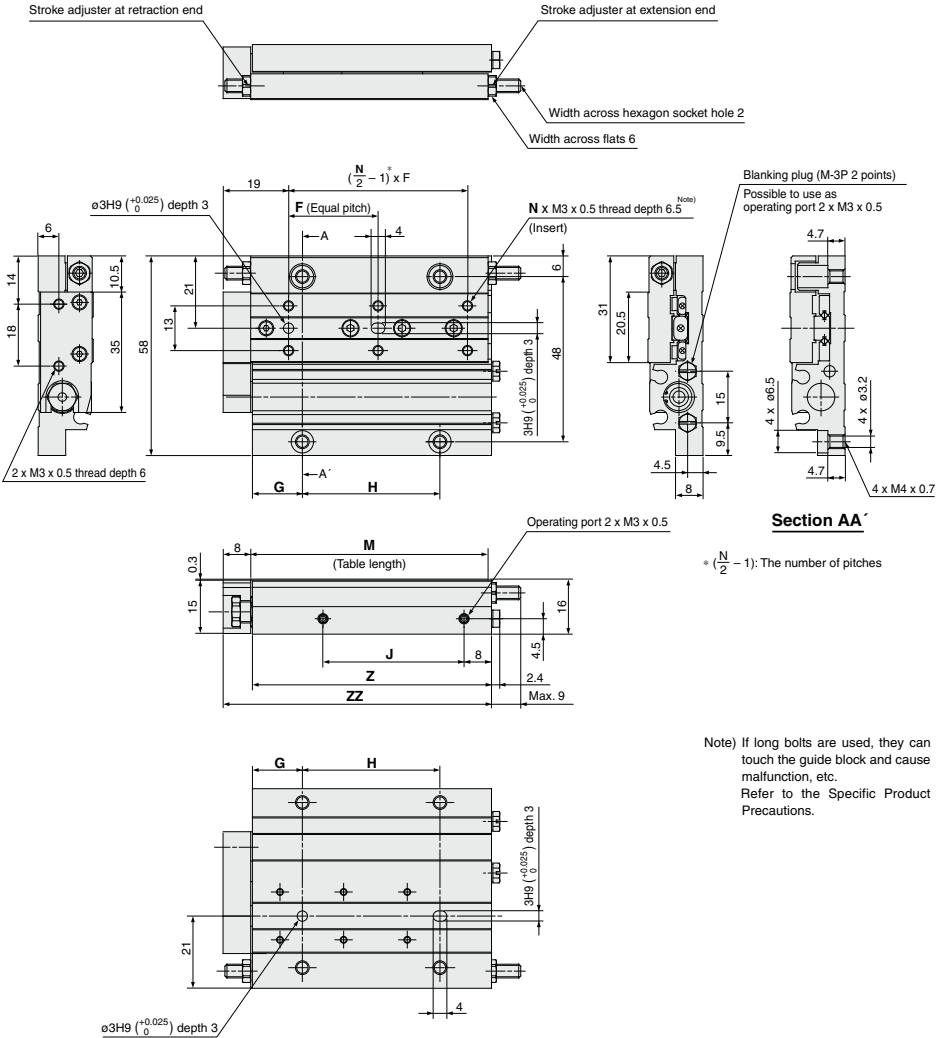

- MXH
- MXS
- MXQ
- MXF
- MXW
- MXJ
- MXP
- MXY
- MTS

(mm)

Model	F	N	G	H	J	M	Z	ZZ
MXF8-10	20	4	13.5	22	21	49	49.5	58
MXF8-20	26	4	14.5	26	26	54	54.5	63
MXF8-30	26	6	14.5	40	41	69	69.5	78

- D-□
- X□

MXF Series

Dimensions: MXF12

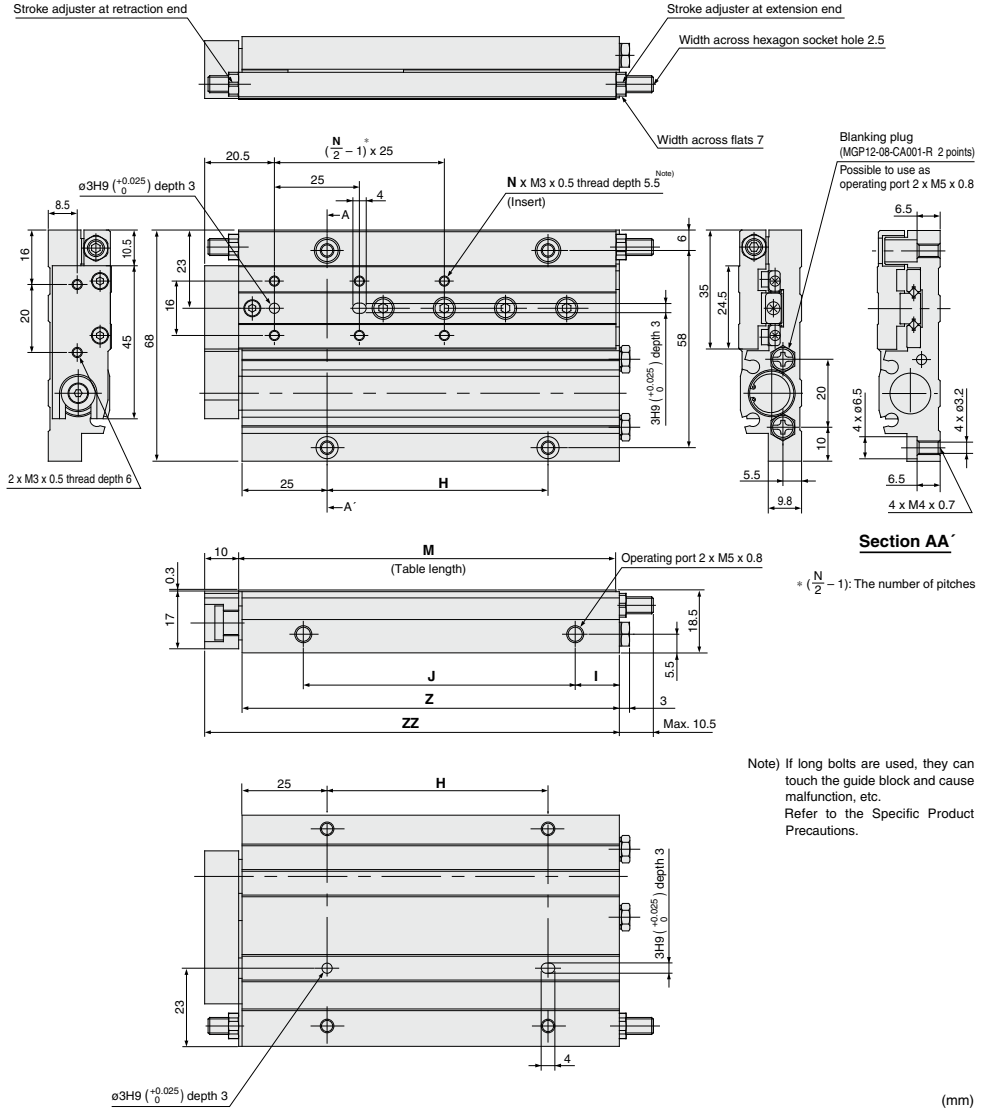

Model	N	H	I	J	M	Z	ZZ
MXF12-20	4	22	11	36	65	65	76
MXF12-30	4	30	12	45	75	75	86
MXF12-50	6	65	13	80	111	111	122

Dimensions: MXF16

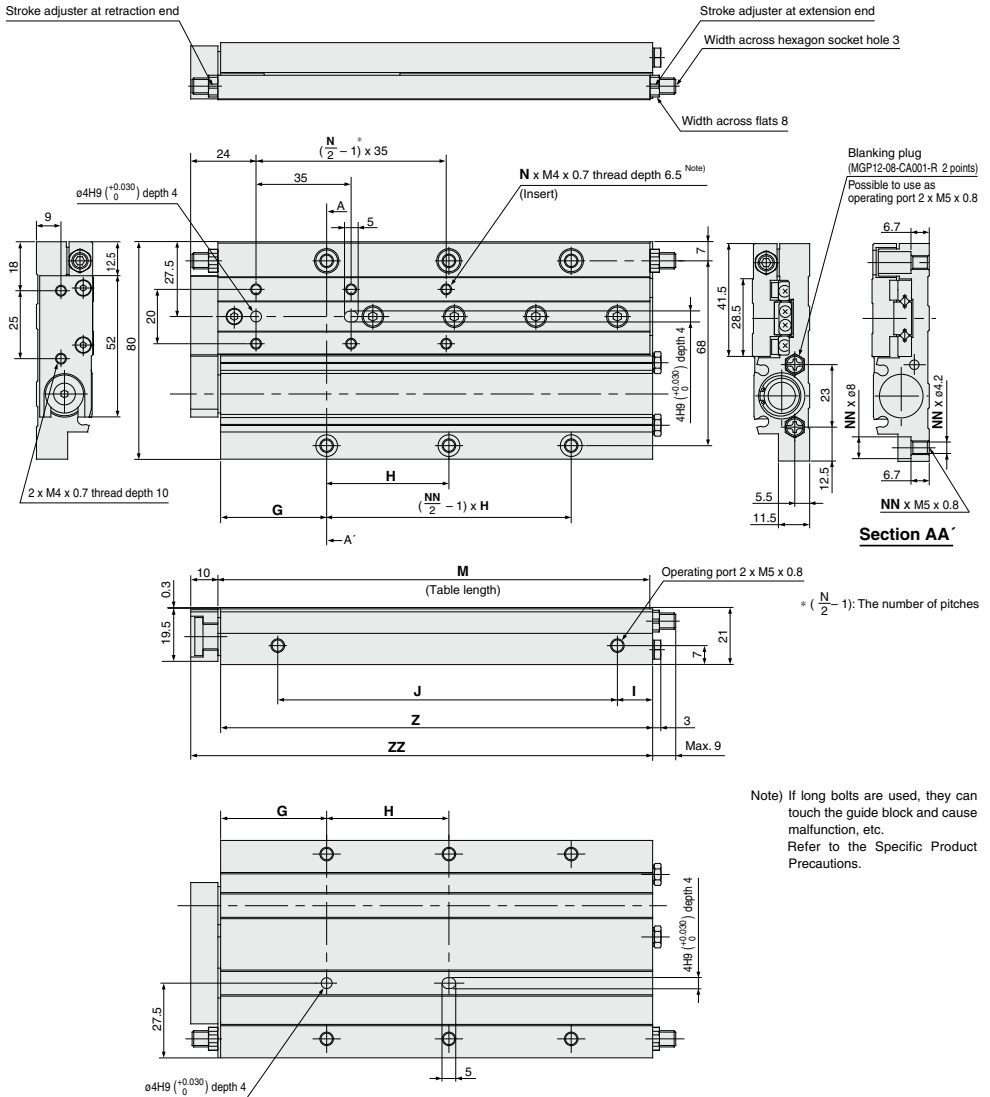

- MXH
- MXS
- MXQ
- MXQ
- MXF
- MXW
- MXJ
- MXP
- MXY
- MTS

	(mm)								
Model	N	G	H	NN	I	J	M	Z	ZZ
MXF16-30	4	29	25	4	12	50	83	83	94
MXF16-50	6	29	55	4	12	80	113	113	124
MXF16-75	6	39	45	6	13	125	159	159	170

- D-
- X

MXF Series

Dimensions: MXF20

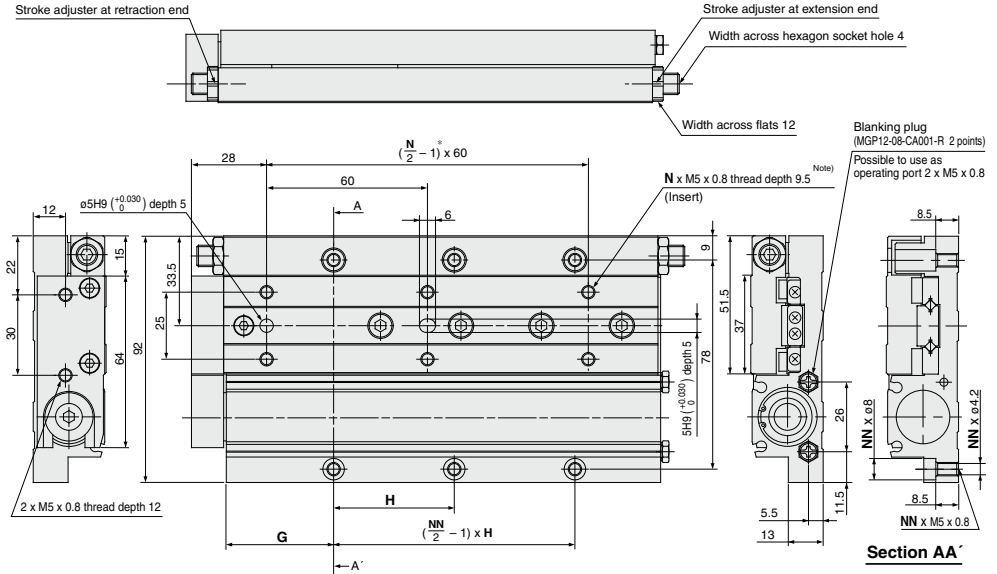

Blanking plug (MGP12-08-CA001-R 2 points)
Possible to use as operating port 2 x M5 x 0.8

Note)

* $\left(\frac{N}{2} - 1 \right)$: The number of pitches

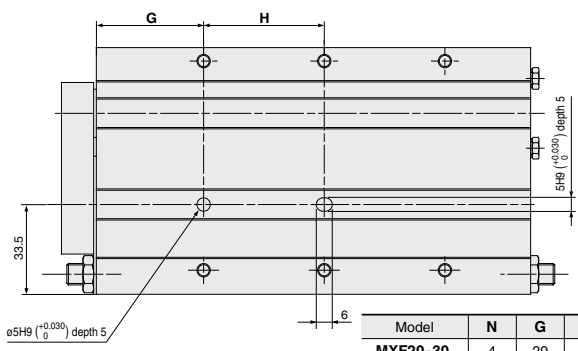
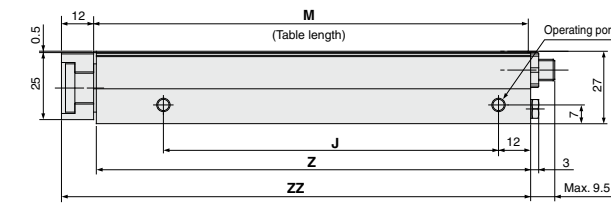

Note) If long bolts are used, they can touch the guide block and cause malfunction, etc. Refer to the Specific Product Precautions.

Model	N	G	H	NN	J	M	Z	ZZ
MXF20-30	4	29	30	4	57	91	91	104
MXF20-50	4	36	45	4	77	113	113	126
MXF20-75	6	40	45	6	125	162	162	175
MXF20-100	6	59	60	6	175	211	211	224

Auto Switch Mounting

Auto Switch Proper Mounting Position (Detection at Stroke End)

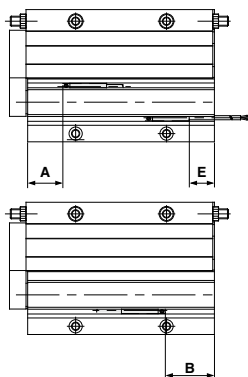

Reed Auto Switch: D-A90, D-A93, D-A96, D-A90V, D-A93V, D-A96V (mm)

Model	A	B						E						
		Stroke						Stroke						
		10	20	30	50	75	100	10	20	30	50	75	100	
MXF8	9.5	10	5	10	—	—	—	8 (5.5)	3 (0.5)	8 (5.5)	—	—	—	—
MXF12	12	—	13.1	13.1	29.1	—	—	11.1 (8.6)	11.1 (8.6)	27.1 (24.6)	—	—	—	—
MXF16	17.2	—	—	15.8	25.8	46.8	—	—	13.8 (11.3)	23.8 (21.3)	44.8 (42.3)	—	—	—
MXF20	19.4	—	—	20.7	22.7	46.2	70.7	—	—	18.7 (16.2)	20.7 (18.2)	44.2 (41.7)	68.7 (66.2)	—

Solid State Auto Switch: D-M9B, D-M9N, D-M9P, D-M9BV, D-M9NW, D-M9PW, D-M9□A (mm)

Model	A	B						E						E (D-M9□A)					
		Stroke						Stroke						Stroke					
		10	20	30	50	75	100	10	20	30	50	75	100	10	20	30	50	75	100
MXF8	13.5	14	9	14	—	—	—	4	-1	4	—	—	—	2	-3	2	—	—	—
MXF12	16	—	17.1	17.1	33.1	—	—	7.1	7.1	23.1	—	—	—	5.1	5.1	21.1	—	—	—
MXF16	21.2	—	—	19.8	29.8	50.8	—	—	—	9.8	19.8	40.8	—	—	—	7.8	17.8	38.8	—
MXF20	23.4	—	—	24.7	26.7	50.2	74.7	—	—	14.7	16.7	40.2	64.7	—	—	12.7	14.7	38.2	62.7

Solid State Auto Switch: D-M9BV, D-M9NV, D-M9PV, D-M9BVV, D-M9NVV, D-M9PWV, D-M9□AV (mm)

Model	A	B						E						E (D-M9□AV)					
		Stroke						Stroke						Stroke					
		10	20	30	50	75	100	10	20	30	50	75	100	10	20	30	50	75	100
MXF8	13.5	14	9	14	—	—	—	6	1	6	—	—	—	4	-1	4	—	—	—
MXF12	16	—	17.1	17.1	33.1	—	—	9.1	9.1	25.1	—	—	—	7.1	7.1	23.1	—	—	—
MXF16	21.2	—	—	19.8	29.8	50.8	—	—	—	11.8	21.8	42.3	—	—	—	9.8	19.8	40.3	—
MXF20	23.4	—	—	24.7	26.7	50.2	74.7	—	—	16.7	18.7	42.2	66.7	—	—	14.7	16.7	40.2	64.7

* (): Denotes the values of D-A93.

Note) Adjust the auto switch after confirming the operating conditions in the actual setting.

Auto Switch Mounting



Auto Switch Mounting Tool

When adjusting the auto switch mounting screw (included with auto switch), use a watchmaker's screwdriver with a handle about 5 to 6 mm in diameter.

Tightening Torque

Tightening Torque of Auto Switch Mounting Screw (N·m)

Auto switch model	Tightening torque
D-A9□(V)	0.10 to 0.20
D-M9□(V) D-M9□W(V) D-M9□A, M9□AV	0.05 to 0.15

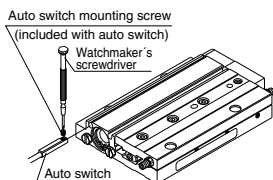

Operating Range

Auto switch model	Applicable bore size (mm)			
	8	12	16	20
D-A9□(V)	4.5	5	6	7
D-M9□, M9□V D-M9□W, M9□WV D-M9□A, M9□AV	3	3	4.5	5

* Since the operating range is provided as a guideline including hysteresis, it cannot be guaranteed (assuming approximately ±30% dispersion). It may vary substantially depending on an ambient environment.

Other than the models listed in "How to Order", the following auto switches are applicable.

* Normally closed (NC = b contact) solid state auto switches (D-F9G/F9H types) and solid state auto switch D-F8 are also available. For details, refer to pages 1136 and 1137.

MXH

MXS

MXQ

MXQ

MXF

MXW

MXJ

MXP

MXY

MTS

D-□

X-□



1 PTFE Grease Symbol -X7

MXF Standard model no. — X7
 ● PTFE grease

PTFE grease is used for all parts that grease is applied.

Specifications

Type	PTFE grease
Bore size (mm)	8, 12, 16, 20

* Dimensions other than the above is the same as the standard type.

⚠ Warning

Precautions

Be aware that smoking cigarettes, etc. after your hands have come into contact with the grease used in this cylinder can create a gas that is hazardous to humans.

2 Grease for Food Processing Machines Symbol -X9

MXF Standard model no. — X9
 ● Grease for food processing machines

Grease for food processing machines is used for all parts that grease is applied.

Specifications

Type	Grease for food processing machines (NSF-H1 certified)/Aluminum complex soap base grease
Bore size (mm)	8, 12, 16, 20

* Dimensions other than the above is the same as the standard type.

⚠ Caution

Do not use this cylinder in a food-related environment.

<Cannot be mounted>

Food zone--Food may directly contact with this cylinder, and is treated as food products.

<Can be mounted>

Splash zone--Food may directly contact with this cylinder, but is not treated as food products.

Non-food zone--This cylinder do not directly contact food.

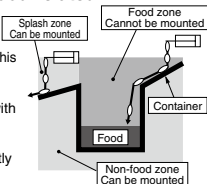

3 Without Built-in Auto Switch Magnet Symbol -X33

MXF Standard model no. — X33
 ● Without built-in auto switch magnet

Auto switch magnet is not built in.

Specifications

Type	Without built-in auto switch magnet
Bore size (mm)	8, 12, 16, 20
Auto switch	Not mountable

* Dimensions other than the above is the same as the standard type.

4 Fluororubber Seal Symbol -X39

MXF Standard model no. — X39
 ● Fluororubber seal

Change the materials for the piston seal, rod seal and O-rings to fluororubber.

Specifications

Type	Fluororubber seal
Bore size (mm)	8, 12, 16, 20
Seal material	Fluororubber

* Dimensions other than the above is the same as the standard type.

5 Anti-corrosive Specifications for Guide Unit Symbol -X42

MXF Standard model no. — X42
 ● Anti-corrosive specifications for guide unit

Rail and guide are given anti-corrosive treatment.

Specifications

Type	Anti-corrosive guide unit
Bore size (mm)	8, 12, 16, 20
Surface treatment	Special anti-corrosive treatment (2)

* 1 Dimensions other than the above is the same as the standard type.

* 2 Special anti-corrosive treatment makes the rail and the guide black.

6 EPDM Seal Symbol -X45

MXF Standard model no. — X45
 ● EPDM seal

Change the materials for the piston seal, rod seal and O-rings to EPDM.

Specifications

Type	EPDM seal
Bore size (mm)	8, 12, 16, 20
Seal material	EPDM
Grease	PTFE grease

* Dimensions other than the above is the same as the standard type.

⚠ Warning

Precautions

Be aware that smoking cigarettes, etc. after your hands have come into contact with the grease used in this cylinder can create a gas that is hazardous to humans.

MXF Series

Made to Order: Individual Specifications 2



Please contact SMC for detailed dimensions, specifications and lead times.

7 Adjusting Bolt, Long Specification (Adjustment range: 15 mm)

Symbol
-X11

MXF Standard model no. — X11

- Adjusting bolt, long specification (Adjustment range: 15 mm)

The average adjusting stroke range was extended from 5 mm to 15 mm with a long adjusting bolt.

Dimensions

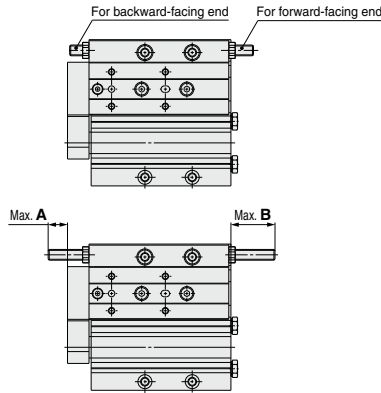

(mm)		
Model	A	B
MXF8	10	19
MXF12	10	20.5
MXF16	10	19
MXF20	10	19.5

- MXH
- MXS
- MXQ
- MXQ
- MXF
- MXW
- MXJ
- MXP
- MXY
- MTS

- D-
- X



MXF Series Specific Product Precautions

Be sure to read this before handling the products. Refer to back page 50 for Safety Instructions and pages 3 to 12 for Actuator and Auto Switch Precautions.

Mounting

⚠ Caution

- Do not scratch or dent the mounting side of the body, table or end plate. It causes play in the guide section and increases sliding resistance.
- Do not scratch or dent on the forward side of the rail or guide. It will result in looseness of the guide section and increased sliding resistance.
- Keep away from objects which are influenced by magnets.
As the piston part has magnets built-in, do not allow close contact with magnetic disks, magnetic cards or magnetic tapes. Data may be erased.
- When mounting the body, use screws with appropriate length and do not exceed the maximum tightening torque. Tightening with a torque above the limit could malfunction. Whereas tightening insufficiently could result in misalignment or come to a drop.
- Be careful when adjusting stroke not to allow cylinder end plate to bottom out against cylinder body.

Mounting of Body

The slide table can be mounted from 2 directions. Select the best direction according to your application.

1. Body Tapped

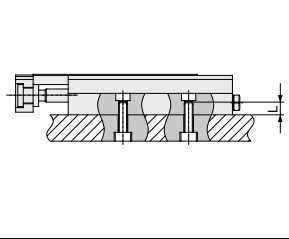

Model	Bolt	Maximum tightening torque (N·m)	Maximum screw-in depth L (mm)
MXF8	M4 x 0.7	2.1	4.7
MXF12	M4 x 0.7	2.1	6.5
MXF16	M5 x 0.8	4.4	6.7
MXF20	M5 x 0.8	4.4	8.5

2. Body Through-hole

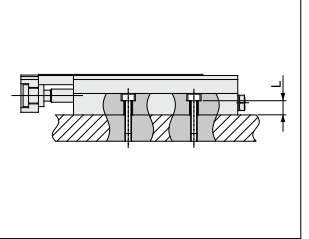

Model	Bolt	Maximum tightening torque (N·m)	Maximum screw-in depth L (mm)
MXF8	M3 x 0.5	1.2	4.7
MXF12	M3 x 0.5	1.2	6.5
MXF16	M4 x 0.7	2.8	6.7
MXF20	M4 x 0.7	2.8	8.5

- ⚠ **Caution** 0.02 mm or less of flatness is recommended for the body mounting surface. An uneven mounting surface of a workpiece or a base may cause vibration or increase sliding resistance.

Positioning

⚠ Caution

- The positioning hole on the table and on the bottom of the body does not have the same center. Positioning hole is meant to be for reproducibility for mounting and dismounting.

Selection

⚠ Caution

- If intermediate stop by external stopper is done, avoid ejection.
If ejection occurs, it may cause damage. In the case the slide table is stopped at an intermediate position by an external stopper then forwarded to the front, return the slide table to the back for just a moment to retract the stopper, then supply pressure to the opposite port to operate slide table.
- Do not use it in such a way that excessive external force or impact force could work on it.
This could result in damage.

Mounting of Workpiece

Work can be mounted on two sides of the body.

1. Front Mounting

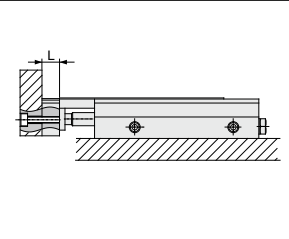

Model	Bolt	Maximum tightening torque (N·m)	Maximum screw-in depth L (mm)
MXF8	M3 x 0.5	0.9	6
MXF12	M3 x 0.5	0.9	6
MXF16	M4 x 0.7	2.1	10
MXF20	M5 x 0.8	4.4	12

2. Top Mounting

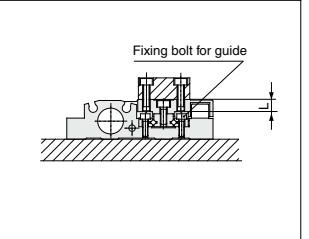

Model	Bolt	Maximum tightening torque (N·m)	Maximum screw-in depth L (mm)
MXF8	M3 x 0.5	0.9	6.5
MXF12	M3 x 0.5	0.9	5.5
MXF16	M4 x 0.7	2.1	6.5
MXF20	M5 x 0.8	4.4	9.5

⚠ Caution

To prevent the workpiece holding bolts from touching the guide holding bolts, use bolts that are 0.5 mm or more shorter than the maximum screw-in depth.
If the bolts are too long, they hit the end plate and may cause malfunctions.