

Rotary Clamp Cylinder

MK2T Series

Double Guide Type

Improved non-rotating accuracy and rotation angle!

Rotation mechanism uses **2** guide rollers.

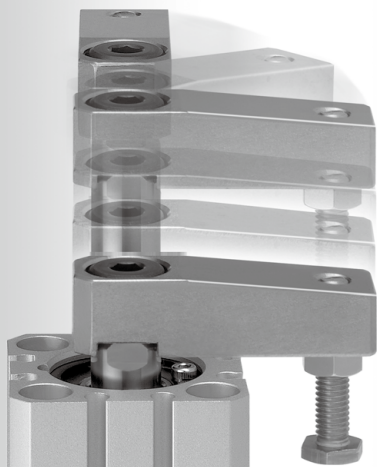

Rotation mechanism



Piston rod
Rod cover
Guide roller

Non-rotating accuracy: $\pm 0.9^\circ \Rightarrow \pm 0.5^\circ$
(Clamp part) * Values for $\phi 32, \phi 40$. Comparison with our MK2 series

Rotation angle: $90^\circ \pm 10^\circ \Rightarrow 90^\circ \pm 5^\circ$

3 times the allowable moment of inertia
 $\phi 32, \phi 40$ * Comparison with our MK2 series

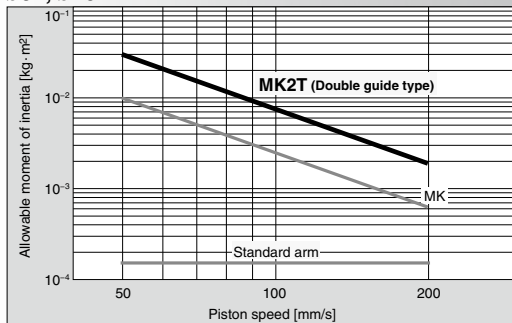

Horizontal mounting possible

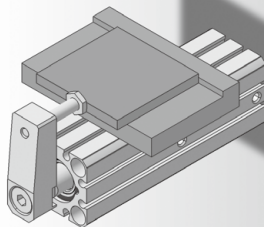

- Interchangeable mounting pitch (MK)
- Small auto switches mountable on 4 surfaces * Bore size $\phi 20, \phi 25$

MK2T Series Model Selection

Item	Series	MK2T
Max. piston speed <small>Note)</small> [mm/s]	ø12, ø16	—
	ø20, ø25	200
	ø32 to ø63	200
Non-rotating accuracy (Clamp part)	ø12	—
	ø16	—
	ø20, ø25	±1.0°
	ø32, ø40	±0.5°
	ø50, ø63	±0.5°
Rotation angle		90°±5°
Horizontal mounting		Allowed

Note) "Maximum piston speed" indicates the maximum speed possible when employing a standard arm.

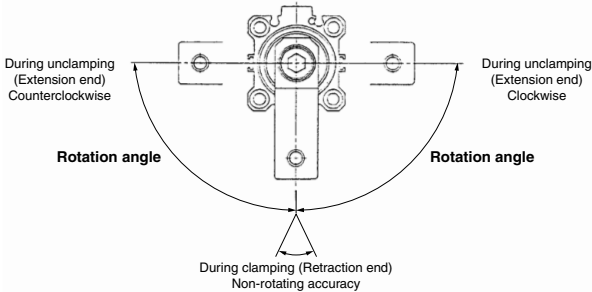

[Actual calculation example]

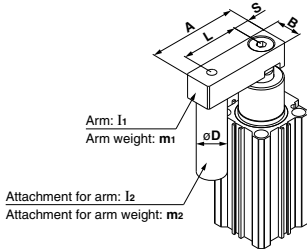

Example) Find the moment of inertia of the arm.

$$I_1 = m_1 \cdot \frac{A^2 + B^2}{12} + m_1 \cdot \left(\frac{A}{2} - S \right)^2$$

Find the moment of inertia of the attachment for arm.

$$I_2 = m_2 \cdot \frac{D^2}{8} + m_2 \cdot L^2$$

(Calculation example) Cylinder bore size ø32

$A = 0.1$ m, $B = 0.035$ m, $S = 0.012$ m, $L = 0.075$ m, $D = 0.024$ m
 $m_1 = 0.96$ kg, $m_2 = 0.32$ kg

$$I_1 = 0.96 \times \frac{0.1^2 + 0.035^2}{12} + 0.96 \times \left(\frac{0.1}{2} - 0.012 \right)^2 = 2.3 \times 10^{-3} \text{ kg} \cdot \text{m}^2$$

$$I_2 = 0.32 \times \frac{0.024^2}{8} + 0.32 \times 0.075^2 = 1.8 \times 10^{-3} \text{ kg} \cdot \text{m}^2$$

Find the actual moment of inertia.

$$I = I_1 + I_2 = (2.3 + 1.8) \times 10^{-3} = 4.1 \times 10^{-3} \text{ kg} \cdot \text{m}^2$$

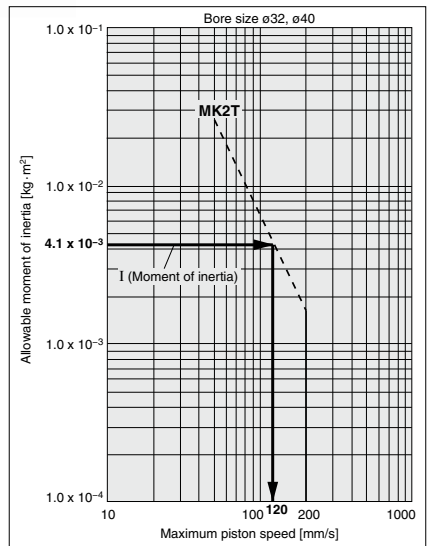

Calculation Example (ø32, clamp stroke 10 mm)

Max. piston speed	Average piston speed <small>Note 1)</small>	Stroke total	Stroke time <small>Note 2)</small>
120 mm/s	75 mm/s	39 mm	0.52 sec.

Note 1) Average piston speed = Maximum piston speed ÷ 1.6.

Note 2) Please use the stroke speeds indicated above.

Moment of Inertia

ø20, ø25

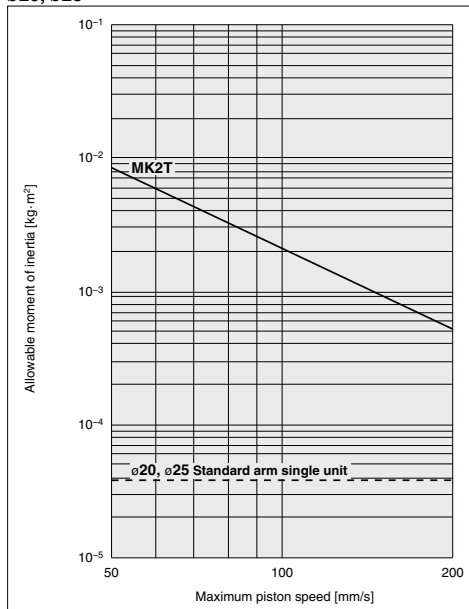

ø32, ø40

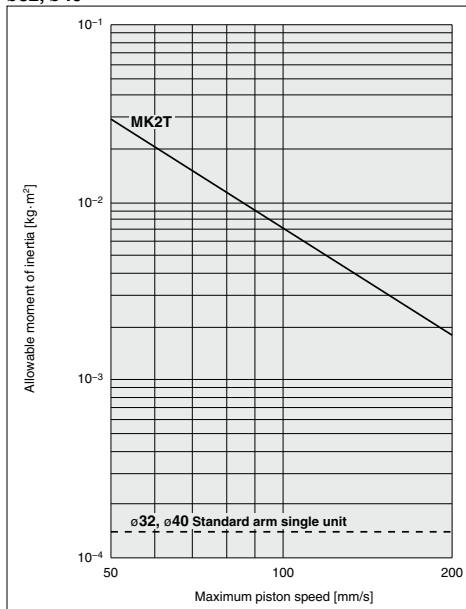

ø50, ø63

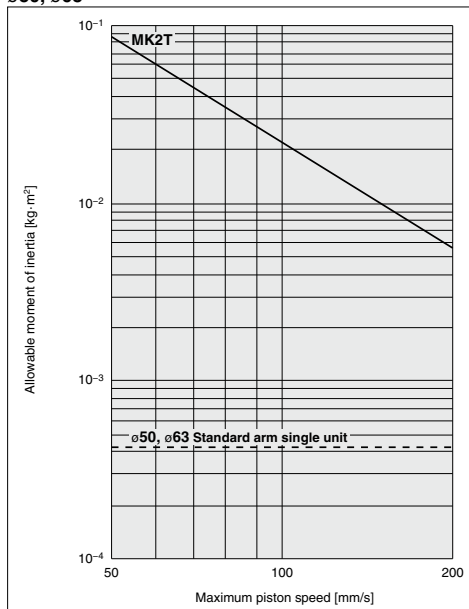

Note 1) Maximum piston speed is equivalent to approximately 1.6x the average piston speed. (Rough indication)

Note 2) The moment of inertia of the standard arm single unit is the value for the arm only. The values of accessories are not included.

Rotary Clamp Cylinder: Double Guide Type

MK2T Series

ø20, ø25, ø32, ø40, ø50, ø63

How to Order

MK2T B 20 - **10 R N** - **M9BW** -

Rotary clamp cylinder
Double guide type

Mounting bracket

B	Through-hole/Both ends tapped common (Standard)
G	Head end flange

* Mounting bracket is included, (but not assembled).

Bore size

20	20 mm	40	40 mm
25	25 mm	50	50 mm
32	32 mm	63	63 mm

Cylinder port

Nil	M thread	ø20, ø25
	Rc	
TN	NPT	ø32 to ø63
	G	
TF	G	

Clamp stroke

Symbol	Clamp stroke	Applicable bore size
10	10 mm	ø20 to ø40
20	20 mm	ø20 to ø63
50	50 mm	ø50 to ø63

Number of auto switches

Nil	2 pcs.
S	1 pc.

Auto switch type

Nil	Without auto switch (Built-in magnet)
N	With arm

* For applicable auto switch models, refer to the below table.

Body option

Nil	Standard (Female thread)
N	With arm

* Arms are included when shipped, (but not assembled).

Made to Order
(Refer to page 423.)

Rotary direction
(Unclamp → Clamp)

R	Clockwise
L	Counterclockwise

Applicable Auto Switches

Refer to pages 1341 to 1435 for further information on auto switches.

Type	Special function	Electrical entry	Indicator light	Wiring (Output)	Load voltage		Auto switch model		Lead wire length (m)					Pre-wired connector	Applicable load	
					DC	AC	Perpendicular (Nil)	In-line (L)	0.5 (M)	1 (Z)	3 (L)	5 (Z)	None (N)			
																ø20, ø25
Solid state auto switch	—	Grommet	Yes	3-wire (NPN)	24 V	—	5 V, 12 V	M9NV	M9N	●	●	●	●	○	IC circuit	
				3-wire (PNP)				M9PV	M9P	●	—	○	○	○		
		Connector	2-wire	12 V	M9BV	M9B	●	—	●	○	○	—				
		—	J79C	—	—	●	—	●	●	●	—					
	Diagnostic indication (2-color indicator)	Grommet	Yes	3-wire (NPN)	24 V	—	5 V, 12 V	M9NVW	M9NW	●	●	●	●	○	IC circuit	
				3-wire (PNP)				M9PWW	M9PW	●	●	●	●	○		
		Water resistant (2-color indicator)	Grommet	Yes	3-wire (NPN)	24 V	—	5 V, 12 V	M9BWW	M9BW	●	●	●	●	○	—
					3-wire (PNP)				M9NAV*1	M9NA*1	○	○	●	○	○	
		Diagnostic output (2-color indicator)	Grommet	Yes	2-wire	24 V	—	5 V, 12 V	M9PAV*1	M9PA*1	○	○	●	○	○	—
					4-wire				M9BAV*1	M9BA*1	○	○	●	○	○	
Magnetic field resistant (2-color indicator)	Grommet	Yes	2-wire (No polarity)	24 V	—	—	—	F79F	●	—	●	○	○	IC circuit		
			—				P3DWA***	●	—	●	●	●	—			
—	Grommet	Yes	3-wire (NPN equivalent)	24 V	—	5 V	A96V	A96	●	—	●	—	—	IC circuit		
							—	200 V	A72	—	A72H	●	—		●	—
Reed auto switch	—	Grommet	No	2-wire	24 V	—	12 V	100 V	A93V*2	A93	●	●	●	●	—	
							5 V, 12 V	100 V or less	A90V	A90	●	—	●	—		IC circuit
		Connector	No	12 V	—	A73C	—	—	—	—	—	●	●	●	—	
				5 V, 12 V	24 V or less	A80C	—	—	—	—	—	—	●	●		●
		Diagnostic indication (2-color indicator)	Grommet	Yes	—	—	—	—	A79W	—	—	—	—	—	—	—
					—	—	—	—	—	—	—	—	—	—	—	

*1 Water resistant type auto switches can be mounted on the above models, but in such case SMC cannot guarantee water resistance. Consult with SMC regarding water resistant types with the above model numbers.

*2 1 m type lead wire is only applicable to D-A93.

* Lead wire length symbols: 0.5 m Nil (Example) M9NV
 1 m M (Example) M9NVW
 3 m L (Example) M9NVWL
 5 m Z (Example) M9NVWZ
 None N (Example) J79CN

* Solid state auto switches marked with "○" are produced upon receipt of order.
 ** For D-P4DW, ø40 to ø63 are available.
 *** Only D-P4DW type is assembled at the time of shipment.
 **** The D-P3DWA□ is mountable on bore size ø25 to ø63.

* Since there are other applicable auto switches than listed, refer to page 429 for details.

* For details about auto switches with pre-wired connector, refer to pages 1410 and 1411.

* When D-M9□(V)/M9□W(V)/M9□A(V)/A9□(V) types with ø32 to ø50 are mounted on a side other than the port side, order auto switch mounting brackets separately. Refer to page 430 for details.

* Auto switches are shipped together (not assembled).



Rotary Angle

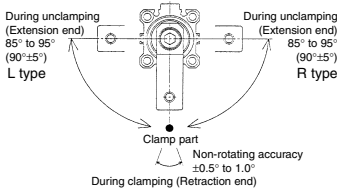

Made to Order
Made to Order: Individual Specifications
 (For details, refer to page 431.)

Symbol	Description
-X1859	With head end pin hole

Made to Order

[Click here for details](#)

Symbol	Specifications
-XC89	Spatter resistant coil scraper, Lube-retainer, Grease for welding (Piston rod: S45C)
-XC91	Spatter resistant coil scraper, Grease for welding (Piston rod: S45C)

Option/Arm

Bore size (mm)	Part no.	Accessories
20	MK-A020Z	Clamp bolt,
25	MK-A025Z	Hexagon socket head cap screw,
32	MK-A032Z	Hexagon nut,
40	MK-A040Z	Spring washer
50	MK-A050Z	
63	MK2T-A063	

Mounting Bracket/Flange

Bore size (mm)	Part no.	Accessories
20	CQS-F020	
25	CQS-F025	
32	MK2T-F032	Hexagon socket head cap screw
40	MK2T-F040	
50	MK2T-F050	
63	MK2T-F063	

Specifications

Bore size (mm)	20	25	32	40	50	63
Action	Double acting					
Rotation angle <small>Note 1)</small>	90° ±5°					
Rotary direction <small>Note 2)</small>	Clockwise, Counterclockwise					
Rotary stroke (mm)	19		29			33
Clamp stroke (mm)	10, 20			20, 50		
Theoretical clamp force (N) <small>Note 3)</small>	100	185	300	525	825	1300
Fluid	Air					
Proof pressure	1.5 MPa					
Operating pressure range	0.1 to 1 MPa					
Ambient and fluid temperature	Without auto switch: -10 to 70°C (No freezing)					
	With auto switch: -10 to 60°C (No freezing)					
Lubrication	Non-lube					
Piping port size	M5 x 0.8		Rc1/8, NPT1/8, G1/8		Rc1/4, NPT1/4, G1/4	
Mounting	Through-hole/Both ends tapped common, Head end flange					
Cushion	Rubber bumper					
Stroke length tolerance	+1.0 0					
Piston speed	50 to 200 mm/s					
Non-rotating accuracy (Clamp part)	±1.0°			±0.5°		

Note 1) Refer to "Rotary Angle" figure.

Note 2) Direction of rotation viewed from the rod end when the piston rod is retracting.

Note 3) At 0.5 MPa.

Theoretical Output

Bore size (mm)	Rod size (mm)	Operating direction	Piston area (cm ²)	Operating pressure (MPa)				Unit: N
				0.3	0.5	0.7	1.0	
20	12	R	2	60.8	100	139	200	
		H	3	90.2	149	208	298	
25	12	R	3.7	112	185	258	370	
		H	4.9	149	245	341	490	
32	16	R	6	182	300	418	600	
		H	8	243	400	557	800	
40	16	R	10.5	319	525	731	1050	
		H	12.5	380	625	870	1250	
50	20	R	16.5	502	825	1149	1648	
		H	19.6	596	980	1365	1961	
63	25	R	26	780	1300	1820	2600	
		H	31.2	948	1560	2172	3121	

Note) Theoretical output (N) = Pressure (MPa) x Piston area (cm²) x 100

Operating direction

R: Rod end (Clamp)

H: Head end (Unclamp)

Weight/Through-hole Mounting

Clamp stroke (mm)	Bore size (mm)						Unit: g
	20	25	32	40	50	63	
10	367	448	806	1008	—	—	
20	433	520	914	1127	2049	2609	
50	—	—	—	—	2672	3354	

Additional Weight

Bore size (mm)	20	25	32	40	50	63	Unit: g
With arm	100	100	200	200	350	600	
Head end flange (including mounting bolt)	133	153	166	198	345	531	

Calculation: (Example) MK2TG20-10RN

• Standard calculation: MK2TB20-10R 367 g

• Extra weight calculation: Head end flange 133 g

With arm 100 g

600 g

MK2T Series

Construction

MK2T□20 to 63

With arm (N)

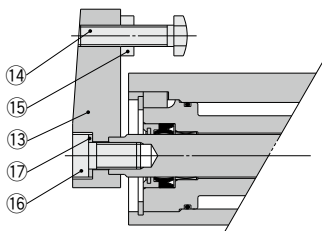

Head end flange (G)

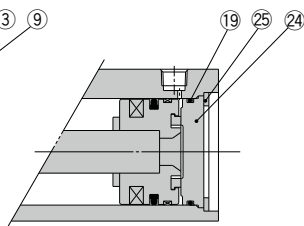
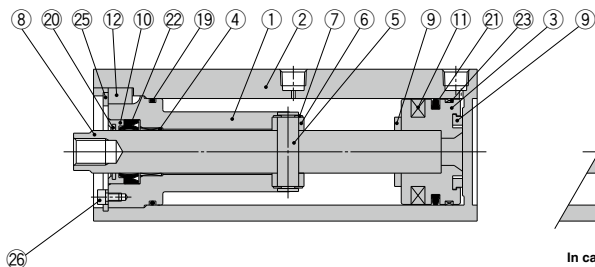
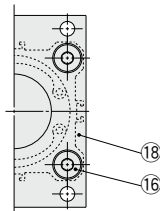

In case of clamp stroke 50 mm

Component Parts

No.	Description	Material	Note
1	Rod cover	Structural steel	
2	Cylinder tube	Aluminum alloy	
3	Piston	Aluminum alloy	
4	Bushing	Oil-impregnated sintered alloy	ø20, 25
		Bronze casted	ø32 to 63
		Stainless steel	ø20, 25
5	Guide shaft	Stainless steel	ø20, 25
		Structural steel	ø32 to 63
6	Guide roller	Structural steel	
7	Retaining ring	Steel for special applications	ø20, 25
		Stainless steel	ø32 to 63
8	Piston rod	Stainless steel	ø20, 25
		Structural steel	ø32 to 63
9	Bumper	Urethane	
10	Seal retainer	Aluminum alloy	
11	Magnet	—	
12	Key	Structural steel	

Component Parts

No.	Description	Material	Note
13	Arm	Structural steel	
14	Clamp bolt	Structural steel	
15	Hexagon nut	Structural steel	
16	Hexagon socket head cap screw	Structural steel	
17	Spring washer	Steel wire	
18	Flange	Structural steel	
19	Gasket	NBR	
20	Coil scraper	Bronze	
21	Piston seal	NBR	
22	Rod seal	NBR	
23	Wear ring	Resin	
24	Bottom plate	Aluminum alloy	
25	Retaining ring	Steel for special applications	
		Hexagon socket head cap screw (with SW)	Structural steel
26	Washer	Stainless steel	ø25, ø32 only
		Hexagon socket head cap screw	Structural steel

Replacement Parts: Seal Kit

Bore size (mm)	20	25	32	40	50	63
Kit no.	MK2T20-PS	MK2T25-PS	MK2T32-PS	MK2T40-PS	MK2T50-PS	MK2T63-PS
Content	Set of nos. above 19 20 21 22					

* Seal kit includes 19, 20, 21, 22. Order the seal kit, based on each bore size.

⚠ Precautions

Be sure to read this before handling the products. Refer to page 9 for safety instructions and pages 10 to 19 for actuator and auto switch precautions.

⚠ Caution

Clamp Arm Mounting

- Use a clamp arm that is available as an option. To fabricate a clamp arm, make sure that the allowable bending moment and the inertial moment will be within the specified range. If a clamp arm that exceeds the specified value is installed, the internal mechanism in the cylinder could become damaged.

Ensuring Safety

- If one side of the piston is pressurized by supplying air with the clamp arm attached, the piston will move vertically while the clamp arm rotates. This operation could be hazardous to personnel, as their hands or feet could get caught by the clamp arm, or could lead to equipment damage. Therefore, it is important to secure as a danger zone a cylindrical area with the length of the clamp arm as its radius, and the stroke plus 20 mm as its height.

Installation and Adjustment/ Clamp Arm Removal and Reinstallation

- During the removal or reinstallation of the clamp arm, make sure to use a wrench or a vise to secure the clamp arm before removing or tightening the bolt. This is to prevent the bolt tightening torque from being applied to the piston rod, which could damage the cylinder's internal mechanism.

Mounting Bolt for MK2TB

Mounting: Mounting bolt for through-hole type is available.

Refer to the following for ordering procedures. Order the actual number of bolts that will be used.

Example) **CQ-M5 x 115 L 4 pcs.**

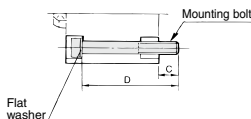

(Note) Be sure to use a flat washer to mount cylinders via through-holes.

Cylinder model	C	D	Mounting bolt part no.
MK2TB20-10	11	115	CQ-M5 x 115 L
MK2TB20-20	11	135	CQ-M5 x 135 L
MK2TB25-10	8.5	115	CQ-M5 x 115 L
MK2TB25-20	8.5	135	CQ-M5 x 135 L
MK2TB32-10	11.5	145	CQ-M5 x 145 L
MK2TB32-20	11.5	165	CQ-M5 x 165 L
MK2TB40-10	7.5	145	CQ-M5 x 145 L
MK2TB40-20	7.5	165	CQ-M5 x 165 L
MK2TB50-20	13.5	185	CQ-M6 x 185 L
MK2TB50-50	10	245	CQ-M6 x 245 L
MK2TB63-20	13	185	CQ-M8 x 185 L
MK2TB63-50	14	250	CQ-M8 x 250 L

Precautions for Designing and Mounting Arms

When arms are to be made separately, their length and weight should be within the following range. When mounting the cylinder horizontally, also select within the same operating range as the following items.

1. Allowable bending moment

Use the arm length and operating pressure within Graph (1) for allowable bending moment loaded piston rod.

Graph (1)

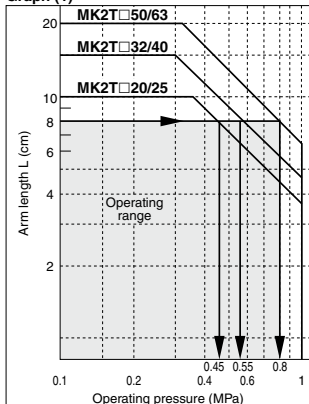

When arm length is 8 cm, pressure should be less than
 MK2T□20/25: 0.45 MPa
 MK2T□32/40: 0.55 MPa
 MK2T□50/63: 0.8 MPa.

2. Moment of inertia

When the arm is long and heavy, damage of internal parts may be caused due to inertia. Use the inertia moment and cylinder speed within Graph (2) based on arm requirements.

Graph (2)

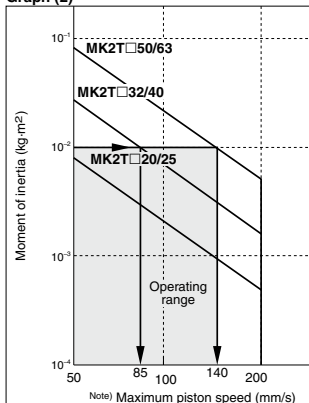

When arm's moment of inertia is 1×10^{-2} kg·m², cylinder speed should be less than
 MK2T□32/40: 85 mm/s
 MK2T□50/63: 140 mm/s.
 For calculating moment of inertia, refer to pages 420, 421 and 434.

(Note) Maximum piston speed is equivalent to approximately 1.6x the average piston speed. (Rough indication)

- To attach and detach the arm to and from the piston rod, fix the arm with a wrench or vise and then tighten the bolt. (If an excessive force is applied in the rotary direction, it may bring about the damage to the internal mechanism.) Refer to the following table for the tightening torque for mounting.

Bore size (mm)	Proper tightening torque (N·m)
20, 25	11.5 to 14.0
32, 40	24 to 30
50	75 to 90
63	106 to 127

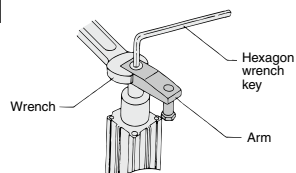

MK2T Series



Dimensions: $\phi 20$, $\phi 25$

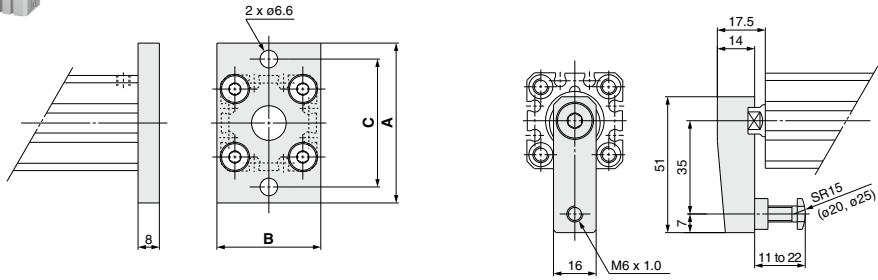

Head End Flange (mm)

Model	A	B	C
MK2TG20	60	39	48
MK2TG25	64	42	52

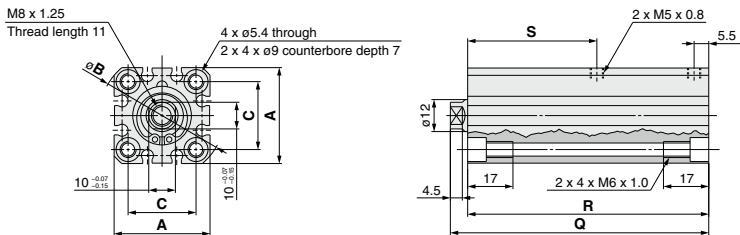

Through-hole/Both Ends Tapped Common (Standard) (mm)

Bore size	A	ϕB	C	Clamp stroke 10 mm			Clamp stroke 20 mm		
				Q	R	S	Q	R	S
20	36	47	25.5	116.5	110.5	59	136.5	130.5	69
25	40	52	28	119	113	59	139	133	69

Rotary Clamp Cylinder: Double Guide Type **MK2T Series**



Dimensions: $\varnothing 32$, $\varnothing 40$, $\varnothing 50$, $\varnothing 63$

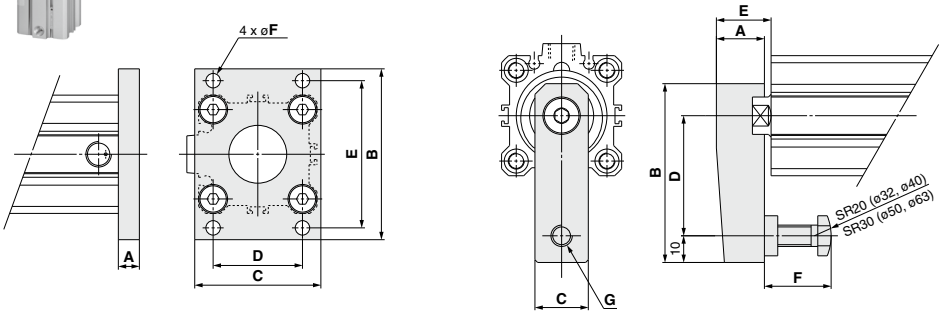

Head End Flange

Model	A	B	C	D	E	$\varnothing F$
MK2TG32	8	65	48	34	56	5.5
MK2TG40	8	72	54	40	62	5.5
MK2TG50	9	89	67	50	76	6.6
MK2TG63	9	108	80	60	92	9

With Arm

Model	A	B	C	D	E	F	G
MK2T□32□-□□N	18	67	20	45	21.5	15 to 25	M8 x 1.25
MK2T□40□-□□N	18	67	20	45	21	15 to 25	M8 x 1.25
MK2T□50□-□□N	22	88	22	65	29.5	20 to 40	M10 x 1.5
MK2T□63□-□□N	32	91	32	65	34.5	20 to 40	M10 x 1.5

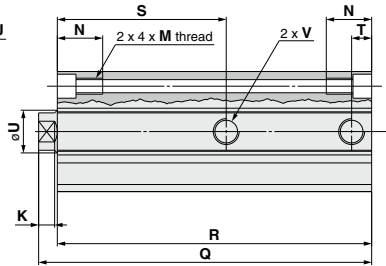
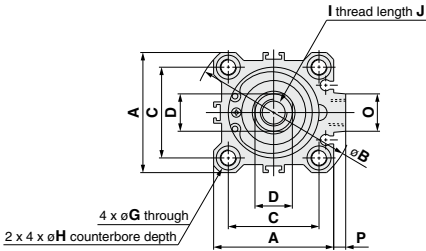

Through-hole/Both Ends Tapped Common (Standard)

Bore size	A	$\varnothing B$	C	D	G	H	I	J	K	M	N	O	P	$\varnothing U$	V		
															NH	TN	TF
32	45	60	34	14 ^{+0.07} _{-0.15}	5.5	9 depth 7	M10 x 1.5	12	6	M6 x 1.0	17	14	4.5	16	Rc 1/8	NPT 1/8	G 1/8
40	52	69	40	14 ^{+0.07} _{-0.15}	5.5	9 depth 7	M10 x 1.5	12	6	M6 x 1.0	17	14	5	16	Rc 1/8	NPT 1/8	G 1/8
50	64	86	50	17 ^{+0.07} _{-0.15}	6.6	11 depth 8	M12 x 1.75	15	7	M8 x 1.25	22	19	7	20	Rc 1/4	NPT 1/4	G 1/4
63	77	103	60	22 ^{+0.07} _{-0.15}	9	14 depth 10.5	M16 x 2	21	8	M10 x 1.5	28.5	19	7	25	Rc 1/4	NPT 1/4	G 1/4

Bore size	Clamp stroke 10 mm				Clamp stroke 20 mm				Clamp stroke 50 mm			
	Q	R	S	T	Q	R	S	T	Q	R	S	T
32	148	140	74	7.5	168	160	84	7.5	—	—	—	—
40	151.5	144	75	8	171.5	164	85	8	—	—	—	—
50	—	—	—	—	191	179	91.5	12.5	254.5	242.5	121.5	14
63	—	—	—	—	192	182	93	10.5	256	246	123	15

Auto Switch Mounting

Auto Switch Proper Mounting Position (Detection at Stroke End)

ø20 to ø63

D-M9□
D-M9□V
D-M9□W
D-M9□WV
D-M9□A
D-M9□AV
D-A9□
D-A9□V

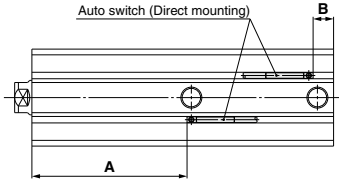

ø32 to ø63

D-F7□/J79
D-F7□V
D-J79C
D-F7□W/J79W
D-F7□WV
D-F7BA/F7BAV
D-F79F/F7NT
D-A7□/A80
D-A73C/A80C
D-A7□H/A80H
D-A79W
D-P4DW

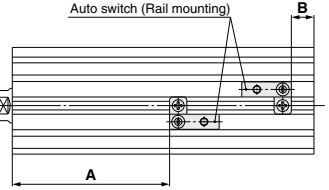

ø25 to ø63

D-P3DWA

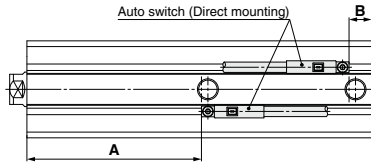
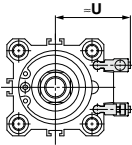

Auto switch model	D-P3DWA		
	A	B	U
Bore size 25	56.5	6.5	33
32	71.5	9	35.5
40	72.5	11.5	39
50-20st	88	17	45
50-50st	118	20.5	45
63-20st	90	18	48.5
63-50st	120	22	48.5

Note) For bore sizes ø32 to ø50, the D-P3DWA is mountable only on the port side.

Mounting	Rail mounting								Direct mounting							
	D-A7 D-A8		D-A7□H/A80H D-A73C/A80C D-F7□/F79F/J79 D-F7□V/J79C D-F7BA□/F7□W D-J79W/F7□WV		D-A79W		D-P4DW		D-M9□ D-M9□V D-M9□W D-M9□WV D-M9□A D-M9□AV		D-A9□ D-A9□V		D-F7NT			
	A	B	A	B	A	B	A	B	A	B	A	B	A	B		
MK2T20	—	—	—	—	—	—	—	—	60.5	9	56.5	5	63	11.5		
MK2T25	—	—	—	—	—	—	—	—	61	11	57	7	63.5	13.5		
MK2T32	73 (73.5)	10.5 (11)	73.5	11	70.5	8	—	—	76	13.5	72	9.5	78.5	16		
MK2T40	74 (74.5)	13 (13.5)	74.5	13.5	71.5	10.5	70	9	77	16	73	12	79.5	18.5		
MK2T50-20st	89.5 (90)	18.5 (19)	90	19	87	16	85.5	14.5	92.5	21.5	88.5	17.5	95	24		
MK2T50-50st	119.5 (120)	22 (22.5)	120	22.5	117	19.5	115.5	18	122.5	25	118.5	21	125	27.5		
MK2T63-20st	91.5 (92)	19.5 (20)	92	20	89	17	87.5	15.5	94.5	22.5	90.5	18.5	97	25		
MK2T63-50st	121.5 (122)	23.5 (24)	122	24	119	21	117.5	19.5	124.5	26.5	120.5	22.5	127	29		

* () : D-A72

Note) When setting an auto switch, confirm the operation and adjust its mounting position.

Operating Range

Operating Range (Dimensions) (mm)

Auto switch model	Bore size					
	20	25	32	40	50	63
D-M9□/M9□V	3	3.5	4.5	4.5	5	5
D-M9□W/M9□WV D-M9□A/M9□AV	5.5	5.5	6.5	5.5	6.5	6.5
D-A9□/A9□V	9	9.5	9	9.5	9.5	11
D-F7□/J79 D-F7□V/F79F/J79C D-F7□W/F7□WV D-F79F/F7BA/F7BAV/F7NT	—	—	6	6	6	6.5
D-A7□/A80 D-A7□H/A80H D-A73C/A80C	—	—	9.5	11.5	11	13.5
D-A79W	—	—	6	7	7	9.5
D-P3DWA	—	5.5	6	6	6.5	6.5
D-P4DW	—	—	—	5	5	5

* Since this is a guideline including hysteresis, not meant to be guaranteed. (Assuming approximately ±30% dispersion.) There may be the case it will vary substantially depending on an ambient environment.

* Figures for models D-M9□(V), M9□W(V), M9□A(V), and A9□(V) with ø32 or more indicate the operating range when using the current auto switch-mounting groove, without using auto switch mounting bracket (BQ2-012).

Other than the models listed in "How to Order", the following auto switches are applicable. For detailed specifications, refer to pages 1341 to 1435.

Auto switch type	Model	Electrical entry	Features	Applicable bore size
Solid state	D-F7NV, F7PV, F7BV	Grommet (Perpendicular)	—	ø32 to ø63
	D-F7NWV, F7BWV		Diagnostic indication (2-color indicator)	
	D-F7BAV		Water resistant	
	D-F79, F7P, J79	Grommet (In-line)	—	
	D-F79W, F7PW, J79W		Diagnostic indication (2-color indicator)	
	D-F7BA		Water resistant (2-color indicator)	
	D-F7NT		With timer	
	D-P5DW		Magnetic field resistant	
Reed	D-A73	Grommet (Perpendicular)	—	ø32 to ø63
	D-A80		Without indicator light	
	D-A73H, A76H	Grommet (In-line)	—	
	D-A80H		Without indicator light	

* With pre-wired connector is available for solid state auto switches, too. For details, refer to pages 1410 and 1411.

* Normally closed (NC = b contact) solid state auto switches (D-M9□E(V)) are also available. For details, refer to page 1360.

MK2T Series

Auto Switch Mounting Bracket/Part No.

Auto switch mounting surface	Bore size (mm)		
	ø20	ø25	ø32, ø40, ø50
Auto switch model	Auto switch mounting surface	Auto switch mounting surface	Auto switch mounting surface
	Port, A, B, C sides	Port side	A, B, C sides
			Port, A, B, C sides
D-M9□ D-M9□V D-M9□W D-M9□WV D-M9□A D-M9□AV D-A9□ D-A9□V	No auto switch mounting bracket necessary.	No auto switch mounting bracket necessary.	① BQ-2 ② BQ2-012 Two types of auto switch mounting bracket are used as a set.
D-P3DWA	—	No auto switch mounting bracket necessary.	—

Note 1) For ø32 to ø50 of each cylinder series, when mounting compact auto switches on one of the three sides other than the port side (above A, B, C side) in the figure above, a separate auto switch mounting bracket is necessary as shown in the table above, so please order one separately from the cylinder.
(The same is true when mounting compact auto switches with the auto switch mounting rail, not using the compact auto switch mounting groove, for diameters ø63.)

Example

MK2TB32-10R-M9BW 1 unit
BQ-2 2 pcs.
BQ2-012 2 pcs.

Note 2) When the cylinder is shipped, an auto switch mounting bracket and auto switch are included in the shipment.

Auto switch model	Bore size (mm)			
	32	40	50	63
D-F7□/J79 D-F7□V D-J79C D-F7□W/J79W D-F7□WV D-F7BA/F7BAV D-F79F/F7NT D-A7□/A80 D-A73C/A80C D-A7□H/A80H D-A79W				
		BQ-2		
D-P4DW	—		BQP1-050	

Note 3) When the cylinder is shipped, an auto switch mounting bracket and auto switch are included in the shipment. However, ø40 to ø63 with the D-P4DW are assembled at the time of shipment.

[Mounting screw set made of stainless steel]

The set of stainless steel mounting screws (with nuts) described below is available and can be used depending on the operating environment. (Please order the auto switch spacer BQ-2, since it is not included.)

The "D-F7BA/F7BAV" switch is set on the cylinder with the stainless steel screws above when shipped.

When only a switch is mounted independently, "BBA2" screw set is attached.

Note 4) When mounting D-M9□A(V) anywhere other than the port side of ø32, ø40, ø50, please order auto switch mounting brackets BQ2-012S, BQ-2, and the stainless steel screw set BBA2 separately.

Detailed Contents of Stainless Steel Mounting Screw Set

Part no.	Content			Applicable auto switch mounting bracket part no.	Applicable auto switch
	Description	Size	No.		
BBA2	Auto switch mounting screw	M3 x 0.5 x 8 L	1	BQ-1	D-A7
		M3 x 0.5 x 10 L	1	BQ-2	D-A8
	Auto switch mounting nut (Square nut)	M3 x 0.5	1	BQ-1	D-F7
		M3 x 0.5	1	BQ-2	D-J7

Note 5) When using BQ-1, BBA2 may be used by itself.

When using BQ-2, BQ-2 and BBA2 should be used together as a set, and used in combination with the auto switch spacer (black resin material) and stainless steel screws.

Auto Switch Mounting Bracket Weight

Mounting bracket part no.	Weight (g)
BQ-1	1.5
BQ-2	1.5
BQ2-012	5
BQP1-050	16

MK2T Series

Made to Order: Individual Specifications

Please contact SMC for detailed dimensions, specifications and lead times.



1 With Head End Pin Hole

Symbol

-X1859

How to Order

MK2T Standard model no. - X1859

With head end pin hole

Specifications

Applicable series	MK2T
Bore size	ø32, ø40, ø50, ø63
Specifications other than above	Same as standard product

Dimensions

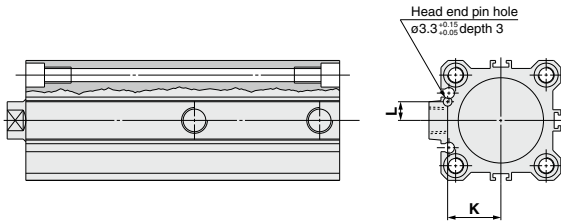

Bore size (mm)	K	L
32	20 ^{+0.15}	7 ^{+0.15}
40	24 ^{+0.15}	7 ^{+0.15}
50	30 ^{+0.15}	8 ^{+0.15}
63	35 ^{+0.15}	9 ^{+0.15}

* Dimensions other than above are same as basic type.



MK2T Series

Specific Product Precautions 1

Be sure to read this before handling the products.

Refer to page 9 for safety instructions and pages 10 to 19 for actuator and auto switch precautions.

Operating Environment

Warning

1. Do not use the cylinder under following environments:

- 1) An area in which fluids such as cutting oil splash on the piston rod.
- 2) An area in which foreign matter such as particles, cutting chips, dust, or spatter is present.
- 3) An area in which the ambient temperature exceeds the operating range.
- 4) An area exposed to direct sunlight.
- 5) An environment that poses the risk of corrosion.

Clamp Arm Removal and Reinstallation

Warning

1. To remove and reinstall the arm on the piston rod, instead of securing the cylinder body, use a wrench to secure the arm to loosen or to tighten the bolt (Fig. (1)).

An excessive amount of rotational force will be applied to the piston rod if the bolt is tightened by securing the cylinder body, which could damage the internal parts.

To fabricate an arm, make sure to machine a detect portion that corresponds to the parallel section at the rod end.

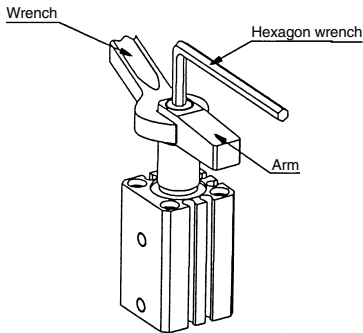

Fig. (1)

Speed Adjustment

Warning

1. Make sure to connect a speed controller to the cylinder and adjust it so that the cylinder speed will be within a range of 50 to 200 mm/s.

If a clamp arm other than the available option is used, make sure to select an appropriate arm after calculating the inertial moment of the arm.

To operate a speed controller, make sure that the valve is fully closed, and gradually open the valve to adjust the speed.



MK2T Series

Specific Product Precautions 2

Be sure to read this before handling the products.

Refer to page 9 for safety instructions and pages 10 to 19 for actuator and auto switch precautions.

Operating Environment

⚠ Warning

1. A cylinder could malfunction or the non-rotating accuracy could be affected if a rotational force is applied to the piston rod. Therefore, observe the particulars given below before operating the cylinder.

- 1) Do not absolutely perform any work (such as clamping or acting as a stopper, etc.) in the rotary direction (Fig. (2)).
- 2) To clamp, make sure to do so within the clamp stroke (straight-line stroke) range (Fig. (3)).
- 3) Make sure that the clamping surface of the workpiece is perpendicular to the cylinder's axial line (Fig. (4)).
- 4) Do not operate the cylinder in such a way that an external force causes the workpiece to move while being clamped (Fig. (5)).
- 5) Furthermore, do not operate the cylinder in an application in which a rotational force will be applied to the piston rod.

1) Do not perform any work in the rotary direction.

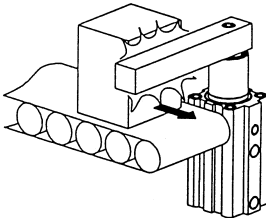

Fig. (2)

2) Do not clamp during the rotary stroke.

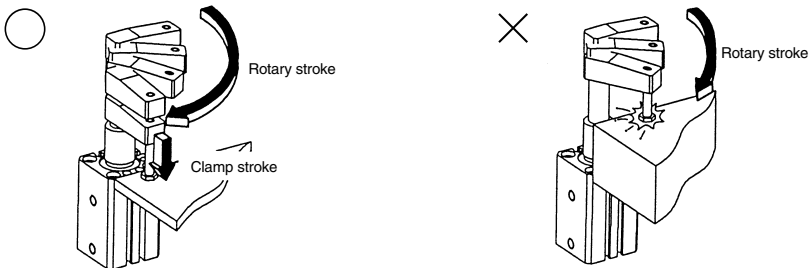

Fig. (3)

3) Do not clamp on a slanted surface.

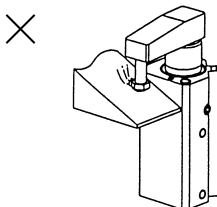

Fig. (4)

4) Make sure that the workpiece does not move during clamping.

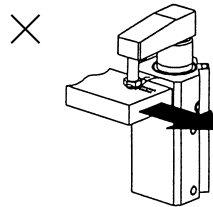

Fig. (5)



MK2T Series

Specific Product Precautions 3

Be sure to read this before handling the products.

Refer to page 9 for safety instructions and pages 10 to 19 for actuator and auto switch precautions.

Mounting

- When a magnetic substrate surrounds the cylinder as shown in the figure below (including when the magnetic substrate is only on one side of the cylinder), the movement of the auto switch may become unstable, so please contact SMC.

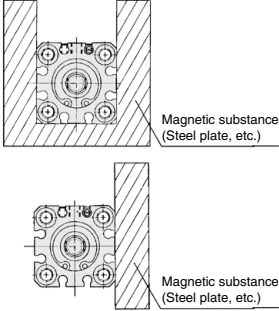

With Magnetic Field Resistant Auto Switch D-P3DWA, P4DWL

- If welding cables or welding gun electrodes are in the vicinity of the cylinder, the magnets in the cylinder could be affected by the external magnetic fields. (Contact SMC if the welding amperage exceeds 16000 A.) If the source of strong magnetism comes in contact with the cylinder or an auto switch, make sure to install the cylinder away from the source of the magnetism. If the cylinder is to be used in an environment in which spatter will come in direct contact with the lead wires, cover the lead wires with a protective tube. For the protective tube, use a tube I.D. $\phi 7$ or more, which excels in heat resistance and flexibility. Contact SMC if an inverter welder or a DC welder will be used.

Calculation of Moment of Inertia

I: Moment of inertia (kg·m²) m: Load mass (kg)

1. Thin shaft

Position of rotational axis:
Vertical to the bar and through the end

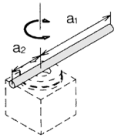

$$I = m_1 \cdot \frac{a_1^2}{3} + m_2 \cdot \frac{a_2^2}{3}$$

4. Thin rectangular plate (Rectangular parallelepiped)

Position of rotational axis:
Vertical to the plate and through the end

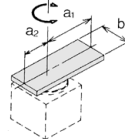

$$I = m_1 \cdot \frac{4a_1^2 + b^2}{12} + m_2 \cdot \frac{4a_2^2 + b^2}{12}$$

2. Thin shaft

Position of rotational axis:
Perpendicular to the shaft through the center of gravity

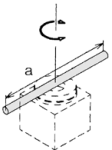

$$I = m \cdot \frac{a^2}{12}$$

5. Thin rectangular plate (Rectangular parallelepiped)

Position of rotational axis:
Through the center of gravity and vertical to the plate
(Same as also thick rectangular plate)

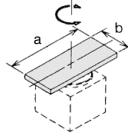

$$I = m \cdot \frac{a^2 + b^2}{12}$$

3. Thin rectangular plate (Rectangular parallelepiped)

Position of rotational axis:
Parallel to side b through the center of gravity

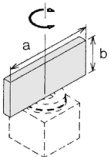

$$I = m \cdot \frac{a^2}{12}$$

6. Load at the end of lever arm

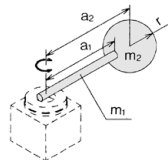

$$I = m_1 \cdot \frac{a_1^2}{3} + m_2 \cdot a_2^2 + K$$

$$k = m_2 \cdot \frac{2a_2^2}{5}$$