

# Rotary Actuator/Vane Type

## CRB1 Series

Size: 50, 63, 80, 100

Compact auto switches  
can be used! (D-M9□)

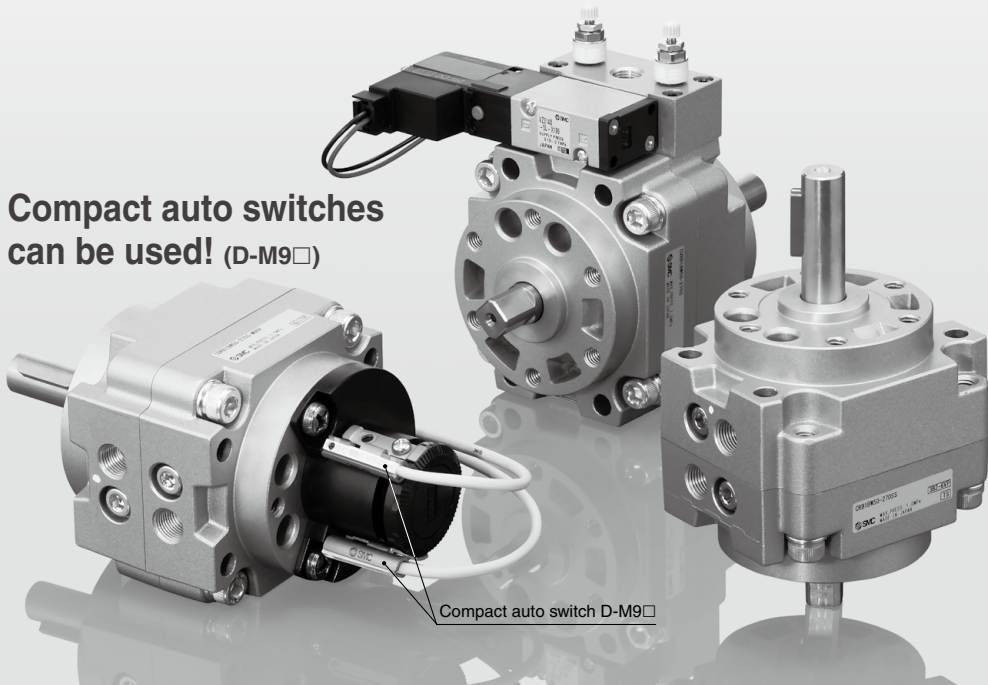

CRB□□
<b>CRB1</b>
MSU
CRJ
CRA1
CRQ2
MSQ
MSZ
CRQ2X
MSQX
MRQ

### Stainless steel specification for main parts

**Made to Order**

Size: 50, 63, 80, 100

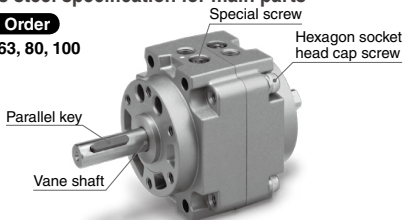

### Two different port locations (side and axial) are available.

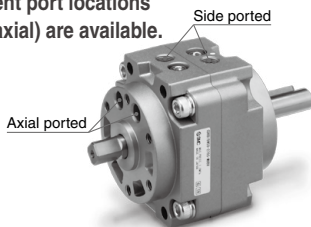

### Mounting

Direct mounting

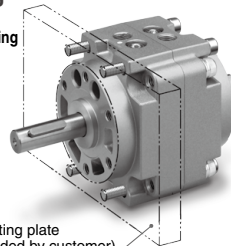

Foot mounting

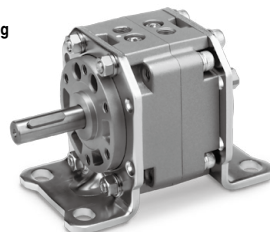

D-□

Basic type  
*CRB1 Series*

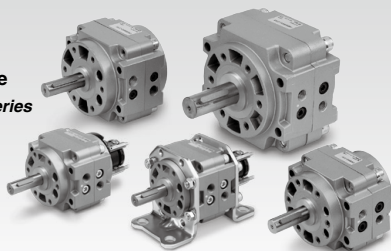

With solenoid valve  
*CVRB1 Series*

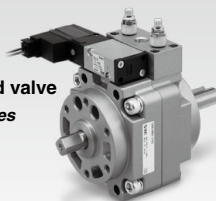

Series Variations

		Fluid		Air																		
		Size		50				63				80				100						
Vane type	S: Single vane D: Double vane		S		D		S		D		S		D		S		D					
	Port location		Side ported (Nil)	Side ported (Nil)	Side ported (Nil)	Side ported (Nil)	Side ported (Nil)	Side ported (Nil)	Side ported (Nil)	Side ported (Nil)	Side ported (Nil)	Side ported (Nil)	Side ported (Nil)	Side ported (Nil)	Side ported (Nil)	Side ported (Nil)	Side ported (Nil)	Side ported (Nil)				
Port location	Side ported (Nil)		Side ported	Side ported	Side ported	Side ported	Side ported	Side ported	Side ported	Side ported	Side ported	Side ported	Side ported	Side ported	Side ported	Side ported	Side ported	Side ported				
	Axial ported (E)		Axial ported	Axial ported	Axial ported	Axial ported	Axial ported	Axial ported	Axial ported	Axial ported	Axial ported	Axial ported	Axial ported	Axial ported	Axial ported	Axial ported	Axial ported	Axial ported	Axial ported			
Standard	Rotating angle	90°		●	●	●	●	●	●	●	●	●	●	●	●	●	●	●	●			
		180°		●	●	●	●	●	●	●	●	●	●	●	●	●	●	●	●	●		
		270°		●	●	●	●	●	●	●	●	●	●	●	●	●	●	●	●	●	●	
		Semi-standard	100°		●	●	●	●	●	●	●	●	●	●	●	●	●	●	●	●	●	
			190°		●	●	●	●	●	●	●	●	●	●	●	●	●	●	●	●	●	●
			280°		●	●	●	●	●	●	●	●	●	●	●	●	●	●	●	●	●	●
Shaft type	Double shaft		W	●	●	●	●	●	●	●	●	●	●	●	●	●	●	●	●			
Cushion	Rubber bumper		●	●	●	●	●	●	●	●	●	●	●	●	●	●	●	●	●			
Variations	Basic type		●	●	●	●	●	●	●	●	●	●	●	●	●	●	●	●	●	●		
	With auto switch		●	●	●	●	●	●	●	●	●	●	●	●	●	●	●	●	●	●		
	With One-touch fittings		●	●	●	●	●	●	●	●	●	●	●	●	●	●	●	●	●	●		
	Clean series		10-	●	●	●	●	●	●	●	●	●	●	●	●	●	●	●	●	●		
	Copper-free and fluorine-free		20-	●	●	●	●	●	●	●	●	●	●	●	●	●	●	●	●	●		
Option	Mounting	With solenoid valve		CVRB1	●	●	●	●	●	●	●	●	●	●	●	●	●	●	●	●		
		With foot bracket		L	●	●	●	●	●	●	●	●	●	●	●	●	●	●	●	●	●	
		Material	Stainless steel specification for main parts		●	●	●	●	●	●	●	●	●	●	●	●	●	●	●	●	●	
			Shaft type	Double shaft type	Double shaft (Long shaft with four chamfers)		J	●	●	●	●	●	●	●	●	●	●	●	●	●	●	●
					Double shaft with four chamfers		Z	●	●	●	●	●	●	●	●	●	●	●	●	●	●	●
Double shaft key					Y	●	●	●	●	●	●	●	●	●	●	●	●	●	●	●	●	●
Double round shaft		K			●	●	●	●	●	●	●	●	●	●	●	●	●	●	●	●	●	
Single shaft type	Single shaft key		S	●	●	●	●	●	●	●	●	●	●	●	●	●	●	●	●	●		
	Single round shaft		T	●	●	●	●	●	●	●	●	●	●	●	●	●	●	●	●	●		
	Single shaft with four chamfers		X	●	●	●	●	●	●	●	●	●	●	●	●	●	●	●	●	●		
Pattern	Shaft pattern		●	●	●	●	●	●	●	●	●	●	●	●	●	●	●	●	●	●		
	Rotation pattern		●	●	●	●	●	●	●	●	●	●	●	●	●	●	●	●	●	●		

# CONTENTS

## Vane Type Rotary Actuator *CRB1 Series*

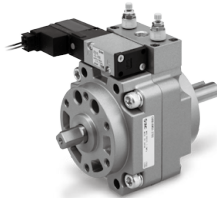
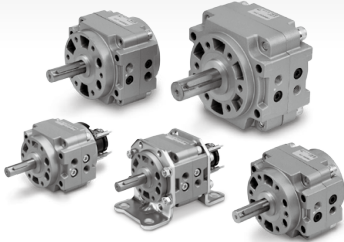

### ● Vane Type Rotary Actuator *CRB1 Series*

How to Order .....	Page 110
Specifications .....	Page 111
Construction .....	Page 116
Dimensions .....	Page 117

### ● Rotary Actuator with Solenoid Valve *CVRB1 Series*

How to Order .....	Page 121
Specifications .....	Page 122
Dimensions .....	Page 122

### ● Simple Specials

Shaft Pattern Sequencing I <b>-XA1 to -XA24</b> .....	Page 124
Shaft Pattern Sequencing II <b>-XA31 to -XA60</b> .....	Page 127

### ● Made to Order .....

Page 133

### ● Auto Switch Mounting .....

Page 135

CRB1
<b>CRB1</b>
MSU
<b>CRJ</b>
CRA1
CRQ2
MSQ
MSZ
CRQ2X MSQX
MRQ

D-□

# Vane Type Rotary Actuator

# CRB1 Series

## Size: 50, 63, 80, 100

### How to Order

**Basic type**

CRB1 **B** **W** **80** - **90** **S** □

**With auto switch**

CDRB1 **B** **W** **80** - **90** **S** □ - **M9B** **L** □

**Shaft type**

**W** Double shaft (Long shaft key & Four chamfers)

**Rotating angle**

Classification	Symbol	Single vane	Double vane
Standard	90	90°	90°
	180	180°	—
	270	270°	—
Semi-standard	100	100°	100°
	190	190°	—
	280	280°	—

**Mounting**

<b>B</b>	Basic
<b>L</b>	Foot

Refer to Table (1) below when foot bracket assembly is required separately.

**Table (1): Foot Bracket Assembly Part Number**

Model	Assembly part no.
CRB1LW50	P411020-5
CRB1LW63	P411030-5
CRB1LW80	P411040-5
CRB1LW100	P411050-5

**Size**

50
63
80
100

**Vane type**

<b>S</b>	Single vane
<b>D</b>	Double vane

**Connecting port location**

<b>Nil</b>	Side ported
<b>E</b>	Axial ported

**Auto switch**

<b>Nil</b>	Without auto switch (Built-in magnet)
<b>M</b>	Without D-M9 type auto switch (Built-in magnet)

\* For applicable auto switch model, refer to the table below.

\*\* The operating range and hysteresis of the D-M9□ are different from those of the other auto switches. For details, refer to page 135.

**Made to Order or Port thread type**

Refer to pages 124 to 126, 133 and 134 for details about Made to Order specifications.

<b>Nil</b>	Rc
<b>-XF*</b>	G
<b>-XN*</b>	NPT

\* Combination with Made to Order is not available.

**Number of auto switches**

<b>S</b>	1 pc.*
<b>Nil</b>	2 pcs.**

\* S: A right-hand auto switch is shipped.

\*\* Nil: A right-hand switch and a left-hand switch are shipped.

**Electrical entry/Lead wire length**

<b>Nil</b>	Grommet/Lead wire: 0.5 m
<b>M</b>	Grommet/Lead wire: 1 m
<b>L</b>	Grommet/Lead wire: 3 m
<b>CN</b>	Connector/Without lead wire
<b>C</b>	Connector/Lead wire: 0.5 m
<b>CL</b>	Connector/Lead wire: 3 m

\* Connectors are available only for the R73, R80, T79.

\*\* Lead wire with connector part nos.  
D-LC05: Lead wire 0.5 m  
D-LC30: Lead wire 3 m  
D-LC50: Lead wire 5 m

### Applicable Auto Switches/Refer to pages 797 to 850 for further information on auto switches.

Type	Special function	Electrical entry	Indicator light	Wiring (Output)	Load voltage		Auto switch model		Lead wire type	Lead wire length [m]					Pre-wired connector	Applicable load
					DC	AC	Perpendicular	In-line		0.5 (Nil)	1 (M)	3 (L)	5 (Z)	None (N)		
Solid state auto switch	—	Grommet	Yes	3-wire (NPN)	24 V	5 V, 12 V	—	—	Oilproof heavy-duty cord	●	●	○	—	○	IC circuit	
				3-wire (PNP)						●	●	○	—	○		
				2-wire						●	●	○	—	○		
				3-wire (NPN)						●	●	○	—	○		
				3-wire (PNP)						●	●	○	—	○		
				2-wire						●	●	○	—	○		
Reed auto switch	—	Connector	Yes	2-wire	24 V	—	100 V	—	Oilproof heavy-duty cord	●	●	○	—	○	—	
				—						●	●	○	—	○		
				—						●	●	○	—	○		
				—						●	●	○	—	○		
				—						●	●	○	—	○		
				—						●	●	○	—	○		
Reed auto switch	—	Connector	No	2-wire	24 V or less	—	—	—	Oilproof heavy-duty cord	●	●	○	—	○	IC circuit	
				—						●	●	○	—	○		
				—						●	●	○	—	○		

\* Lead wire length symbols: 0.5 m ..... Nil (Example) R73C  
3 m ..... L (Example) R73CL  
5 m ..... Z (Example) R73CZ  
None ..... N (Example) R73CN

\* Solid state auto switches marked with "○" are produced upon receipt of order.

- Excellent reliability and durability.  
The use of bearings to support thrust and radial loads improves reliability and durability.
- The body of the rotary actuator can be mounted directly.
- Two different port locations (side and axial) are available.

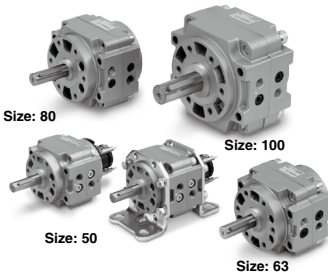

**Symbol**



Refer to pages 135 to 137 for actuators with auto switches.

- Auto switch unit and switch block unit
- Operating range and hysteresis
- How to change the auto switch detecting position
- Auto switch mounting
- Auto switch adjustment

**Made to Order**  
(For details, refer to pages 124 to 126, 133 and 134.)

Symbol	Description
<b>XA1 to XA24</b>	Shaft type pattern
<b>XC1</b>	Addition of connection port
<b>XC4</b>	Change of rotating angle
<b>XC5</b>	Change of rotating angle
<b>XC6</b>	Change of rotating angle
<b>XC7</b>	Reversed shaft
<b>XC26</b>	Change of rotating angle
<b>XC27</b>	Change of rotation range and direction
<b>XC30</b>	Fluorine grease

**Specifications**

Size	50	63	80	100	50	63	80	100	
Vane type	Single vane (S)				Double vane (D)				
Rotating angle	Standard	90° <sup>+1°</sup> , 180° <sup>+4°</sup> , 270° <sup>+4°</sup>				90° <sup>+1°</sup>			
	Semi-standard	100° <sup>+4°</sup> , 190° <sup>+4°</sup> , 280° <sup>+4°</sup>				100° <sup>+4°</sup>			
Fluid	Air (Non-lube)								
Proof pressure	1.5 MPa								
Ambient and fluid temperature	5 to 60°C								
Max. operating pressure	1.0 MPa								
Min. operating pressure	0.15 MPa								
Rotation time adjustment range	0.1 to 1 s/90°								
Allowable kinetic energy	0.082 J	0.12 J	0.398 J	0.6 J	0.112 J	0.16 J	0.54 J	0.811 J	
Shaft load	Allowable radial load	245 N	390 N	490 N	588 N	245 N	390 N	490 N	588 N
	Allowable thrust load	196 N	340 N	490 N	539 N	196 N	340 N	490 N	539 N
Bearing	Bearing								
Port location	Side ported or Axial ported								
Port size	Side ported	1/8		1/4		1/8		1/4	
	Axial ported	1/8		1/4		1/8		1/4	
Mounting	Basic, Foot								

**Volume**

Classification	Rotating angle	Single vane (S)				Double vane (D)			
		50	63	80	100	50	63	80	100
Standard	90°	30	70	88	186	48	98	136	272
	180°	49	94	138	281	—	—	—	—
	270°	66	118	188	376	—	—	—	—
Semi-standard	100°	32	73	93	197	52	104	146	294
	190°	51	97	143	292	—	—	—	—
	280°	68	121	193	387	—	—	—	—

**Weight**

Model	Rotating angle	Single vane (S)				Double vane (D)			
		50	63	80	100	50	63	80	100
Main body	90°	810	1365	2070	3990	830	1410	2120	4150
	180°	790	1330	2010	3880	—	—	—	—
	270°	770	1290	1950	3760	—	—	—	—
	100°	808	1360	2065	3980	822	1400	2100	4100
	190°	788	1325	2005	3870	—	—	—	—
	280°	766	1285	1940	3735	—	—	—	—
Auto switch unit + 2 auto switches		65	85	95	165	65	85	95	165
Foot bracket assembly		384	785	993	1722	384	785	993	1722

**Mounting Bracket Assembly Part No.**

Model		Foot bracket assembly part number	Description
Basic type	With auto switch		
<b>CRB1LW50</b>	<b>CDRB1LW50</b>	P411020-5	· 2 foot brackets · 8 mounting bolts · 8 mounting nuts · 8 washers
<b>CRB1LW63</b>	<b>CDRB1LW63</b>	P411030-5	
<b>CRB1LW80</b>	<b>CDRB1LW80</b>	P411040-5	
<b>CRB1LW100</b>	<b>CDRB1LW100</b>	P411050-5	

\* Refer to page 119 for detailed dimensions.

CRB1  
MSQ  
CRA1  
CRQ2  
MSQ  
MSZ  
CRO2X  
MSQX  
MRQ

D-□

# CRB1 Series

## Effective Output

Size: 50

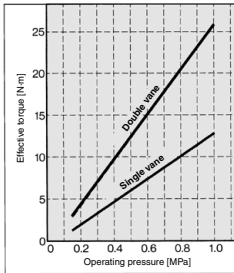

Size: 63

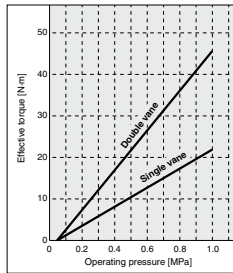

Size: 80

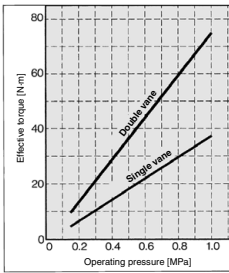

Size: 100

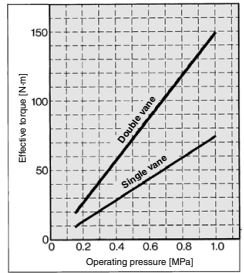

## Key Position and Rotation Range (Top View from Long Shaft Side)

Key positions in the figures below show the intermediate rotation position when A or B port is pressurized.

	Single vane type			Double vane type
	90°	180°	270°	90°
Standard				
Semi-standard				

## Direct Mounting of Body

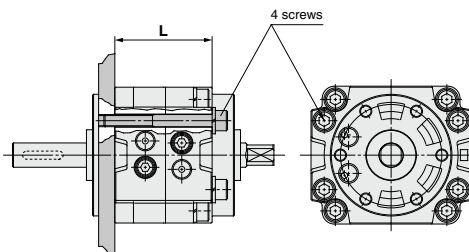

### Reference Screw Size

Size	L	Screw
50	48	M 6
63	52	M 8
80	60	M 8
100	80	M10

## With One-touch Fittings

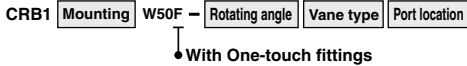

With One-touch fittings facilitate the piping work and greatly reduce the installation space.

### Specifications

Vane type	Single vane	Double vane
Size	<b>50</b>	
Operating pressure range [MPa]	0.15 to 1.0	
Speed regulation range [s/90°]	0.1 to 1	
Port location	Side ported or Axial ported	
Piping	With One-touch fittings	
Mounting	Basic, Foot	
Variations	Basic type, With auto switch	

### Applicable Tubing and Size

Applicable tubing O.D./I.D [mm]	<b>ø6/ø4</b>
Applicable tubing material	Nylon, Soft nylon, Polyurethane

Refer to page 120 for external dimensions.

## Clean Series

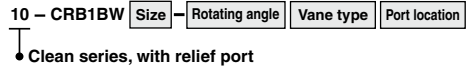

The double-seal construction of the actuator shaft section of these series to channel exhaust through the relief ports directly to the outside of a clean room environment allows operation of these cylinders in a class 100 clean room.

### Specifications

Vane type	Single/Double vane	
Size	<b>50</b>	<b>63</b>
Operating pressure range [MPa]	0.15 to 1.0	
Speed regulation range [s/90°]	0.1 to 1	
Port location	Side ported or Axial ported	
Piping	Screw-in type	
Relief port size	M5 x 0.8	
Mounting	Basic	
Variations	Basic type, With auto switch	
Allowable kinetic energy	0.029 J	0.042 J

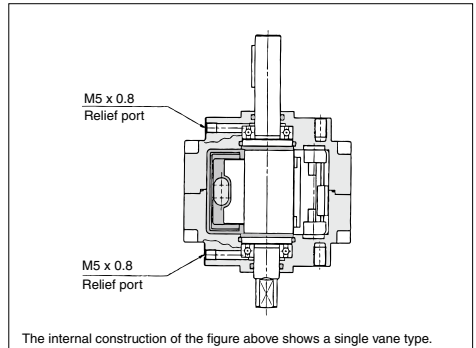

CRB□2

CRB1

MSU

CRJ

CRA1

CRQ2

MSQ

MSZ

CRQ2X  
MSQX

MRQ

D-□

# CRB1 Series

## Stainless Steel Specification for Main Parts

CDRB1 Mounting W Size — Rotating angle Vane type Port location S

● Auto switch

Nil	Basic type
D	With auto switch (With switch unit)

● Stainless steel specification for main parts

### Specifications

Vane type	Single/Double vane			
Size	50	63	80	100
Operating pressure range [MPa]	0.15 to 1.0			
Speed regulation range [s/90°]	0.1 to 1			
Port location	Side ported or Axial ported			
Piping	Screw-in type			
Mounting	Basic, Foot			
Variations	Basic type, With auto switch			
Allowable kinetic energy	0.029 J	0.042 J	0.142 J	0.212 J

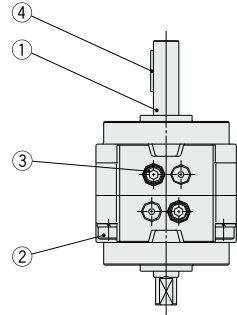

### Stainless Steel Parts

	Description
1	Vane shaft
2	Hexagon socket head cap screw
3	Special screw
4	Parallel key

\* Individual part cannot be shipped.



## Rotary Actuator: Replaceable Shaft

A shaft can be replaced with a different shaft type except for standard shaft type (W).

Without auto switch **CRB1B J** Size — Rotating angle Vane type Port location — Made to Order

Shaft type

<b>J</b>	Double shaft (Long shaft with four chamfers)
<b>K</b>	Double round shaft
<b>S</b>	Single shaft key
<b>T</b>	Single round shaft
<b>X</b>	Single shaft with four chamfers
<b>Y</b>	Double shaft key
<b>Z</b>	Double shaft with four chamfers

Made to Order

Symbol	Description
<b>XA31 to XA60</b>	Shaft type pattern
<b>XC1</b>	Addition of connection port
<b>XC4</b>	Change of rotating angle
<b>XC5</b>	Change of rotating angle
<b>XC6</b>	Change of rotating angle
<b>XC7</b>	Reversed shaft
<b>XC26</b>	Change of rotating angle
<b>XC27</b>	Change of rotation range and direction
<b>XC30</b>	Fluorine grease

\* Refer to pages 127 to 134 for details.

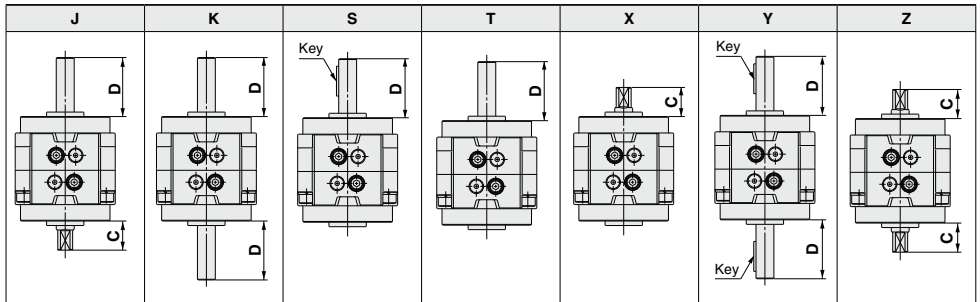

[mm]

Size	C	D
<b>50</b>	19.5	39.5
<b>63</b>	21	45
<b>80</b>	23.5	53.5
<b>100</b>	30	65

Note) Dimensions of the shaft and key groove are the same as the standard.  
(Dimension parts different from the standard conform to the general tolerance.)

With auto switch **CDRB1B J** Size — Rotating angle Vane type Port location — Made to Order

With auto switch

Shaft type

<b>J</b>	Double shaft (Long shaft with four chamfers)
<b>Z</b>	Double shaft with four chamfers

Made to Order

Symbol	Description
<b>XA31 to XA60</b>	Shaft type pattern
<b>XC1</b>	Addition of connection port
<b>XC4</b>	Change of rotating angle
<b>XC5</b>	Change of rotating angle
<b>XC6</b>	Change of rotating angle
<b>XC7</b>	Reversed shaft
<b>XC26</b>	Change of rotating angle
<b>XC27</b>	Change of rotation range and direction
<b>XC30</b>	Fluorine grease

The above may not be selected when the product comes with an auto switch. Refer to pages 127 to 134 for details.

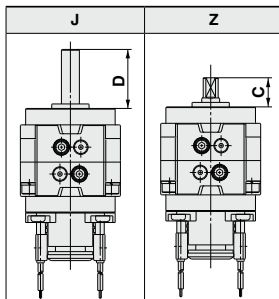

[mm]

Size	C	D
<b>50</b>	19.5	39.5
<b>63</b>	21	45
<b>80</b>	23.5	53.5
<b>100</b>	30	65

Note) Dimensions of the shaft and key groove are the same as the standard.  
(Dimension parts different from the standard conform to the general tolerance.)

# CRB1 Series

## Construction

**Basic type** (Keys in the figures below show the intermediate rotation position.)

**For 270°** (Top view from long shaft side)

Single vane

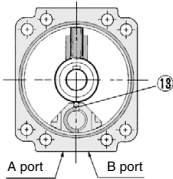

**For 180°** (Top view from long shaft side)

Single vane

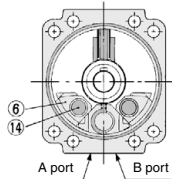

**For 90°** (Top view from long shaft side)

Single vane

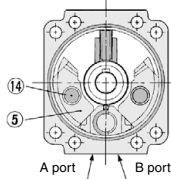

**For 90°** (Top view from long shaft side)

Double vane

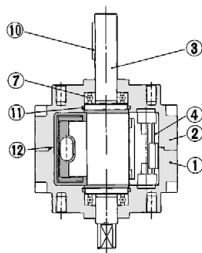
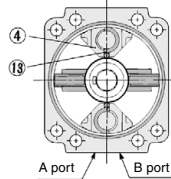

(Long shaft side)

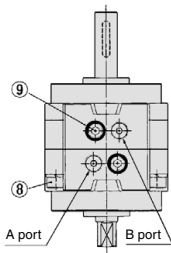

(Short shaft side)

**With auto switch**

(Keys in the figures below show the actuator for 180° when A port is pressurized.)

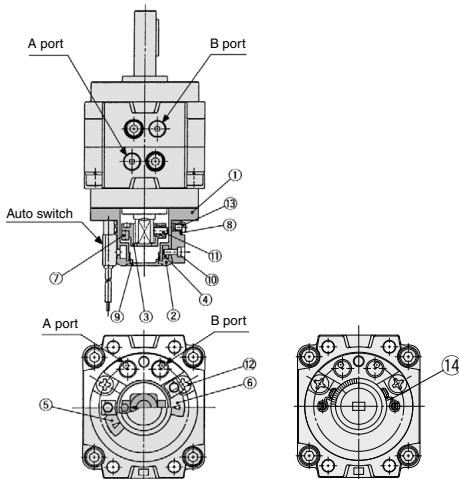

D-M9□

## Component Parts

No.	Description	Material	Note
1	Body (A)	Aluminum alloy	Painted
2	Body (B)	Aluminum alloy	Painted
3	Vane shaft	Carbon steel*	
4	Stopper	Aluminum alloy	
5	Stopper	Resin	For 90°
6	Stopper	Resin	For 180°
7	Bearing	Bearing steel	
8	Hexagon socket head cap screw (with washer)	Chrome molybdenum steel	
9	Special screw	Chrome molybdenum steel	
10	Parallel key	Carbon steel	
11	O-ring	NBR	
12	O-ring	NBR	Special O-ring
13	Stopper seal	NBR	Special seal
14	Holding rubber	NBR	

\* Individual part cannot be shipped.

\* The material is chrome molybdenum steel for double vane type.

## Component Parts

No.	Description	Material	Note
1	Cover (A)	Resin	
2	Cover (B)	Resin	
3	Magnet lever	Resin	
4	Holding block	Stainless steel	
5	Switch block (A)	Resin	
6	Switch block (B)	Resin	
7	Magnet	—	
8	Arm	Stainless steel	
9	Rubber cap	NBR	
10	Cross recessed round head screw	Stainless steel	
11	Hexagon socket head set screw	Stainless steel	
12	Cross recessed round head screw	Chrome molybdenum steel	For size 50, 63, 80
13	Hexagon socket head cap screw	Chrome molybdenum steel	For size 100
14	Cross recessed round head screw	Stainless steel	
14	Switch holder	Stainless steel	

\* Individual part cannot be shipped. Please purchase the whole unit. (Refer to page 135.)

**Dimensions: 50, 63, 80, 100**

Single vane type/Double vane type  
CRB1BW□-□S/D  
<Port location: Side ported>

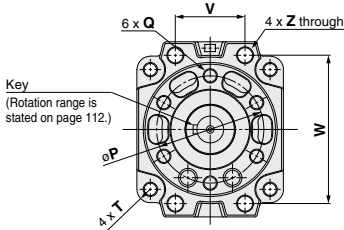

**Key Dimensions**

Key dimension			
	b (h9)	h (h9)	L
Size			
<b>50</b>	4 <sup>0</sup> <sub>-0.030</sub>	4 <sup>0</sup> <sub>-0.030</sub>	20
<b>63</b>	5 <sup>0</sup> <sub>-0.030</sub>	5 <sup>0</sup> <sub>-0.030</sub>	25
<b>80</b>	5 <sup>0</sup> <sub>-0.030</sub>	5 <sup>0</sup> <sub>-0.030</sub>	36
<b>100</b>	7 <sup>0</sup> <sub>-0.036</sub>	7 <sup>0</sup> <sub>-0.036</sub>	40

Axial ported (Port location): CRB1BW□-□SE, CRB1BW□-□DE

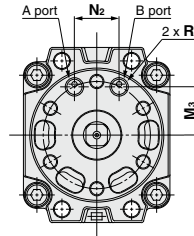
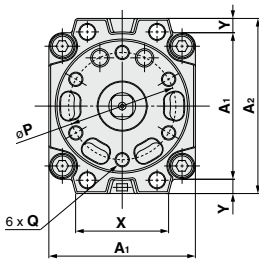
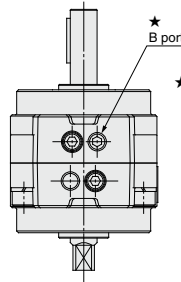
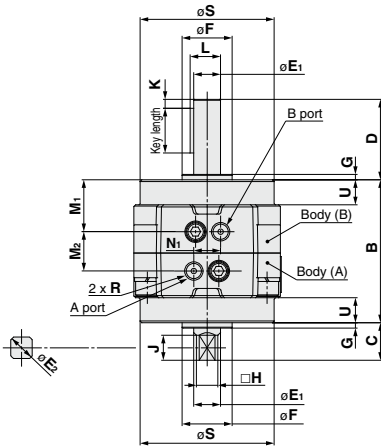

Size	A1	A2	B	C	D	E1 (g6)	E2 (h9)	F (h9)	G	H	J	K	L	M1	M2	M3	N1	N2	P	Q	R (°)	S	T	U	V	W	X	Y	Z
<b>50</b>	67	78	70	19.5	39.5	12 <sup>-0.006</sup> <sub>-0.017</sub>	11.9 <sup>0</sup> <sub>-0.043</sub>	25 <sup>0</sup> <sub>-0.032</sub>	3	10	13	5	13.5	26	18	21	14	18	50	M6 x 1 depth 9	1/8	60	R6	11	34	66	46	5.5	6.5
<b>63</b>	82	98	80	21	45	15 <sup>-0.006</sup> <sub>-0.017</sub>	14.9 <sup>0</sup> <sub>-0.043</sub>	28 <sup>0</sup> <sub>-0.032</sub>	3	12	14	5	17	29	22	27	15	25	60	M8 x 1.25 depth 10	1/8	75	P7.5	14	39	83	52	8	9
<b>80</b>	95	110	90	23.5	53.5	17 <sup>-0.006</sup> <sub>-0.017</sub>	16.9 <sup>0</sup> <sub>-0.043</sub>	30 <sup>0</sup> <sub>-0.032</sub>	3	13	16	5	19	30	30	29	20	30	70	M8 x 1.25 depth 12	1/4	88	R8	15	48	94	63	7.5	9
<b>100</b>	125	140	103	30	65	25 <sup>-0.007</sup> <sub>-0.020</sub>	24.9 <sup>0</sup> <sub>-0.052</sub>	45 <sup>0</sup> <sub>-0.062</sub>	4	19	22	5	28	35.5	32	38	24	38	80	M10 x 1.5 depth 13	1/4	108	R11	11.5	60	120	78	7.5	11

\* For single vane type: Above figures show actuators for 180° when B port is pressurized.  
 \* For double vane type: Figures above show the intermediate rotation position when the A or B port is pressurized.  
 \* In addition to Rc, G and NPT are also available for connection ports.

- CRB□2
- CRB1**
- MSU
- CRJ
- CRA1
- CRQ2
- MSQ
- MSZ
- CRQ2X
- MSQX
- MRQ



# CRB1 Series

## Dimensions: 50, 63, 80, 100 (With auto switch)

Single vane type/Double vane type

CDRB1BW□-□S/D

<Port location: Side ported>

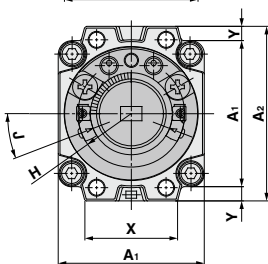
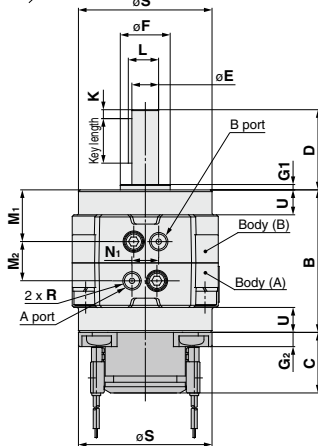
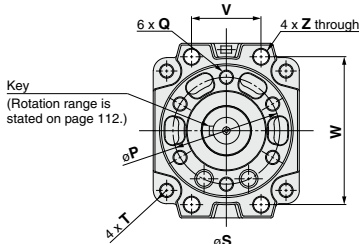

Axial ported (Port location): CDRB1BW□-□SE, CDRB1BW□-□DE

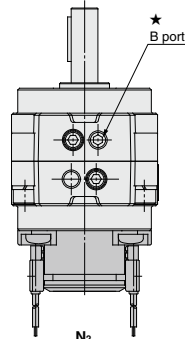

★ If B port of Body (B) is machined, the port is plugged with Rc1/8.

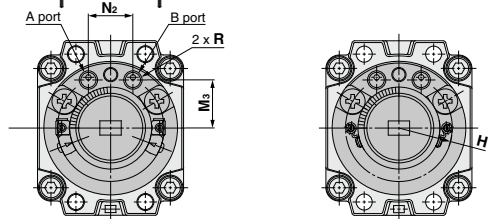

D-M9□

### Key Dimensions

Key dimension			
	b (h9)	h (h9)	L
Size			
50	4 <sup>0</sup> <sub>-0.030</sub>	4 <sup>0</sup> <sub>-0.030</sub>	20
63	5 <sup>0</sup> <sub>-0.030</sub>	5 <sup>0</sup> <sub>-0.030</sub>	25
80	5 <sup>0</sup> <sub>-0.030</sub>	5 <sup>0</sup> <sub>-0.030</sub>	36
100	7 <sup>0</sup> <sub>-0.036</sub>	7 <sup>0</sup> <sub>-0.036</sub>	40

Size																					[mm]								
	A1	A2	B	C	D	E (g6)	F (h9)	G1	G2	H (R)	J	K	L	M1	M2	M3	N1	N2	P	Q	R (+)	S	T	U	V	W	X	Y	Z
50	67	78	70	32	39.5	12 <sup>-0.006</sup> <sub>-0.017</sub>	25 <sup>0</sup> <sub>-0.052</sub>	3	6.5	R22.5	32.5	5	13.5	26	18	21	14	18	50	M6 x 1 depth 9	1/8	60	P6	11	34	66	46	5.5	6.5
63	82	98	80	34	45	15 <sup>-0.006</sup> <sub>-0.017</sub>	28 <sup>0</sup> <sub>-0.052</sub>	3	8	R30	21	5	17	29	22	27	15	25	60	M8 x 1.25 depth 10	1/8	75	R7.5	14	39	83	52	8	9
80	95	110	90	34	53.5	17 <sup>-0.005</sup> <sub>-0.017</sub>	30 <sup>0</sup> <sub>-0.052</sub>	3	8	R30	21	5	19	30	30	29	20	30	70	M8 x 1.25 depth 12	1/4	88	P8	15	48	94	63	7.5	9
100	125	140	103	39	65	25 <sup>-0.007</sup> <sub>-0.020</sub>	45 <sup>0</sup> <sub>-0.062</sub>	4	13	R30	21	5	28	35.5	32	38	24	38	80	M10 x 1.5 depth 13	1/4	108	P11	11.5	60	120	78	7.5	11

\* For single vane type: Above figures show actuators for 180° when B port is pressurized.

\* For double vane type: Figures above show the intermediate rotation position when the A or B port is pressurized.

\* In addition to Rc, G and NPT are also available for connection ports.



# CRB1 Series

## With One-touch Fittings: 50

### Basic type

CRB1□W50F-□□

<Port location: Side ported>

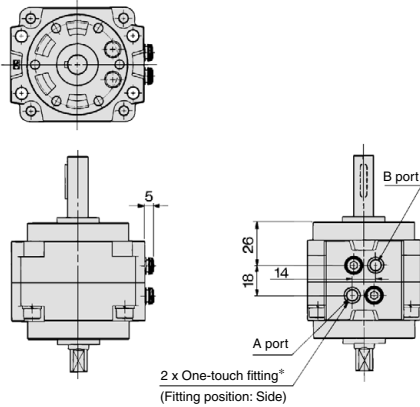

### With auto switch

CDRB1□W50F-□□□

<Port location: Side ported>

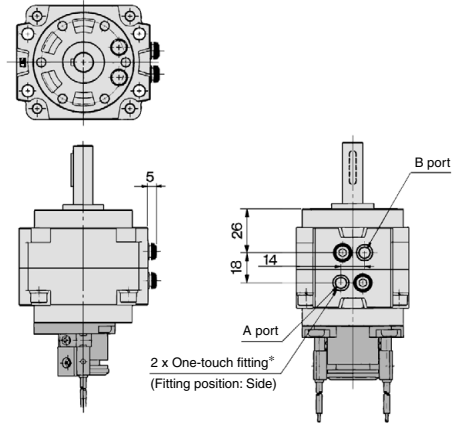

### CRB1□W50F-□□E

<Port location: Axial ported>

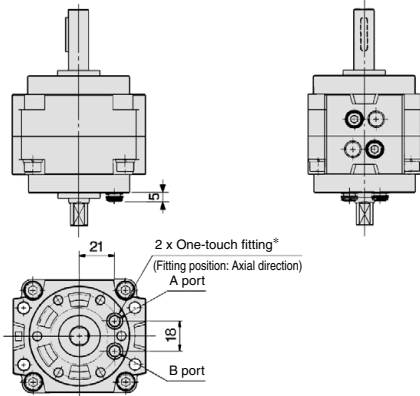

### CDRB1□W50F-□□E-□

<Port location: Axial ported>

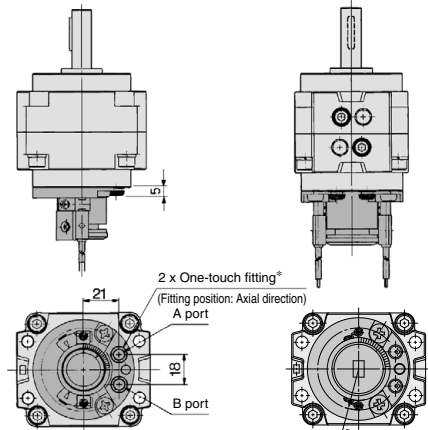

D-M9□

### Applicable Tubing and O.D./I.D

Applicable tubing O.D./I.D [mm]	ø6/ø4
Applicable tubing material	Nylon, Soft nylon, Polyurethane

\* Dimensions not indicated in the above figures are the same as size 50 actuator.

\* Keys in the figures above show the intermediate rotation position for single vane type.

# Rotary Actuator with Solenoid Valve

## *CVRB1 Series*

### Size: 50, 63, 80, 100

#### How to Order

#### Rotary Actuator

**Rotary** **CDVRB1 B W 80 - 90 S - M9B L** **Made to Order**

For details, refer to pages 124 to 126, 133 and 134.

**Auto switch**

<b>Nil</b>	Basic type
<b>D</b>	With auto switch (With auto switch unit and built-in magnet)

**Mounting**

<b>B</b>	Basic
<b>L</b>	Foot

**Size**

<b>50</b>
<b>63</b>
<b>80</b>
<b>100</b>

**Shaft type**

<b>W</b>	Double shaft (Long shaft key & Four chamfers)
----------	---

**Rotating angle**

<b>90</b>	90°
<b>100</b>	100°
<b>180</b>	180°
<b>190</b>	190°
<b>270</b>	270°
<b>280</b>	280°

**Vane type**

<b>S</b>	Single vane
<b>D</b>	Double vane

**Auto switch**

<b>Nil</b>	Without auto switch (Built-in magnet)
<b>M</b>	Without D-M9 type auto switch (Built-in magnet)

**Number of auto switches**

<b>S</b>	1 pc.*
<b>Nil</b>	2 pcs.**

\* S: A right-hand auto switch is shipped.  
\*\* Nil: A right-hand switch and a left-hand switch are shipped.

**Electrical entry/Lead wire length**

<b>Nil</b>	Grommet/Lead wire: 0.5 m
<b>M</b>	Grommet/Lead wire: 1 m
<b>L</b>	Grommet/Lead wire: 3 m
<b>CN</b>	Connector/Without lead wire
<b>CL</b>	Connector/Lead wire: 0.5 m
<b>CL</b>	Connector/Lead wire: 3 m

\* Connectors are available only for the R73, R80, T79.  
\*\* Lead wire with connector part nos.  
D-LC05: Lead wire 0.5 m  
D-LC30: Lead wire 3 m  
D-LC50: Lead wire 5 m

**How to Order (Example)**

When ordering the rotary actuator with solenoid valve, CVRB1 series, specify the models of both the rotary and the valve (solenoid valve).

(Note) For the valve, add \* in front of the part number when ordering.  
Example) CDVRB1BW80-90S-R73 ...1 pc.  
\*VZ5140-5LZ .....1 pc.

\* For applicable auto switch model, refer to the table below.  
\*\* The operating range and hysteresis of the D-M9□ are different from those of the other auto switches. For details, refer to page 135.

#### Solenoid Valve

**Valve** **VZ 3 1 40 - 5 L** **X199**

**Valve series**

<b>3</b>	VZ3000 series	□ VVRB1BW50,63
<b>5</b>	VZ5000 series	□ VVRB1BW80,100

**Type of actuation**

<b>1</b>	2-position single solenoid
<b>2</b>	2-position double solenoid

**Rated voltage**

<b>1</b>	100 VAC 50/60 Hz
<b>2</b>	200 VAC 50/60 Hz
<b>5</b>	24 VDC

**Electrical entry**

<b>Grommet</b>	<b>L plug connector</b>	<b>M plug connector</b>	<b>DIN terminal</b>
<b>G:</b> Lead wire length 300 mm	<b>L:</b> With lead wire (Wire length: 300 mm)	<b>M:</b> With lead wire (Wire length: 300 mm)	<b>D:</b> With connector
<b>H:</b> Lead wire length 600 mm	<b>LO:</b> Without connector	<b>MO:</b> Without connector	<b>DO:</b> Without connector

**Manual**

**Nil:** Non-locking push type **B:** Locking B type (Slotted)

**C:** Locking C type (Manual)

**Light/Surge voltage suppressor**

<b>Nil</b>	Without light/surge voltage suppressor
<b>S</b>	With surge voltage suppressor
<b>Z (Note)</b>	With light/surge voltage suppressor

Note) GZ, HZ and DOZ are not available.

#### Applicable Auto Switches/Refer to pages 797 to 850 for further information on auto switches.

Type	Special function	Electrical entry	Indicator light	Wiring (Output)	Load voltage		Auto switch model		Lead wire type	Lead wire length [m]					Pre-wired connector	Applicable load
					DC	AC	Perpendicular	In-line		0.5 (Nil)	1 (M)	3 (L)	5 (Z)	None (N)		
Solid state auto switch	Grommet	—	Yes	3-wire (NPN) 3-wire (PNP) 2-wire 3-wire (NPN) 3-wire (PNP)	24 V	5 V,	—	M9NV M9N M9PV M9P M9BV M9B S79 S7P T79 R79C R73 R80 R80C	Oilproof heavy-duty cord	●	●	●	○	—	—	IC circuit
						12 V										
						12 V										
						5 V,										
						12 V										
						12 V										
Reed auto switch	Connector	—	No	2-wire	—	100 V	—	R73 R73C R80 R80C	—	●	●	●	○	—	—	
						48 V, 100 V										
						100 V										
						24 V or less										

\* Lead wire length symbols:  
0.5 m ..... Nil (Example) R73C  
3 m ..... L (Example) R73CL  
5 m ..... Z (Example) R73CZ  
None ..... N (Example) R73CN

\* Solid state auto switches marked with "○" are produced upon receipt of order.

CRB12  
CRB1  
MSU  
CRJ  
CRA1  
CRQ2  
MSQ  
MSZ  
CRQ2X  
MSQX  
MRQ

D-□

# CVRB1 Series

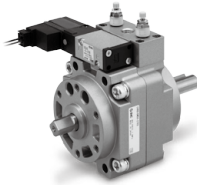

Made to Order

## Made to Order

(For details, refer to pages 124 to 126, 133 and 134.)

Symbol	Description
<b>XA1 to XA24</b>	Shaft type pattern
<b>XC1</b>	Addition of connection port
<b>XC4</b>	Change of rotating angle
<b>XC5</b>	Change of rotating angle
<b>XC6</b>	Change of rotating angle
<b>XC7</b>	Reversed shaft
<b>XC26</b>	Change of rotating angle
<b>XC27</b>	Change of rotation range and direction
<b>XC30</b>	Fluorine grease

Refer to pages 135 to 137 for actuators with auto switches.

- Auto switch unit and switch block unit
- Operating range and hysteresis
- How to change the auto switch detecting position
- Auto switch mounting
- Auto switch adjustment

## Solenoid Valve Specifications

Model		VZ3000/5000 series
<b>Manual override</b>		Non-locking push type Locking type (Slotted), Locking type (Manual)
<b>Pilot exhaust type</b>		Pilot valve individual exhaust
<b>Mounting position</b>		Free
<b>Impact/Vibration resistance [m/s<sup>2</sup>] <small>Note 1)</small></b>		300/50
<b>Enclosure</b>		Dusttight
<b>Electrical entry</b>		Grommet (G)/(H), L plug connector (L), M plug connector (M), DIN terminal (D)
<b>Coil rated voltage [V]</b>	AC 50/60 Hz	100, 200
	DC	24
<b>Allowable voltage fluctuation [%]</b>		-15 to +10 of rated voltage
<b>Power consumption [W] [Current mA] <small>Note 2)</small></b>		DC 1.8 (With light: 2.1) (24 VDC: 75 [With light: 87.5])
<b>Apparent power [VA] <small>Note 2)</small></b> <b>[Current mA]</b>	AC	Inrush 4.5 to 50 Hz, 4.2/60 Hz <small>[100 VAC: 45/50 Hz, 42/60 Hz] [200 VAC: 22.5/50 Hz, 21/60 Hz]</small>
		Holding 3.5/50 Hz, 3/60 Hz <small>[100 VAC: 35/50 Hz, 30/60 Hz] [200 VAC: 17.5/50 Hz, 15/60 Hz]</small>
<b>Surge voltage suppressor</b>		DC: Diode, AC: ZNR
<b>Indicator light</b>		DC: LED (Red), AC: Neon bulb

· Option

Note 1) Impact resistance: No malfunction occurred in the impact test using a drop impact tester. The test was performed at both energized and de-energized states to the axis and right angle direction of the main valve and armature.

Vibration resistance: No malfunction occurred in the one-sweep test between 45 and 2000 Hz. A test was performed at both energized and de-energized states to the axis and right angle direction of the main valve and armature. (Value in the initial stage.)

Note 2) At the rated voltage.

### About rotary actuator specifications

The vibration adjustment range differs from that of the standard series.

With solenoid valve: 0.3 to 1 s/90°

Other specifications and structures are similar to those of the standard CRB1 series. Refer to pages 111 and 116.

## Dimensions

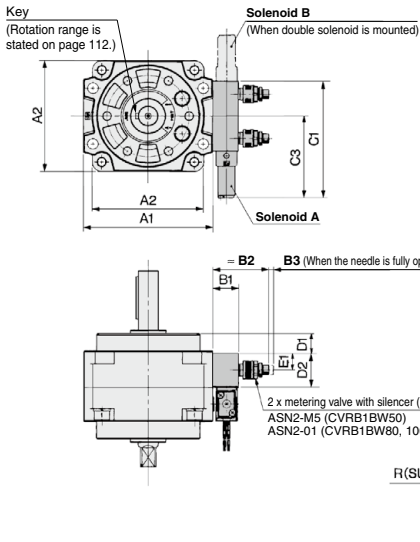

\* Keys in the figures below show the intermediate rotation position for single vane type.

Note 1) Solenoid valve in external appearance is for VZ1140-1G.

Note 2) Solenoid valve dimensions: 2-position single solenoid, ( ): 2-position double solenoid.

Size	A1	A2	B1	B2	B3	C1	C2	C3	D1	D2	E1	E2	F1	F2	G	R
<b>50</b>	78	67	18	36	2.8	82.5	120 (136.5)	60 (61)	12	24	11.5	30	52 (53)	104 (120.5)	25	1/8
<b>63</b>	98	82	18	36	2.8	88	102 (136.5)	60 (61)	16	24	11.5	30	52 (53)	104 (120.5)	27.5	1/8
<b>80</b>	110	95	22	48	4	100	140 (155 )	70 (71)	17	29	14	38	62 (63)	124 (139 )	36	1/8
<b>100</b>	140	125	22	48	4	100	140 (155 )	70 (71)	23.5	29	14	38	62 (63)	124 (139 )	42.5	1/8



# CRB1 Series (Size: 50, 63, 80, 100)

## Simple Specials

### -XA1 to -XA24: Shaft Pattern Sequencing I

Shaft shape pattern is dealt with simple made-to-order system. (Refer to the front matter.)  
Please contact SMC for a specification sheet when placing an order.

Symbol

**-XA1 to XA24**

#### Shaft Pattern Sequencing I

Applicable shaft type: W (Standard)

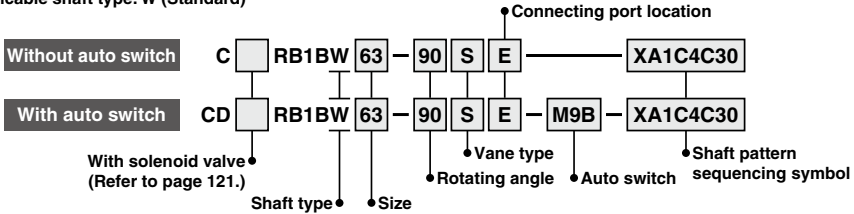

#### Shaft Pattern Sequencing Symbol

Note) The tolerance of the additionally machined parts conforms to the general tolerance.

##### ● Axial: Top (Long shaft side)

Symbol	Description	Size			
		50	63	80	100
XA1	Shaft-end female thread	●	●	●	●
XA14*	Shaft through-hole + Shaft-end female thread	●	●	●	●
XA17*	Change of long shaft length (Change of key length)	●	●	●	●
XA24*	Double key	●	●	●	●

\* The vane type for the shaft through-hole is compatible with single vanes only.

##### ● Axial: Bottom (Short shaft side)

Symbol	Description	Size			
		50	63	80	100
XA2*	Shaft-end female thread	●	●	●	●
XA15*	Shaft through-hole + Shaft-end female thread	●	●	●	●
XA18*	Change of short shaft length	●	●	●	●

\* The vane type for the shaft through-hole is compatible with single vanes only.

##### ● Double Shaft

Symbol	Description	Size			
		50	63	80	100
XA13*	Shaft through-hole	●	●	●	●
XA16*	Shaft through-hole + Double shaft-end female threads	●	●	●	●
XA19*	Change of double shaft length	●	●	●	●
XA20*	Reversed shaft, Change of double shaft length	●	●	●	●

\* The vane type for the shaft through-hole is compatible with single vanes only.  
\* The product with an auto switch is available only for XA1, 14, 17 and 24.

#### Combination

##### XA□ Combination

Symbol	Description	Axial direction		Combination													
		Up	Down	XA1	XA2	XA13	XA14	XA15	XA16	XA17	XA18	XA19	XA20	XA24			
XA1	Shaft-end female thread	●	—	●	—	—	—	—	—	—	—	—	—	—	—	—	—
XA2	Shaft-end female thread	—	●	—	●	—	—	—	—	—	—	—	—	—	—	—	—
XA13	Shaft through-hole	●	—	—	—	—	—	—	—	—	—	—	—	—	—	—	—
XA14	Shaft through-hole + Shaft-end female thread	●	—	—	—	—	—	—	—	—	—	—	—	—	—	—	—
XA15	Shaft through-hole + Shaft-end female thread	—	●	—	—	—	—	—	—	—	—	—	—	—	—	—	—
XA16	Shaft through-hole + Double shaft-end female threads	●	—	—	—	—	—	—	—	—	—	—	—	—	—	—	—
XA17	Change of long shaft length (Change of key length)	—	—	—	●	—	—	—	—	—	—	—	—	—	—	—	—
XA18	Change of short shaft length	—	●	—	—	—	—	—	—	—	—	—	—	—	—	—	—
XA19	Change of double shaft length	—	●	—	—	—	—	—	—	—	—	—	—	—	—	—	—
XA20	Reversed shaft, Change of double shaft length	—	●	—	—	—	—	—	—	—	—	—	—	—	—	—	—
XA24	Double key	●	—	—	—	—	—	—	—	—	—	—	—	—	—	—	—

A total of two XA□ combinations is available.  
Example: XA1A24

##### XA□, XC□ Combination

Combination other than -XA□, such as Made to Order (-XC□), is also available. Refer to pages 133 to 134 for details about made-to-order specifications.

Symbol	Description	Size	XA1, XA2 XA13 to 20, 24	
			●	—
XC1	Addition of connection port	50, 63 80, 100	●	—
XC4	Change of rotating angle		●	—
XC5	Change of rotating angle		●	—
XC6	Change of rotating angle		●	—
XC7	Reversed shaft		—	—
XC26	Change of rotating angle		●	—
XC27	Change of rotation range and direction		●	—
XC30	Fluorine grease		●	—

A total of four XA□ and XC□ combinations is available.  
Example: XA1A24C1C30

## Axial: Top (Long shaft side)

**Symbol: A1** Machine female threads into the long shaft.

- The maximum dimension L1 is, as a rule, twice the thread size.  
(Example) For M3: L1 = 6
- Applicable shaft type: W

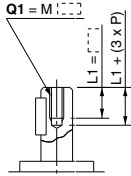

Size	Q1
50	M3, M4, M5
63	M4, M5, M6
80	M4, M5, M6
100	M5, M6, M8

**Symbol: A14** Applicable to single vane type only

A special end is machined onto the long shaft, and a through-hole is drilled into it. Female threads are machined into the through-holes, whose diameter is equivalent to the diameter of the pilot holes.

- The maximum dimension L1 is, as a rule, twice the thread size.  
(Example) For M5: L1 = 10
- Applicable shaft type: W

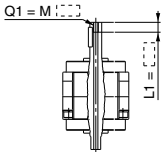

Size	50	63	80	100
Thread				
M5 x 0.8	ø4.2	ø4.2	ø4.2	—
M6 x 1	—	ø5	ø5	ø5
M8 x 1.25	—	—	—	ø6.8

**Symbol: A17** Shorten the long shaft.

- Applicable shaft type: W

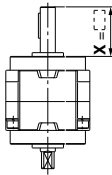

Size	X
50	24.5 to 39.5
63	28 to 45
80	30.5 to 53.5
100	40 to 65

**Symbol: A24** Double key

Keys and keyways are machined at 180° of standard position.

- Applicable shaft type: W
- Equal dimensions are indicated by the same marker.

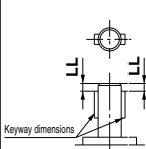

Size	Keyway dimension	LL
50	4 x 4 x 20	5
63	5 x 5 x 25	
80	5 x 5 x 36	
100	7 x 7 x 40	

## Axial: Bottom (Short shaft side)

**Symbol: A2** Machine female threads into the short shaft.

- The maximum dimension L2 is, as a rule, twice the thread size.  
(Example) For M4: L2 = 8
- Applicable shaft type: W

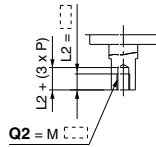

Size	Q2
50	M3, M4, M5
63	M4, M5, M6
80	M4, M5, M6
100	M5, M6, M8

**Symbol: A15** Applicable to single vane type only

A special end is machined onto the short shaft, and a through-hole is drilled into it. Female threads are machined into the through-hole, whose diameter is equivalent to the pilot hole diameter.

- The maximum dimension L2 is, as a rule, twice the thread size.  
(Example) For M4: L2 = 8
- Applicable shaft type: W

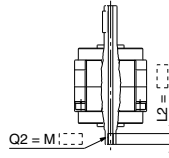

Size	50	63	80	100
Thread				
M5 x 0.8	ø4.2	ø4.2	ø4.2	—
M6 x 1	—	ø5	ø5	ø5
M8 x 1.25	—	—	—	ø6.8

**Symbol: A18** Shorten the short shaft.

- Applicable shaft type: W

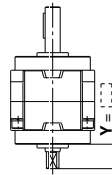

Size	Y
50	4 to 19.5
63	4 to 21
80	4 to 23.5
100	5 to 30

CRB2

CRB1

MSU

CRJ

CRA1

CRQ2

MSQ

MSZ

CRQ2X

MSQX

MRQ

D-□

## Double Shaft

### Symbol: A13

Applicable to single vane type only

Shaft with through-hole

- Minimum machining diameter for d1 is 0.1.
- Applicable shaft type: W

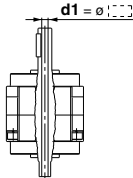

Size	d1	[mm]
<b>50</b>	ø4 to ø5	
<b>63</b>	ø4 to ø6	
<b>80</b>	ø4 to ø6.5	
<b>100</b>	ø5 to ø8	

### Symbol: A16

Applicable to single vane type only

A special end is machined onto both the long and short shafts, and a through-hole is drilled into both shafts. Female threads are machined into the through-holes, whose diameter is equivalent to the diameter of the pilot holes.

- The maximum dimension L1 is, as a rule, twice the thread size.
- (Example) For M5: L1 = 10
- Applicable shaft type: W

• Equal dimensions are indicated by the same marker.

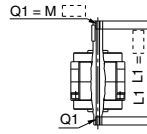

Size	50	63	80	100	[mm]
Thread					
M5 x 0.8	ø4.2	ø4.2	ø4.2	—	
M6 x 1	—	ø5	ø5	ø5	
M8 x 1.25	—	—	—	ø6.8	

### Symbol: A19

Shorten both long and short shafts.

- Applicable shaft type: W

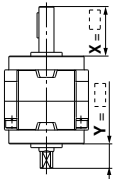

Size	X	Y	[mm]
<b>50</b>	24.5 to 39.5	4 to 19.5	
<b>63</b>	28 to 45	4 to 21	
<b>80</b>	30.5 to 53.5	4 to 23.5	
<b>100</b>	40 to 65	5 to 30	

### Symbol: A20

The rotation axis is reversed.

(If shortening the shaft is not required, indicate "\*" for dimension X, Y.)

- Applicable shaft type: W

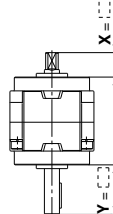

Size	X	Y	[mm]
<b>50</b>	4 to 19.5	24.5 to 39.5	
<b>63</b>	4 to 21	28 to 45	
<b>80</b>	4 to 23.5	30.5 to 53.5	
<b>100</b>	5 to 30	40 to 65	

# CRB1 Series (Size: 50, 63, 80, 100)

## Simple Specials

### -XA31 to -XA60: Shaft Pattern Sequencing II

Shaft shape pattern is dealt with simple made-to-order system. (Refer to the front matter.)

Please contact SMC for a specification sheet when placing an order.

Symbol

#### Shaft Pattern Sequencing II

-XA31 to XA60

Applicable shaft type: J, K, S, T, X, Y, Z

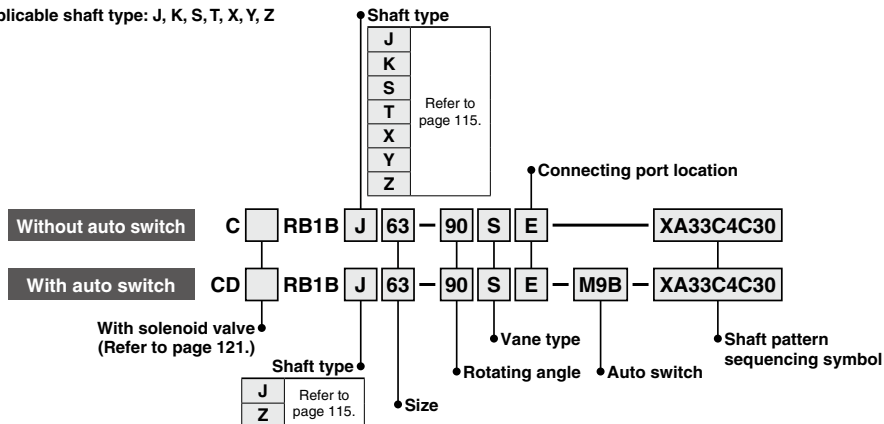

CRB1

CRB1

MSU

CRJ

CRA1

CRQ2

MSQ

MSZ

CRQ2X  
MSQX

MRQ

#### Shaft Pattern Sequencing Symbol

##### ● Axial: Top (Long shaft side)

Symbol	Description	Shaft type	Size
XA31	Shaft-end female thread	S, Y	50, 63, 80, 100
XA33	Shaft-end female thread	J, K, T	
XA35	Shaft-end female thread	X, Z	
XA37	Stepped round shaft	J, K, T	
XA45	Middle-cut chamfer	J, K, T	
XA48	Change of long shaft length (With keyway)	S, Y	
XA51	Change of long shaft length (Without keyway)	J, K, T	
XA54	Change of long shaft length (With four chamfers)	X, Z	

##### ● Axial: Bottom (Short shaft side)

Symbol	Description	Shaft type	Size
XA32	Shaft-end female thread	S, Y	50, 63, 80, 100
XA34	Shaft-end female thread	K, T	
XA36	Shaft-end female thread	J, X, Z	
XA38	Stepped round shaft	K	
XA46	Middle-cut chamfer	K	
XA49	Change of short shaft length (With keyway)	Y	
XA52	Change of short shaft length (Without keyway)	K	
XA55	Change of short shaft length (With four chamfers)	J, Z	

##### ● Double Shaft

Symbol	Description	Shaft type	Size
XA39*	Shaft through-hole	S, Y	50, 63, 80, 100
XA40*	Shaft through-hole	K, T	
XA41*	Shaft through-hole	J, X, Z	
XA42*	Shaft through-hole + Double shaft-end female threads	S, Y	
XA43*	Shaft through-hole + Double shaft-end female threads	K, T	
XA44*	Shaft through-hole + Double shaft-end female threads	J, X, Z	
XA50	Change of double shaft length (Both sides with keyway)	Y	
XA53	Change of double shaft length (Without keyway)	K	
XA56	Change of double shaft length (Both sides with four chamfers)	Z	
XA57	Change of double shaft length (With four chamfers, without keyway)	J	
XA58	Reversed shaft, Change of double shaft length (With four chamfers, without keyway)	J, T	
XA59	Reversed shaft, Change of shaft length (With four chamfers)	X	
XA60	Reversed shaft, Change of shaft length (With keyway)	S	

\* The vane type for the shaft through-hole is compatible with single vanes only.

\* The product with an auto switch is available only for J and Z shafts of XA33, 35, 37, 45, 51 and 54.

D-□



## Axial: Top (Long shaft side)

**Symbol: A31** Machine female threads into the long shaft.

- The maximum dimension L1 is, as a rule, twice the thread size.  
(Example) For M3: L1 = 6
- Applicable shaft type: S, Y

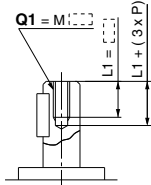

Q1 [mm]			
Size	S	Y	
50	M3, M4, M5		
63	M4, M5, M6		
80	M4, M5, M6		
100	M5, M6, M8		

**Symbol: A33** Machine female threads into the long shaft.

- The maximum dimension L1 is, as a rule, twice the thread size.  
(Example) For M3: L1 = 6
- Applicable shaft type: J, K, T

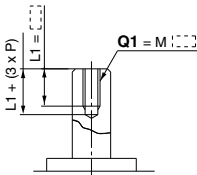

Q1 [mm]			
Size	J	K	T
50	M3, M4, M5, M6		
63	M4, M5, M6		
80	M4, M5, M6, M8		
100	M5, M6, M8, M10		

**Symbol: A35** Machine female threads into the long shaft.

- The maximum dimension L1 is, as a rule, twice the thread size.  
(Example) For M3: L1 = 6
- Applicable shaft type: X, Z

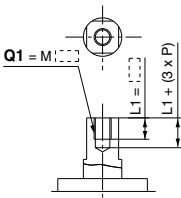

Q1 [mm]		
Size	X	Z
50	M3, M4, M5	
63	M4, M5, M6	
80	M4, M5, M6	
100	M5, M6, M8	

**Symbol: A37** The long shaft can be further shortened by machining it into a stepped round shaft.

- (If shortening the shaft is not required, indicate "\*" for dimension X.)  
(If not specifying dimension CA, indicate "\*" instead.)
- Equal dimensions are indicated by the same marker.
- Applicable shaft type: J, K, T

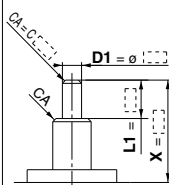

Size	X			L1 max			D1		
	J	K	T	J	K	T	J	K	T
50	4 to 39.5	X-3	3 to 11.9						
63	4 to 45	X-3	3 to 14.9						
80	4 to 53.5	X-3	3 to 16.9						
100	5 to 65	X-4	3 to 24.9						

## Axial: Bottom (Short shaft side)

**Symbol: A32** Machine female threads into the short shaft.

- The maximum dimension L2 is, as a rule, twice the thread size.  
(Example) For M4: L2 = 8
- Applicable shaft type: S, Y

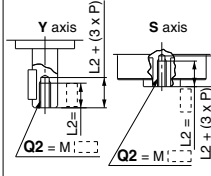

Q2 [mm]			
Size	S	Y	
50	M3, M4, M5, M6	M3, M4, M5	
63	M4, M5, M6	M4, M5, M6	
80	M4, M5, M6, M8	M4, M5, M6	
100	M5, M6, M8, M10	M5, M6, M8	

**Symbol: A34** Machine female threads into the short shaft.

- The maximum dimension L2 is, as a rule, twice the thread size.  
(Example) For M3: L2 = 6
- Applicable shaft type: K, T

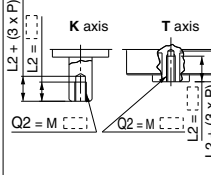

Q2 [mm]		
Size	K	T
50	M3, M4, M5, M6	
63	M4, M5, M6	
80	M4, M5, M6, M8	
100	M5, M6, M8, M10	

**Symbol: A36** Machine female threads into the short shaft.

- The maximum dimension L2 is, as a rule, twice the thread size.  
(Example) For M3: L2 = 6
- Applicable shaft type: J, X, Z

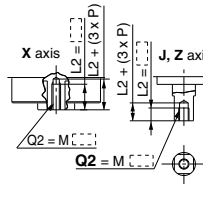

Q2 [mm]			
Size	X	J	Z
50	M3, M4, M5, M6	M3, M4, M5	
63	M4, M5, M6	M4, M5, M6	
80	M4, M5, M6, M8	M4, M5, M6	
100	M5, M6, M8, M10	M5, M6, M8	

**Symbol: A38** The short shaft can be further shortened by machining it into a stepped round shaft.

- (If shortening the shaft is not required, indicate "\*" for dimension Y.)  
(If not specifying dimension CB, indicate "\*" instead.)
- Equal dimensions are indicated by the same marker.
- Applicable shaft type: K

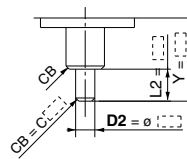

Size	Y		L2 max		D2	
	Y	L2 max	Y-3	3 to 11.9	Y	D2
50	4 to 39.5	Y-3	3 to 11.9			
63	4 to 45	Y-3	3 to 14.9			
80	4 to 53.5	Y-3	3 to 16.9			
100	5 to 65	Y-4	3 to 24.9			

CRB2

CRB1

MSU

CRJ

CRA1

CRQ2

MSQ

MSZ

CRQ2X

MSQX

MRQ

D-□

# CRB1 Series

## Axial: Top (Long shaft side)

**Symbol: A45** The long shaft can be further shortened by machining a middle-cut chamfer into it.  
(The position of the chamfer is same as the standard one.)

(If shortening the shaft is not required, indicate "∞" for dimension X.)

- Minimum machining dimension is 0.1.
- Applicable shaft type: J, K, T

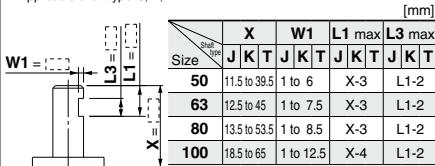

**Symbol: A48** Shorten the long shaft.

- Applicable shaft type: S, Y

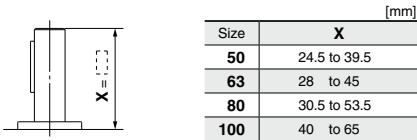

**Symbol: A51** Shorten the long shaft.

- Applicable shaft type: J, K, T

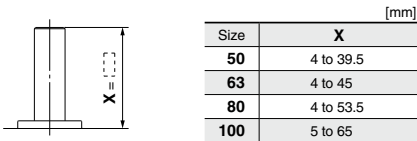

**Symbol: A54** Shorten the long shaft.

- Applicable shaft type: X, Z

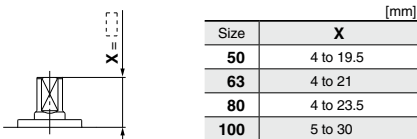

## Axial: Bottom (Short shaft side)

**Symbol: A46** The short shaft can be further shortened by machining a middle-cut chamfer into it.  
(The position of the chamfer is same as the standard one.)

(If shortening the shaft is not required, indicate "∞" for dimension X.)

- Minimum machining dimension is 0.1.
- Applicable shaft type: K

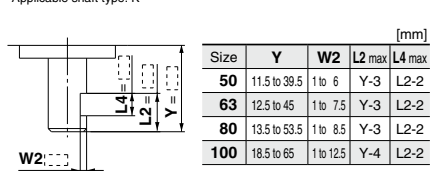

**Symbol: A49** Shorten the short shaft.

- Applicable shaft type: Y

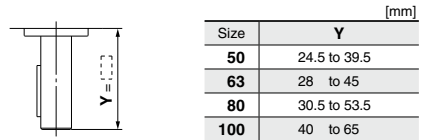

**Symbol: A52** Shorten the long shaft.

- Applicable shaft type: K

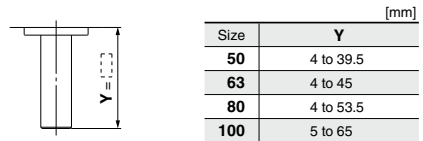

**Symbol: A55** Shorten the short shaft.

- Applicable shaft type: J, Z

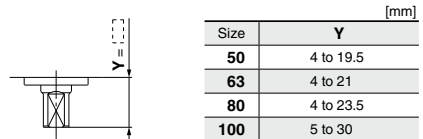

**Symbol: A59** Reverse the assembly of the shaft, and shorten the long shaft.

- Applicable shaft type: X

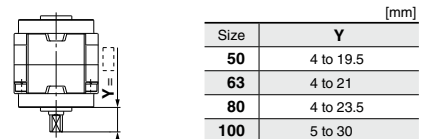

**Symbol: A60** Reverse the assembly of the shaft, and shorten the long shaft.

- Applicable shaft type: S

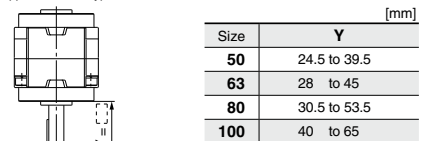

## Caution

For the shaft patterns A45 and A46, a middle-cut chamfer may interfere with the center hole if the W1/W2 dimensions and (L1 - L3), (L2 - L4) dimensions are less than what are shown in the table below.

Size	W1 W2		L1-L3		L2-L4
	W1	W2	L1-L3	L2-L4	
50	4.5	to 6	2	to 5.5	
63	6	to 7.5	2	to 3	
80	6.5	to 8.5	2	to 6.5	
100	10.5	to 12.5	2	to 6.5	

## Double Shaft

**Symbol: A39** Applicable to single vane type only

Shaft with through-hole  
 • Minimum machining diameter for d1 is 0.1.  
 • Applicable shaft type: S, Y

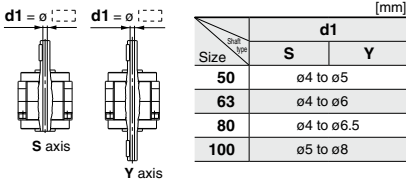

**Symbol: A40** Applicable to single vane type only

Shaft with through-hole  
 • Minimum machining diameter for d1 is 0.1.  
 • Applicable shaft type: K, T

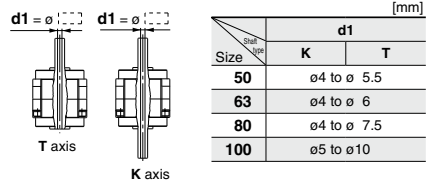

**Symbol: A41** Applicable to single vane type only

Shaft with through-hole  
 • Minimum machining diameter for d1 is 0.1.  
 • Applicable shaft type: J, X, Z

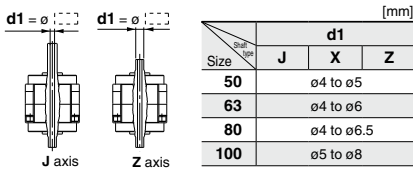

**Symbol: A42** Applicable to single vane type only

A special end is machined onto both the long and short shafts, and a through-hole is drilled into both shafts. Female threads are machined into the through-holes, whose diameter is equivalent to the diameter of the pilot holes.  
 • The maximum dimension L1 is, as a rule, twice the thread size.  
 • Applicable shaft type: S, Y • Equal dimensions are indicated by the same marker.

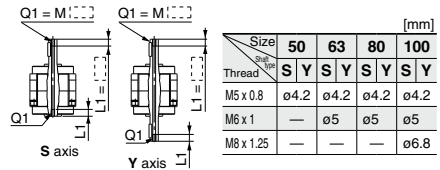

**Symbol: A43** Applicable to single vane type only

A special end is machined onto both the long and short shafts, and a through-hole is drilled into both shafts. Female threads are machined into the through-holes, whose diameter is equivalent to the diameter of the pilot holes.  
 • The maximum dimension L1 is, as a rule, twice the thread size.  
 • Applicable shaft type: K, T • Equal dimensions are indicated by the same marker.

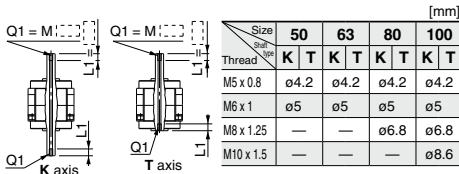

**Symbol: A44** Applicable to single vane type only

A special end is machined onto both the long and short shafts, and a through-hole is drilled into both shafts. Female threads are machined into the through-holes, whose diameter is equivalent to the diameter of the pilot holes.  
 • The maximum dimension L1 is, as a rule, twice the thread size.  
 • Applicable shaft type: J, X, Z • Equal dimensions are indicated by the same marker.

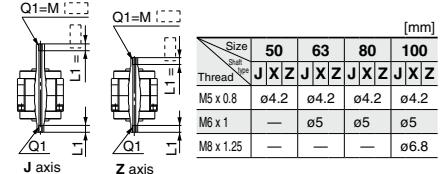

**Symbol: A50** Shorten both long and short shafts.

• Applicable shaft type: Y

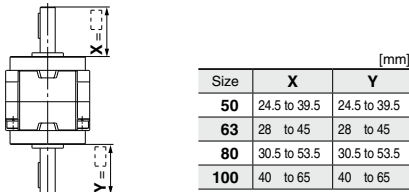

**Symbol: A53** Shorten both long and short shafts.

• Applicable shaft type: K

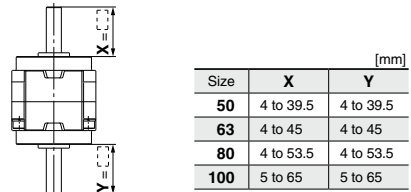

CRB2  
**CRB1**  
 MSU  
 CRJ  
 CRA1  
 CRQ2  
 MSQ  
 MSZ  
 CRQ2X  
 MSQX  
 MRQ

D-□



## Double Shaft

### Symbol: A56

Shorten both long and short shafts.

- Applicable shaft type: Z

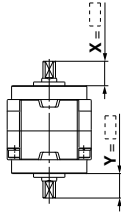

[mm]		
Size	X	Y
50	4 to 19.5	4 to 19.5
63	4 to 21	4 to 21
80	4 to 23.5	4 to 23.5
100	5 to 30	5 to 30

### Symbol: A57

Shorten both long and short shafts.

- Applicable shaft type: J

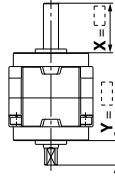

[mm]		
Size	X	Y
50	4 to 39.5	4 to 19.5
63	4 to 45	4 to 21
80	4 to 53.5	4 to 23.5
100	5 to 65	5 to 30

### Symbol: A58

The rotation axis is reversed.

The long shaft and short shaft are shortened.

(If shortening the shaft is not required, indicate "\*" for dimension X, Y.)

- Applicable shaft type: J, T

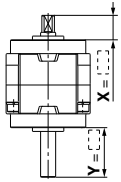

[mm]		
Size	X	Y
50	4 to 19.5	4 to 39.5
63	4 to 21	4 to 45
80	4 to 23.5	4 to 53.5
100	5 to 30	5 to 65

# CRB1 Series (Size: 50, 63, 80, 100)

## Made to Order

### XC1, 4, 5, 6, 7, 26, 27, 30

#### How to Order

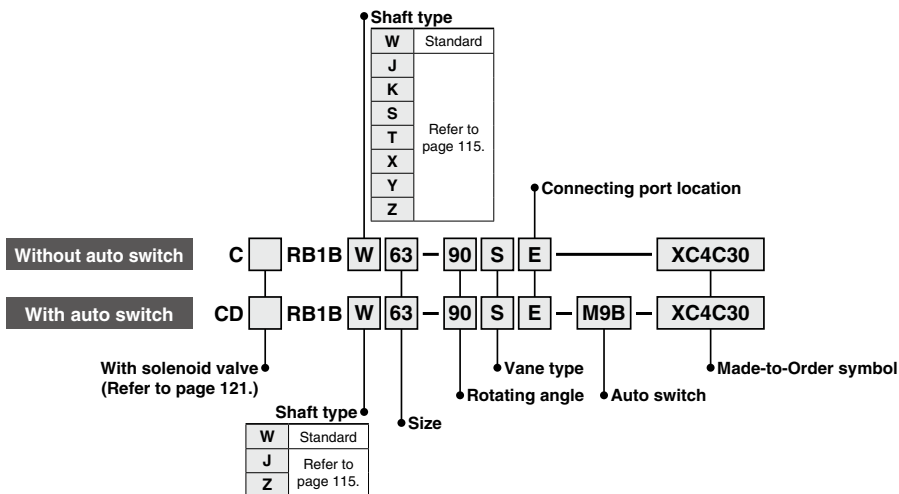

CRB1
CRB1
MSU
CRJ
CRA1
CRQ2
MSQ
MSZ
CRQ2X
MSQX
MRQ

#### Made-to-Order Symbol

Symbol	Description	Applicable shaft type	Size
		W, J, K, S, T, X, Y, Z	
XC1	Addition of connection port	●	50, 63, 80, 100
XC4	Change of rotating angle	●	
XC5	Change of rotating angle	●	
XC6	Change of rotating angle	●	
XC7*	Reversed shaft	●	
XC26	Change of rotating angle	●	
XC27	Change of rotation range and direction	●	
XC30	Fluorine grease	●	

\* This specification is not available for rotary actuators with auto switch unit.

#### Combination

Symbol	Combination	
	XC1	XC30
XC1	—	●
XC4	●	●
XC5	●	●
XC6	●	●
XC7	●	●
XC26	●	●
XC27	●	●
XC30	●	—

**Symbol: C1** Add connection ports on Body (A). (An additionally machined port will have an aluminum surface since it will be left unfinished.)

Size	[mm]		
	Q	M	N
50	Rc1/8	21	18
63	Rc1/8	27	25
80	Rc1/4	29	30
100	Rc1/4	38	38

**Symbol: C4** Change of rotating angle. (Applicable to single vane type only) Start of rotation is horizontal line (90° down from the top to the right side).

Size	[mm]	
	Rotation range θ	
50		
63	45°±8°	90°±8°
80		
100		



# CRB1 Series

## Symbol: C5

Change of rotating angle. (Applicable to single vane type only)  
Start of rotation is 45° up from the bottom of the vertical line to the left side.

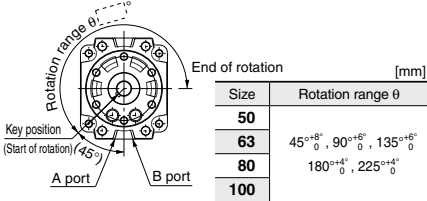

Start of rotation is the position of the key when B port is pressurized.  
(Top view from long shaft side)

## Symbol: C7

The shafts are reversed.

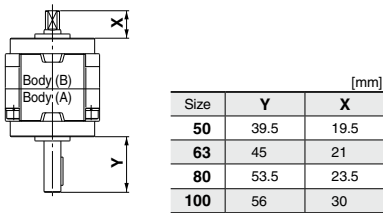

## Symbol: C27

Change of rotating angle. (Applicable to double vane type only)  
Rotating angle 90° Start of rotation is 45° up from the bottom of the vertical line of the right side.

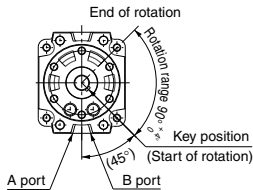

Start of rotation is the position of the key when A port is pressurized.  
(Top view from long shaft side)

## Symbol: C6

Change of rotating angle. (Applicable to single vane type only)  
Start of rotation is horizontal line (90° down from the top to the left side).

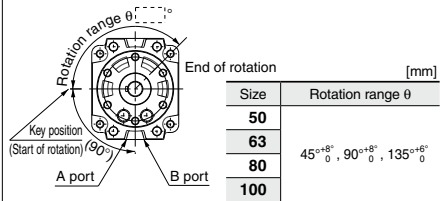

Start of rotation is the position of the key when B port is pressurized.  
(Top view from long shaft side)

## Symbol: C26

Change of rotating angle. (Applicable to single vane type only)  
Start of rotation is 45° up from the bottom of the vertical line to the right side.

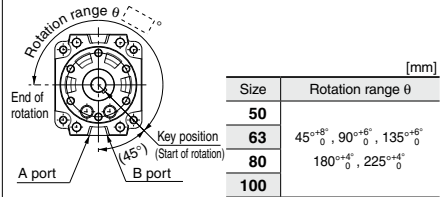

Start of rotation is the position of the key when A port is pressurized.  
(Top view from long shaft side)

## Symbol: C30

Change the standard grease to fluorine grease.  
(Not for low-speed specification.)

# CRB1 Series Auto Switch Mounting

## Auto Switch Unit and Switch Block Unit

### Unit Part Number

Size	For D-M9□		For D-S/T79□, D-R73/80□		
	Auto switch unit part number*1	Switch block unit part number Common to right-hand and left-hand	Auto switch unit part number*1	Switch block unit part number*2	
				For right-hand	For left-hand
<b>50</b>	P411020-1M	P811010-8M	P411020-1	P411020-8	P411020-9
<b>63</b>	P411030-1M		P411030-1	P411040-8	P411040-9
<b>80</b>	P411040-1M		P411040-1		
<b>100</b>	P411050-1M		P411050-1		

\*1 An auto switch will not be included, please order it separately.

\*2 Auto switch unit comes with one right-hand and one left-hand switch blocks that are used for addition or when the switch block is damaged.

## Operating Range and Hysteresis

### \* Operating range: $\theta m$

The range between the position where the auto switch turns ON as the magnet inside the auto switch unit moves and the position where the auto switch turns OFF as the magnet travels the same direction.

### \* Hysteresis range: $\theta d$

The range between the position where the auto switch turns ON as the magnet inside the auto switch unit moves and the position where the auto switch turns OFF as the magnet travels the opposite direction.

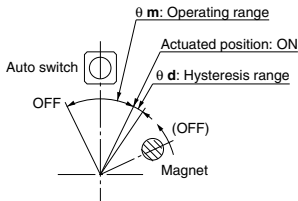

### D-M9□

Size	$\theta m$ : Operating range	$\theta d$ : Hysteresis range
<b>50</b>	86°	10°
<b>63, 80, 100</b>	70°	10°

### D-S/T79□, D-R73/80□

Size	$\theta m$ : Operating range	$\theta d$ : Hysteresis range
<b>50</b>	52°	8°
<b>63, 80, 100</b>	38°	7°

Note) Since the figures in the above table are provided as a guideline only, they cannot be guaranteed. Adjust the auto switch after confirming the operating conditions in the actual setting.

## How to Change the Auto Switch Detecting Position

\* When setting the detecting position, loosen the cross recessed round head screw a bit and move the auto switch to the preferred position and then tighten again and fix it. At this time, if tightened too much, screw can become damaged and unable to fix position. Proper tightening torque: 0.4 to 0.6 [N·m] When tightening the cross recessed round head screw, take care that the auto switch does not tilt.

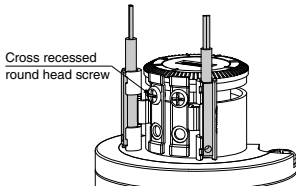

D-M9□  
Size: 50 to 100

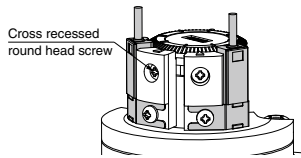

D-S/T79□  
D-R73/R80□  
Size: 50 to 100

CRB□2

CRB1

MSU

CRJ

CRA1

CRQ2

MSQ

MSZ

CRQ2X

MSQX

MRQ

D-□

# CRB1 Series

## Auto Switch Mounting

### External view and descriptions of auto switch unit

The following shows the external view and typical descriptions of the auto switch unit.

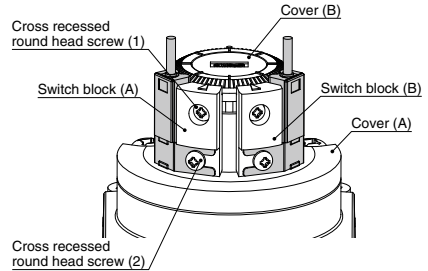
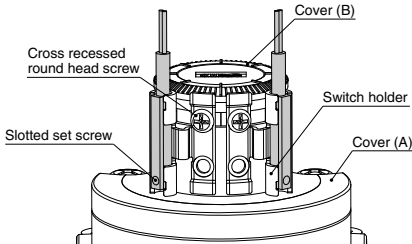

### Mounting Procedure

#### <Applicable auto switch>

Solid state auto switch

D-M9□

#### 1. Auto switch mounting

Insert the auto switch into the groove of the switch holder.

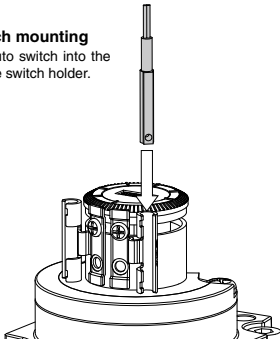

#### 2. Auto switch securing

Align the auto switch with the lower surface of the groove on the side of the switch holder, and secure the slotted set screw. (Refer to the enlarged view.)

\* Proper tightening torque: 0.05 to 0.1 [N·m]

Align with the groove lower surface to secure.

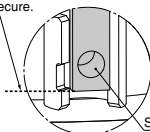

Enlarged view

#### 3. Switch holder securing

After the actuated position has been adjusted with the cross recessed round head screw, use the auto switch.

\* When tightening the screw, take care that the auto switch does not tilt.

### Mounting Procedure

#### <Applicable auto switch>

Solid state auto switch

D-S79, S7P

D-T79, T79C

Reed auto switch

D-R73/R73C (With indicator light)

D-R80/R80C (Without indicator light)

#### 1. Auto switch mounting

Loosen the cross recessed round head screw (2), and insert the arm of the auto switch.

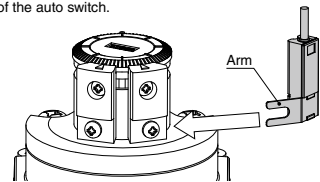

#### 2. Auto switch securing

Set the auto switch so that it is in contact with the switch block, and tighten the cross recessed round head screw (2).

\* Proper tightening torque: 0.4 to 0.6 [N·m]

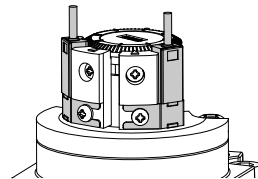

#### 3. Switch holder securing

After the actuated position has been adjusted with the cross recessed round head screw (1), use the auto switch.

\* Proper tightening torque: 0.4 to 0.6 [N·m]

## Auto Switch Adjustment

### Rotation range of the output shaft key (keyway) and auto switch mounting position

<Applicable models / Size: 50, 63, 80, 100>

#### <Single vane>

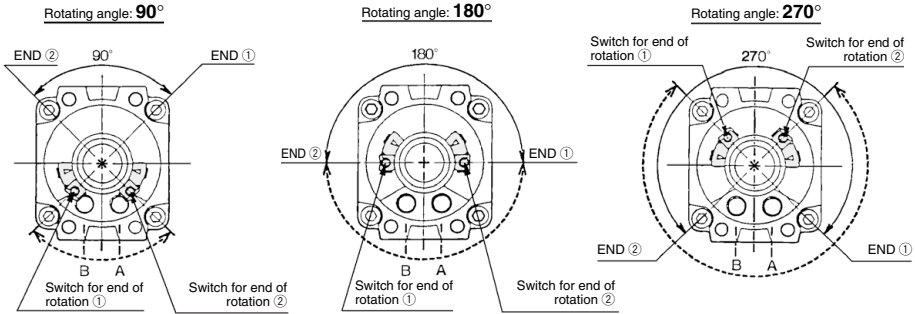

- \* Solid-lined curves indicate the rotation range of the output key (keyway). When the key is pointing to end of rotation ① the switch for end of rotation ① will operate, and when the key is pointing to end of rotation ②, the switch for end of rotation ② will operate.
- \* Broken-lined curves indicate the rotation range of the built-in magnet. Rotation range of the switch can be decreased by either moving the switch for end of rotation ② clockwise or moving the switch for end of rotation ② counterclockwise. Auto switch in the figures above is at the most sensitive position.
- \* Each auto switch unit comes with one right-hand and one left-hand switch.
- \* The magnet position can be checked with a convenient ► indication by removing a rubber cap when adjusting the auto switch position.
- \* For standard products, a magnet is mounted on the opposite side of the output shaft key.
- \* Since four chamfers are machined into the axis of rotation, a magnet position can be readjusted at 90° intervals.

#### <Double vane>

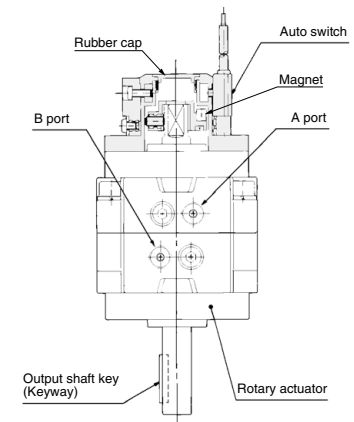
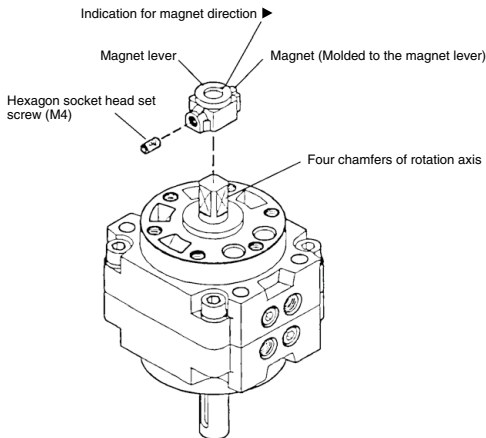
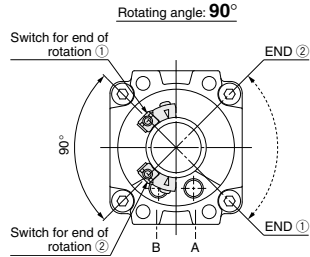

CRB□2

CRB1

MSU

CRJ

CRA1

CRQ2

MSQ

MSZ

CRQ2X

MSQX

MRQ

D-□