

Made to Order Common Specifications



1	-XB5	Oversized rod cylinder	P.1728
2	-XB6	Heat resistant cylinder (-10 to 150°C)	P.1729
3	-XB7	Cold resistant cylinder (-40 to 70°C)	P.1731
4	-XB9	Low speed cylinder (10 to 50 mm/s)	P.1732
5	-XB10	Intermediate stroke (Using exclusive body)	P.1733
6	-XB10A	Intermediate stroke (Spacer-installed type)	P.1738
7	-XB11	Long stroke type	P.1739
8	-XB12	External stainless steel cylinder	P.1742
9	-XB13	Low speed cylinder (5 to 50 mm/s)	P.1743
10	-XB14	Cylinder with heat resistant auto switch	P.1744
11	-XB19	High speed type	P.1747
12	-XB20	Stroke adjustment unit with adjustment bolt	P.1748
13	-XB22	Shock absorber soft type RJ series type	P.1752
14	-XC2(A)	Rod end length extended 10 mm	P.1755
15	-XC3	Special port location	P.1756
16	-XC4	With heavy duty scraper	P.1760
17	-XC5	Heat resistant cylinder (-10 to 110°C)	P.1765
18	-XC6	Made of stainless steel	P.1766
19	-XC7	Tie-rod, cushion valve, tie-rod nut, etc. made of stainless steel	P.1769
20	-XC8	Adjustable stroke cylinder/Adjustable extension type	P.1770
21	-XC9	Adjustable stroke cylinder/Adjustable retraction type	P.1776
22	-XC10	Dual stroke cylinder/Double rod type	P.1781
23	-XC11	Dual stroke cylinder/Single rod type	P.1786
24	-XC12	Tandem cylinder	P.1794
25	-XC13	Auto switch rail mounting type	P.1796
26	-XC17	Pin cylinder with rod quenched	P.1801
27	-XC19	Intermediate stroke (Spacer type)	P.1802
28	-XC20	Head cover axial port	P.1803
29	-XC22	Fluororubber seals	P.1804
30	-XC24	With magnetic shielding plate	P.1806
31	-XC25	No fixed throttle of connection port	P.1806
32	-XC26	With split pins for double clevis pin/double knuckle joint pin and flat washers	P.1807
33	-XC26□	Double clevis width/Double knuckle width 12.5 mm, 16.5 mm, 19.5 mm: With double clevis, double knuckle joint	P.1809
34	-XC27	Double clevis and double knuckle joint pins made of stainless steel	P.1817
35	-XC28	Compact flange made of SS400	P.1818
36	-XC29	Double knuckle joint with spring pin	P.1819
37	-XC30	Rod side trunnion	P.1820
38	-XC34	Non-rotating plate with workpiece mounting screw (No extended part on the rod end)	P.1822
39	-XC35	With coil scraper	P.1823
40	-XC36	With boss in rod side	P.1829
41	-XC37	Larger throttle diameter of connection port	P.1829
42	-XC38	Vacuum (Rod through-hole)	P.1830
43	-XC42	Built-in shock absorber in head cover side	P.1831
44	-XC51	With hose nipple	P.1832
45	-XC52	Mounting nut with set screw	P.1832
46	-XC56	With knock pin holes	P.1833
47	-XC57	Rodless cylinder with floating joint	P.1836
48	-XC65	Made of Stainless Steel (Combination of XC7 and XC68)	P.1838
49	-XC67	Dust seal band NBR lining specifications	P.1839
50	-XC68	Made of stainless steel (with hard chrome plated piston rod)	P.1839
51	-XC69	MGP series with shock absorber	P.1841
52	-XC71	Helical insert thread specifications	P.1844
53	-XC72	Without built-in auto switch magnet	P.1844
54	-XC73	Built-in cylinder with lock (CDNG)	P.1845
55	-XC74	With front plate for MGG cylinder	P.1848
56	-XC78	Auto switch mounting special dimensions at stroke end	P.1849
57	-XC82	Bottom mounting type	P.1850

Made to Order Common Specifications

58	-XC83	Built-in cylinder with lock (MDNB).....	P.1851
59	-XC85	Grease for food processing equipment.....	P.1854
60	-XC86	With rod end bracket.....	P.1855
61	-XC87	Cylinder with one-way lock/heavy duty specifications.....	P.1856
62	-XC88	Spatter resistant coil scraper, Lube-retainer, Grease for welding (Piston rod: Stainless steel 304) ...	P.1857
63	-XC89	Spatter resistant coil scraper, Lube-retainer, Grease for welding (Piston rod: S45C).....	P.1857
64	-XC91	Spatter resistant coil scraper, Grease for welding (Piston rod: S45C).....	P.1857
65	-XC92	Dust resistant actuator.....	P.1893
66	-XC93	With greater water resistance + stable lubrication function (Lube-retainer).....	P.1896

How to Order When Combining Made-to-Order Specifications

How to order when combining two specifications: simple specials (XA□) and made-to-order common specifications (XB□, XC□).

■ How to Order Example: 1 (Enter the symbol in alphabetical order.)

CQ2B25 - 30D - XA7B6

Note) "X" of XB6 is not necessary.

● Made to Order

Symbol	Specifications
XA7	Change of rod end shape
XB6	Heat resistant cylinder

■ How to Order Example: 2 (Enter the symbol in numerical order when alphabetical letters are the same.)

CDQ2B25 - 30DZ - M9BW - XC4C6

Note) "X" of XC6 is not necessary.

● Made to Order

Symbol	Specifications
XC4	With heavy duty scraper
XC6	Made of stainless steel

* Please contact SMC for the availability of a desired combination of simple specials and made-to-order specifications or a combination of three or more made-to-order specifications.

Made to Order Common Specifications: -XB5: Oversized Rod Cylinder



1 Oversized Rod Cylinder

Symbol
-XB5

A cylinder that has been made stronger through the use of a piston rod with a larger diameter. It is used for long stroke applications that pose the risk of bending or buckling of the piston rod.
(Please contact SMC if a lateral load must be applied to it.)

How to Order

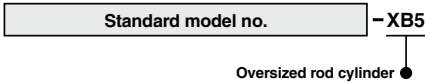

Applicable Series

Series	Description	Model	Action	Vol. no. (for std model)
MB	Air cylinder	MB	Double acting, Single rod	②-1 From P. 392
MB1	Air cylinder	MB1	Double acting, Single rod	②-1 From P. 440
CA2	Air cylinder	CA2	Double acting, Single rod	②-1 From P. 470
CS1	Air cylinder	CS1	Double acting, Single rod	②-1 From P. 530

Dimensions (Dimensions other than below are the same as standard type.)

MB, MB1 series

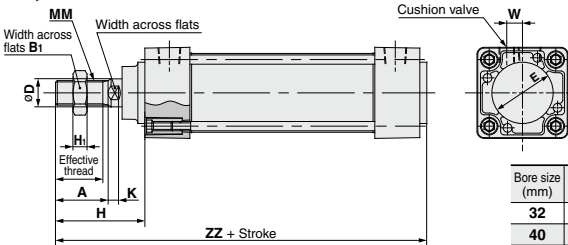

Bore size (mm)	A	Effective thread length	B1	øD	H	H1	K	Width across flats	MM	W	ZZ
32	30	27	22	16	51	8	6	14	M14 x 1.5	7.2	139
40	35	32	27	20	58	11	7	18	M18 x 1.5	9.7	146
50	40	37	32	25	68	13	10	22	M22 x 1.5	10.5	166
63	40	37	32	25	68	13	10	22	M22 x 1.5	12	166
80	40	37	41	30	74	16	10	26	M26 x 1.5	14	192
100	50	47	46	36	90	18	16	31	M30 x 1.5	15	208

CA2 series

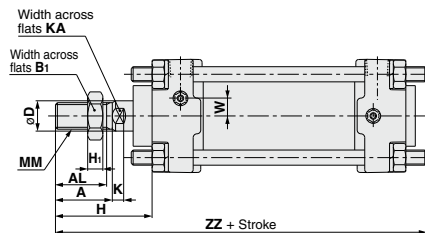

Bore size (mm)	A	AL	B1	øD	H	H1	K	KA	MM	W	ZZ
40	35	32	27	20	58	11	7	18	M18 x 1.5	9	153
50	40	37	32	25	71	13	11	22	M22 x 1.5	9	172
63	40	37	32	25	71	13	11	22	M22 x 1.5	9	183
80	40	37	41	30	72	16	11	26	M26 x 1.5	0	205
100	50	47	46	36	85	18	15	31	M30 x 1.5	0	228

CS1 series

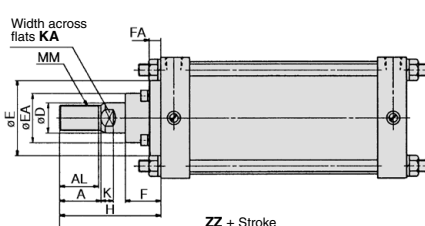

Bore size (mm)	A	AL	D	E	EA	F	FA	H	K	KA	MM	ZZ
125	63	60	50	115	74	48	17	135	20	46	M45 x 1.5	260
140	71	67	60	140	86	60	20	160	25	56	M56 x 2.0	285
160	71	67	60	140	86	60	20	160	25	56	M56 x 2.0	296.5
180	80	76	70	140	96	60	20	175	30	65	M64 x 2.0	325
200	80	76	70	140	96	60	20	175	30	65	M64 x 2.0	325

Made to Order Common Specifications: -XB6: Heat Resistant Cylinder (-10 to 150°C)



2 Heat Resistant Cylinder (-10 to 150°C)

Symbol
-XB6

Air cylinder which changed the seal material and grease, so that it could be used even at higher temperature up to 150 from -10°C.

Applicable Series

Series	Description	Model	Action	Note	Vol. no. (for std model)
CJP2	Pin cylinder	CJP2	Double acting, Single rod	Except clevis, trunnion type, with auto switch, ø4. Packing set ⁽⁶⁾	②-1 From P. 23
CJ2	Air cylinder	CJ2-Z	Double acting, Single rod	Except with air cushion and auto switch, rod end bracket T, U	②-1 From P. 46
		CJ2W-Z	Double acting, Double rod	Except with air cushion and auto switch, rod end bracket T, U	
CM2	Air cylinder	CM2-Z	Double acting, Single rod	Except with rod boot and with auto switch	②-1 From P. 172
		CM2W-Z	Double acting, Double rod	Except with rod boot and with auto switch	
	Non-rotating rod type	CM2K-Z	Double acting, Single rod	Except with rod boot and with auto switch	
		CM2KW-Z	Double acting, Double rod	Except with auto switch	
	Direct mount type	CM2R-Z	Double acting, Single rod	Except with auto switch	
	Non-rotating rod, Direct mount type	CM2RK-Z	Double acting, Single rod	Except with auto switch	
End lock cylinder	CBM2	Double acting, Single rod	Except with rod boot and with auto switch		
CG1	Air cylinder	CG1-Z	Double acting, Single rod	Except with auto switch. Without a bumper for cylinders with rubber bumper	②-1 From P. 292
		CG1W-Z	Double acting, Double rod	Except with auto switch. Without a bumper for cylinders with rubber bumper	
	Direct mount type	CG1R-Z	Double acting, Single rod	Except with auto switch. Without a bumper for cylinders with rubber bumper	
MB	Air cylinder	MB-Z	Double acting, Single rod	Except without air cushion and with auto switch	②-1 From P. 392
		MBW-Z	Double acting, Double rod	Except without air cushion and with auto switch	
MB1	Air cylinder	MB1-Z	Double acting, Single rod	Except without air cushion and with auto switch	②-1 From P. 440
		MB1W-Z	Double acting, Double rod	Except without air cushion and with auto switch	
CA2	Air cylinder	CA2-Z	Double acting, Single rod	Except with auto switch	②-1 From P. 470
		CA2W-Z	Double acting, Double rod	Except with auto switch	
	End lock cylinder	CBA2	Double acting, Single rod	Except with auto switch	
CS1	Air cylinder	CS1□	Double acting, Single rod	Except with auto switch. Applicable bore size (ø125 to ø200)	②-1 From P. 530
		CS1W□	Double acting, Double rod		
CS2	Air cylinder	CS2	Double acting, Single rod	Except with auto switch	②-1 From P. 568
		CS2W	Double acting, Double rod	Except with auto switch	
CUJ	Mini free mount cylinder	CUJ	Double acting, Single rod	Except with auto switch and ø4	②-1 From P. 596
	Free mount cylinder	CU	Double acting, Single rod	Except with auto switch	
CU	Non-rotating rod type	CUK	Double acting, Single rod	Except with auto switch	②-1 From P. 623
	Long stroke	CU	Double acting, Single rod	Except with auto switch	
	Long stroke, Non-rotating rod	CUK	Double acting, Single rod	Except with auto switch	
		CUK	Double acting, Single rod	Except with auto switch	
CQS	Compact cylinder	CQS	Double acting, Single rod	Except with rubber bumper and auto switch	②-1 From P. 693
		CQSW	Double acting, Double rod	Except with rubber bumper and auto switch	
		CQ2-Z	Double acting, Single rod	Except with rubber bumper and auto switch	
CQ2	Compact cylinder	CQ2-Z	Double acting, Single rod	Except with rubber bumper and auto switch	②-1 From P. 773
		CQ2W-Z	Double acting, Double rod	Except with rubber bumper and auto switch	
	Axial piping type (Centralized piping type)	CQP2	Double acting, Single rod	Except with rubber bumper and auto switch	
		CQ2K-Z	Double acting, Single rod	Except with rubber bumper and auto switch	
		CQ2KW-Z	Double acting, Double rod	Except with rubber bumper and auto switch	
CG5	Stainless cylinder	CG5	Double acting, Single rod	Except with auto switch. Without a bumper for cylinders with a rubber bumper (Grease for non-food is used.)	②-1 From P. 1070
CY3	Magnetically coupled rodless cylinder	CY3B	Basic type	Except with auto switch. Without a bumper	②-1 From P. 1468
MK	Rotary clamp	MK-Z	Double acting	Except with auto switch, ø12 and ø16	②-3 From P. 389
MGP	Compact guide cylinder	MGPM-Z	Double acting	Except with auto switch. No rubber bumper is equipped.	②-2 From P. 432
MGQ	Compact guide cylinder	MGQ	Double acting	Except with auto switch, ø12 to ø25 of MGQL (Ball bushing type)	②-2 From P. 520
MGG	Guide cylinder	MGG	Double acting	Except with auto switch. No shock absorber and rubber bumper are equipped.	②-2 From P. 538
MGC	Guide cylinder	MGC	Double acting	Except with auto switch	②-2 From P. 578
CXSJ	Dual rod cylinder	CXSJ	Compact type	Except with auto switch	②-2 From P. 737
CXS		CXS	Basic type	Except with auto switch	②-2 From P. 749

How to Order

Standard model no.	-XB6
Heat resistant cylinder	

Specifications

Ambient temperature range	-10 to 150°C (0 to 150°C for CS1, CS2 series)
Seals materials	Fluororubber
Grease	Heat resistant grease
Specifications other than above and external dimensions	Same as standard type

Warning Precautions

Be aware that smoking cigarettes, etc. after your hands have come into contact with the grease used in this cylinder can create a gas that is hazardous to humans.

- Note 1) Operate without lubrication from a pneumatic system lubricator.
- Note 2) Please contact SMC for details on the maintenance intervals for this cylinder, which differ from those of the standard cylinder.
- Note 3) In principle, it is impossible to make built-in magnet type and the one with auto switch. But, as for the one with auto switch, and the heat resistant cylinder with heat resistant auto switch, since it will be differed depending on the series, please contact SMC.
- Note 4) Piston speed is ranged from 50 to 500 mm/s. But, for MGQ□80, 100 and MGP□80, 100, it will be 50 to 400 mm/s, 50 to 200 mm/s for the MK series. The piston speed for the CY3B series is 50 to 400 mm/s.
- Note 5) Please contact SMC for the CQ2, CQS, MGP and MGQ series with rubber bumper.
- Note 6) As for the ambient temperature range of the CY3B series, since the magnetic holding force will be varied depending on the operating conditions, make sure that by referring to the next page.
- Note 7) The ambient temperature range of the CY3B series is 50 to 150°C.
- Note 8) Refer to the construction of the standard type for the details of the packing set for CJP2□6,10 and 16.



Made to Order Common Specifications: -XB6: Heat Resistant Cylinder (-10 to 150°C)



2 Heat Resistant Cylinder (-10 to 150°C)

Symbol
-XB6

CY3B series How to Order

CY3B - -XB6

Heat resistant cylinder

Specifications

Applicable size	CY3B
Bore size (mm)	ø6 to ø63
Ambient and fluid temperature	50 to 150°C*
Maximum operating pressure	0.5 MPa
Piston speed	50 to 400 mm/s*

* When using in less than 100°C range, since it could make a difference in the maintenance cycle, depending on the operating speed, use it at 200 mm/s or less.

Operating Pressure Limit for Intermediate Stop and Vertical Operation

Maximum operating pressure at the intermediate stop	0.4 MPa*
---	----------

* Use caution that the magnet coupling will be removed, if it is used to stop in an intermediate stroke by an external stopper with the operating pressure over 0.4 MPa.

Magnetic Holding Force (N)

Bore size (mm)	6	10	15	20	25	32	40	50	63
Holding force (at 150°C)	14.4	40.0	90.1	160	250	410	641	1000	1590
Holding force (at 100°C)	17.2	47.9	107	192	299	490	766	1190	1900

MGC series

How to Order

MGC -XB6

Heat resistant cylinder

Dimensions (Dimensions other than below are the same as standard type.)

MGCLB series

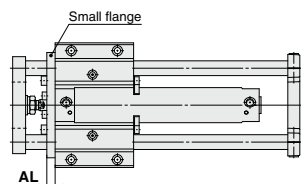

Bore size (mm)		(mm)
Bore size (mm)	AL	
20	9	
25	9	
32	9	
40	12	
50	12	

Temperature Range for Operating Cylinder and Piston Speed

- When using with the operating temperature from 60 up to 100°C, and the piston speed of more than 200 mm/s, please consult with SMC separately.
- When using with the operating temperature from 50 up to 100°C, and the piston speed of less than 200 mm/s, XB6 specifications can be used.
- As for XB6, regarding the temperature range (over 50 to 60°C) which overlaps the one of standard products, consider the tendency of operating temperature (upper, lower limits), then choose a model.

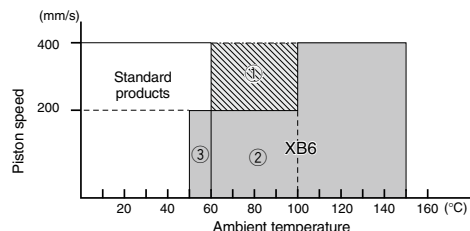

When using with the operating temperature fluctuated between 50°C or less and 100°C or more, the operating speed, etc. will be largely restricted by the durability. Prior to use, please contact SMC.

<Reference>

Maintenance cycle for XB6 could vary substantially, depending on the operating condition and the ambient temperature. Even if using in our recommended range, as a guide, conduct it in around 1/2 intervals, compared to the standard products.

Dimensions (Dimensions other than below are the same as standard type.)

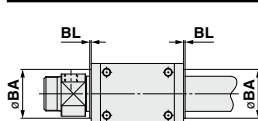

(mm)		
Bore size (mm)	BA	BL
6	—	—
10	—	—
15	—	—
20	—	—
25	37	0.3
32	—	—
40	—	—
50	68.5	0.6
63	—	—

MGP series

How to Order

MGPM -XB6

Heat resistant cylinder

Dimensions

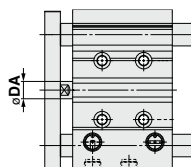

Bore size (mm)		(mm)
Bore size (mm)	DA	
12	(6)	
16	(8)	
20	(10)	
25	(10)	
32	(14)	
40	(14)	
50	20	
63	20	
80	25	
100	30	

The dimensions in () are the same as standard type.

Made to Order Common Specifications: -XB7: Cold Resistant Cylinder (-40 to 70°C)



3 Cold Resistant Cylinder (-40 to 70°C)

Symbol
-XB7

Air cylinder which changed the seal material and grease, so that it could be used even at lower temperature down to -40°C.

Applicable Series

Series	Description	Model	Action	Note	Vol. no. (for std model)
CJP2	Pin cylinder	CJP2	Double acting, Single rod	Except clevis, trunnion type, with auto switch, ø4. Packing set (7)	②-1 From P. 23
CJ2	Air cylinder	CJ2-Z	Double acting, Single rod	Except with air cushion and auto switch, rod end bracket, pivot bracket	②-1 From P. 46
		CJ2W-Z	Double acting, Double rod	Except with air cushion and auto switch, rod end bracket, pivot bracket	
CM2	Air cylinder	CM2-Z	Double acting, Single rod	Except with rod boot, with air cushion, with auto switch	②-1 From P. 172
		CM2W-Z	Double acting, Double rod	Except with rod boot, with air cushion, with auto switch	
	Direct mount type	CM2R-Z	Double acting, Single rod	Except with air cushion, auto switch	
CG1	Air cylinder	CG1-Z	Double acting, Single rod	Except with air cushion, auto switch. Cylinders with a rubber bumper have no bumper.	②-1 From P. 292 ⁽⁶⁾
		CG1W-Z	Double acting, Double rod	Except with air cushion, auto switch. Cylinders with a rubber bumper have no bumper.	
	Direct mount type	CG1R-Z	Double acting, Single rod	Except with air cushion, auto switch. Cylinders with a rubber bumper have no bumper.	
CU	Free mount cylinder	CU	Double acting, Single rod	Except with auto switch	②-1 From P. 623
	Non-rotating rod type	CUK	Double acting, Single rod	Except with auto switch	
	Long stroke	CU	Double acting, Single rod	Except with auto switch	
	Long stroke, Non-rotating rod	CUK	Double acting, Single rod	Except with auto switch	
CQS	Compact cylinder	CQS	Double acting, Single rod	Except with auto switch, with rubber bumper, with bracket	②-1 From P. 693
		CQSW	Double acting, Double rod	Except with auto switch, with rubber bumper, with bracket	
CQ2	Compact cylinder	CQ2-Z	Double acting, Single rod	ø12 to ø40. Except with auto switch, with rubber bumper, with bracket	②-1 From P. 773
		CQ2W-Z	Double acting, Double rod	ø12 to ø40. Except with auto switch, with rubber bumper, with bracket	
	Axial piping type (Centralized piping type)	CQP2	Double acting, Single rod	ø12 to ø40. Except with auto switch, with rubber bumper, with bracket	

How to Order

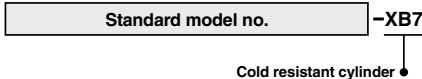

Specifications

Ambient temperature range	-40 to 70°C
Seals material	Low nitrile rubber
Grease	Cold resistant grease
Auto switch	Not mountable
Dimensions	Same as standard type
Additional specifications	Same as standard type

⚠ Warning Precautions

Be aware that smoking cigarettes, etc. after your hands have come into contact with the grease used in this cylinder can create a gas that is hazardous to humans.

- Note 1) Operate without lubrication from a pneumatic system lubricator.
 Note 2) Use dry air which is suitable for heatless air dryer, etc. not to cause the moisture to be frozen.
 Note 3) Please contact SMC for details on the maintenance intervals for this cylinder, which differ from those of the standard cylinder.
 Note 4) Mounting auto switch is impossible.
 Note 5) Please contact SMC for the one with rubber bumper for CQ2, CQS.
 Note 6) No cushion type is adopted.
 Piston speed is ranged from 50 to 500 mm/s.
 Note 7) Refer to the construction of the standard type for the details of the packing set for CJP2□6,10 and 16.

Made to Order Common Specifications: -XB9: Low Speed Cylinder (10 to 50 mm/s)



4 Low Speed Cylinder (10 to 50 mm/s)

Symbol

-XB9

Even if driving at lower speeds 10 to 50 mm/s, there would be no stick-slip phenomenon and it can run smoothly.

Applicable Series

Series	Description	Model	Action	Note	Vol. no. (for std model)
CJ2	Air cylinder	CJ2-Z	Double acting, Single rod	Except with air cushion	②-1 From P. 46
	Air cylinder	CM2-Z	Double acting, Single rod	Except air-hydro, with air cushion, with rod boot	
CM2	Direct mount type	CM2R-Z	Double acting, Single rod	Except with air cushion	②-1 From P. 172
	End lock cylinder	CBM2	Double acting, Single rod	Except with rod boot, with air cushion	
CG1	Air cylinder	CG1-Z	Double acting, Single rod	Except with rod boot, with air cushion	②-1 From P. 292
	Direct mount type	CG1R-Z	Double acting, Single rod	Except with air cushion	
CU	Free mount cylinder	CU	Double acting, Single rod		②-1 From P. 623
	Non-rotating rod type	CUK	Double acting, Single rod		
	Long stroke standard type	CU	Double acting, Single rod		
	Long stroke, Non-rotating rod type	CUK	Double acting, Single rod		
CQS	Compact cylinder	CQS	Double acting, Single rod		②-1 From P. 693
		CQSW	Double acting, Double rod		
CQ2	Compact cylinder	CQ2-Z	Double acting, Single rod		②-1 From P. 773
		CQ2W-Z	Double acting, Double rod		
	Axial piping type (Centralized piping type)	CQP2	Double acting, Single rod		
CY	Magnetically coupled rodless cylinder	CY3B	Double acting		②-1 From P. 1468
		CY1S-Z	Double acting		
		CY1L	Double acting		
MGQ	Compact guide cylinder	MGQ	Double acting		②-2 From P. 520

How to Order

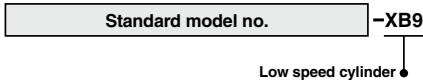

Note) Operate without lubrication from a pneumatic system lubricator.

Specifications

Piston speed	10 to 50 mm/s (CY is ranged between 15 to 50 mm/s.)
Dimensions	Same as standard type
Additional specifications	Same as standard type

⚠ Warning Precautions

Be aware that smoking cigarettes, etc. after your hands have come into contact with the grease used in this cylinder can create a gas that is hazardous to humans.

Made to Order Common Specifications: -XB10: Intermediate Stroke (Using exclusive body)



5 Intermediate Stroke (Using exclusive body) Symbol **-XB10**

Cylinder which can reduce the mounting space by using an exclusive body which does not use a spacer to achieve that the full length dimension could be shortened when an intermediate stroke other than the standard stroke is required.

Applicable Series

Series	Description	Model	Action	Note	Vol. no. (for std model)
CQS	Compact cylinder	CQS	Double acting, Single rod	Long stroke is available, too.	②-1 From P. 693
		CQSW	Single acting (Spring return) Double acting, Double rod		
CQ2	Compact cylinder	CQ2-Z	Double acting, Single rod	Except ø12 to 32	②-1 From P. 773
		CQ2W-Z	Single acting (Spring return) Double acting, Double rod		
	Non-rotating rod type	CQ2K-Z	Double acting, Single rod		
		CQ2-Z	Double acting, Single rod		
	Large bore size	CQ2W-Z	Double acting, Double rod		
		CQ2-Z	Double acting, Single rod		
Long stroke	CQ2-Z	Double acting, Single rod			
Anti-lateral load	CQ2□S-Z	Double acting, Single rod			
MGP	Compact guide cylinder	MGP-Z	Double acting		②-2 From P. 432
MGQ	Compact guide cylinder	MGQ	Double acting		②-2 From P. 520
MY	Mechanically jointed rodless cylinder	MY1H-Z	Linear guide type	10 mm increments for ø10	②-1 From P. 1208
		MY1H	Linear guide type		②-1 From P. 1302
		MY1HT	High rigidity Linear guide type		②-1 From P. 1324
		MY2H/HT	Linear guide type		②-1 From P. 1388
CY1	Magnetically coupled rodless cylinder	CY1H CY1F	Linear guide type		②-1 From P. 1528
REA	Sine rodless cylinder	REAH	Linear guide type		②-3 From P. 75
REB		REBH			②-3 From P. 104

How to Order

Standard model no. **-XB10**

Specifications: Same as standard type

Intermediate stroke

Dimensions: CQ2 Series

Double acting, Single rod

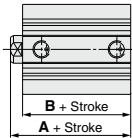

Double acting, Double rod

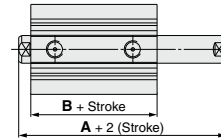

Bore size (mm)	Single rod type				Applicable stroke range (mm)
	A		B		
12	49 stroke or less	51 to 99 stroke	49 stroke or less	51 to 99 stroke	6 to 29
16	20.5 (31.5)	—	17 (28)	—	
20	22 (34)	—	18.5 (30.5)	—	6 to 49
25	24 (36)	—	19.5 (31.5)	—	
32	27.5 (37.5)	—	22.5 (32.5)	—	6 to 99
40	30 (40)	40 (40)	23 (33)	33 (33)	
50	36.5 (46.5)	46.5 (46.5)	29.5 (39.5)	39.5 (39.5)	11 to 99
63	38.5 (48.5)	48.5 (48.5)	30.5 (40.5)	40.5 (40.5)	
80	44 (54)	54 (54)	36 (46)	46 (46)	11 to 99
100	53.5 (63.5)	63.5 (63.5)	43.5 (53.5)	53.5 (53.5)	

Bore size (mm)	Single rod type (Single acting/Return)		Applicable stroke range (mm)
	A	B	
12	20.5 (31.5)	17 (28)	6 to 9
16	22 (34)	18.5 (30.5)	
20	24 (36)	19.5 (31.5)	6 to 9
25	27.5 (37.5)	22.5 (32.5)	
32	30 (40)	23 (33)	6 to 9
40	36.5 (46.5)	29.5 (39.5)	
50	38.5 (48.5)	30.5 (40.5)	11 to 19

Bore size (mm)	Double rod type				Applicable stroke range (mm)
	A		B		
12	49 stroke or less	51 to 99 stroke	49 stroke or less	51 to 99 stroke	6 to 29
16	32.2 (39.4)	—	25.2 (32.4)	—	
20	33 (43)	—	26 (36)	—	6 to 49
25	35 (47)	—	26 (38)	—	
32	39 (49)	—	29 (39)	—	6 to 99
40	44.5 (54.5)	54.5 (54.5)	30.5 (40.5)	40.5 (40.5)	
50	54 (64)	64 (64)	40 (50)	50 (50)	11 to 99
63	56.5 (66.5)	66.5 (66.5)	40.5 (50.5)	50.5 (50.5)	
80	58 (68)	68 (68)	42 (52)	52 (52)	11 to 99
100	71 (81)	81 (81)	51 (61)	61 (61)	

* (): Denotes the dimensions of auto switch type.
* Other dimensions are the same as standard type.
Note) Applicable stroke available in 1 mm increments.



Made to Order Common Specifications: -XB10: Intermediate Stroke (Using exclusive body)



5 Intermediate Stroke (Using exclusive body)

Dimensions: CQ2 Series

Double acting, Single rod/Long stroke

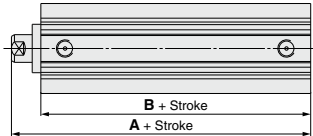

Double acting, Single rod/Large bore

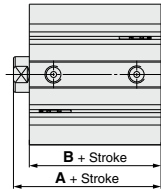

Double acting, Double rod/Large bore

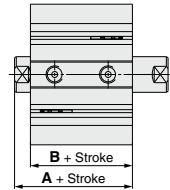

Bore size (mm)	Single rod type (Long stroke)		Applicable stroke range(mm)
	A	B	
32	62.5	45.5	101 to 299
40	72	55	
50	73.5	55.5	
63	75	57	
80	86	66	
100	97.5	75.5	

* Dimensions of "with auto switch" and those of "without auto switch" are the same.

Bore size (mm)	Single rod type		Applicable stroke range(mm)
	A	B	
125	99	83	11 to 299
140	99	83	
160	108	91	
180	119	102	
200	126	109	

* Dimensions other than listed above are the same as standard type.
Note) Applicable stroke available in 1 mm increments.

Bore size (mm)	Double rod type		Applicable stroke range(mm)
	A	B	
125	115	83	11 to 299
140	115	83	
160	125	91	
180	136	102	
200	143	109	

* Dimensions other than listed above are the same as standard type.
Note) Applicable stroke available in 1 mm increments.

Double acting, Single rod/End lock With head side locking

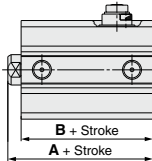

Double acting, Single rod/End lock With rod side locking

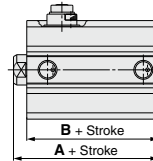

Head Side Locking

Bore size (mm)	A		B		Applicable stroke range(mm)
	24 stroke or less	26 to 99 stroke	24 stroke or less	26 to 99 stroke	
20	65.5	80.5	61	66	6 to 99
25	69	84	64	69	
32	72.5		65.5		
40	82		75		
50	83.5		75.5		
63	85		77		

Bore size (mm)	A		B		Applicable stroke range(mm)
	49 stroke or less	51 to 99 stroke	49 stroke or less	51 to 99 stroke	
80	121	136	111	116	6 to 99
100	132.5	147.5	120.5	125.5	

Rod Side Locking

Bore size (mm)	A		B		Applicable stroke range(mm)
	24 stroke or less	26 to 99 stroke	24 stroke or less	26 to 99 stroke	
20	59	80.5	54.5	66	6 to 99
25	62.5	84	57.5	69	
32	65		58		
40	71.5		64.5		
50	73.5		65.5		
63	79		71		

Bore size (mm)	A		B		Applicable stroke range(mm)
	49 stroke or less	51 to 99 stroke	49 stroke or less	51 to 99 stroke	
80	113.5	136	103.5	116	6 to 99
100	125	147.5	113	125.5	

Dimensions: CQS Series

**Double acting,
Single rod/Long stroke**

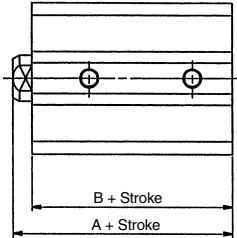

Double acting, Double rod

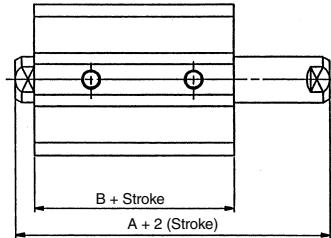

(mm)

Bore size (mm)	Single rod type		Applicable stroke
	A	B	
12	20.5 (25.5)	17 (22)	6 to 29
16	20.5 (25.5)	17 (22)	
20	24 (34)	19.5 (29.5)	6 to 49
25	27.5 (37.5)	22.5 (32.5)	

(mm)

Bore size (mm)	Double rod type		Applicable stroke
	A	B	
12	29 (34)	22 (27)	6 to 29
16	29 (34)	22 (27)	
20	35 (45)	26 (36)	6 to 49
25	39 (49)	29 (39)	

(mm)

Bore size (mm)	Single rod type (Long stroke)		Applicable stroke
	A	B	
12	45.5	32	31 to 99
16	45.5	32	
20	55.5	41	51 to 199
25	59	44	51 to 299

(mm)

Bore size (mm)	Single rod type (Single acting/Return)		Applicable stroke
	A	B	
12	20.5 (25.5)	17 (22)	6 to 9
16	20.5 (25.5)	17 (22)	
20	24 (34)	19.5 (29.5)	6 to 9
25	27.5 (37.5)	22.5 (32.5)	

* (): Denotes the dimensions with auto switch.

- * (): Denotes the dimensions with auto switch.
- * In the case of long stroke, dimensions of "with auto switch" and those of "without auto switch" are the same.
- * Dimensions other than listed at left are the same as standard type.
- Note) Applicable stroke available in 1 mm increments.



Made to Order Common Specifications: -XB10: Intermediate Stroke (Using exclusive body)



5 Intermediate Stroke (Using exclusive body)

Dimensions: MGP Series

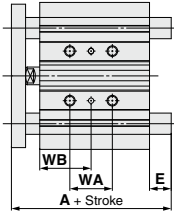

Stroke Range

Bore size (mm)	Stroke range (mm)
12, 16	11 to 249
20, 25	21 to 399
32, 40, 50, 63, 80, 100	26 to 399

* Specifications except the stroke range are the same as standard.
Note) Applicable stroke available in 1 mm increments.

MGPM-Z, MGPL-Z, MGPA-Z/WA, WB Dimensions

Bore size (mm)	Stroke range (mm)	WA				WB			
		11 to 39 st	41 to 99 st	101 to 199 st	201 to 249 st	11 to 39 st	41 to 99 st	101 to 199 st	201 to 249 st
12	11 to 249	20	40	110	200	15	25	60	105
16		24	44	110	200	17	27	60	105

Bore size (mm)	Stroke range (mm)	WA				WB					
		21 to 39 st	41 to 124 st	126 to 199 st	201 to 299 st	301 to 399 st	21 to 39 st	41 to 124 st	126 to 199 st	201 to 299 st	301 to 399 st
20	21 to 399	24	44	120	200	300	29	39	77	117	167
25		24	44	120	200	300	29	39	77	117	167

Bore size (mm)	Stroke range (mm)	WA					WB				
		26 to 49 st	51 to 124 st	126 to 199 st	201 to 299 st	301 to 399 st	26 to 49 st	51 to 124 st	126 to 199 st	201 to 299 st	301 to 399 st
32	26 to 399	24	48	124	200	300	33	45	83	121	171
40		24	48	124	200	300	34	46	84	122	172
50		24	48	124	200	300	36	48	86	124	174
63		28	52	128	200	300	38	50	88	124	174
80		28	52	128	200	300	42	54	92	128	178
100		48	72	148	220	320	35	47	85	121	171

MGPM-Z/A, E Dimensions

Bore size (mm)	A			E		
	11 to 74 st	76 to 99 st	101 to 249 st	11 to 74 st	76 to 99 st	101 to 249 st
12	42	60.5	82.5	0	18.5	40.5
16	46	64.5	92.5	0	18.5	46.5

Bore size (mm)	A			E		
	21 to 74 st	76 to 199 st	201 to 399 st	21 to 74 st	76 to 199 st	201 to 399 st
20	53	77.5	110	0	24.5	57
25	53.5	77.5	109.5	0	24	56

Bore size (mm)	A			E		
	26 to 74 st	76 to 199 st	201 to 399 st	26 to 74 st	76 to 199 st	201 to 399 st
32	75	93.5	129.5	15.5	34	70
40	75	93.5	129.5	9	27.5	63.5
50	88.5	109.5	150.5	16.5	37.5	78.5
63	88.5	109.5	150.5	11.5	32.5	73.5
80	104.5	131.5	180.5	8	35	84
100	126.5	151.5	190.5	10.5	35.5	74.5

* Dimensions except mentioned above are the same as standard type.

MGPL-Z, MGPA-Z/A, E Dimensions

Bore size (mm)	A			E		
	11 to 39 st	41 to 99 st	101 to 249 st	11 to 39 st	41 to 99 st	101 to 249 st
12	43	55	84.5	1	13	42.5
16	49	65	94.5	3	19	48.5

Bore size (mm)	A			E				
	21 to 39 st	41 to 124 st	126 to 199 st	21 to 39 st	41 to 124 st	126 to 199 st		
20	59	76	100	117.5	6	23	47	64.5
25	65.5	81.5	100.5	117.5	12	28	47	64

Bore size (mm)	A			E				
	26 to 74 st	76 to 124 st	126 to 199 st	201 to 399 st	26 to 74 st	76 to 124 st	126 to 199 st	201 to 399 st
32	79.5	96.5	116.5	138.5	20	37	57	79
40	79.5	96.5	116.5	138.5	13.5	30.5	50.5	72.5
50	91.5	112.5	132.5	159.5	19.5	40.5	60.5	87.5
63	91.5	112.5	132.5	159.5	14.5	35.5	55.5	82.5

Bore size (mm)	A			E				
	26 to 49 st	51 to 74 st	76 to 199 st	201 to 399 st	26 to 49 st	51 to 74 st	76 to 199 st	201 to 399 st
80	104.5	128.5	158.5	191.5	8	32	62	95
100	119.5	145.5	178.5	201.5	3.5	29.5	62.5	85.5

Dimensions: MGQ Series

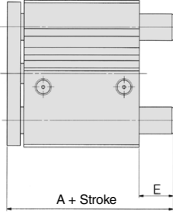

Stroke Range

Bore size (mm)	Stroke range (mm)
12, 16	11 to 99
20, 25	21 to 199
32, 40, 50, 63, 80, 100	26 to 199

* Specifications except the stroke range are the same as standard.
Note) Applicable stroke available in 1 mm increments.

MGQM (Slide bearing) A, E Dimensions

Bore size (mm)	A		E	
	11 to 99 st	11 to 99 st	11 to 99 st	11 to 99 st
12	39		0	
16	43		0	

Bore size (mm)	A		E	
	21 to 74 st	76 to 199 st	21 to 74 st	76 to 199 st
20	47	61.5	0	14.5
25	47.5	62	0	14.5

Bore size (mm)	A		E	
	26 to 199 st		26 to 199 st	
32	71.5		24	
40	71.5		17.5	
50	81		25	
63	81		20	
80	93		18.5	
100	105		21	

* Dimensions except mentioned above are the same as standard type.

MGQL (Ball bushing bearing) A, E Dimensions

Bore size (mm)	A		E	
	11 to 39 st	41 to 99 st	11 to 39 st	41 to 99 st
12	43	55	4	16
16	49	65	6	22

Bore size (mm)	A		E	
	21 to 39 st	41 to 199 st	21 to 39 st	41 to 199 st
20	57	74	10	27
25	63.5	79.5	16	32

Bore size (mm)	A		E	
	26 to 74 st	76 to 199 st	26 to 74 st	76 to 199 st
32	53	90	5.5	42.5
40	54	90	0	36
50	60	102	4	46
63	61	102	0	41
80	84	143	9.5	68.5
100	89	153	5	69

* Dimensions except mentioned above are the same as standard type.

RE_A^B series

REAH REBH **Bore size** – **Stroke** – XB10
(Refer to the table below.)
● Intermediate stroke

Strokes

Bore size	150	175	200	225	250	275	300	325	350	375	400	425	450	475	500	525	550	575	600	650	700	750	800	850	900	950	1000	
REAH10	●	○	●	○	○	○	●	/	/	/	/	/	/	/	/	/	/	/	/	/	/	/	/	/	/	/	/	
RE ₅ H15	●	○	○	○	○	○	○	○	○	○	○	○	○	○	○	○	○	○	○	○	○	○	○	○	○	○	○	○
REAH20	/	/	●	○	○	○	○	○	○	○	○	○	○	○	○	○	○	○	○	○	○	○	○	○	○	○	○	○
RE ₅ H25	/	/	●	○	○	○	○	○	○	○	○	○	○	○	○	○	○	○	○	○	○	○	○	○	○	○	○	○
RE ₅ HT25	/	/	●	○	○	○	○	○	○	○	○	○	○	○	○	○	○	○	○	○	○	○	○	○	○	○	○	○
RE ₅ HT32	/	/	●	○	○	○	○	○	○	○	○	○	○	○	○	○	○	○	○	○	○	○	○	○	○	○	○	○

●: Standard stroke
○: Strokes set for -XB10
—: No setting



Made to Order Common Specifications: -XB10A: Intermediate Stroke (Spacer-installed type)



6 Intermediate Stroke (Spacer-installed type)

Symbol
-XB10A

Intermediate stroke: Available in 1 mm increments. A spacer is installed on tubes with a stroke longer than the specified stroke (● in the below table).

Applicable Series

Series	Model	Action	Note
CQ2	Standard type	CQ2-Z	Double acting, Single rod
			ø32 to ø100

Applicable Stroke

Intermediate stroke with ○: Available in 1 mm increments.

A spacer is installed on tubes with a stroke longer than the specified stroke (●).

◆: Standard stroke ●: Stroke in stock

Bore size (mm)	Stroke range	Type	Stroke																			
			55	60	65	70	75	80	85	90	95	100	55	60	65	70	75	80	85	90	95	100
32, 40	51 to 94	Spacer-installed type 2	○	●	○	●	○	●	○	●	○	●	○	●	○	●	○	●	○	●	○	●
50 to 100	51 to 94		○	●	○	●	○	●	○	●	○	●	○	●	○	●	○	●	○	●	○	●

Note) Specify a spacer-installed type 1 with standard model number for ordering an intermediate stroke with a * mark. Refer to the CQ2 series, page 775 for details.

Specifications: Same as standard type

How to Order C□Q2 Standard model no. - XB10 A

Intermediate stroke ↓
Spacer-installed type ↓

Order no.	CQ2B32-57DZ-XB10A (uses 60 mm stroke tube)
	● CQ2B32-60DZ-XB10 with 3 mm width spacer inside
	● The B dimension is 93 mm.

Dimensions: CQ2 Series

Double acting,
Single rod

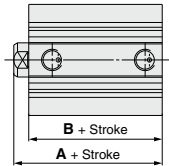

Symbol Stroke	A																B								(mm)
	51 to 54	56 to 59	61 to 64	66 to 69	76 to 79	81 to 84	86 to 89	91 to 94	51 to 54	56 to 59	61 to 64	66 to 69	76 to 79	81 to 84	86 to 89	91 to 94									
Bore size	95	100	105	110	120	125	130	135	88	93	98	103	113	118	123	128	93	98	103	108	113	118	123	128	
32	101.5	106.5	111.5	116.5	126.5	131.5	136.5	141.5	94.5	99.5	104.5	109.5	119.5	124.5	129.5	134.5	93	98	103	108	113	118	123	128	
40	103.5	108.5	113.5	118.5	128.5	133.5	138.5	143.5	95.5	100.5	105.5	110.5	120.5	125.5	130.5	135.5	93	98	103	108	113	118	123	128	
50	109	114	119	124	134	139	144	149	101	106	111	116	126	131	136	141	93	98	103	108	113	118	123	128	
63	118.5	123.5	128.5	133.5	143.5	148.5	153.5	158.5	108.5	113.5	118.5	123.5	133.5	138.5	143.5	148.5	93	98	103	108	113	118	123	128	
80	130	135	140	145	155	160	165	170	118	123	128	133	143	148	153	158	93	98	103	108	113	118	123	128	
100																	93	98	103	108	113	118	123	128	

Made to Order Common Specifications: -XB11: Long Stroke Type



7 Long Stroke Type

Symbol
-XB11

Stroke which exceeds the standard stroke length

Applicable Series

Series	Description	Model	Type	Note	Vol. no. (for std model)
MY	Mechanically jointed rodless cylinder	MY1B-Z	Basic type		②-1 From P. 1188
		MY1H-Z	Linear guide type		②-1 From P. 1208
		MY1B	Basic type		
		MY1M (W)	Slide bearing type	With cover (W) is also available.	②-1 From P. 1238
		MY1C (W)	Cam follower guide type	With cover (W) is also available.	
		MY1H	Linear guide type	Except $\phi 10$	
		MY2C	Cam follower guide type		
		MY2H/HT	Linear guide type		②-1 From P. 1380
		MY3A	Basic short type		
		MY3B	Basic standard type		②-1 From P. 1424
MY3M	Slide bearing type				
CY	Magnetically coupled rodless cylinder	CY3B	Basic type		②-1 From P. 1468
		CY1H	Linear guide type		
CX2	Slide unit	CX2	Slide bearing type		②-2 From P. 650
CXW	Slide unit	CXWM	Slide bearing type		②-2 From P. 659
		CXWL	Ball bushing bearing type		
CXSJ	Dual rod cylinder	CXSJ	Standard type		②-2 From P. 737
CXS		CXS ^(Note)	Standard type		②-2 From P. 749
		CXSW	Double rod type		
ML1	Hy-rodless cylinder	ML1C	Cam follower guide type		②-2 From P. 1108
REA	Sine rodless cylinder	REA	Basic type		②-3 From P. 25

Note) The product with air cushion or with end lock for retraction side is available as a special order.

How to Order

Standard model no. **-XB11**

Specifications: Same as standard type

• Long stroke type

* Enter a symbol for stroke required.

Stroke Range

Model	Bore size (mm)	Standard stroke (mm)	Long stroke (mm)
MY1B-Z	25, 32, 40	100 to 2000	2001 to 5000
MY1H-Z	25, 32, 40	50 to 600	601 to 1500
MY1B	10, 16, 20, 50, 63, 80, 100	100 to 2000	2001 to 5000 (Up to 3000 for $\phi 10, \phi 16$)
MY1M (W)	16, 20, 25, 32, 40, 50, 63	100 to 2000	2001 to 5000 (3000 for $\phi 16$ only, 3000 for MY1MW)
MY1C (W)	16, 20, 25, 32, 40, 50, 63	100 to 2000	2001 to 5000 (3000 for $\phi 16$ only, 3000 for MY1CW)
MY1H	16, 20	50 to 600	601 to 1000
MY2C	16, 25, 40	100 to 2000	2001 to 5000 (Up to 3000 for $\phi 16$)
MY2H/HT	16, 25, 40	50 to 600	601 to 1500 (Up to 1000 for $\phi 16$)
MY3A	16, 20, 25, 32, 40, 50, 63	100 to 2000	2001 to 3000
MY3B	16, 25, 40, 63	100 to 2000	2001 to 3000
MY3M	16, 25, 40, 63	100 to 2000	2001 to 3000
CY3B	25, 32, 40, 50, 63	100 to 1000	2001 to 3000 ($\phi 25$ to $\phi 40$) 2001 to 5000 ($\phi 50, \phi 63$)
CY1H	10	100 to 300	301 to 500
	15	100 to 500	501 to 750
	20	100 to 600	601 to 1000
	25	100 to 800	801 to 1200
CY1HT	25	100 to 1000	1001 to 1200
	32	100 to 1000	1001 to 1500
CX2	15, 25	25 to 200	225, 250, 275, 300
Model	Bore size (mm)	Standard stroke (mm)	Long stroke (mm)
CXWM	16, 20, 25, 32	25 to 200	225, 250, 275, 300 (CXWM16 to 25) 225, 250 (CXWM32)
			225, 250, 275 (CXWL16 to 25) 225 (CXWL32)
CXWL	10	10 to 75	80, 90, 100, 110, 120, 125, 150
CXSJ	15	10 to 100	110, 120, 125, 150
	20, 25, 32	10 to 100	110, 120, 125, 150, 175, 200
CXS	10	10 to 75	80, 90, 100, 110, 120, 125, 150
	15	10 to 100	110, 120, 125, 150
CXSW	20, 25, 32	10 to 100	110, 120, 125, 150, 175, 200
	10, 15	10, 20, 30, 40, 50	75, 100, 125, 150
ML1	25, 32, 40	100 to 1000	1001 to 2000
	25, 32, 40	100 to 1000	2001 to 4000 ($\phi 25, \phi 32$) 2001 to 5000 ($\phi 40$) 2001 to 6000 ($\phi 50, \phi 63$)
REA	25, 32, 40, 50, 63	200 to 1000	2001 to 4000 ($\phi 25, \phi 32$) 2001 to 5000 ($\phi 40$) 2001 to 6000 ($\phi 50, \phi 63$)



Made to Order Common Specifications: -XB11: Long Stroke Type



7 Long Stroke Type

Dimensions

CX2 series: $\phi 15, \phi 25$

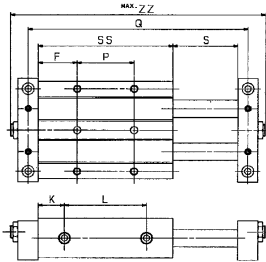

Model	F	L	K	P	Q	S	SS	Z	ZZ
CX2N15-225	89.5	238	15.5	90	506	227	269	496	528
CX2N15-250	102	263	15.5	90	556	252	294	546	578
CX2N15-275	114.5	288	15.5	90	606	277	319	596	628
CX2N15-300	127	313	15.5	90	656	302	344	646	678

Model	F	L	K	P	Q	S	SS	Z	ZZ
CX2N25-225	96	241	20.5	90	525	227	282	509	553
CX2N25-250	108.5	266	20.5	90	575	252	307	559	603
CX2N25-275	121	291	20.5	90	625	277	332	609	653
CX2N25-300	133.5	316	20.5	90	675	302	357	659	703

CXWM series: $\phi 16, \phi 25$

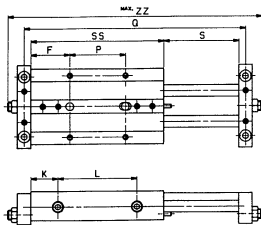

Model	F	L	K	P	Q	S	SS	Z	ZZ
CXWM16-225	92.5	238	18.5	90	514	227	275	502	538
CXWM16-250	105	263	18.5	90	564	252	300	552	588
CXWM16-275	117.5	288	18.5	90	614	277	325	602	638
CXWM16-300	130	313	18.5	90	664	302	350	652	688

Model	F	L	K	P	Q	S	SS	Z	ZZ
CXWM25-225	96	241	20.5	90	525	227	282	509	553
CXWM25-250	108.5	266	20.5	90	575	252	307	559	603
CXWM25-275	121	291	20.5	90	625	277	332	609	653
CXWM25-300	133.5	316	20.5	90	675	302	357	659	703

$\phi 20, \phi 32$

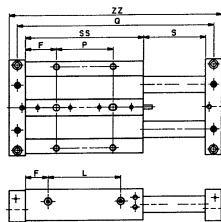

Model	F	L	K	P	Q	S	SS	Z	ZZ
CXWM20-225	94.5	239	20	90	520	227	279	506	534
CXWM20-250	107	264	20	90	570	252	304	556	584
CXWM20-275	119.5	289	20	90	620	277	329	606	634
CXWM20-300	132	314	20	90	670	302	354	656	684

Model	F	L	K	P	Q	S	SS	Z	ZZ
CXWM32-225	38	240	28	220	543	227	296	523	563
CXWM32-250	38	265	28	245	593	252	321	573	613

CXWL series: $\phi 16, \phi 25$

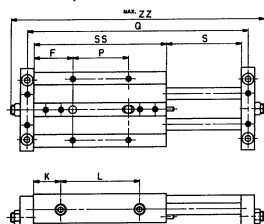

Model	F	L	K	P	Q	S	SS	Z	ZZ
CXWL16-225	115.5	239	41	90	560	227	321	548	584
CXWL16-250	128	264	41	90	610	252	346	598	634
CXWL16-275	140.5	289	41	90	660	277	371	648	684

Model	F	L	K	P	Q	S	SS	Z	ZZ
CXWL25-225	119	241	43.5	90	571	227	328	555	599
CXWL25-250	131.5	266	43.5	90	621	252	353	605	649
CXWL25-275	144	291	43.5	90	671	277	378	655	699

Dimensions

CXWL series: $\varnothing 20, \varnothing 32$

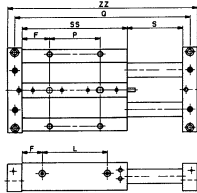

Model	F	L	K	P	Q	S	SS	Z	ZZ
CXWL20-225	116.5	239	42	90	564	227	323	550	578
CXWL20-250	129	264	42	90	614	252	348	600	628
CXWL20-275	141.5	289	42	90	664	277	373	650	678

Model	F	L	K	P	Q	S	SS	Z	ZZ
CXWL32-225	41	277	30	255	584	227	337	564	604

CXSJ_L^M series: $\varnothing 10$

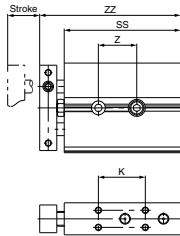

CXSJ_L^M series: $\varnothing 15, \varnothing 20, \varnothing 25, \varnothing 32$

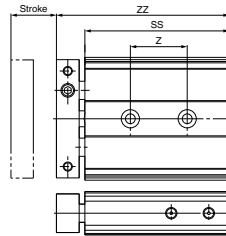

Model	CXSJ ^M $\varnothing 10$					CXSJ ^M $\varnothing 15$					CXSJ ^M $\varnothing 20$					CXSJ ^M $\varnothing 25$					CXSJ ^M $\varnothing 32$								
Stroke	80	90	100	110	120	125	150	110	120	125	150	110	120	125	150	175	200	110	120	125	150	175	200	110	120	125	150	175	200
SS	124.5	134.5	144.5	154.5	164.5	169.5	194.5	167.5	177.5	182.5	207.5	177.5	187.5	192.5	217.5	242.5	267.5	180.5	190.5	195.5	220.5	245.5	270.5	190.5	200.5	205.5	230.5	255.5	280.5
ZZ	136	146	156	166	176	181	206	180	190	195	220	194	204	209	234	259	284	197	207	212	237	262	287	210.5	220.5	225.5	250.5	275.5	300.5
Z	88	98	108	118	128	133	158	65	75			80	100					80	100					90					
K	92	102	112	122	132	137	162																						

Note 1) Dimensions of each model except SS, ZZ, Z and K on the above table are the same as standard type.

CXS_L^M series: $\varnothing 10, \varnothing 15$

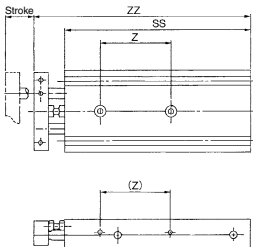

CXS_L^M series: $\varnothing 20, \varnothing 25, \varnothing 32$

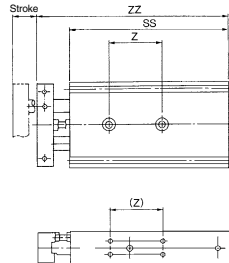

Model	CXS ^M $\varnothing 10$					CXS ^M $\varnothing 15$					CXS ^M $\varnothing 20$					CXS ^M $\varnothing 25$					CXS ^M $\varnothing 32$								
Stroke	80	90	100	110	120	125	150	110	120	125	150	110	120	125	150	175	200	110	120	125	150	175	200	110	120	125	150	175	200
SS	135	145	155	165	175	180	205	170	180	185	210	180	190	195	220	245	270	182	192	197	222	247	272	192	202	207	232	257	282
ZZ	152	162	172	182	192	197	222	189	199	204	229	204	214	219	244	269	294	206	216	221	246	271	296	222	232	237	262	287	312
Z	50	60			70	80		65	75			80	100					80	100					90					

Note 1) Dimensions of each model except SS, ZZ and Z on the above table are the same as standard type.

Note 2) For the external dimensions of the CXSW series double rod, refer to the standard type of CXSW.

Made to Order Common Specifications: -XB12: External Stainless Steel Cylinder



8 External Stainless Steel Cylinder

Symbol
-XB12

A cylinder that uses stainless steel that excels in rust resistance for all external parts that are exposed to the surrounding environment. Its external dimensions and installation dimensions are identical to those of the standard CM2 series.

Applicable Series

Series	Description	Model	Action	Vol. no. (for std model)
CM2	Air cylinder	CM2	Double acting, Single rod Single acting (Spring return/extend)	②-1 From P. 172
		CM2W	Double acting, Double rod	
	Non-rotating rod type	CM2K	Double acting, Single rod Single acting (Spring return/extend)	

How to Order

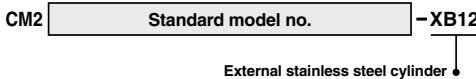

Specifications

Material	External stainless steel 304	
Series	CM2, CM2K	CM2W
Cushion	Rubber bumper (Standard equipment)	
Mounting type	Basic, Axial foot, Rod side flange, Head side flange, Integrated clevis, Boss-cut basic, Boss-cut rod side flange	Basic, Axial foot, Flange
Specifications other than above and external dimensions	Same as standard type	

Note) With air cushion, One-touch fitting integrated type are not available.

Mounting Bracket Part No.

Description	Bore size (mm)			
	20	25	32	40
Foot ⁽¹⁾	CM-L020B-XB12	CM-L032B-XB12	CM-L040B-XB12	
Flange	CM-F020B-XB12	CM-F032B-XB12	CM-F040B-XB12	
Mounting nut	SN-020BSUS	SN-032BSUS	SN-040BSUS	
Rod end nut	NT-02SUS	NT-03SUS	NT-04SUS	
Single knuckle joint	I-020B-XB12	I-032B-XB12	I-040B-XB12	
Double knuckle ⁽²⁾ joint	Y-020B-XB12	Y-032B-XB12	Y-040B-XB12	
Pin for double ⁽³⁾ knuckle joint	CDP-1-XC27		CDP-3-XC27	

Note 1) The minimum order quantity includes 2 foot brackets and 1 mounting nut. Order 2 pcs. per cylinder.

Note 2) With pin, retaining ring

Note 3) With retaining ring (Cotter pins for bore size ø40)

Made to Order Common Specifications: -XB13: Low Speed Cylinder (5 to 50 mm/s)



9 Low Speed Cylinder (5 to 50 mm/s)

Symbol
-XB13

Even if driving at lower speeds 5 to 50 mm/s (CY: 7 to 50 mm/s), there would be no stick-slip phenomenon and it can run smoothly.

Applicable Series

Series	Description	Model	Action	Note	Vol. no. (for std model)
CJ2	Air cylinder	CJ2	Double acting, Single rod	Except with air cushion	②-1 From P. 46
CM2	Air cylinder	CM2	Double acting, Single rod	Except with rod boot and with air cushion	②-1 From P. 172
	Direct mount type	CM2R	Double acting, Single rod	Except with air cushion	
CG1	Air cylinder	CG1-Z	Double acting, Single rod	Except with rod boot and with air cushion	②-1 From P. 292
	Direct mount type	CG1R	Double acting, Single rod	Except with air cushion	
MB	Air cylinder	MB	Double acting, Single rod	Except $\phi 125$	②-1 From P. 392
CU	Free mount cylinder	CU	Double acting, Single rod		②-1 From P. 623
	Non-rotating rod type	CUK	Double acting, Single rod		
	Long stroke, standard type	CU	Double acting, Single rod		
	Long stroke, non-rotating rod type	CUK	Double acting, Single rod		
CQS	Compact cylinder	CQS	Double acting, Single rod	Except long stroke, non-rotating and anti-lateral load types	②-1 From P. 693
		CQSW	Double acting, Double rod	Except non-rotating type	
CQ2	Compact cylinder	CQ2-Z	Double acting, Single rod	Except long stroke, non-rotating, large bore and anti-lateral load types	②-1 From P. 773
		CQ2W-Z	Double acting, Double rod	Except non-rotating and large bore types	
	Axial piping type (Centralized piping type)	CQP2	Double acting, Single rod		
CX2	Slide unit	CX2	Slide bearing type		②-2 From P. 650
CXW	Slide unit	CXWM	Slide bearing type		②-2 From P. 659
		CXWL	Ball bushing bearing type		
MXH	Compact slide	MXH-Z	Double acting, Single rod		②-2 From P. 19
CXSJ	Dual rod cylinder	CXSJ	Standard type		②-2 From P. 737
CXS		CXS	Standard type		②-2 From P. 749
MGP	Compact guide cylinder	MGP ^M _L -Z	Double acting		②-2 From P. 432
MGG	Guide cylinder	MGGM	Double acting	Shock absorber cannot be mounted.	②-2 From P. 538
MGC	Guide cylinder	MGCM	Double acting	With rubber bumper. Port size Rc1/8 is applicable to $\phi 20, 25$.	②-2 From P. 578
CY	Magnetically coupled rodless cylinder	CY3B	Basic type		②-1 From P. 1468
		CY1S-Z	Slide bearing type		
		CY1L	Ball bushing bearing type		
CXT	Platform cylinder	CXT	Double acting	Except long stroke. Shock absorber cannot be mounted.	②-2 From P. 712

How to Order

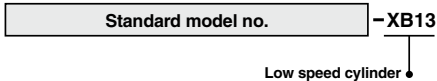

- Note 1) Operate without lubrication from a pneumatic system lubricator.
 Note 2) For the speed adjustment, use speed controllers for controlling at lower speeds. (AS-FM/AS-M series)

Specifications

Piston speed	5 to 50 mm/s (CY: 7 to 50 mm/s)
Dimensions	Same as standard type
Additional specifications	Same as standard type

⚠ Warning Operating Precautions

Be aware that smoking cigarettes, etc. after your hands have come into contact with the grease used in this cylinder can create a gas that is hazardous to humans.

Made to Order Common Specifications: -XB14: Cylinder with Heat Resistant Auto Switch



10 Cylinder with Heat Resistant Auto Switch CQ2 Series/D-M9□J

Symbol
-XB14

Heat resistant (Max. 150°C) type added to the D-M9□ compact auto switch. Choice of output types: PNP, NPN

Applicable Series

Series	Description	Model	Action	Note	Vol. no. (for std model)
CDQ2	Compact cylinder	CDQ2-Z	Double acting, Single rod	ø16 to ø63 only Except with rubber bumper	②-1 From P. 773

How to Order

CDQ2 Standard model no. - M9NJL □ - XB14

Symbol	Output
M9NJ	NPN
M9PJ	PNP

* Lead wire length symbols
3 m..... L (Example) M9NJL
5 m..... Z (Example) M9NJZ

Number of auto switches
Cylinder with heat resistant auto switch

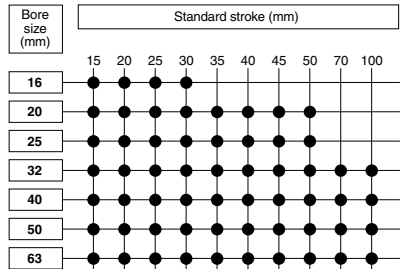

• Manufacturing of intermediate strokes
Intermediate strokes in 1 mm increments are available by using spacers with standard stroke cylinders.

Specifications

Ambient and fluid temperature range	0 to 150°C
Seal material	Fluororubber
Grease	Heat resistant grease
Standard stroke	See right side.
Dimensions	See below.
Specifications other than above	Same as standard type

Note) For detailed specifications about auto switch, refer to page 1636.

Proper Mounting Auto Switch Position (Detection at stroke end)

ø16 to ø25

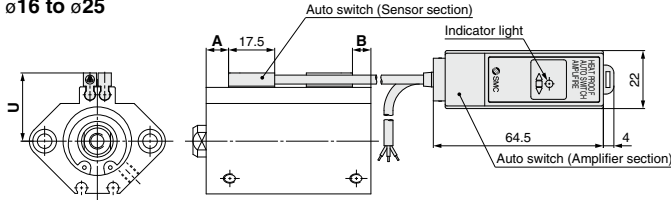

Auto Switch Proper Mounting Position (Detection at stroke end) and Mounting Height (mm)

Bore size	Auto switch model		
	A	B	U
16	9.5	7	21
20	9.5	8.5	23.5
25	9.5	9	27
32	11	8	29
40	15	10.5	31
50	13	13.5	36
63	15.5	16.5	41.5

Note) Adjust the auto switch after confirming the operating condition in the actual setting.

ø32 to ø63

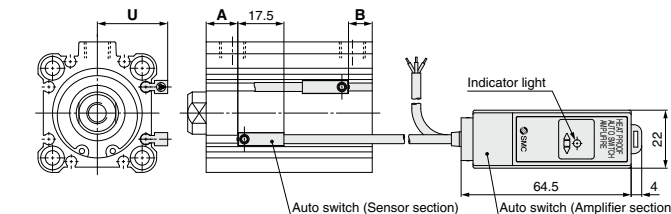

Operating Range (mm)

Auto switch model	Bore size						
	16	20	25	32	40	50	63
D-M9NJ□	4.5	4.5	4.5	5	4.5	5	5
D-M9PJ□	4.5	4.5	4.5	5	4.5	5	5

* Since the operating range is provided as a guideline at room temperature, it cannot be guaranteed. It may change substantially depending on the ambient environment.

* Dimensions on the cylinder body is equivalent to the standard type, double acting, single rod of the CDQ2 series.

Note 1) Auto switches are shipped in the same package, but not assembled in order to protect it at the time of shipment. Assemble it by referring to A, B dimensions for mounting position shown in the table above.

Note 2) Tightening torque for auto switch mounting M3 screw should be set as 0.5 to 0.7 N·m.

Made to Order Common Specifications: -XB14: Cylinder with Heat Resistant Auto Switch



10 Cylinder with Heat Resistant Auto Switch CQ2 Series/D-F7NJ□ Symbol **-XB14**

Heat resistant compact cylinder CDQ2 series (ø16 to ø63) which can mount heat resistant solid state switch. (D-F7NJ ½ Max. 150°C)

Applicable Series

Series	Description	Model	Action	Note	Vol. no. (for std model)
CQ2	Compact cylinder	CQ2-Z	Double acting, Single rod	Applicable to ø16 to ø63 Except with rubber bumper	②-1 From P. 773

How to Order

CDQ2 Standard model no. - F7NJL - XB14

Cylinder with heat resistant auto switch •

Specifications

Ambient and fluid temperature range	0 to 150°C
Seal material	Fluororubber
Grease	Heat resistant grease
Standard stroke	See right side.
Dimensions	See below.
Specifications other than above	Same as standard type

Note) For detailed specifications about auto switch, refer to page 1637.

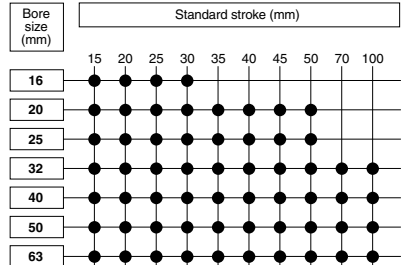

• Manufacturing of intermediate strokes
Intermediate strokes in 1 mm increments are available by using spacers with standard stroke cylinders.

Proper Mounting Auto Switch Position (Detection at stroke end)

ø16 to ø25

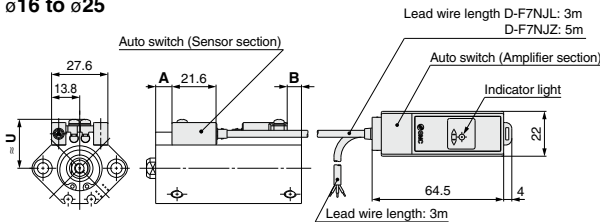

Bore size (mm)	(mm)		
	A	B	U
16	8	5.5	22.5
20	8	7	25.5
25	8	7.5	28
32	9.5	6.5	36
40	13.5	9	38
50	11.5	12	43.5
63	14	15	48.5

Auto Switch Mounting Bracket: Part No.

Auto switch model	Bore size (mm)					
	16	20	25	32	40	50
D-F7NJL(Z)	BQ4-012			BQJ2-032		

Auto Switch Mounting Bracket Weight

Mounting bracket part no.	Weight (g)
BQ4-012	1.5
BQJ2-032	3.6

ø32 to ø63

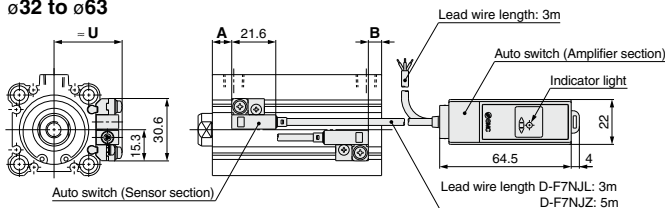

* Dimensions on the cylinder body is equivalent to the standard type, double acting, single rod of the CDQ2 series.

Note 1) Auto switches are shipped in the same package, but not assembled in order to protect it at the time of shipment. Assemble it by referring to A, B dimensions for mounting position shown in the table above.

Note 2) Tightening torque for auto switch mounting M3 screw should be set as 0.5 to 0.7 N·m.

Made to Order Common Specifications: -XB19: High Speed Type



11 High Speed Type

Symbol
-XB19

This is a high speed type of the dual rod cylinder CXS series.

The cylinder speed can reach a maximum of 1500 mm/s (1000 mm/s for $\phi 25$ and $\phi 32$) by enlarging the orifice diameter of the cylinder port. The allowable kinetic energy is approximately four times that of the standard type.

Applicable Series

Series	Description	Model	Action	Vol. no. (for std model)
CXS	Dual rod cylinder	CXS	Double acting, Single rod	②-2 From P. 749

Specifications

Bore size (mm)	6	10	15	20	25	32
Minimum operating pressure	0.15 MPa	0.1 MPa			0.05 MPa	
Maximum operating pressure	0.7 MPa					
Proof pressure	1.05 MPa					
Fluid	Air (Non-lube)					
Ambient and fluid temperature	-10 to 60°C (No freezing)					
Piston speed	30 to 1500 mm/s			30 to 1000 mm/s		
Port size	M5 x 0.8				Rc 1/8	
Stroke adjustable range	0 to -5 mm compared to the standard stroke					
Bearing type	Slide bearing, Ball bushing bearing					
Cushion	Rubber bumper					

How to Order

CXS -XB19
High speed type

Operating Conditions

Maximum Load Mass

When the cylinder is mounted as shown in the diagrams on the right, the maximum load mass (m) should not exceed the values indicated in the graph below.

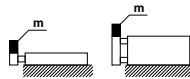

CXS □ 6, 10, 15, 20

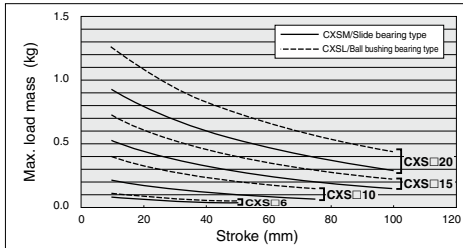

CXS □ 25, 32

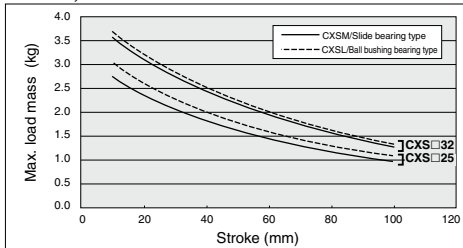

Allowable kinetic energy (XB19)

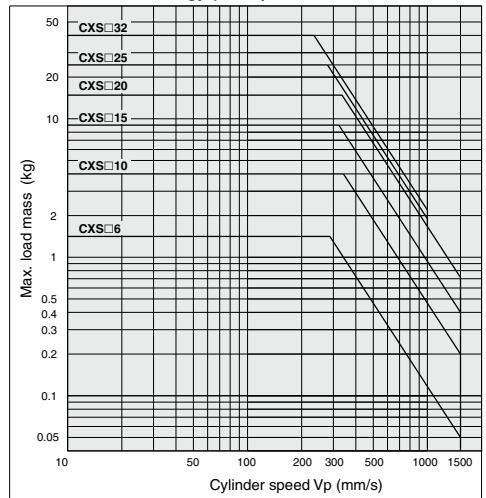

Dimensions

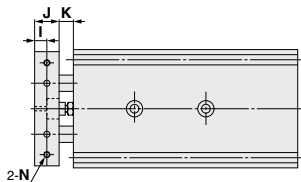

Bore size (mm)	I	J	K	N
6	3.25	6.5	7	M3 x 0.5 through-hole
10	5	10	7	M3 x 0.5 through-hole
15	6	12	7	M3 x 0.5 through-hole
20	7	14	10	M4 x 0.7 thread depth 6
25	7	14	10	M5 x 0.8 thread depth 7.5
32	9	18	12	M5 x 0.8 thread depth 8



Made to Order Common Specifications: -XB20: Stroke Adjustment Unit with Adjustment Bolt



12 Stroke Adjustment Unit with Adjustment Bolt

Stroke adjustment unit with an adjustment bolt.

Applicable Series

Series	Description	Model	Action	Vol. no. (for std model)
MY2	Mechanically jointed rodless cylinder	MY2H	Linear guide (Single axis)	①-1 From P. 1388
		MY2HT	Linear guide (Double axis)	

How to Order

MY2H
MY2HT Standard model no. -XB20

Stroke Adjustment Unit Specifications

Bore size (mm)		16		25		40	
Unit symbol		L	H	L	H	L	H
Shock absorber model	MY2H	RB0806	RB1007	RB1007	RB1412	RB1412	RB2015
	MY2HT	RB1007	RB1412	RB1412	RB2015	RB2015	RB2725
Stroke adjustment range by intermediate fixing spacer (mm)	Without spacer	0 to -5.6		0 to -11.5		0 to -16	
	With short spacer	-5.6 to -11.2		-11.5 to -23		-16 to -32	
	With long spacer	-11.2 to -16.8		-23 to -34.5		-32 to -48	

* Spacers are used to fix the stroke adjustment unit at an intermediate stroke position.
* Stroke adjustment range is applicable for one side when mounted on a cylinder.

Stroke adjustment unit mounting diagram

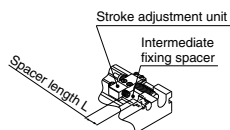

Example of L6L7 attachment

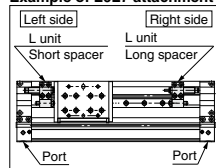

Stroke Adjustment Unit Model

Note) Stroke adjustment unit with adjusting bolt (-XB20) cannot be mounted on the standard cylinder.

Guide symbol • **MY2** H - **A** 25 L2 - **6N** - **XB20**

Symbol	Stroke adjustment unit	Mounting position
H	MY2H16	For left
H	MY2H25	For left
H	MY2H40	For left
HT	MY2HT16	For left
HT	MY2HT25	For left
HT	MY2HT40	For left

Stroke adjustment unit

Cylinder bore size	Stroke adjustment unit
16	16 mm
25	25 mm
40	40 mm

Cylinder bore size

Symbol	Stroke adjustment unit	Mounting position
L1	L unit	For left
L2	L unit	For right
H1	H unit	For left
H2	H unit	For right

Unit part no. •

With adjustment bolt

Symbol	Stroke adjustment unit
Nil	Without spacer
6	Short spacer
7	Long spacer

Intermediate fixing spacer

Symbol	Stroke adjustment unit
Nil	Assembled as a unit
N	Spacer only

Spacer shipping method

* Spacers for MY2HT are shipped in 2 piece sets.
* Intermediate fixing spacers are shipped together.

MY2H (-XB20)

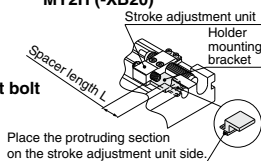

MY2HT (-XB20)

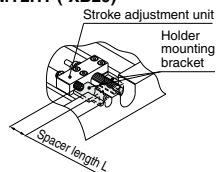

Components Parts

MY2H-A25L2-XB20 (Without spacer)

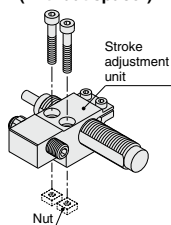

MY2H-A25L2-6-XB20 (With short spacer)

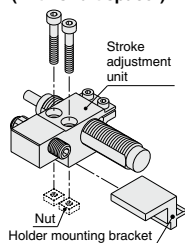

MY2H-A25L2-7-XB20 (With long spacer)

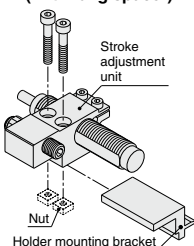

MY2H-A25L2-6N-XB20 (Short spacer only)

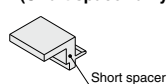

MY2H-A25L2-7N-XB20 (Long spacer only)

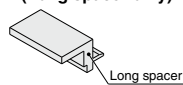

* Nuts are installed onto the cylinder body.

Made to Order Common Specifications: Stroke Adjustment Unit with Adjustment Bolt

Symbol
-XB20

Dimensions (Dimensions other than below are the same as standard type.)

MY2H L unit

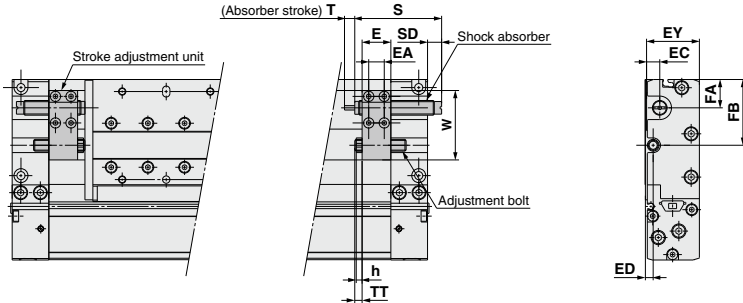

Applicable cylinder	E	EA	EC	ED	EY	FA	FB	h	S	T	SD	TT	W	Shock absorber model	Adjusting bolt	Adjustment range
MY2H16	15.8	8.4	6.2	5	28	12.4	30	3.2	40.8	6	1.3	4.2 (Max. 9.8)	34.5	RB0806	M5 x 0.8 x 25L	5.6
MY2H25	19.6	10.6	10	5.5	37	19.3	44.8	4	46.7	7	—	5 (Max. 16.5)	47.3	RB1007	M8 x 1.0 x 35L	11.5
MY2H40	29	16	13	8	57	17	49	5	67.3	12	—	6 (Max. 22)	59	RB1412	M10 x 1.0 x 50L	16

MY2H H unit

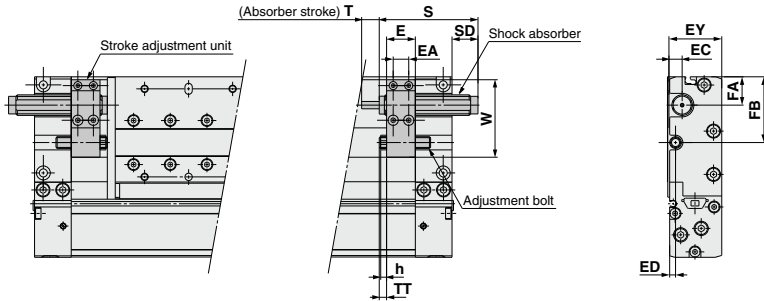

Applicable cylinder	E	EA	EC	ED	EY	FA	FB	h	S	SD	T	TT	W	Shock absorber model	Adjustment bolt	Adjustment range
MY2H16	15.8	8.4	6.2	5	28	12.4	30	3.2	46.7	7.2	7	4.2 (Max. 9.8)	35.5	RB1007	M5 x 0.8 x 25L	5.6
MY2H25	19.6	10.6	10	5.5	37	19.3	44.8	4	67.3	18.2	12	5 (Max. 16.5)	52.8	RB1412	M8 x 1.0 x 35L	11.5
MY2H40	29	16	13	8	57	17	49	5	73.2	—	15	6 (Max. 22)	59	RB2015	M10 x 1.0 x 50L	16

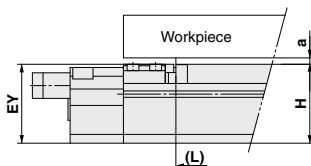

⚠ Caution

Since the dimension **EY** of the unit is greater than the table top height (dimension **H**), when a workpiece is loaded that is larger than the full length (dimension **L**) of the slide table, allow a clearance of size "a" or larger at the workpiece side.

Applicable cylinder	a	EY	H
MY2H16 L/H Unit	1	28	28
MY2H25 L/H Unit	1	37	37
MY2H40 L/H Unit	0	57	58

Made to Order Common Specifications: -XB20: Stroke Adjustment Unit with Adjustment Bolt



12 Stroke Adjustment Unit with Adjustment Bolt

Dimensions (Dimensions other than below are the same as standard type.)

MY2HT L unit

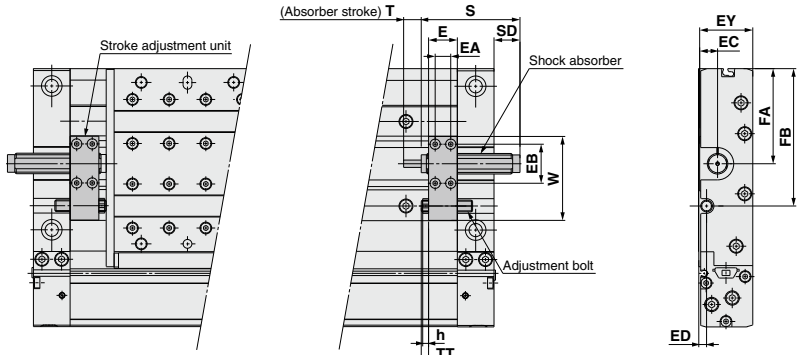

Applicable cylinder	E	EA	EB	EC	ED	EY	FA	FB	h	S	SD	T	TT	W	Shock absorber model	Adjustment bolt	Adjustment range
MY2HT16	15.8	8.4	21	9	5	28	46.5	67	3.2	46.7	7.2	7	4.2 (Max. 9.8)	40.6	RB1007	M5 x 0.8 x 25L	5.6
MY2HT25	19.6	10.6	26.6	12.2	5.5	37	64.8	93.6	4	67.3	18.2	12	5 (Max. 16.5)	57.2	RB1412	M8 x 1.0 x 35L	11.5
MY2HT40	29	16	37	18.2	8	58	74.5	110.5	5	73.2	—	15	6 (Max. 22)	71.6	RB2015	M10 x 1.0 x 50L	16

MY2HT H unit

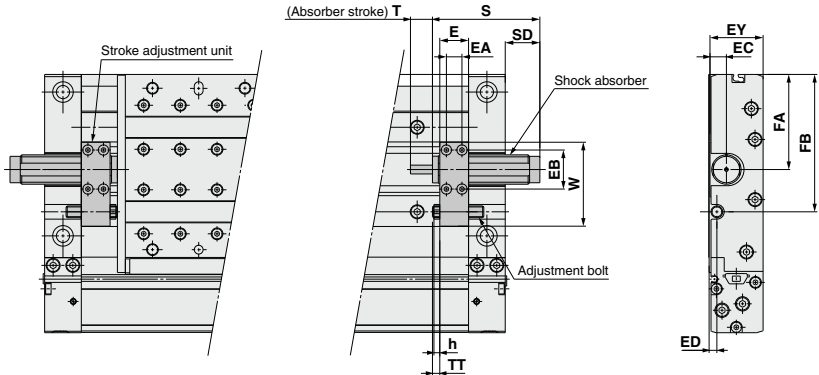

Applicable cylinder	E	EA	EB	EC	ED	EY	FA	FB	h	S	SD	T	TT	W	Shock absorber model	Adjustment bolt	Adjustment range
MY2HT16	15.8	8.4	21	9	5	28	46.5	67	3.2	67.3	27.8	12	4.2 (Max. 9.8)	40.6	RB1412	M5 x 0.8 x 25L	5.6
MY2HT25	19.6	10.6	26.6	12.2	5.5	37	64.8	93.6	4	73.2	24.1	15	5 (Max. 16.5)	57.2	RB2015	M8 x 1.0 x 35L	11.5
MY2HT40	29	16	37	18.2	8	58	74.5	110.5	5	99	24.5	25	6 (Max. 22)	71.6	RB2725	M10 x 1.0 x 50L	16

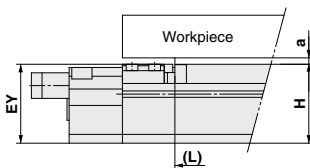

⚠ Caution

Since the dimension EY of the unit is greater than the table top height (dimension H), when a workpiece is loaded that is larger than the full length (dimension L) of the slide table, allow a clearance of size "a" or larger at the workpiece side.

Applicable cylinder	a	EY	H
MY2HT16 L/H Unit	1	28	28
MY2HT25 L/H Unit	1	37	37
MY2HT40 L/H Unit	1	58	58

Made to Order Common Specifications: Stroke Adjustment Unit with Adjustment Bolt

Symbol
-XB20

XB20 (Stroke Adjustment Unit with Adjustment Bolt)

⚠ Caution

<Stroke adjustment with adjusting bolt>

1. Loosen the lock nut for the adjustment bolt and adjust a stroke by rotating the adjustment bolt.

After adjusting the stroke, secure the adjustment bolt by tightening the lock nut.

If the effective stroke of the shock absorber is shortened by the stroke adjustment, its absorption capacity will be drastically reduced. Therefore, the adjustment bolt should be secured at a position where it projects about 0.5 mm farther than the shock absorber.

Tighten shock absorber holding bolts equally with the specified tightening torque.

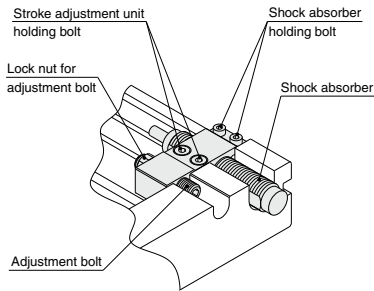

MY2H(-XB20)

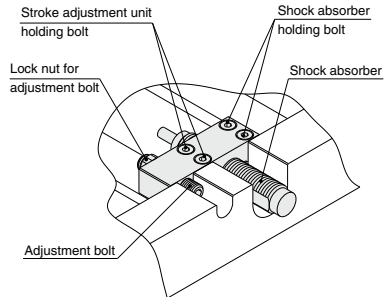

MY2HT(-XB20)

Tightening Torque for Stroke Adjustment Unit Holding Bolt

Bore size (mm)	MY2H		MY2HT		(N·m)
	L unit	H unit	L unit	H unit	
16				0.6	
25				1.5	
40				5.0	

Tightening Torque for Shock Absorber Holding Bolt

Bore size (mm)	MY2H		MY2HT		(N·m)
	L unit	H unit	L unit	H unit	
16				0.6	
25	1.5	0.6		1.5	
40	5.0	1.5		5.0	

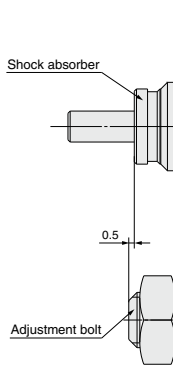

2. Do not use the shock absorber and air cushion together.



Made to Order Common Specifications: -XB22: Shock Absorber Soft Type RJ Series Type



13 Shock Absorber Soft Type RJ Series Type

- The standard cylinder has been equipped with shock absorber soft type RJ series type to enable soft stopping at the stroke end.
- Two different shock absorbers are available in accordance with the operating conditions.

Applicable Series

Series	Description	Model	Bearing type	Applicable bore size	Vol. no. (for std model)
MY	Mechanically jointed rodless cylinder	MY1B-Z	Basic type	ø25, ø32, ø40	②-1 From P. 1188
		MY1H-Z	Single-axis linear guide type	ø25, ø32, ø40	
		MY1B	Basic type	ø10, ø20	
		MY1M	Slide bearing type	ø16 to ø40	
		MY1C	Cam follower type	ø16 to ø40	
		MY1H	Single-axis linear guide type	ø10, ø16, ø20	
		MY1□W	With protective cover	ø16 to ø40	
		MY2C	Cam follower type	ø16, ø25, ø40	
		MY2H	Single-axis linear guide type	ø16, ø25, ø40	
		MY2HT	Double-axis linear guide type	ø16, ø25	
		MY3B	Basic type	ø16 to ø50	
		MY3M	Slide bearing type	ø16, ø25, ø40	
CY	Magnetically coupled rodless cylinder	CY1L	Ball bushing bearing type	ø6 to ø25	②-1 From P. 1516
		CY1H	Single-axis linear guide type	ø10 to ø25	
		CY1HT	Double-axis linear guide type	ø25	
MGP	Compact guide cylinder	MGP-Z	Slide bearing type, Ball bushing bearing type	ø12 to ø40	②-2 From P. 432
MGG	Guide cylinder	MGG	Slide bearing type, Ball bushing bearing type	ø20 to ø32	②-2 From P. 538
CX2	Slide unit	CX2N	Slide bearing type	ø10, ø15, ø25	②-2 From P. 650
CXT	Platform cylinder	CXT	Slide bearing type, Ball bushing bearing type	ø12 to ø25	②-2 From P. 712

How to Order



How to Order a Stroke Adjustment Unit for MY Itself

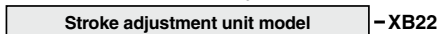

Specifications

Absorbed energy	For the maximum impact weight graph, refer to page 1754.
Specifications other than above and external dimensions	Same as standard type

* For dimensions of the MGP series, refer to page 1754-1.

- * For details on shock absorber soft type RJ series, refer to Best Pneumatics No.2-3.
- * The shock absorber service life is different from that of each cylinder. Refer to the "Specific Product Precautions" of the RJ series for the replacement period.

Cylinders

Note) Refer to Best Pneumatics No. 2-3 for the details of the shock absorber RB series.

Mechanically Jointed Rodless Cylinder

Model	Type	Stroke adjusting unit	Bore size						
			ø10	ø16	ø20	ø25	ø32	ø40	ø50
MY1B-Z MY1H-Z	-XB22	L	/	/	/	RJ1007H	RJ1412H		/
		H				RJ1412H	—	—	
		Standard				RB1007	RB1412		
MY1B	-XB22	L	/	/	RJ0806H	/	/	/	/
		H			RJ1007H				
		Standard			L				
MY1M MY1C	-XB22	L	/	RJ0806H	RJ1007H	RJ1412H		/	
		H		RJ1007H	RJ1412H	—	—		
		Standard		L	RB0806	RB1007	RB1412		
MY1H	-XB22	L	/	RJ0806H	RJ1007H	/	/	/	
		H		RJ1007H					
		Standard		L	RB0806				
MY1□W	-XB22	L	/	RJ0806H	RJ1007H	RJ1412H		/	
		H		RB0806	RB1007	RB1412			
		Standard		L	RB0806	RB1007	RB1412		
MY2C MY2H	-XB22	L	/	RJ0806H	RJ1007H	/	/	RJ1412H	
		H		RJ1007H (Note)	RJ1412H			—	
		Standard		L	RB0806			RB1007	RB1412
MY2HT	-XB22	L	/	RJ1007H	RJ1412H	/	/	—	
		H		RJ1412H	—			—	
		Standard		L	RB1007			RB1412	RB2015
MY3B	-XB22	L	/	RJ0806H	RJ1007H	RJ1412H		/	
		H		RJ1007H	RJ1412H	—	—		
		Standard		L	RB0806	RB1007	RB1412		
MY3M	-XB22	L	/	RJ0806H	RJ1007H	/	/	RJ1412H	
		H		RJ1007H	RJ1412H			—	
		Standard		L	RB0806			RB1007	RB1412
	-XB22	L	/	RJ0806H	RJ1007H	/	/	RB2015	
		H		RJ1007H	RB1412			—	
		Standard		L	RB1007			RB1412	RB2015

Note) MY2C16 is not available with H unit.

Magnetically Coupled Rodless Cylinder

Model	Type	Bore size				
		ø6	ø10	ø15	ø20	ø25
CY1L	-XB22	RJ0805	RJ0806H		RJ1007H	RJ1412H
	Standard	RB0805		RB1006	RB1411	
CY1H	-XB22	RJ0806H			RJ1007H	RJ1412H
	Standard	RB0805	RB0806	RB1006	RB1411	
CY1HT	-XB22	/				RJ1412H
	Standard	/				RB1411

Guide Cylinder

Model	Type	Bore size					
		ø12	ø16	ø20	ø25	ø32	ø40
MGP-Z	-XB22	RJ0806H		RJ1007H		RJ1412H	
	-XC69	RB0806		RB1007		RB1412	
MGG	-XB22	/			RJ1007H	RJ1412H	
	Standard	/			RB1007	RB1412	RB2015

Platform Cylinder

Model	Type	Bore size			
		ø12	ø16	ø20	ø25
CXT	-XB22	RJ0806H		RJ1007H	RJ1412H
	Standard	RB0806		RB1007	RB1411

Slide Unit/Double Rod Type

Model	Type	Bore size		
		ø10	ø15	ø25
CX2N	-XB22	RJ0806H		RJ1007H
	Standard	RB0805		RB1006



Made to Order Common Specifications: -XB22: Shock Absorber Soft Type RJ Series Type



13 Shock Absorber Soft Type RJ Series Type

Symbol
-XB22

Maximum Impact Weight Graph (Shock Absorber Performance Line Graph) * Values in the maximum impact mass graph are at room temperature (20 to 25°C).

Ensure that the impact mass and the impact speed are within the absorbed energy graphs below.

Refer to each cylinder selection calculation for load factors and guide load factors.

Please consult with SMC for the MY3 series since there are restrictions on collision speed resulting from the cylinder.

■ Type of collision

Horizontally-applied impact

Air cylinder impact (horizontal/upward)

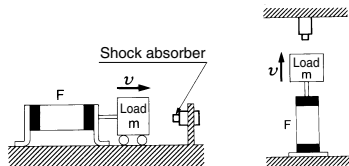

Air cylinder impact (downward)

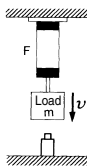

RJ0805 Absorbed Energy

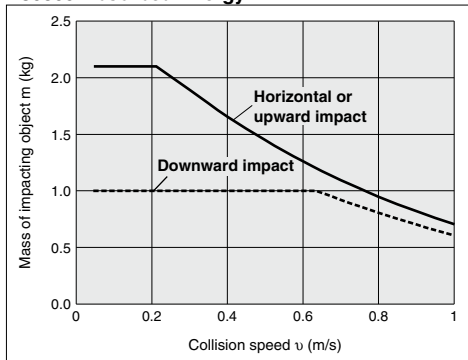

RJ0806H Absorbed Energy

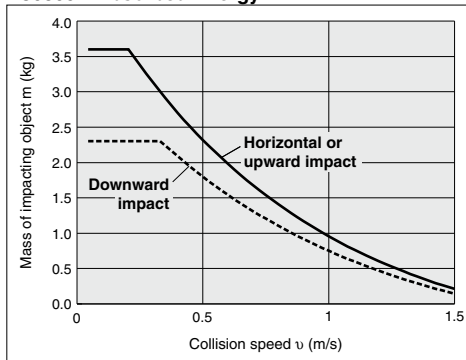

RJ1007H Absorbed Energy

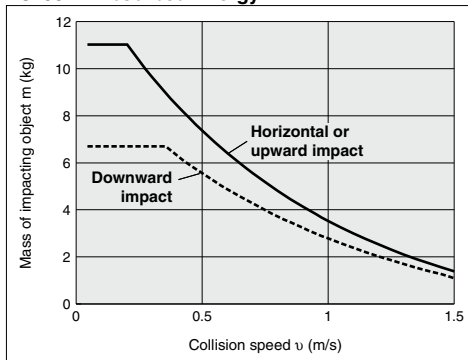

RJ1412H Absorbed Energy

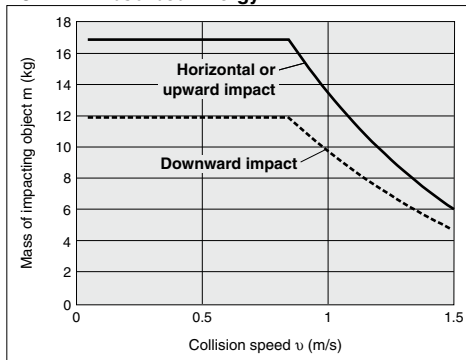

* Be sure to read "Handling Precautions for SMC Products" (M-E03-3) and "Shock Absorber Soft Type RJ Series" (Best Pneumatics No. 2-3) before using.

Made to Order Common Specifications:
Shock Absorber Soft Type RJ Series Type

13 Shock Absorber Soft Type RJ Series Type

Symbol
-XB22

Dimensions (Dimensions other than below are the same as standard type.)

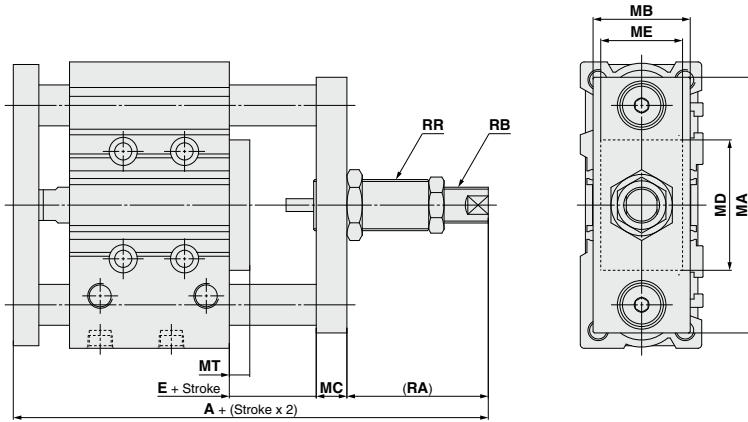

(mm)

Bore size	A	E	MA	MB	MC	MD	ME	MT	RA	RB	RR
12	90	7	51	19	8	27	13	6	33	RJ0806H	M12 x 1.5
16	94	7	58	19	8	28	16	6	33	RJ0806H	M12 x 1.5
20	109	9	68	30	10	33	22	8	37	RJ1007H	M14 x 1.5
25	109.5	9	82	30	10	41	25	8	37	RJ1007H	M14 x 1.5
32	135.5	9	100	38	12	51	32	8	55	RJ1412H	M20 x 1.5
40	142	9	108	38	12	60	32	8	55	RJ1412H	M20 x 1.5

Made to Order Common Specifications: -XC2(A): Rod End Length Extended 10 mm



14 Rod End Length Extended 10 mm

Symbol
-XC2(A)

Rod end length (L dimension) specifications of the cylinder for mounting the flange on the foot or rod side are "standard product + 10 mm" (-XC2).

Applicable Series

Series	Description	Model	Action	Note	Vol. no. (for std model)
CQ2	Standard type	CQ2-Z	Double acting, Single rod	Foot type, Rod side flange only	②-1 From P. 773
		CQ2W-Z	Double acting, Double rod	Foot type only	
	Non-rotating rod type	CQ2K-Z	Double acting, Single rod	Foot type, Rod side flange only	
		CQ2KW-Z	Double acting, Double rod	Foot type only	

Rod end length (L dimension) specifications of the cylinder for mounting the double rod flange are "standard product + 10 mm" (-XC2A).

Applicable Series

Series	Description	Model	Action	Note	Vol. no. (for std model)
CQ2	Standard type	CQ2W-Z	Double acting, Double rod	Flange only	②-1 From P. 799
	Non-rotating rod type	CQ2KW-Z	Double acting, Double rod	Flange only	

How to Order

Standard model no. **- XC2 (A)**

- Rod end length extended 10 mm
- XC2 Foot type, Rod side flange only
- XC2A For mounting double rod flange

Specifications: Same as standard type

Dimensions (Dimensions other than below are the same as standard type.)

Double acting, Single rod

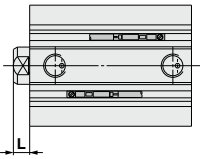

Rod end female thread

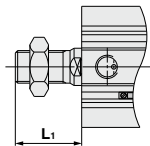

Rod end male thread

Double acting, Double rod (-XC2)

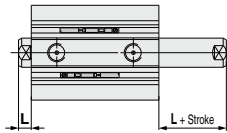

Rod end female thread

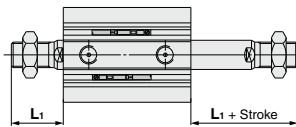

Rod end male thread

Double acting, Double rod (-XC2A)

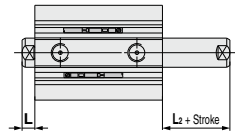

Rod end female thread

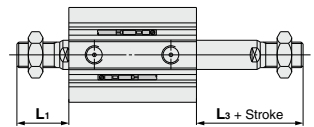

Rod end male thread

Dimensions

Bore size (mm)	Applicable series		Dimensions (mm)	
	Standard type	Non-rotating rod type	Female thread	
			L	L ₁
12	○	—	13.5	24
16	○	—	13.5	25.5
20	○	—	14.5	28.5
25	○	—	15	32.5
32	○	—	17	38.5
40	○	○	17	38.5
50	○	○	18	43.5
63	○	○	18	43.5
80	○	—	20	53.5
100	○	—	22	53.5

Dimensions

Bore size (mm)	Applicable series		Dimensions (mm)			
	Standard type	Non-rotating rod type	Female thread		Male thread	
			L	L ₂	L ₁	L ₃
12	○	—	13.5	3.5	24	14
16	○	—	13.5	3.5	25.5	15.5
20	○	—	14.5	4.5	28.5	18.5
25	○	—	15	5	32.5	22.5
32	○	—	17	7	38.5	28.5
40	○	○	17	7	38.5	28.5
50	○	○	18	8	43.5	33.5
63	○	○	18	8	43.5	33.5
80	○	—	20	10	53.5	43.5
100	○	—	22	12	53.5	43.5



Made to Order Common Specifications: -XC3: Special Port Location



15 Special Port Location

Compared with the standard type, a cylinder which changes the connection port location of rod/head cover and the location of cushion valve.

Applicable Series

Series	Description	Model	Action	Note	Vol. no. (for std. model)
CJ2	Standard type	CJ2-Z	Double acting, Single rod	Except w/ rail mounting type auto switches, w/ air cushion	②-1 From P. 46
	Non-rotating rod type	CJ2K-Z	Double acting, Single rod		
	Smooth cylinder	CJ2Y-Z	Double acting, Single rod		
CM2	Standard type	CM2-Z	Double acting, Single rod Single acting (Spring return/extend)	Except with air cushion	②-1 From P. 172
		CM2W-Z	Double acting, Double rod		
	Air-hydro type	CM2H-Z	Double acting, Single rod		
	Non-rotating rod type	CM2K-Z	Double acting, Single rod Single acting (Spring return/extend)		
		CM2KW-Z	Double acting, Double rod		
	Direct mount type	CM2R-Z	Double acting, Single rod		
	Direct mount type, Air-hydro type	CM2RH-Z	Double acting, Single rod		
	Non-rotating rod, Direct mount type	CM2RK-Z	Double acting, Single rod		
	Smooth cylinder	CM2Y-Z	Double acting, Single rod		
	End lock cylinder	CBM2	Double acting, Single rod		
Low speed cylinder	CM2X-Z	Double acting, Single rod			
MB	Standard type	MB	Double acting, Single rod	②-1 From P. 392	
		MBW	Double acting, Double rod		
	Non-rotating rod type	MBK	Double acting, Single rod		
MB1	Standard type	MB1	Double acting, Double rod	②-1 From P. 440	
		MB1W	Double acting, Single rod		
	Non-rotating rod type	MB1K	Double acting, Single rod		
CA2	Standard type	CA2	Double acting, Single rod	②-1 From P. 470	
		CA2W	Double acting, Double rod		
	End lock cylinder	CBA2	Double acting, Single rod		
CS1	Standard type	CS1	Double acting, Single rod	②-1 From P. 530	
	Low friction type	CS1□Q	Double acting, Single rod		
CS2	Standard type	CS2	Double acting, Single rod	②-1 From P. 568	
	Smooth cylinder	CS2Y	Double acting, Single rod		
RHC	High power cylinder	RHC	Double acting, Single rod	②-3 From P. 351	
RSQ	Stopper cylinder	RSQ	Double acting	②-3 From P. 560	
			Double acting with spring installed		
RSG	Stopper cylinder	RSG	Single acting	②-3 From P. 560	
			Double acting		
			Double acting with spring installed		
CL1	Locked up cylinder	CL1	Double acting, Single rod	②-2 From P. 830	
CLS	Cylinder with lock	CLS	Double acting, Single rod	②-2 From P. 982	
CNA2	Cylinder with lock	CNA2	Double acting, Single rod	②-2 From P. 922	
MXH	Compact slide	MXH-Z	Double acting	②-2 From P. 19	

How to Order

CJ2 -XC3

Special port location

- Head port location seen from the rod side
- Rod port location seen from the rod side

Specifications: Same as standard type.

* For port location, refer to the following diagrams and show the symbols of A, B, C and D.

Port Location

Series	Corresponding symbol of mounting bracket (Positional relationships)	
CJ2 CM2	<p>Position relation between clevis and port</p> <p>* Viewed from the rod side, the ports are rendered A, B, C, and D, in the clockwise direction.</p>	<p>* Viewed from the rod side, with the clevis positioned as shown in the diagram, the ports are rendered A, B, C, and D, in the clockwise direction.</p>
	<p>1. Positional relationships between port and cushion valve cannot be changed. 2. Cylinder with cushion of CJ2 (CJ2-A) is not available for -XC3.</p>	

How to Order

MB, MB1, CA2, CS1, CS2, CNA2, CL1

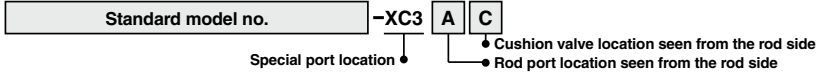

RSQ, RSG

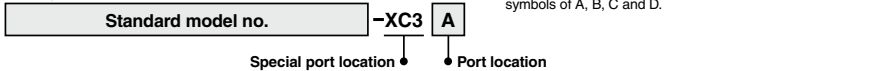

Specifications: Same as standard type

Relation between Port Location and Cushion Valve Location

Series	Corresponding symbol of mounting bracket (Positional relationships)						
CA2 CS1 CNA2 CL1	<p>Basic type</p>	<p>Foot type</p>	<p>Rod side flange type</p>	<p>Head side flange type</p>	<p>Single clevis type</p>	<p>Double clevis type</p>	<p>Center trunnion type</p>
CL1	<ol style="list-style-type: none"> As shown in the above diagram, the symbols for the positions of the ports and cushion valves are as follows: viewed from the rod side, the top position is rendered A; then, B, C, and D, in the clockwise direction. The type in which the ports and the cushion valves are combined is applicable only when the rod cover and the head cover are changed to the same positions. The symbol indicated as "-XC3[A]B" is the standard specification, and there are no part numbers A or B. Those shown above are the same as standard, other than the symbols that indicate the positions of the ports and the cushion valves. 						
CS2	<p>Basic type</p>	<p>Foot type</p>	<p>Rod side flange type</p>	<p>Head side flange type</p>	<p>Single clevis type</p>	<p>Double clevis type</p>	<p>Center trunnion type</p>
CS2	<ol style="list-style-type: none"> Symbol of position for port and cushion valve has to be looked from the rod side, as figures above. (In the case of standard cylinders, port must be positioned in the upper side.) Define the upper side to be A, and then B, C, and D in a clockwise order. Model of combination between port and cushion valve is applicable only when the position of a port and a cushion valve on the rod cover and the head cover will be changed to the same position against the support bracket, as a rule. -XC3AA is not available in terms of the position between port and cushion valve, since it is available in the standard products. 						
MB MB1	<p>Basic type</p>	<p>Foot type</p>	<p>Rod side flange type</p>	<p>Head side flange type</p>	<p>Single clevis type</p>	<p>Double clevis type</p>	<p>Center trunnion type (Except MB1)</p>
MB MB1	<ol style="list-style-type: none"> Symbol of position for port and cushion valve has to be looked from the rod side, as figures above. (In the case of standard cylinders, port must be positioned in the upper side.) Define the upper side to be A, and then B, C, and D in a clockwise order. Model of combination between port and cushion valve is applicable only when the position of a port and a cushion valve on the rod cover and the head cover will be changed to the same position against the support bracket, as a rule. -XC3AA is not available in terms of the position between port and cushion valve, since it is available in the standard products. 						
RSQ RSG	<p>Standard type</p>	<p>-XC3A</p>	<p>-XC3B</p>	<p>-XC3C</p>			
RSQ RSG	<p>In the case of standard type, the symbol for port and rod-chamfered positions are on the same surface and positioned upward. Define the port position at right to be A, and then B, C in a clockwise order.</p>						



Made to Order Common Specifications: -XC3: Special Port Location



15 Special Port Location

How to Order

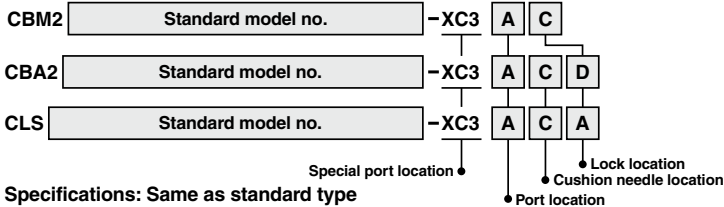

Specifications: Same as standard type

Relation between Port Location and Cushion Valve Location

Series	Corresponding symbol of mounting bracket (Positional relationships)	
CBM2	<p>Port location Rod side port and head side port are at the same location. Symbols of lock position and port location are as the following diagrams.</p> <p>Standard (AD) AC AB</p> <p>Except with air cushion</p>	<p>Clevis type and trunnion type are based on the direction of clevis bracket.</p> <p>AD CD BD Standard (BA) CA DA</p> <p>Diagrams seen from the rod side</p>
CBA2	<p>Port and cushion needle are at the same rod/head position. Symbols of port location, cushion needle position and lock position are as the following diagrams.</p> <p>Standard (ABD) ACD ADB</p> <p>End lock Cushion valve</p>	<p>When the mounting bracket is attached, the conditions placed like below are on a basis.</p> <p>(A) (A) (A) (D) (B)(D) (B)(D) (B)(D)</p> <p>Foot type (A) Rod side flange type (A) Head side flange type (A)</p> <p>(D) (B)(D) (B)(D) (B)(D) (B)(D) (B)(D)</p> <p>Single clevis type Double clevis type Center trunnion type</p> <p>Diagrams seen from the rod side</p>
CLS	<p>Basic type Foot type Rod side flange type Head side flange type Single clevis type Double clevis type Center trunnion type</p> <p>Lock location Port Cushion valve</p>	<p>1. Symbols of port and cushion valve, and lock positions, have to be looked at from the rod side as shown in the figures above. Define the upper side to be A, and then B, C, and D in a clockwise order. 2. The combination model of a port and a cushion valve is applicable when the rod and head covers are moved to the same position. 3. Part number of -XC3[A][B][A] is not available since it indicates a standard type. 4. For the rod side flange type, lock positions [B] and [D] cannot be manufactured since the brake cylinder and the mounting hole of the flange bracket interfere with each other. 5. Symbols excluding those that indicate the locations of ports and cushion valves are the same as the standard type.</p>

How to Order

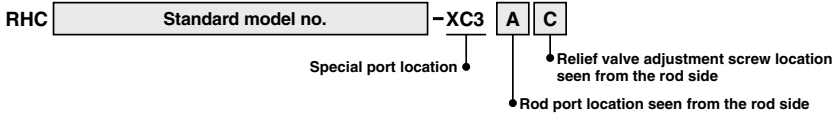

* For port location, refer to the following diagrams and show the symbols of A, B, C and D.

Specifications: Same as standard type

Relation between Port Location and Relief Valve Adjustment Screw Location

Series	Corresponding symbol of mounting bracket (Positional relationships)			
RHC	<p>Basic type</p>	<p>Foot type</p>	<p>Rod side flange type</p>	<p>Head side flange type</p>
	<p>Relief valve adjustment screw</p> <p>① As shown in the above diagram, the symbols for the positions of the ports and the relief valve adjustment screws are as follows: viewed from the rod side, the top position is rendered A, then B, C and D in the clockwise direction. ② The type in which the ports and the relief valve adjustment screws is applicable only when the rod cover and the head cover are changed to the same positions. ③ The symbol indicated as "-XC3[A][B]" is the standard specification, and there are no part numbers A or B. ④ Those shown above are the same as standard, other than the symbols that indicate the positions of the ports and the relief valve adjustment screws. ⑤ Brackets are shipped together.</p>			

How to Order

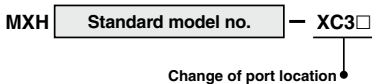

Specifications: Same as standard type

The port location of a standard product is in the axial direction, and it is shipped as plugged on both sides. However, side ported types can be ordered. A shifting of the plugs is not required by the customer.

Relation between Port Location and Plug Location

Standard	-XC3A	-XC3B

Made to Order Common Specifications: -XC4: With Heavy Duty Scraper



16 With Heavy Duty Scraper

It is suitable for using cylinders under the environment, where there are much dusts in a surrounding area by using a heavy duty scraper on the wiper ring, or using cylinders under earth and sand exposed to the die-casted equipment, construction machinery, or industrial vehicles.

Applicable Series

Series	Description	Model	Action	Note	Vol. no. (for std model)
CM2	Air cylinder	CM2-Z	Double acting, Single rod	Head side locking type only (Except w/ air cushion)	②-1 From P. 172
		CM2W-Z	Double acting, Double rod		
	Centralized piping type	CM2□□P	Double acting, Single rod		
	End lock cylinder	CBM2	Double acting, Single rod		
CG1	Air cylinder	CG1-Z	Double acting, Single rod	Applicable to ø32 to ø63	②-1 From P. 292
MB	Air cylinder	MB-Z	Double acting, Single rod	Except ø125	②-1 From P. 392
		MBW-Z	Double acting, Double rod	Except ø125	
MB1	Air cylinder	MB1-Z	Double acting, Single rod	Except ø125	②-1 From P. 440
		MB1W-Z	Double acting, Double rod	Except ø125	
CA2 *	Air cylinder	CA2-Z	Double acting, Single rod	Head side locking type only	②-1 From P. 470
		CA2W-Z	Double acting, Double rod		
	End lock cylinder	CBA2	Double acting, Single rod		
CS1	Air cylinder	CS1	Double acting, Single rod		②-1 From P. 530
		CS1W	Double acting, Double rod		
CS2	Air cylinder	CS2	Double acting, Single rod		②-1 From P. 568
		CS2W	Double acting, Double rod		
CQ2	Air cylinder	CQ2-Z	Double acting, Single rod	Applicable to ø20 to ø100	②-1 From P. 773
		CQ2W-Z	Double acting, Double rod	Applicable to ø40 to ø100	
	Axial piping type (Centralized piping type)	CQP2	Double acting, Single rod	Applicable to ø32 to ø100	
	Long stroke	CQ2-Z	Double acting, Single rod		
RQ	Compact cylinder with air cushion	RQ	Double acting, Single rod		②-1 From P. 985
CV	Valve mounted air cylinder	CVM5	Double acting, Single rod		②-3 From P. 771
		CV3	Double acting, Single rod		②-3 From P. 812
		CVS1	Double acting, Single rod		
MGP	Compact guide cylinder	MGPM-Z	Double acting	Applicable to ø20 to ø100	②-2 From P. 432
		MGPL-Z	Double acting	Applicable to ø20 to ø100	
		MGPA-Z	Double acting	Applicable to ø20 to ø100	
MGG	Guide cylinder	MGG	Double acting	Applicable to ø32 to ø100	②-2 From P. 538
MGC	Guide cylinder	MGC	Double acting	Applicable to ø32 to ø50	②-2 From P. 578
CNA2	Cylinder with lock	CNA2	Double acting, Single rod		②-2 From P. 922
CNG	Cylinder with lock	CNG	Double acting, Single rod	Applicable to ø32, ø40	②-2 From P. 866

* CA2□H (Air-hydro type) comes with a heavy duty scraper as standard.

How to Order

Standard model no. **-XC4**

* For the MGP series, refer to page 1764. **With heavy duty scraper**

⚠ Caution

Do not replace heavy duty scrapers.

- Since heavy duty scrapers are press-fit, do not replace the cover only, but rather the entire rod cover assembly. (Holder plate assembly in the case of the MGP series)
The CM2 series cannot replace either heavy duty scraper or rod seal. (It goes for replacing retainer assembly for the CS1 series.)
Replace the CNA2 series with the lock unit.

Specifications: Same as standard type

Construction (Dimensions are the same as standard.)

CM2 series Refer to page 1762 for the female rod end.

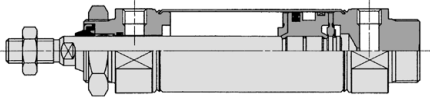

CM2W series Refer to page 1762 for the female rod end.

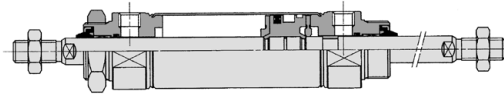

CBM series (Only with head side locking)

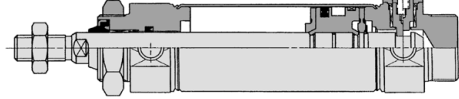

CA2 series

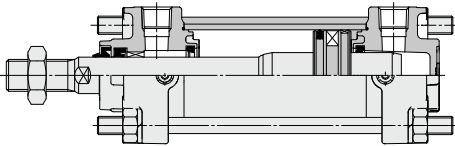

CS1 series

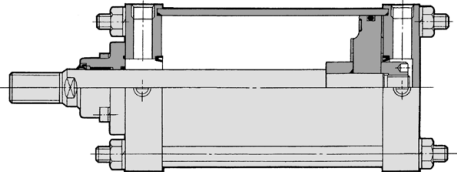

CS2 series

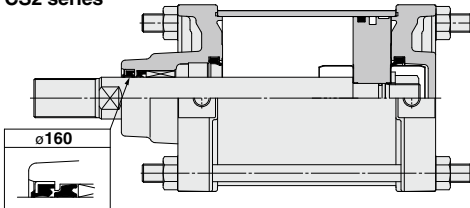

CVS1 series

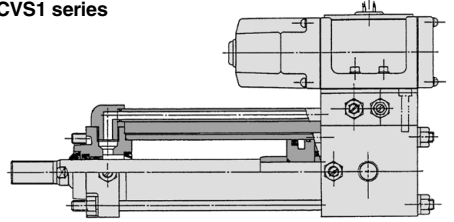

CNA2 series

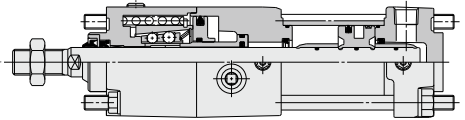

CVM series

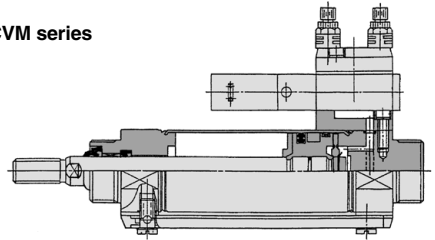

CV3 series

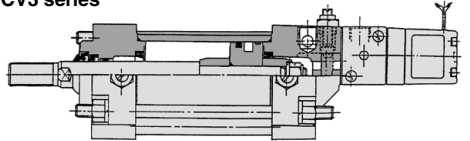

Made to Order Common Specifications: -XC4: With Heavy Duty Scraper



16 With Heavy Duty Scraper

Dimensions (Dimensions other than below are the same as standard type.)

CM2 series CM2W series

* () : Denotes the dimensions for the CM2W series.

Female rod end

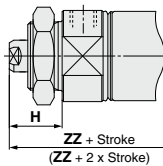

Bore size	CM2 series		CM2W series (mm)	
	H	ZZ	H	ZZ
20	24	99	24	110
25	24	99	24	110
32	24	101	24	112
40	26	130	26	140

MB series MB1 series

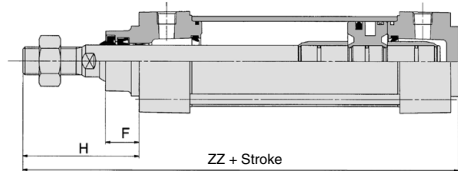

MB, MB1 Series (mm)

Bore size (mm)	F	H	ZZ
32	15	47	135
40	17	58	146
50	19	67	165
63	19	67	165
80	25	81	199
100	25	81	199

CG1 series

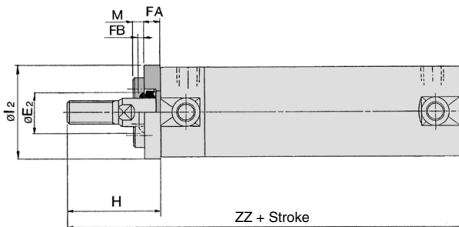

CG1 Series

Bore size	E ₂	FA	FB	M	l ₂	(mm)			
						H		ZZ	
						Male thread	Female thread	Male thread	Female thread
32	17	8	3	5	38	48	28	121	101
40	21	8	3	3.5	47	58	29	138	109
50	26	9	3	4.5	58	66	30	158	122
63	26	9	3	5.5	72	66	30	158	122

Long Stroke

ZZ	
Male thread	Female thread
129	109
147	118
170	134
170	134

* On the axial foot type and the rod side flange type, the mounting bracket is wedged and bolted between the cylinder and the scraper at the time of shipment. On other types, it is placed in the same package (not assembled).

Dimensions (Dimensions other than below are the same as standard type.)

CQ2 series

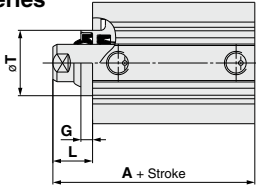

- * () : Denotes the dimensions with auto switch magnet.
- * Relation between bore size 20 to 32 piping port and mounting holes is as the following diagram.
- * Please contact SMC for bore size 20 to 32 with both ends tapped and mounting brackets.

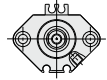

Without auto switch magnet
Bore size 20 to 32

With auto switch magnet
Bore size 32

With auto switch magnet
Bore size 20, 25

Bore size (mm)	A			G		L		T
	50 stroke or less	75, 100 stroke	125 to 300 stroke	100 stroke or less	125 stroke or more	100 stroke or less	125 to 300 stroke	
20	34 (46)	—	—	—	—	4.5	—	—
25	37.5 (47.5)	—	—	—	—	5	—	—
32	40 (50)	50	67.5	—	—	7	12	—
40	46.5 (56.5)	56.5	77	5	10	17	22	28
50	48.5 (58.5)	58.5	78.5	5	10	18	23	35
63	54 (64)	64	80	5	10	18	23	35
80	63.5 (73.5)	73.5	91	5	10	20	25	43
100	75 (85)	85	102.5	5	10	22	27	59

CQ2W series

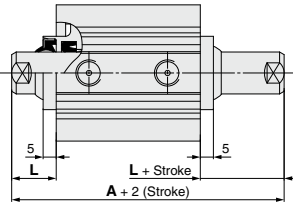

Bore size (mm)	A		L
	50 stroke or less	75, 100 stroke	
40	74 (84)	84	17
50	76.5 (86.5)	86.5	18
63	78 (88)	88	18
80	91 (101)	101	20
100	104.5 (114.5)	114.5	22

RQ series

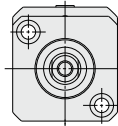
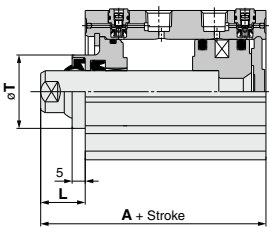

Bore size 20, 25

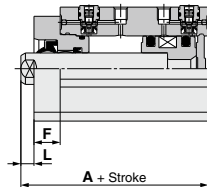

Bore size (mm)	(mm)			
	A	F	L	T
20	46.5	10	4.5	—
25	51.5	10	5	—
32	54	10	7	—
40	61	—	17	28
50	67.5	—	18	35
63	73	—	18	35
80	83.5	—	20	43
100	98	—	22	59

- * Please contact SMC for bore size 20 to 32 with both ends tapped and mounting brackets.
- * Only standard strokes are applicable.

Made to Order Common Specifications: -XC4: With Heavy Duty Scraper



16 With Heavy Duty Scraper

Symbol
-XC4

Dimensions (Dimensions other than below are the same as standard type.)

CNG series

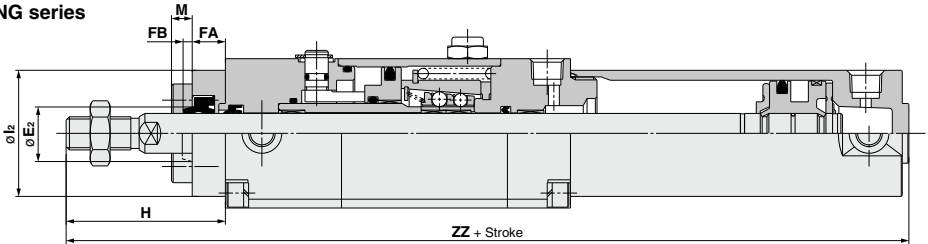

Bore size	E ₂	FA	FB	M	l ₂	H	ZZ
32	17	8	3	5	38	48	204
40	21	8	3	6	48	58	229

Long strokes	ZZ
	212
	238

- * The above figure shows the rubber bumper type.
- * On the axial foot type and the rod side flange type, the mounting bracket is wedged and bolted between the cylinder and the scraper at the time of shipment.

MGG□B series ø32 to ø50

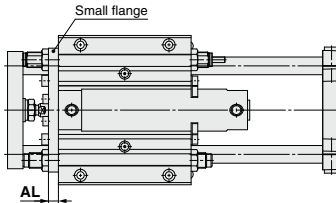

Bore size (mm)	AL (mm)
32	9
40	12
50	12

Specifications: Same as standard type

- Note 1) Except ø20 and ø25
- Note 2) Heavy duty scrapers are attached to the piston rod and guide rods (front and back).
- Note 3) Rod side heavy duty scrapers for ø32 to ø50 are press-fit to large and small flanges.

MGC□B series ø32 to ø50

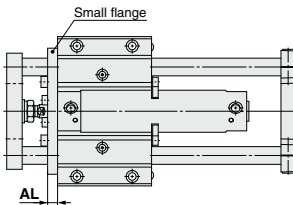

Bore size (mm)	AL (mm)
32	9
40	12
50	12

Made to Order Common Specifications: -XC4: With Heavy Duty Scraper



16 With Heavy Duty Scraper

Symbol
-XC4

How to Order/MGP

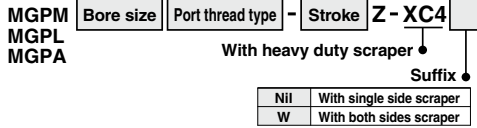

Specifications

Applicable series	MGPM	MGPL/MGPA
Bearing type	Slide bearing	Ball bushing bearing
Bore size (mm)	20, 25, 32, 40, 50, 63, 80, 100	
Minimum operating pressure	With single side	0.12 MPa
	With both sides	0.14 MPa

Specifications other than above are the same as standard type.

Dimensions (Dimensions other than below are the same as standard type.)

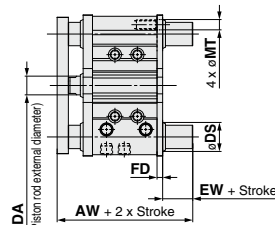
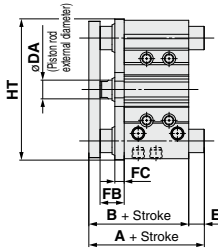

For cylinder with both sides scraper

Common Dimensions:

MGPM, MGPL, MGPA (mm)

Bore size (mm)	B	DA	FB	FC	
				MGPM	MGPL/MGPA
20	63	10	18	9	5
25	63.5	10	17	9	5
32	69.5	14	22	9	5
40	76	14	22	9	5
50	82	20	26	10	8
63	87	20	26	10	5
80	106.5	25	34	15	6
100	126	30	41	15	6

With Both Sides Scraper

Dimensions: AW, EW, FD, MT, DS (mm)

Bore size (mm)	AW	EW	FD	MT	DS ^{*)}	
					MGPM	MGPL/MGPA
20	74	6	5	6	17	15
25	74.5	6	5	7	21	19
32	82.5	7	6	8.5	26	21
40	89	7	6	8.5	26	21
50	95	7	6	11	31	26
63	100	7	6	11	31	26
80	120.5	8	6	14	36	31
100	143	8	9	16	44	36

^{*)} Bypass port size for guide rod with bottom mounting

MGPM (Slide bearing) A, E, HT Dimensions (mm)

Bore size (mm)	A			E			HT
	50 st or less	Over 50 st to 200 st	Over 200 st	50 st or less	Over 50 st to 200 st	Over 200 st	
20	63	87.5	120	0	24.5	57	80
25	63.5	87.5	119.5	0	24	56	93
32	85	103.5	139.5	15.5	34	70	111.5
40	85	103.5	139.5	9	27.5	63.5	119
50	98.5	119.5	160.5	16.5	37.5	78.5	151
63	98.5	119.5	160.5	11.5	32.5	73.5	165
80	114.5	141.5	190.5	8	35	84	202
100	136.5	161.5	200.5	10.5	35.5	74.5	240

MGPL, MGPA (Ball bushing bearing) A, E, HT Dimensions (mm)

Bore size (mm)	A			E			HT	
	30 st or less	Over 30 st to 100 st	Over 100 st to 200 st	30 st or less	Over 30 st to 100 st	Over 100 st to 200 st		
20	69	86	110	127.5	6	23	47	80
25	75.5	91.5	110.5	127.5	12	28	47	93

Bore size (mm)	A			E			HT		
	50 st or less	Over 50 st to 100 st	Over 100 st to 200 st	50 st or less	Over 50 st to 100 st	Over 100 st to 200 st			
32	89.5	106.5	126.5	148.5	20	37	57	79	110
40	89.5	106.5	126.5	148.5	13.5	30.5	50.5	72.5	118
50	101.5	122.5	142.5	169.5	19.5	40.5	60.5	87.5	146
63	101.5	122.5	142.5	169.5	14.5	35.5	55.5	82.5	160

Bore size (mm)	A			E			HT		
	25 st or less	Over 25 st to 50 st	Over 50 st to 200 st	25 st or less	Over 25 st to 50 st	Over 50 st to 200 st			
80	114.5	138.5	168.5	201.5	8	32	62	95	199
100	129.5	155.5	188.5	211.5	3.5	29.5	62.5	85.5	236

Made to Order Common Specifications: -XC5: Heat Resistant Cylinder (-10 to 110°C)



17 Heat Resistant Cylinder (-10 to 110°C)

Symbol
-XC5

Cylinder which changed the seal material for heat resistance (up to 110°C) in order to use under the severe ambient temperature condition which exceeds the standard specifications of -10 to 70°C (0 to 70°C for CS1, CS2 series).

Applicable Series

Series	Description	Model	Action	Note	Vol. no. (for std model)
CM2	Air cylinder	CM2-Z	Double acting, Single rod		②-1 From P. 172
		CM2W-Z	Double acting, Double rod		
	Direct mount type	CM2R-Z	Double acting, Single rod		
MB	Air cylinder	MB-Z	Double acting, Single rod	Except ø125, with rubber bumper, with auto switch	②-1 From P. 392
		MBW-Z	Double acting, Double rod	Except ø125, with rubber bumper, with auto switch	
MB1	Air cylinder	MB1-Z	Double acting, Single rod	Except with rubber bumper, with auto switch	②-1 From P. 440
		MB1W-Z	Double acting, Double rod	Except ø125, with rubber bumper, with auto switch	
CA2	Air cylinder	CA2-Z	Double acting, Single rod		②-1 From P. 470
		CA2W-Z	Double acting, Double rod		
CS1*	Air cylinder	CS1	Double acting, Single rod		②-1 From P. 530
		CS1W	Double acting, Double rod		
CS2	Air cylinder	CS2	Double acting, Single rod		②-1 P. 568
		CS2W	Double acting, Double rod		

How to Order

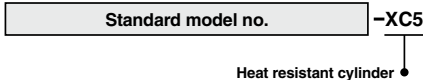

- Note 1) Please contact SMC for details on the maintenance intervals for this cylinder, which differ from those of the standard cylinder.
- Note 2) Manufacturing built-in magnet type and the one with auto switch is impossible.
- Note 3) Material of rod boot is heat resistant tarpaulin.
- Note 4) Applicable bore size of the CS1 series Lube type: ø125 to ø300
Non-lube type: ø125 to ø200

Specifications

Ambient temperature range	-10 to 110°C (0 to 110°C for CS1, CS2 series)
Seal material	Fluororubber (In the case of CS1 cylinder, cushion seal is made of NBR.)
With auto switch	Unavailable ⁽²⁾
Specifications other than above and external dimensions	Same as standard type

Made to Order Common Specifications: -XC6: Made of Stainless Steel



18 Made of Stainless Steel

Suitable for the cases it is likely to generate rust by being immersed in the water and corrosion.

Applicable Series

Series	Description	Model	Action	Vol. no. (for std model)
CM2	Air cylinder	CM2-Z	Double acting, Single rod Single acting (Spring return/extended)	②-1 From P. 172
		CM2W-Z	Double acting, Double rod	
	Non-rotating rod type	CM2K-Z	Double acting, Single rod Single acting (Spring return/extended)	
		CM2KW-Z	Double acting, Double rod	
	Direct mount type	CM2R-Z	Double acting, Single rod	
	Non-rotating rod, Direct mount type	CM2RK-Z	Double acting, Single rod	
	Centralized piping type	CM2□□	Double acting, Single rod	
	Smooth cylinder	CM2Y-Z	Double acting, Single rod	
	Air-hydro type	CM2H-Z	Double acting, Single rod	
	Direct mount type, air-hydro type	CM2RH-Z	Double acting, Single rod	
End lock cylinder	CBM2	Double acting, Single rod		
CG1	Air cylinder	CG1-Z	Double acting, Single rod Single acting (Spring return)	②-1 From P. 292
	Double rod type	CG1W-Z	Double acting, Double rod	
	Direct mount type	CG1R-Z	Double acting, Single rod	
	Smooth cylinder	CG1Y-Z	Double acting, Single rod	
MB ⁽²⁾	Air cylinder	MB	Double acting, Single rod	②-1 From P. 392
	Non-rotating rod type	MBW	Double acting, Double rod	
		MBK	Double acting, Single rod	
MB1 ⁽²⁾	Air cylinder	MB1-Z ⁽⁴⁾	Double acting, Single rod	②-1 From P. 440
	Non-rotating rod type	MB1W-Z ⁽⁴⁾	Double acting, Double rod	
		MB1K-Z	Double acting, Single rod	
		MB1K-Z	Double acting, Single rod	
CA2 ⁽²⁾	Air cylinder	CA2	Double acting, Single rod	②-1 From P. 470
	End lock cylinder	CA2W	Double acting, Double rod	
	Air-hydro type	CBA2 ⁽¹⁾	Double acting, Single rod	
	Smooth cylinder	CA2H	Double acting, Single rod	
CS1 ⁽²⁾	Air cylinder	CA2□Y	Double acting, Single rod	②-1 From P. 530
	Air-hydro type	CS1	Double acting, Single rod	
		CS1W	Double acting, Double rod	
		CS1H	Double acting, Single rod	

How to Order

CM2, CG1, MB, MB1, CA2, CS1,
CQS, CQ2, MU, CV

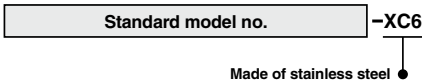

Series	Description	Model	Action	Vol. no. (for std model)
CQS	Compact cylinder	CQS	Double acting, Single rod Single acting (Spring return/extended)	②-1 From P. 693
		CQSW	Double acting, Double rod	
	Non-rotating rod type	CQSK	Double acting, Single rod	
	Lateral load resisting type	CQS□S	Double acting, Single rod	
CQ2	Compact cylinder	CQ2	Double acting, Single rod Single acting (Spring return/extended)	②-1 From P. 773
		CQ2W-Z	Double acting, Single rod	
	Axial piping type (Centralized piping type)	CQP2	Double acting, Single rod Single acting (Spring return/extended)	
	Long stroke	CQ2-Z	Double acting, Single rod	
	Lateral load resisting type	CQ2□S-Z	Double acting, Single rod	
	Water-resistant compact cylinder	CQ2□W-Z	Double acting, Single rod	
MU	Plate cylinder	CQP2□□	Double acting, Single rod	②-1 From P. 1036
		MU-Z	Double acting, Single rod	
CV	Valve mounted air cylinder	CVM5	Double acting, Single rod	②-3 From P. 771
		CVM5K	Double acting, Single rod	
		CV3	Double acting, Single rod	
		CVS1	Double acting, Single rod	
MGP	Compact guide cylinder	MGP-Z	Double acting	②-2 From P. 432
MGG	Guide cylinder	MGG	Double acting	②-2 From P. 538
MGC	Guide cylinder	MGC	Double acting	②-2 From P. 578
CXS	Dual rod cylinder	CXSM	Double acting	②-2 From P. 749
CXSJ	Dual rod cylinder compact type	CXSJM	Double acting	②-2 From P. 737
RHC	High power cylinder	RHC	Double acting	②-3 From P. 351

Note 1) Head side locking type only

Note 2) There is a maximum stroke limit for CA2, MB, MB1 (ø100) and CS1 cylinders.

Note 3) The CS2 series, made of stainless steel, is applicable as "-XC68".

Note 4) For the MB1 single rod and double rod, only ø125 is available.

Maximum Stroke

Series	Double acting, Single rod	Double acting single rod with rod boot
CA2, MB, MB1 (Bore size 100) Others same as the standard type	1500 (Same as standard)	1000
CS1	1200	1200

Specifications

Parts changed to stainless steel	Piston rod, Rod end nut
Specifications other than above and external dimensions	Same as standard

Note 1) In the case of CS1 cylinder, the piston rod is only made of stainless steel. Rod end nut is not attached.

Note 2) In the case of CQ cylinder, its snap ring and piston rod are made of stainless steel.

Rod end nut is also made of stainless steel for rod end male thread type.

CQ (P) 2^{1/2} series

Piston rod and rod end nut (male thread only) have been changed to stainless steel specification "-XC6". Also, the materials for hexagon socket head cap screws to fix $\phi 20$ to $\phi 32$ rod covers have been changed to stainless steel.

Applicable Series

Series	Model	Action	Note	Vol. no. (for std model)	
CQ2	Water-resistant compact cylinder	CQ2□ ^{1/2} -Z	Double acting, Single rod	Applicable to $\phi 20$, $\phi 25$, $\phi 32$.	②-1 From P. 949
	Water resistant, axial piping	CQP2□ ^{1/2}	Double acting, Single rod	Applicable to $\phi 32$.	②-1 From P. 893

Specifications

Parts changed to stainless steel	Piston rod, Rod end nut (male thread only), Rod cover holding hexagon socket head cap screw
----------------------------------	---

Specifications other than above and external dimensions	Same as standard
---	------------------

MGP series

Stainless Steel Modified Parts

XC6A	① ② ③ ④ ⑤ ⑥
XC6B	① ② ⑤ ⑥

Specifications and external dimensions other than above are the same as standard type.

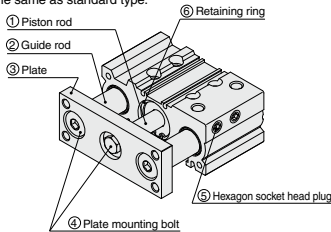

CXSJM series

How to Order

CXSJM [Standard model no.] -XC6

Made of stainless steel

Specifications

Parts changed to stainless steel	Piston rod, retaining ring, hexagon socket head bolt, hexagon socket head set screw, dumper bolt, hexagon nut
Specifications other than above and external dimensions	Same as standard

CXSM series

How to Order

CXSM [Standard model no.] -XC6

Made of stainless steel

Specifications

Parts changed to stainless steel	Piston rod, retaining ring, hexagon socket head bolt, hexagon socket head set screw, dumper bolt, hexagon nut, hexagon socket head plug
Specifications other than above and external dimensions	Same as standard

How to Order

C□Q2□^{1/2} R V [Standard model no.] -XC6A
C□QP2□^{1/2} R V

Stainless steel used on all standard iron parts

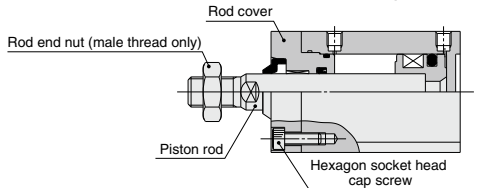

How to Order

MGP^M_L [Standard model no.] -XC6 A

Made of stainless steel

Suffix

A	Stainless steel used on all standard iron parts
B	Stainless steel rod parts

Dimensions

Bore size (mm)	XC6A (mm)			XC6B (mm)
	DA	FA	FB	
12	(6)	8	5	(6)
16	(8)	8	5	(8)
20	(10)	9	7	(10)
25	(10)	10	6	(10)
32	(14)	12	10	(14)
40	(14)	12	10	(14)
50	20	16	12	20
63	20	16	12	20
80	25	19	21	25
100	30	22	28	30

The dimensions in () are the same as standard type.

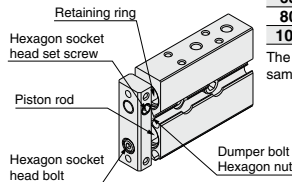

Note) The head cover retaining ring for $\phi 6$ is made of special steel.

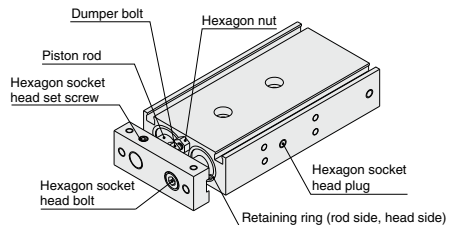

Made to Order Common Specifications: -XC6: Made of Stainless Steel



18 Made of Stainless Steel

Symbol
-XC6

Suitable for the cases it is likely to generate rust by being immersed in the water and corrosion.

MGG series How to Order

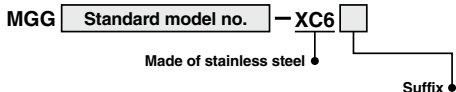

Nil	Piston rod, rod end nut made of stainless steel
A	Stainless steel used on all standard iron parts
B	Stainless steel rod end moving parts
C	Stainless steel rod parts

Parts Changed to Stainless Steel

Symbol	Basic cylinder	Guide unit
-XC6		—
-XC6A	CDG1Z \square N20 to 63- \square Z- -XC6 CDG1B \square N80 to 100- \square Z- -XC6 (Piston rod, Rod end nut)	Flange, Front plate, Rear plate, Ball bushing (MGG \square), Guide rod, End bracket, Flat washer, Spring washer, Type C retaining ring for hole, Adjustment bolt, Nut, Parallel pin, Hexagon socket head cap screw, Guide bolt
-XC6B		Front plate, Guide rod, End bracket, Flat washer, Spring washer, Parallel pin (for front plate), Guide bolt
-XC6C		Guide rod

* Specifications other than the above are the same as the standard type.
Note) RBL (coolant resistant) type shock absorbers are used for -XC6A.

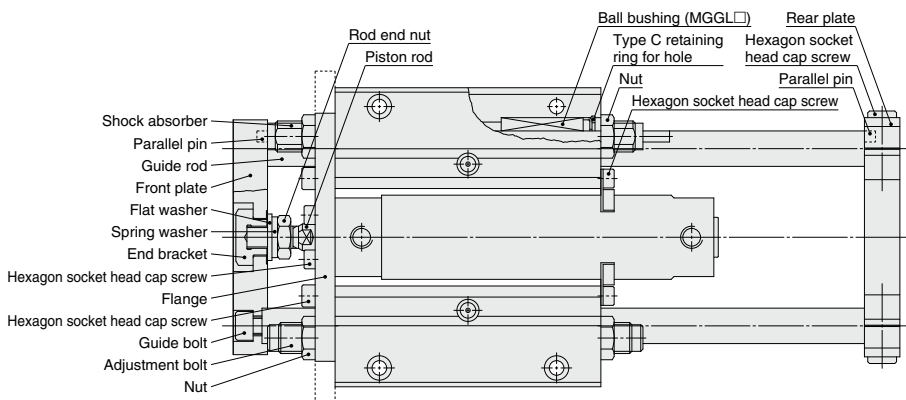

Dimensions (Dimensions other than below are the same as standard type.)

MGG \square B20 to 50- \square -XC6A

MGG \square B20 to 50- \square -XC6B
MGG \square B20 to 50- \square -XC6C

MGG \square F20 to 50- \square -XC6A
MGG \square F20 to 50- \square -XC6B
MGG \square F20 to 50- \square -XC6C

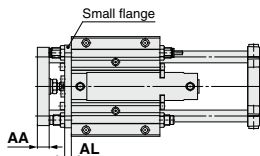

Bore size (mm)	(mm)	
	AA	AL
20	12	9
25	16	9
32	16	9
40	19	12
50	25	12

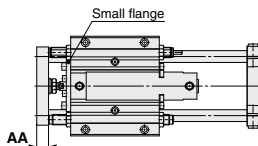

Bore size (mm)	(mm)
	AA
20	12
25	16
32	16
40	19
50	25

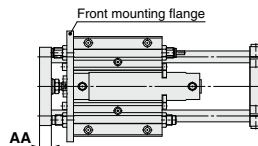

Bore size (mm)	(mm)
	AA
20	12
25	16
32	16
40	19
50	25

Made to Order Common Specifications: -XC6: Made of Stainless Steel



18 Made of Stainless Steel

Symbol
-XC6

Suitable for the cases it is likely to generate rust by being immersed in the water and corrosion.

MGC series How to Order

MGC Bearing type Mounting type Bore size Stroke Equipped/Not equipped back plate Auto switch C -XC6

Note) For the XC6A, XC6B, and XC6C, this symbol is displayed when the D-A9□ or M9□ type auto switch is specified. It does not apply to other auto switches (such as the D-C7□ and H7□). (Nil)

Made of stainless steel
Suffix

Nil	Piston rod, rod end nut made of stainless steel
A	Stainless steel used on all standard iron parts
B	Stainless steel rod end moving parts
C	Stainless steel rod parts

Parts Changed to Stainless Steel

Symbol	Basic cylinder	Guide unit
-XC6	CDG1ZA20 to 50-□-XC6 (Piston rod, Rod end nut)	—
-XC6A	CDG1BA20 to 50-□-X1057 (Piston rod, Rod end nut, Cushion valve)	Flange, Front plate, Rear plate, Ball bushing (MGCL□), Guide rod, End bracket, Flat washer, Spring washer, Type C retaining ring for hole, Hexagon socket head cap screw, Guide bolt
-XC6B		Front plate, Guide rod, End bracket, Flat washer, Spring washer, Guide bolt
-XC6C		Guide rod

* Specifications other than the above are the same as the standard type.

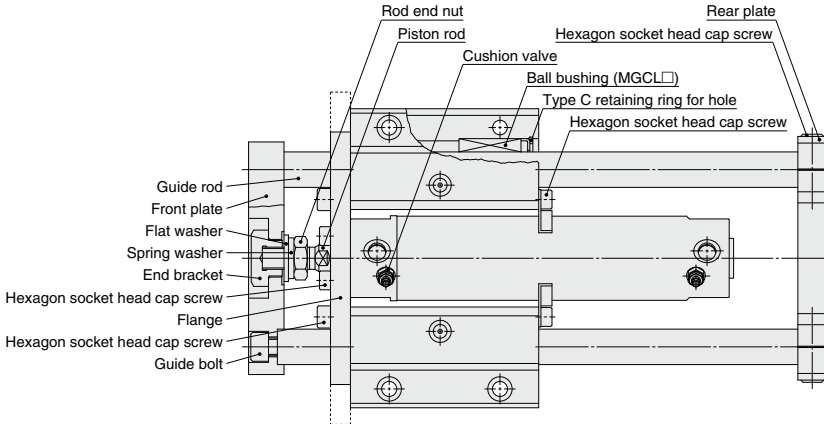

Dimensions (Dimensions other than below are the same as standard type.)

MGC□B20 to 50-□-XC6A

MGC□B20 to 50-□-XC6B

MGC□F20 to 50-□-XC6A

MGC□F20 to 50-□-XC6B

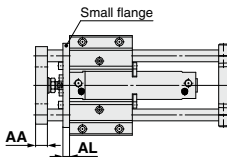

Bore size (mm)	(mm)	
	AA	AL
20	12	9
25	16	9
32	16	9
40	19	12
50	25	12

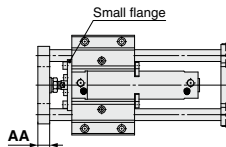

Bore size (mm)	(mm)
	AA
20	12
25	16
32	16
40	19
50	25

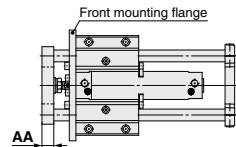

Bore size (mm)	(mm)
	AA
20	12
25	16
32	16
40	19
50	25

Made to Order Common Specifications: -XC7: Tie-rod, Cushion Valve, Tie-rod Nut, etc. Made of Stainless Steel



19 Tie-rod, Cushion Valve, Tie-rod Nut, etc. Made of Stainless Steel

Symbol

-XC7

When using in locations where the rust generation or corrosion likelihood exists, the standard parts material have been partly changed to the stainless steel.

Applicable Series

Series	Description	Model	Action	Note	Vol. no. (for std. model)
MB	Standard type	MB-Z	Double acting, Single rod	Except ø125	②-1 From P. 392
		MBW-Z	Double acting, Double rod	Except ø125	
	Non-rotating rod type	MBK-Z	Double acting, Single rod		
		MBKW-Z	Double acting, Double rod		
	Cylinder with end locke	MBB	Double acting, Single rod		
Smooth cylinder	MBY-Z	Double acting, Single rod			
MB1	Standard type	MB1-Z	Double acting, Single rod	Except ø125	②-1 From P. 440
		MB1W-Z	Double acting, Double rod	Except ø125	
	Non-rotating rod type	MB1K-Z	Double acting, Single rod		
CA2	Standard type	CA2-Z	Double acting, Single rod		②-1 From P. 470
		CA2W-Z	Double acting, Double rod		
	Non-rotating rod type	CA2K	Double acting, Single rod		
		CA2KW	Double acting, Double rod		
	End lock cylinder	CBA2	Double acting, Single rod		
	Smooth cylinder	CA2Y-Z	Double acting, Single rod		
CV	Valve mounted air cylinder	CV3	Double acting, Single rod		②-3 From P. 812
		CVS1	Double acting, Single rod		
		CV3K	Double acting, Single rod		
		CVS1K	Double acting, Single rod		

How to Order

Standard model no. **-XC7**

Tie-rod, Cushion valve, Tie-rod nut, etc. made of stainless steel

Specifications

Component parts changed to stainless steel	Tie-rod, Tie-rod nut, Mounting bracket nut, Spring washer, Cushion valve, Lock nut
Additional specifications	Same as standard type
Dimensions	Same as standard type

-XC

Made to Order Common Specifications: -XC8: Adjustable Stroke Cylinder/Adjustable Extension Type



20 Adjustable Stroke Cylinder/Adjustable Extension Type

It adjusts the extending stroke by the stroke adjustable mechanism equipped in the head side. (After the stroke is adjusted, with cushion on both sides is altered to single-sided, with cushion.)

Applicable Series

Series	Description	Model	Action	Note	Vol. no. (for std model)
CJ2	Air cylinder	CJ2-Z	Double acting	Except double clevis type and with air cushion	②-1 From P. 46
	Air cylinder	CM2-Z	Double acting	Except boss-cut and clevis types	
CM2	Non-rotating rod type	CM2K-Z	Double acting	Except boss-cut and clevis types	②-1 From P. 172
	Direct mount type	CM2R-Z	Double acting	Head cover is equipped with boss.	
	End lock cylinder	CBM2	Double acting	Except clevis type Head side locking type only, Except with air cushion	
	Air-hydro type	CM2H-Z	Double acting	Except clevis type	
	Direct mount type, air-hydro type	CM2HR-Z	Double acting	Head cover is equipped with boss.	
CG1	Air cylinder	CG1-Z	Double acting	Except head side flange and clevis types, ø80, and ø100	②-1 From P. 292
	Non-rotating rod type	CG1K-Z	Double acting	Except head side flange, clevis types and with air cushion	
	Direct mount type	CG1R-Z	Double acting	Except with air cushion	
	Direct mount, Non-rotating rod type	CG1KR-Z	Double acting	Except with air cushion	
MB	Air cylinder	MB-Z	Double acting	Except ø125, with rubber bumper, with auto switch, head side flange and clevis types	②-1 From P. 392
	Non-rotating rod type	MBK-Z	Double acting	Except ø125, with rubber bumper, with auto switch, head side flange and clevis types	
MB1	Air cylinder	MB1-Z	Double acting	Except ø125, with rubber bumper, with auto switch, head side flange and clevis types	②-1 From P. 440
	Non-rotating rod type	MB1K-Z	Double acting	Except head side flange and clevis types	
CA2	Air cylinder	CA2-Z	Double acting	Except head side flange and clevis types	②-1 From P. 470
	Non-rotating rod type	CA2K	Double acting	Except head side flange and clevis types	
	End lock cylinder	CBA2	Double acting	Except head side flange and clevis types, Locking in head side only	
CS1	Air cylinder	CS1	Double acting	Except head side flange and clevis types	②-1 From P. 530
	Air-hydro type	CS1H	Double acting	Except head side flange and clevis types	
CQS	Compact cylinder	CQS	Double acting	Except with rubber bumper and with mounting bracket	②-1 From P. 693
	Non-rotating rod	CQSK	Double acting	Except with rubber bumper and with mounting bracket	
	Compact cylinder	CQ2-Z	Double acting	Except with rubber bumper and with mounting bracket	
CQ2	Non-rotating rod type	CQ2K-Z	Double acting	Except with rubber bumper and with mounting bracket	②-1 From P. 773
	Air-hydro type	CQ2H-Z	Double acting	Except with mounting bracket	
MTS	Precision cylinder	MTS	Double acting		②-2 From P. 384
		MGPM-Z	Double acting		
MGP	Compact guide cylinder	MGPL-Z	Double acting		②-2 From P. 432
		MGPA-Z	Double acting		
MGG	Guide cylinder	MGG	Double acting		②-2 From P. 538
MGC	Guide cylinder	MGC	Double acting		②-2 From P. 578

How to Order

CJ2	Mounting type	Bore size	Stroke	Z - XC8				
CM2	Mounting type	Bore size	Stroke	Cushion	Rod end type symbol	Z - XC8	Stroke adjustment symbol	
CG1	Mounting type	Type	Bore size	Stroke	Rod end type symbol	Stroke adjustment symbol	Z - XC8	
CBM2	Mounting type	Bore size	Stroke	Stroke adjustment symbol	-H	Manual release type	Z - XC8	
CBA2	Mounting type	Bore size	Stroke	Suffix	Stroke adjustment symbol	Z - XC8		
MB	Mounting type	Bore size	Stroke	Suffix	Stroke adjustment symbol	Z - XC8		
MB1	* Except head side flange and clevis types							
CA2	Mounting type	Bore size	Stroke	Suffix	Stroke adjustment symbol	Z - XC8		
CA2K	Mounting type	Bore size	Stroke	Suffix	Stroke adjustment symbol	Z - XC8		
CA2K	* Except head side flange and clevis types							
CS1	Mounting type	Tubing material	Type	Bore size	Stroke	Suffix	Stroke adjustment symbol	Z - XC8
CS1	* Except head side flange and clevis types							
CQSB	Bore size	Stroke	D(M)	Z - XC8				
CQ2B(H)	Bore size	Stroke	D(M) (Z)	Z - XC8				
MTS	Bore size	Stroke	(R)	Z - XC8				
MGP	Bearing type	Bore size	Stroke	Stroke adjustment symbol	Z - XC8			
MGG	Bearing type	Mounting type	Bore size	Port thread type	Stroke	Stroke adjustment symbol	Z - XC8	
MGC	Bearing type	Mounting type	Bore size	Port thread type	Stroke	Stroke adjustment symbol	- Equipped/Not equipped back plate	Z - XC8

Adjustable stroke cylinder/Adjustable extend type

Made to Order Common Specifications: Adjustable Stroke Cylinder/Adjustable Extension Type

Symbol
-XC8

Specifications

Series	Stroke adjustment symbol	Stroke adjustment range (mm)
CJ2	—	0 to 15
CM2 CG1 MB MB1 CA2 CS1	A	0 to 25
	B	0 to 50

Note) Specifications other than above are the same as standard type.

Series	Stroke adjustment symbol	Stroke adjustment range (mm)
CQ2 CQS	—	0 to 10
MGG MGC	A	0 to 25
	B	0 to 50
MGP	A	0 to 10
	B	0 to 25
MTS	—	0 to 10 (ø8)
		0 to 25 (ø12 to ø40)

Precautions

⚠ Warning

- When the cylinder is operating, if something gets caught between the stopper bracket for adjusting the stroke and the cylinder body, it could cause bodily injury or damage the peripheral equipment. Therefore, take preventive measures as necessary, such as installing a protective cover.
- To adjust the stroke, make sure to secure the wrench flats of the stopper bracket by a wrench, etc. before loosening the lock nut. If the lock nut is loosened without securing the stopper bracket, be aware that the area that joins the load to the piston rod or the area in which the piston rod is joined with the load side and the stopper bracket side could loosen first. It may cause an accident or malfunction.

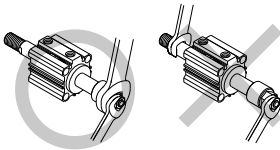

Symbol

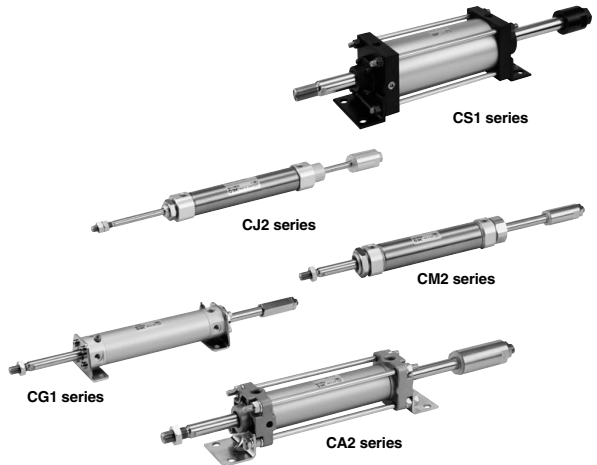
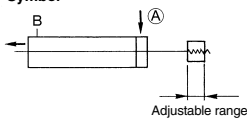

Made to Order Common Specifications: -XC8: Adjustable Stroke Cylinder/Adjustable Extension Type



20 Adjustable Stroke Cylinder/Adjustable Extension Type

Dimensions (Dimensions other than below are the same as standard type.)

CJ2 series

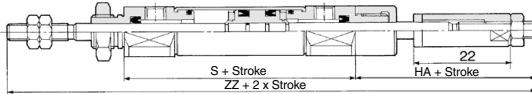

Bore size (mm)	HA	S	ZZ
10	37	49	114
16	37	50	115

CM2 series

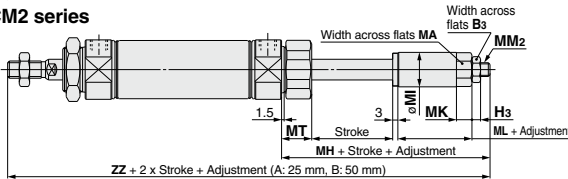

CM2 Series

Bore size (mm)	B ₃	H ₃	MA	MI	MK	MM ₂	MT	MH	ML	ZZ
20	10	3.6	12	14	7	M6 x 1	16.5	47	18	150
25	13	5	17	20	9	M8 x 1.25	17.5	49	18	156
32	13	5	17	20	9	M8 x 1.25	17.5	49	18	158
40	17	6	19	25	10	M10 x 1.25	21.5	60	24	198

CG1 series

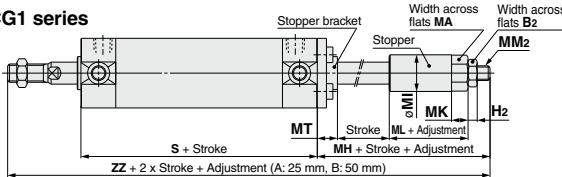

CG1 Series

Bore size (mm)	B ₂	H ₂	MA	MH	MI	MK	ML	MM ₂	MT	S	ZZ
20	10	3.6	12	38	14	7	18	M6 x 1	9	77	150
25	13	5	17	41	20	9	18	M8 x 1.25	11	77	158
32	13	5	17	41	20	9	18	M8 x 1.25	11	79	160
40	17	6	19	47	25	10	24	M10 x 1.25	11	87	184
50	19	8	24	60	32	13	32	M14 x 1.5	11	102	220
63	19	8	24	60	32	13	32	M14 x 1.5	13	102	220

* On the axial foot type, the foot bracket is wedged and bolted between the cylinder and the stopper bracket at the time of shipment. On other types, it is placed in the same package (not assembled).

CG1(K)R series

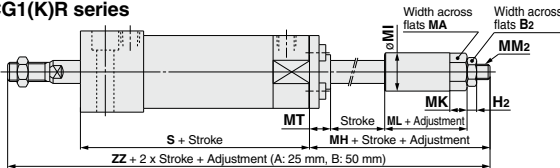

CG1(K)R Series

Bore size (mm)	B ₂	H ₂	MA	MH	MI	MK	ML	MM ₂	MT	S	ZZ
20	10	3.6	12	38	14	7	18	M6 x 1	9	83	148
25	13	5	17	41	20	9	18	M8 x 1.25	11	85	158
32	13	5	17	41	20	9	18	M8 x 1.25	11	91	164
40	17	6	19	47	25	10	24	M10 x 1.25	11	103	189
50	19	8	24	60	32	13	32	M14 x 1.5	11	120	225
63	19	8	24	60	32	13	32	M14 x 1.5	13	126	231

Made to Order Common Specifications: Adjustable Stroke Cylinder/Adjustable Extension Type

Symbol
-XC8

Dimensions (Dimensions other than below are the same as standard type.)

MB series

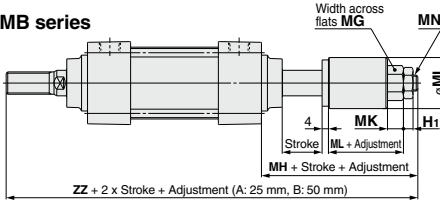

Bore size (mm)	MG	MH	MI	MK	ML	MN	ZZ
32	17	44	23	9	20	M8 x 1.25	175
40	19	48	32	10	22	M10 x 1.25	183
50	24	53	38	13	24	M14 x 1.5	205
63	24	53	38	13	24	M14 x 1.5	205
80	27	72	45	14	32	M16 x 1.5	258
100	32	75	55	17	35	M20 x 1.5	261

CA2 series

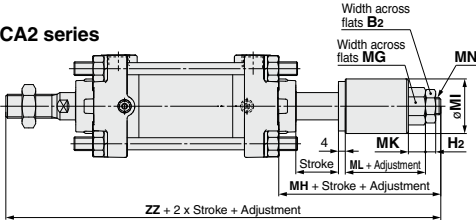

Bore size (mm)	H2	MG	MH	MI	MK	ML	MN	ZZ
40	6	19	45	32	10	22	M10 x 1.25	180
50	8	24	49	38	13	24	M14 x 1.5	197
63	8	24	49	38	13	24	M14 x 1.5	205
80	10	27	66	45	14	32	M16 x 1.5	253
100	12	32	69	55	17	35	M20 x 1.5	267

CS1 series

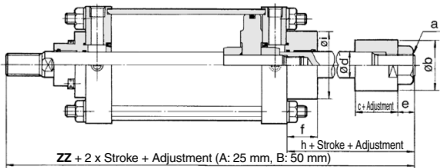

Bore size (mm)	a	ob	c	od	e	f	h	oi	ZZ
125	M30 x 1.5	70	43	36	27	40	110	90	318
140	M30 x 1.5	70	43	36	27	40	110	90	318
160	M30 x 1.5	70	43	36	27	40	110	90	336
180	M42 x 1.5	80	50	45	37.5	45	132.5	115	378.5*
200	M42 x 1.5	80	50	50	37.5	45	132.5	115	378.5*
250	M56 x 2	110	70	60	50	55	175	140	476
300	M56 x 2	110	70	70	50	55	175	140	496

* With auto switch ø180: 382.5, ø200: 387.5

CBM2 series (Only with head side locking)

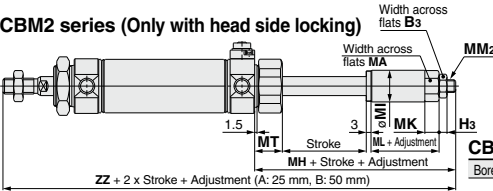

Bore size (mm)	B3	H3	MA	MI	MK	MM2	MT	MH	ML	ZZ
20	10	3.6	12	14	7	M6 x 1	16.5	47	18	150
25	13	5	17	20	9	M8 x 1.25	17.5	49	18	156
32	13	5	17	20	9	M8 x 1.25	17.5	49	18	158
40	17	6	19	25	10	M10 x 1.25	21.5	60	24	198

CBA2 series (Only with head side locking)

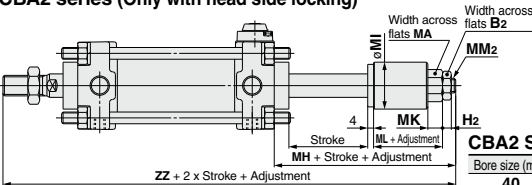

Bore size (mm)	B2	H2	MA	MI	MK	MM2	MH	ML	ZZ
40	17	6	19	32	10	M10 x 1.25	45	22	180
50	22	8	24	38	13	M14 x 1.5	51	24	199
63	22	8	24	38	13	M14 x 1.5	49	24	205
80	24	10	27	45	14	M16 x 1.5	66	32	253
100	30	12	32	55	17	M20 x 1.5	69	35	267

Made to Order Common Specifications: -XC8: Adjustable Stroke Cylinder/Adjustable Extension Type



20 Adjustable Stroke Cylinder/Adjustable Extension Type

Dimensions (Dimensions other than below are the same as standard type.)

MB1 series

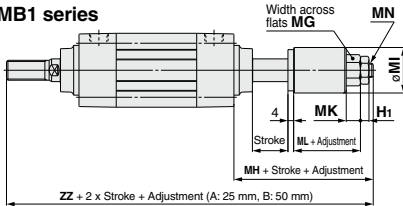

Bore size	MG	MH	MI	MK	ML	MN	(mm)	
32	17	44	23	9	20	M8 x 1.25	175	
40	19	48	32	10	22	M10 x 1.25	183	
50	24	53	38	13	24	M14 x 1.5	205	
63	24	53	38	13	24	M14 x 1.5	205	
80	27	72	45	14	32	M16 x 1.5	258	
100	32	75	55	17	35	M20 x 1.5	261	

CQ2, CQ2H series

ø12 to ø25

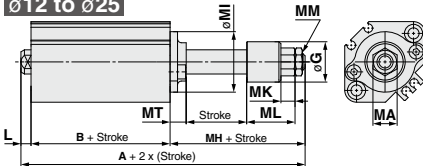

Bore size	A	B	L	MH	MT	MA	MI	MM	MK	ML	øG	Stroke adjustment range
12	57.7 (64.9)	25.2 (32.4)	3.5	29	5	8	□25 (ø15)	M4 x 0.7	5.5	20	14	5 to 30
16	58.5 (68.5)	26 (36)	3.5	29	5	10	□28 (ø20)	M5 x 0.8	5.5	20	14	5 to 30
20	67.5 (79.5)	26 (38)	4.5	37	8	12	□36 (ø25)	M6 x 1	7	24	20	5 to 50
25	71 (81)	29 (39)	5	37	8	12	□40 (ø30)	M6 x 1	7	24	20	5 to 50
32	78.5 (88.5)	30.5 (40.5)	7	41	6	17	ø38	M8 x 1.25	9	28.5	25	5 to 50 75-100
40	88 (98)	40 (50)	7	41	6	19	ø46	M10 x 1.25	10	27	25	5 to 50 75-100
50	100.5 (110.5)	40.5 (50.5)	8	52	8	24	ø57	M14 x 1.5	13	31	35	10 to 50 75-100
63	102 (112)	42 (52)	8	52	10	24	ø68	M14 x 1.5	13	31	35	10 to 50 75-100
80	125 (135)	51 (61)	10	64	12	32	ø90	M20 x 1.5	16	40	45	10 to 50 75-100
100	138.5 (148.5)	60.5 (70.5)	12	66	14	32	ø110	M20 x 1.5	16	40	45	10 to 50 75-100

ø32 to ø100

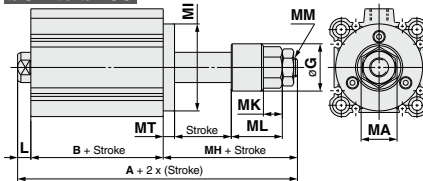

CQS series

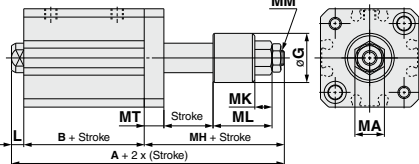

Note 1 () : Denotes the dimensions with auto switch.
Note 2) Applicable stroke available in 5 mm increments.

Bore size	A	B	L	MH	MT	MA	MI	MM	MK	ML	øG	Stroke adjustment range
12	56.1 (61.1)	22 (27)	3.5	30.6	5	8	M4 x 0.7	5.5	20	14		5 to 30
16	56.5 (61.5)	22 (27)	3.5	31	5	10	M5 x 0.8	5.5	20	14		5 to 30
20	67.5 (77.5)	26 (36)	4.5	37	8	12	M6 x 1	7	24	20		5 to 50
25	71 (81)	29 (39)	5	37	8	12	M6 x 1	7	24	20		5 to 50

Note 1 () : Denotes the dimensions with auto switch.
Note 2) Applicable stroke available in 5 mm increments.

MTS series

ø8

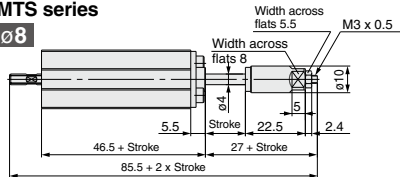

ø12 to ø40

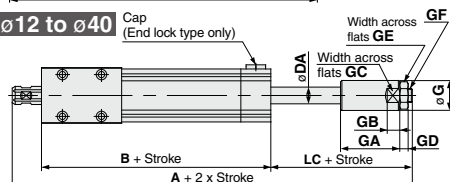

Basic Type

Bore size (mm)	A	B	LC	DA	G	GA	GB	GC	GD	GE	GF
12	145	80.5	49.5	6	13.5	42.5	6	11	4	8	M5 x 0.8
16	149.5	83	50.5	8	15.5	42.5	7	13	5	10	M6 x 1.0
20	175	106.5	50.5	10	19.5	42.5	8.5	17	5	13	M8 x 1.25
25	187	114.5	51.5	12	21.5	42.5	9	19	6	17	M10 x 1.25
32	222.5	142.5	56	16	27.5	45	10.5	24	8	22	M14 x 1.5
40	240	155	59	20	32.5	45	11.5	27	11	27	M18 x 1.5

With End Lock

Bore size (mm)	A	B
12	163	98.5
16	165.5	99
20	191.5	123
25	201.5	129
32	238.5	158.5
40	258.5	173.5

Made to Order Common Specifications: Adjustable Stroke Cylinder/Adjustable Extension Type

Symbol
-XC8

Dimensions (Dimensions other than below are the same as standard type.)

MGJ series ø20 to ø50

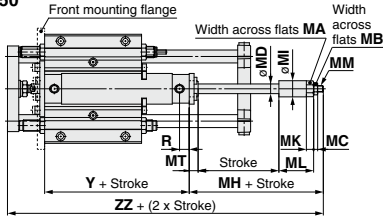

ø63

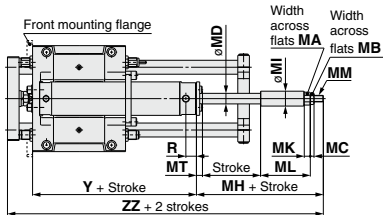

MGC series ø20 to ø50

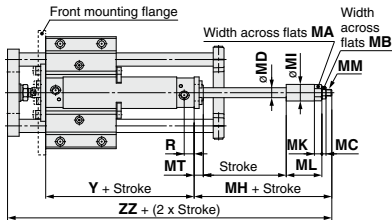

MGP series

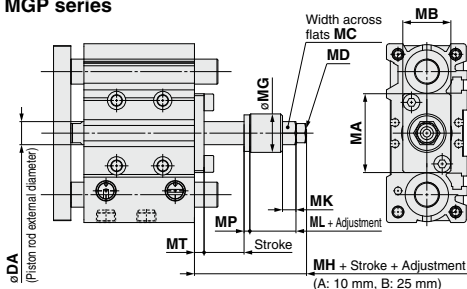

MGJ Series

Bore size (mm)	R	Y	MA	MB	MC	MD	MI	MK	MM	MT
20	12	77	12	10	3.6	8	14	7	M6 x 1	9
25	12	77	17	13	5	10	20	9	M8 x 1.25	11
32	12	79	17	13	5	12	20	9	M8 x 1.25	11
40	13	87	19	17	6	16	25	10	M10 x 1.25	11
50	14	102	24	19	8	20	32	13	M14 x 1.5	11
63	14	117	24	19	8	20	32	13	M14 x 1.5	13

Bore size (mm)	Adjustment 0 to 25 mm			Adjustment 0 to 50 mm		
	MH	ML	ZZ	MH	ML	ZZ
20	63	43	179	88	68	204
25	66	43	189	91	68	214
32	66	43	191	91	68	216
40	72	49	215	97	74	240
50	85	57	254	110	82	279
63	85	57	256	110	82	281

* The piston speed for the extension side is 50 to 500 mm/s.

MGC Series

Bore size (mm)	R	Y	MA	MB	MC	MD	MI	MK	MM	MT
20	12	77	12	10	3.6	8	14	7	M6 x 1	9
25	12	77	17	13	5	10	20	9	M8 x 1.25	11
32	12	79	17	13	5	12	20	9	M8 x 1.25	11
40	13	87	19	17	6	16	25	10	M10 x 1.25	11
50	14	102	24	19	8	20	32	13	M14 x 1.5	11

Bore size (mm)	Adjustment 0 to 25 mm			Adjustment 0 to 50 mm		
	MH	ML	ZZ	MH	ML	ZZ
20	63	43	179	88	68	204
25	66	43	189	91	68	214
32	66	43	191	91	68	216
40	72	49	215	97	74	240
50	85	57	254	110	82	279

* The piston speed for the extension side is 50 to 500 mm/s.

Common Dimensions: MGPM-Z, MGPL-Z, MGPA-Z

Bore size (mm)	DA	MA	MB	MC	MD	øMG	MH	MK	ML	MP	MT	CT
12	6	27	13	8	M4 x 0.7	14	20	5.5	10	3	3	3
16	8	28	16	10	M5 x 0.8	14	20	5.5	10	3	3	3
20	10	33	22	12	M6 x 1	20	26	7	14	3	4	4
25	12	41	25	12	M6 x 1	20	27	7	14	3	5	5
32	16	51	32	17	M8 x 1.25	25	35	9	18.5	4	6	6
40	16	60	32	19	M10 x 1.25	25	35	10	17	4	6	6
50	20	71	38	24	M14 x 1.5	35	46	13	21	4	8	8
63	20	84	50	24	M14 x 1.5	35	46	13	21	4	8	8
80	25	114	50	32	M20 x 1.5	45	55	16	30	4	9	9
100	30	140	65	32	M20 x 1.5	45	58	16	30	4	12	12



Made to Order Common Specifications: -XC9: Adjustable Stroke Cylinder/Adjustable Retraction Type



21 Adjustable Stroke Cylinder/Adjustable Retraction Type

The retract stroke of the cylinder can be adjusted by the adjustment bolt.

Applicable Series

Series	Description	Model	Action	Note	Vol. no. (for std model)
CJ2	Air cylinder	CJ2-Z	Double acting, Single rod	Except double clevis type and with air cushion	②-1 From P. 46
	Non-rotating rod	CJ2K-Z	Double acting, Single rod		
	Direct mount type	CJ2R-Z	Double acting, Single rod	Except double clevis type	
	Non-rotating rod/Direct mount type	CJ2RK-Z	Double acting, Single rod		
	Smooth cylinder	CJ2Y-Z	Double acting, Single rod		
CM2	Air cylinder	CM2-Z	Double acting, Single rod	Except boss-cut and clevis types	②-1 From P. 172
	Non-rotating rod	CM2K-Z	Double acting, Single rod		
	Direct mount type	CM2R-Z	Double acting, Single rod	Except the head cover with boss	
	Non-rotating rod/Direct mount type	CM2RK-Z	Double acting, Single rod	Except the head cover with boss	
	Smooth cylinder	CM2Y-Z	Double acting, Single rod	Except boss-cut and clevis types	
CG1	Air cylinder	CG1-Z	Double acting, Single rod	Except head side flange and clevis types, ø80, and ø100	②-1 From P. 292
	Non-rotating rod	CG1K-Z	Double acting, Single rod	Except head side flange, clevis types and with air cushion	
	Direct mount type	CG1R-Z	Double acting, Single rod	Except with air cushion	
	Non-rotating rod/Direct mount type	CG1KR-Z	Double acting	Except with air cushion	
MB	Air cylinder	MB-Z	Double acting, Single rod	Except ø125, with rubber bumper, with auto switch, head side flange and clevis types	②-1 From P. 392
	Non-rotating rod	MBK-Z	Double acting, Single rod	Except ø125, with rubber bumper, with auto switch, head side flange and clevis types	
MB1	Air cylinder	MB1-Z	Double acting, Single rod	Except ø125, with rubber bumper, with auto switch, head side flange and clevis types	②-1 From P. 440
	Non-rotating rod	MB1K-Z	Double acting, Single rod		
CA2	Air cylinder	CA2-Z	Double acting, Single rod	Except head side flange and clevis types	②-1 From P. 470
	Non-rotating rod	CA2K	Double acting, Single rod	Except head side flange and clevis types	
	End lock cylinder	CBA2	Double acting, Single rod	Except head side flange and clevis types	
CS1	Air cylinder	CS1	Double acting, Single rod	Except head side flange and clevis types, ø125 to ø160	②-1 From P. 530
	Non-rotating rod	CS2	Double acting, Single rod	Except head side flange and clevis types	
CS2	Air cylinder	CS2	Double acting, Single rod	Except head side flange and clevis types	②-1 From P. 568
	Smooth cylinder	CS2Y	Double acting, Single rod		
CQS	Compact cylinder	CQS	Double acting, Single rod	Except with rubber bumper and with mounting bracket	②-1 From P. 693
CQ2	Compact cylinder	CQ2-Z	Double acting, Single rod	Except with rubber bumper and with mounting bracket	②-1 From P. 773
	Non-rotating rod	CQ2K-Z	Double acting, Single rod		
MGP	Compact guide cylinder	MGPM-Z	Double acting		②-2 From P. 432
		MGPL-Z	Double acting		
		MGPA-Z	Double acting		
MGG	Guide cylinder	MGG	Double acting		②-2 From P. 538
MGC	Guide cylinder	MGC	Double acting		②-2 From P. 578

How to Order

CJ2	Mounting type	Bore size	Stroke	Z - XC9
	* Except clevis type			
CM2	Mounting type	Bore size	Stroke	Cushion
	* Except boss-cut and clevis types			
CM2R	Mounting type	Bore size	Stroke	Rod end type symbol
	* Except boss-cut and clevis types			
CG1	Mounting type	Type	Bore size	Stroke
	* Except clevis type			
MB	Mounting type	Bore size	Stroke	Suffix
MB1	Mounting type	Bore size	Stroke	Suffix
	* Except head side flange and clevis types			
CA2	Mounting type	Type	Bore size	Stroke
	* Except head side flange and clevis types			
CA2K	Mounting type	Type	Bore size	Stroke
	* Except head side flange and clevis types			
CBA2	Mounting type	Type	Bore size	Stroke
	* Except head side flange and clevis types			
CS1	Mounting type	Tubing material	Type	Bore size
	* Except head side flange and clevis types			
CS2	Mounting type	Bore size	Port suffix	Stroke
	* Except head side flange and clevis types			
CS2Y	Mounting type	Bore size	Port suffix	Stroke
	* Except head side flange and clevis types			
CQ2B	Bore size	Stroke	D (M)	Z
CQSB	Bore size	Stroke	D (M)	Z
MGP	Bearing type	Bore size	Stroke	Stroke adjustment symbol
MGG	Bearing type	Mounting type	Bore size	Port thread type
MGC	Bearing type	Mounting type	Bore size	Port thread type

Adjustable stroke cylinder/Adjustable retract type ●

(After adjusting stroke, both-side cushion type is changed into single side cushion type. CQ2 is without cushion.)

Made to Order Common Specifications: Adjustable Stroke Cylinder/Adjustable Retraction Type

Symbol
-XC9

Specifications

Series	Stroke adjustment symbol	Stroke adjustment range (mm)
CJ2	—	0 to 15
CM2 CG1 MB MB1 CA2 CS1 CS2	A	0 to 25
	B	0 to 50

Series	Stroke adjustment symbol	Stroke adjustment range (mm)
CQ2 CQS	—	0 to 10
MGP	A	0 to 10
	B	0 to 25
MGG MGC	A	0 to 25
	B	0 to 50

Note) Specifications other than above are the same as standard type.

Precautions

⚠ Caution

- When air is supplied to the cylinder, if the stroke adjustment bolt is loosened in excess of the allowable stroke adjustment amount, be aware that the stroke adjustment bolt could fly out or air could be discharged, which could injure personnel or damage the peripheral equipment.
- Adjust the stroke when the cylinder is not pressurized. If it is adjusted in the pressurized state, the seal of the adjustment section could become deformed, leading to air leakage.

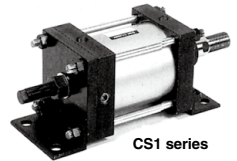

Symbol

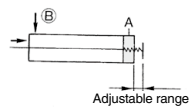

Dimensions (Dimensions other than below are the same as standard type.)

CJ2 series

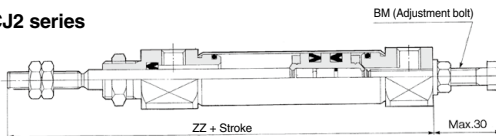

Bore size (mm)	(mm)	
	BM	ZZ
10	M5 x 0.8	74
16	M5 x 0.8	75

CM2 series

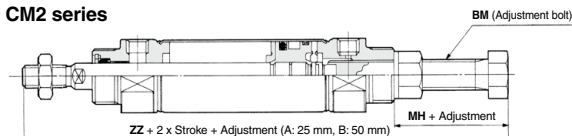

Bore size (mm)	(mm)		
	BM	MH	ZZ
20	M10 x 1.25	26.5	142.5
25	M14 x 1.5	29	149
32	M14 x 1.5	29	151
40	M16 x 1.5	32	186

Made to Order Common Specifications: -XC9: Adjustable Stroke Cylinder/Adjustable Retraction Type



21 Adjustable Stroke Cylinder/Adjustable Retraction Type

Dimensions (Dimensions other than below are the same as standard type.)

CM2R series

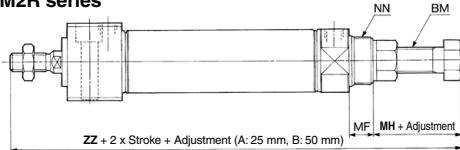

Bore size (mm)	BM	MF	MH	NN	ZZ
20	M10 x 12.5	13	26.5	M20 x 1.5	142.5
25	M14 x 1.5	13	29	M26 x 1.5	149
32	M14 x 1.5	13	29	M26 x 1.5	151
40	M16 x 1.5	16	32	M32 x 2	186

CG1 series

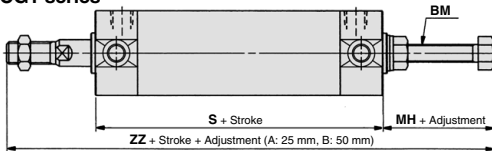

Bore size (mm)	BM	S	Rubber bumper		Air cushion	
			MH	ZZ	MH	ZZ
20	M6 x 1	77	23	135	21	133
25	M6 x 1	77	23	140	21	138
32	M8 x 1.25	79	25	144	25	144
40	M12 x 1.75	87	40	177	39	176
50	M12 x 1.75	102	33	193	37	197
63	M16 x 2	102	40	200	44	204

MB series

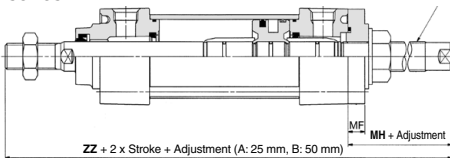

* In the case of axial foot type, the cushion is shipped after mounting. On other types, it is placed in the same package (not assembled).

* Dimensions other than above are the same as the CG1 series, long stroke type.

MB, MB1 Common

Bore size (mm)	b	c	d	ka	MM	ZZ
32	9	8	40	8	M12 x 1.25	171
40	9	8	39.5	8	M12 x 1.25	174.5
50	11	8	46	13	M16 x 1.5	198
63	11	8	52	17	M20 x 1.5	204
80	15	10	61	19	M24 x 1.5	247
100	15	10	61.5	19	M24 x 1.5	247.5

MB1 series

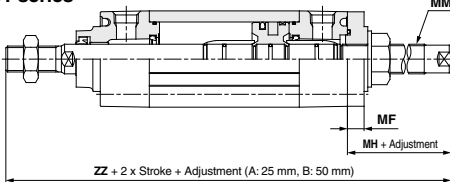

CA2

Bore size (mm)	b	c	d	ka	MM	ZZ
40	9	8	36	8	M12 x 1.25	171
50	11	8	42	13	M16 x 1.5	190
63	11	8	44	17	M20 x 1.5	200
80	15	10	54	19	M24 x 1.5	241
100	15	10	55.5	19	M24 x 1.5	253.5

CA2 series

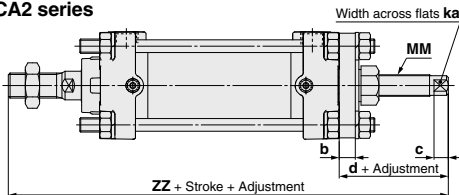

CA2K, CBA2 (With lock on rod side only)

Bore size (mm)	b	c	d	ka	MM	ZZ
40	9	8	44	11	M16 x 1.5	179
50	11	8	42	11	M16 x 1.5	190
63	11	8	48	14	M20 x 1.5	204
80	15	10	55	19	M24 x 1.5	242
100	15	10	57	19	M24 x 1.5	255

CS1 series

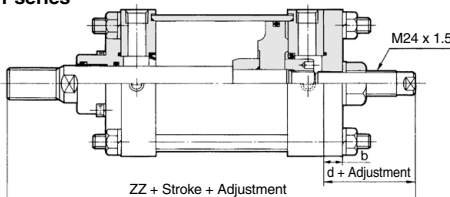

Bore size (mm)	b	d	ZZ
125	19	66	274
140	19	66	274
160	22	62	288

Made to Order Common Specifications: Adjustable Stroke Cylinder/Adjustable Retraction Type

Symbol
-XC9

Dimensions (Dimensions other than below are the same as standard type.)

CS2 series

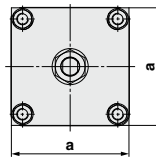
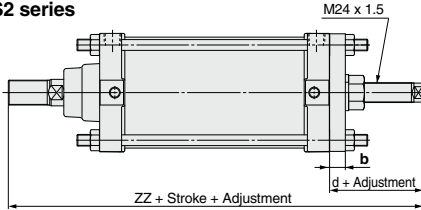

Bore size (mm)	a	b	d	ZZ
125	142	19	63	271
140	155	19	63	271
160	174	19	59	285

QCS series

ø12, ø16

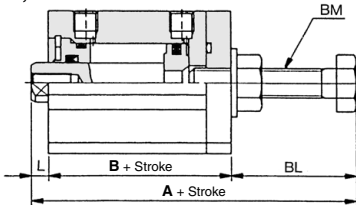

ø20, ø25

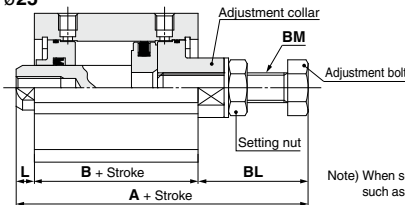

Bore size (mm)	A	B	L	BL	BM	Manufacturable stroke
12	50.5 (54.5)	22 (27)	3.5	25 (29)	M5 x 0.8	5 to 30
16	51 (56)	22 (27)	3.5	25.5	M6 x 1	
20	61 (71)	26 (36)	4.5	30.5	M8 x 1.25	5 to 50
25	63.5 (73.5)	29 (39)	5	29.5	M8 x 1.25	

Note 1) (): Denotes the dimensions with auto switch.
Note 2) Applicable stroke available in 5 mm increments.

Note) When securing the adjustment bolt, clamp the width across flats of the adjustment collar with a tool, such as a spanner and tighten the setting nut with a tool, such as other spanner to secure the bolt firmly.

CQ2 series

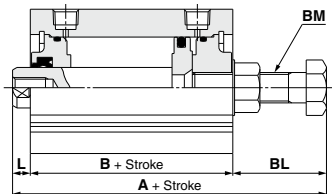

ø20, ø25, ø32

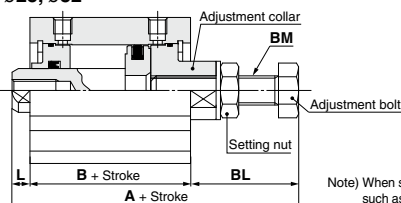

Bore size (mm)	A	B	L	BL	BM	Manufacturable stroke
12	52 (59.2)	25.2 (32.4)	3.5	23.3	M5 x 0.8	5 to 30
16	53 (63)	26 (36)	3.5	23.5	M6 x 1	
20	61 (73)	26 (36)	4.5	30.5	M8 x 1.25	5 to 50
25	63.5 (73.5)	29 (39)	5	29.5	M8 x 1.25	
32	65.5 (75.5)	30.5 (40.5)	7	28	M8 x 1.25	5 to 50
40	84 (94)	40 (50)	7	37	M12 x 1.5	75, 100
50	84.5 (94.5)	40.5 (50.5)	8	36	M12 x 1.5	
63	88.5 (98.5)	42 (52)	8	38.5	M16 x 1.5	10 to 50
80	109.5 (119.5)	51 (61)	10	48.5	M20 x 1.5	75, 100
100	125 (135)	60.5 (70.5)	12	52.5	M24 x 1.5	

Note 1) (): Denotes the dimensions with auto switch.
Note 2) Applicable stroke available in 5 mm increments.

Note) When securing the adjustment bolt, clamp the width across flats of the adjustment collar with a tool, such as a spanner and tighten the setting nut with a tool, such as other spanner to secure the bolt firmly.

Made to Order Common Specifications: -XC9: Adjustable Stroke Cylinder/Adjustable Retraction Type



21 Adjustable Stroke Cylinder/Adjustable Retraction Type

Symbol

-XC9

Dimensions (Dimensions other than below are the same as standard type.)

MGP series

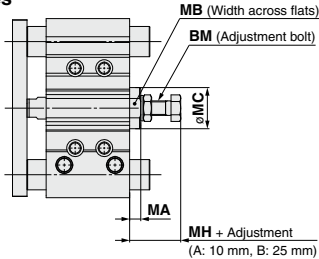

Common Dimensions: MGPM, MGPL, MGPA (mm)

Bore size (mm)	BM	MA	MB	MC	MH
12	M5 x 0.8	5	8	12.5	17
16	M6 x 1	5	10	14	19
20	M8 x 1.25	6.5	13	16	25
25	M8 x 1.25	6.5	13	16	24
32	M8 x 1.25	6.5	19	21	25
40	M12 x 1.5	9	27	30	32.5
50	M12 x 1.5	9	30	34	32.5
63	M16 x 1.5	10	36	40	37
80	M20 x 1.5	15	41	46	48.5
100	M24 x 1.5	18	46	52	55.5

MGG series ø20 to ø50

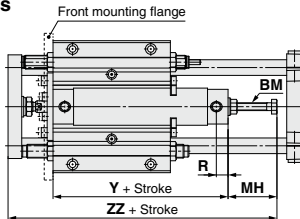

MGG Series (mm)

Bore size (mm)	R	Y	BM	Adjustment 0 to 25 mm		Adjustment 0 to 50 mm	
				MH	ZZ	MH	ZZ
20	12	77	M6 x 1	48	164	73	189
25	12	77	M6 x 1	48	171	73	196
32	12	79	M8 x 1.25	50	175	75	200
40	13	87	M12 x 1.75	65	208	90	233
50	14	102	M12 x 1.75	58	227	83	252
63	14	117	M16 x 2	65	236	90	261

* The piston speed for the retraction side is 50 to 500 mm/s.

ø63

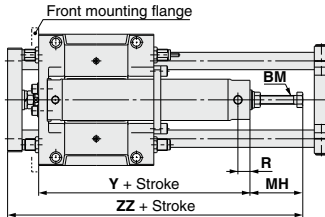

MGC series ø20 to ø50

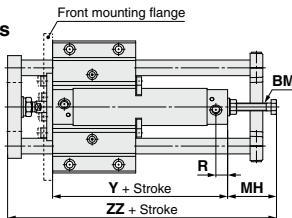

MGC Series (mm)

Bore size (mm)	R	Y	BM	Adjustment 0 to 25 mm		Adjustment 0 to 50 mm	
				MH	ZZ	MH	ZZ
20	12	77	M6 x 1	46	162	71	187
25	12	77	M6 x 1	46	169	71	194
32	12	79	M8 x 1.25	50	175	75	200
40	13	87	M12 x 1.75	64	207	89	232
50	14	102	M12 x 1.75	62	231	87	256

* The piston speed for the retraction side is 50 to 500 mm/s.

Made to Order Common Specifications: -XC10: Dual Stroke Cylinder/Double Rod Type



22 Dual Stroke Cylinder/Double Rod Type

Symbol
-XC10

Two cylinders are constructed as one cylinder in a back-to-back configuration allowing the cylinder stroke to be controlled in three steps.

Applicable Series

Series	Description	Model	Action	Note	Vol. no. (for std model)
CJ2	Air cylinder	CJ2-Z	Double acting, Single rod	Except with air cushion	②-1 From P. 46
	Non-rotating rod type	CJ2K-Z	Double acting, Single rod		
CM2	Air cylinder	CM2-Z	Double acting, Single rod	Except with air cushion	②-1 From P. 172
	Non-rotating rod type	CM2K-Z	Double acting, Single rod	Except with air cushion	
CG1	Smooth cylinder	CM2Y-Z	Double acting, Single rod		②-1 From P. 292
	Air cylinder	CG1-Z	Double acting, Single rod		
MB	Non-rotating rod type	CG1K-Z	Double acting, Single rod	Except with air cushion	②-1 From P. 392
	Air cylinder	MB-Z	Double acting, Single rod	* Except ø125, clevis and trunnion types	
MB1	Non-rotating rod type	MBK-Z	Double acting, Single rod	* Except clevis and trunnion types	②-1 From P. 440
	Air cylinder	MBB	Double acting, Single rod	* Except clevis and trunnion types	
CA2	Non-rotating rod type	MB1-Z	Double acting, Single rod	* Except ø125, clevis and trunnion types	②-1 From P. 470
	Air cylinder	MB1K-Z	Double acting, Single rod	* Except clevis and trunnion types	
CS1	Non-rotating rod type	CA2-Z	Double acting, Single rod	* Except clevis and trunnion types	②-1 From P. 530
	Air cylinder	CA2K	Double acting, Single rod	* Except clevis and trunnion types	
CS2	End lock cylinder	CA2K	Double acting, Single rod	* Except clevis and trunnion types	②-1 From P. 568
	Air cylinder	CBA2	Double acting, Single rod	* Except clevis and trunnion types	
CQS	Air-hydro cylinder	CS1	Double acting, Single rod	* Except clevis and trunnion types	②-1 From P. 693
	Smooth cylinder	CS1H	Double acting, Single rod	* Except clevis and trunnion types	
CQ2	Compact cylinder	CS2	Double acting, Single rod	* Except clevis and trunnion types	②-1 From P. 773
	Air-hydro cylinder	CS2Y	Double acting, Single rod	* Except clevis and trunnion types	
CQ2B	Compact cylinder	CQS	Double acting, Single rod	Except with bracket	②-1 From P. 693
	Air-hydro cylinder	CQ2-Z	Double acting, Single rod	Except with bracket	
CQ2B	Compact cylinder	CQ2-Z	Double acting, Single rod	Except with bracket	②-1 From P. 773
	Air-hydro cylinder	CQ2H-Z	Double acting, Single rod	Except with bracket	

How to Order

CJ2	Mounting type	Bore size	-	Stroke A	+	Stroke B	Z	-	XC10		
CM2	Mounting type	Bore size	-	Stroke A	Suffix	+	Stroke B	Suffix	Z - XC10		
CG1	Mounting type	Type	Bore size	-	Stroke A	Suffix	+	Stroke B	Suffix	Z - XC10	
MB	Mounting type	Bore size	-	Stroke A	Suffix	+	Stroke B	Suffix	Z - XC10		
MB1	* Except clevis and trunnion types										
MBB	Mounting type	Bore size	-	Stroke A	Suffix	-	Lock position	Manual release type	+		
	Stroke B	Suffix	-	Lock position	Symbol of manual release	XC10					
	* Except clevis and trunnion types										
CA2	Mounting type	Type	Bore size	-	Stroke A	Suffix	+	Stroke B	Suffix	Z - XC10	
	* Except clevis and trunnion types										
CA2K	Mounting type	Type	Bore size	-	Stroke A	Suffix	+	Stroke B	Suffix	- XC10	
	* Except clevis and trunnion types										
CBA2	Mounting type	Type	Bore size	-	Stroke A	Suffix	-	Lock position	Manual release type	+	
	Stroke B	Suffix	-	Lock position	Symbol of manual release	XC10					
	* Except clevis and trunnion types										
CS1	Mounting type	Tubing material	Type	Bore size	-	Stroke A	Suffix	+	Stroke B	Suffix	- XC10
	* Except clevis and trunnion types										
CS2	Mounting type	Bore size	Port suffix	-	Stroke A	Suffix	+	Stroke B	Suffix	- XC10	
	* Except clevis and trunnion types										
CQ2B	Bore size	-	Stroke S ₁	+	Stroke S ₂	D (C)(M)(Z)	XC10				
CQSB	Bore size	-	Stroke S ₁	+	Stroke S ₂	D (C)(M)	XC10				

Dual stroke cylinder



Made to Order Common Specifications: -XC10: Dual Stroke Cylinder/Double Rod Type



22 Dual Stroke Cylinder/Double Rod Type

Specifications

Series	Bore size (mm)	Maximum manufacturable stroke (mm)
CJ2	10, 16	300 (Maximum 150 on one side)
CM2	20 to 40	1000 (A + B stroke)
CG1	20	1500 (A + B stroke)
	25	1500 (A + B stroke)
	32	1500 (A + B stroke)
	40	1500 (A + B stroke)
	50, 63	1500 (A + B stroke)
MB MB1	32 to 100	1000 (A + B stroke)

* Specifications other than above are the same as standard type.

Series	Bore size (mm)	Maximum manufacturable stroke (mm)
CA2	40 to 100	1000 (A + B stroke)
CS1	125, 140	1000 (A + B stroke)
	160 to 300	1200 (A + B stroke)
CS2	125, 140	1000 (A + B stroke)
	160	1200 (A + B stroke)
CQS CQ2	12, 16	60 (Maximum 30 on one side)
	20, 25	100 (Maximum 50 on one side)
CQ2	32, 40	200 (Maximum 100 on one side)
	50 to 100	200 (Maximum 100 on one side)

Symbol

Function



When air pressure is supplied to ports **A** and **B**, both A and B strokes retract.



When air pressure is supplied to ports **B** and **C**, A out strokes.



When air pressure is supplied to ports **A** and **B**, B out strokes.



When air pressure is supplied to ports **C** and **B**, both strokes A and B out strokes.



CJ2 series

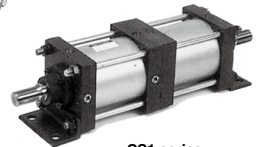

CS1 series



CG1 series



CA2 series

Dimensions (Dimensions other than below are the same as standard type.)

CJ2 series

Bore size (mm)	NB	S	Z
10	21	36.5	150
16	21	37.5	152

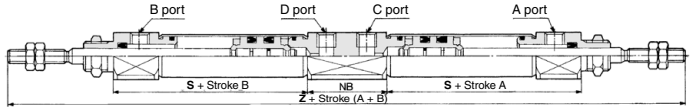

CM2 series

Bore size (mm)	GC	GD	SA	SB	ZZ
20	7	24	47	78	207
25	7	24	47	78	215
32	7	24	49	80	219
40	10.5	33.5	66.5	110.5	277

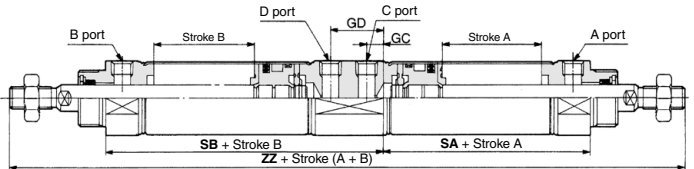

CG1 series

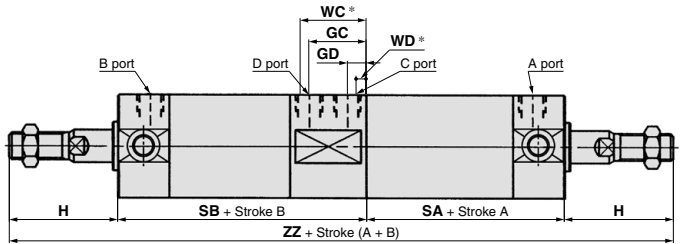
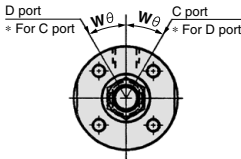

Bore size	GC	GD	H	SA	SB	Wθ	Air cushion		
							WC	WD	ZZ
20	20.5 (21)	8.5 (9)	35	56.5 (56)	85.5 (86)	30°	(25)	(5)	212
25	21 (21.5)	9 (8.5)	40	56	86	30°	(25)	(5)	222
32	23	9	40	58	90	30°	(27)	(5)	228
40	23.5 (25)	7.5 (9)	50	66.5 (65)	97.5 (99)	20°	(29)	(5)	264
50	29	13	58	75	117	20°	(32)	(9)	308
63	28	12	58	76	116 (116)	20°	(32)	(8)	308

* (): With air cushion

MB series

Bore size	GC	NA	NB	S	ZZ
32	36	64	10.6	178	272
40	38	64	10.6	178	280
50	41	73	10.6	198	314
63	43	73	10.6	198	314
80	52	90	14.6	242	386
100	52	90	14.6	242	386

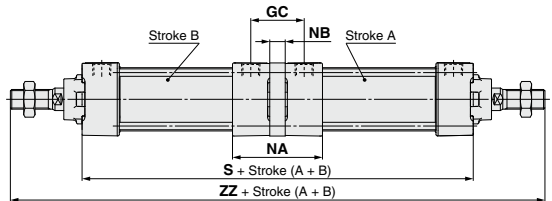

MB1 series

Bore size	GC	NA	NB	S	ZZ
32	36	62	10.6	178	272
40	38	62	10.6	178	280
50	41	71	10.6	198	314
63	43	71	10.6	198	314
80	52	88	14.6	242	386
100	52	88	14.6	242	386

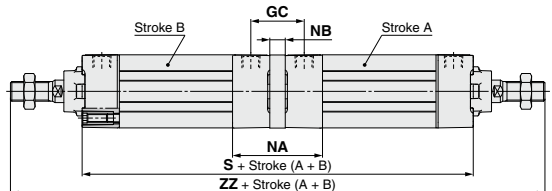

Made to Order Common Specifications: -XC10: Dual Stroke Cylinder/Double Rod Type



22 Dual Stroke Cylinder/Double Rod Type

Dimensions (Dimensions other than below are the same as standard type.)

CA2 series

Bore size	GB	Q	S	ZZ
40	29	53	167	269
50	33	59	179	295
63	33	61	195	311
80	41	73	231	373
100	41	79	251	395

(mm)

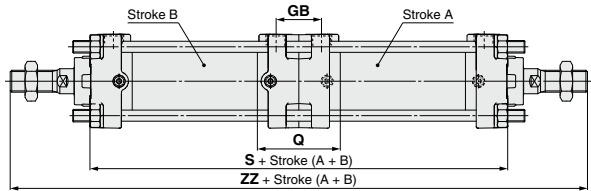

CBA2 series

Bore size (mm)	GC	L	Q	S	ZZ
40	42	12	66	180	282
50	48	14	74	194	310
63	48	14	76	210	326
80	58	16	90	248	390
100	60	18	98	270	414

(mm)

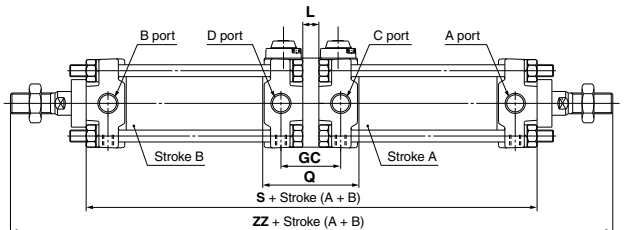

* The above diagram shows head side lock type and manual releasing non-locking type. Dimensions of rod side locking type, both-side lock type and manual releasing lock type are the same as dimensions in the above table.

CS1 series

Bore size (mm)	Without auto switch		With auto switch	
	S	ZZ	S	ZZ
125	196	416	196	416
140	196	416	196	416
160	212	452	212	452
180	222	492	230	500
200	222	492	240	510
250	282	602	—	—
300	292	642	—	—

(mm)

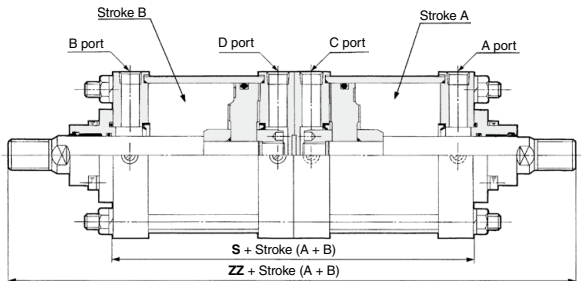

CS2 series

Bore size (mm)	S	ZZ
125	196	416
140	196	416
160	212	452

(mm)

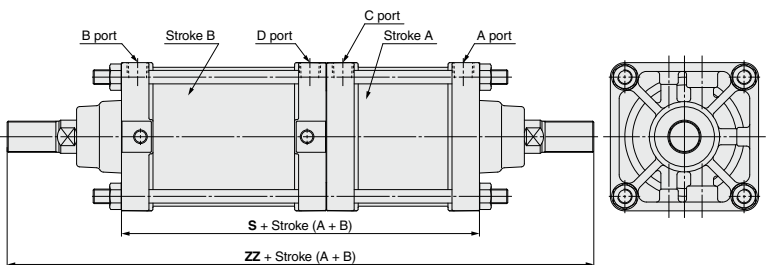

* For rod side flange type "F", the flange bracket will be attached to the stroke A side.

Construction/Dimensions (Other dimensions are the same as standard.)

CQ2 series

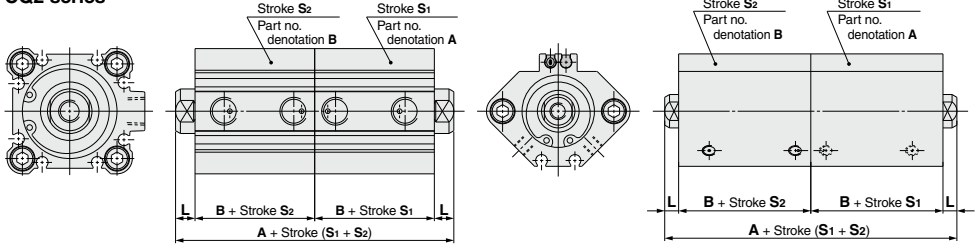

Note) In the case of bore sizes $\phi 12$ to $\phi 25$ with auto switch, port directions are different. (mm)

Bore size (mm)	A			B		L	Stroke Both of S ₁ , S ₂
	50 st or less for both of S ₁ , S ₂	Combination of 50 st or less, 75, 100 st	75, 100 st for both of S ₁ , S ₂	50 st or less	75, 100 st		
12	41 (63)	—	—	17 (28)	—	3.5	5 to 30
16	44 (68)	—	—	18.5 (30.5)	—	3.5	
20	48 (72)	—	—	19.5 (31.5)	—	4.5	5 to 50
25	55 (75)	—	—	22.5 (32.5)	—	5	
32	60 (80)	70 (80)	80 (80)	23 (33)	33 (33)	7	5 to 100
40	73 (93)	83 (93)	93 (93)	29.5 (39.5)	39.5 (39.5)	7	
50	77 (97)	87 (97)	97 (97)	30.5 (40.5)	40.5 (40.5)	8	10 to 100
63	88 (108)	98 (108)	108 (108)	36 (46)	46 (46)	8	
80	107 (127)	117 (127)	127 (127)	43.5 (53.5)	53.5 (53.5)	10	
100	130 (150)	140 (150)	150 (150)	53 (63)	63 (63)	12	

Note 1) (): Denotes the dimensions with auto switch.
Note 2) Applicable stroke available in 5 mm increments.

CQS series

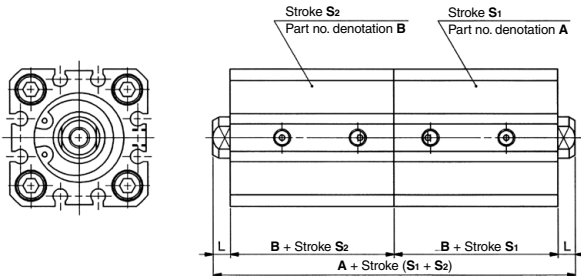

(mm)

Bore size (mm)	A	B	L	Stroke Both of S ₁ , S ₂
12	41 (51)	17 (22)	3.5	5 to 30
16	41 (51)	17 (22)	3.5	
20	48 (68)	19.5 (29.5)	4.5	5 to 50
25	55 (75)	22.5 (32.5)	5	

Note 1) (): Denotes the dimensions with auto switch.
Note 2) Applicable stroke available in 5 mm increments.

Made to Order Common Specifications: -XC11: Dual Stroke Cylinder/Single Rod Type



23 Dual Stroke Cylinder/Single Rod Type

Two cylinders can be integrated by connecting them in line, and the cylinder stroke can be controlled in two stages in both directions.
Do not operate the CS1 series at twice the output.

Applicable Series

Series	Description	Model	Action	Note	Vol. no. (for std model)
CJ2	Air cylinder	CJ2-Z	Double acting, Single rod	Except with air cushion	②-1 From P. 46
	Air cylinder	CM2-Z	Double acting, Single rod		
CM2	Non-rotating rod	CM2K-Z	Double acting, Single rod		②-1 From P. 172
	Direct mount	CM2R-Z	Double acting, Single rod		
	Non-rotating rod, Direct mount type	CM2RK-Z	Double acting, Single rod		
CG1	Air cylinder	CG1-Z	Double acting, Single rod	Except with air cushion	②-1 From P. 292
	Non-rotating rod	CG1K-Z	Double acting, Single rod		
MB	Air cylinder	MB-Z	Double acting, Single rod	* Except ø125 and trunnion type	②-1 From P. 392
MB1	Air cylinder	MB1-Z	Double acting, Single rod	* Except ø125 and trunnion type	②-1 From P. 440
CA2	Air cylinder	CA2-Z	Double acting, Single rod	* Except trunnion type	②-1 From P. 470
	Non-rotating rod	CA2K	Double acting, Single rod	* Except trunnion type	
CS1	Air cylinder	CS1	Double acting, Single rod	* Except trunnion type	②-1 From P. 530
CS2	Air cylinder	CS2	Double acting, Single rod	* Except trunnion type	②-1 From P. 568
CQS	Compact cylinder	CQS	Double acting, Single rod	Except with bracket	②-1 From P. 693
CQ2	Compact cylinder	CQ2-Z	Double acting, Single rod	Except with bracket	②-1 From P. 773
	Air-hydro cylinder	CQ2H-Z	Double acting, Single rod	Except with bracket	
CNA2	Cylinder with lock	CNA2	Double acting, Single rod	* Except trunnion type	②-2 From P. 922
MGG	Guide cylinder	MGG	Double acting		②-2 From P. 538
MGC	Guide cylinder	MGC	Double acting		②-2 From P. 578

How to Order

CJ2	Mounting type	Bore size	-	Stroke A	+	Stroke B-A	Z - XC11		
CM2	Mounting type	Bore size	-	Stroke A	+	Stroke B-A	Suffix Z - XC11		
CG1	Mounting type	Type	Bore size	-	Stroke A	+	Stroke B-A	Suffix Z - XC11	
MB MB1	Mounting type	Bore size	-	Stroke A	Suffix	+	Stroke B-A	Suffix Z - XC11	
* Except trunnion type									
CA2	Mounting type	Type	Bore size	-	Stroke A	Suffix	+	Stroke B-A	Suffix Z - XC11
* Except trunnion type									
CA2K	Mounting type	Type	Bore size	-	Stroke A	Suffix	+	Stroke B-A	Suffix - XC11
* Except trunnion type									
CS1	Mounting type	Tubing material	Bore size	-	Stroke A	Suffix	+	Stroke B-A	Suffix - XC11
* Except trunnion type									
CS2	Mounting type	Bore size	Port suffix	-	Stroke A	Suffix	+	Stroke B-A	Suffix - XC11
* Except trunnion type									
CQSB	Bore size	-	Stroke S ₁	+	Stroke S ₂ -S ₁	D(C)(M) - XC11			
CQ2B	Bore size	-	Stroke S ₁	+	Stroke S ₂ -S ₁	D(C)(M)(Z) - XC11			
CNA2	Mounting type	Type	Bore size	-	Stroke A	Suffix	+	Stroke B-A	Suffix - D - XC11
Dual stroke cylinder/Single rod ↓									

Specifications: Same as standard type (Please contact SMC for each manufacturable stroke length.)

Functional description of dual stroke cylinder

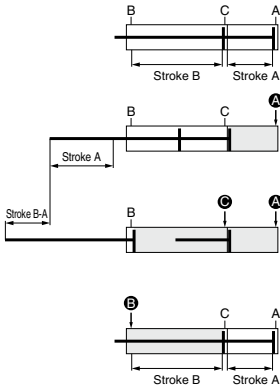

- 1) Initial state
(0 stroke position)
- 2) 1st stage Stroke A operation
When the air pressure is supplied from the A port, the rod operates the stroke A.
- 3) 2nd stage Stroke B-A operation
Following the 1st stage, when the air pressure is supplied from the C port, the rod operates the stroke B-A.
- 4) Cylinder retraction
When the air pressure is supplied from the B port, the rod retracts completely.



Precautions

⚠ Caution

1. Do not supply air until the cylinder is fixed with the attached bolt.
2. If air is supplied without securing the cylinder, the cylinder could lurch, posing the risk of bodily injury or damage to the peripheral equipment.

Stroke A or stroke B operation can be made individually.

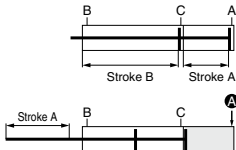

Stroke A operation

- 1) Initial state
(0 stroke position)
- 2) Operation
When the air pressure is supplied from the A port, the rod operates the stroke A.

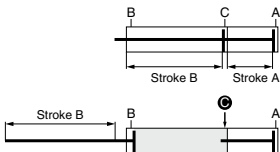

Stroke B operation

- 1) Initial state
(0 stroke position)
- 2) Operation
When the air pressure is supplied from the C port, the rod operates the stroke B.

Double output is possible.

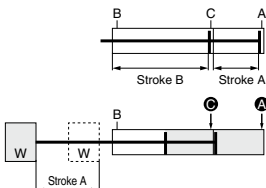

- 1) Initial state
(0 stroke position)
- 2) Double output
When the air pressure is supplied to the A and C ports at the same time, the double output can be obtained in the stroke A range.

Made to Order Common Specifications: -XC11: Dual Stroke Cylinder/Single Rod Type



23 Dual Stroke Cylinder/Single Rod Type

Dimensions (Dimensions other than below are the same as standard type.)

CJ2 series

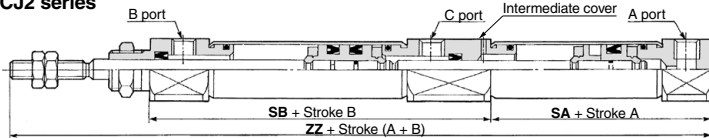

(mm)			
Bore size (mm)	SA	SB	Z
10	31	53.5	112.5
16	31.5	54.5	114

Note) When mounting an auto switch at the extended piston rod A side, the following auto switches interfere with the intermediate cover. In this case, please mount on the stroke B side. Please be aware that the auto switch defects and temporarily turns ON/OFF when passing the intermediate position of the B stroke.

Solid state auto switch : D-H7□, D-H7C, D-H7□W, D-H7NF, D-H7BA

Reed auto switch : D-C7□, D-C80, D-C73C, D-C80C, D-A80, D-A9□, D-A9□V, D-A79W, D-A73

CM2 series

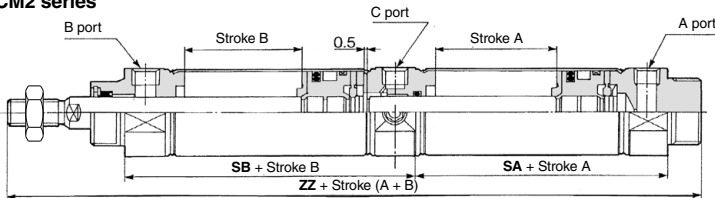

(mm)			
Bore size (mm)	SA	SB	ZZ
20	48	62	164
25	48	62	168
32	50	64	172
40	67.5	88.5	222

CM2R series

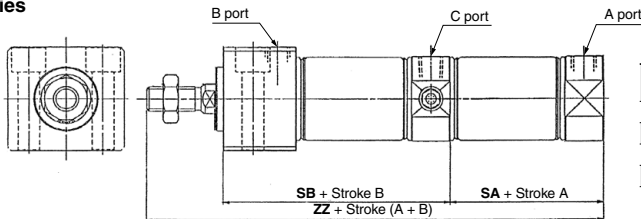

(mm)			
Bore size (mm)	SA	SB	ZZ
20	48	76	151
25	48	76	155
32	50	78	159
40	67.5	104.5	206

CG1 series

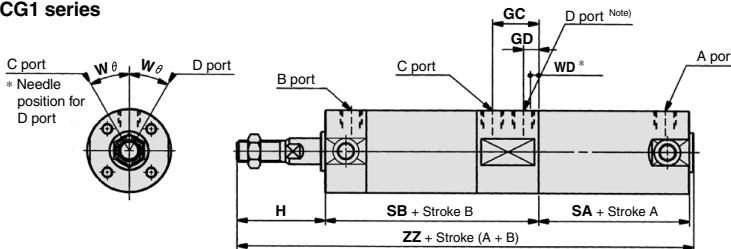

Note) D port type Type N: Rubber bumper, Plug with fixed orifice;

Type A: Air cushion, element non-installation (Release to atmospheric pressure)

CG1, CG1K

(mm)										
Bore size	GC	GD	H	SA	SB	Wθ	ZZ	Air cushion		Long stroke
								WD	SA	ZZ
20	21	9	35	48	87	30°	172	5	56	180
25	21 (21.5)	9 (8.5)	40	48	87	30°	177	6.5	56	185
32	23	9	40	50	91	30°	183	5	58	191
40	25	9	50	56	100	20°	208	5	65	217
50	29	13	58	63	118	20°	241	9	75	253
63	28	12	58	64	117	20°	241	8	76	253

* () : With air cushion

Note) When the stroke A is a long stroke (ø20: 201 mm or more, ø25 to ø63: 301 mm or more)

Construction/Dimensions

MB series

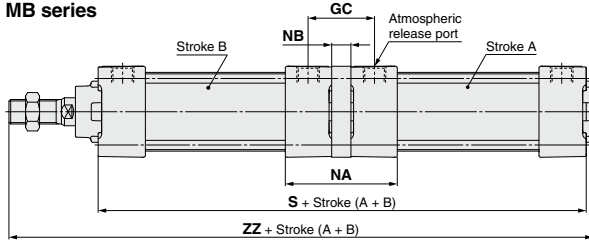

(mm)					
Bore size	GC	NA	NB	S	ZZ
32	36	64	10.6	179	230
40	38	64	10.6	179	234
50	41	73	10.6	199	261
63	43	73	10.6	199	261
80	52	90	14.6	243	319
100	52	90	14.6	243	319

MB1 series

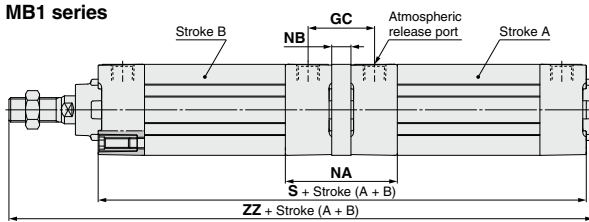

(mm)					
Bore size	GC	NA	NB	S	ZZ
32	36	62	10.6	179	230
40	38	62	10.6	179	234
50	41	71	10.6	199	261
63	43	71	10.6	199	261
80	52	88	14.6	243	319
100	52	88	14.6	243	319

CA2 series

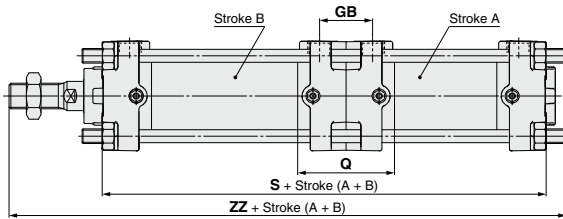

(mm)				
Bore size	GB	Q	S	ZZ
40	29	53	168	230
50	33	59	180	249
63	33	61	196	268
80	41	73	232	320
100	41	79	252	341

CNA2 series

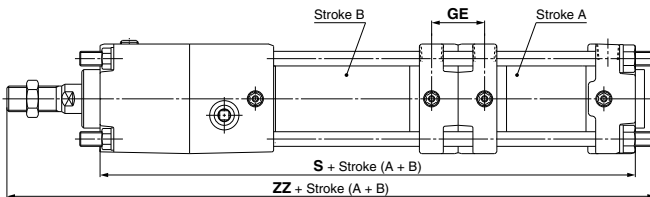

(mm)			
Bore size	GE	S	ZZ
40	29	237	299
50	33	258	327
63	33	280	352
80	41	334	422
100	41	372	461

Made to Order Common Specifications: -XC11: Dual Stroke Cylinder/Single Rod Type



23 Dual Stroke Cylinder/Single Rod Type

Construction/Dimensions

CS1 series

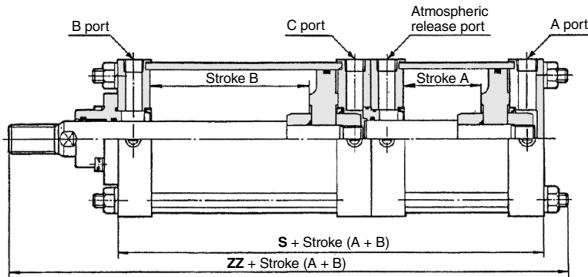

Bore size (mm)	Without auto switch		With auto switch	
	S	ZZ	S	ZZ
125	197	334	197	334
140	197	334	197	334
160	213	363.5	213	363.5
180	223	393	231	401
200	223	393	241	411
250	283	484.5	—	—
300	293	519.5	—	—

CS2 series

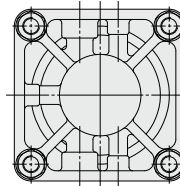
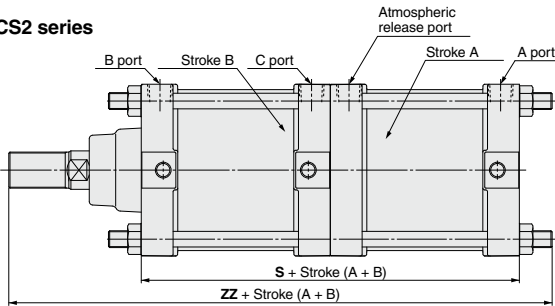

Bore size (mm)		
	S	ZZ
125	197	334
140	197	334
160	213	363.5

CQS series

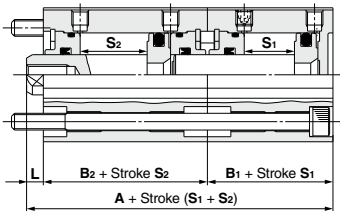

Bore size (mm)	A	B ₁	B ₂	L	Stroke Both of S ₁ , S ₂
	12	42.5 (52.5)	17 (22)	22 (27)	
16	42.5 (52.5)	17 (22)	22 (27)	3.5	
20	50 (70)	19.5 (29.5)	26 (36)	4.5	
25	56.5 (76.5)	22.5 (32.5)	29 (39)	5	

Note 1) (): Denotes the dimensions with auto switch.
 Note 2) Applicable stroke available in 5 mm increments.
 Note 3) Please contact SMC for long stroke type.

CQ2 series

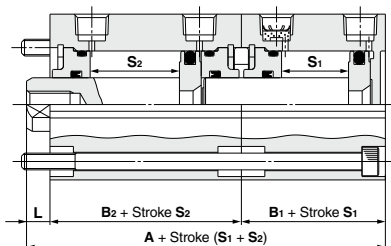

Bore size (mm)	A	B ₁	B ₂	L	Stroke Both of S ₁ , S ₂
	12	45.7 (63.9)	17 (28)	25.2 (32.4)	
16	48 (70)	18.5 (30.5)	26 (36)	3.5	
20	50 (74)	19.5 (31.5)	26 (38)	4.5	
25	56.5 (76.5)	22.5 (32.5)	29 (39)	5	
32	60.5 (80.5)	23 (33)	30.5 (40.5)	7	
40	76.5 (96.5)	29.5 (39.5)	40 (50)	7	
50	79 (99)	30.5 (40.5)	40.5 (50.5)	8	
63	86 (106)	36 (46)	42 (52)	8	
80	104.5 (124.5)	43.5 (53.5)	51 (61)	10	
100	125.5 (145.5)	53 (63)	60.5 (70.5)	12	

Note 1) (): Denotes the dimensions with auto switch.
 Note 2) Applicable stroke available in 5 mm increments.
 Note 3) Please contact SMC for long stroke type.

Made to Order Common Specifications: Dual Stroke Cylinder/Single Rod Type

Symbol
-XC11

MGG series

How to Order

MGG Bearing type Mounting type Bore size - Stroke A + Stroke B-A - Auto switch - C ^{Note} - **XC11**

Note) This symbol is indicated when the D-A9□ or M9□ type auto switch is specified.
It does not apply to other auto switches (D-C7□ and H7□, etc.) (Nil)

Dual stroke cylinder/Single rod type

Specifications

Bore size	20	25	32	40	50	63
Basic cylinder *	CDG1BN Bore size - Stroke A + Stroke B-A - Auto switch - C ^{Note} - X428					
Stroke A	ø20: Maximum 200 mm ø25 to ø63: Maximum 300 mm					
Stroke B	ø20: Maximum 200 mm ø25 to ø63: Maximum 300 mm					
Dimensions	Refer to the table below.					
Piston speed	The piston speed for the stroke B retraction side is 50 to 500 mm/s.					
Specifications other than above	Same as standard type					

* The cylinder has the shape before model change.

Dimensions (Dimensions other than below are the same as standard type.)

MGG series

ø20 to ø50

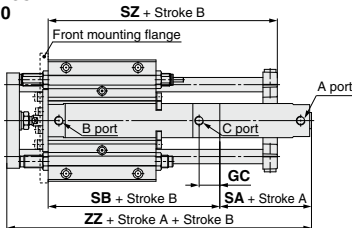

MGG Series

(mm)

Bore size (mm)	GC	SA	SB	SZ	ZZ	Bracket mounting stroke (Stroke A + Stroke B)	Stroke A availability
20	21	50	87	118	176	35 st or more	Up to 200
25	21	50	87	129	183	60 st or more	Up to 300
32	23	52	91	155	189	80 st or more	
40	24	59	99	182	214	125 st or more	
50	28	66	117	218	250	160 st or more	
63	28	66	132	254	252	210 st or more	

ø63

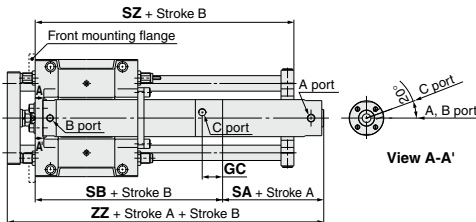

View A-A'

Made to Order Common Specifications: -XC11: Dual Stroke Cylinder/Single Rod Type



23 Dual Stroke Cylinder/Single Rod Type

Symbol
-XC11

MGC series

How to Order

MGC Bearing type Mounting type Bore size - Stroke A + Stroke B-A - Equipped/Not equipped back plate - Auto switch - **XC11**

Dual stroke cylinder/Single rod type

Specifications

Bore size	20	25	32	40	50
Basic cylinder	CDG1ZA <input type="text"/> Bore size <input type="text"/> - <input type="text"/> Stroke A <input type="text"/> + <input type="text"/> Stroke B-A <input type="text"/> Z - <input type="text"/> Auto switch <input type="text"/> - XC11				
Stroke A	ø20: Maximum 200 mm ø25 to ø50: Maximum 300 mm				
Stroke B	ø20: Maximum 200 mm ø25 to ø50: Maximum 300 mm				
Dimensions	Refer to the table below.				
Piston speed	The piston speed for the stroke B retraction side is 50 to 500 mm/s.				
Specifications other than above	Same as standard type				

Dimensions (Dimensions other than below are the same as standard type.)

MGC series
ø20 to ø50

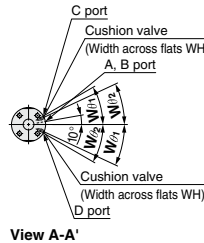
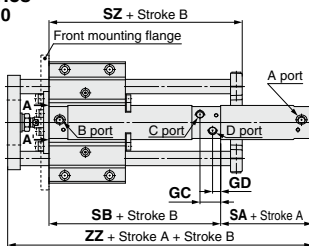

MGC Series

(mm)

Bore size (mm)	GC	GD	SA	SB	W _{1/1}	W _{1/2}
20	21	9	50	87	30°	30°
25	21	9	50	87	30°	30°
32	23	9	52	91	25°	30°
40	24	8	59	99	20°	20°
50	28	12	66	117	20°	20°

Bore size (mm)	SZ		ZZ	Bracket mounting stroke (Stroke A + Stroke B)	Stroke A availability
	With R	Without R			
20	101	80	176	35 st or more	Up to 200
25	107	85	183	60 st or more	
32	115	90	189	80 st or more	Up to 300
40	132	100	214	125 st or more	
50	174	135	250	160 st or more	

Made to Order Common Specifications: -XC12: Tandem Cylinder



24 Tandem Cylinder

This is a cylinder produced with two air cylinders in line allowing double the output force.

Applicable Series

Series	Description	Model	Action	Note	Vol. no. (for std. model)
CM2	Air cylinder	CM2-Z	Double acting, Single rod	Except with air cushion	②-1 From P. 172
	Direct mount type	CM2R	Double acting, Single rod	Except with air cushion	
CG1	Air cylinder	CG1-Z	Double acting, Single rod	Except with air cushion	②-1 From P. 292
	Non-rotating rod type	CG1K-Z	Double acting, Single rod	Except with air cushion	
MB	Air cylinder	MB-Z	Double acting, Single rod	Except ø 125	②-1 From P. 392
MB1	Air cylinder	MB1-Z	Double acting, Single rod	Except ø 125	②-1 From P. 440
CA2	Air cylinder	CA2-Z	Double acting, Single rod		②-1 From P. 470

How to Order

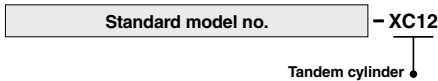

CG1 series

Symbol

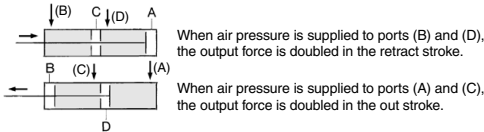

Specifications: Same as standard type

Dimensions (Dimensions other than below are the same as standard type.)

CM2 series

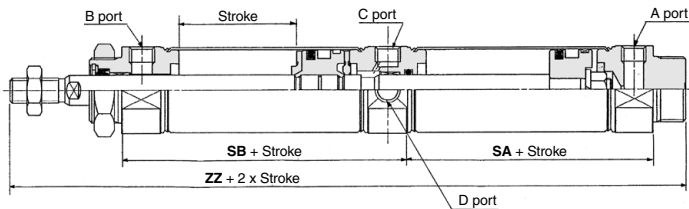

Bore size	(mm)		
	SA	SB	ZZ
20	48	62	164
25	48	62	168
32	50	64	172
40	67.5	88.5	222

Dimensions (Dimensions other than below are the same as standard type.)

CG1 series

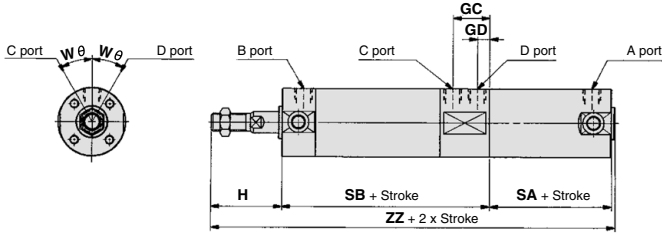

CG1

Bore size	GC	GD	H	SA	SB	Wθ	ZZ	Long stroke Note)	
								SA	ZZ
20	21	9	35	48	87	30°	172	56	180
25	21	9	40	48	87	30°	177	56	185
32	23	9	40	50	91	30°	183	58	191
40	25	9	50	56	100	20°	208	65	217
50	29	13	58	63	118	20°	241	75	253
63	28	12	58	64	117	20°	241	76	253

Note) When the stroke is a long stroke (ø20: 201 mm or more, ø25 to ø63: 301 mm or more)

CG1K

Bore size	GC	GD	H	SA	SB	Wθ	ZZ
20	21	9	35	48	87	30°	172
25	21	9	40	48	87	30°	177
32	23	9	40	50	91	30°	183
40	24	8	50	57	99	20°	208
50	28	12	58	64	117	20°	241
63	28	12	58	64	117	20°	241

* Please contact SMC for long stroke (301 mm or more) since SA-dimensions and ZZ-dimensions are different from those in the above table.

CA2 series

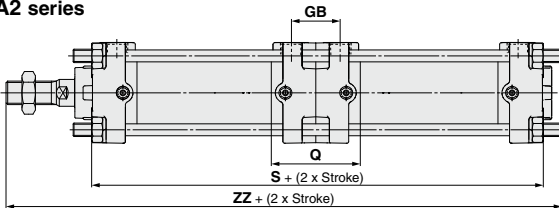

Bore size	GB	Q	S	ZZ
40	29	53	169	231
50	33	59	181	250
63	33	61	197	269
80	41	73	233	321
100	41	79	253	342

MB series

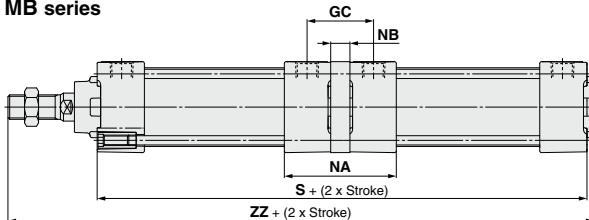

Bore size	GC	NA	NB	S	ZZ
32	36	64	10.6	180	231
40	38	64	10.6	180	235
50	41	73	10.6	200	262
63	43	73	10.6	200	262
80	52	90	14.6	244	320
100	52	90	14.6	244	320

MB1 series

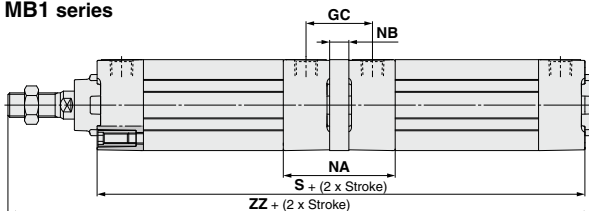

Bore size	GC	NA	NB	S	ZZ
32	36	62	10.6	180	231
40	38	62	10.6	180	235
50	41	71	10.6	200	262
63	43	71	10.6	200	262
80	52	88	14.6	244	320
100	52	88	14.6	244	320



Made to Order Common Specifications: -XC13: Auto Switch Rail Mounting Type



25 Auto Switch Rail Mounting Type

A cylinder on which a rail is mounted to enable auto switches, in addition to the standard method for mounting auto switches (Band mounting type).

Applicable Series

Series	Description	Model	Action	Note	Vol. no. (for std model)
CM2	Air cylinder	CM2-Z	Double acting, Single rod Single acting (Spring return/extended)		②-1 From P. 172
		CM2W-Z	Double acting, Double rod		
	Non-rotating rod type	CM2K-Z	Double acting, Single rod Single acting (Spring return/extended)		
		CM2KW	Double acting, Double rod		
		Direct mount type	CM2R-Z	Double acting, Single rod	
	Non-rotating rod, Direct mount type	CM2RK-Z	Double acting, Single rod		
	Smooth cylinder	CM2Y-Z	Double acting, Single rod		
	End lock cylinder	CBM2	Double acting, Single rod	For XC13A and XC13C only	
CG1	Air cylinder	CG1-Z	Double acting, Single rod	Except the trunnion type	②-1 From P. 292
	Double rod type	CG1W-Z	Double acting, Double rod	Except the trunnion type	
	Non-rotating rod type	CG1K-Z	Double acting, Single rod	Except the trunnion type	
	Direct mount type	CG1R-Z	Double acting, Single rod	Except with air cushion	
	End lock cylinder	CBG1	Double acting, Single rod	For XC13A only	
MGG	Guide cylinder	MGG	Double acting		②-2 From P. 538
MGC	Guide cylinder	MGC	Double acting		②-2 From P. 578

How to Order

CDM2 - XC13A

CDG1 - XC13A

* Trunnion type of the CDG1 series cannot be mounted.

Rail mounting direction *

XC13A	Mounted on the right side when viewed from the rod with the ports facing upwards.
XC13B *2 *3	Mounted on the left side when viewed from the rod.
XC13C *1 *2	Mounted on the underside when viewed from the rod.

- * 1 Not available for CDG1.
- * 2 Not available for CBG1.
- * 3 Not available for CBM2.

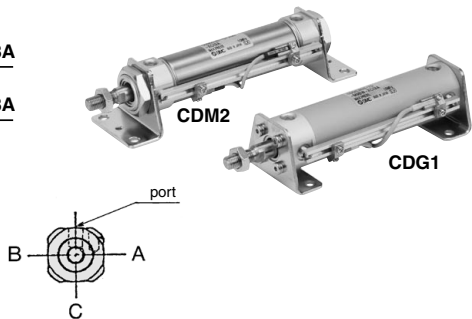

CDM2 Applicable Auto Switches

Rail mounting type	Solid state	D-F7□, D-F7□V, D-F7BA, D-F79F, D-F79W, D-F7□WV, D-J79, D-J79C, D-J79W
	Reed	D-A9□/A9□V, D-A7/A8, D-A7□H/A80H, D-A73C/A80C, D-A79W
Auto switch specifications		For detailed specifications about an auto switch for itself, refer to pages 1575 to 1701.

CDG1 Applicable Auto Switches

Rail mounting type	Solid state	D-M9□/M9□V, D-M9□W/M9□WV, D-M9□A/M9□AV, D-F7□, D-F7□V, D-F7BA, D-F79F, D-F79W, D-F7□WV, D-J79, D-J79C, D-J79W
	Reed	D-A7/A8, D-A7□H/A80H, D-A73C/A80C, D-A79W
Auto switch specifications		For detailed specifications about an auto switch for itself, refer to pages 1575 to 1701.

Proper Auto Switch Mounting Position (Detection at stroke end) and Mounting Height

CDM2 series

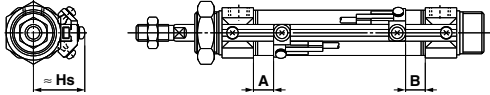

Proper Auto Switch Mounting Position (mm)

Auto switch model Bore size (mm)	D-F7NT		D-A9□ D-A9□V D-A79W		D-A7□ D-A80	
	A	B	A	B	A	B
20	8 (5.5)	7 (4.5)	13 (10.5)	12 (9.5)	5 (2.5)	4 (1.5)
25	8 (5.5)	7 (4.5)	13 (10.5)	12 (9.5)	5 (2.5)	4 (1.5)
32	9 (6.5)	8 (5.5)	14 (11.5)	13 (10.5)	6 (3.5)	5 (2.5)
40	15	13	19	18	12	10

Auto Switch Mounting Height (mm)

D-F7□/F79F D-J79/F7NT D-F7□W/J79W D-F7BA D-A9□/A9□V A7□H/A80H	D-F7□V D-F7□WV D-F7BAV	D-J79C	D-A7□ D-A80	D-A73C D-A80C	D-A79W
Hs	Hs	Hs	Hs	Hs	Hs
23.5	26	29	22.5	29.5	25
26.5	29	32	25.5	32.5	28
30	32.5	35.5	29	35	31.5
34	36.5	39.5	33	40	35.5

Note 1) () : With air cushion

Note 2) Adjust the auto switch after confirming the operating conditions in the actual setting.

Note 3) For the dimensions other than the proper auto switch mounting position and its mounting height, refer to standard type for CM2 series.

Minimum Auto Switch Mounting Stroke (mm)

Auto switch model	No. of auto switch mounted		
	1	2 Same surface	n (n: No. of auto switches) Same surface
D-F7□V D-J79C	5	5	10 + 10 (n-2) ^{Note} (n=4, 6...)
D-F7□ D-J79	5	5	15 + 15 (n-2) ^{Note} (n=4, 6...)
D-F7□WV D-F7BAV D-A79W	10	15	10 + 15 (n-2) ^{Note} (n=4, 6...)
D-F7□W/J79W D-F7BA D-F79F/F7NT	10	15	15 + 20 (n-2) ^{Note} (n=4, 6...)
D-A9□ D-A9□V	5	10	10 + 15 (n-2) ^{Note} (n=4, 6...)
D-A7□/A80 D-A7□H/A80H D-A73C/A80C	5	10	15 + 10 (n-2) ^{Note} (n=4, 6...)
D-A7□H D-A80H	5	10	15 + 15 (n-2) ^{Note} (n=4, 6...)

Note) When "n" is an odd number, an even number that is one larger than this odd number is used for the calculation. However, the minimum even number is 4. So, 4 is used for the calculation when "n" is 1 to 3.

Auto Switch Mounting Bracket: Part No.

Auto switch model	Bore size (mm)
	20 to 40
D-A9□/A9□V	BQ2-012

Note 1) When adding D-A9□(V), order a set of auto switch mounting brackets BQ-1 and BQ2-012 for the CDQ2 series (ø12 to ø25) separately.

When adding the auto switches other than D-A9□(V) mentioned on the left and D-F7BA(V), order auto switch mounting brackets BQ-1 separately.

Note 2) When adding the auto switch D-F7BA(V), order a stainless steel screw set BBA2 separately.

Operating range (mm)

Auto switch model	Bore size (mm)			
	20	25	32	40
D-F7□/F79F/F7□V D-J79/J79C D-F7□W/J79W/F7□WV D-F7BA/F7BAV D-F7NTL	3.5	3.5	4	3.5
D-A9□/D-A9□V	5.5	6	6.5	6.5
D-A7□/A80 D-A7□H/A80H D-A73C/A80C	7.5	8	8.5	8.5
D-A79W	10	10.5	12.5	12.5

* Since the operating range is provided as a guideline including hysteresis, it cannot be guaranteed (assuming approximately ±30% dispersion). It may vary substantially depending on an ambient environment.



Made to Order Common Specifications: -XC13: Auto Switch Rail Mounting Type



25 Auto Switch Rail Mounting Type

Proper Auto Switch Mounting Position (Detection at stroke end) and Mounting Height

CDG1 series

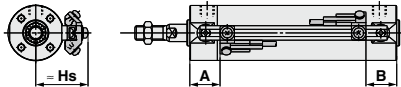

CDG1R series (ø20 to ø63)

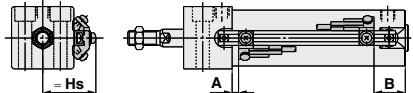

Proper Auto Switch Mounting Position (Detection at stroke end)

Applicable Cylinder Series: CDG1-XC13

(mm)

Auto switch model	D-M9□/D-M9□V D-M9□W/D-M9□WV D-M9□A/D-M9□AV		D-F7□/F79F□V D-J79/J79C D-F7□W/J79W/F7□WV		D-F7A/F7ABV D-A72/A7□A80H D-A73C/A80C		D-F7NT		D-A7□ D-A80		D-A79W	
	A	B	A	B	A	B	A	B	A	B	A	B
20	31.5	22.5 (30.5)	30.5	21.5 (29.5)	35.5	26.5 (34.5)	30	21 (29)	27.5	18.5 (26.5)		
25	31	23 (31)	30	22 (30)	35	27 (35)	29.5	21.5 (29.5)	27	19 (27)		
32	32.5	23.5 (31.5)	31.5	22.5 (30.5)	36.5	27.5 (35.5)	31	22 (30)	28.5	19.5 (27.5)		
40	37.5	25.5 (34.5)	36.5	24.5 (33.5)	41.5	29.5 (38.5)	36	24 (33)	33.5	21.5 (30.5)		
50	44.5	30.5 (42.5)	43.5	29.5 (41.5)	49	34.5 (46.5)	43	29 (41)	40.5	26.5 (38.5)		
63	43	32 (44)	42	31 (43)	47	36 (48)	41.5	30.5 (42.5)	39	28 (40)		
80	56	37 (51)	55	36 (50)	60	41 (55)	54.5	35.5 (49.5)	52	33 (47)		
100	55	38 (52)	54	37 (51)	59	42 (56)	53.5	36.5 (50.5)	51	34 (48)		

Note 1) (): For long stroke type

Note 2) Adjust the auto switch after confirming the operating conditions in the actual setting.

Proper Auto Switch Mounting Position (Detection at stroke end)

Applicable Cylinder Series: CDG1R-XC13

(mm)

Auto switch model	D-M9□/D-M9□V D-M9□W/D-M9□WV D-M9□A/D-M9□AV		D-F7□/F79F□V D-J79/J79C D-F7□W/J79W/F7□WV		D-F7A/F7ABV D-A72/A7□A80H D-A73C/A80C		D-F7NT		D-A7□ D-A80		D-A79W	
	A	B	A	B	A	B	A	B	A	B	A	B
20	10.5	22.5	9.5	21.5	14.5	26.5	9	21	6.5	18.5		
25	10	23	9	22	14	27	8.5	21.5	6	19		
32	11.5	23.5	10.5	22.5	15.5	27.5	10	22	7.5	19.5		
40	16.5	25.5	15.5	24.5	20.5	29.5	15	24	12.5	21.5		
50	18.5	30.5	17.5	29.5	22.5	34.5	17	29	14.5	26.5		
63	17	32	16	31	21	36	15.5	30.5	13	28		

Note) Adjust the auto switch after confirming the operating conditions in the actual setting.

Proper Auto Switch Mounting Position/Applicable Cylinder Series: CDBG1-XC13 (mm)

Lock position	H (Head side)		R (Rod side)		W (Both sides)	
	A	B (Note 2)	A	B	A	B (Note 2)
20	+0	+12	+11	+0	+11	+12
25	+0.5	+11.5	+11.5	-0.5	+11.5	+11.5
32	+0	+10	+10	+0	+10	+10
40	+0	+14	+9	+0	+9	+14
50	+0	+17	+12	+0	+12	+17
63	+1.5	+15.5	+13.5	-1.5	+13.5	+15.5
80	-1.5	+23.5	+14.5	+1.5	+14.5	+23.5
100	-0.5	+23.5	+15.5	+0.5	+15.5	+22.5

Note 1) For end lock cylinders, add the above values to those listed in the table for CG1-XC13.

Note 2) For the head side and both sides lock, add the above values to CG1-XC13 (long stroke) to find B.

Note 3) Adjust the auto switch after confirming the operating conditions in the actual setting.

Note 4) For the dimensions other than the proper auto switch mounting position and mounting height, refer to standard type for CG1 series.

Auto Switch Mounting Height

(mm)

Auto switch model	D-M9□/M9□V D-M9□W/M9□WV D-F7□/F79F D-J79/F7NT D-F7□W/J79W/F7□A	D-F7□V D-F7□WV D-F7BAV	D-J79C	D-A7□ D-A80	D-A73C D-A80C	D-A79W
	Hs	Hs	Hs	Hs	Hs	Hs
20	26.5	29	32	25.5	32.5	28
25	29	31.5	34.5	28	35	30.5
32	32.5	35	38	31.5	38.5	34
40	36.5	39	42	35.5	42.5	38
50	42	44.5	47.5	41	48	43.5
63	49	51.5	54.5	48	55	50.5
80	59	61.5	64.5	58	65	60.5
100	69.5	72	75	68.5	75.5	71

Made to Order Common Specifications: Auto Switch Rail Mounting Type

Symbol
-XC13

How to Order

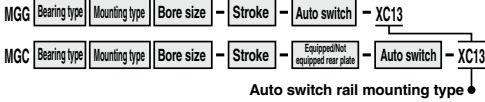

MGG/MGC Applicable Auto Switches

Rail mounting type	Solid state switch	D-M9□/M9□V, D-M9□W/M9□WV, D-M9□A/M9□AV, D-F7□, D-F7□V, D-F7BA, D-F79F, D-F79W, D-F7□WV, D-J79, D-J79C, D-J79W
	Reed switch	D-A7/A8, D-A7□/A80H, D-A73C/A80C, D-A79W
Auto switch specifications	For detailed specifications about an auto switch for itself, refer to pages 1575 to 1701.	

Dimensions (Dimensions other than below are the same as standard type.)

MGG series ø20 to ø50

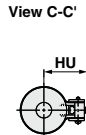
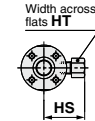
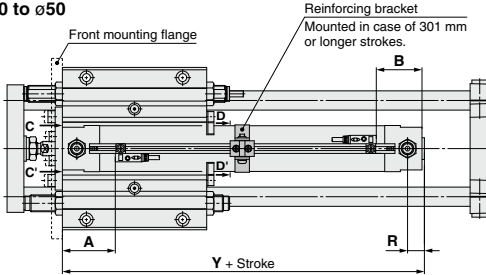

MGG Series (mm)

Bore size (mm)	R	Y	HS	HT	HU
20	14	99	28.5	14	30.7
25	14	99	31	14	33.2
32	14	101	34.5	14	36.5
40	15	109	39	14	41
50	16	124	49.5	17	46.2
63	16	139	56.5	17	53.2
80	23	165	75.5	23	62.2
100	23	165	86	26	72.7

ø63 to ø100

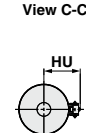
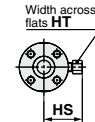
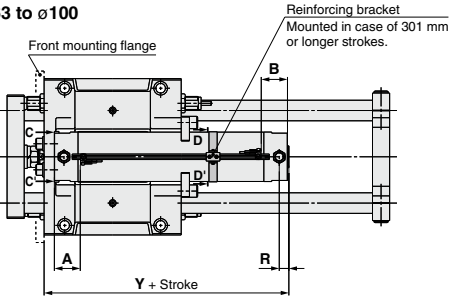

MGC series ø20 to ø50

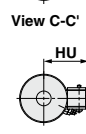
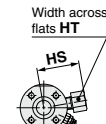
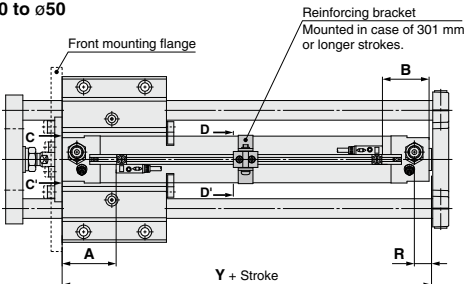

MGC Series (mm)

Bore size (mm)	R	Y	HS	HT	HU
20	14	99	26	7	30.7
25	14	99	28.5	7	33.2
32	14	101	34.5	14	36.5
40	15	109	39	14	41
50	16	124	49.5	17	46.2

Made to Order Common Specifications: -XC13: Auto Switch Rail Mounting Type



25 Auto Switch Rail Mounting Type

Symbol
-XC13

Proper Auto Switch Mounting Position (Detection at stroke end) and Mounting Height

Proper Auto Switch Mounting Position/Applicable Cylinder MGG, MGC Series (mm)

Auto switch model	D-M9□/M9□V D-M9□W/M9□VV D-M9□A/M9□AV		D-F7□/F79F/F7□V D-J79/J79C D-F7□W/J79W/F7□VV D-F7BA/F7BAV D-A72/A7□H/A80H D-A73C/A80C		D-F7NT		D-A7□ D-A80		D-A79W	
	A	B	A	B	A	B	A	B	A	B
	Bore size (mm)									
20	45.5	39.5	43	37	48	42	42.5	36.5	40	34
25	45.5	39.5	43	37	48	42	42.5	36.5	40	34
32	46.5	40.5	44	38	49	43	43.5	37.5	41	35
40	51.5	43.5	49	41	54	46	48.5	40.5	46	38
50	58.5	51.5	56	49	61	54	55.5	48.5	53	46
63	58.5	51.5	56	49	61	54	55.5	48.5	53	46
80	68.5	61.5	66	59	71	64	65.5	58.5	63	56
100	68.5	61.5	66	59	71	64	65.5	58.5	63	56

Auto Switch Mounting Height (mm)

D-M9□/M9□V D-M9□W/M9□VV D-M9□A/M9□AV		D-F7□V D-F7□WV D-F7BAV	D-J79C	D-A7□ D-A80	D-A73C D-A80C	D-A79W
Hs		Hs	Hs	Hs	Hs	Hs
26.5		29	31	26.5	32.5	30
29		31.5	33.5	29	35	32.5
32.5		34.5	36.5	32	38.5	35.5
37		39	41	36.5	43	40
42		44.5	46.5	42	48	45.5
49		51.5	53.5	49	55	52.5
58		60.5	62.5	58	64	61.5
69		71	73	68.5	74.5	72

Note 1) Adjust the auto switch after confirming the operating conditions in the actual setting.

Note 2) For dimensions other than the proper auto switch mounting position and height, refer the standard type for MGG and MGC series.

Minimum Auto Switch Mounting Stroke/CDG1, MGG, MGC

Auto switch model	No. of auto switch mounted (mm)		
	1	2 Same surface	n (n: No. of auto switches) Same surface
D-M9□/M9□V D-F7□V D-J79C	5	5	10 + 10 (n-2) ^{Note} (n=4, 6··)
D-M9□WV D-M9□AV D-F7□WV D-F7BAV D-A79W	10	15	10 + 15 (n-2) ^{Note} (n=4, 6··)
D-M9□W D-M9□A	10	15	15 + 15 (n-2) ^{Note} (n=4, 6··)
D-F7□ D-J79	5	5	15 + 15 (n-2) ^{Note} (n=4, 6··)
D-F7□W/J79W D-F7BA D-F79F/F7NT	10	15	15 + 20 (n-2) ^{Note} (n=4, 6··)
D-A7□/A80 D-A7□H/A80H D-A73C/A80C	5	10	15 + 10 (n-2) ^{Note} (n=4, 6··)
D-A7□H D-A80H	5	10	15 + 15 (n-2) ^{Note} (n=4, 6··)

Note) When "n" is an odd number, an even number that is one larger than this odd number is used for the calculation. However, the minimum even number is 4. So, 4 is used for the calculation when "n" is 1 to 3.

Operating Range/CDG1, MGG, MGC

Auto switch model	Bore size (mm)							
	20	25	32	40	50	63	80	100
D-M9□/M9□V D-M9□W/M9□WV D-M9□A/M9□AV	4	4	5	4	5.5	6.5	7.5	7
D-F7□/F79F/F7□V D-J79/J79C D-F7□W/J79W/F7□WV D-F7BA/F7BAV D-F7NT	4.5	4	4.5	5	5	6	6	6
D-A7□/A80 D-A7□H/A80H D-A73C/A80C	9	9	10	11	11	13.5	13	13.5
D-A79W	11	11	13	14	14	16.5	16	16.5

* Since the operating range is provided as a guideline including hysteresis, it cannot be guaranteed. (Assuming approximately ±30% dispersion.) It may vary substantially depending on an ambient environment.

Auto Switch Mounting Bracket: Part No./CDG1, MGG, MGC

Auto switch model	Bore size (mm)	
	ø20 to ø100	
D-M9□/M9□V D-M9□W/M9□WV	BQ2-012	
D-A9□A/A9□AV	BQ2-012S	

Note 1) When adding D-M9□(V) and D-A9□W(V), order a set of auto switch mounting brackets BQ-1 and BQ2-012 for the CDQ2 series (ø12 to ø25) separately.
When ordering the auto switches other than D-M9□□□ mentioned on the left and D-F7BA(V), order auto switch mounting brackets BQ-1 separately.

Note 2) When adding D-M9□A(V), order a stainless steel screw set BBA2 together with BQ2-012S separately.

When adding the auto switch D-F7BA(V), order a stainless steel screw set BBA2 separately.

Made to Order Common Specifications: -XC17: Pin Cylinder with Rod Quenched



26 Pin Cylinder with Rod Quenched

Symbol
-XC17

The piston rod material is changed and the rod end is quenched.

Applicable Series

Series	Description	Model	Action	Note	Vol. no. (for std model)
CJP	Pin cylinder	CJPB	Single acting (Panel mount)	Except $\phi 4$	2-1 From P. 35
		CJPS	Single acting (Embedded)	Except $\phi 4$	

How to Order

CJP -XC17

Note) Additional symbol for "-B" (without thread) is unnecessary when indicating the model no.

Rod quenched specifications

Specifications: Same as standard type

Construction (Dimensions are the same as standard.)

Panel mount type: CJPB

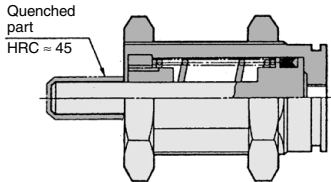

Embedded type: CJPS

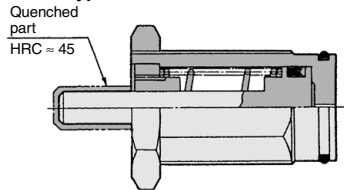

Made to Order Common Specifications: -XC19: Intermediate Stroke (Spacer Type)



27 Intermediate Stroke (Spacer type)

Symbol
-XC19

Dealing with the intermediate stroke by installing a spacer with the standard stroke cylinder.

Applicable Series

Series	Description	Model	Action	Note	Vol. no. (for std. model)
CU	Free mount cylinder	CU	Double acting, Single rod	5 mm spacer only	②-1 From P. 623
	Non-rotating rod type	CUK	Double acting, Single rod	5 mm spacer only	
	Long stroke	CU	Double acting, Single rod	5 mm spacer only	
	Long stroke, Non-rotating	CUK	Double acting, Single rod	5 mm spacer only	
CJP2	Pin cylinder	CJP2	Double acting, Single rod	Except ø4	②-1 From P. 23
MGP	Compact guide cylinder	MGP ^{KL} _A AZ	Double acting	Air cushion type only	②-2 From P. 452
MXH	Compact slide	MXH-Z	Double acting	5 mm spacer only	②-2 From P. 19
CXS	Dual rod cylinder	CXS ^L	Double acting	5 mm spacer only	②-2 From P. 749
CXSJ	Dual rod cylinder compact type	CXSJ ^L	Double acting	5 mm spacer only	②-2 From P. 737

How to Order

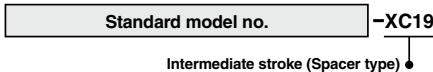

CU

Applicable Stroke

Stroke (mm)	Stroke (mm)
ø6, ø10, ø16	35, 45, 55
ø20, ø25, ø32	35, 45, 55, 65, 75, 85, 95

- Dealing with it by installing a 5 mm width spacer with the standard stroke cylinder.
- Specifications other than above are the same as standard type.
- External dimensions are the same as standard stroke products added by 5 mm for the required stroke.
- Please consult with SMC when stroke other than applicable stroke is required.

CJP2

Applicable Stroke

Stroke (mm)	Stroke (mm)
ø6	1 mm increments in 24 st or less
ø10, ø16	1 mm increments in 39 st or less

- Dealing with it by installing a 1 to 4 mm width spacer with the standard stroke cylinder.
- Specifications other than above are the same as standard type.
- External dimensions are the same as standard stroke products which is closed to the required intermediate stroke.
Example: For 11 ST, to b-e dealt with 4 mm spacer for 15 st body
- As for the one with switch, 5 st or less will not be available.

MGP(Air Cushion Type)

Applicable Stroke

Description	Dealing with the stroke in 1 mm increments by changing a collar of the standard stroke cylinder. Minimum manufacturable stroke ø16 to ø63: 15 mm ø80, ø100: 20 mm Select a rubber bumper type, because the cushion effect is not obtainable for less than this stroke.	
Part no.	Suffix "-XC19" to the end of standard part number.	
Applicable stroke (mm)	ø16	15 to 249
	ø20 to ø63	15 to 399
	ø80, ø100	20 to 399
Example	Part no. MGPM20-35AZ-XC19 15 mm width collar is installed in MGPM20-50AZ. C dimension is 112 mm.	

(Note) Intermediate strokes (in 1 mm increments) with a special body are available by made-to-order.

MXH

Applicable Stroke

Stroke (mm)	Stroke (mm)
ø6, ø10, ø16, ø20	35, 45, 55

- Dealing with it by installing a 5 mm width spacer with the standard stroke cylinder.
- Specifications other than above are the same as standard type.
- External dimensions are the same as standard stroke products added by 5 mm for the required stroke.
- Please consult with SMC when stroke other than applicable stroke is required.

CXS

Applicable Stroke

Stroke (mm)	Stroke (mm)
ø6	15, 25, 35, 45
ø10	55, 65
ø15	55, 65, 85, 95
ø20	
ø25	
ø32	

- Dealing with it by installing a 5 mm width spacer with the standard stroke cylinder.
- Specifications other than above are the same as standard type.
- External dimensions are the same as standard stroke products added by 5 mm for the required stroke.
- Please consult with SMC when stroke other than applicable stroke is required.

CXSJ

Applicable Stroke

Stroke (mm)	Stroke (mm)
ø6	15, 25, 35, 45
ø10	15, 25, 35, 45, 70
ø15	15, 25, 35, 45, 70, 95
ø20	
ø25	
ø32	

- Dealing with it by installing a 5 mm width spacer with the standard stroke cylinder.
- Specifications other than above are the same as standard type.
- External dimensions are the same as standard stroke products added by 5 mm for the required stroke.
- Please consult with SMC when stroke other than applicable stroke is required.

Made to Order Common Specifications: -XC20: Head Cover Axial Port



28 Head Cover Axial Port

Symbol
-XC20

Head side port position is changed to the axial direction. (Standard head side port is plugged with hexagon socket head screw.)

Applicable Series

Series	Description	Model	Action	Note	Vol. no. (for std model)
CM2	Air cylinder	CM2-Z	Double acting, Single rod Single acting (Spring return/extend)	Except with air cushion	② -1 From P. 172
	Non-rotating rod type	CM2K-Z	Double acting, Single rod Single acting (Spring return/extend)	Except with air cushion	
	Direct mount type	CM2R-Z	Double acting, Single rod	Except with air cushion	
	Non-rotating rod, Direct mount type	CM2RK-Z	Double acting, Single rod	Except with air cushion	
	Smooth cylinder	CM2Y-Z	Double acting, Single rod		
CG1	Air cylinder	CG1-Z	Double acting, Single rod Single acting (Spring return/extend)	Except with air cushion	② -1 From P. 292
	Non-rotating rod type	CG1K-Z	Double acting, Single rod	Except with air cushion	
	Direct mount type	CG1R-Z	Double acting, Single rod	Except with air cushion	
	Non-rotating rod, Direct mount type	CG1KR-Z	Double acting, Single rod	Except with air cushion	
	Smooth cylinder	CG1Y-Z	Double acting, Single rod		

How to Order

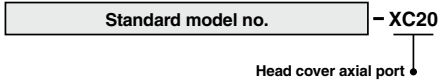

Specifications: Same as standard type

* Be sure to use the speed controller since head side port has no throttle.

Construction

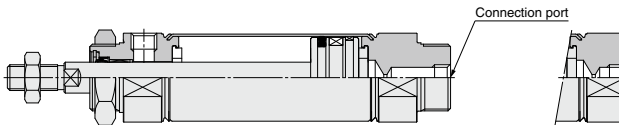

CM2 Series

Bore size (mm)	Port size
20, 25, 32	Rc 1/8
40	Rc 1/4

CG1 Series

Bore size (mm)	Port size
20, 25, 32, 40	Rc 1/8
50, 63	Rc 1/4

* Same dimensions as standard type except port size.

Made to Order Common Specifications: -XC22: Fluororubber Seals



29 Fluororubber Seals

Applicable Series

Series	Description	Model	Action	Note	Vol. no. (for std model)
CJP	Pin cylinder	CJP2	Double acting, Single rod	Except ø4. Packing set (7)	②-1 From P. 23
		CJPB	Single acting (Panel mounting)	Except ø4	
		CJPS	Single acting (Embedded)	Except ø4	
CJ2	Air cylinder	CJ2-Z	Double acting, Single rod	Except with air cushion	②-1 From P. 46
		CJ2W-Z	Single acting (Spring return/extend)		
	Non-rotating rod type	CJ2K-Z	Double acting, Double rod	Except with air cushion	
CM2	Direct mount type	CJ2R-Z	Double acting, Single rod		②-1 From P. 172
		CM2-Z	Double acting, Single rod		
	Air cylinder	CM2W-Z	Double acting, Double rod		
		CM2K-Z	Double acting, Single rod		
		CM2KW-Z	Double acting, Double rod		
	Direct mount type	CM2R-Z	Double acting, Single rod		
	Non-rotating rod, Direct mount type	CM2RK-Z	Double acting, Single rod		
End lock cylinder	CBM2	Double acting, Single rod			
CG1	Air cylinder	CG1-Z	Double acting, Single rod	Without a bumper for cylinders with a rubber bumper	②-1 From P. 292 (5)
	Double rod type	CG1W-Z	Double acting, Double rod	Without a bumper for cylinders with a rubber bumper	
	Direct mount type	CG1R-Z	Double acting, Single rod	Without a bumper for cylinders with a rubber bumper	
MB	Air cylinder	MB-Z	Double acting, Single rod	Except ø125	②-1 From P. 392
		MBW-Z	Double acting, Double rod	Except ø125	
MB1	Air cylinder	MB1-Z	Double acting, Single rod	Air cushion only	②-1 From P. 440
		MB1W-Z	Double acting, Double rod	Air cushion only	
CA2	Air cylinder	CA2-Z	Double acting, Single rod		②-1 From P. 470
		CA2W-Z	Double acting, Double rod		
	End lock cylinder	CBA2	Double acting, Single rod		
CS1	Air cylinder	CS1	Double acting, Single rod	Applicable bore: Lube type 125 to 300, Non-lube type 125 to 200	②-1 From P. 530
CS2	Air cylinder	CS2	Double acting, Single rod		②-1 From P. 568
		CS2W	Double acting, Double rod		
CUJ	Mini free mount cylinder	CUJ	Double acting, Single rod	Except ø4, and single acting, spring return type. ø12 to ø20: A bumper is a standard product.	②-1 From P. 596
CU	Free mount cylinder	CU	Double acting, Single rod		②-1 From P. 623
			Single acting (Spring return/extend)		
	Non-rotating rod type	CUK	Double acting, Single rod		
			Single acting (Spring return/extend)		
Long stroke	CU	Double acting, Single rod			
Long stroke, Non-rotating	CUK	Double acting, Single rod			
MGP	Compact guide cylinder	MGPM-Z	Double acting	Slide bearing only	②-2 From P. 432
MGQ	Compact guide cylinder	MGQM	Double acting	Slide bearing only	②-2 From P. 520 (6)
MGG	Guide cylinder	MGG	Double acting	Without rubber bumper	②-2 From P. 538
MGC	Guide cylinder	MGC	Double acting		②-2 From P. 578
CV	Valve mounted air cylinder	CV3	Double acting, Single rod		②-3 From P. 812
		CVS1	Double acting, Single rod		
CEP1	High precision stroke reading cylinder	CEP1	Double acting, Single rod		②-3 From P. 647
MXH	Compact slide	MXH-Z	Double acting		②-2 From P. 19
CXS	Dual rod cylinder	CXS	Double acting		②-2 From P. 749
CXSJ	Dual rod cylinder compact type	CXSJ	Double acting		②-2 From P. 737
CX2	Slide unit	CX2	Double acting		②-2 From P. 650
CXW	Slide unit	CXW	Double acting		②-2 From P. 659
MK	Rotary clamp cylinder	MK	Double acting	The bumper is a standard product.	②-3 From P. 389

How to Order

Standard model no. **-XC22**

Fluororubber seals

Specifications

Seal material	Fluororubber	
Ambient temperature range	With auto switch : -10 to 60°C (0°C to 60°C for CS1, CS2 series) Without auto switch : -10 to 70°C (0°C to 70°C for CS1, CS2 series)	Note 1) (No freezing)
Specifications other than above and external dimensions	Same as standard type for each series	

Note 1) Please confirm with SMC, as the type of chemical and the operating temperature may not allow the use of this product.

Note 2) Cylinders with auto switches can also be produced; however, auto switch related parts (auto switch units, mounting brackets, built-in magnets) are the same as standard products. Before using these, please contact SMC regarding their suitability for the operating environment.

Note 3) It is only applicable for the cylinder main body section as to CV3, CVS1 series.

Note 4) The MGG series is using a shock absorber RBL type.

Note 5) No cushion is equipped for N type. Piston speed is ranged from 50 to 500 mm/s.

Note 6) The MGP and MGQ series are without a cushion. Confirm the kinetic energy.

Note 7) Refer to the construction of the standard type for the details of the packing set for CJP2□6,10 and 16.

How to Order

MGPM Standard model no. **-XC22**
↓
 Fluororubber seals

Dimensions

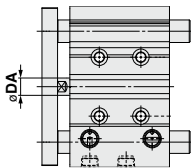

(mm)			
Bore size (mm)	DA	Bore size (mm)	DA
12	(6)	40	(14)
16	(8)	50	20
20	(10)	63	20
25	(10)	80	25
32	(14)	100	30

The dimensions in () are the same as standard type.

How to Order

MGC Standard model no. **-XC22**
↓
 Fluororubber seals

Dimensions (Dimensions other than below are the same as standard type.)

MGCLB series

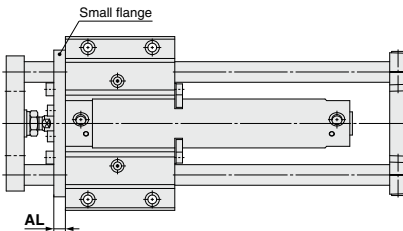

(mm)	
Bore size (mm)	AL
20	9
25	9
32	9
40	12
50	12

Made to Order Common Specifications: -XC24: With Magnetic Shielding Plate -XC25: No Fixed Throttle of Connection Port



30 With Magnetic Shielding Plate -XC24

Symbol

Shields against the magnetic leaked from external slider.

Applicable Series

Series	Description	Model	Action	Vol. no. (for std model)
CY3	Magnetically coupled rodless cylinder	CY3B	Double acting	②-1 From P. 1468
REA	Sine rodless cylinder	REA	Double acting	②-3 From P. 25

How to Order

CY3B
REA Standard model no. -XC24

With magnetic shielding plate ↓

Specifications: Same as standard type

Dimensions

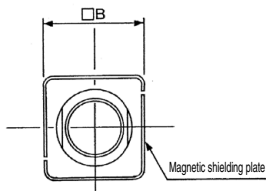

Dimensions	Bore size (mm)								
	ø6	ø10	ø15	ø20	ø25	ø32	ø40	ø50	ø63
□B	19	27	37	38	48	62	72	88	102
Standard external (□B)	17	25	35	36	46	60	70	86	100

* Dimensions except mentioned above are the same as standard type.
* REA is ø25 to ø63.

31 No Fixed Throttle of Connection Port -XC25

Symbol

Type with no restrictor on the port, since it's using air-hydro type on the rod cover and the head cover of air cylinder CM2 series.

Applicable Series

Series	Description	Model	Action	Vol. no. (for std model)	
CM2	Air cylinder	CM2-Z	Double acting, Single rod Single acting (Spring return/airless)	②-1 From P. 172	
		CM2W-Z	Double acting, Double rod		
		CM2K-Z	Double acting, Single rod		
	Non-rotating rod type	CM2KW-Z	Double acting, Double rod Single acting (Spring return/airless)		
		Direct mount type	CM2R-Z		Double acting, Single rod
		Non-rotating rod, Direct mount type	CM2RK-Z		Double acting, Single rod
Smooth cylinder	CM2Y-Z	Double acting, Single rod			

* Except with air cushion (Standard equipment)

How to Order

CM2 Standard model no. -XC25

No fixed throttle in connection port ↓

Specifications: Same as standard type

Construction

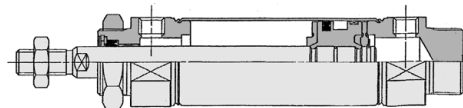

* External dimensions are the same as standard CM2 series.

⚠ Caution

1. Use a shock absorber, etc.

When the piston speed exceed 750 mm/s, make sure that direct impact does not apply on the cylinder cover by using an external stopper (shock absorber, etc).

Made to Order Common Specifications: -XC26: With Split Pins for Double Clevis Pin and Double Knuckle Joint Pin and Flat Washers



32 With Split Pins for Double Clevis Pin/Double Knuckle Joint Pin and Flat Washers **-XC26**

Flat washer is added for the double clevis (one of the mounting types) or double knuckle joint (one of the accessories).

Applicable Series

Series	Description	Model	Action	Note	Vol. no. (for std model)
MB	Air cylinder	MB	Double acting, Single rod	ø125 only	②-1 From P. 392
MB1	Air cylinder	MB1	Double acting, Single rod	ø125 only	②-1 From P. 440
		MB1W	Double acting, Double rod	ø125 only	
CS2	Standard type Smooth cylinder	CS2-Z	Double acting, Single rod		②-1 From P. 568
		CS2Y-Z	Double acting, Single rod		

Specifications

Mounting type	Only double clevis type (D), Double knuckle joint
Changed parts	Clevis pin, knuckle joint pin, flat washer
Specifications other than above	Same as standard type

Dimensions (Dimensions other than below are the same as standard type.)

Double clevis

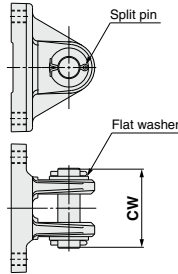

- * For mounting bracket, split pin, clevis pin and flat washer are shipped together, (but not assembled).
- * Mounting method is the same as standard type.

Bore size (mm)	CW
ø125	90
ø140	104
ø160	113

Double knuckle joint

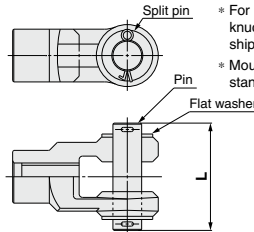

- * For mounting bracket, split pin, knuckle joint pin and flat washer are shipped together, (but not assembled).
- * Mounting method is the same as standard type.

Bore size (mm)	L
ø125	90
ø140	104
ø160	113

How to Order

• Product

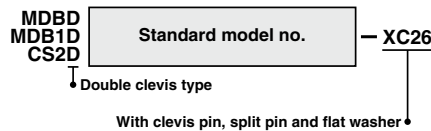

• Parts assembly

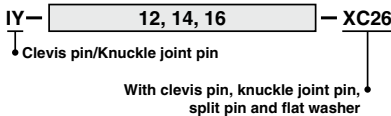
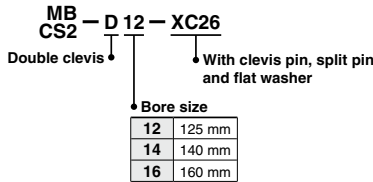

Made to Order Common Specifications: -XC26: With Split Pins for Double Clevis Pin and Double Knuckle Joint Pin and Flat Washers



32 With Split Pins for Double Clevis Pin/Double Knuckle Joint Pin and Flat Washers -XC26

A pin for double clevis (one of the mounting types) or double knuckle joint (one of the accessories) has been changed for a split pin, and split pins and flat washers have been added.

Applicable Series

Series	Model	Action	Vol. no. (for std model)
CQS	Standard type	CQS	Double acting, Single rod Single acting Spring return/extended
	Long stroke	CQS	Double acting, Single rod
	Non-rotating rod type	CQSK	Double acting, Single rod
	Anti-lateral load type	CQS□S	Double acting, Single rod
CQ2	Standard type	CQ2-Z	Double acting, Single rod Single acting Spring return/extended
	Long stroke	CQ2-Z	Double acting, Single rod
	Non-rotating rod type	CQ2K-Z	Double acting, Single rod
	Anti-lateral load type	CQ2□S-Z	Double acting, Single rod
	With end lock	CBQ2	Double acting, Single rod
	Magnetic field resistant	CDQ2□P	Double acting, Single rod
	Copper-free compact	20-CQ2-Z	Double acting, Single rod Single acting Spring return/extended
	Copper-free long stroke	20-CQ2□-Z	Double acting, Single rod
Copper-free anti-lateral load	20-CQ2□S-Z	Double acting, Single rod	

Specifications

Mounting	Double clevis (D) only
Changed parts	Clevis pin/Knuckle pin, Split pin, Flat washer
Specifications other than above	Same as standard

Dimensions: Same as Standard

Double clevis

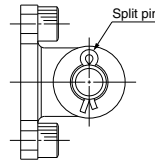

Flat washer

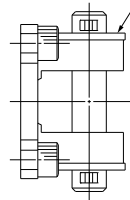

How to Order

• Product

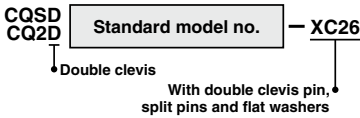

• Parts assembly

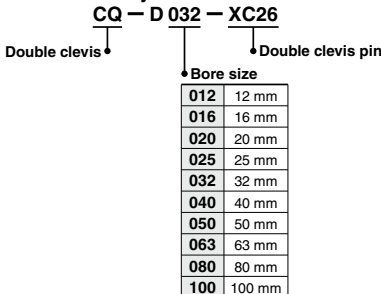

- * For mounting bracket, split pins, clevis pin and flat washers are shipped together, (but not assembled).
- * Mounting method is the same as standard.

Double knuckle joint

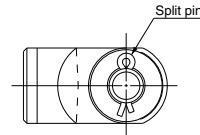

Flat washer

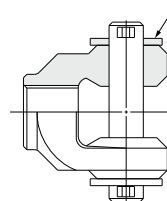

- * For mounting bracket, split pins, knuckle pin and flat washers are shipped together, (but not assembled).
- * Mounting method is the same as standard.

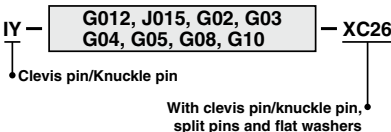
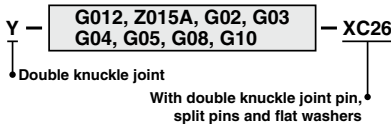

Made to Order Common Specifications:

-XC26 : Double Clevis Width 12.5 mm, 16.5 mm, 19.5 mm: With Double Clevis and Double Knuckle Joint



33 Double Clevis Width 12.5 mm, 16.5 mm, 19.5 mm: With Double Clevis and Double Knuckle Joint **-XC26**

3 types of double clevis width and double knuckle joint width: 12.5 mm, 16.5 mm, 19.5 mm
 Made to order -XC35, -XC88/-XC89, and -XC91 are available.

Applicable Series

Series	Description	Model	Action	Bore size (mm)	Made to Order			Vol. no. (for std model)
					With coil scraper XC35	Spatter resistant specification for arc welding XC88/XC89	Spatter resistant specification for arc welding XC91	
CQ2	Standard	CQ2-Z	Double acting, Single rod	32, 40, 50, 63	○	○	○	2 -1 From P. 773
	Long stroke	CQ2-Z			○	○	—	
	Anti-lateral load	CQ2□S-Z	—		○	—		

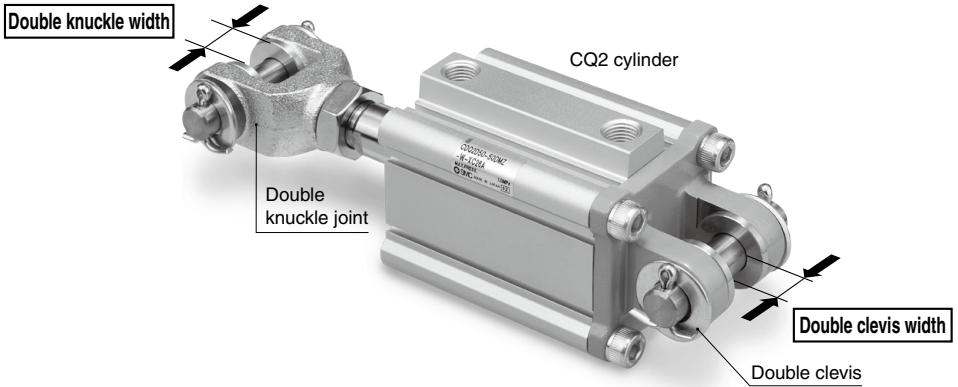

Made to Order Common Specifications:

-XC26□: Double Clevis Width 12.5 mm, 16.5 mm, 19.5 mm: With Double Clevis and Double Knuckle Joint



33 Double Clevis Width 12.5 mm, 16.5 mm, 19.5 mm: With Double Clevis and Double Knuckle Joint

CQ2 series: Standard

How to Order

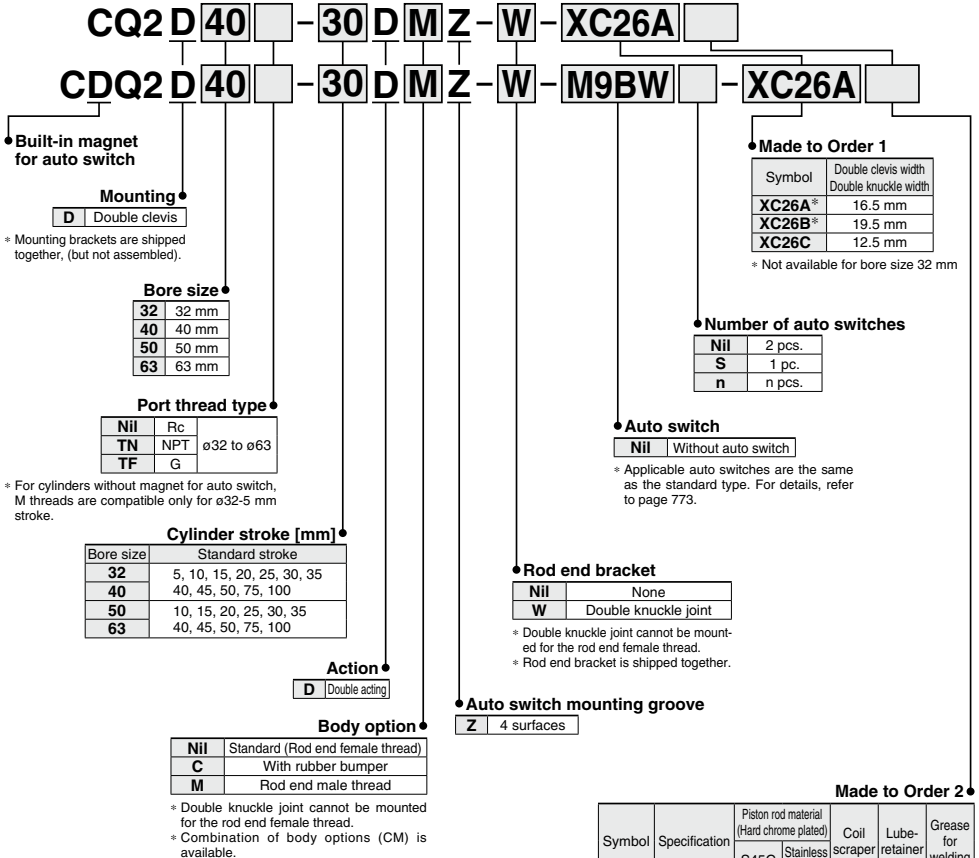

Ordering Example of Cylinder Assembly

When arranging Made to Order 1 and 2 at the same time
Cylinder model: CDQ2D40-30DMZ-W-M9BW-XC26AC35

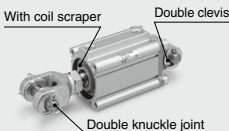

Mounting D: Double clevis
Rod end bracket W: Double knuckle joint
Made to Order 1 : XC26A
(Double clevis/knuckle width: 16.5 mm)
Made to Order 2 : XC35
(With coil scraper)
Auto switch D-M9BW: 2 pcs.

Made to Order 2

Symbol	Specification	Piston rod material (Hard chrome plated)		Coil scraper	Lube- retainer	Grease for welding
		S45C	Stainless steel 304			
Nil	None	—	—	—	—	—
XC35	With coil scraper	●	—	●	—	—
XC88*	Spatter resistant spec. for arc welding	—	●	●	●	●
XC89*	Spatter resistant spec. for arc welding	●	—	●	●	●
XC91*	Spatter resistant spec. for arc welding	●	—	●	—	●

* Only available for cylinders with built-in magnet for auto switch

Double Clevis Width
Double Knuckle Width

Made to Order Common Specifications:
12.5 mm, 16.5 mm, 19.5 mm: With Double Clevis and Double Knuckle Joint

Symbol

-XC26

Bore Size

Ø32 to Ø63 Standard

C(D)Q2D-XC26

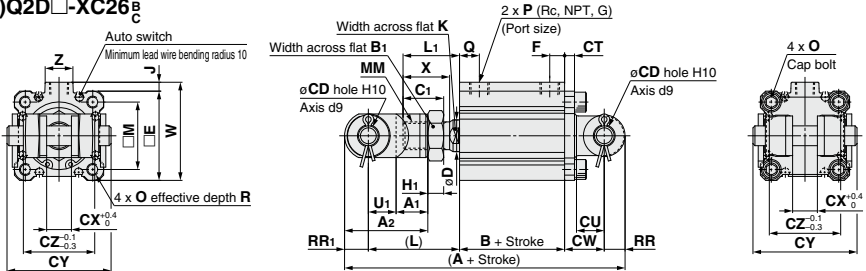

Note 1) Intermediate strokes (1 to 99 mm) are available in 1 mm increments.

For intermediate strokes, the dimensions are the same as a standard stroke one size larger than this intermediate stroke.

Note 2) For 5 mm stroke with bore size 32 and without magnet for auto switch, F dimension is 5.5 and P dimension is M5 x 0.8.

Note 3) For models with a rubber bumper, the stroke length tolerance does not include the deflection of the bumper.

Note 4) Flat washers and split pins are included with the double clevis and double knuckle joint of this cylinder.

Note 5) Double clevis and double knuckle joint are shipped together with the product.

Bore size	Stroke range	Without magnet for auto switch		Built-in magnet for auto switch		CD	CT	CU	CW	CX			CY	CZ	D	E	F	J
		A	B	A	B					XC26A	XC26B	XC26C						
32	50 or less	111	23	121	33	10	5	14	20	—	—	12.5	52.5	36	16	45	7.5	4.5
	75, 100	121	33															
40	50 or less	119.5	29.5	129.5	39.5	10	6	14	22	16.5	19.5	12.5	52.5	36	16	52	7.5	5
	75, 100	129.5	39.5															
50	50 or less	147.5	30.5	157.5	40.5	14	7	20	28	16.5	19.5	12.5	66	44	20	64	10.5	7
	75, 100	157.5	40.5															
63	50 or less	155	36	165	46	14	8	20	30	16.5	19.5	12.5	66	44	20	77	10.5	7
	75, 100	165	46															

Bore size	K	L	M	O	P	Q	R	RR	RR1	U1	W	Z	A1	A2	B1	C1	H1	L1	MM	X
32	14	46	34	M6 x 1.0	1/8	10	10	10	12	14	49.5	14	16	42	22	20.5	8	28.5	M14 x 1.5	23.5
40	14	46	40	M6 x 1.0	1/8	12.5	10	10	12	14	57	15	16	42	22	20.5	8	28.5	M14 x 1.5	23.5
50	17	59	50	M8 x 1.25	1/4	10.5	14	14	16	20	71	19	20	56	27	26	11	33.5	M18 x 1.5	28.5
63	17	59	60	M10 x 1.5	1/4	15	18	14	16	20	84	19	20	56	27	26	11	33.5	M18 x 1.5	28.5

Made to Order (Dimensions other than those shown below are the same as those shown above.)

■ With coil scraper:
C(D)Q2D-XC26-C35

■ Spatter resistant specification for arc welding:
CDQ2D-XC26-C88/C89/C91

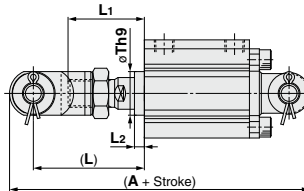

Bore size	Stroke range	XC35/XC91					XC88/XC89					
		Without magnet for auto switch		Built-in magnet for auto switch			Without magnet for auto switch		Built-in magnet for auto switch			
		A	L	L1	L2	Th9	A	L	L1	L2	Th9	
32	50 or less	116	126	51	33.5	5	23 ⁰ _{-0.052}	131	56	38.5	10	23 ⁰ _{-0.052}
	75, 100	126										
40	50 or less	124.5	134.5	51	33.5	5	28 ⁰ _{-0.052}	139.5	56	38.5	10	28 ⁰ _{-0.052}
	75, 100	134.5										
50	50 or less	152.5	162.5	64	38.5	5	35 ⁰ _{-0.062}	167.5	69	43.5	10	35 ⁰ _{-0.062}
	75, 100	162.5										
63	50 or less	160	170	64	38.5	5	35 ⁰ _{-0.062}	175	69	43.5	10	35 ⁰ _{-0.062}
	75, 100	170										

* XC88, XC89 and XC91 are only available for cylinders with built-in magnet for auto switch.



Made to Order Common Specifications:

-XC26□: Double Clevis Width 12.5 mm, 16.5 mm, 19.5 mm: With Double Clevis and Double Knuckle Joint



33 Double Clevis Width 12.5 mm, 16.5 mm, 19.5 mm: With Double Clevis and Double Knuckle Joint

CQ2 series: Long stroke

How to Order

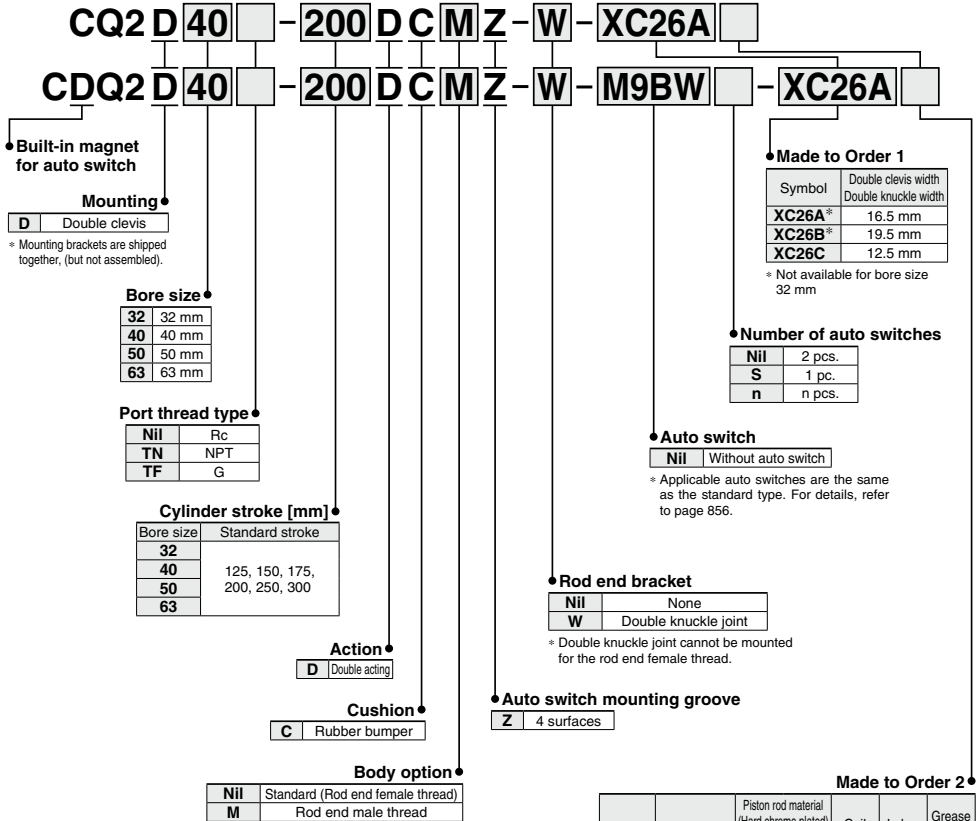

Ordering Example of Cylinder Assembly

When arranging Made to Order 1 and 2 at the same time
Cylinder model: CDQ2D40-200DCMZ-W-M9BW-XC26AC35

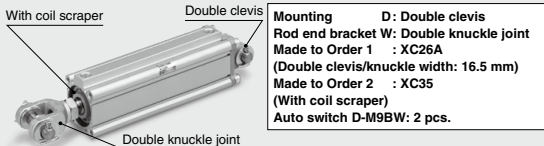

Symbol	Specification	Piston rod material (Hard chrome plated)		Coil scraper	Lube-retainer	Grease for welding
		S45C	Stainless steel 304			
Nil	None	—	—	—	—	—
XC35	With coil scraper	●	—	●	—	—
XC88*	Spatter resistant spec. for arc welding	—	●	●	●	●
XC89*	Spatter resistant spec. for arc welding	●	—	●	●	●

* Only available for cylinders with built-in magnet for auto switch

Double Clevis Width
Double Knuckle Width

Made to Order Common Specifications:
12.5 mm, 16.5 mm, 19.5 mm: With Double Clevis and Double Knuckle Joint

Symbol

-XC26

Bore Size

∅32 to ∅63 Long Stroke

C(D)Q2D-XC26

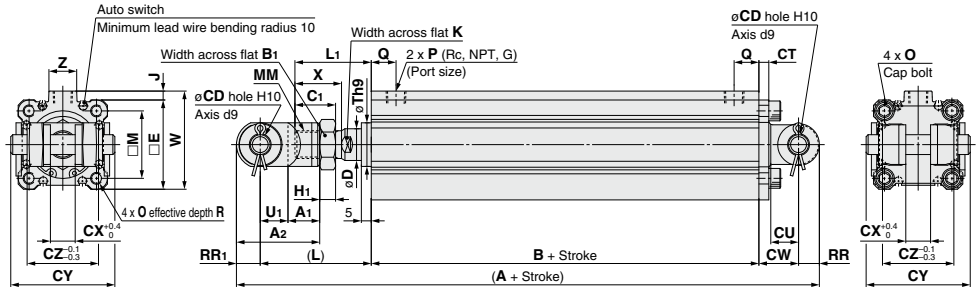

Note 1) Intermediate strokes (101 to 299 mm) are available in 1 mm increments.

For intermediate strokes, the dimensions are the same as a standard stroke one size larger than this intermediate stroke.

Note 2) Stroke length tolerance does not include the deflection of the bumper.

Note 3) Flat washers and split pins are included with the double clevis and double knuckle joint of this cylinder.

Note 4) Double clevis and double knuckle joint are shipped together with the product.

Bore size	Stroke range	A	B	CD	CT	CU	CW	CX			CY	CZ	D	E	J	K	L	M
								XC26A	XC26B	XC26C								
32		143.5	45.5	10	5	14	20	—	—	12.5	52.5	36	16	45	4.5	14	56	34
40	125, 150, 175,	155	55	10	6	14	22	16.5	19.5	12.5	52.5	36	16	52	5	14	56	40
50	200, 250, 300	182.5	55.5	14	7	20	28	16.5	19.5	12.5	66	44	20	64	7	17	69	50
63		186	57	14	8	20	30	16.5	19.5	12.5	66	44	20	77	7	17	69	60

Bore size	O	P	Q	R	RR	RR1	Th9	U1	W	Z	A1	B1	C1	H1	L1	MM	X	
32	M6 x 1.0	1/8	10	10	10	12	22 ^{0.052}	14	49.5	14	16	42	22	20.5	8	38.5	M14 x 1.5	23.5
40	M6 x 1.0	1/8	12.5	10	10	12	28 ^{0.052}	14	57	15	16	42	22	20.5	8	38.5	M14 x 1.5	23.5
50	M8 x 1.25	1/4	14	14	14	16	35 ^{0.062}	20	71	19	20	56	27	26	11	43.5	M18 x 1.5	28.5
63	M10 x 1.5	1/4	16.5	18	14	16	35 ^{0.062}	20	84	19	20	56	27	26	11	43.5	M18 x 1.5	28.5

Made to Order (Dimensions other than those shown below are the same as those shown above.)

■With coil scraper: C(D)Q2D-XC26-C35

■Spatter resistant specification for arc welding: CDQ2D-XC26-C88/C89

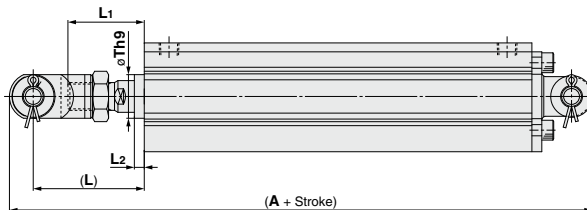

Bore size	Stroke range	XC35					XC88/XC89				
		A	L	L1	L2	Th9	A	L	L1	L2	Th9
32		143.5	56	38.5	5	23 ^{0.052}	148.5	56	38.5	10	23 ^{0.052}
40	125, 150, 175,	155	56	38.5	5	28 ^{0.052}	160	56	38.5	10	28 ^{0.052}
50	200, 250, 300	182.5	69	43.5	5	35 ^{0.062}	187.5	69	43.5	10	35 ^{0.062}
63		186	69	43.5	5	35 ^{0.062}	191	69	43.5	10	35 ^{0.062}

* XC88 and XC89 are only available for cylinders with built-in magnet for auto switch.

Made to Order Common Specifications:

-XC26□: Double Clevis Width 12.5 mm, 16.5 mm, 19.5 mm: With Double Clevis and Double Knuckle Joint



33 Double Clevis Width 12.5 mm, 16.5 mm, 19.5 mm: With Double Clevis and Double Knuckle Joint

CQ2□S series: Anti-lateral load

How to Order

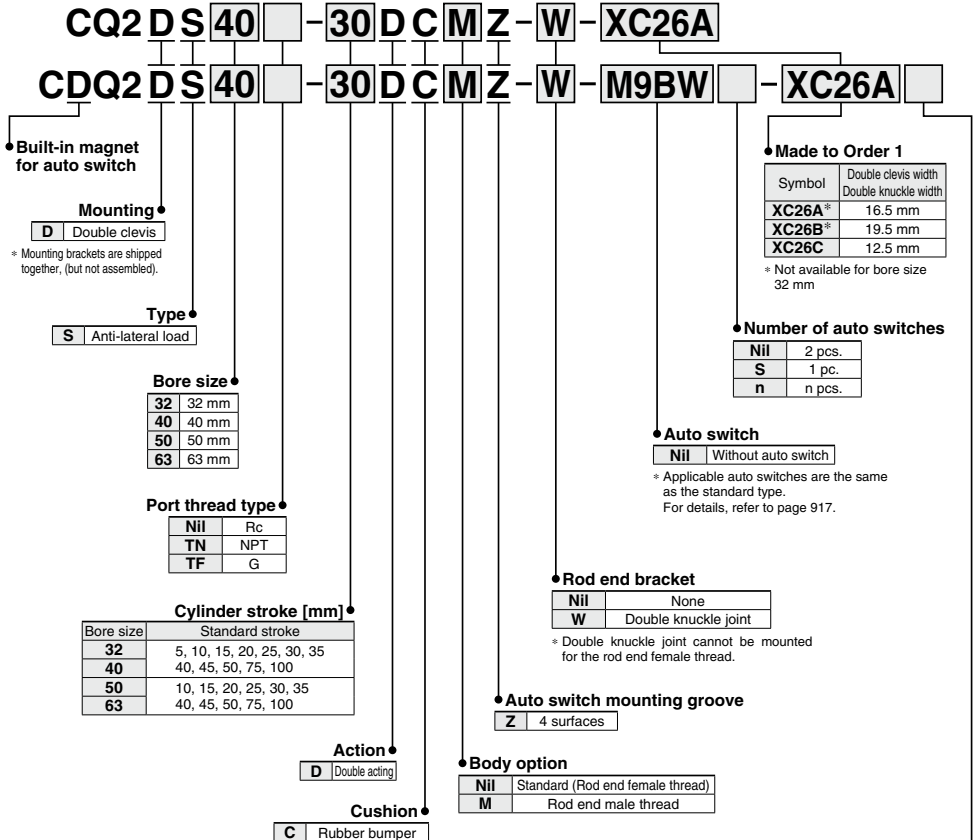

Ordering Example of Cylinder Assembly

When arranging Made to Order 1 and 2 at the same time
Cylinder model: **CDQ2DS40-30DCMZ-W-M9BW-XC26AC89**

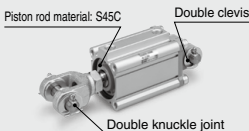

Mounting **D**: Double clevis
Rod end bracket W: Double knuckle joint
Made to Order 1 : XC26A
(Double clevis/knuckle width: 16.5 mm)
Made to Order 2 : XC89
(Piston rod material: S45C)
Auto switch **D-M9BW**: 2 pcs.

Made to Order 2

Symbol	Specification	Piston rod material (Hard chrome plated)		Coil scraper	Lube- retainer	Grease for welding
		S45C	Stainless steel 304			
Nil	None	—	—	—	—	—
XC88*	Spatter resistant spec. for arc welding	—	●	●	●	●
XC89*	Spatter resistant spec. for arc welding	●	—	●	●	●

* Only available for cylinders with built-in magnet for auto switch

Bore Size

Ø32 to Ø63 Anti-lateral Load

C(D)Q2DS-XC26

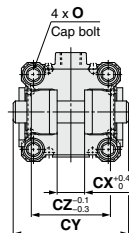
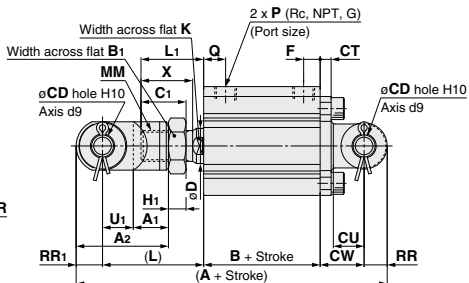
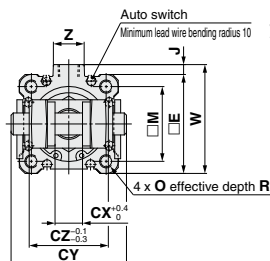

Note 1) Intermediate strokes (1 to 99 mm) are available in 1 mm increments.

For intermediate strokes, the dimensions are the same as a standard stroke one size larger than this intermediate stroke.

Note 2) Stroke length tolerance does not include the deflection of the bumper.

Note 3) Flat washers and split pins are included with the double clevis and double knuckle joint of this cylinder.

Note 4) Double clevis and double knuckle joint are shipped together with the product.

Bore size	Stroke range	Without magnet for auto switch		Built-in magnet for auto switch		CD	CT	CU	CW	CX			CY	CZ	D	E	F	J
		A	B	A	B					XC26A	XC26B	XC26C						
32	50 or less	121	33	131	43	10	5	14	20	—	—	12.5	52.5	36	16	45	7.5	4.5
	75, 100	131	43															
40	50 or less	129.5	39.5	139.5	49.5	10	6	14	22	16.5	19.5	12.5	52.5	36	16	52	7.5	5
	75, 100	139.5	49.5															
50	50 or less	157.5	40.5	167.5	50.5	14	7	20	28	16.5	19.5	12.5	66	44	20	64	10.5	7
	75, 100	167.5	50.5															
63	50 or less	165	46	175	56	14	8	20	30	16.5	19.5	12.5	66	44	20	77	10.5	7
	75, 100	175	56															

Bore size	K	L	M	O	P	Q	R	RR	RR1	U1	W	Z	A1	A2	B1	C1	H1	L1	MM	X
32	14	46	34	M6 x 1.0	1/8	10	10	10	12	14	49.5	14	16	42	22	20.5	8	28.5	M14 x 1.5	23.5
40	14	46	40	M6 x 1.0	1/8	12.5	10	10	12	14	57	15	16	42	22	20.5	8	28.5	M14 x 1.5	23.5
50	17	59	50	M8 x 1.25	1/4	10.5	14	14	16	20	71	19	20	56	27	26	11	33.5	M18 x 1.5	28.5
63	17	59	60	M10 x 1.5	1/4	15	18	14	16	20	84	19	20	56	27	26	11	33.5	M18 x 1.5	28.5

Made to Order (Dimensions other than those shown below are the same as those shown above.)

Spatter resistant specification for arc welding: CDQ2DS-XC26 C88/C89

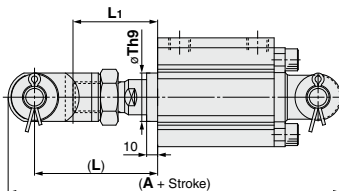

Bore size	Stroke range	XC88/XC89			
		A	L	L1	Th9
32	5, 10, 15, 20, 25, 30,	141	56	38.5	23.0 ^{+0.052}
40	35, 40, 45, 50, 75, 100	149.5	56	38.5	28.0 ^{+0.052}
50	10, 15, 20, 25, 30, 35,	177.5	69	43.5	35.0 ^{+0.052}
63	40, 45, 50, 75, 100	185	69	43.5	35.0 ^{+0.052}

Made to Order Common Specifications:

-XC26 Double Clevis Width 12.5 mm, 16.5 mm, 19.5 mm: With Double Clevis and Double Knuckle Joint



33 Double Clevis Width 12.5 mm, 16.5 mm, 19.5 mm: With Double Clevis and Double Knuckle Joint **-XC26**

Accessories

Double knuckle joint

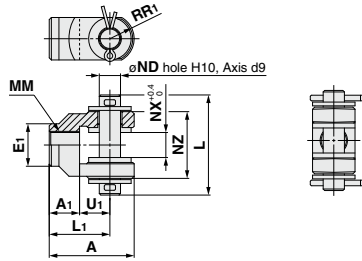

Part no.	Applicable bore size	A	A1	E1	L1	MM	RR1	U1	ND	NX	NZ	L
Y-G04-XC26A	32, 40	42	16	ø22	30	M14 x 1.5	12	14	10	16.5	36	52.5
Y-G04-XC26B										19.5		
Y-G04-XC26C										12.5		
Y-G05-XC26A	50, 63	56	20	ø28	40	M18 x 1.5	16	20	14	16.5	44	66
Y-G05-XC26B										19.5		
Y-G05-XC26C										12.5		

Note) A knuckle joint pin, 2 flat washers and 2 split pins are included.

Double clevis

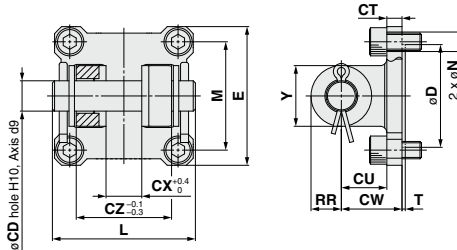

Part no.	Applicable bore size	D	E	M	N	T	CD	CT	CU	CW	CX	CZ	RR	L	Y
CQ-D032-XC26C	32	30.7	45	34	6.6	1	10	5	14	20	12.5	36	10	52.5	20
CQ-D040-XC26A											16.5				
CQ-D040-XC26B	40	39.1	52	40	6.6	1	10	6	14	22	16.5	36	10	52.5	20
CQ-D040-XC26C											19.5				
CQ-D050-XC26A											12.5				
CQ-D050-XC26A	50	48.5	64	50	9	1.5	14	7	20	28	16.5	44	14	66	28
CQ-D050-XC26B											19.5				
CQ-D050-XC26C											12.5				
CQ-D063-XC26A	63	61.3	77	60	11	2	14	8	20	30	16.5	44	14	66	28
CQ-D063-XC26B											19.5				
CQ-D063-XC26C											12.5				

Note) A clevis pin, 2 flat washers, 2 split pins and 4 hexagon socket head cap screws are included.

Made to Order Common Specifications: -XC27: Double Clevis and Double Knuckle Joint Pins Made of Stainless Steel



34 Double Clevis and Double Knuckle Joint Pins Made of Stainless Steel

Symbol
-XC27

To prevent the oscillating portion of the double clevis or the double knuckle joint from rusting, the material of the pin and the retaining ring has been changed to stainless steel.

Applicable Series

Series	Description	Model	Action	Vol. no. (for std model)
CM2	Standard type	CM2-Z	Double acting, Single rod (1) Single acting (Spring return/extend) (2)	②-1 From P. 172
	Non-rotating rod type	CM2K-Z	Double acting, Single rod (1) Single acting (Spring return/extend) (2)	
	End lock cylinder	CBM2	Double acting, Single rod	
	Smooth cylinder	CM2Y-Z	Double acting, Single rod	
CG1	Standard type	CG1-Z	Double acting, Single rod (1) Single acting (Spring return/extend) (2)	②-1 From P. 292
	Non-rotating rod type	CG1K-Z (2)	Double acting, Single rod (1)	
MB	Standard type	MB-Z	Double acting, Double rod (1)	②-1 From P. 392
	Non-rotating rod type	MBK-Z	Double acting, Single rod (1)	
	With end lock	MBB	Double acting, Single rod	
MB1	Smooth cylinder	MBY-Z	Double acting, Single rod (1)	②-1 From P. 440
	Standard type	MB1-Z	Double acting, Single rod (1)	
CA2	Non-rotating rod type	MB1K-Z	Double acting, Single rod (1)	②-1 From P. 470
	Standard type	CA2-Z	Double acting, Single rod (1)	
	End lock cylinder	CA2K	Double acting, Single rod	
	Smooth cylinder	CA2Y-Z	Double acting, Single rod	
CS1	Standard type	CS1	Double acting, Single rod	②-1 From P. 530
	Low friction	CS1Q	Double acting, Single rod	
CS2	Standard type	CS2	Double acting, Single rod	②-1 From P. 568
	Smooth cylinder	CS2Y	Double acting, Single rod	

Series	Description	Model	Action	Vol. no. (for std model)
CV	Valve mounted air cylinder	CVS1	Double acting, Single rod	②-3 From P. 832
		CVS1K	Double acting, Single rod	
CQS	Compact cylinder	CQS	Double acting, Single rod Single acting (Spring return/extend) (1)	②-1 From P. 693
	Long stroke	CQS	Double acting, Single rod	
	Anti-lateral load type	CQS□S	Double acting, Single rod	
	Non-rotating rod type	CQSK	Double acting, Single rod	
	Copper-free compact cylinder	20-CQS	Double acting, Single rod Single acting (Spring return/extend) (1)	
	Copper-free long stroke	20-CQS	Double acting, Single rod	
CQ2	Copper-free anti-lateral load type	20-CQS□S	Double acting, Single rod	②-1 From P. 773
	Compact cylinder	CQ2-Z	Double acting, Single rod (1) Single acting (Spring return/extend) (1)	
	Long stroke	CQ2-Z	Double acting, Single rod	
	Anti-lateral load type	CQ2□S-Z	Double acting, Single rod	
	Non-rotating rod type	CQ2K-Z	Double acting, Single rod	
	Magnetic field resistant	CDQ2□P	Double acting, Single rod	
	Copper-free compact cylinder	20-CQ2-Z	Double acting, Single rod Single acting (Spring return/extend) (1)	
	Copper-free long stroke	20-CQ2-Z	Double acting, Single rod	
Copper-free anti-lateral load type	20-CQ2□S-Z	Double acting, Single rod		

Note 1) Except cylinders with double knuckle joint bracket in How to Order

Note 2) Except ø80 and ø100 with rubber bumper

Except ø20, ø25, ø32, ø80, and ø100 with air cushion

How to Order

CQSD -XC27

CQ2D -XC27

CG1D -XC27

CM2D -XC27

CA2D -XC27

CS1D -XC27

CS2D -XC27

↓ Double clevis type

↓ Double clevis pin
made of stainless steel

Y - -XC27

Y - -XC27

Y - -XC27

Y - -XC27

Y - -XC27

↓ Double knuckle joint

↓ Double knuckle joint pin
made of stainless steel

IY - -XC27

IY - -XC27

CD - -XC27

CD - -XC27

CDP - -XC27

CDP - -XC27

↓ Clevis pin
Knuckle pin
made of stainless steel

• Clevis pin
Knuckle pin

* Stainless steel specification for IY-J015 is IY-J015SUS.

Specifications

Mounting type	Only double clevis type (D), Double knuckle joint only
Pin and retaining ring material	Stainless steel 304
Specifications other than above	Same as standard type

Made to Order Common Specifications: -XC28: Compact Flange Made of SS400



35 Compact Flange Made of SS400

Symbol
-XC28

Width of a flange bracket on the rod and head side has the same dimensions as the cylinder's rod cover to save the mounting space. (Flange shape and FV-dimensions are only different from the standard type.)

Applicable Series

Series	Description	Model	Action	Vol. no. (for std model)
CA2	Air cylinder	CA2-Z	Double acting, Single rod	②-1 From P. 470
		CA2W-Z	Double acting, Double rod	
	Non-rotating rod type	CA2K	Double acting, Single rod	
		CA2KW	Double acting, Double rod	
	With end lock	CBA2	Double acting, Single rod	
Smooth cylinder	CA2Y-Z	Double acting, Single rod		
CV	Valve mounted air cylinder	CVS1	Double acting, Single rod	②-3 From P. 832
		CVS1K	Double acting, Single rod	

How to Order

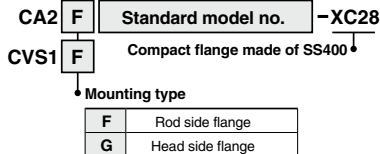

Specifications: Same as standard type

Dimensions

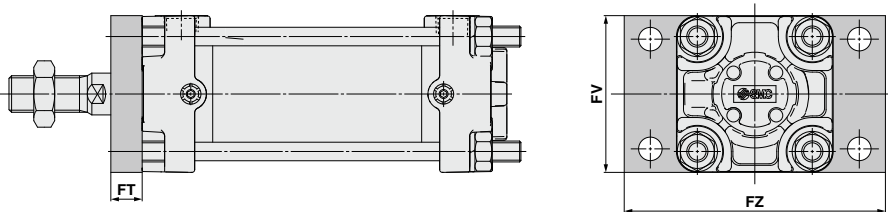

Bore size (mm)	(mm)		
	FT	FV	FZ
40	12	60	100
50	12	70	110
63	15	85	130
80	18	102	160
100	18	116	180

* Other dimensions are the same as flange on the rod side and head side of standard type. (Figure is the case of flange on the rod side.)

Made to Order Common Specifications: -XC29: Double Knuckle Joint with Spring Pin



36 Double Knuckle Joint with Spring Pin

Symbol
-XC29

To prevent loosening of the double knuckle joint of standard air cylinder (CM2/CA2 series)

Applicable Series

Series	Description	Model	Action	Vol. no. (for std model)
CM2	Air cylinder	CM2-Z	Double acting, Single rod (1) Single acting (Spring return) (1)	②-1 From P. 172
		CM2W-Z	Double acting, Double rod	
	CM2R-Z	Double acting, Single rod		
	Centralized piping type	CM2□□P	Double acting, Single rod	
	End lock cylinder	CBM2	Double acting, Single rod	
Smooth cylinder	CM2Y-Z	Double acting, Single rod		
CG1	Air cylinder	CG1-Z	Double acting, Single rod (1) Single acting (Spring return) (1) (2)	②-1 From P. 292

Note 1) Except cylinders with rod end bracket in How to Order
Note 2) Compatible with rubber bumper only

Series	Description	Model	Action	Vol. no. (for std model)
MB	Air cylinder	MB-Z [*]	Double acting, Single rod (1)	②-1 From P. 392
	Cylinder with end lock	MBB	Double acting, Single rod	
	Smooth cylinder	MBY-Z	Double acting, Single rod	
MB1	Air cylinder	MB1-Z [*]	Double acting, Single rod (1)	②-1 From P. 440
CA2	Air cylinder	CA2-Z	Double acting, Single rod (1)	②-1 From P. 470
	End lock cylinder	CBA2	Double acting, Single rod	
	Smooth cylinder	CA2Y-Z	Double acting, Single rod	
CV	Valve mounted air cylinder	CV3	Double acting, Single rod	②-3 From P. 812
		CVS1	Double acting, Single rod	

* Except ø125

How to Order

Standard model no. **-XC29**
Double knuckle joint with spring pin ↓

Specifications: Same as standard type

Dimensions (For mounting bracket, pin is shipped together.)

CM2 series

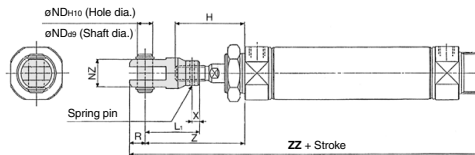

Bore size (mm)	H	L ₁	NDH ₁₀	NZ	R	Z	ZZ	Spring pin
20	41	36	9 ^{+0.058} ₀	18	10	61	146	ø3 x 16L
25	45	38	9 ^{+0.058} ₀	18	10	65	150	ø3 x 16L
32	45	38	9 ^{+0.058} ₀	18	10	65	152	ø3 x 16L
40	50	55	12 ^{+0.070} ₀	38	13	83	200	ø4 x 24L

* Other dimensions are the same as standard type.

CA2 series CV series

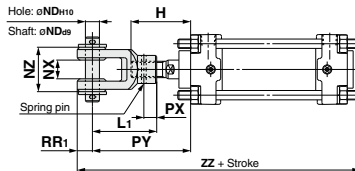

Bore size (mm)	H	L ₁	PX	PY	ZZ	RR ₁	øND	H10	d _e	NX	NZ	Spring pin
40	51	55	11	84	192	13	12	+0.070 0	-0.050 -0.093	16 ^{+0.3} -0.1	38	ø4 x 24L
50	58	60	12	91	207	15	12	+0.070 0	-0.050 -0.093	16 ^{+0.3} -0.1	38	ø4 x 25L
63	58	60	12	91	218	15	12	+0.070 0	-0.050 -0.093	16 ^{+0.3} -0.1	38	ø4 x 25L
80	71	71	16	105	257	19	18	+0.070 0	-0.050 -0.093	28 ^{+0.3} -0.1	55	ø4 x 36L
100	72	83	16	118	282	21	20	+0.084 0	-0.065 -0.117	30 ^{+0.3} -0.1	61	ø4 x 40L

* Dimensions except mentioned above are the same as standard type.



Made to Order Common Specifications: -XC30: Rod Side Trunnion



37 Rod Side Trunnion

This cylinder shortens the distance between the fulcrum and the rod end by installing a trunnion bracket in front of the rod side cover.

Applicable Series

Series	Description	Model	Action	Vol. no. (for std model)
MB	Standard type	MB-Z*	Double acting, Single rod	②-1 From P. 392
		MBW-Z*	Double acting, Double rod	
	Non-rotating rod type	MBK-Z	Double acting, Single rod	
	MBKW-Z	Double acting, Double rod		
	Cylinder with end lock	MBB	Double acting, Single rod	
Smooth cylinder	MBY-Z	Double acting, Single rod		
MB1	Standard type	MB1-Z*	Double acting, Single rod	②-1 From P. 440
	Non-rotating rod type	MB1W-Z*	Double acting, Double rod	
CA2	Air cylinder	CA2-Z	Double acting, Single rod	②-1 From P. 470
	Smooth cylinder	CA2Y-Z	Double acting, Single rod	
CS1	Standard type	CS1	Double acting, Single rod	②-1 From P. 530
		CS1W	Double acting, Double rod	
	Low friction	CS1Q	Double acting, Single rod	
CS2	Standard type	CS2	Double acting, Single rod	②-1 From P. 568
		CS2W	Double acting, Double rod	
	Smooth cylinder	CS2Y	Double acting, Single rod	

* Except $\phi 125$

How to Order

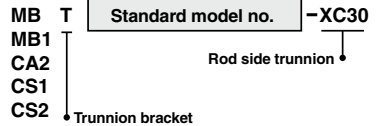

Specifications: Same as standard type

Dimensions (Dimensions other than below are the same as standard type.)

CA2 series

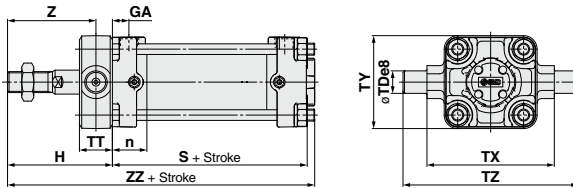

(mm)

Symbol Bore size	n	GA	H	S	TDe8	TT	TX	TY	TZ	Z	ZZ
40	23	11	66	80	15 ^{-0.032} _{-0.050}	22	85	62	117	55	151
50	26	13	71	86	15 ^{-0.032} _{-0.050}	22	95	74	127	60	163
63	27	13	79	94	18 ^{-0.032} _{-0.050}	28	110	90	148	65	179
80	32	16	94.5	111	25 ^{-0.040} _{-0.073}	34	140	110	192	77.5	212.5
100	35	16	100	121	25 ^{-0.040} _{-0.073}	40	162	130	214	80	229

MB series

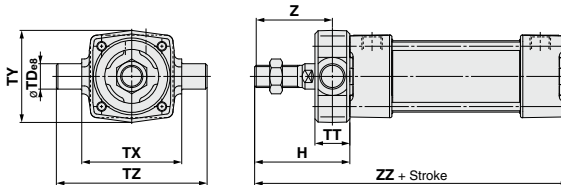

(mm)

Bore size	H	$\phi TDe8$	TT	TX	TY	TZ	Z	ZZ
32	47	12 ^{-0.032} _{-0.050}	17	50	49	74	38.5	135
40	60	16 ^{-0.032} _{-0.050}	22	63	58	95	49	148
50	66	16 ^{-0.032} _{-0.050}	22	75	71	107	55	164
63	72	20 ^{-0.040} _{-0.073}	28	90	87	130	58	170
80	86	20 ^{-0.040} _{-0.073}	34	110	110	150	69	204
100	92	25 ^{-0.040} _{-0.073}	40	132	136	182	72	210

* Dimensions except mentioned above are the same as standard type.

Dimensions (Dimensions other than below are the same as standard type.)

MB1 series

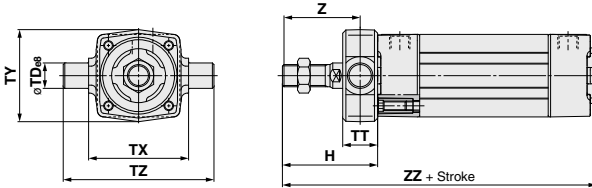

Bore size	H	TDø8	TT	TX	TY	TZ	Z	ZZ
32	47	12 ^{+0.032} _{-0.059}	17	50	49	74	38.5	135
40	60	16 ^{+0.038} _{-0.059}	22	63	58	95	49	148
50	66	16 ^{+0.038} _{-0.059}	22	75	71	107	55	164
63	72	20 ^{+0.040} _{-0.073}	28	90	87	130	58	170
80	86	20 ^{+0.040} _{-0.073}	34	110	110	150	69	204
100	92	25 ^{+0.040} _{-0.073}	40	132	136	182	72	210

* Dimensions except mentioned above are the same as standard type.

CS1 series

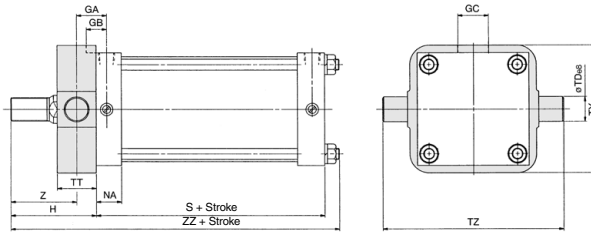

Bore size (mm)	Symbol	GA	GB	GC	NA	S	TDø8	TT	TY	TZ	H	Z	ZZ
125		38	23	45	32	95	32 ^{-0.050} _{-0.089}	50	164	234	113	88.0	227
140		40.5	23	45	32	95	36 ^{-0.050} _{-0.089}	55	184	262	113	85.5	227
160		45.5	25.5	50	36	103	40 ^{-0.050} _{-0.089}	60	204	292	123	93.0	248
180		45	25.5	50	36	108	45 ^{-0.050} _{-0.089}	59	228	326	138	108.5	272
200		45	25.5	50	36	108	45 ^{-0.050} _{-0.089}	59	257	355	138	108.5	272
250		54.5	30	60	46	138	56 ^{-0.060} _{-0.106}	69	325	447	163	128.5	331
300		59.5	30	70	46	143	67 ^{-0.060} _{-0.106}	79	390	534	178	138.5	357

* Dimensions except mentioned above are the same as standard type.

CS2 series

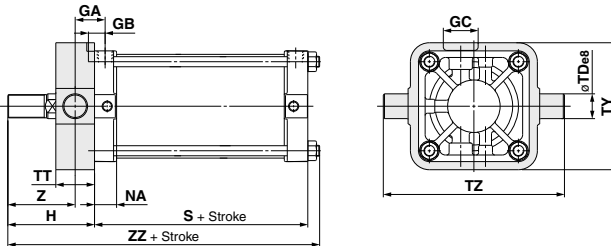

Bore size (mm)	GA	GB	GC	NA	S	TDø8	TT	TY	TZ	H	Z	ZZ
125	38	23	45	28.5	96	32 ^{-0.050} _{-0.089}	50	164	234	112	87	221
140	40.5	23	45	28.5	96	36 ^{-0.050} _{-0.089}	55	184	262	112	84.5	221
160	46	26	50	32.5	104	40 ^{-0.050} _{-0.089}	60	204	292	122	92	241



Made to Order Common Specifications: -XC34: Non-rotating Plate with Workpiece Mounting Screw (No extended part on the rod end)



38 Non-rotating Plate with Workpiece Mounting Screw (No extended part on the rod end) **-XC34**

The plate has workpiece mounting screws.
The dimension FL, the distance between a non-rotating plate to piston rod end, has been eliminated.
The piston rod does not protrude from the plate.

Applicable model no. **-XC34**

Applicable Series

Series	Description	Model	Action	Vol. no. (for std model)
CU	Non-rotating rod	CUK	Double acting, Single rod	②-1 From P. 666
	Non-rotating rod	CUK	Single acting, Single rod (Spring return/extend)	
	Non-rotating rod/Long stroke	CUK	Double acting, Single rod	

Dimensions

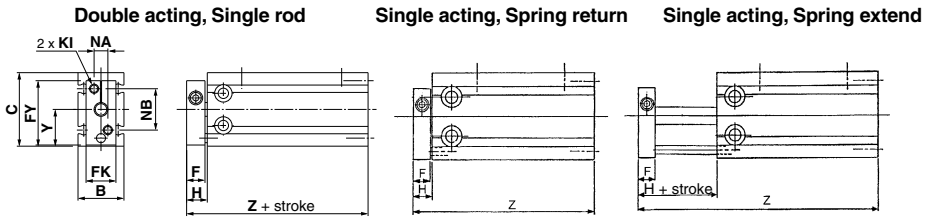

(mm)

Bore size (mm)	B	C	FK	FY	KI	NA	NB	Y
6	13	22	11	20.5	M3 x 0.5	6	14	10.5
10	15	24	12	22	M3 x 0.5	7	15	11.5
16	20	32	13	28	M4 x 0.7	6	18	15.5
20	26	40	16	33	M4 x 0.7	8	20	19.5
25	32	50	20	43.5	M5 x 0.8	10	28	24.5
32	40	62	24	51.5	M5 x 0.8	12	32	30.5

(mm)

Bore size (mm)	Action	F	H	Z													
				Double acting		Single acting (Spring return)						Single acting (Spring extend)					
				Without switch	With switch	Without switch			With switch			Without switch			With switch		
5st	10st	15st	5st	10st	15st	5st	10st	15st	5st	10st	15st	5st	10st	15st			
6	8	9	42	42	47	52	57	47	52	57	52	62	67	52	62	67	
10	8	9	45	45	50	55	65	50	55	65	55	65	80	55	65	80	
16	8	9	39	49	44	49	59	54	59	69	59	69	84	69	79	94	
20	8	9	45	55	50	55	65	60	65	75	55	65	80	65	75	90	
25	10	11	51	61	56	61	71	66	71	81	61	71	86	71	81	96	
32	12	13	55	65	60	65	75	70	75	85	65	75	90	75	85	100	

* Dimensions except mentioned above are the same as standard type.

Made to Order Common Specifications: -XC35: With Coil Scraper



39 With Coil Scraper

Symbol
-XC35

It gets rid of frost, ice, weld spatter, cutting chips adhered to the piston rod, and protects the seals, etc.

Applicable Series

Series	Description	Model	Action	Note	Vol. no. (for std model)
CM2	Air cylinder	CM2-Z	Double acting, Single rod	Except with air cushion	②-1 From P. 172
		CM2W-Z	Double acting, Double rod	Except with air cushion	
	Cylinder with end lock	CBM2	Double acting, Single rod	Lock in head end only (Except with air cushion)	
CG1	Air cylinder	CG1-Z	Double acting, Single rod		②-1 From P. 292
MB	Air cylinder	MB-Z	Double acting, Single rod	Except ø125	②-1 From P. 392
		MBW-Z	Double acting, Double rod	Except ø125	
MB1	Air cylinder	MB1-Z	Double acting, Single rod		②-1 From P. 440
		MBW-Z	Double acting, Double rod		
CA2	Air cylinder	CA2-Z	Double acting, Single rod		②-1 From P. 470
		CA2W-Z	Double acting, Double rod		
	Cylinder with end lock	CBA2	Double acting, Single rod		
CS1	Air cylinder	CS1	Double acting, Single rod		②-1 From P. 530
		CS1W	Double acting, Double rod		
CS2	Air cylinder	CS2	Double acting, Single rod		②-1 From P. 568
		CS2W	Double acting, Double rod		
CQ2	Compact cylinder	CQ2-Z	Double acting, Single rod	Applicable to ø32 to ø100	②-1 From P. 773
		CQ2W-Z	Double acting, Double rod	Applicable to ø32 to ø100	
		CQP2	Double acting, Single rod	Applicable to ø32 to ø100, Except with bracket	
	Long stroke	CQ2-Z	Double acting, Single rod	Applicable to ø32 to ø100	
RQ	Compact cylinder with air cushion	RQ	Double acting, Single rod	Applicable to ø32 to ø100	②-1 From P. 985
MNB	Cylinder with lock	MNB	Double acting, Single rod		②-2 From P. 890
CNA2	Cylinder with lock	CNA2	Double acting, Single rod		②-2 From P. 922
CNG	Cylinder with lock	CNG	Double acting, Single rod		②-2 From P. 866
CLS	Cylinder with lock	CLS	Double acting, Single rod	Applicable to ø125 to ø160 (ø180 to ø250 as standard)	②-2 From P. 982
CLQ	Compact cylinder with lock	CLQ	Double acting, Single rod	Applicable to ø40 to ø100	②-2 From P. 1008
CV	Valve mounted cylinder	CVS1	Double acting, Single rod		②-3 From P. 832
MGP	Compact guide cylinder	MGPM-Z	Double acting	Applicable to ø20 to ø100	②-2 From P. 432
		MGPL-Z	Double acting	Applicable to ø20 to ø100	
		MGPA-Z	Double acting	Applicable to ø20 to ø100	
MGG	Guide cylinder	MGG	Double acting	Applicable to ø32 to ø100	②-2 From P. 538
MGC	Guide cylinder	MGC	Double acting	Applicable to ø32 to ø50	②-2 From P. 578

How to Order

Standard model no. – XC35
 With coil scraper

* For MGP series, refer to page 1827.

Specifications: Same as standard type



Made to Order Common Specifications: -XC35: With Coil Scraper



39 With Coil Scraper

Dimensions (Dimensions other than below are the same as standard type.)

The dimensions of the CS2 series are the same as the standard type.

CS1 series

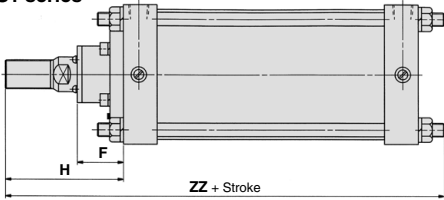

Bore size (mm)	Without auto switch			With auto switch		
	F	H	ZZ	F	H	ZZ
125	50	120	245	50	120	245
140	50	120	245	50	120	245
160	50	130	266.5	50	130	266.5
180	55	145	291	55	145	295
200	55	145	291	55	145	300
250	69	175	357.5	—	—	—
300	69	190	387.5	—	—	—

MB series

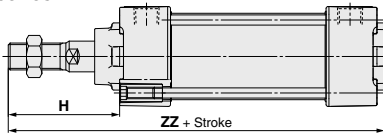

Bore size	(mm)	
	H	ZZ
32	47	135
40	58	146
50	67	165
63	67	165
80	81	199
100	81	199

MB1 series

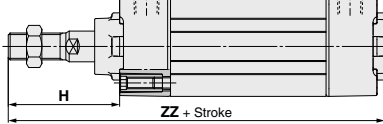

Bore size	(mm)	
	H	ZZ
32	47	135
40	58	146
50	67	165
63	67	165
80	81	199
100	81	199

CG1 series

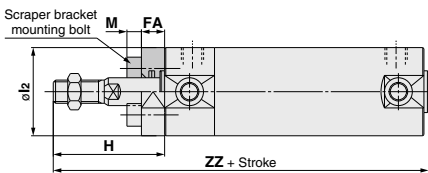

Bore size	Stroke range		FA	H		l ₂	M	ZZ	
	Standard	Long stroke		Male thread	Female thread			Male thread	Female thread
20	Up to 200	201 to 1500	6	39	27	27	4	110 (118)	98 (106)
25	Up to 300	301 to 1500	6	44	28	32	5	115 (123)	99 (107)
32	Up to 300	301 to 1500	6	44	28	38	5	117 (125)	101 (109)
40	Up to 300	301 to 1500	7	54	29	47	3.5	134 (143)	109 (118)
50	Up to 300	301 to 1500	7	62	30	58	4.5	154 (166)	122 (134)
63	Up to 300	301 to 1500	7	62	30	72	5.5	154 (166)	122 (134)

Note) () : Long stroke

- * Other dimensions are the same as the double acting, single rod type.
- * On the axial foot and rod side flange types, the mounting bracket is wedged and bolted between the cylinder and the scraper at the time of shipment. Others are shipped together (but not assembled).
- * The long stroke shows the maximum manufacturable stroke. For details about maximum stroke that can be used for each mounting bracket, refer to the stroke selection table on front matter pages.

CQ2 series

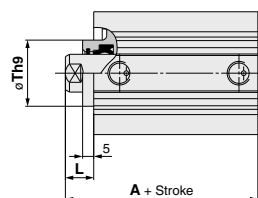

Bore size	A			L		T
	Standard type, Axial piping type		Long stroke	Standard type, Axial piping type	Long stroke	
	50 stroke or less	75, 100 stroke	125 to 300 stroke	100 stroke or less	125 to 300 stroke	
32	35 (45)	45	62.5	12	17	23 ⁰ _{-0.062}
40	41.5 (51.5)	51.5	72	12	17	28 ⁰ _{-0.062}
50	43.5 (53.5)	53.5	73.5	13	18	35 ⁰ _{-0.062}
63	49 (59)	59	75	13	18	35 ⁰ _{-0.062}
80	58.5 (68.5)	68.5	86	15	20	43 ⁰ _{-0.062}
100	70 (80)	80	97.5	17	22	59 ⁰ _{-0.074}

* () : Denotes the dimensions with auto switch magnet.

Dimensions (Dimensions other than below are the same as standard type.)

CQ2W series

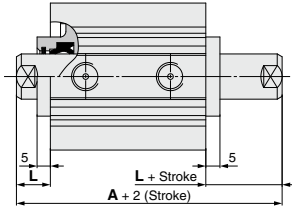

Bore size	A		L
	50 stroke or less	75, 100 stroke	
32	54.5 (64.5)	64.5	12
40	64 (74)	74	12
50	66.5 (76.5)	76.5	13
63	68 (78)	78	13
80	81 (91)	91	15
100	94.5 (104.5)	104.5	17

* () : Denotes the dimensions with auto switch magnet.

RQ series

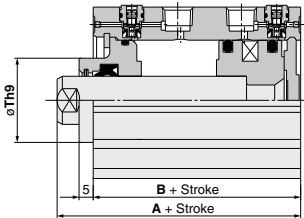

Bore size (mm)	A	B	Th9
32	49	37	23 ⁰ _{-0.052}
40	56	44	28 ⁰ _{-0.052}
50	62.5	49.5	35 ⁰ _{-0.062}
63	68	55	35 ⁰ _{-0.062}
80	78.5	63.5	43 ⁰ _{-0.062}
100	93	76	59 ⁰ _{-0.074}

CBA2 series

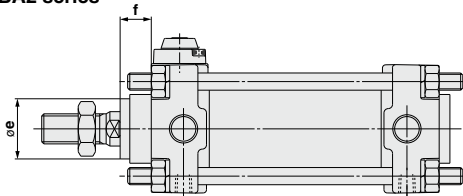

Bore size (mm)	øe	f	
		With rod side locking.	With both-side locking
40	28	14.5	
50	32	16.5	
63	32	14	
80	37	16	
100	44	17.5	

The above diagram shows the rod side locking and manual releasing non-locking types.
The CBA2 series head side locking type is the same as the standard type.
The dimensions of the manual releasing non-locking type are the same as indicated above.

CNG series

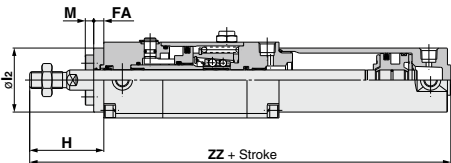

Bore size (mm)	FA	M	l ₂	H	ZZ
20	6	4	27	39	182
25	6	5	32	44	197
32	6	5	38	44	200
40	7	6	48	54	225
					ZZ
					190
					205
					208
					234

Long stroke

CNA2 series

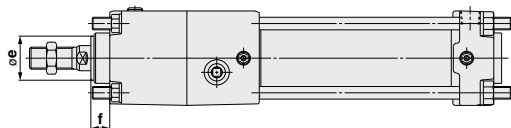

Bore size (mm)	e	f
40	28	12
50	32	12.5
63	32	12.5
80	37	16.5
100	44	17

* Other dimensions are the same as the standard type. (The figure shows a type with a rubber bumper.)

* On the axial foot and rod side flange types, the mounting bracket is wedged and bolted between the cylinder and the scraper at the time of shipment.



Made to Order Common Specifications: -XC35: With Coil Scraper



39 With Coil Scraper

Dimensions (Dimensions other than below are the same as standard type.)

MNB series

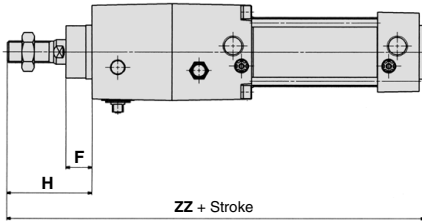

Bore size (mm)	F	H	ZZ
32	16	47	205
40	18	56	221
50	19	63	250
63	19	63	264
80	25	77	326
100	25	77	346

CLS series

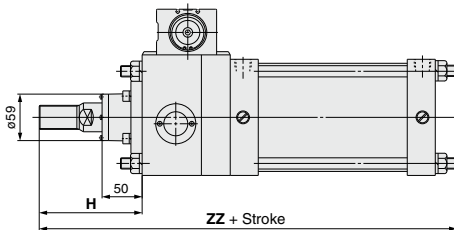

Bore size (mm)	H	ZZ
125	120	355
140	120	355
160	130	398.5

* ø180 to ø250: A coil scraper is attached as standard.

CLQ series

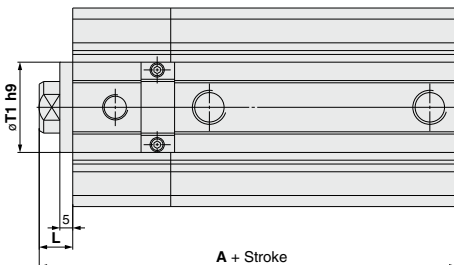

Bore size (mm)	Stroke range (mm)	A		L	T1 h9
		Without auto switch	With auto switch		
40	10 to 50	75.5	85.5	12	28 ⁰ _{-0.052}
	75,100	85.5			
50	10 to 50	78.5	88.5	13	35 ⁰ _{-0.062}
	75,100	88.5			
63	10 to 50	87	97	13	35 ⁰ _{-0.062}
	75,100	97			
80	10 to 50	101.5	111.5	15	43 ⁰ _{-0.062}
	75,100	111.5			
100	10 to 50	120	130	17	59 ⁰ _{-0.074}
	75,100	130			

How to Order

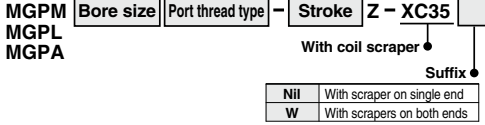

Specifications

Applicable series		MGPM	MGPL, MGPA
Bearing type		Slide bearing	Ball bushing bearing
Bore size (mm)		20, 25, 32, 40, 50, 63, 80, 100	
Minimum operating pressure	With single end	0.12 MPa	
	With both ends	0.14 MPa	

* Specifications other than above are the same as standard type.

Dimensions (Dimensions other than below are the same as standard type.)

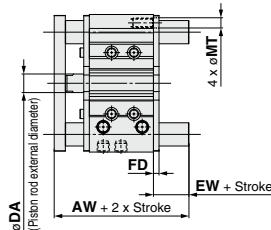
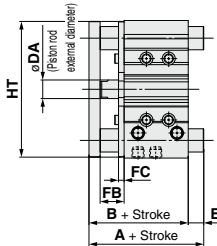

For cylinder with both sides scraper

Common Dimensions:

Bore size (mm)	B	DA	FB	FC	
				MGPM	MGPL/MGPA
20	63	10	18	5	5
25	63.5	10	17	6	5
32	69.5	14	22	6	5
40	76	14	22	6	5
50	82	20	26	6	5
63	87	20	26	6	5
80	106.5	25	34	8	6
100	126	30	41	9	6

With Both Sides Scraper

Dimensions: AW, EW, FD, MT (mm)

Bore size (mm)	AW	EW	FD	MT
20	74	6	5	6
25	74.5	6	5	7
32	82.5	7	6	9
40	89	7	6	8.5
50	95	7	6	11
63	100	7	6	11
80	120.5	8	6	14
100	143	8	9	16

MGPM (Slide bearing) A, E, HT Dimensions (mm)

Bore size (mm)	A			E			HT
	50 st or less	Over 50 st to 200 st	Over 200 st	50 st or less	Over 50 st to 200 st	Over 200 st	
20	63	87.5	120	0	24.5	57	80
25	63.5	87.5	119.5	0	24	56	93
32	85	103.5	139.5	15.5	34	70	110
40	85	103.5	139.5	9	27.5	63.5	118
50	98.5	119.5	160.5	16.5	37.5	78.5	146
63	98.5	119.5	160.5	11.5	32.5	73.5	160
80	114.5	141.5	190.5	8	35	84	199
100	136.5	161.5	200.5	10.5	35.5	74.5	236

MGPL, MGPA (Ball bushing bearing) A, E, HT Dimensions (mm)

Bore size (mm)	A				E				HT
	30 st or less	Over 30 st to 100 st	Over 100 st to 200 st	Over 200 st	30 st or less	Over 30 st to 100 st	Over 100 st to 200 st	Over 200 st	
20	69	86	110	127.5	6	23	47	64.5	80
25	75.5	91.5	110.5	127.5	12	28	47	64	93

Bore size (mm)	A				E				HT
	50 st or less	Over 50 st to 100 st	Over 100 st to 200 st	Over 200 st	50 st or less	Over 50 st to 100 st	Over 100 st to 200 st	Over 200 st	
32	89.5	106.5	126.5	148.5	20	37	57	79	110
40	89.5	106.5	126.5	148.5	13.5	30.5	50.5	72.5	118
50	101.5	122.5	142.5	169.5	19.5	40.5	60.5	87.5	146
63	101.5	122.5	142.5	169.5	14.5	35.5	55.5	82.5	160

Bore size (mm)	A				E				HT
	25 st or less	Over 25 st to 50 st	Over 50 st to 200 st	Over 200 st	25 st or less	Over 25 st to 50 st	Over 50 st to 200 st	Over 200 st	
80	114.5	138.5	168.5	201.5	8	32	62	95	199
100	129.5	155.5	188.5	211.5	3.5	29.5	62.5	85.5	236



Made to Order Common Specifications: -XC35: With Coil Scraper



39 With Coil Scraper

Symbol
-XC35

How to Order

MGG -XC35
MGC -XC35
With coil scraper ●

Specifications: Same as the standard type of each series

Note 1) Except $\phi 20$ and $\phi 25$

Note 2) Coil scrapers are attached to the piston rod and guide rods (front and back).

Dimensions (Dimensions other than below and the MGG□B series ($\phi 63$ to $\phi 100$) are the same as standard type.)

MGG□B series

$\phi 32$ to $\phi 50$

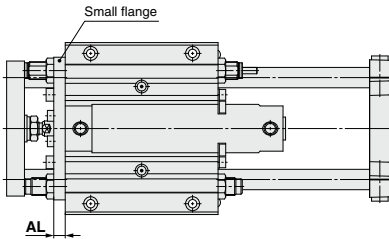

(mm)	
Bore size (mm)	AL
32	9
40	12
50	12

MGC□B series

$\phi 32$ to $\phi 50$

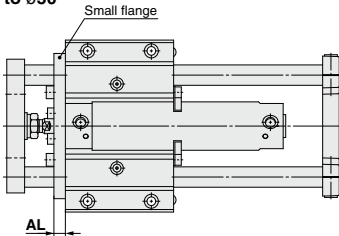

(mm)	
Bore size (mm)	AL
32	9
40	12
50	12

Made to Order Common Specifications:

-XC36: With Boss in Rod Side

-XC37: Larger Throttle Dia. of Connection Port



40 With Boss in Rod Side

Symbol
-XC36

Cylinder with boss in rod side

Applicable Series

Series	Description	Model	Action	Vol. no. (for std model)
CQS	Compact cylinder	CQS	Double acting, Single rod	②-1 From P. 693
		CQSW	Double acting, Double rod	
CQ2	Compact cylinder	CQ2-Z	Double acting, Single rod Single acting (Spring return/bleed)	②-1 From P. 773
		CQ2W-Z	Double acting, Double rod	
	Axial piping type (Centralized piping type)	CQP2	Double acting, Single rod Single acting (Spring return/bleed)	

Note 1) For the double rod type, it comes with boss for both sides.
 Note 2) Except with bracket
 Note 3) ø125 or more is excluded in CQ2.

How to Order

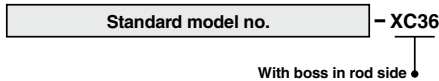

Specifications: Same as standard type

Dimensions

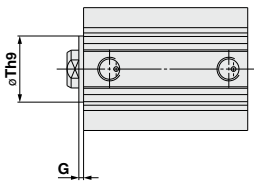

Series	CQ2		CQS	
	Th9	G	Th9	G
12	15 ⁰ _{-0.043}	1.5	15 ⁰ _{-0.043}	1.5
16	20 ⁰ _{-0.052}	1.5	20 ⁰ _{-0.052}	1.5
20	13 ⁰ _{-0.043}	2	13 ⁰ _{-0.043}	2
25	15 ⁰ _{-0.043}	2	15 ⁰ _{-0.043}	2
32	21 ⁰ _{-0.052}	2	—	—
40	28 ⁰ _{-0.052}	2	—	—
50	35 ⁰ _{-0.062}	2	—	—
63	35 ⁰ _{-0.062}	2	—	—
80	43 ⁰ _{-0.062}	2	—	—
100	59 ⁰ _{-0.074}	2	—	—

* Dimensions except mentioned above are the same as standard type.

41 Larger Throttle Diameter of Connection Port

Symbol
-XC37

This is a cylinder with a piping port larger than the standard type.

Applicable Series

Series	Description	Model	Action	Vol. no. (for std model)
CG1	Air cylinder	CG1-Z	Double acting, Single rod	②-1 From P. 292
	Double rod type	CG1W-Z	Double acting, Double rod	
MGG	Guide Cylinder	MGG	Double acting	②-2 From P. 538
MGC	Guide Cylinder	MGC	Double acting	②-2 From P. 578

Note 1) Except ø80, 100

How to Order

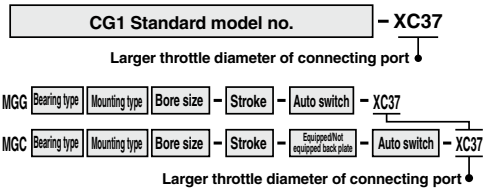

Specifications: Same as standard type

Dimensions (Throttle diameter of connection port)

Dimensions other than below are the same as standard type.

CG1 Series (mm)

Bore size (mm)	With rubber bumper	With air cushion	Standard type
20	5	3	(2.1)
25	5	3.5	(2.5)
32	6	6	(3.3)
40	7	7	(3.9)
50	9	9	(4.5)
63	9	9	(5.7)

* Use external stopper, etc. not to be damaged with cylinder cover directly if exceeding the range of kinetic energy absorption.

MGG Series (mm)

Bore size (mm)	Throttle dia. (ø)
20	5
25	5
32	6
40	7
50	9
63	9

MGC Series (mm)

Bore size (mm)	Throttle dia. (ø)
20	3
25	3.5
32	6
40	7
50	9



Made to Order Common Specifications: -XC38: Vacuum (Rod through-hole)



42 Vacuum (Rod through-hole)

Symbol
-XC38

Through-hole of hollow rod can be used as the passage of vacuum air.

Applicable Series

Series	Description	Model	Action	Note	Vol. no. (for std model)
CM2	Air cylinder/Standard type	CM2W-Z	Double acting, Double rod		②-1 From P. 193
MTS	Precision cylinder	MTS	Double acting, Single rod	Available only for ø8 female thread	②-2 From P. 384

How to Order

CM2 Standard model no.

-XC38

Vacuum (Rod through-hole)



Construction/Dimensions

(Other dimensions are the same as standard.)

CM2W series

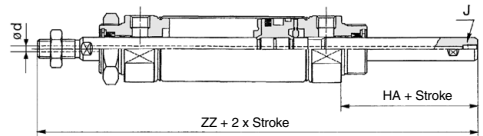

Bore size (mm)	d	J	HA	ZZ
20	3	M5 x 0.8	32	135
25	3	M5 x 0.8	32	139
32	3	M5 x 0.8	32	141
40	4	Rc1/8	36	174

Specifications: Same as standard type

MTS8 - Stroke (P) -XC38

Axial piping type

Vacuum (Rod through-hole)



Dimensions

MTS8 series

Use ø4/ø2.5 urethane tube (TU0425) or use soft nylon tube (TS0425).

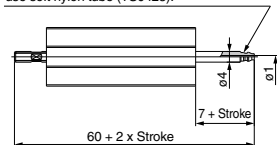

⚠ Caution

1. Blow air for through-hole.

Flush the through-hole which is a passage for air pressure and vacuum to prevent dust.

Specifications

Bore size (mm)	8
Piping direction	Standard piping type, Axial piping type
Rod end configuration	Female thread

Made to Order Common Specifications: -XC42: Built-in Shock Absorber in Head Cover Side



43 Built-in Shock Absorber in Head Cover Side

Symbol
-XC42

A type of the CG1 series air cylinder in which a special shock absorber is enclosed in the head portion so that its ability to absorb energy during the retraction of the cylinder is considerably greater than the current air cushion.

Applicable Series

Series	Description	Model	Action	Note	Vol. no. (for std model)
CG1	Air cylinder	CG1-Z	Double acting, Single rod	Except head side trunnion and clevis types	②-1 From P. 292

How to Order

CG1 Standard model no. -XC42
Built-in shock absorber in head cover side ↓



Specifications

Piston speed	50 to 1000 mm/s
Additional specifications	Same as standard type

* On the axial foot and head side flange types, the bracket is mounted at the time of shipment. Others are shipped together (but not assembled).

Construction/Dimensions (Other dimensions are the same as CG1 long stroke cylinder.)

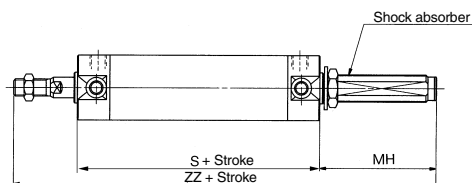

The shock absorber service life is different from that of the CG1 cylinder. Refer to the RB series Specific Product Precautions for the replacement period.

(mm)

Bore (mm)	Stroke range	Shock absorber	S	MH	ZZ
20	10 to 350	RBAC0806	77	23.5	135.5
25	10 to 400	RBAC1007	77	31	148
32	15 to 450	RBAC1412	79	55	174
40	15 to 800	RBAC2015	87	62.5	199.5
50	15 to 1200	RBAC2015	102	55.5	215.5
63	25 to 1200	RBAC2725	102	92.5	252.5

* Shock absorbers are consumables.

The specifications for shock absorbers are the same as RBC□□□□, but use RBAC□□□□ when an external pressure is applied such as for a built-in cylinder.

The maximum absorption energy may decrease depending on the operating conditions.

Made to Order Common Specifications: -XC51: With Hose Nipple -XC52: Mounting Nut with Set Screw



44 With Hose Nipple

Symbol
-XC51

The one with hose nipple attached in order to save time for assembly at the time of shipment.

Applicable Series

Series	Description	Model	Action	Vol. no. (for std model)
CJ2	Air cylinder	CJ2-Z	Double acting, Single rod Single acting (Spring return/absent)	②-1 From P. 46
		CJ2W-Z	Double acting, Double rod	
	Non-rotating rod type	CJ2K-Z	Double acting, Single rod Single acting (Spring return/absent)	
		CJ2Z-Z	Double acting, Single rod	
	With speed controller	CJ2Z-Z	Double acting, Double rod	
		CJ2W-Z	Double acting, Single rod	
	Low friction type	CJ2□Q	Double acting, Single rod	
	Direct mount type	CJ2RA-Z	Double acting, Single rod Single acting (Spring return/absent)	
		CJ2RK-Z	Double acting, Single rod Single acting (Spring return/absent)	

45 Mounting Nut with Set Screw

Symbol
-XC52

In order to prevent the mounting nut from being loosen, set screw should be tighten from the two directions to fix the mounting nut.

Applicable Series

Series	Description	Action	Action	Vol. no. (for std model)
CM2	Air cylinder	CM2-Z	Double acting, Single rod Single acting (Spring return/absent)	②-1 From P. 172
		CM2W-Z	Double acting, Double rod	
	Non-rotating rod type	CM2K-Z	Double acting, Single rod Single acting (Spring return/absent)	
		CM2KW-Z	Double acting, Double rod	
	Centralized piping type	CM2□P-Z	Double acting, Single rod	
	End lock cylinder	CBM2	Double acting, Single rod	
	Smooth cylinder	CM2Y-Z	Double acting, Single rod	
	Low speed cylinder	CM2X-Z	Double acting, Single rod	

How to Order

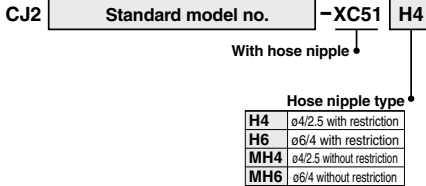

Specifications: Same as standard type

Applicable Hose Nipple Type

Symbol	Applicable bore size (mm)	Function	Hose nipple part no.
H4	ø4/2.5	With a fixed orifice (ø0.8)	CJ-5H-4
H6	ø6/4		CJ-5H-6
MH4	ø4/2.5	Without fixed orifice	M-5H-4
MH6	ø6/4		M-5H-6

Dimensions

(Dimensions other than below are the same as standard type.)

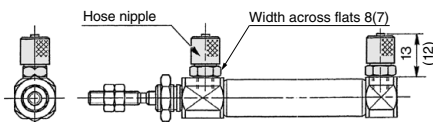

* The above figure shows the ø6/4 hose nipple mounting dimensions. The dimensions in () show those for the ø4/2.5 hose nipple.

How to Order

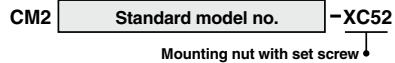

Specifications: Same as standard type

Dimensions

(Dimensions other than below are the same as standard type.)

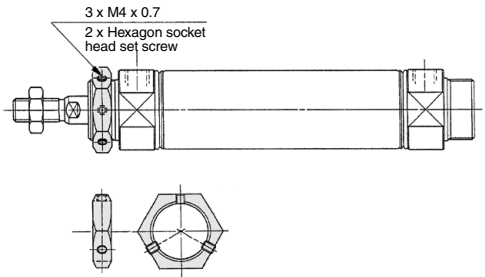

Made to Order Common Specifications: -XC56: With Knock Pin Holes



46 With Knock Pin Holes

Symbol
-XC56

Cylinder with knock positioning pin hole.

Applicable Series

Series	Description	Model	Action	Note	Vol. no. (for std model)
MGPW	Compact guide cylinder	MGPW	Double acting		②-2 From P. 498
MGG	Guide cylinder	MGG ^M B	Double acting	For basic type only	②-2 From P. 538
MGC	Guide cylinder	MGC ^M B	Double acting	For basic type only	②-2 From P. 578
MGQ	Compact guide cylinder	MGQ	Double acting	For basic type only	②-2 From P. 520
MY	Mechanically jointed rodless cylinder	MY1H-Z	Linear guide		
		MY1C	Cam follower guide		②-1 From P. 1208
		MY1H	Linear guide		
		MY2H	Linear guide type (Single axis)		
		MY2HT	Linear guide type (Double axis)		②-1 From P. 1388

How to Order

Standard model no.

-XC56

With knock pin holes

Specifications: Same as standard type

Dimensions (Dimensions other than below are the same as standard type.)

MGPW series

ø20 to ø63

Upper view of plate

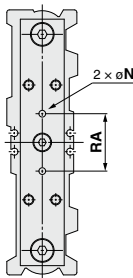

Side view (lower surface) of cylinder

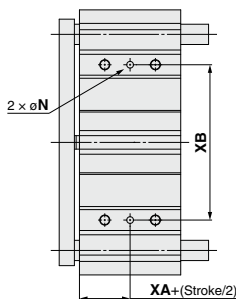

Bottom view of cylinder

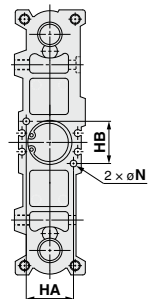

MGPW Series

(mm)

Bore size (mm)	HA	HB	N	RA	XA	XB
20	25±0.02	25±0.02	3 ^{H7} ₀ ^{+0.010} depth 6	28±0.02	17	76±0.03
25	28±0.02	28±0.02	4 ^{H7} ₀ ^{+0.012} depth 6	34±0.02	18	92±0.03
32	34±0.02	34±0.02	4 ^{H7} ₀ ^{+0.012} depth 6	42±0.02	19	112±0.03
40	38±0.02	38±0.02	4 ^{H7} ₀ ^{+0.012} depth 6	50±0.02	21	128±0.04
50	49±0.02	49±0.02	5 ^{H7} ₀ ^{+0.012} depth 8	66±0.03	21	168±0.04
63	58±0.03	58±0.03	5 ^{H7} ₀ ^{+0.012} depth 8	80±0.03	25	196±0.04



Made to Order Common Specifications: -XC56: With Knock Pin Holes



46 With Knock Pin Holes

Dimensions (Dimensions other than below are the same as standard type.)

MGJ series ø20 to ø50

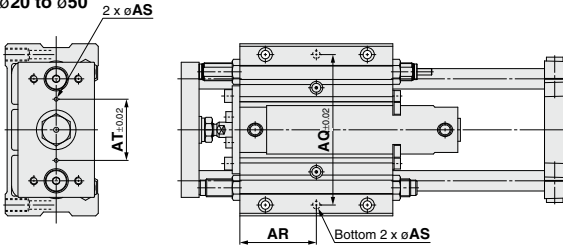

MGJ Series

(mm)

Bore size (mm)	AQ	AR	AS	AT
20	92	45	5 ^{HT} ₀ ^{+0.012} depth 6	36
25	113	50	6 ^{HT} ₀ ^{+0.012} depth 8	45
32	118	60	6 ^{HT} ₀ ^{+0.012} depth 8	48
40	150	70	8 ^{HT} ₀ ^{+0.015} depth 11	56
50	170	85	10 ^{HT} ₀ ^{+0.015} depth 13	68
63	200	100	10 ^{HT} ₀ ^{+0.015} depth 13	74
80	234	115	12 ^{HT} ₀ ^{+0.018} depth 15	92
100	274	140	12 ^{HT} ₀ ^{+0.018} depth 15	106

ø63 to ø100

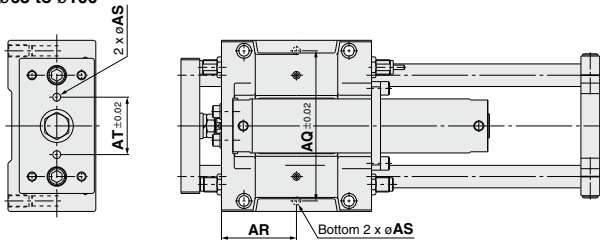

MGC series ø20 to ø50

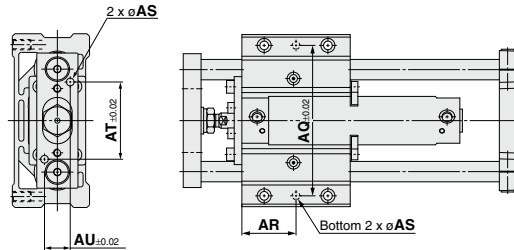

MGC Series

(mm)

Bore size (mm)	AQ	AR	AS	AT	AU
20	90	37.5	5 ^{HT} ₀ ^{+0.012} depth 6	45	15
25	103	40	6 ^{HT} ₀ ^{+0.012} depth 8	55	20
32	118	42.5	6 ^{HT} ₀ ^{+0.012} depth 8	60	20
40	140	47.5	8 ^{HT} ₀ ^{+0.013} depth 11	70	22
50	170	65	8 ^{HT} ₀ ^{+0.015} depth 11	85	30

MGQ series

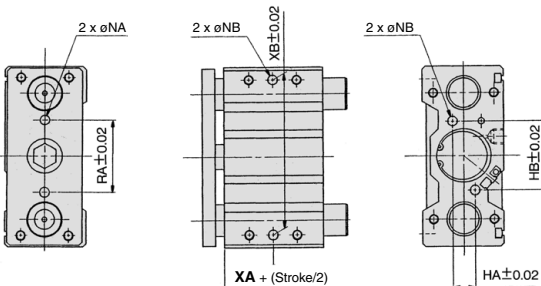

MGQ Series

(mm)

Bore size (mm)	HA	HB	NA	NB	RA	XA	XB
12	0	19	3 ^{HT} ₀ ^{+0.010} depth 4	3 ^{HT} ₀ ^{+0.010} depth 4	21	14.5	50
16	7	22	3 ^{HT} ₀ ^{+0.010} depth 4	3 ^{HT} ₀ ^{+0.010} depth 4	22	16.5	54
20	9	26	4 ^{HT} ₀ ^{+0.012} depth 5	4 ^{HT} ₀ ^{+0.012} depth 5	28	18	64
25	12	30	4 ^{HT} ₀ ^{+0.012} depth 5	6 ^{HT} ₀ ^{+0.013} depth 5	34	19	76
32	14	44	6 ^{HT} ₀ ^{+0.012} through	6 ^{HT} ₀ ^{+0.013} depth 8	46	18.5	100
40	14	54	6 ^{HT} ₀ ^{+0.012} through	6 ^{HT} ₀ ^{+0.013} depth 8	50	22	110
50	20	62	8 ^{HT} ₀ ^{+0.015} through	8 ^{HT} ₀ ^{+0.015} depth 11	56	22	124
63	30	74	8 ^{HT} ₀ ^{+0.015} through	8 ^{HT} ₀ ^{+0.015} depth 11	66	24	132
80	36	94	10 ^{HT} ₀ ^{+0.018} through	10 ^{HT} ₀ ^{+0.018} depth 13	84	28.5	166
100	40	116	10 ^{HT} ₀ ^{+0.018} through	10 ^{HT} ₀ ^{+0.018} depth 13	110	32.5	200

Dimensions (Dimensions other than below are the same as standard type.)

MY1C series

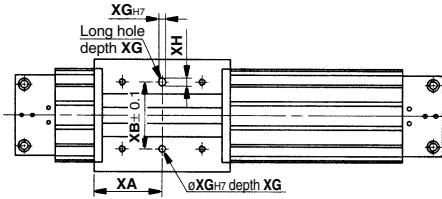

Mounting surface of a workpiece for the slide table

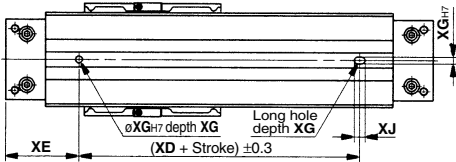

Mounting surface of cylinder tube

Bore size (mm)	XA	XB	XD	XE	XG	XH	XJ
16	40	40	80	40	4	5	9
20	50	40	100	50	4	5	9
25	51	50	110	55	5	6	10
32	66	60	140	70	6	7	11
40	81	80	180	80	6	7	11
50	100	90	230	85	8	9	13
63	115	110	280	90	10	10	15

MY1H-Z series

$\phi 25, \phi 32, \phi 40$

MY1H series

$\phi 10, \phi 16, \phi 20$

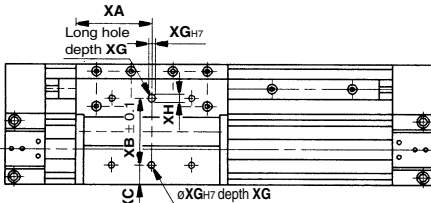

Mounting surface of a workpiece for the slide table

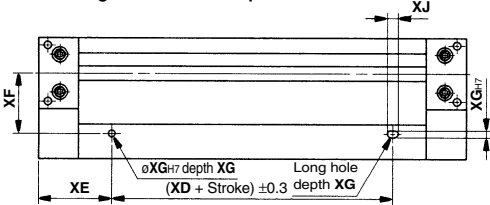

Mounting surface of cylinder tube

Bore size (mm)	XA	XB	XC	XD	XE
10	25	33	3.5	70	20
16	40	40	7.5	80	40
20	50	40	14.5	100	50
25	57	50	14.5	110	55
32	70	60	15	140	70
40	85	80	20.5	180	80

Bore size (mm)	XF	XG	XH	XJ
10	21.5	3	4	5
16	30	4	5	7
20	39	4	5	7
25	45	5	6	8
32	60	6	7	9
40	60.5	6	7	9

Made to Order Common Specifications: -XC56: With Knock Pin Holes



46 With Knock Pin Holes

Symbol
-XC56

Dimensions (Dimensions other than below are the same as standard type.)

MY2H series

ø16, ø25, ø40

MY2HT series

ø16, ø25, ø40

* The workpiece mounting surface of the slide table supports knock pin holes as standard.

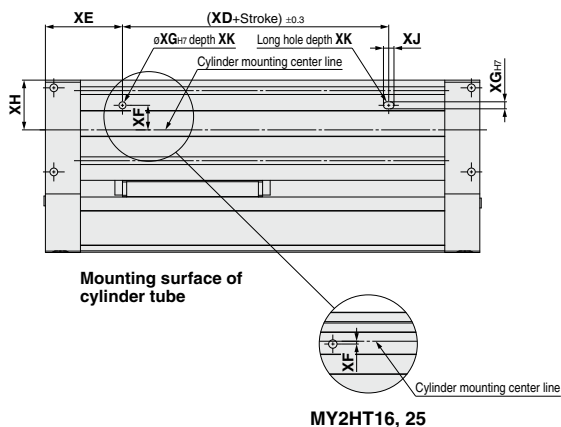

MY2H series (mm)

Bore size (mm)	XD	XE	XF	XG	XH	XJ	XK
16	80	40	11.5	4	23.5	6	5
25	100	55	17.5	5	35.5	7.5	5
40	170	80	25.5	6	45.5	9	8

MY2HT series (mm)

Bore size (mm)	XD	XE	XF	XG	XH	XJ	XK
16	80	40	3.5	5	43	7.5	5
25	100	55	2	6	61	9	8
40	170	80	3	8	75	12	12

Made to Order Common Specifications: -XC57: Rodless Cylinder with Floating Joint



47 Rodless Cylinder with Floating Joint

A special floating joint has been added to the CY3B series, which reduces the amount of labor that is required for connecting the cylinder to the guide of another shaft (load side).
The bolts used for joining the floating joint to the load can be secured either from above or below. (CY1B with a $\phi 6$ or $\phi 10$ bore must be secured from above.)

Applicable Series

Series	Description	Model	Action	Vol. no. (for std model)
CY3	Magnetically coupled rodless cylinder	CY3B	Double acting	②-1 From P. 1468
		CY3R	Double acting	
REA	Sine rodless cylinder	REA	Double acting	②-3 From P. 25
		REAR	Double acting	
REB	Sine rodless cylinder	REBR	Double acting	

How to Order

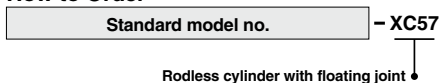

Note) The body of this cylinder is for connecting to the floating joint so that it cannot be connected to the body of the standard type. Therefore, please contact SMC for this.

Specifications: Same as standard type

Construction/Dimensions (Other dimensions are the same as standard.)

CY3B series REA series

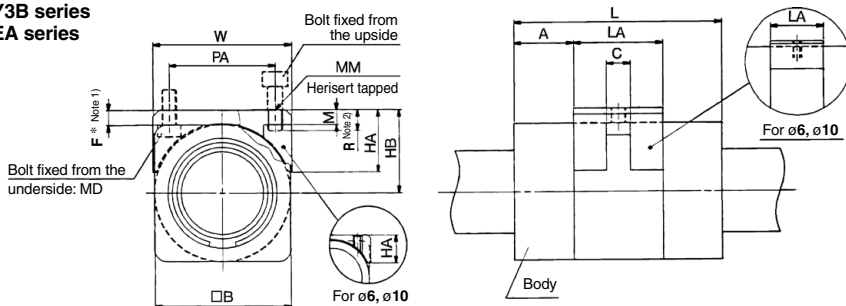

Bore size (mm)	A	□B	C	F ⁽¹⁾	HA	HB	L	LA	MM	MD	M	PA	R ⁽²⁾	W
6	10	17	—	2.5	6.3	11	35	15	M3 x 0.5 x 3L	—	—	12	—	18
10	10	25	—	2.5	9.5	15	38	18	M3 x 0.5 x 3L	—	—	17	—	26
15	16	35	6.5	5.5	16.5	23	57	25	M4 x 0.7	M3	4	25	6	36
20	18	36	6.5	5.5	17	23.5	66	30	M4 x 0.7	M3	4	27	6	37
25	20	46	8.0	5.5	21	28.5	70	30	M5 x 0.8	M4	5	36	7	47
32	22.5	60	9.5	6.0	27.5	36	80	35	M6 x 1.0	M5	6	47	8	61
40	26	70	9.5	6.0	28.5	41	92	40	M6 x 1.0	M5	6	55	8	71
50	35	86	11	6.0	35	49	110	40	M8 x 1.25	M6	8	65	11	87
63	36	100	18	7.0	42	57	122	50	M8 x 1.25	M6	10	80	11	101

Note 1) With dimension F¹, the amount of clearance between the body and the floating joint is 1 mm. The self weight deflection of the cylinder tube is not taken into account. Before operating the cylinder, determine the proper value by taking the amount of self weight deflection and the amount of off-centering from the other shaft into consideration.

Note 2) When the bolts are secured from above, be aware that if the cylinder is operated when dimension R (on $\phi 6$ and $\phi 10$, 3 mm or over) is exceeded, the end of the bolt could come in contact with the body, without being able to achieve the floating effect.

Construction/Dimensions

**CY3R series
REAR, REBR series**

For $\phi 6, \phi 10, \phi 15$

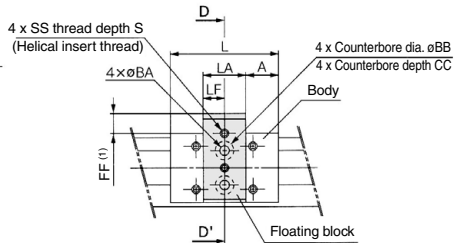
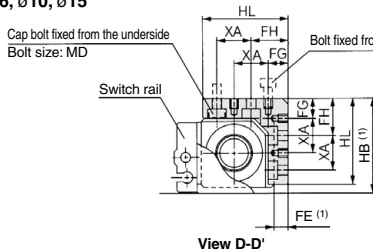

For $\phi 20, \phi 25, \phi 32, \phi 40, \phi 50, \phi 63$

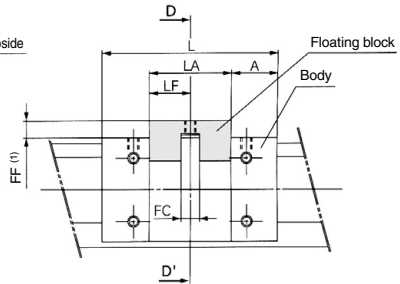
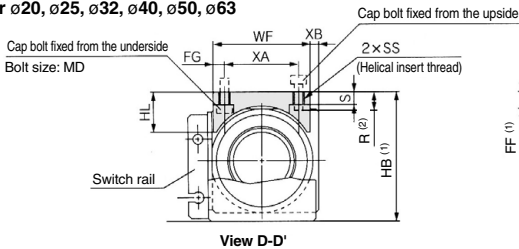

Bores size (mm)	A	BA	BB	CC	FC	FE ⁽¹⁾	FF ⁽¹⁾	FG	FH	HB ⁽¹⁾	HL	L	LA	LF	MD	R ⁽²⁾	S	SS	WF	XA	XB
6	9.5	3.4	6.5	3.3	—	5	7	5.5	10.5	26	23	34	15	7.5	M3	—	3.5	M3 x 0.5	—	10	—
10	11.5	3.4	6.5	3.3	—	5	7	7	13	33	30	38	15	7.5	M3	—	3.5	M3 x 0.5	—	12	—
15	18	4.5	8	4.4	—	4.5	6.5	7.5	14.5	38.5	35.5	53	17	8.5	M4	—	4.5	M4 x 0.7	—	14	—
20	16.5	—	—	—	6.5	—	6	4	—	45	14	62	29	14.5	M3	7	4.5	M4 x 0.7	34	26	3
25	20.5	—	—	—	8	—	7	4	—	51	17	70	29	14.5	M4	8	5.5	M5 x 0.8	39	31	3
32	21	—	—	—	9.5	—	7.5	4.5	—	62.5	22	76	34	17	M5	10	6.5	M6 x 1	50	41	3
40	25.5	—	—	—	9.5	—	7.5	7.5	—	74.5	28	90	39	19.5	M5	10	6.5	M6 x 1	60	45	3
50	35.5	—	—	—	11	—	7.5	9	—	92.5	38	110	39	19.5	M6	15	10	M8 x 1.25	78	60	3
63	34.5	—	—	—	18	—	7.5	10	—	104.5	39	118	49	24.5	M6	15	10	M8 x 1.25	90	70	3

Note 1) With dimension FE, FF, and HB, the amount of clearance between the body and the floating joint is 1 mm. The self weight deflection of the cylinder tube is not taken into account. Before operating the cylinder, determine the proper value by taking the amount of self weight deflection and the amount of off-centering with the other shaft into consideration.

Note 2) When the bolts are secured from above, be aware that if the cylinder is operated when dimension R is exceeded, the end of the bolt could come in contact with the body, without being able to achieve the floating effect.

Made to Order Common Specifications: -XC65: Made of Stainless Steel (Combination of XC7 and XC68)



48 Made of Stainless Steel (Combination of XC7 and XC68)

Symbol
-XC65

Suitable for the cases it is likely to generate rust by being immersed in the water and corrosion.

Applicable Series

Series	Description	Model	Action	Note	Vol. no. (for std model)
MB	Air cylinder	MB-Z	Double acting, Single rod	Except ø125	②-1 From P. 392
		MBW-Z	Double acting, Double rod	Except ø125 and air cushion	
MB1	Smooth cylinder	MBY-Z	Double acting, Single rod		②-3 From P. 183
		MB1-Z	Double acting, Single rod	Except ø125	
CA2	Air cylinder	MB1W-Z	Double acting, Double rod	Except ø125	②-1 From P. 440
		CA2Y-Z	Double acting, Single rod		

Specifications

Parts changed to stainless steel	Tie-rod, Tie-rod nut, Cushion valve, Piston rod (with hard chrome plated), Rod end nut
Maximum manufacturable stroke (mm)	Double acting, Single rod: 1600 Double acting single rod with rod boot: 1000
Specifications other than above and external dimensions	Same as standard type

How to Order

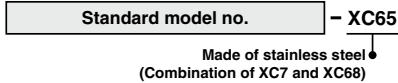

Made to Order Common Specifications:

-XC67: Dust Seal Band NBR Lining Specifications

-XC68: Made of Stainless Steel (With Hard Chrome Plated Piston Rod)



49 Dust Seal Band NBR Lining Specifications

Symbol

-XC67

The standard vinyl chloride lining specification is changed to NBR lining

Oil resistance and peeling resistance are improved.

Note) Please consult with SMC for specific details on oil resistance.

MY1 **B** **Bore size** - **Stroke** **Stroke adjustment unit** - **Auto switch** **Suffix** -XC67

Series: Bore size

B	Basic type	10	16	20	25	32	40	50	63	80	100
M(W)	Slide bearing type (With cover)	•	•	•	•	•	•	•	•	•	•
C(W)	Cam follower guide type (With cover)	•	•	•	•	•	•	•	•	•	•
H	Linear guide type	•	•	•	•	•	•	•	•	•	•
HT	High rigidity/Linear guide type	•	•	•	•	•	•	•	•	•	•

ø10, ø80 and ø100 are available only in stainless steel plate and the NBR lining specification is not available.

Example) MY1B40G-300L-Z73-XC67

For ordering dust seal band (NBR lining) only

MY **Bore size** - 16 **B N** - **Stroke**

Dust seal band NBR lining

Dust seal band Hexagon socket head set screw thread treatment

Nil	Black zinc chromated
W	Nickel plated

For details, refer to "Dust seal band" in the construction of each series.

Example) MY25-16BNW-300

Applicable Series

Series	Description	Model	Type	Vol. no. (for std model)
MY	Mechanically jointed rodless cylinder	MY1B	Basic type	②-1 From P. 1238
		MY1M(W)	Slide bearing type (With cover)	
		MY1C(W)	Cam follower guide type (With cover)	
		MY1H	Linear guide type	
		MY1HT	High rigidity/Linear guide type	

50 Made of Stainless Steel (With Hard Chrome Plated Piston Rod)

Symbol

-XC68

Suitable for the cases it is likely to generate rust by being immersed in the water and corrosion.

Applicable Series

Series	Description	Model	Action	Vol. no. (for std model)
MB	Standard type	MB-Z	Double acting, Single rod	②-1 From P. 392
		MBW-Z	Double acting, Double rod	
	Smooth cylinder	MBY-Z	Double acting, Single rod	
MB1	Standard type	MB1-Z	Double acting, Single rod	②-1 From P. 440
		MB1W-Z	Double acting, Double rod	
		CA2-Z	Double acting, Single rod	
CA2	Standard type	CA2-Z	Double acting, Single rod	②-1 From P. 470
		CA2W-Z	Double acting, Double rod	
	Smooth cylinder	CA2Y-Z	Double acting, Single rod	
CS1	Standard type	CS1	Double acting, Single rod	②-1 From P. 530
CS2	Standard type	CS2	Double acting, Single rod	②-1 From P. 568
		CS2W	Double acting, Double rod	
	Smooth cylinder	CS2Y	Double acting, Single rod	

Specifications

Parts changed to stainless steel	Piston rod
Specifications other than above and external dimensions	Same as standard

Maximum stroke

(mm)

Series	Double acting, Single rod	Double acting single rod with rod boot
MB, MB1	1600	1000
CA2, CS1, CS2	1600	1400

How to Order

Standard model no. -XC68

Made of stainless steel
(With hard chrome plated piston rod)

Made to Order Common Specifications: -XC69: MGP Series with Shock Absorber



51 MGP Series with Shock Absorber

Symbol
-XC69

Applicable Series

Series	Description	Model	Action	Note	Vol. no. (for std model)
MGP	Compact guide cylinder	MGPM	Double acting		②-2 From P. 432
		MGPL	Double acting		
		MGPA	Double acting		

How to Order **MGP M 32** - **50** - **Z73** - **XC69**

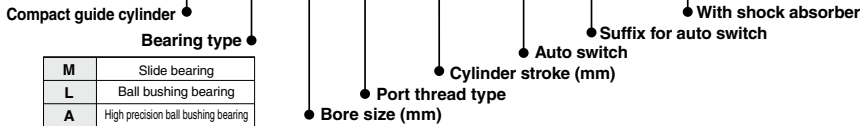

Specifications of Extension Adjusting Mechanism

Bore size (mm)	12, 16	20, 25	32, 40	50, 63	80, 100
Shock absorber model	RB0806	RB1007	RB1412	RB2015	RB2725
Maximum energy absorption (J)	2.94	5.88	19.6	58.8	147
Stroke adjustment range (mm)	0 to -15		0 to -25		0 to -30
Piston speed	Refer to the graph below.				

Soft type RJ series type (-XB22) is also available.
 For details, refer to -XB22.

Allowable Kinetic Energy

Load mass and cylinder speed should be observed within the range given in the graph below.

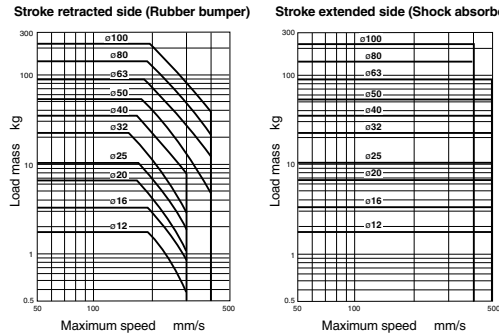

The shock absorber service life is different from that of the MGP cylinder. Refer to the RB series Specific Product Precautions for the replacement period.

Mounting

Do not allow hands or fingers near the cylinder during its operation.

If finger, etc. were to get caught between shock absorber and body, it might damage on the human body and the peripheral equipment. Take protective measures by mounting a protective cover, etc. as necessary.

Basically, avoid bottom-mounting a cylinder.

Mounting space is limited owing to the guide rod and the end plate, etc. Mount a cylinder by the top mounting or side mounting.

Adjustment

1. How to adjust an adjustment screw (Stroke adjustment)

Loosen only the hexagon nut 1, then turn the adjustment screw to adjust the stroke. After adjusting, lock it with the hexagon nut 1. Fix it at the position ejected from the end plate, so that the end face of an adjustment screw could hit the bracket for stopper directly. (Refer to the figure right above.)

2. How to replace shock absorbers

Loosen hexagon nut 2, and turn a shock absorber counterclockwise for removal. For installing a new shock absorber, fix it at the position that the end face of an adjustment screw sticks out by 0.5 mm from a shock absorber. (Refer to the figure on the right.) After adjusting the position of shock absorber, be sure to secure with hexagon nut 2.

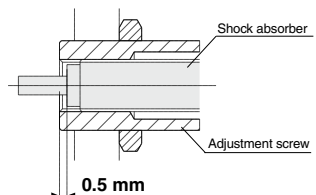
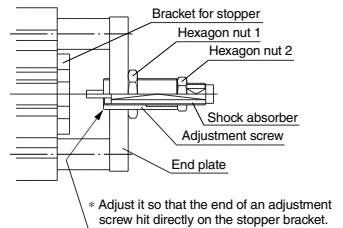

Made to Order Common Specifications: -XC69: MGP Series with Shock Absorber



51 MGP Series with Shock Absorber

Dimensions

ø12 to ø63

T-slot dimensions

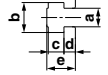

Bore size (mm)	T-slot dimensions					
	a	b	c	d	e	f
12	4.4	7.4	3.7	2	6.2	
16	4.4	7.4	3.7	2.5	6.7	
20	5.4	8.4	4.5	2.8	7.8	
25	5.4	8.4	4.5	3	8.2	
32	6.5	10.5	5.5	3.5	9.5	
40	6.5	10.5	5.5	4	11	
50	8.5	13.5	7.5	4.5	13.5	
63	11	17.8	10	7	18.5	

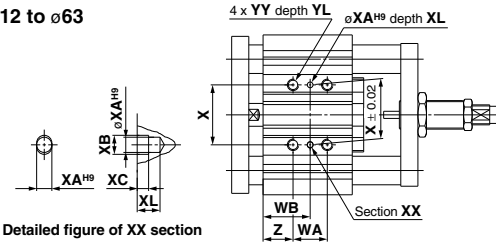

Detailed figure of XX section

Bottom view

For ø12, ø16

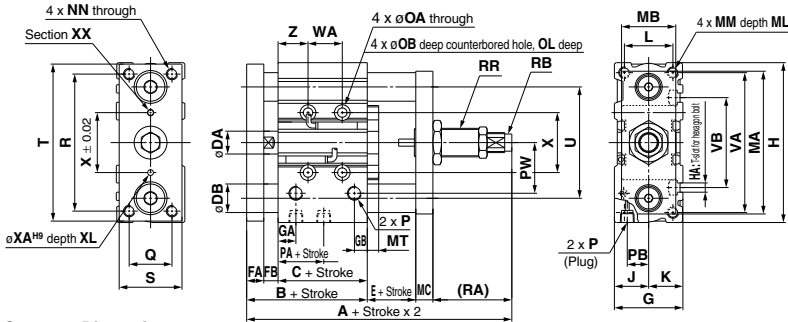

Common Dimensions

Bore size (mm)	Standard stroke (mm)	DB																							
		A	B	C	DA	Slide		E	FA	FB	G	GA	GB	H	HA	J	K	L	MA	MB	MC	MT	MM	ML	NN
12	10, 20, 30, 40, 50, 75, 100	90	42	29	6	8	6	7	8	5	26	11	7.5	58	M4	13	13	18	51	19	8	6	M4 x 0.7	10	M4 x 0.7
	125, 150, 175, 200, 250	94	46	33	8	10	8	7	8	5	30	11	8	64	M4	15	15	22	58	19	8	6	M5 x 0.8	12	M5 x 0.8
20	20, 30, 40, 50, 75, 100, 125, 150	109	53	37	10	12	10	9	10	6	36	10.5	8.5	83	M5	18	18	24	68	30	10	8	M5 x 0.8	13	M5 x 0.8
	175, 200, 250, 300, 350, 400	109.5	53.5	37.5	12	16	13	9	10	6	42	11.5	9	93	M5	21	21	30	82	30	10	8	M6 x 1.0	15	M6 x 1.0
32	25, 50, 75, 100	135.5	59.5	37.5	16	20	16	9	12	10	48	12.5	9	112	M6	24	24	34	100	38	12	8	M8 x 1.25	20	M8 x 1.25
	142, 66	142	66	44	16	20	16	9	12	10	54	14	10	120	M6	27	27	40	108	38	12	8	M8 x 1.25	20	M8 x 1.25
40	125, 150, 175, 200	155	72	44	20	25	20	10	16	12	64	14	11	148	M8	32	32	46	139	60	16	9	M10 x 1.5	22	M10 x 1.5
	250, 300, 350, 400	160	77	49	20	25	20	10	16	12	78	16.5	13.5	162	M10	39	39	58	153	60	16	9	M10 x 1.5	22	M10 x 1.5

Bore size (mm)	OA	OB	OL	P																								
				Nil			N	TF	PA	PB	PW	Q	R	RA	RB	RR	S	T	U	VA	VB	X	XA	XB	XC	XL	YY	YL
12	4.3	8	4.5	M5 x 0.8	—	—	—	13	8	18	14	48	33	RB0806	M12 x 1.5	22	56	41	50	37	3	3.5	3	6	M5 x 0.8	10	5	
16	4.3	8	4.5	M5 x 0.8	—	—	—	15	10	19	16	54	33	RB0806	M12 x 1.5	25	62	46	56	38	24	3	3.5	3	6	M5 x 0.8	10	5
20	5.4	9.5	5.5	Rc1/8	NPT1/8	G1/8	12.5	10.5	25	18	70	37	RB1007	M14 x 1.5	30	81	54	72	44	28	3	3.5	3	6	M6 x 1.0	12	17	
25	5.4	9.5	5.5	Rc1/8	NPT1/8	G1/8	12.5	13.5	30	26	78	37	RB1007	M14 x 1.5	38	91	64	82	50	34	4	4.5	3	6	M6 x 1.0	12	17	
32	6.6	11	7.5	Rc1/8	NPT1/8	G1/8	7	15	35.5	30	96	55	RB1412	M20 x 1.5	44	110	78	98	63	42	4	4.5	3	6	M8 x 1.25	16	21	
40	6.6	11	7.5	Rc1/8	NPT1/8	G1/8	13	18	39.5	30	104	55	RB1412	M20 x 1.5	44	118	86	106	72	50	4	4.5	3	6	M8 x 1.25	16	22	
50	8.6	14	9	Rc1/4	NPT1/4	G1/4	9	21.5	47	40	130	57	RB2015	M27 x 1.5	60	146	110	130	92	66	5	6	4	8	M10 x 1.5	20	24	
63	8.6	14	9	Rc1/4	NPT1/4	G1/4	14	28	58	50	130	57	RB2015	M27 x 1.5	70	158	124	142	110	80	5	6	4	8	M10 x 1.5	20	24	

MGP12 to 25 WA, WB Dimensions

Bore size (mm)	WA					WB				
	30 st or less	Over 30 st to 100 st	Over 100 st to 200 st	Over 200 st to 300 st	Over 300 st	30 st or less	Over 30 st to 100 st	Over 100 st to 200 st	Over 200 st to 300 st	Over 300 st
12	20	40	110	200	—	15	25	60	105	—
16	24	44	110	200	—	17	27	60	105	—
20	24	44	120	200	300	29	39	77	117	167
25	24	44	120	200	300	29	39	77	117	167

MGP32 to 63 WA, WB Dimensions

Bore size (mm)	WA					WB				
	25 st or less	Over 25 st to 100 st	Over 100 st to 200 st	Over 200 st to 300 st	Over 300 st	25 st or less	Over 25 st to 100 st	Over 100 st to 200 st	Over 200 st to 300 st	Over 300 st
32	24	48	124	200	300	33	45	83	121	171
40	24	48	124	200	300	34	46	84	122	172
50	24	48	124	200	300	36	48	86	124	174
63	28	52	128	200	300	38	50	88	124	174

Note) Refer to the Manufacture of Intermediate Strokes in Best Pneumatics No. 2-2 for intermediate strokes excluding the standard strokes.

• Bore size 12 and 16: M5 x 0.8 port only
• Bore size over 20: Rc, NPT or G ports selectable (Refer to Best Pneumatics No. 2-2)

Dimensions

ø80 to ø100

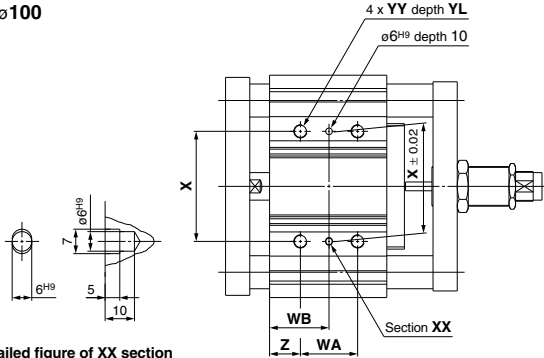

Detailed figure of XX section

Bottom view

T-slot dimensions

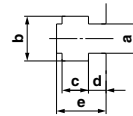

Bore size (mm)	T-slot dimensions (mm)				
	a	b	c	d	e
80	13.3	20.3	12	8	22.5
100	15.3	23.3	13.5	10	30

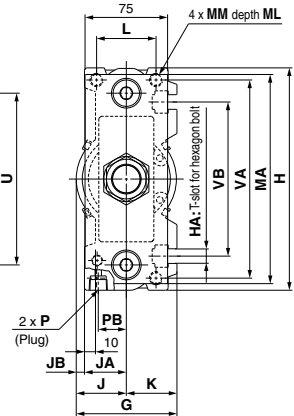
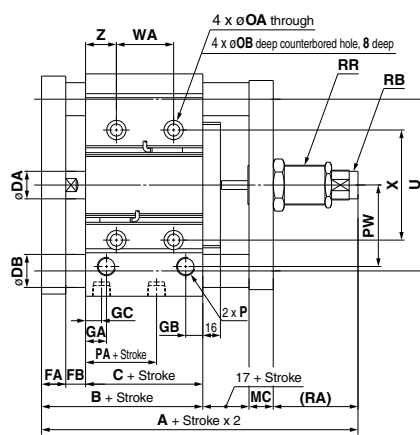
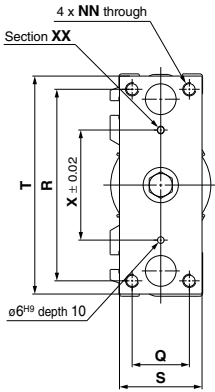

Common Dimensions

Bore size (mm)	Standard stroke (mm)	A	B	C	DA	DB		FA	FB	G	GA	GB	GC	H	HA	J	JA	JB	K	L	MA	MC
						Slide	Ball bushing															
80	25, 50, 75, 100, 125, 150, 175	212.5	96.5	56.5	25	30	25	22	18	91.5	19	15.5	14.5	202	M12	45.5	38	7.5	46	54	190	22
100	200, 250, 300, 350, 400	232	116	66	30	36	30	25	25	111.5	23	19	18	240	M14	55.5	45	10.5	56	62	228	25

Bore size (mm)	MM	ML	NN	OA	OB	P			PA	PB	PW	Q	R	RA	RB	RR	S	T	U	VA	VB
						Nil	N	TF													
80	M12 x 1.75	25	M12 x 1.75	10.6	17.5	Rc3/8	NPT3/8	G3/8	14.5	25.5	74	52	174	77	RB2725	M36 x 1.5	75	198	156	180	140
100	M14 x 2.0	31	M14 x 2.0	12.5	20	Rc3/8	NPT3/8	G3/8	17.5	32.5	89	64	210	74	RB2725	M36 x 1.5	90	236	188	210	166

Bore size (mm)	WA					WB					X	YY	YL	Z
	25 st or less	Over 25 st to 100 st	Over 100 st to 200 st	Over 200 st to 300 st	Over 300 st	25 st or less	Over 25 st to 100 st	Over 100 st to 200 st	Over 200 st to 300 st	Over 300 st				
80	28	52	128	200	300	42	54	92	128	178	100	M12 x 1.75	24	28
100	48	72	148	220	320	35	47	85	121	171	124	M14 x 2.0	28	11

Note) Refer to the Manufacture of Intermediate Strokes in Best Pneumatics No. 2-2 for the intermediate strokes excluding the standard strokes.

• Rc, NPT or G ports selectable (Refer to Best Pneumatics No. 2-2.)



Made to Order Common Specifications:

-XC71: Helical Insert Thread Specifications

-XC72: Without Built-in Auto Switch Magnet



52 Helical Insert Thread Specifications

Symbol
-XC71

The guide body mounting threads are helical insert threads.

Applicable Series

Series	Description	Model	Action	Note	Vol. no. (for std model)
MGG	Guide cylinder	MGG	Double acting		②-2 From P. 538

How to Order

MGG Bearing type **B** Bore size Port thread type - Stroke - Auto switch - **XC71**

↓ Basic type

↓ Helical insert thread specifications

Specifications

Applicable series	MGG□B
Bore size (mm)	20, 25, 32, 40, 50
Mounting type	Basic type

* Specifications other than above are the same as standard type.

Dimensions (Dimensions other than below are the same as standard type.)

ø20 to ø50

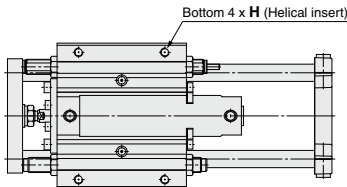

Bore size (mm)	H	AF
20	M6 x 1 depth 12	M5 x 0.8 depth 7.5
25	M8 x 1.25 depth 16	M6 x 1 depth 9
32	M8 x 1.25 depth 16	M6 x 1 depth 9
40	M10 x 1.5 depth 20	M8 x 1.25 depth 12
50	M12 x 1.75 depth 24	M10 x 1.5 depth 15

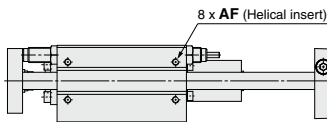

53 Without Built-in Auto Switch Magnet

Symbol
-XC72

This cylinder type does not have built-in auto switch magnet.

Applicable Series

Series	Description	Model	Action	Note	Vol. no. (for std model)
MGG	Guide cylinder	MGG	Double acting		②-2 From P. 538

How to Order

MGG Standard model no. - **XC72**

↓ Without built-in auto switch magnet

Specifications

Applicable series	MGG
Bore size (mm)	20, 25, 32, 40, 50
Auto switch	Not mountable

* Specifications and external dimensions other than above are the same as standard type.

Made to Order Common Specifications: -XC73: Built-in Cylinder with Lock (CDNG)



54 Built-in Cylinder with Lock (CDNG)

Symbol
-XC73

This type has a built-in cylinder with lock, which accommodates intermediate stops, emergency stops and drop prevention, etc.

Applicable Series

Series	Description	Model	Action	Note	Vol. no. (for std model)
MGG	Guide cylinder	MGG	Double acting		②-2 From P. 538

How to Order

MGG Bearing type Mounting type Bore size - Stroke - Auto switch - C ^{Note 1} -XC73

Cylinder Specifications

Applicable series		MGG				
Bore size (mm)		20	25	32	40	
Basic cylinder		CDNGBN	Bore size	Stroke	D - Auto switch	C ^{Note 1}
Minimum operating pressure		0.2 MPa (Horizontal with no load)				
Piston speed		50 to 1000 mm/s ^{Note 2}				
Stroke adjustment range (One side) [Built-in adjustment bolts (2 pcs.)]		0 to -15 mm				
Non-rotating accuracy ^{*2}	Slide bearing	±0.06°	±0.05°	±0.04°		
	Ball bushing bearing	±0.04°	±0.04°	±0.04°		
Shock absorber model		RB1412	RB2015			

Note 1) This symbol is indicated when the D-A9□ or M9□ type auto switch is specified. It does not apply to other auto switches (D-C7□ and H7□, etc.) (Nil)

Note 2) When the piston is locked, the load mass is limited by the mounting orientation and the operating pressure. For details about the lock specifications, etc., refer to the cylinders with lock (Best Pneumatics No. 2-2).

*1 Specifications other than shown on the left are the same as the standard type.

*2 Non-rotating rod accuracy must be below the values shown in the table at the retraction of the cylinder (initial value), and without loads or the conditions excluding the deflection of the guide rods.

◆ Built-in cylinder with lock

Dimensions

Basic type/MGG□B

ø20 to ø40

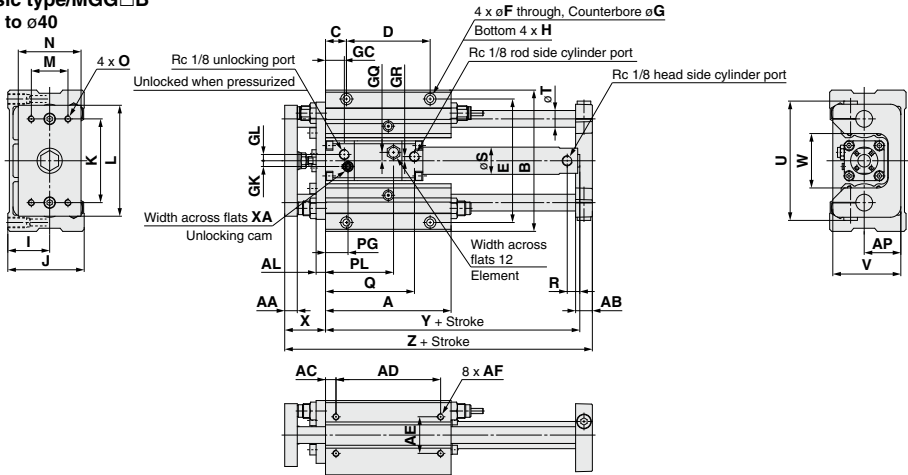

Standard Stroke

Bore size (mm)	Stroke range (mm)	A	AA	AB	AC	AD	AE	AF	AL	AP	B	C	D	E	F	G	GC	GK	GL	GQ	GR	H	I	J
20	75, 100, 125, 150, 200	120	12	16	10	100	35	M6 x 1 depth 12	9	35	135	20	80	118	6.6	11 depth 8	18	5.5	6	8	4	M10 x 1.5 depth 18	40	73
25	75, 100, 125	140	16	19	10	120	40	M8 x 1.25 depth 16	9	45	170	20	100	150	9	14 depth 10	25	6.5	9	10	7	M12 x 1.75 depth 21	50	93
32	150, 200	140	16	19	10	120	40	M8 x 1.25 depth 16	9	45	170	20	100	150	9	14 depth 10	25	6.5	9	10	7	M12 x 1.75 depth 21	50	93
40	250, 300	170	19	21	10	150	45	M10 x 1.5 depth 20	12	50	194	25	120	170	11	17 depth 12	26	7	11	12	7	M14 x 2 depth 25	55	103

Long Stroke

Bore size (mm)	K	L	M	N	O	PG	PL	Q	R	S	T	U	V	W	X	XA	Y	Z	Bore size (mm)	Stroke range (mm)	R	Y
20	80	106	35	60	M6 x 1 depth 9	21.5	65	85	12	26	16	114	65	52	39	3	143	194	20	250 to 400	14	151
25	95	134	50	75	M8 x 1.25 depth 13	26.5	73	96	12	31	20	138	84	62	46	3	153	228	25	350 to 500	14	161
32	95	134	50	75	M8 x 1.25 depth 13	26.5	73	97	12	38	20	138	84	62	46	3	156	228	32	350 to 600	14	164
40	115	152	56	90	M10 x 1.5 depth 16	28	81	104	12	47	25	164	94	75	56	4	171	274	40	350 to 800	15	180



Made to Order Common Specifications: -XC73: Built-in Cylinder with Lock (CDNG)



54 Built-in Cylinder with Lock (CDNG)

Dimensions

Front mounting flange type/MGG□F
ø20 to ø40

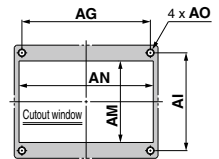
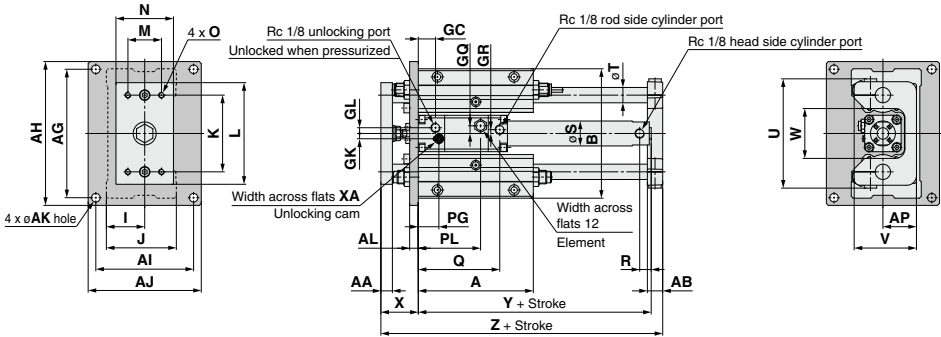

Mounting dimensions

Standard Stroke

Bore size (mm)	Stroke range (mm)	A	AA	AB	AG	AH	AI	AJ	AK	AL	AM	AN	AO	AP	B	GC	GK	GL	GQ	GR	I	J	K	L	M	N
20	75, 100, 125, 150, 200	120	12	16	134	150	102	118	9	9	85	140	M8	35	135	18	5.5	6	8	4	40	73	80	106	35	60
25	75, 100, 125	140	16	19	170	186	134	150	9	9	105	175	M8	45	170	25	6.5	9	10	7	50	93	95	134	50	75
	150, 200, 250, 300	140	16	19	170	186	134	150	9	9	105	175	M8	45	170	25	6.5	9	10	7	50	93	95	134	50	75
40		170	19	21	190	210	140	160	11	12	115	200	M10	50	194	26	7	11	12	7	55	103	115	152	56	90

Long Stroke

Bore size (mm)	O	PG	PL	Q	R	S	T	U	V	W	X	XA	Y	Z
20	M6 x 1 depth 9	21.5	65	85	12	26	16	114	65	52	39	3	143	194
25	M8 x 1.25 depth 13	26.5	73	96	12	31	20	138	84	62	46	3	153	228
32	M8 x 1.25 depth 13	26.5	73	97	12	38	20	138	84	62	46	3	156	228
40	M10 x 1.5 depth 16	28	81	104	12	47	25	164	94	75	56	4	171	274

Bore size (mm)	Stroke range (mm)	R	Y
20	250 to 400	14	151
25	350 to 500	14	161
32	350 to 600	14	164
40	350 to 800	15	180

Made to Order Common Specifications: Built-in Cylinder with Lock (CDNG)

Symbol
-XC73

This type has a built-in cylinder with lock, which accommodates intermediate stops, emergency stops and drop prevention, etc.

How to Order

MGC Bearing type Mounting type Bore size — Stroke — Equipped/Not equipped rear plate — Auto switch — C Note 1 — **XC73**

Built-in cylinder with lock

Cylinder Specifications

Applicable series		MGC					
Bore size (mm)		20	25	32	40		
Basic cylinder		CDNGBA	Bore size	Stroke	D	Auto switch	C Note 1
Minimum operating pressure		0.2 MPa (Horizontal with no load)					
Piston speed		50 to 750 mm/s ^{Note 2)}					
Non-rotating accuracy #2	Side bearing	±0.06°		±0.05°		±0.04°	
	Ball bushing bearing	±0.04°		±0.04°		±0.04°	

Note 1) This symbol is indicated when the D-A9□ or M9□ type auto switch is specified. It does not apply to other auto switches (D-C7□ and H7□, etc.) (Nil)

Note 2) When the piston is locked, the load mass is limited by the mounting orientation and the operating pressure. For details about the lock specifications, etc., refer to the cylinders with lock (Best Pneumatics No. 2-2).

#1 Specifications other than shown on the left are the same as the standard type.

#2 Non-rotating rod accuracy must be below the values shown in the table at the retraction of the cylinder (initial value), and without loads or the conditions excluding the deflection of the guide rods.

Dimensions

Basic type/MGC□B ø20 to ø40

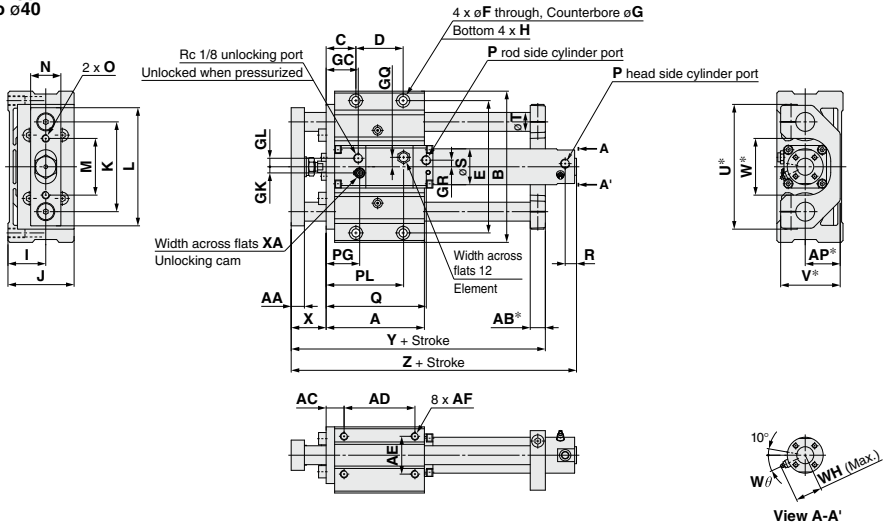

Standard Stroke

Bore size (mm)	Stroke range (mm)	A	AA	AB*	AC	AD	AE	AF	AP*	B	C	D	E	F	G	GC	GK	GL	GQ	GR	H	I	J	K
20	75, 100, 125, 150, 200	94	11	13	16.5	70	35	M6 x 1 depth 12	32	135	26.5	50	118	6.8	11 depth 8	27	5.5	6	8	4	M8 x 1.25 depth 14	35	60	80
25	75, 100, 125	104	14	16	19	75	40	M8 x 1.25 depth 16	37	160	31.5	50	140	8.6	14 depth 10	34	6.5	9	10	7	M10 x 1.5 depth 18	40	70	95
32	150, 200	104	14	16	19	75	40	M8 x 1.25 depth 16	37	160	31.5	50	140	8.6	14 depth 10	34	6.5	9	10	7	M10 x 1.5 depth 18	40	70	95
40	250, 300	142	17	19	22	110	45	M10 x 1.5 depth 20	42	194	37	80	170	10.5	17 depth 12	38	7	11	12	7	M12 x 1.75 depth 21	45	82.5	115

Long Stroke

Bore size (mm)	L	M	N	O	P	PG	PL	Q	R	S	T	U*	V*	W*	WH	W _l	X	XA	Y	Z	Bore size (mm)	Stroke range (mm)	R	Z
20	105	50	25	M6 x 1	M5 x 0.8	30.5	74	96	12	26	16	112	53	50	23	30°	30	3	148	182	20	250 to 400	14	190
25	125	60	32	M8 x 1.25	M5 x 0.8	35.5	82	106	12	31	20	132	63	60	25	30°	37	3	169	199	25	350 to 500	14	207
32	125	60	32	M8 x 1.25	Rc 1/8	35.5	82	106	12	38	20	132	63	60	28.5	25°	37	3	169	207	32	350 to 600	14	210
40	150	75	38	M8 x 1.25	Rc 1/8	40	93	116	12	47	25	162	73	70	33	20°	44	4	210	227	40	350 to 800	15	236

Note) Without rear plate: Dimensions with an asterisk (*) mark is not needed.

Made to Order Common Specifications:

-XC73: Built-in Cylinder with Lock (CDNG)

-XC74: With Front Plate for MGG Cylinder



54 Built-in Cylinder with Lock (CDNG)

Symbol
-XC73

Dimensions

Front mounting flange type/MGC□F

ø20 to ø40

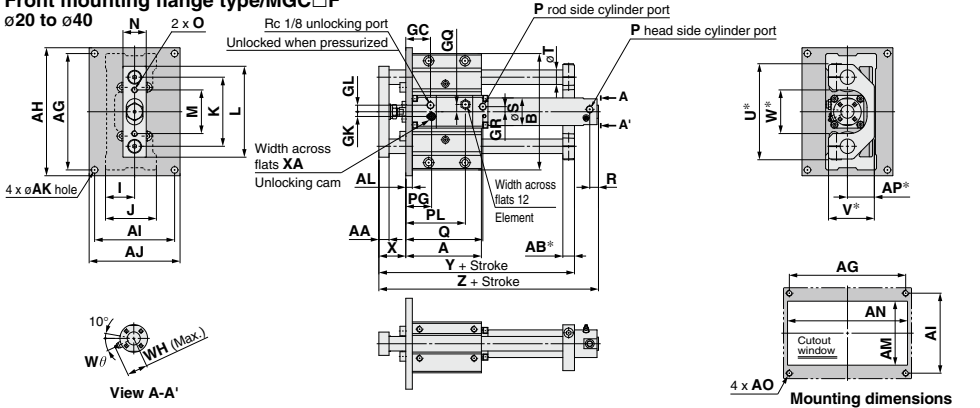

Standard Stroke

Bore size (mm)	Stroke range (mm)	A	AA	AB*	AG	AH	AI	AJ	AK	AL	AM	AN	AO	AP*	B	GC	GK	GL	GQ	GR	I	J	K	L	M	N
20	75, 100, 125, 150, 200	94	11	13	134	150	92	108	9	9	75	140	M8	32	135	27	5.5	6	8	4	35	60	80	105	50	25
25	75, 100, 125	104	14	16	160	176	110	125	9	9	88	165	M8	37	160	34	6.5	9	10	7	40	70	95	125	60	32
32	150, 200, 250, 300	104	14	16	160	176	110	125	9	9	88	165	M8	37	160	34	6.5	9	10	7	40	70	95	125	60	32
40		142	17	19	190	210	115	135	11	12	96	200	M10	42	194	38	7	11	12	7	45	82.5	115	150	75	38

Long Stroke

Bore size (mm)	O	P	PG	PL	Q	R	S	T	U*	V*	W*	WH	Wθ	X	XA	Y	Z
20	M6 x 1	M5 x 0.8	30.5	74	96	12	26	16	112	53	50	23	30°	30	3	148	182
25	M8 x 1.25	M5 x 0.8	35.5	82	106	12	31	20	132	63	60	25	30°	37	3	169	199
32	M8 x 1.25	Rc 1/8	35.5	82	106	12	38	20	132	63	60	28.5	25°	37	3	169	202
40	M8 x 1.25	Rc 1/8	40	93	116	12	47	25	162	73	70	33	20°	44	4	210	227

Note) Without rear plate: Dimensions with an asterisk (*) mark is not needed.

55 With Front Plate for MGG Cylinder

Symbol
-XC74

This type uses a front plate equivalent to the MGG series.

How to Order

MGC -XC74

With front plate for MGG

Specifications

Applicable series	MGC
Bore size (mm)	20, 25, 32, 40, 50
Fluid	Air
Minimum operating pressure	0.15 MPa (Horizontal, With no load)
Piston speed	50 to 750mm/s
Auto switch	Mountable

* Specifications other than above are the same as standard type.

Dimensions (Dimensions other than below are the same as standard type.)

ø20 to ø50

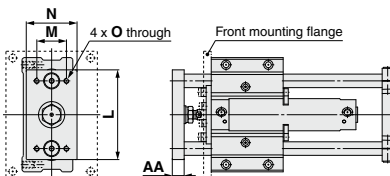

Bore size (mm)	L	M	N	O	AA
20	80	25	45	M6 x 1	11
25	100	35	54	M6 x 1	14
32	106	35	60	M6 x 1	14
40	134	50	75	M8 x 1.25	17
50	152	56	90	M10 x 1.5	23

Made to Order Common Specifications: -XC78: Auto Switch Mounting Special Dimensions at Stroke End



56 Auto Switch Mounting Special Dimensions at Stroke End

Symbol
-XC78

Auto switch mounting position at stroke end is assembled like below.

Applicable Series

Series	Description	Model	Action	Note	Vol. no. (for std model)
MGC	Guide cylinder	MGC	Double acting		②-2 From P. 578

How to Order

MGC -XC78

Auto switch mounting special dimensions at stroke end

Specifications

Applicable series	MGC
Bore size (mm)	20, 25, 32, 40, 50
Applicable cylinder	Guide cylinder
Specifications other than above	Same as standard type

Dimensions (Dimensions other than below are the same as standard type.)

D-M9□(V)/M9□(V)/M9□A(V)
D-A9□(V)

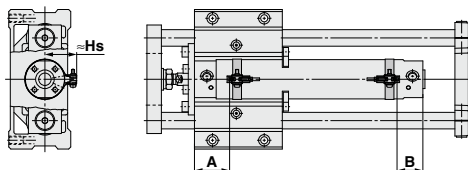

D-B5/B6
D-G5/K5

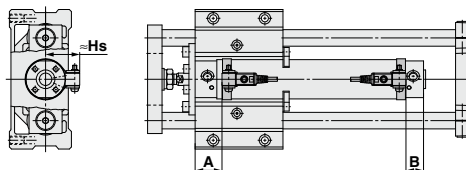

D-C7/C8
D-H7

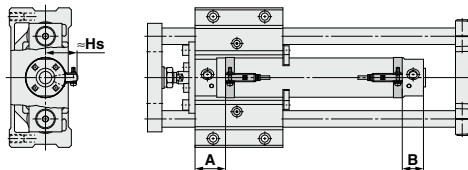

D-B7/B8
D-G7/K7

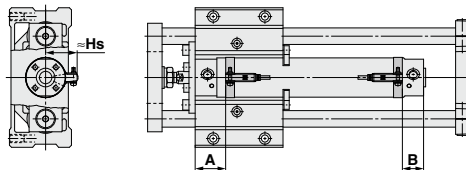

Proper Auto Switch Mounting Position

Auto switch model	(mm)															
	D-M9□(V) D-M9□W(V) D-M9□A(V)		D-A9□(V)		D-B7/B8 D-B73C D-B80C D-G7/K7 D-K79C		D-C7□ D-C80 D-C73C D-C80C		D-B5□ D-B64		D-B59W		D-H7□ D-H7C D-H7NF D-H7□W D-H7BA		D-G59F/G5 D-K59 D-G5W D-K59W D-G5NT D-G5BA	
	A	B	A	B	A	B	A	B	A	B	A	B	A	B	A	B
20	33	24 (32)	29	20 (28)	30.5	21.5 (29.5)	29.5	20.5 (28.5)	23.5	15.5 (22.5)	26.5	17.5 (25.5)	28.5	19.5 (27.5)	25	16 (24)
25	33	24 (32)	29	20 (28)	30.5	21.5 (29.5)	29.5	20.5 (28.5)	23.5	15.5 (22.5)	26.5	17.5 (25.5)	28.5	19.5 (27.5)	25	16 (24)
32	34	25 (33)	30	21 (29)	31.5	22.5 (30.5)	30.5	21.5 (29.5)	24.5	15.5 (23.5)	27.5	18.5 (26.5)	29.5	20.5 (28.5)	26	17 (25)
40	39	27 (36)	35	23 (32)	36.5	24.5 (33.5)	35.5	23.5 (32.5)	29.5	19 (26.5)	32	20.5 (29.5)	34.5	22.5 (31.5)	31	19 (28)
50	46	32 (36)	42	28 (40)	43.5	29.5 (41.5)	42.5	28.5 (40.5)	36.5	22.5 (34.5)	39.5	25.5 (37.5)	41.5	27.5 (39.5)	38	24 (36)

Proper Auto Switch Mounting Height

Auto switch model	(mm)					
	D-M9□(V) D-M9□W(V) D-A9□(V)		D-C7□/C80 D-H7□ D-H7NF D-H7BA	D-C73C D-C80C	D-B7□/B80 D-B73C D-B80C D-G79K79 D-H7C D-G5BA D-G5NT D-G59F	D-G5□/K59 D-G5□W D-K59W D-B5□/B64 D-B59W D-G5BA D-G59F
	Hs	Hs	Hs	Hs		
20	25	24.5	27	27.5		
25	27.5	27	29.5	30		
32	31	30.5	33	33.5		
40	35.5	35	37.5	38		
50	41	40.5	43	43.5		

* () : Long stroke, double rod

Note) Adjust the auto switch after confirming the operating conditions in the actual setting.

Made to Order Common Specifications: -XC82: Bottom Mounting Type



57 Bottom Mounting Type

Symbol
-XC82

Since the guide rod does not protrude from the bottom at the retraction of the rod, relief holes for guide rods are not required.

Applicable Series

Series	Description	Model	Action	Note	Vol. no. (for std model)
MGP	Compact guide cylinder	MGPM	Double acting		2-2 From P. 432

How to Order

MGP M 32 - 50 Z - - XC82

- Compact guide cylinder
- Bearing Type
 - M Slide bearing
- Bore size (mm)

12	12 mm
16	16 mm
20	20 mm
25	25 mm
32	32 mm
40	40 mm
50	50 mm
63	63 mm
80	80 mm
100	100 mm
- Port thread type
- Cylinder stroke (mm)

Bore size (mm)	Applicable stroke (mm)
12 to 25	75, 100
32 to 100	25, 50, 75, 100
- Auto switch
- Suffix for auto switch
- Bottom mounting type

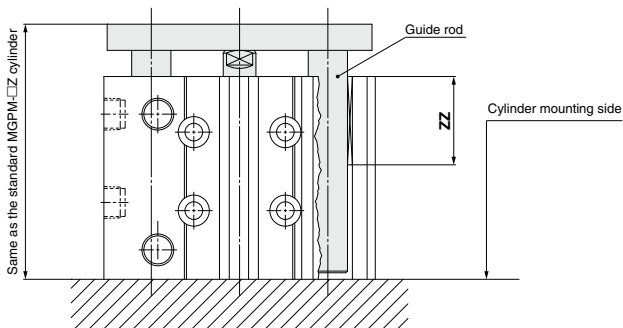

(Note) The total length (ZZ) of the guide rod bushing is shorter than the standard type.

Made to Order Common Specifications: -XC83: Built-in Cylinder with Lock (MDNB)



58 Built-in Cylinder with Lock (MDNB)

Symbol
-XC83

This type has a built-in cylinder with lock, which accommodates intermediate stops, emergency stops and drop prevention, etc.

Applicable Series

Series	Description	Model	Action	Note	Vol. no. (for std model)
MGG	Guide cylinder	MGG	Double acting		2-2 From P. 538

How to Order

MGG **Bearing type** **Mounting type** **Bore size** — **Stroke** — **Auto switch** — **XC83**

Specifications

Applicable series	MGG					
Bore size (mm)	50	63	80	100		
Basic cylinder	MDNBB	Bore size	Stroke	D	Auto switch	X1189
Minimum operating pressure	0.2 MPa (Horizontal with no load)					
Piston speed ^{Note}	50 to 1000 mm/s		50 to 700 mm/s			
Stroke adjustment range (One side) [Built-in adjusting bolts (2 pcs.)]	0 to -15 mm					
Non-rotating accuracy ^{#2}	Slide bearing	±0.04°		±0.03°		
	Ball bushing bearing	±0.03°		±0.02°		
Shock absorber model	RB2015		RB2725			

↳ Built-in cylinder with lock

Note) When the piston is locked, the load mass is limited by the mounting orientation and the operating pressure.

For details about the lock specifications, etc., refer to the cylinders with lock (Best Pneumatics No. 2-2).

#1 Specifications other than shown above are the same as the standard type.

#2 Non-rotating rod accuracy must be below the values shown in the table at the retraction of the cylinder (initial value), and without loads or the conditions excluding the deflection of the guide rods.

Applicable Auto Switches

Refer to pages 1575 to 1701 for the detailed specifications of auto switches.

Type	Special function	Electrical entry	Indicator light	Wiring (output)	Load voltage		Auto switch part no.	Tie-rod mounting	Band mounting	Lead wire length (m)				Pre-wired connector	Applicable load	
					DC	AC				0.5 (Nil)	1 (M)	3 (L)	5 (Z)		IC circuit	Relay, PLC
Solid state auto switch	—	Grommet	No	3-wire (NPN)	5 V, 12 V	—	M9N	—	●	●	●	○	○	—		
				3-wire (PNP)			M9P	—	●	●	●	○	○			
		Terminal conduit		2-wire	12 V	M9B	—	●	●	●	○	○	—			
				2-wire (NPN)	5 V, 12 V	—	G39	—	—	—	—	—				
	Diagnostic indication (2-color)	Grommet	Yes	3-wire (NPN)	5 V, 12 V	—	M9NW	—	●	●	●	○	○	—	IC circuit	
				3-wire (PNP)			M9PW	—	●	●	●	○	○			
				2-wire	12 V	M9BW	—	●	●	●	○	○	—			
				3-wire (NPN)	5 V, 12 V	M9NA	—	○	○	●	○	○				
				3-wire (PNP)	12 V	M9PA	—	○	○	●	○	○				
				2-wire	12 V	M9BA	—	○	○	●	○	○				
Reed auto switch	—	Grommet	Yes	3-wire (NPN equivalent)	—	5 V	—	A96	—	●	—	●	—	—	IC circuit	—
				No	2-wire	24 V	12 V	100 V	A93	—	●	●	●	●	—	
		100 V or less		A90				—	●	—	●	—	—			
		—		A33				—	—	—	—	—	—	—	—	
		Terminal conduit		Yes	100 V, 200 V	—	A34	—	—	—	—	—	—	—	Relay, PLC	
Din terminal	Yes	100 V, 200 V	—	A44	—	—	—	—	—	—	—	Relay, PLC				

* Lead wire length symbols: 0.5 m Nil (Example) M9NW 1 m M (Example) M9NWM 3 m L (Example) M9NWL 5 m Z (Example) M9NWX

* Solid state auto switch with ○: Manufactured upon receipt of order.

* Refer to page 1852 since there are applicable auto switches other than listed above.

* Refer to pages 1648 and 1649 for the details of auto switches with a pre-wired connector.

* D-A9□/M9□/M9□W/M9□A/M9□AV auto switches are shipped together (not assembled).

(Auto switch mounting brackets for the models above are mounted when shipped.)

Auto Switch Mounting Bracket: Part No.

Auto switch model	Bore size (mm)			
	ø50	ø63	ø80	ø100
D-A9□/A9□V D-M9□/M9□V D-M9□W/M9□WV D-M9□A/M9□AV	BA7-040	BA7-040	BA7-063	BA7-063
D-A3□/A44 D-G39/K39	BMB1-050	BMB1-063	BMB1-080	BMB1-100
D-Z7□/Z80 D-Y59□/Y69□ D-Y7P/Y7PV D-Y7□W/Y7□WV D-Y7BA	BMB4-050	BMB4-050	BA4-063	BA4-063

[Mounting screw set made of stainless steel]

The following set of mounting screws made of stainless steel (including nuts) is available. Use it in accordance with the operating environment. (Please order the auto switch mounting bracket separately, since it is not included.)

BBA1: Stainless steel screw set for D-A5/A6/F5/J5 types

Note) Refer to page 1689 for the details of BBA1.

When shipping cylinders with D-M9□A/M9□A/Y7BA auto switches, the stainless steel screws above are used to secure auto switch mounting brackets.



Made to Order Common Specifications: -XC83: Built-in Cylinder with Lock (MDNB)



58 Built-in Cylinder with Lock (MDNB)

Besides the models listed on the previous page, the following auto switches are applicable.
Refer to pages 1575 and 1701 for details.

Auto switch type	Part no.	Electrical entry (Felching direction)	Features
Reed	D-A93V, A96V	Grommet (Perpendicular)	—
	D-A90V		Without indicator light
	D-Z73, Z76	Grommet (In-line)	—
	D-Z80		Without indicator light
Solid state	D-M9NV, M9PV, M9BV	Grommet (Perpendicular)	—
	D-Y69A, Y69B, Y7PV		—
	D-M9NWV, M9PWV, M9BWW		Diagnostic indication (2-color)
	D-Y7NWV, Y7PWV, Y7BWW		Water resistant (2-color indicator)
	D-M9NAV, M9PAV, M9BAV	Grommet (In-line)	—
	D-Y59A, Y59B, Y7P		—
	D-Y7NW, Y7PW, Y7BW		Diagnostic indication (2-color)
	D-Y7BA		Water resistant (2-color indicator)

* For solid state switches, auto switches with a pre-wired connector are also available. Refer to pages 1648 and 1649 for details.

* Normally closed (NC = b contact) solid state auto switches (D-F9G/F9H/Y7G/Y7H types) are also available. Refer to pages 1593 and 1595 for details.

Refer to the MNB series in Best Pneumatics No.2-2 for the minimum auto switch mounting stroke, proper auto switch mounting position and operating range.

Dimensions

Basic type ø50 to ø100

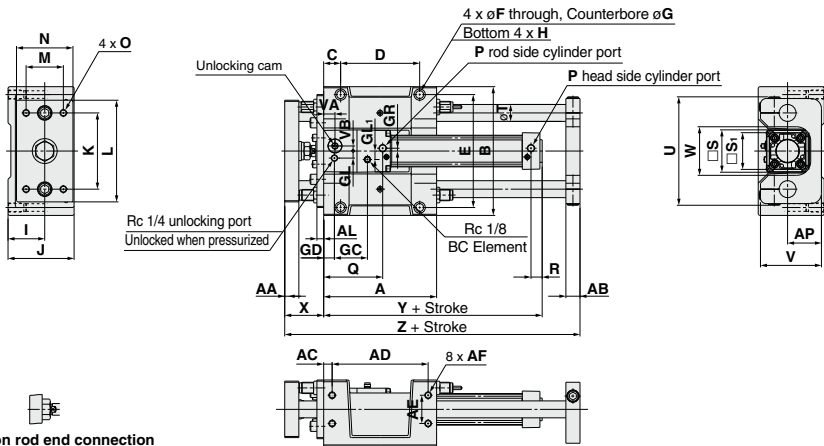

Standard Stroke

Bore size (mm)	Stroke range (mm)	A	AA	AB	AC	AD	AE	AF	AL	AP	B	C	D	E	F	G	GC	GD	GL	GL1	GR	H	I
50	75, 100, 125	200	25	25	15	170	50	M12 x 1.75 depth 24	12	60	228	30	140	200	13.5	20 depth 14.5	58.5	19	12.5	15	5	M16 x 2 depth 28	65
63	150, 200	230	25	27	15	200	55	M12 x 1.75 depth 24	12	70	262	30	170	234	13.5	20 depth 14.5	68	23	17.5	12	9	M16 x 2 depth 28	75
80	250, 300	280	30	30	17.5	245	70	M14 x 2 depth 28	16	80	304	35	210	274	15	23 depth 17	81	33	22	18	11.5	M18 x 2.5 depth 32	85
100		280	32	30	17.5	245	70	M14 x 2 depth 28	16	80	304	35	210	274	15	23 depth 17	96	37.5	25	20	17	M18 x 2.5 depth 32	85

Bore size (mm)	J	K	L	M	N	O	P	Q	R	S	S ₁	T	U	V	VA	VB	W	X	Y	Z
50	117	135	180	66	100	M12 x 1.75 depth 23	Rc 1/4	104.5	19.5	75	65	30	192	108	20	9	86	69	187	323
63	138	160	214	76	115	M12 x 1.75 depth 23	Rc 3/8	119.5	20.5	90	75	35	224	128	23	8.5	104	69	201	358
80	153	190	245	80	125	M14 x 2 depth 28	Rc 3/8	150	23	102	95	40	262	143	33	10.5	128	87	249	431
100	153	190	245	80	125	M14 x 2 depth 30	Rc 1/2	170	23	116	114	40	262	143	37.5	10.5	128	87	269	431

Long Stroke

Bore size (mm)	Stroke range (mm)
50	350 to 1000
63	350 to 1000
80	350 to 1000
100	350 to 1000

Symbol
-XC83

Dimensions

Front mounting flange type
ø50 to ø100

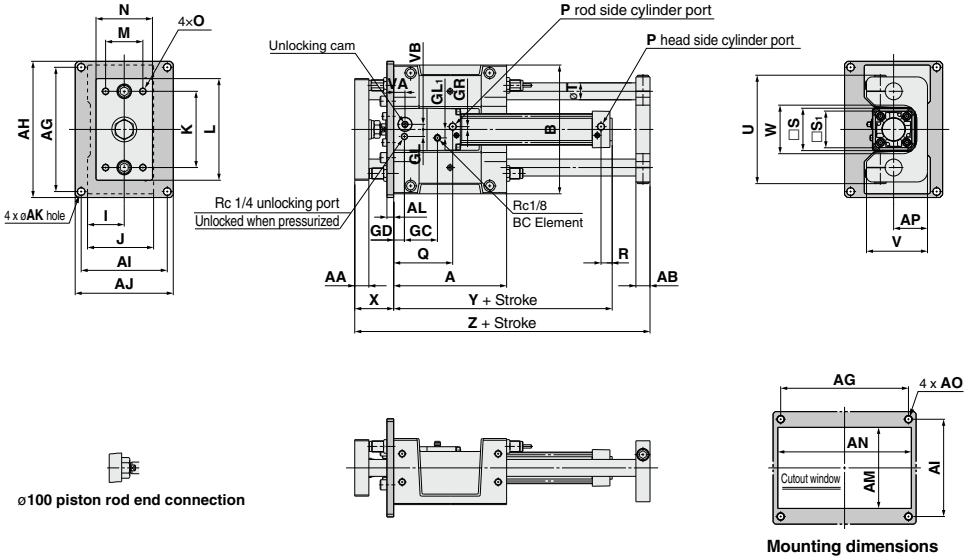

Standard Stroke

Bore size (mm)	Stroke range (mm)	A	AA	AB	AG	AH	AI	AJ	AK	AL	AM	AN	AO	AP	B	GC	GD	GL	GL1	GR	I	J	K	L	M	N
50	75, 100, 125	200	25	25	228	250	158	180	14	12	135	234	M12	60	228	58.5	19	12.5	15	5	65	117	135	180	66	100
	150, 200	230	25	27	262	284	178	200	14	12	155	268	M12	70	262	68	23	17.5	12	9	75	138	160	214	76	115
	250, 300	280	30	30	300	326	200	226	16	16	175	310	M14	80	304	81	33	22	18	11.5	85	153	190	245	80	125
100		280	32	30	300	326	200	226	16	16	175	310	M14	80	304	96	37.5	25	20	17	85	153	190	245	80	125

Long Stroke

Bore size (mm)	O	P	Q	R	S	S1	T	U	V	VA	VB	W	X	Y	Z
50	M12 x 1.75 depth 23	Rc 1/4	104.5	19.5	75	65	30	192	108	20	9	86	69	187	323
63	M12 x 1.75 depth 23	Rc 3/8	119.5	20.5	90	75	35	224	128	23	8.5	104	69	201	358
80	M14 x 2 depth 28	Rc 3/8	150	23	102	95	40	262	143	33	10.5	128	87	249	431
100	M14 x 2 depth 30	Rc 1/2	170	23	116	114	40	262	143	37.5	10.5	128	87	269	431

Bore size (mm)	Stroke range (mm)
50	350 to 1000
63	350 to 1000
80	350 to 1000
100	350 to 1000



Made to Order Common Specifications: -XC85: Grease for Food Processing Equipment



59 Grease for Food Processing Equipment

Symbol
-XC85

Food grade grease (certified by NSF-H1) is used as lubricant.

Applicable Series

Series	Description	Model	Action	Note	Vol. no. (for std model)
CM2	Air cylinder	CM2-Z	Double acting, Single rod		②-1 From P. 172
	Direct mount type	CM2W-Z	Double acting, Double rod		
	Centralized piping type	CM2□P	Double acting, Single rod	Except with rod boot	
CG1	Air cylinder	CG1-Z	Double acting, Single rod		②-1 From P. 292
	Direct mount type	CG1W-Z	Double acting, Double rod		
	Direct mount type	CG1R-Z	Double acting, Single rod		
CA2	Air cylinder	CA2-Z	Double acting, Single rod		②-1 From P. 470
		CA2W-Z	Double acting, Double rod		
CQS	Compact cylinder	CQS	Double acting, Single rod		②-1 From P. 693
		CQS	Single acting, Single rod		
		CQSW	Double acting, Double rod		
		CQS	Double acting, Single rod		
CQ2	Compact cylinder	CQ2-Z	Double acting, Single rod		②-1 From P. 773
		CQ2-Z	Single acting, Single rod		
		CQ2W-Z	Double acting, Double rod		
	Large bore size	CQ2B-Z	Double acting, Single rod		
		CQ2WB-Z	Double acting, Double rod		
	Long stroke	CQ2-Z	Double acting, Single rod		
	Non-rotating rod	CQ2K-Z	Double acting, Single rod		
		CQ2KW-Z	Double acting, Double rod		
	Axial piping type (Centralized piping type)	CQP2	Double acting, Single rod		
		CQP2	Single acting, Single rod		
Anti-lateral load	CQ2□S-Z	Double acting, Single rod			
With end lock	CBQ2	Double acting, Single rod			
MGP	Compact guide cylinder	MGP-Z	Double acting, Single rod		②-2 From P. 432
	With air cushion	MGP-□AZ	Double acting, Single rod		
	With end lock	MGP	Double acting, Single rod		
	Heavy duty guide rod type	MGPS	Double acting, Single rod		
	High precision ball bushing type	MGPA-Z	Double acting, Single rod		
CXSJ	Dual rod cylinder	CXSJ	Double acting		②-2 From P. 737
CXS		CXS	Double acting		②-2 From P. 749

How to Order

Standard model no. — **XC85**

Grease for food processing equipment

Specifications

Seal material	Nitrile rubber
Grease	Grease for food
Auto switch	Mountable
Dimensions	Same as standard model
Specifications other than above	Same as standard model

Warning

Precautions

Be aware that smoking cigarettes, etc. after your hands have come into contact with the grease used in this cylinder can create a gas that is hazardous to humans.

<Not installable>

Food zone.....An environment where food which will be sold as merchandise, directly touches the cylinder's components.

Splash zone.....An environment where food which will not be sold as merchandise, directly touches the cylinder's components.

<Installable>

Non-food zone.....An environment where there is no contact with food.

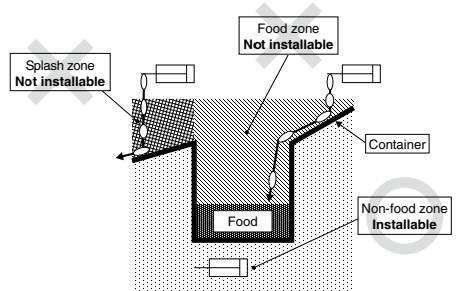

Note 1) Avoid using this product in the food zone. (Refer to the figure above.)

Note 2) When the product is used in an area of liquid splash, or a water resistant function is required for the product, please consult SMC.

Note 3) Operate without lubrication from a pneumatic system lubricator.

Note 4) Use the following grease pack for the maintenance work.
GR-H-010 (Grease: 10 g)

Note 5) Please contact SMC for details on the maintenance intervals for this cylinder, which differ from those of the standard cylinder.

Made to Order Common Specifications: -XC86: With Rod End Bracket



60 With Rod End Bracket

Symbol
-XC86

With rod end bracket type to simplify the order process.

Applicable Series

Series	Description	Model	Action	Vol. no. (for std model)
CS1	Standard type	CS1	Double acting, Single rod	②-1 From P. 530
	Low friction type	CS1Q	Double acting, Single rod	
CS2	Standard type	CS2	Double acting, Single rod	②-1 From P. 568
	Smooth cylinder	CS2Y	Double acting, Single rod	

How to Order

Standard model no. **-XC86** **A**

With rod end bracket ↓

↓ Suffix

A	With rod end nut
B	With double knuckle joint
C	With single knuckle joint
D	With double knuckle joint and rod end nut
E	With single knuckle joint and rod end nut
F	With rod end nut (For knuckle joint)

Note 1) Rod end brackets are shipped together.

Note 2) A pin and two split pins are attached for double knuckle joint.

Note 3) XC86A to C: Standard type, XC86D to F: Standard type except for rod end thread length (A and H dimensions)

Dimensions (Dimensions other than below are the same as standard type.)

CS1, CS2 series XC86B, XC86C

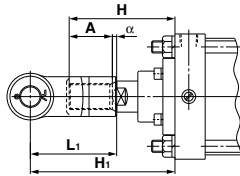

Series	Symbol Bore size (mm)	H	A	α	L ₁	H ₁	CS1		CS2	
							I type single knuckle	Y type double knuckle	I type single knuckle	Y type double knuckle
CS1 CS2	125	110	50	3.5	100	156.5	I-12	Y-12	I-12A	Y-12A
	140	110	50	3.5	105	161.5	I-14	Y-14	I-14A	Y-14A
	160	120	56	3.5	110	170.5	I-16	Y-16	I-16A	Y-16A
CS1	180, 200	135	63	3.5	125	193.5	I-18, I-20	Y-18, Y-20		
	250	160	71	3.5	160	245.5	I-25	Y-25		
	300	175	80	3.5	175	266.5	I-30	Y-30		

CS1, CS2 series XC86D, XC86E

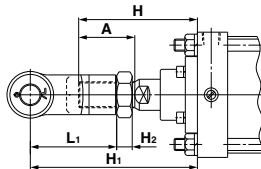

XC86F

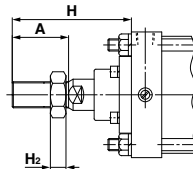

Series	Symbol Bore size (mm)	H	A	L ₁	H ₁	H ₂	CS1		CS2		CS1, CS2 common Applicable rod end nut
							I type single knuckle	Y type double knuckle	I type single knuckle	Y type double knuckle	
CS1 CS2	125	125	65	100	181	18	I-12	Y-12	I-12A	Y-12A	NT-12
	140	125	65	105	186	18	I-14	Y-14	I-14A	Y-14A	NT-12
	160	140	76	110	198	21	I-16	Y-16	I-16A	Y-16A	NT-16
CS1	180	155	83	125	223	23	I-18	Y-18			NT-18
	200	160	88	125	227	27	I-20	Y-20			NT-20
	250	195	106	160	287	34	I-25	Y-25			NT-25
	300	210	115	175	312	38	I-30	Y-30			NT-30



Made to Order Common Specifications: -XC86: With Rod End Bracket -XC87: Cylinder with One-way Lock/Heavy Duty Specifications



60 With Rod End Bracket

Symbol
-XC86

Dimensions (Dimensions other than below are the same as standard type.)

CS2 series
XC86B, XC86C

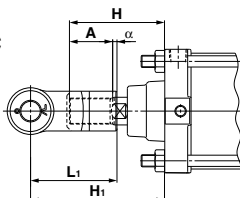

Bore size (mm)	Symbol	H	A	α	L ₁	H ₁	Applicable knuckle joint part no.	
							I type single knuckle	Y type double knuckle
125	110	50	3.5	100	156.5		I-12A	Y-12A
140	110	50	3.5	105	161.5		I-14A	Y-14A
160	120	56	3.5	110	170.5		I-16A	Y-16A

CS2 series
XC86D, XC86E

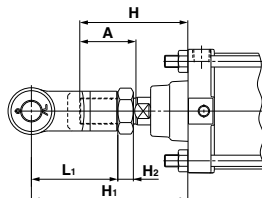

Bore size (mm)	Symbol	H	A	L ₁	H ₁	H ₂	Applicable knuckle joint part no.		Applicable rod end nut
							I type single knuckle	Y type double knuckle	
125	125	65	100	181	18		I-12A	Y-12A	NT-12
140	125	65	105	186	18		I-14A	Y-14A	NT-12
160	140	76	110	198	21		I-16A	Y-16A	NT-16

61 Cylinder with One-way Lock/Heavy Duty Specifications

Symbol
-XC87

Piston rods are heat treated. Even when an external force exceeding the specification range acts temporarily on the piston rod in the locked state, it is resistant to damage and an unlocking failure is unlikely to occur.

Applicable Series

Series	Description	Model	Action	Note	Vol. no. (for std model)
CLQ	Compact cylinder with lock	CLQ	Double acting, Single rod	Applicable to $\phi 40$ to $\phi 100$.	②-2 From P. 1008
RLQ	Compact cylinder with air cushion and lock	RLQ	Double acting, Single rod	Applicable to $\phi 40$ to $\phi 63$.	②-2 From P. 1034
MLGP	Compact guide cylinder with lock	MLGP	Double acting	Applicable to $\phi 40$ to $\phi 100$.	②-2 From P. 1090
CLK2	Clamp cylinder with lock	CLK2	Double acting, Single rod	Applicable to $\phi 40$ to $\phi 63$.	②-3 From P. 448
MLU	Plate cylinder with lock	MLU	Double acting, Single rod	Applicable to $\phi 40$ and $\phi 50$.	②-2 From P. 1060

How to Order

Standard model no. —XC87

Heavy duty specifications ◀

Specifications: Same as standard type
Dimensions: Same as the standard type

Made to Order Common Specifications:

-XC88: Spatter Resistant Coil Scraper, Lube-retainer, Grease for Welding (Piston rod: Stainless steel 304)

-XC89: Spatter Resistant Coil Scraper, Lube-retainer, Grease for Welding (Piston rod: S45C)

-XC91: Spatter Resistant Coil Scraper, Grease for Welding (Piston rod: S45C)



62 Spatter Resistant Coil Scraper, Lube-retainer, Grease for Welding (Piston rod: Stainless steel 304) **-XC88**

63 Spatter Resistant Coil Scraper, Lube-retainer, Grease for Welding (Piston rod: S45C) **-XC89**

Reduces spatter adhesion and improves durability by the use of the coil scraper, Lube-retainer and grease for welding.

64 Spatter Resistant Coil Scraper, Grease for Welding (Piston rod: S45C) **-XC91**

With coil scraper and grease for welding

Applicable Series

Series	Description	Model	Action	XC88	XC89	XC91	Vol. no. (for std model)
MB	Air cylinder	MB-Z	Double acting, Single rod	●	●	●	②-1 From P. 392
CA2	Air cylinder	CA2-Z	Double acting, Single rod	●	●	●	②-1 From P. 470
CQ2	Compact cylinder	CQ2-Z	Double acting, Single rod	●	●	●	②-1 From P. 773
	Long stroke	CQ2-Z	Double acting, Single rod	●	●	—	
	Anti-lateral load	CQ2□S-Z	Double acting, Single rod	●	●	—	
MGP	Compact guide cylinder	MGPM-Z	Double acting	●	—	●	②-2 From P. 432
MK2T	Rotary clamp cylinder	MK2T	Double acting	—	●	●	②-3 From P. 406
CKG1	Clamp cylinder	CKG1-Z	Double acting, Single rod	●	●	●	②-3 From P. 421

Common Specifications: MB, CA2, CQ2, MK2T, CK

Part no.	Piston rod material (Hard chrome plating)		Coil scraper	Lube-retainer	Grease for welding
	S45C	Stainless steel 304			
-XC88	—	●	●	●	●
-XC89	●	—	●	●	●
-XC91	●	—	●	—	●

Note) Use the -XC91 in a place where the distance from the welding portion is far and the spatter scattering is minimized.

Specifications: MGP

Part no.	Piston rod/Guide rod material (Hard chrome plating)		Coil scraper		Lube-retainer		Grease for welding
	S45C	Stainless steel 304	Rod side	Head side	Rod side	Head side	
-XC88	—	●	●	—	●	—	●
-XC91	●	—	●	—	●	—	●
-XC88W	—	●	●	●	●	●	●
-XC89W	●	—	●	●	●	●	●
-XC91W	●	—	●	●	●	—	●

* The current product MGP-XC89 is equivalent to -XC91.

Made to Order Common Specifications:

- XC88: Spatter Resistant Coil Scraper, Lube-retainer, Grease for Welding (Piston rod: Stainless steel 304)
- XC89: Spatter Resistant Coil Scraper, Lube-retainer, Grease for Welding (Piston rod: S45C)
- XC91: Spatter Resistant Coil Scraper, Grease for Welding (Piston rod: S45C)



62 Spatter Resistant Coil Scraper, Lube-retainer, Grease for Welding (Piston rod: Stainless steel 304)

63 Spatter Resistant Coil Scraper, Lube-retainer, Grease for Welding (Piston rod: S45C)

Reduces spatter adhesion and improves durability by the use of the coil scraper, Lube-retainer and grease for welding.

64 Spatter Resistant Coil Scraper, Grease for Welding (Piston rod: S45C)

With coil scraper and grease for welding

MB Series

How to Order

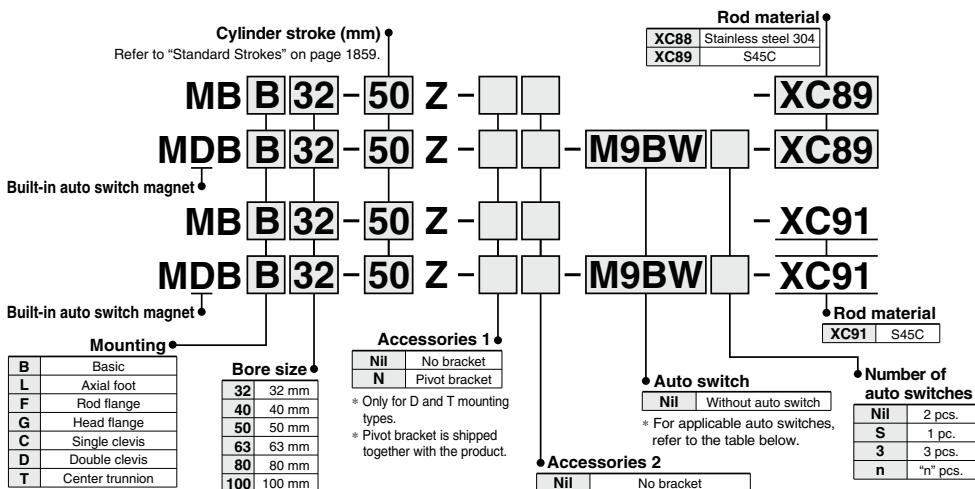

Made to Order

Part no.	Piston rod material (Hard chrome plated)		Coil scraper	Lube-retainer	Grease for welding
	S45C	Stainless steel 304			
-XC88	—	●	●	●	●
-XC89	●	—	●	●	●
-XC91	●	—	●	—	●

Note) Use the -XC91 in a place where the distance from the welding portion is far and the spatter scattering is minimized.

Built-in Auto Switch Magnet Cylinder Model

If a built-in auto switch magnet cylinder without an auto switch is required, there is no need to enter the symbol for the auto switch. (Example) MDBB40-100Z-XC89

Applicable Auto Switches

Refer to pages 1575 to 1701 for further information on auto switches.

Type	Special function	Electrical entry	Indicator light	Wiring (Output)	Load voltage		Auto switch model	Lead wire length (m)			Pre-wired connector	Applicable load		
					DC	AC		0.5 (Nil)	1 (M)	3 (L)			5 (Z)	
Solid state auto switch	—	Grommet	Yes	3-wire (NPN)	24 V	5 V, 12 V	—	M9N	●	●	○	○	IC circuit	
				3-wire (PNP)				●	●	○	○			
				2-wire				●	●	○	○			
	Diagnostic indication (2-color indicator)			3-wire (NPN)				●	●	○	○	IC circuit		
				3-wire (PNP)				●	●	○	○			
				2-wire				●	●	○	○			
				2-wire (Non-polar)				—	—	—	—			
Magnetic field resistant (2-color indicator)	3-wire (NPN)	●	●	○	○	—								
	3-wire (PNP)	●	●	○	○									
	2-wire	●	●	○	○									
Reed auto switch	—	Grommet	Yes	3-wire (NPN equivalent)	24 V	5 V	—	A96	●	●	—	—	IC circuit	—
				2-wire				100 V	●	●	—	—	—	Relay, PLC
				—				100 V or less	●	●	—	—	—	—
				—				—	●	●	—	—	—	IC circuit

- * Lead wire length symbols: 0.5 m Nil (Example) M9NW 1 m M (Example) M9NWM 3 m L (Example) M9NWL 5 m Z (Example) M9NWL
- * Solid state auto switches marked with "O" are produced upon receipt of order.
- * For D-P3DWA/P4DW, ø40 to ø100 are available.
- * For details about auto switches with pre-wired connector, refer to pages 1648 and 1649.

* Please contact SMC for auto switches, auto switch proper mounting positions and operating ranges other than the above.

* The D-A9□/M9□□□/P3DWA auto switches are shipped together, (but not assembled). (However, auto switch mounting brackets are assembled for the D-A9□/M9□□□ before shipment.)

Made to Order Common Specifications:
Spatter Resistant Coil Scraper, Lube-retainer, Grease for Welding (Piston rod: Stainless steel 304)
Spatter Resistant Coil Scraper, Lube-retainer, Grease for Welding (Piston rod: S45C)
Spatter Resistant Coil Scraper, Grease for Welding (Piston rod: S45C)

Symbol

-XC88

-XC89

-XC91



Specifications

Bore size (mm)	32	40	50	63	80	100
Action	Double acting, Single rod					
Fluid	Air					
Proof pressure	1.5 MPa					
Max. operating pressure	1.0 MPa					
Min. operating pressure	0.05 MPa					
Ambient and fluid temperature	Without auto switch: -10 to 70°C (No freezing)					
	With auto switch: -10 to 60°C (No freezing)					
Lubrication	Not required (Non-lube)					
Operating piston speed	50 to 1000 mm/s					
Stroke length tolerance	Up to 250: $^{+1.0}_0$, 251 to 1000: $^{+1.4}_0$, 1001 to 1500: $^{+1.8}_0$					
Cushion	Air cushion					
Port size (Rc)	1/8	1/4		3/8		1/2
Mounting	Basic, Foot, Rod flange, Head flange, Single clevis, Double clevis, Center trunnion					

Standard Strokes

Bore size (mm)	Standard stroke (mm)	Max. stroke
32	25, 50, 75, 100, 125, 150, 175, 200, 250, 300, 350, 400, 450, 500	700
	25, 50, 75, 100, 125, 150, 175, 200, 250, 300, 350, 400, 450, 500	
40	25, 50, 75, 100, 125, 150, 175, 200, 250, 300, 350, 400, 450, 500, 600	800
	25, 50, 75, 100, 125, 150, 175, 200, 250, 300, 350, 400, 450, 500, 600	
50	25, 50, 75, 100, 125, 150, 175, 200, 250, 300, 350, 400, 450, 500, 600	1000
	25, 50, 75, 100, 125, 150, 175, 200, 250, 300, 350, 400, 450, 500, 600	
63	25, 50, 75, 100, 125, 150, 175, 200, 250, 300, 350, 400, 450, 500, 600, 700, 800	1000
	25, 50, 75, 100, 125, 150, 175, 200, 250, 300, 350, 400, 450, 500, 600, 700, 800	
80	25, 50, 75, 100, 125, 150, 175, 200, 250, 300, 350, 400, 450, 500, 600, 700, 800	1000
	25, 50, 75, 100, 125, 150, 175, 200, 250, 300, 350, 400, 450, 500, 600, 700, 800	
100	25, 50, 75, 100, 125, 150, 175, 200, 250, 300, 350, 400, 450, 500, 600, 700, 800	1000
	25, 50, 75, 100, 125, 150, 175, 200, 250, 300, 350, 400, 450, 500, 600, 700, 800	

Manufacture of intermediate strokes is possible. (Spacers are not used.) Produced upon receipt of order.

Accessories

Mounting		Basic	Axial foot	Rod flange	Head flange	Single clevis	Double clevis	Center trunnion
Standard	Rod end nut	●	●	●	●	●	●	●
	Clevis pin	—	—	—	—	—	●	—
Option	Single knuckle joint	●	●	●	●	●	●	●
	Double knuckle joint (with pin)	●	●	●	●	●	●	●

Mounting Brackets/Part No.

Bore size (mm)	32	40	50	63	80	100
Axial foot ^{Note 1)}	MB-L03	MB-L04	MB-L05	MB-L06	MB-L08	MB-L10
Flange	MB-F03	MB-F04	MB-F05	MB-F06	MB-F08	MB-F10
Single clevis	MB-C03	MB-C04	MB-C05	MB-C06	MB-C08	MB-C10
Double clevis	MB-D03	MB-D04	MB-D05	MB-D06	MB-D08	MB-D10

Note 1) Order two axial foot brackets per cylinder.

Note 2) Accessories for each mounting bracket are as follows:

Axial foot, flange, single clevis/body mounting bolt, double clevis/body mounting bolt, clevis pin, flat washers and split pins.

Made to Order Common Specifications:

-XC88: Spatter Resistant Coil Scraper, Lube-retainer, Grease for Welding (Piston rod: Stainless steel 304)

-XC89: Spatter Resistant Coil Scraper, Lube-retainer, Grease for Welding (Piston rod: S45C)

-XC91: Spatter Resistant Coil Scraper, Grease for Welding (Piston rod: S45C)



62 Spatter Resistant Coil Scraper, Lube-retainer, Grease for Welding (Piston rod: Stainless steel 304)

63 Spatter Resistant Coil Scraper, Lube-retainer, Grease for Welding (Piston rod: S45C)

Reduces spatter adhesion and improves durability by the use of the coil scraper, Lube-retainer and grease for welding.

64 Spatter Resistant Coil Scraper, Grease for Welding (Piston rod: S45C)

With coil scraper and grease for welding

Bore Size

ø32 to ø100

Dimensions with mounting bracket are the same as standard type. For details, refer to page 397.

M□B□-XC88
-XC89

Basic: MBB

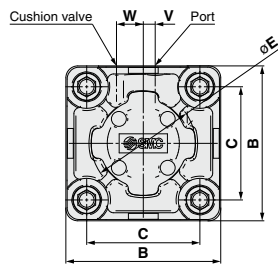
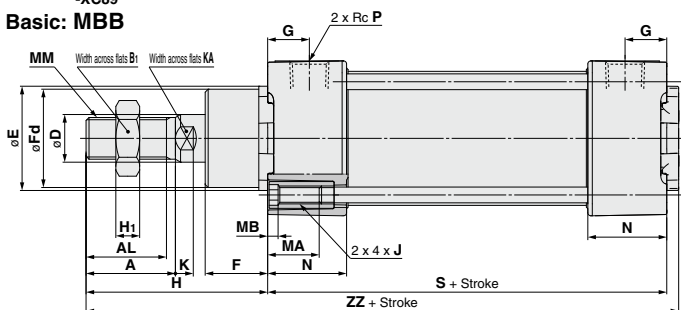

Dimensions

Bore size (mm)	A	AL	B	B ₁	C	D	E	F	F _d	G	H	H ₁	J	K	KA	MA	MB	MM	N	P	S	V	W	ZZ
32	22	19.5	46	17	32.5	12	30	21	28	13	50	6	M6 x 1	6	10	16	4	M10 x 1.25	27	1/8	84	4	6.5	138
40	30	27	52	22	38	16	35	23.5	33	14	61	8	M6 x 1	6	14	16	4	M14 x 1.5	27	1/4	84	4	9	149
50	35	32	65	27	46.5	20	40	23	39.5	15.5	67	11	M8 x 1.25	7	18	16	4	M18 x 1.5	31.5	1/4	94	5	10.5	165
63	35	32	75	27	56.5	20	45	23	39.5	16.5	67	11	M8 x 1.25	7	18	16	4	M18 x 1.5	31.5	3/8	94	9	12	165
80	40	37	95	32	72	25	45	29	44.5	19	82	13	M10 x 1.5	10	22	16	5	M22 x 1.5	38	3/8	114	11.5	14	200
100	40	37	114	41	89	30	55	29	54	19	82	16	M10 x 1.5	10	26	16	5	M26 x 1.5	38	1/2	114	17	15	200

M□B□-XC91

Basic: MBB

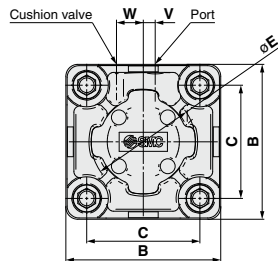
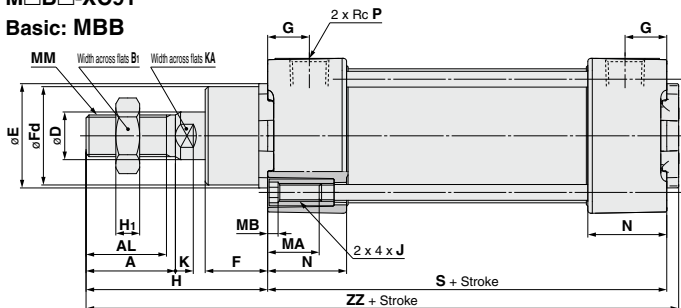

Dimensions

Bore size (mm)	Stroke range	A	AL	B	B ₁	C	D	E	F	F _d	G	H	H ₁	J	K	KA	MA	MB	MM	N	P	S	V	W	ZZ
32	Up to 1000	22	19.5	46	17	32.5	12	30	13	28	13	47	6	M6 x 1	6	10	16	4	M10 x 1.25	27	1/8	84	4	6.5	135
40	Up to 1000	30	27	52	22	38	16	35	13	33	14	58	8	M6 x 1	6	14	16	4	M14 x 1.5	27	1/4	84	4	9	146
50	Up to 1000	35	32	65	27	46.5	20	40	14	39.5	15.5	67	11	M8 x 1.25	7	18	16	5	M18 x 1.5	31.5	1/4	94	5	10.5	165
63	Up to 1000	35	32	75	27	56.5	20	45	14	39.5	16.5	67	11	M8 x 1.25	7	18	16	5	M18 x 1.5	31.5	3/8	94	9	12	165
80	Up to 1000	40	37	95	32	72	25	45	20	44.5	19	81	13	M10 x 1.5	10	22	16	5	M22 x 1.5	38	3/8	114	11.5	14	199
100	Up to 1000	40	37	114	41	89	30	55	20	54	19	81	16	M10 x 1.5	10	26	16	5	M26 x 1.5	38	1/2	114	17	15	199

Made to Order Common Specifications:
Spatter Resistant Coil Scraper, Lube-retainer, Grease for Welding (Piston rod: Stainless steel 304)
Spatter Resistant Coil Scraper, Lube-retainer, Grease for Welding (Piston rod: S45C)
Spatter Resistant Coil Scraper, Grease for Welding (Piston rod: S45C)

Symbol

-XC88

-XC89

-XC91

CA2 Series

How to Order

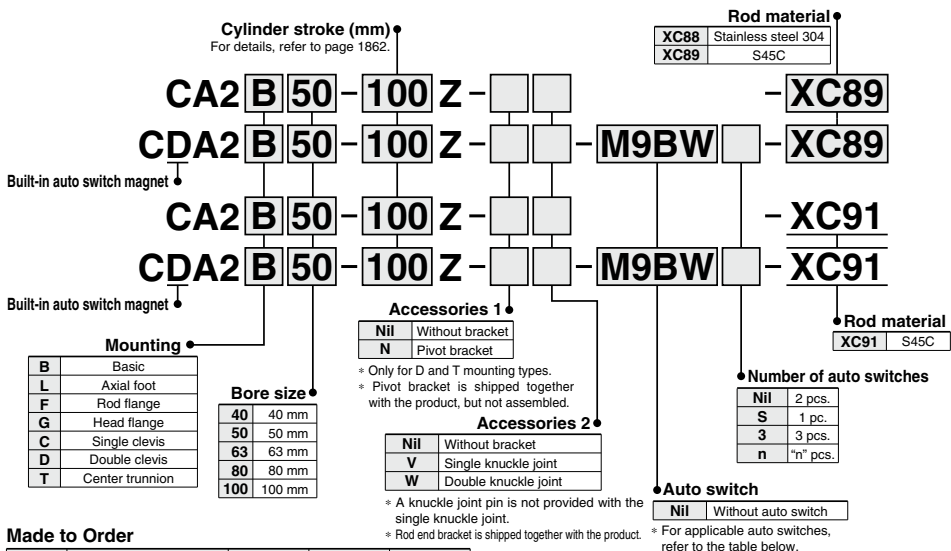

Made to Order

Part no.	Piston rod material (Hard chrome plated)		Coil scraper	Lube-retainer	Grease for welding
	S45C	Stainless steel 304			
-XC88	—	●	●	●	●
-XC89	—	—	●	●	●
-XC91	●	—	●	—	●

Note) Use the -XC91 in a place where the distance from the welding portion is far and the spatter scattering is minimized.

Built-in Auto Switch Magnet Cylinder Model

If a built-in auto switch magnet cylinder without an auto switch is required, there is no need to enter the symbol for the auto switch. (Example) CDA2L40-100Z-XC89

Applicable Auto Switches Refer to pages 1575 to 1701 for further information on auto switches.

Type	Special function	Electrical entry	Indicator light	Wiring (Output)	Load voltage		Auto switch model	Lead wire length (m)				Pre-wired connector	Applicable load			
					DC	AC		0.5 (Nil)	1 (M)	3 (L)	5 (Z)					
Solid state auto switch	—	Grommet	Yes	3-wire (NPN)	24 V	5 V, 12 V	—	M9N	●	●	○	○	IC circuit			
				3-wire (PNP)				M9P	●	●	○	○				
				2-wire				M9B	●	●	○	○				
	3-wire (NPN)			M9NW				●	●	○	○	IC circuit				
	3-wire (PNP)			M9PW				●	●	○	○					
	2-wire			M9BW				●	●	○	○					
Magnetic field resistant (2-color indicator)	—	Grommet	No	2-wire (Non-polar)	—	—	—	P3DWA	●	—	●	●	—			
				—				P4DW	—	—	●	●				
				—				—	—	—	●	●				
Reed auto switch	—	Grommet	Yes	3-wire (NPN equivalent)	24 V	5 V	—	A96	●	—	●	—	IC circuit	—		
				2-wire				100 V	A93	●	●	●	—		—	Relay, PLC
									100 V or less	A90	●	—	●		—	—

* Lead wire length symbols: 0.5 m..... Nil (Example)M9NW
 1 m..... M (Example)M9NWM
 3 m..... L (Example)M9NWL
 5 m..... Z (Example)M9NWZ

* Solid state auto switches marked with "○" are produced upon receipt of order.

* Please contact SMC for auto switches, auto switch proper mounting positions and operating ranges other than the above.

* For details about auto switches with pre-wired connector, refer to pages 1648 and 1649.

* The D-A9□M9□□P3DWA auto switches are shipped together. (but not assembled). (However, auto switch mounting brackets are assembled for the D-A9□M9□□ before shipment.)



Made to Order Common Specifications:

- XC88: Spatter Resistant Coil Scraper, Lube-retainer, Grease for Welding (Piston rod: Stainless steel 304)
- XC89: Spatter Resistant Coil Scraper, Lube-retainer, Grease for Welding (Piston rod: S45C)
- XC91: Spatter Resistant Coil Scraper, Grease for Welding (Piston rod: S45C)



62 Spatter Resistant Coil Scraper, Lube-retainer, Grease for Welding (Piston rod: Stainless steel 304)

63 Spatter Resistant Coil Scraper, Lube-retainer, Grease for Welding (Piston rod: S45C)

Reduces spatter adhesion and improves durability by the use of the coil scraper, Lube-retainer and grease for welding.

64 Spatter Resistant Coil Scraper, Grease for Welding (Piston rod: S45C)

With coil scraper and grease for welding

Specifications



Bore size (mm)		40	50	63	80	100
Fluid		Air				
Action		Double acting				
Proof pressure		1.5 MPa				
Maximum operating pressure		1.0 MPa				
Ambient and fluid temperature		Without auto switch: -10 to 70°C ^{Note 1)} With auto switch: -10 to 60°C ^{Note 1)}				
Minimum operating pressure		0.05 MPa				
Piston speed		50 to 500 mm/s				
Cushion		Air cushion				
Stroke length tolerance		Up to 250 ^{±0.15} 251 to 1000 ^{±0.14}				
Lubrication		Not required (Non-lube)				
Mounting		Basic, Foot, Rod flange, Head flange Single clevis, Double clevis, Center trunnion				
Allowable kinetic energy (J) ^{Note 2)}	When air cushion is activated	2.8	4.6	7.8	16	29
	When air cushion is not activated	0.33	0.56	0.91	1.50	2.68

Note 1) With no freezing

Note 2) Activate the air cushion when operating the cylinder. If this is not done, the rod parts assembly or the tie-rods will be damaged when the allowable kinetic energy exceeds the values shown in the table above.

Standard Strokes

Bore size	Standard stroke ^{Note 1)}		Max. manufacturable stroke ^{Note 2)}
	(mm)		
40	25, 50, 75, 100, 125, 150, 175, 200, 250, 300, 350, 400, 450, 500		1000
50, 63	25, 50, 75, 100, 125, 150, 175, 200, 250, 300, 350, 400, 450, 500, 600		1000
80, 100	25, 50, 75, 100, 125, 150, 175, 200, 250, 300, 350, 400, 450, 500, 600, 700		1000

Note 1) Intermediate strokes not listed above are produced upon receipt of order.

Note 2) For details about applicable maximum stroke, refer to the model selection table on front matter pages.

Minimum Stroke for
Auto Switch Mounting

⚠ Caution

1. The minimum stroke for mounting varies with the auto switch type and cylinder mounting type. In particular, the center trunnion type needs careful attention. (For details, refer to pages 521 and 522.)

Accessories

Mounting		Basic	Axial foot	Rod flange	Head flange	Single clevis	Double clevis	Center trunnion
Standard	Rod end nut	●	●	●	●	●	●	●
	Clevis pin	—	—	—	—	—	●	—
Option	Single knuckle joint	●	●	●	●	●	●	●
	Double knuckle joint (With pin)	●	●	●	●	●	●	●

Made to Order Common Specifications:
Spatter Resistant Coil Scraper, Lube-retainer, Grease for Welding (Piston rod: Stainless steel 304)
Spatter Resistant Coil Scraper, Lube-retainer, Grease for Welding (Piston rod: S45C)
Spatter Resistant Coil Scraper, Grease for Welding (Piston rod: S45C)

Symbol

-XC88

-XC89

-XC91

Bore Size

ø40 to ø100

Dimensions with mounting bracket are the same as standard type. For details, refer to pages 476 to 483.

CA2-XC88

CA2-XC89

Basic: CA2B

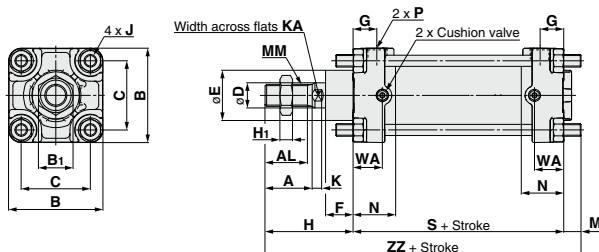

(mm)

Bore size (mm)	A	AL	B	B ₁	C	D	E	F	G	H ₁	J	K	KA	M	MM	N	P	S	WA	H	ZZ
40	30	27	60	22	44	16	32	17.5	15	8	M8 x 1.25	6	14	11	M14 x 1.5	27	1/4	84	18.5	56	151
50	35	32	70	27	52	20	40	15	17	11	M8 x 1.25	7	18	11	M18 x 1.5	30	3/8	90	18.5	60	161
63	35	32	85	27	64	20	40	15	17	11	M10 x 1.25	7	18	14	M18 x 1.5	31	3/8	98	23	60	172
80	40	37	102	32	78	25	52	19	21	13	M12 x 1.75	10	22	17	M22 x 1.5	37	1/2	116	28.5	73	206
100	40	37	116	41	92	30	52	19	21	16	M12 x 1.75	10	26	17	M26 x 1.5	40	1/2	126	28.5	74	217

CA2B□-XC91 * Dimensions are the same as the standard product (CA2 series).

Basic: CA2B

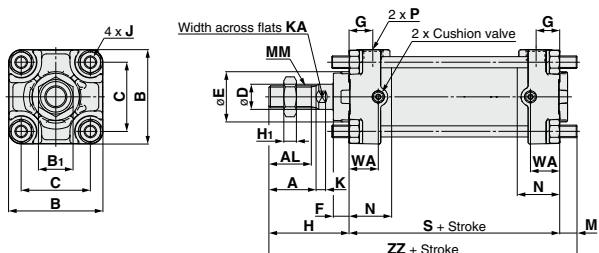

(mm)

Bore size (mm)	A	AL	B	B ₁	C	D	E	F	G	H ₁	J	K	KA	M	MM	N	P	S	WA	H	ZZ
40	30	27	60	22	44	16	32	10	15	8	M8 x 1.25	6	14	11	M14 x 1.5	27	1/4	84	18.5	51	146
50	35	32	70	27	52	20	40	10	17	11	M8 x 1.25	7	18	11	M18 x 1.5	30	3/8	90	18.5	58	159
63	35	32	85	27	64	20	40	10	17	11	M10 x 1.25	7	18	14	M18 x 1.5	31	3/8	98	23	58	170
80	40	37	102	32	78	25	52	14	21	13	M12 x 1.75	10	22	17	M22 x 1.5	37	1/2	116	28.5	71	204
100	40	37	116	41	92	30	52	14	21	16	M12 x 1.75	10	26	17	M26 x 1.5	40	1/2	126	28.5	72	215



Made to Order Common Specifications:

- XC88: Spatter Resistant Coil Scraper, Lube-retainer, Grease for Welding (Piston rod: Stainless steel 304)
- XC89: Spatter Resistant Coil Scraper, Lube-retainer, Grease for Welding (Piston rod: S45C)
- XC91: Spatter Resistant Coil Scraper, Grease for Welding (Piston rod: S45C)



62 Spatter Resistant Coil Scraper, Lube-retainer, Grease for Welding (Piston rod: Stainless steel 304)

63 Spatter Resistant Coil Scraper, Lube-retainer, Grease for Welding (Piston rod: S45C)

Reduces spatter adhesion and improves durability by the use of the coil scraper, Lube-retainer and grease for welding.

64 Spatter Resistant Coil Scraper, Grease for Welding (Piston rod: S45C)

With coil scraper and grease for welding

CQ2 Series: Standard

How to Order

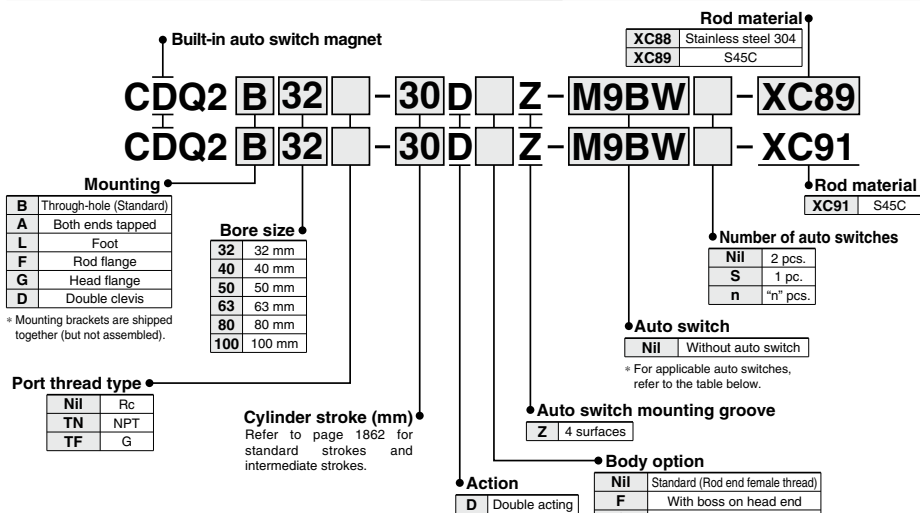

Made to Order

Part no.	Piston rod material (Hard chrome plated)		Coil scraper	Lube-retainer	Grease for welding
	S45C	Stainless steel 304			
-XC88	—	●	●	●	●
-XC89	—	—	●	●	●
-XC91	●	—	●	—	●

Note) Use the -XC91 in a place where the distance from the welding portion is far and the spatter scattering is minimized.

Built-in Auto Switch Magnet Cylinder Model

If a built-in auto switch magnet cylinder without an auto switch is required, there is no need to enter the symbol for the auto switch. (Example) CDQ2L32-25DZ-XC89

Applicable Auto Switches/Refer to pages 1575 to 1701 for further information on auto switches.

Type	Special function	Electrical entry	Indicator light	Wiring (Output)	Load voltage		Auto switch model		Lead wire length (m)					Pre-wired connector	Applicable load
					DC	AC	Perpendicular	In-line	0.5	1	3	5	None		
									(Nil)	(M)	(L)	(Z)	(N)		
Solid state auto switch	—	Grommet	Yes	3-wire (NPN)	24 V	5 V, 12 V	—	M9NV	M9N	●	●	○	—	○	IC circuit
				3-wire (PNP)				M9PV	M9P	●	●	○	—	○	
				2-wire				M9BV	M9B	●	●	○	—	○	
	3-wire (NPN)			M9NWV				M9NW	●	●	○	—	○	IC circuit	
	3-wire (PNP)			M9PWW				M9PW	●	●	○	—	○		
	2-wire			M9BWW				M9BW	●	●	○	—	○		
Reed switch	—	Grommet	Yes	3-wire (NPN equivalent)	24 V	5 V, 12 V	—	A96V	A96	●	●	○	—	○	IC circuit
				2-wire				A93V	A93	●	●	○	—	○	
				—				A90V	A90	●	●	○	—	○	

* Lead wire length symbols: 0.5 m Nil
1 m M
3 m L
5 m Z
(Example) M9NV
(Example) M9NWW
(Example) M9NWL
(Example) M9NWX

* Solid state auto switches marked with "○" are produced upon receipt of order.
* The D-P3DWA□ is mountable on ø32 to ø100.

* Please contact SMC for auto switches, auto switch proper mounting positions and operating ranges other than the above.
* For details about auto switches with pre-wired connector, refer to pages 1648 and 1649.

Made to Order Common Specifications:
Spatter Resistant Coil Scraper, Lube-retainer, Grease for Welding (Piston rod: Stainless steel 304)
Spatter Resistant Coil Scraper, Lube-retainer, Grease for Welding (Piston rod: S45C)
Spatter Resistant Coil Scraper, Grease for Welding (Piston rod: S45C)

Symbol

-XC88

-XC89

-XC91

Specifications



Pneumatic type

Bore size (mm)	32	40	50	63	80	100	
Action	Double acting, Single rod						
Fluid	Air						
Proof pressure	1.5 MPa						
Maximum operating pressure	1.0 MPa						
Minimum operating pressure	0.05 MPa						
Ambient and fluid temperature	-10 to 60°C (No freezing)						
Lubrication	Not required (Non-lube)						
Piston speed	50 to 500 mm/s						
Allowable kinetic energy (J)	Standard	0.15	0.26	0.46	0.77	1.36	2.27
	With rubber bumper	0.29	0.52	0.91	1.54	2.71	4.54
Stroke length tolerance	+1.0 mm (Note) 0						

Note) Stroke length tolerance does not include the amount of bumper change.

Standard Strokes

Pneumatic type (mm)

Bore size	Standard stroke
32, 40	5, 10, 15, 20, 25, 30, 35, 40, 45, 50, 75, 100
50 to 100	10, 15, 20, 25, 30, 35, 40, 45, 50, 75, 100

- For long strokes exceeding the standard stroke range, refer to page 1871.
- For intermediate strokes, refer below.

Mounting Brackets/Part No.

Bore size (mm)	Model	Foot (Note 1)	Flange	Double clevis
32	CDQ2□□-□DZ	CQ-L032-XC35	CQ-F032-XC35	CQ-D032
40	CDQ2□□-□DZ	CQ-L040	CQ-F040	CQ-D040
50	CDQ2□□-□DZ	CQ-L050	CQ-F050	CQ-D050
63	CDQ2□□-□DZ	CQ-L063	CQ-F063	CQ-D063
80	CDQ2□□-□DZ	CQ-L080	CQ-F080	CQ-D080
100	CDQ2□□-□DZ	CQ-L100	CQ-F100	CQ-D100

Note 1) Order two foot brackets per cylinder. (except ø32)

Note 2) For ø32 type, order 1 piece per cylinder. (Part number for a set of 2 foot brackets)

Note 2) Parts belonging to each bracket are as follows.
 Foot or Flange: Body mounting bolts
 Double clevis: Clevis pin, Type C retaining rings for axis, Body mounting bolts

Manufacture of Intermediate Strokes

Spacer-installed type: Standard model number

- A spacer is installed on the standard strokes.
- Available in 1 mm increments
- A spacer is installed on tubes with a stroke longer than the specified stroke (◆).

◆: Standard stroke

Bore size (mm)	Stroke range	Type	Stroke																				
			5	10	15	20	25	30	35	40	45	50	75	100									
32, 40	1 to 99	Spacer-installed type 1	◆	◆	◆	◆	◆	◆	◆	◆	◆	◆	◆	◆	◆	◆	◆	◆	◆	◆	◆	◆	
50 to 100	1 to 99	type 1	◆	◆	◆	◆	◆	◆	◆	◆	◆	◆	◆	◆	◆	◆	◆	◆	◆	◆	◆	◆	

Ordering example: ø32-57 mm stroke, with through-hole and without auto switch

Type	Spacer-installed type 1
Part no.	Standard model number
Order no.	CDQ2B32-57DZ-XC89
Ordering example	Description <ul style="list-style-type: none"> • Uses a standard stroke (75 mm) tube. • Makes 57 mm stroke with 18 mm spacer inside. • The B dimension is 108 mm.



Made to Order Common Specifications:

-XC88: Spatter Resistant Coil Scraper, Lube-retainer, Grease for Welding (Piston rod: Stainless steel 304)

-XC89: Spatter Resistant Coil Scraper, Lube-retainer, Grease for Welding (Piston rod: S45C)

-XC91: Spatter Resistant Coil Scraper, Grease for Welding (Piston rod: S45C)



62 Spatter Resistant Coil Scraper, Lube-retainer, Grease for Welding (Piston rod: Stainless steel 304)

63 Spatter Resistant Coil Scraper, Lube-retainer, Grease for Welding (Piston rod: S45C)

Reduces spatter adhesion and improves durability by the use of the coil scraper, Lube-retainer and grease for welding.

64 Spatter Resistant Coil Scraper, Grease for Welding (Piston rod: S45C)

With coil scraper and grease for welding

Bore Size

ø32 to ø50

Dimensions with mounting bracket are the same as standard type. For details, refer to pages 790 to 792.

CDQ2 □ XC88
 XC89

Through-hole (Standard): CDQ2B

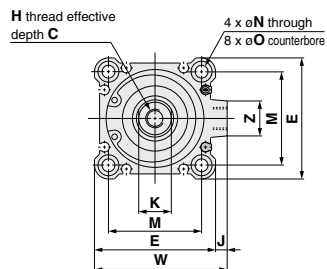

Both ends tapped: CDQ2A

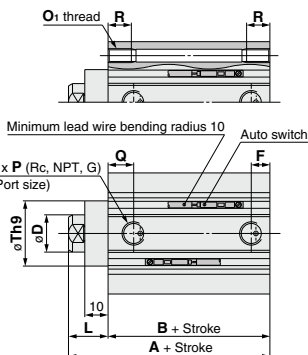

Both Ends Tapped (mm)

Bore size (mm)	Ø1	R
32	M6 x 1.0	10
40	M6 x 1.0	10
50	M8 x 1.25	14

With boss on head end

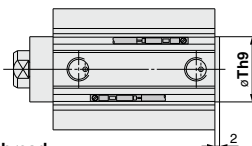

With Boss on Head End (mm)

Bore size (mm)	Th9
32	21 ⁰ _{-0.032}
40	28 ⁰ _{-0.032}
50	35 ⁰ _{-0.062}

Rod end male thread

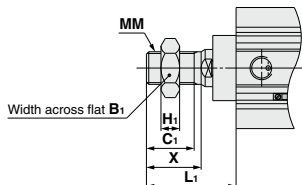

Rod End Male Thread (mm)

Bore size (mm)	B1	C1	H1	L1	MM	X
32	22	20.5	8	38.5	M14 x 1.5	23.5
40	22	20.5	8	38.5	M14 x 1.5	23.5
50	27	26	11	43.5	M18 x 1.5	28.5

Standard

Bore size (mm)	Stroke range (mm)	A	B	C	D	E	F	H	J	K	L	M	N	O	P	Q	Th9	W	Z
32	5 to 50, 75, 100	50	33	13	16	45	7.5	M8 x 1.25	4.5	14	17	34	5.5	9 depth 7	1/8	10	23 ⁰ _{-0.032}	49.5	14
40	5 to 50, 75, 100	56.5	39.5	13	16	52	7.5	M8 x 1.25	5	14	17	40	5.5	9 depth 7	1/8	12.5	28 ⁰ _{-0.032}	57	15
50	10 to 50, 75, 100	58.5	40.5	15	20	64	10.5	M10 x 1.5	7	17	18	50	6.6	11 depth 8	1/4	10.5	35 ⁰ _{-0.062}	71	19

Note 1) The external dimensions with rubber bumper are same as those of the standard, as shown above.

* For details about the rod end nut and accessory brackets, refer to pages 796 to 798.

Note 2) For calculation on the longitudinal dimension of intermediate strokes, refer to page 1865.

Made to Order Common Specifications:
Spatter Resistant Coil Scraper, Lube-retainer, Grease for Welding (Piston rod: Stainless steel 304)
Spatter Resistant Coil Scraper, Lube-retainer, Grease for Welding (Piston rod: S45C)
Spatter Resistant Coil Scraper, Grease for Welding (Piston rod: S45C)

Symbol

-XC88

-XC89

-XC91

Bore Size

ø63 to ø100

Dimensions with mounting bracket are the same as standard type. For details, refer to pages 793 to 795.

CDQ2 □ ^{-XC88}
^{-XC89}

Through-hole (Standard): CDQ2B

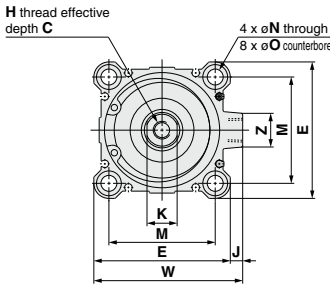

Both ends tapped: CDQ2A

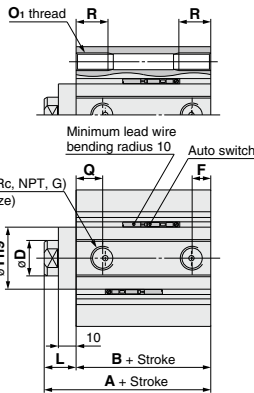

Both Ends Tapped (mm)

Bore size (mm)	O ₁	R
63	M10 x 1.5	18
80	M12 x 1.75	22
100	M12 x 1.75	22

With Boss on Head End (mm)

Bore size (mm)	Th9
63	35 ⁰ _{-0.062}
80	43 ⁰ _{-0.062}
100	59 ⁰ _{-0.074}

With boss on head end

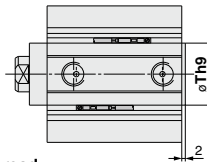

Rod end male thread

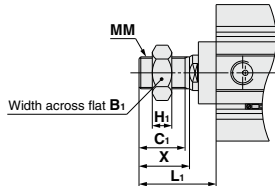

Rod End Male Thread (mm)

Bore size (mm)	B ₁	C ₁	H ₁	L ₁	MM	X
63	27	26	11	43.5	M18 x 1.5	28.5
80	32	32.5	13	53.5	M22 x 1.5	35.5
100	41	32.5	16	53.5	M26 x 1.5	35.5

Standard

Bore size (mm)	Stroke range (mm)	A	B	C	D	E	F	H	J	K	L	M	N	O	P	Q	Th9	W	Z
63	10 to 50, 75, 100	64	46	15	20	77	10.5	M10 x 1.5	7	17	18	60	9	14 depth 10.5	1/4	15	35 ⁰ _{-0.062}	84	19
80	10 to 50, 75, 100	73.5	53.5	21	25	98	12.5	M16 x 2.0	6	22	20	77	11	17.5 depth 13.5	3/8	16	43 ⁰ _{-0.062}	104	25
100	10 to 50, 75, 100	85	63	27	30	117	13	M20 x 2.5	6.5	27	22	94	11	17.5 depth 13.5	3/8	23	59 ⁰ _{-0.074}	123.5	25

Note 1) The external dimensions with rubber bumper are same as those of the standard, as shown above.

* For details about the rod end nut and accessory brackets, refer to pages 796 to 798.

Note 2) For calculation on the longitudinal dimension of intermediate strokes, refer to page 1865.



Made to Order Common Specifications:

-XC88: Spatter Resistant Coil Scraper, Lube-retainer, Grease for Welding (Piston rod: Stainless steel 304)

-XC89: Spatter Resistant Coil Scraper, Lube-retainer, Grease for Welding (Piston rod: S45C)

-XC91: Spatter Resistant Coil Scraper, Grease for Welding (Piston rod: S45C)



62 Spatter Resistant Coil Scraper, Lube-retainer, Grease for Welding (Piston rod: Stainless steel 304)

63 Spatter Resistant Coil Scraper, Lube-retainer, Grease for Welding (Piston rod: S45C)

Reduces spatter adhesion and improves durability by the use of the coil scraper, Lube-retainer and grease for welding.

64 Spatter Resistant Coil Scraper, Grease for Welding (Piston rod: S45C)

With coil scraper and grease for welding

Bore Size

ø32 to ø50

Dimensions with mounting bracket are the same as standard type. For details, refer to pages 790 to 792.

CDQ2□-XC91

Both ends tapped: CDQ2A

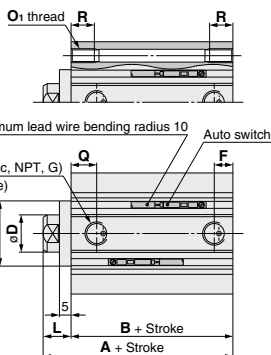

Both Ends Tapped (mm)

Bore size (mm)	O1	R
32	M6 x 1.0	10
40	M6 x 1.0	10
50	M8 x 1.25	14

Through-hole (Standard): CDQ2B

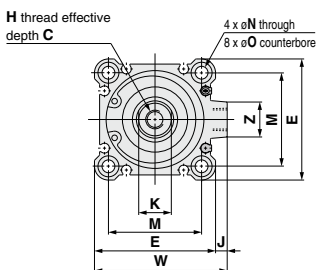

With boss on head end

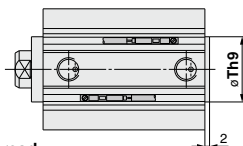

With Boss on Head End (mm)

Bore size (mm)	Th9
32	21 ⁰ _{-0.032}
40	28 ⁰ _{-0.032}
50	35 ⁰ _{-0.062}

Rod end male thread

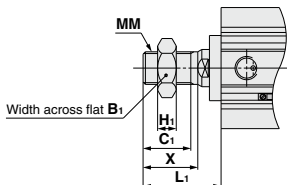

Rod End Male Thread (mm)

Bore size (mm)	B1	C1	H1	L1	MM	X
32	22	20.5	8	33.5	M14 x 1.5	23.5
40	22	20.5	8	33.5	M14 x 1.5	23.5
50	27	26	11	38.5	M18 x 1.5	28.5

Standard

Bore size (mm)	Stroke range (mm)	A	B	C	D	E	F	H	J	K	L	M	N	O	P	Q	Th9	W	Z
32	5 to 50, 75, 100	45	33	13	16	45	7.5	M8 x 1.25	4.5	14	12	34	5.5	9 depth 7	1/8	10	23 ⁰ _{-0.032}	49.5	14
40	5 to 50, 75, 100	51.5	39.5	13	16	52	7.5	M8 x 1.25	5	14	12	40	5.5	9 depth 7	1/8	12.5	28 ⁰ _{-0.032}	57	15
50	10 to 50, 75, 100	53.5	40.5	15	20	64	10.5	M10 x 1.5	7	17	13	50	6.6	11 depth 8	1/4	10.5	35 ⁰ _{-0.062}	71	19

Note 1) The external dimensions with rubber bumper are same as those of the standard, as shown above.

* For details about the rod end nut and accessory brackets, refer to pages 796 to 798.

Note 2) For calculation on the longitudinal dimension of intermediate strokes, refer to page 1865.

Made to Order Common Specifications:
Spatter Resistant Coil Scraper, Lube-retainer, Grease for Welding (Piston rod: Stainless steel 304)
Spatter Resistant Coil Scraper, Lube-retainer, Grease for Welding (Piston rod: S45C)
Spatter Resistant Coil Scraper, Grease for Welding (Piston rod: S45C)

Symbol

-XC88

-XC89

-XC91

Bore Size

ø63 to ø100

Dimensions with mounting bracket are the same as standard type. For details, refer to pages 793 to 795.

CDQ2□-XC91

Through-hole (Standard): CDQ2B

Both ends tapped: CDQ2A

Both Ends Tapped (mm)

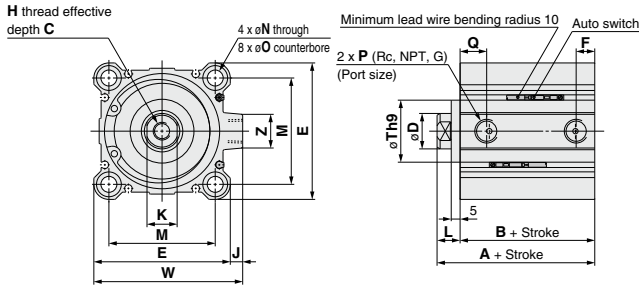

Bore size (mm)	O ₁	R
63	M10 x 1.5	18
80	M12 x 1.75	22
100	M12 x 1.75	22

With boss on head end

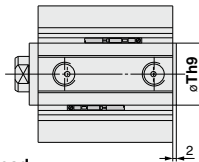

With Boss on Head End (mm)

Bore size (mm)	Th9
63	35 ⁰ _{-0.062}
80	43 ⁰ _{-0.062}
100	59 ⁰ _{-0.074}

Rod end male thread

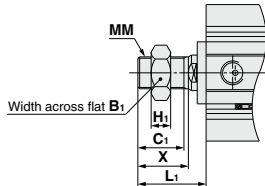

Rod End Male Thread (mm)

Bore size (mm)	B ₁	C ₁	H ₁	L ₁	MM	X
63	27	26	11	38.5	M18 x 1.5	28.5
80	32	32.5	13	48.5	M22 x 1.5	35.5
100	41	32.5	16	48.5	M26 x 1.5	35.5

Standard

Bore size (mm)	Stroke range (mm)	A	B	C	D	E	F	H	J	K	L	M	N	O	P	Q	Th9	W	Z
63	10 to 50, 75, 100	59	46	15	20	77	10.5	M10 x 1.5	7	17	13	60	9	14 depth 10.5	1/4	15	35 ⁰ _{-0.062}	84	19
80	10 to 50, 75, 100	68.5	53.5	21	25	98	12.5	M16 x 2.0	6	22	15	77	11	17.5 depth 13.5	3/8	16	43 ⁰ _{-0.062}	104	25
100	10 to 50, 75, 100	80	63	27	30	117	13	M20 x 2.5	6.5	27	17	94	11	17.5 depth 13.5	3/8	23	59 ⁰ _{-0.074}	123.5	25

Note 1) The external dimensions with rubber bumper are same as those of the standard, as shown above.

* For details about the rod end nut and accessory brackets, refer to pages 796 to 798.

Note 2) For calculation on the longitudinal dimension of intermediate strokes, refer to page 1865.



Made to Order Common Specifications:

-XC88: Spatter Resistant Coil Scraper, Lube-retainer, Grease for Welding (Piston rod: Stainless steel 304)

-XC89: Spatter Resistant Coil Scraper, Lube-retainer, Grease for Welding (Piston rod: S45C)

-XC91: Spatter Resistant Coil Scraper, Grease for Welding (Piston rod: S45C)



62 Spatter Resistant Coil Scraper, Lube-retainer, Grease for Welding (Piston rod: Stainless steel 304)

63 Spatter Resistant Coil Scraper, Lube-retainer, Grease for Welding (Piston rod: S45C)

Reduces spatter adhesion and improves durability by the use of the coil scraper, Lube-retainer and grease for welding.

64 Spatter Resistant Coil Scraper, Grease for Welding (Piston rod: S45C)

With coil scraper and grease for welding

CQ2 Series: Long Stroke How to Order

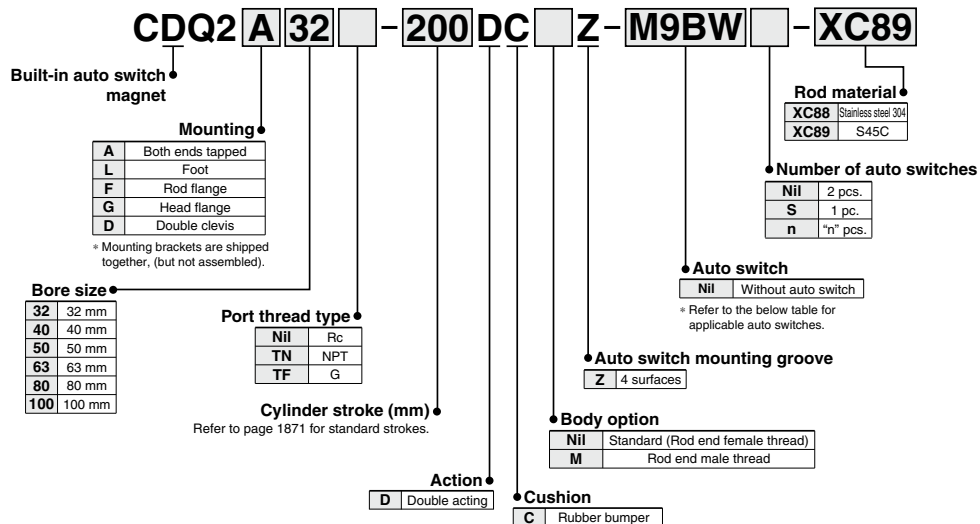

Made to Order

Part no.	Piston rod material (Hard chrome plated)		Coil scraper	Lube-retainer	Grease for welding
	S45C	Stainless steel 304			
-XC88	—	●	●	●	●
-XC89	●	—	●	●	●

Built-in Auto Switch Magnet Cylinder Model

If a built-in auto switch magnet cylinder without an auto switch is required, there is no need to enter the symbol for the auto switch. (Example) CDQ2L40-200DCZ-XC89

Applicable Auto Switches

Refer to pages 1575 to 1701 for further information on auto switches.

Type	Special function	Electrical entry	Indicator light	Wiring (Output)	Load voltage		Auto switch model		Lead wire length (m)					Pre-wired connector	Applicable load					
					DC	AC	Perpendicular	In-line	0.5 (Nil)	1 (M)	3 (L)	5 (Z)	None (N)		IC circuit	Relay, PLC				
Solid state auto switch	—	Grommet	Yes	3-wire (NPN)	24 V	—	M9NV	M9N	●	●	●	○	—	○			—	—		
				3-wire (PNP)			M9PV	M9P	●	●	●	○	—	○						
	2-wire			M9BV			M9B	●	●	●	○	—	○	—						
	3-wire (NPN)			M9NVW			M9NW	●	●	●	○	—	○	—	IC circuit					
	3-wire (PNP)			M9PVW			M9PW	●	●	●	○	—	○							
	2-wire			M9BW			M9B	●	●	●	○	—	○							
2-wire (Non-polar)	—	P3DWA	●	●	●	○	—	○	—											
Reed auto switch	—	Grommet	Yes	3-wire (NPN equivalent)	24 V	12 V 5 V, 12 V	100 V 100 V or less	A96V	A96	●	●	●	—	—	—	—	IC circuit	—		
				2-wire				A93V	A93	●	●	●	●	—	—	—	—	—	—	Relay, PLC
				—				A90V	A90	●	●	●	—	—	—	—	—	—	—	—

* Lead wire length symbols: 0.5 m Nil

(Example) M9NW

1 m M (Example) M9NVW

3 m L (Example) M9NWL

5 m Z (Example) M9NZ

* Solid state auto switches marked with "○" are produced upon receipt of order.

* Please contact SMC for auto switches, auto switch proper mounting positions and operating ranges other than the above.

* For details about auto switches with pre-wired connector, refer to pages 1648 and 1649.

Made to Order Common Specifications:
Spatter Resistant Coil Scraper, Lube-retainer, Grease for Welding (Piston rod: Stainless steel 304)
Spatter Resistant Coil Scraper, Lube-retainer, Grease for Welding (Piston rod: S45C)
Spatter Resistant Coil Scraper, Grease for Welding (Piston rod: S45C)

Symbol

-XC88

-XC89

-XC91

Specifications

Bore size (mm)	32	40	50	63	80	100
Action	Double acting, Single rod					
Fluid	Air					
Proof pressure	1.5 MPa					
Maximum operating pressure	1.0 MPa					
Minimum operating pressure	0.05 MPa					
Ambient and fluid temperature	-10 to 60°C (No freezing)					
Lubrication	Not required (Non-lube)					
Piston speed	50 to 500 mm/s					
Allowable kinetic energy (J)	0.29	0.52	0.91	1.54	2.71	4.54
Stroke length tolerance	+1.4 mm (Note) 0					

Note) Stroke length tolerance does not include the amount of bumper change.

Standard Strokes

Bore size	Standard stroke
32, 40, 50 63, 80, 100	125, 150, 175, 200, 250, 300

(mm)

Manufacture of Intermediate Strokes

Type	A spacer is installed in the standard stroke body.	
Part no.	Refer to "How to Order" for the standard model number. (Page 1870)	
Description	Strokes in 1 mm increments are available by installing a spacer in the standard stroke cylinder.	
Stroke range	Bore size	Stroke range
	32 to 100	101 to 299
Example	Part no.: CDQ2A50-166DCZ-XC89 CDQ2A50-175DCZ-XC89 with 9 mm width spacer inside The B dimension is 235.5 mm.	

Type

		Bore size (mm)	32	40	50	63	80	100	
Pneumatic	Built-in magnet for auto switch		●	●	●	●	●	●	
	Piping	Pipe thread	—	Rc1/8	Rc1/8	Rc1/4	Rc1/4	Rc3/8	Rc3/8
			TN	NPT1/8	NPT1/8	NPT1/4	NPT1/4	NPT3/8	NPT3/8
				TF	G1/8	G1/8	G1/4	G1/4	G3/8
	Rod end male thread		●	●	●	●	●	●	



Made to Order Common Specifications:

- XC88: Spatter Resistant Coil Scraper, Lube-retainer, Grease for Welding (Piston rod: Stainless steel 304)
- XC89: Spatter Resistant Coil Scraper, Lube-retainer, Grease for Welding (Piston rod: S45C)
- XC91: Spatter Resistant Coil Scraper, Grease for Welding (Piston rod: S45C)



62 Spatter Resistant Coil Scraper, Lube-retainer, Grease for Welding (Piston rod: Stainless steel 304)

63 Spatter Resistant Coil Scraper, Lube-retainer, Grease for Welding (Piston rod: S45C)

Reduces spatter adhesion and improves durability by the use of the coil scraper, Lube-retainer and grease for welding.

64 Spatter Resistant Coil Scraper, Grease for Welding (Piston rod: S45C)

With coil scraper and grease for welding

Bore Size

ø32 to ø50

Dimensions with mounting bracket are the same as standard type. For details, refer to pages 790 to 792.

CDQ2 □ ^{XC88}
□ ^{XC89}

Both ends tapped: CDQ2A

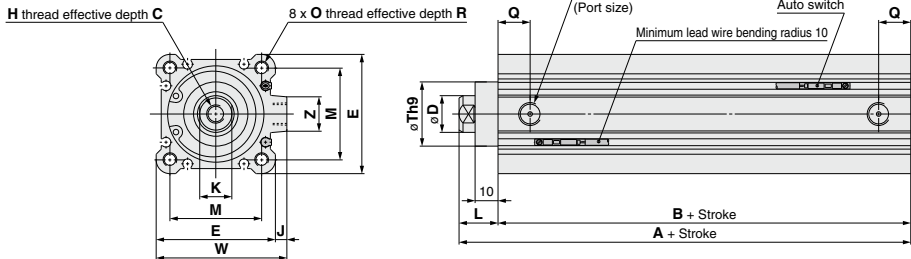

Rod end male thread

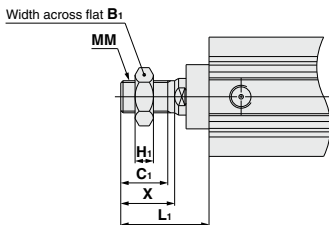

Rod End Male Thread

Bore size (mm)	B ₁	C ₁	H ₁	L ₁	MM	X
32	22	20.5	8	38.5	M14 x 1.5	23.5
40	22	20.5	8	38.5	M14 x 1.5	23.5
50	27	26	11	43.5	M18 x 1.5	28.5

Both Ends Tapped

Bore size (mm)	Stroke range (mm)	A	B	C	D	E	H	J	K	L	M	O	P	Q	R	Th9	W	Z
32	125 to 200 (Note 1) 250, 300	67.5	50.5	13	16	45	M8 x 1.25	4.5	14	17	34	M6 x 1.0	1/8	10	10	23 ⁰ _{0.052}	49.5	14
		77	60	13	16	52	M8 x 1.25	5	14	17	40	M6 x 1.0	1/8	12.5	10	28 ⁰ _{0.052}	57	15
50		78.5	60.5	15	20	64	M10 x 1.5	7	17	18	50	M8 x 1.25	1/4	14	14	35 ⁰ _{0.062}	71	19

Note 1) For 125 to 200 strokes, strokes are available in 25 mm increments.

Note 2) For calculation on the longitudinal dimension of intermediate strokes, refer to page 1865.

Made to Order Common Specifications:
Spatter Resistant Coil Scraper, Lube-retainer, Grease for Welding (Piston rod: Stainless steel 304)
Spatter Resistant Coil Scraper, Lube-retainer, Grease for Welding (Piston rod: S45C)
Spatter Resistant Coil Scraper, Grease for Welding (Piston rod: S45C)

Symbol

-XC88

-XC89

-XC91

Bore Size

∅63 to ∅100

Dimensions with mounting bracket are the same as standard type. For details, refer to pages 793 to 795.

CDQ2 □ **-XC88**
-XC89

Both ends tapped: CDQ2A

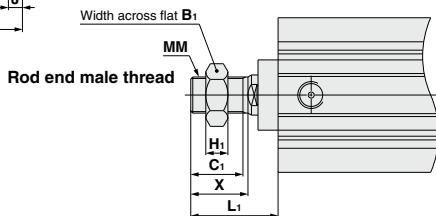
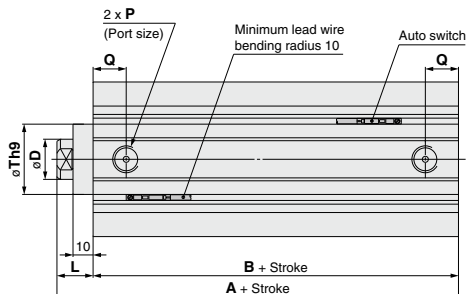
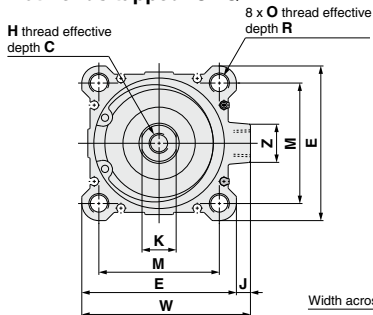

Rod End Male Thread (mm)

Bore size (mm)	B ₁	C ₁	H ₁	L ₁	MM	X
63	27	26	11	43.5	M18 x 1.5	28.5
80	32	32.5	13	53.5	M22 x 1.5	35.5
100	41	32.5	16	53.5	M26 x 1.5	35.5

Both Ends Tapped

Bore size (mm)	Stroke range (mm)	A	B	C	D	E	H	J	K	L	M	O	P	Q	R	Th9	W	Z
63	125 to 200 (Note 1) 250, 300	80	62	15	20	77	M10 x 1.5	7	17	18	60	M10 x 1.5	1/4	16.5	18	35 ^{0.062}	84	19
80		91	71	21	25	98	M16 x 2.0	6	22	20	77	M12 x 1.75	3/8	19	22	43 ^{0.062}	104	25
100		102.5	80.5	27	30	117	M20 x 2.5	6.5	27	22	94	M12 x 1.75	3/8	23	22	59 ^{0.074}	123.5	25

Note 1) For 125 to 200 strokes, strokes are available in 25 mm increments.

Note 2) For calculation on the longitudinal dimension of intermediate strokes, refer to page 1865.

Made to Order Common Specifications:

- XC88: Spatter Resistant Coil Scraper, Lube-retainer, Grease for Welding (Piston rod: Stainless steel 304)
- XC89: Spatter Resistant Coil Scraper, Lube-retainer, Grease for Welding (Piston rod: S45C)
- XC91: Spatter Resistant Coil Scraper, Grease for Welding (Piston rod: S45C)



62 Spatter Resistant Coil Scraper, Lube-retainer, Grease for Welding (Piston rod: Stainless steel 304)

63 Spatter Resistant Coil Scraper, Lube-retainer, Grease for Welding (Piston rod: S45C)

Reduces spatter adhesion and improves durability by the use of the coil scraper, Lube-retainer and grease for welding.

64 Spatter Resistant Coil Scraper, Grease for Welding (Piston rod: S45C)

With coil scraper and grease for welding

CQ2 □ S Series: Anti-lateral Load How to Order

CDQ2 B S 32 - 30 D C Z - M9BW - XC89

Built-in auto switch magnet •

Mounting •

B	Through-hole (Standard)
A	Both ends tapped
L	Foot
F	Rod flange
G	Head flange
D	Double clevis

* Mounting brackets are shipped together, (but not assembled).

Type •

S	Anti-lateral load
---	-------------------

Bore size •

32	32 mm
40	40 mm
50	50 mm
63	63 mm
80	80 mm
100	100 mm

Port thread type •

Nil	Rc
TN	NPT
TF	G

Cylinder stroke (mm) •

Refer to page 1875 for standard strokes.

Action •

D	Double acting
---	---------------

Rod material •

XC88	Stainless steel 304
XC89	S45C

Number of auto switches

Nil	2 pcs.
S	1 pc.
n	"n" pcs.

Auto switch

Nil	Without auto switch
-----	---------------------

* Refer to the below table for applicable auto switches.

Auto switch mounting groove

Z	4 surfaces
---	------------

Body option 2

Nil	Standard (Rod end female thread)
M	Rod end male thread

Cushion

C	Rubber bumper
---	---------------

Body option 1

Nil	Standard
F	With boss on head end

Made to Order

Part no.	Piston rod material (Hard chrome plated)		Coil scraper	Lube-retainer	Grease for welding
	S45C	Stainless steel 304			
-XC88	—	●	●	●	●
-XC89	●	—	●	●	●

Built-in Auto Switch Magnet Cylinder Model

If a built-in auto switch magnet cylinder without an auto switch is required, there is no need to enter the symbol for the auto switch. (Example) CDQ2L540-30DCZ-XC89

Applicable Auto Switches Refer to pages 1575 to 1701 for further information on auto switches.

Type	Special function	Electrical entry	Indicator light	Wiring (Output)	Load voltage		Auto switch model		Lead wire length (m)					Pre-wired connector	Applicable load		
					DC	AC	Perpendicular	In-line	0.5 (Nil)	1 (M)	3 (L)	5 (Z)	None (N)		IC circuit	Relay, PLC	
																	5 V, 12 V
Solid state auto switch	—	Grommet	Yes	3-wire (NPN)	24 V	—	—	M9PV	M9N	●	●	●	○	—	○	IC circuit	Relay, PLC
				3-wire (PNP)				M9PV	M9P	●	●	●	○	—	○		
				2-wire				M9BV	M9B	●	●	●	○	—	○		
	Diagnostic indication (2-color indicator)			3-wire (NPN)				M9NWW	M9NW	●	●	●	○	—	○	IC circuit	
				3-wire (PNP)				M9PWW	M9PW	●	●	●	○	—	○		
				2-wire				M9BWW	M9BW	●	●	●	○	—	○		
Magnetic field resistant (2-color indicator)	—	Grommet	No	2-wire (Non-polar)	24 V	—	—	—	P3DWA	●	●	●	●	●	—	—	
				—				P4DW	—	—	●	●	●	●	●	—	—
Reed auto switch	—	Grommet	Yes	3-wire (NPN equivalent)	24 V	—	—	A96V	A96	●	●	●	○	—	—	IC circuit	—
				—				A93V	A93	●	●	●	○	—	—	Relay, PLC	
				2-wire				A90V	A90	●	●	●	○	—	—	IC circuit	

* Lead wire length symbols: 0.5 m Nil
1 m M
3 m L
5 m Z

(Example) M9NV
(Example) M9NWM
(Example) M9NWL
(Example) M9NWX

* Solid state auto switches marked with "○" are produced upon receipt of order.

* Please contact SMC for auto switches, auto switch proper mounting positions and operating ranges other than the above.
* For details about auto switches with pre-wired connector, refer to pages 1648 and 1649.

Made to Order Common Specifications:
Spatter Resistant Coil Scraper, Lube-retainer, Grease for Welding (Piston rod: Stainless steel 304)
Spatter Resistant Coil Scraper, Lube-retainer, Grease for Welding (Piston rod: S45C)
Spatter Resistant Coil Scraper, Grease for Welding (Piston rod: S45C)

Symbol

-XC88

-XC89

-XC91

Specifications

Bore size (mm)	32	40	50	63	80	100
Action	Double acting, Single rod					
Fluid	Air					
Proof pressure	1.5 MPa					
Maximum operating pressure	1.0 MPa					
Minimum operating pressure	0.05 MPa					
Ambient and fluid temperature	-10 to 60°C (No freezing)					
Lubrication	Not required (Non-lube)					
Piston speed	50 to 500 mm/s					
Allowable kinetic energy (J)	0.29	0.52	0.91	1.54	2.71	4.54
Stroke length tolerance	+1.0 mm (Note) 0					

Note) Stroke length tolerance does not include the amount of dumper change.

Standard Strokes

Bore size	Standard stroke (mm)
32, 40	5, 10, 15, 20, 25, 30, 35, 40, 45, 50, 75, 100
50, 63, 80, 100	10, 15, 20, 25, 30, 35, 40, 45, 50, 75, 100

Manufacture of Intermediate Strokes

Type	A spacer is installed in the standard stroke body.	
Part no.	Refer to "How to Order" for the standard model number. (Page 1874)	
Description	Strokes in 1 mm increments are available by installing a spacer in the standard stroke cylinder.	
Stroke range	Bore size	Stroke range
	32 to 100	1 to 99
Example	Part no.: CDQ2BS50-57DCZ-XC89 CDQ2BS50-75DCZ-XC89 with 18 mm width spacer inside The B dimension is 125.5 mm.	

Type

Bore size (mm)		32	40	50	63	80	100	
Pneumatic	Mounting	Through-hole (Standard)	●	●	●	●	●	
		Both ends tapped	●	●	●	●	●	
		Built-in magnet for auto switch	●	●	●	●	●	
	Piping	Pipe thread	Rc1/8	Rc1/8	Rc1/4	Rc1/4	Rc3/8	Rc3/8
			NPT1/8	NPT1/8	NPT1/4	NPT1/4	NPT3/8	NPT3/8
			G1/8	G1/8	G1/4	G1/4	G3/8	G3/8
		Rod end male thread	●	●	●	●	●	●
		With rubber bumper (Standard)	●	●	●	●	●	●
		With boss on head end	●	●	●	●	●	●

-XC □

Made to Order Common Specifications:

- XC88: Spatter Resistant Coil Scraper, Lube-retainer, Grease for Welding (Piston rod: Stainless steel 304)
- XC89: Spatter Resistant Coil Scraper, Lube-retainer, Grease for Welding (Piston rod: S45C)
- XC91: Spatter Resistant Coil Scraper, Grease for Welding (Piston rod: S45C)



62 Spatter Resistant Coil Scraper, Lube-retainer, Grease for Welding (Piston rod: Stainless steel 304)

63 Spatter Resistant Coil Scraper, Lube-retainer, Grease for Welding (Piston rod: S45C)

Reduces spatter adhesion and improves durability by the use of the coil scraper, Lube-retainer and grease for welding.

64 Spatter Resistant Coil Scraper, Grease for Welding (Piston rod: S45C)

With coil scraper and grease for welding

Bore Size

ø32 to ø50

Dimensions with mounting bracket are the same as standard type. For details, refer to pages 790 to 792.

CDQ2□S-XC88
CDQ2□S-XC89

Both ends tapped: CDQ2AS

Through-hole (Standard): CDQ2BS

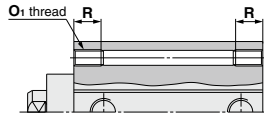

Both Ends Tapped

Bore size (mm)	O ₁	R
32	M6 x 1.0	10
40	M6 x 1.0	10
50	M8 x 1.25	14

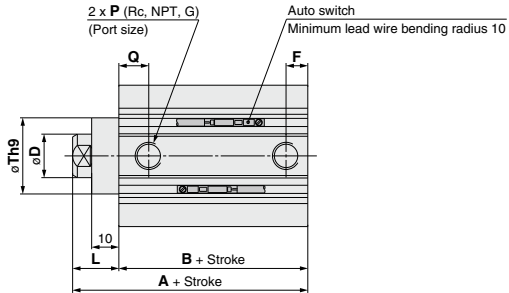
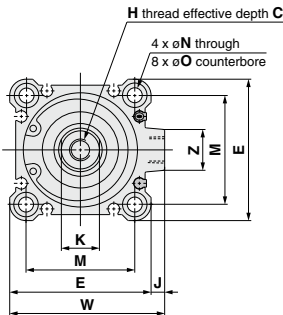

Rod end male thread

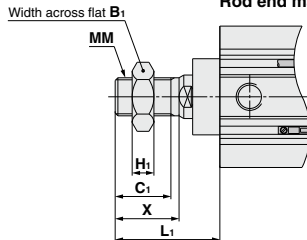

Rod End Male Thread

Bore size (mm)	B ₁	C ₁	H ₁	L ₁	MM	X
32	22	20.5	8	38.5	M14 x 1.5	23.5
40	22	20.5	8	38.5	M14 x 1.5	23.5
50	27	26	11	43.5	M18 x 1.5	28.5

The dimensions with boss on head end are equivalent to those of the CDQ2 series, double acting, single rod. Refer to page 1866.

Bore size (mm)	Stroke range (mm)	A	B	C	D	E	F	H	J	K	L	M	N	O	Th9	P	Q	W	Z
32	5 to 50, 75, 100	60	43	13	16	45	7.5	M8 x 1.25	4.5	14	17	34	5.5	9 depth 7	23 ⁰ / _{0.052}	1/8	10	49.5	14
40	5 to 50, 75, 100	66.5	49.5	13	16	52	7.5	M8 x 1.25	5	14	17	40	5.5	9 depth 7	28 ⁰ / _{0.052}	1/8	12.5	57	15
50	10 to 50, 75, 100	68.5	50.5	15	20	64	10.5	M10 x 1.5	7	17	18	50	6.6	11 depth 8	35 ⁰ / _{0.052}	1/4	10.5	71	19

Made to Order Common Specifications:
Spatter Resistant Coil Scraper, Lube-retainer, Grease for Welding (Piston rod: Stainless steel 304)
Spatter Resistant Coil Scraper, Lube-retainer, Grease for Welding (Piston rod: S45C)
Spatter Resistant Coil Scraper, Grease for Welding (Piston rod: S45C)

Symbol

-XC88

-XC89

-XC91

Bore Size

ø63 to ø100

Dimensions with mounting bracket are the same as standard type. For details, refer to pages 793 to 795.

CDQ2□S-XC88
 CDQ2□S-XC89

Both ends tapped: CDQ2AS

Both Ends Tapped

Bore size (mm)	O ₁	R
63	M10 x 1.5	18
80	M12 x 1.75	22
100	M12 x 1.75	22

Through-hole (Standard): CDQ2BS

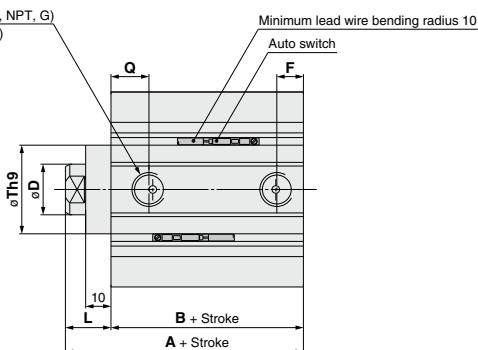
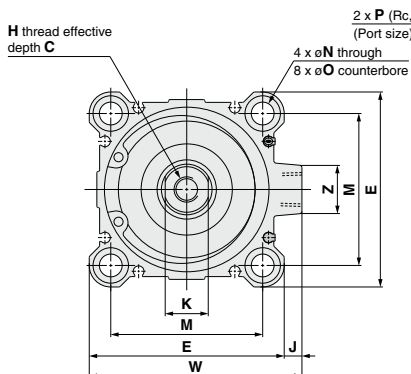
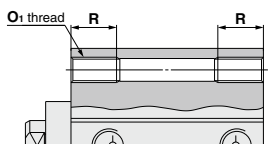

Rod end male thread

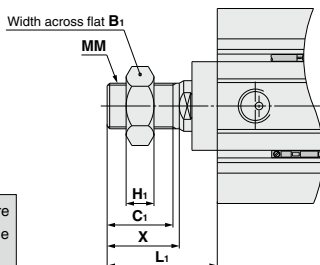

Rod End Male Thread

Bore size (mm)	B ₁	C ₁	H ₁	L ₁	MM	X
63	27	26	11	43.5	M18 x 1.5	28.5
80	32	32.5	13	53.5	M22 x 1.5	35.5
100	41	32.5	16	53.5	M26 x 1.5	35.5

The dimensions with boss on head end are equivalent to those of the CDQ2 series, double acting, single rod. Refer to page 1867.

Bore size (mm)	Stroke range (mm)	A	B	C	D	E	F	H	J	K	L	M	N	O	P	Q	Th9	W	Z
63	10 to 50, 75, 100	74	56	15	20	77	10.5	M10 x 1.5	7	17	18	60	9	14 depth 10.5	1/4	15	35 ^{0.062}	84	19
80	10 to 50, 75, 100	83.5	63.5	21	25	98	12.5	M16 x 2.0	6	22	20	77	11	17.5 depth 13.5	3/8	16	43 ^{0.062}	104	25
100	10 to 50, 75, 100	95	73	27	30	117	13	M20 x 2.5	6.5	27	22	94	11	17.5 depth 13.5	3/8	23	59 ^{0.078}	123.5	25



Made to Order Common Specifications:

- XC88: Spatter Resistant Coil Scraper, Lube-retainer, Grease for Welding (Piston rod: Stainless steel 304)
- XC89: Spatter Resistant Coil Scraper, Lube-retainer, Grease for Welding (Piston rod: S45C)
- XC91: Spatter Resistant Coil Scraper, Grease for Welding (Piston rod: S45C)



62 Spatter Resistant Coil Scraper, Lube-retainer, Grease for Welding (Rod parts: Stainless steel 304)

63 Spatter Resistant Coil Scraper, Lube-retainer, Grease for Welding (Rod parts: S45C)

Reduces spatter adhesion and improves durability by the use of the coil scraper, Lube-retainer and grease for welding.

64 Spatter Resistant Coil Scraper, Grease for Welding (Rod parts: S45C)

With coil scraper and grease for welding

MGP Series

How to Order

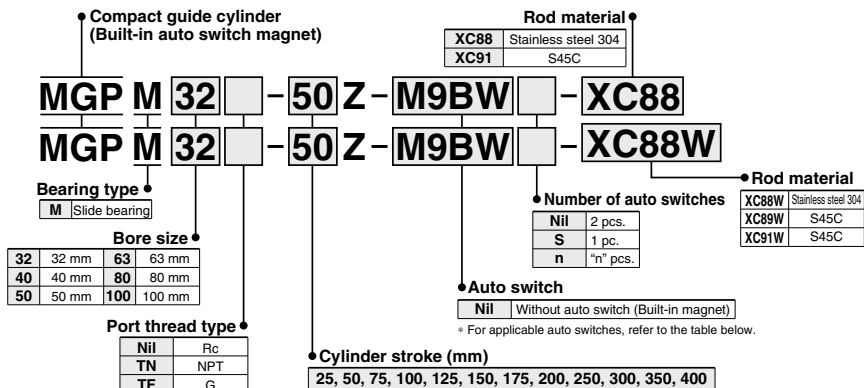

Made to Order

Part no.	Piston rod/ Guide rod material (Hard chrome plating)		Coil scraper		Lube-retainer		Grease for welding
	S45C	Stainless steel 304	Rod side	Head side	Rod side	Head side	
-XC88	—	●	●	—	●	—	●
-XC91	●	—	●	—	●	—	●
-XC88W	—	●	●	●	●	●	●
-XC89W	●	—	●	●	●	●	●
-XC91W	●	—	●	●	●	—	●

* The current product MGP-XC89 is equivalent to -XC91.

Specifications

Bore size		ø32	ø40	ø50	ø63	ø80	ø100
Action		Double acting					
Fluid		Air					
Proof pressure		1.5 MPa					
Maximum operating pressure		1.0 MPa					
Minimum operating pressure	XC88, XC91	0.12 MPa					
	XC88W, XC89W, XC91W	0.14 MPa					
Ambient and fluid temperature		-10°C to 60°C (No freezing)					
Cushion		Rubber bumper on both ends					
Lubrication		Not required (Non-lube)					
Stroke length tolerance		±0.1 mm					

Applicable Auto Switches

Refer to pages 1575 to 1701 for further information on auto switches.

Type	Special function	Electrical entry	Indicator light	Wiring (Output)	Load voltage		Auto switch model					Pre-wired connector	Applicable load			
					DC	AC	Perpendicular		In-line				—	—		
							0.5 (Nil)	1 (M)	3 (L)	5 (Z)	—				—	
Solid state auto switch	—	Grommet	Yes	3-wire (NPN)	24 V	5 V, 12 V	—	M9NV	M9N	●	●	●	○	IC circuit	Relay, PLC	
				3-wire (PNP)				M9PV	M9P	●	●	○	○			
				2-wire				M9BV	M9B	●	●	○	○			
	Diagnostic indication (2-color indicator)			3-wire (NPN)				M9NVW	M9NW	●	●	○	○	IC circuit		
				3-wire (PNP)				M9VW	M9PW	●	●	○	○			
				2-wire				M9BW	M9BW	●	●	○	○			
Magnetic field resistant (2-color indicator)	2-wire (Non-polar)	—	—	—	—	—	—	—	—	—	—	—				
	—	—	—	—	—	—	—	—	—	—	—	—				
Reed auto switch	—	Grommet	Yes	3-wire (NPN equivalent)	24 V	5 V	—	A96V	A96	●	●	—	—	IC circuit	—	
				—				A93V	A93	●	●	●	●	—	—	Relay, PLC
				2-wire				A90V	A90	●	●	—	—	—	—	IC circuit

* Lead wire length symbols: 0.5 m..... Nil (Example) M9NV
 1 m..... M (Example) M9NVW
 3 m..... L (Example) M9NWL
 5 m..... Z (Example) M9NWZ

* Solid state auto switches marked with "○" are produced upon receipt of order.
 * Auto switches other than P3DWA/P4DW cannot be used under the magnetic field environment.
 * Please contact SMC for auto switches, auto switch proper mounting positions and operating ranges other than the above.

* Auto switches are shipped together, (but not assembled).

* For details about auto switches with pre-wired connector, refer to pages 1648 and 1649.

Made to Order Common Specifications:
Spatter Resistant Coil Scraper, Lube-retainer, Grease for Welding (Piston rod: Stainless steel 304)
Spatter Resistant Coil Scraper, Lube-retainer, Grease for Welding (Piston rod: S45C)
Spatter Resistant Coil Scraper, Grease for Welding (Piston rod: S45C)

Symbol

-XC88

-XC89

-XC91

Bore Size

ø32 to ø63

MGPM -XC88
-XC91

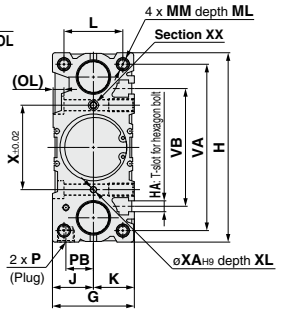
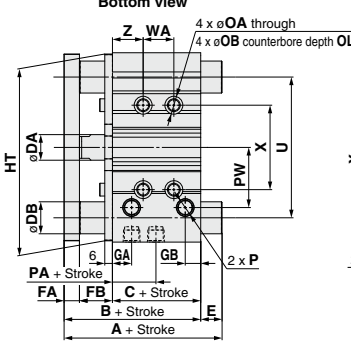
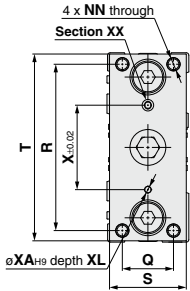
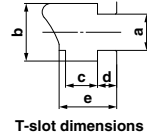
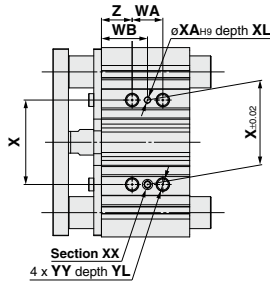
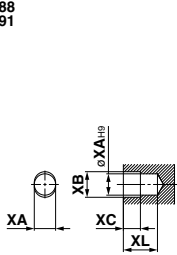

Bore size (mm)	Standard stroke	A			B	C	DA	DB	E			FA	FB	G	GA	GB	H	HA	HT	J
		50 st or less	Over 50 st 200 st or less	Over 200 st					50 st or less	Over 50 st 200 st or less	Over 200 st									
32	25, 50, 75, 100	85	103.5	139.5	69.5	37.5	14	20	15.5	34	70	10	22	48	12	9	112	M6	110	24
40	125, 150, 175, 200	85	103.5	139.5	76	44	14	20	9	27.5	63.5	10	22	54	15	12	120	M6	118	27
50	250, 300, 350, 400	98.5	119.5	160.5	82	44	20	25	16.5	37.5	78.5	12	26	64	15	12	148	M8	146	32
63		98.5	119.5	160.5	87	49	20	25	11.5	32.5	73.5	12	26	78	15.5	13.5	162	M10	160	39

Bore size	K	L	MM	ML	NN	OA	OB	OL	P			PA	PB	PW	Q	R	S	T	U	VA	VB
									NI	TN	TF										
32	24	34	M8 x 1.25	20	M8 x 1.25	6.7	11	7.5	Rc1/8	NPT1/8	G1/8	6.5	16	35.5	30	96	44	110	78	98	63
40	27	40	M8 x 1.25	20	M8 x 1.25	6.7	11	7.5	Rc1/8	NPT1/8	G1/8	13	18	39.5	30	104	44	118	86	106	72
50	32	46	M10 x 1.5	22	M10 x 1.5	8.6	14	9	Rc1/4	NPT1/4	G1/4	9	21.5	47	40	130	60	146	110	130	92
63	39	58	M10 x 1.5	22	M10 x 1.5	8.6	—	9	Rc1/4	NPT1/4	G1/4	13	28	58	50	130	70	158	124	142	110

Bore size	WA					WB					X	XA	XB	XC	XL	YY	YL	Z	a	b	c	d	e
	25 st or less	Over 25 st 100 st or less	Over 100 st 200 st or less	Over 200 st 300 st or less	Over 300 st	25 st or less	Over 25 st 100 st or less	Over 100 st 200 st or less	Over 200 st 300 st or less	Over 300 st													
32	24	48	124	200	300	33	45	83	121	171	42	4	4.5	3	6	M8 x 1.25	16	21	6.5	10.5	5.5	3.5	9.5
40	24	48	124	200	300	34	46	84	122	172	50	4	4.5	3	6	M8 x 1.25	16	22	6.5	10.5	5.5	4	11
50	24	48	124	200	300	36	48	86	124	174	66	5	6	4	8	M10 x 1.5	20	24	8.5	13.5	7.5	4.5	13.5
63	28	52	128	200	300	38	50	88	124	174	80	5	6	4	8	M10 x 1.5	20	24	11	17.8	10	7	18.5



Made to Order Common Specifications:

-XC88: Spatter Resistant Coil Scraper, Lube-retainer, Grease for Welding (Piston rod: Stainless steel 304)

-XC89: Spatter Resistant Coil Scraper, Lube-retainer, Grease for Welding (Piston rod: S45C)

-XC91: Spatter Resistant Coil Scraper, Grease for Welding (Piston rod: S45C)



62 Spatter Resistant Coil Scraper, Lube-retainer, Grease for Welding (Rod parts: Stainless steel 304)

63 Spatter Resistant Coil Scraper, Lube-retainer, Grease for Welding (Rod parts: S45C)

Reduces spatter adhesion and improves durability by the use of the coil scraper, Lube-retainer and grease for welding.

64 Spatter Resistant Coil Scraper, Grease for Welding (Rod parts: S45C)

With coil scraper and grease for welding

Bore Size

ø80, ø100

MGPM-XC88
-XC91

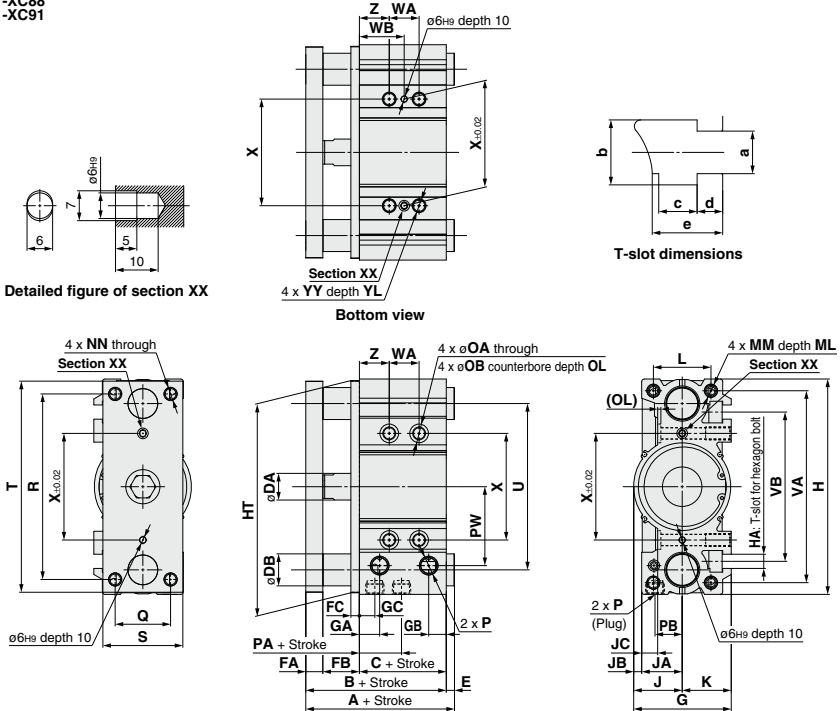

(mm)

Bore size	Standard stroke	A				B	C	DA	DB	E			FA	FB	FC	G	GA	GB	GC	H	HA
		50 st or less	Over 50 st 200 st or less	Over 200 st	50 st or less					Over 50 st 200 st or less	Over 200 st										
80	25, 50, 75, 100, 125, 150, 175,	114.5	141.5	190.5	106.5	56.5	25	30	8	35	84	16	34	8	91.5	19	16.5	14.5	202	M12	
100	200, 250, 300, 350, 400	136.5	161.5	200.5	126	66	30	36	10.5	35.5	74.5	19	41	9	111.5	22.5	20.5	18	240	M14	

Bore size	HT	J	JA	JB	JC	K	L	MM	ML	NN	OA	OB	OL	P										
														Nil	TN	TF	PA	PB	PW	Q	R	S	T	U
80	199	45.5	38	7.5	15	46	54	M12 x 1.75	25	M12 x 1.75	10.6	17.5	3	Rc3/8	NPT3/8	G3/8	14.5	25.5	74	52	174	75	198	156
100	236	55.5	45	10.5	10	56	62	M14 x 2	31	M14 x 2	12.5	20	8	Rc3/8	NPT3/8	G3/8	17.5	32.5	89	64	210	90	236	188

Bore size	WA					WB					X	YY	YL	Z	a	b	c	d	e		
	VA	VB	25 st or less	Over 25 st 100 st or less	Over 100 st 200 st or less	Over 200 st 300 st or less	Over 300 st	25 st or less	Over 25 st 100 st or less	Over 100 st 200 st or less										Over 200 st 300 st or less	Over 300 st
80	180	140	28	52	128	200	300	42	54	92	128	178	100	M12 x 1.75	24	28	13.3	20.3	12	8	22.5
100	210	166	48	72	148	220	320	35	47	85	121	171	124	M14 x 2	28	11	15.3	23.3	13.5	10	30

Made to Order Common Specifications:
Spatter Resistant Coil Scraper, Lube-retainer, Grease for Welding (Piston rod: Stainless steel 304)
Spatter Resistant Coil Scraper, Lube-retainer, Grease for Welding (Piston rod: S45C)
Spatter Resistant Coil Scraper, Grease for Welding (Piston rod: S45C)

Symbol

-XC88

-XC89

-XC91

Bore Size

ø32 to ø63

MGPM -XC88W
 -XC89W

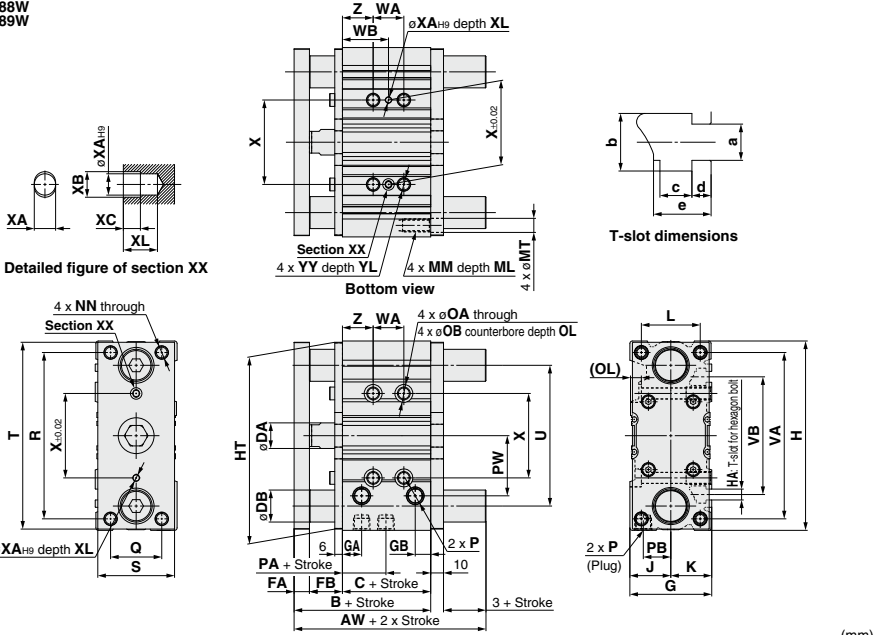

(mm)

Bore size	Standard stroke	AW	B	C	DA	DB	FA	FB	G	GA	GB	H	HA	HT	J	K	L	MM	ML	MT	NN
32	25, 50, 75, 100, 125,	82.5	69.5	37.5	14	20	10	22	48	12	9	112	M6	110	24	24	34	M8 x 1.25	20	9	M8 x 1.25
40	150, 175, 200, 250,	89	76	44	14	20	10	22	54	15	12	120	M6	118	27	27	40	M8 x 1.25	20	8.5	M8 x 1.25
50	300, 350, 400	95	82	44	20	25	12	26	64	15	12	148	M8	146	32	32	46	M10 x 1.5	22	11	M10 x 1.5
63		100	87	49	20	25	12	26	78	15.5	13.5	162	M10	160	39	39	58	M10 x 1.5	22	11	M10 x 1.5

Bore size	OA	OB	OL	P			PA	PB	PW	Q	R	S	T	U	VA	VB	WA				
				NII	TN	TF											25 st or less	Over 25 st 100 st or less	Over 100 st 200 st or less	Over 200 st 300 st or less	Over 300 st
32	6.7	11	7.5	Rc1/8	NPT1/8	G1/8	6.5	16	35.5	30	96	44	110	78	98	63	24	48	124	200	300
40	6.7	11	7.5	Rc1/8	NPT1/8	G1/8	13	18	39.5	30	104	44	118	86	106	72	24	48	124	200	300
50	8.6	14	9	Rc1/4	NPT1/4	G1/4	9	21.5	47	40	130	60	146	110	130	92	24	48	124	200	300
63	8.6	—	9	Rc1/4	NPT1/4	G1/4	13	28	58	50	130	70	158	124	142	110	28	52	128	200	300

Bore size	WB					X	XA	XB	XC	XL	YY	YL	Z	a	b	c	d	e
	25 st or less	Over 25 st 100 st or less	Over 100 st 200 st or less	Over 200 st 300 st or less	Over 300 st													
32	33	45	83	121	171	42	4	4.5	3	6	M8 x 1.25	16	21	6.5	10.5	5.5	3.5	9.5
40	34	46	84	122	172	50	4	4.5	3	6	M8 x 1.25	16	22	6.5	10.5	5.5	4	11
50	36	48	86	124	174	66	5	6	4	8	M10 x 1.5	20	24	8.5	13.5	7.5	4.5	13.5
63	38	50	88	124	174	80	5	6	4	8	M10 x 1.5	20	24	11	17.8	10	7	18.5



Made to Order Common Specifications:

-XC88: Spatter Resistant Coil Scraper, Lube-retainer, Grease for Welding (Piston rod: Stainless steel 304)

-XC89: Spatter Resistant Coil Scraper, Lube-retainer, Grease for Welding (Piston rod: S45C)

-XC91: Spatter Resistant Coil Scraper, Grease for Welding (Piston rod: S45C)



62 Spatter Resistant Coil Scraper, Lube-retainer, Grease for Welding (Rod parts: Stainless steel 304)

63 Spatter Resistant Coil Scraper, Lube-retainer, Grease for Welding (Rod parts: S45C)

Reduces spatter adhesion and improves durability by the use of the coil scraper, Lube-retainer and grease for welding.

64 Spatter Resistant Coil Scraper, Grease for Welding (Rod parts: S45C)

With coil scraper and grease for welding

Bore Size

ø80, ø100

MGPM -XC88W
-XC89W

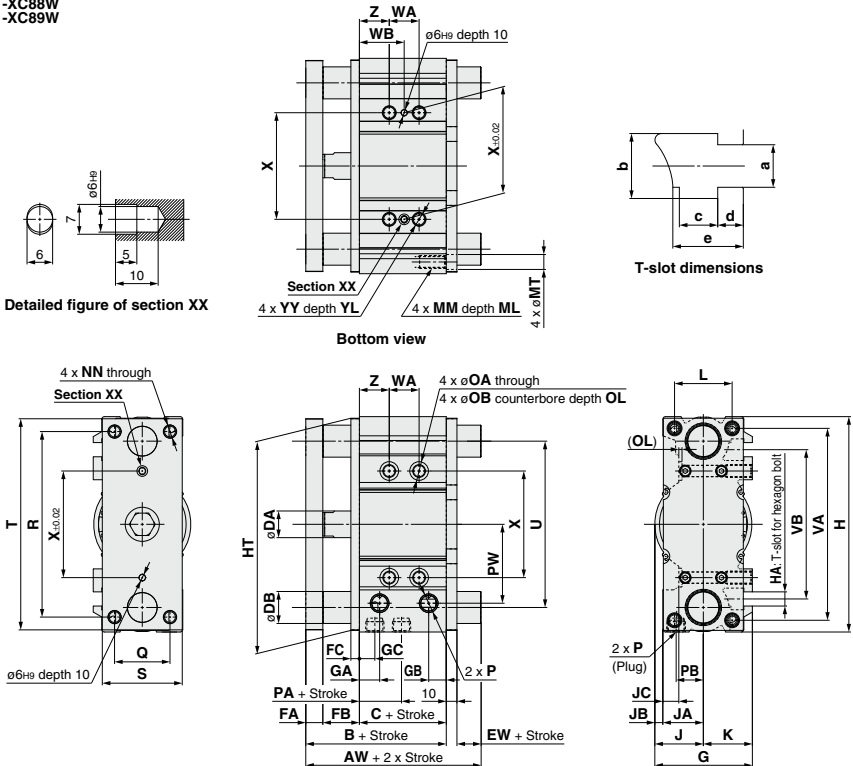

Bore size	Standard stroke										AW	B	C	DA	DB	EW	FA	FB	FC	G	GA	GB	GC	H	HA	HT	J	JA	JB
80	25	50	75	100	125	150	175	120.5	106.5	56.5	25	30	4	16	34	8	91.5	19	16.5	14.5	202	M12	199	45.5	38	7.5			
100	200	250	300	350	400		143	126	66	30	36	7	19	41	9	111.5	22.5	20.5	18	240	M14	236	55.5	45	10.5				

Bore size	JC	K	L	MM	ML	MT	NN	OA	OB	OL	P						PA	PB	PW	Q	R	S	T	U	VA
											Nil	TN	TF	PA	PB	PW									
80	15	46	54	M12 x 1.75	25	14	M12 x 1.75	10.6	17.5	3	Rc3/8	NPT3/8	G3/8	14.5	25.5	74	52	174	75	198	156	180			
100	10	56	62	M14 x 2	31	16	M14 x 2	12.5	20	8	Rc3/8	NPT3/8	G3/8	17.5	32.5	89	64	210	90	236	188	210			

Bore size	VB	WA				WB						X	YY	YL	Z	a	b	c	d	e	
		25 st or less	Over 25 st or less	Over 100 st or less	Over 200 st or less	Over 300 st or less	25 st or less	Over 25 st or less	Over 100 st or less	Over 200 st or less	Over 300 st or less										
80	140	28	52	128	200	300	300	42	54	92	128	178	100	M12 x 1.75	24	28	13.3	20.3	12	8	22.5
100	166	48	72	148	220	320	320	35	47	85	121	171	124	M14 x 2	28	11	15.3	23.3	13.5	10	30

Made to Order Common Specifications:
Spatter Resistant Coil Scraper, Lube-retainer, Grease for Welding (Piston rod: Stainless steel 304)
Spatter Resistant Coil Scraper, Lube-retainer, Grease for Welding (Piston rod: S45C)
Spatter Resistant Coil Scraper, Grease for Welding (Piston rod: S45C)

Symbol

-XC88

-XC89

-XC91

Bore Size

ø32 to ø63

MGPM-XC91W

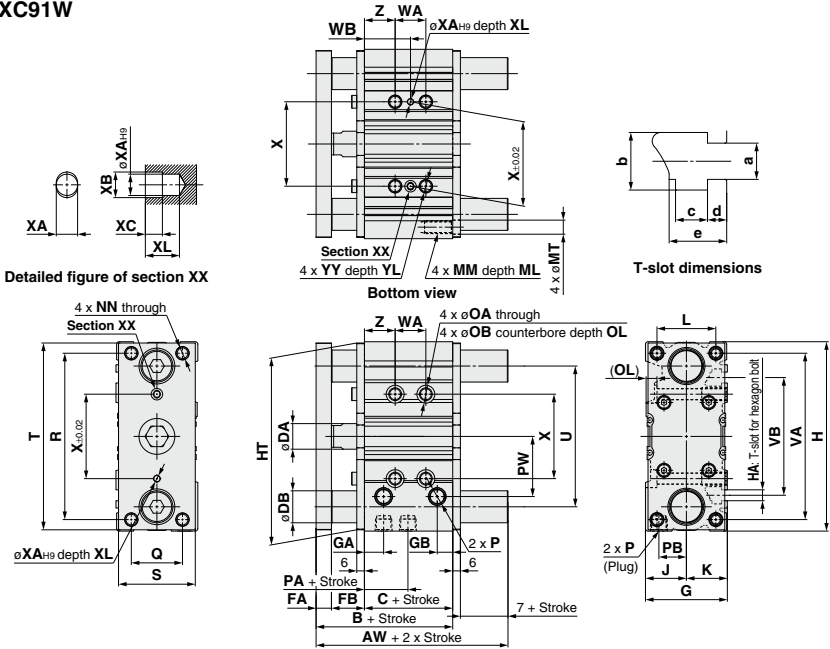

(mm)

Bore size	Standard stroke	AW	B	C	DA	DB	FA	FB	G	GA	GB	H	HA	HT	J	K	L	MM	ML	MT	NN
32	25, 50, 75, 100, 125, 150, 175, 200, 250, 300, 350, 400	82.5	69.5	37.5	14	20	10	22	48	12	9	112	M6	110	24	24	34	M8 x 1.25	20	9	M8 x 1.25
40		89	76	44	14	20	10	22	54	15	12	120	M6	118	27	27	40	M8 x 1.25	20	8.5	M8 x 1.25
50		95	82	44	20	25	12	26	64	15	12	148	M8	146	32	32	46	M10 x 1.5	22	11	M10 x 1.5
63		100	87	49	20	25	12	26	78	15.5	13.5	162	M10	160	39	39	58	M10 x 1.5	22	11	M10 x 1.5

Bore size	OA	OB	OL	P			PA	PB	PW	Q	R	S	T	U	VA	VB	WA				
				Nil	TN	TF											25 st or less	Over 25 st 100 st or less	Over 100 st 200 st or less	Over 200 st 300 st or less	Over 300 st
32	6.7	11	7.5	Rc1/8	NPT1/8	G1/8	6.5	16	35.5	30	96	44	110	78	98	63	24	48	124	200	300
40	6.7	11	7.5	Rc1/8	NPT1/8	G1/8	13	18	39.5	30	104	44	118	86	106	72	24	48	124	200	300
50	8.6	14	9	Rc1/4	NPT1/4	G1/4	9	21.5	47	40	130	60	146	110	130	92	24	48	124	200	300
63	8.6	—	9	Rc1/4	NPT1/4	G1/4	13	28	58	50	130	70	158	124	142	110	28	52	128	200	300

Bore size	WB					X	XA	XB	XC	XL	YY	YL	Z	a	b	c	d	e
	25 st or less	Over 25 st 100 st or less	Over 100 st 200 st or less	Over 200 st 300 st or less	Over 300 st													
32	33	45	83	121	171	42	4	4.5	3	6	M8 x 1.25	16	21	6.5	10.5	5.5	3.5	9.5
40	34	46	84	122	172	50	4	4.5	3	6	M8 x 1.25	16	22	6.5	10.5	5.5	4	11
50	36	48	86	124	174	66	5	6	4	8	M10 x 1.5	20	24	8.5	13.5	7.5	4.5	13.5
63	38	50	88	124	174	80	5	6	4	8	M10 x 1.5	20	24	11	17.8	10	7	18.5



Made to Order Common Specifications:

-XC88: Spatter Resistant Coil Scraper, Lube-retainer, Grease for Welding (Piston rod: Stainless steel 304)

-XC89: Spatter Resistant Coil Scraper, Lube-retainer, Grease for Welding (Piston rod: S45C)

-XC91: Spatter Resistant Coil Scraper, Grease for Welding (Piston rod: S45C)



62 Spatter Resistant Coil Scraper, Lube-retainer, Grease for Welding (Rod parts: Stainless steel 304) **-XC88**

63 Spatter Resistant Coil Scraper, Lube-retainer, Grease for Welding (Rod parts: S45C) **-XC89**

Reduces spatter adhesion and improves durability by the use of the coil scraper, Lube-retainer and grease for welding.

64 Spatter Resistant Coil Scraper, Grease for Welding (Rod parts: S45C) **-XC91**

With coil scraper and grease for welding

Bore Size

ø80, ø100

MGPM-XC91W

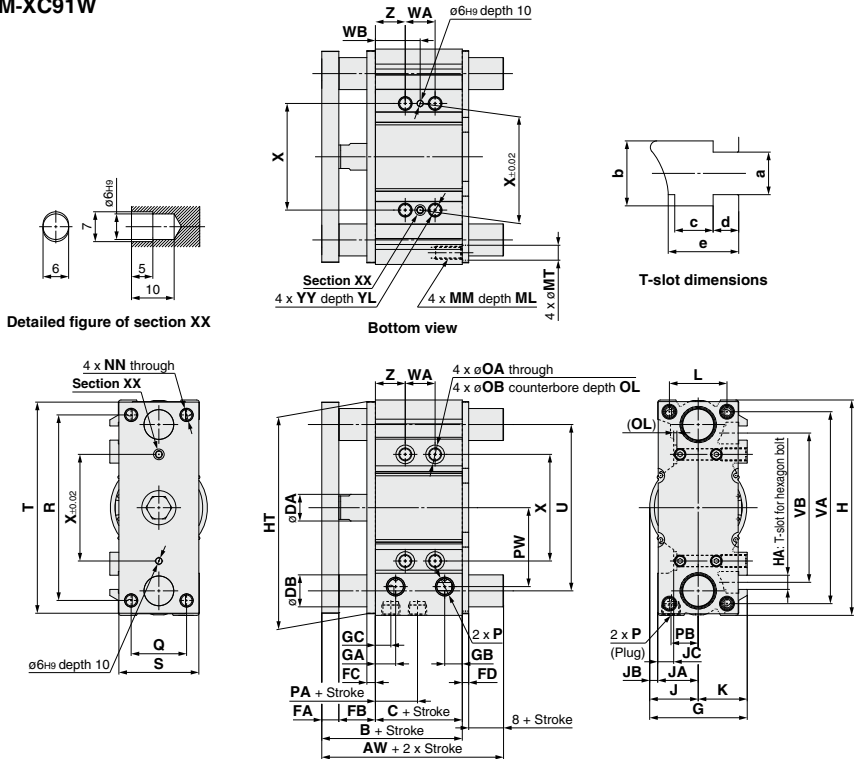

Bore size	Standard stroke					AW	B	C	DA	DB	FA	FB	FC	FD	G	GA	GB	GC	H	HA	HT	J	JA	JB	JC
80	25, 50, 75, 100, 125, 150, 175	120.5	106.5	56.5	25	30	16	34	8	6	91.5	19	16.5	14.5	202	M12	199	45.5	38	7.5	15				
100	200, 250, 300, 350, 400	143	126	66	30	36	19	41	9	9	111.5	22.5	20.5	18	240	M14	236	55.5	45	10.5	10				

Bore size	K	L	MM	ML	MT	NN	OA	OB	OL	P			PA	PB	PW	Q	R	S	T	U	VA
										Nil	TN	TF									
80	46	54	M12 x 1.75	25	14	M12 x 1.75	10.6	17.5	3	Rc3/8	NPT3/8	G3/8	14.5	25.5	74	52	174	75	198	156	180
100	56	62	M14 x 2	31	16	M14 x 2	12.5	20	8	Rc3/8	NPT3/8	G3/8	17.5	32.5	89	64	210	90	236	188	210

Bore size	VB	WA					WB					X	YY	YL	Z	a	b	c	d	e
		25 st or less	Over 25 st 100 st or less	Over 100 st 200 st or less	Over 200 st 300 st or less	Over 300 st	25 st or less	Over 25 st 100 st or less	Over 100 st 200 st or less	Over 200 st 300 st or less	Over 300 st									
80	140	28	52	128	200	300	42	54	92	128	178	100	M12 x 1.75	24	28	13.3	20.3	12	8	22.5
100	166	48	72	148	220	320	35	47	85	121	171	124	M14 x 2	28	11	15.3	23.3	13.5	10	30

Made to Order Common Specifications:
Spatter Resistant Coil Scraper, Lube-retainer, Grease for Welding (Piston rod: Stainless steel 304)
Spatter Resistant Coil Scraper, Lube-retainer, Grease for Welding (Piston rod: S45C)
Spatter Resistant Coil Scraper, Grease for Welding (Piston rod: S45C)

62	Spatter Resistant Coil Scraper, Lube-retainer, Grease for Welding (Piston rod: Stainless steel 304)	-XC88
63	Spatter Resistant Coil Scraper, Lube-retainer, Grease for Welding (Piston rod: S45C)	-XC89
Reduces spatter adhesion and improves durability by the use of the coil scraper, Lube-retainer and grease for welding.		
64	Spatter Resistant Coil Scraper, Grease for Welding (Piston rod: S45C)	-XC91

With coil scraper and grease for welding

MK2T Series

How to Order

MK2T B 32 - **10 R** - **M9BW** - **XC89**

MK2T B 32 - **10 R** - **M9BW** - **XC91**

Symbol

-XC88

-XC89

-XC91

Rotary clamp cylinder
Double guide type
(Built-in auto switch magnet)

Mounting bracket

B	Through-hole (Both ends tapped common) (Standard)
G	Head flange

Bore size

32	32 mm	50	50 mm
40	40 mm	63	63 mm

Cylinder port

Nil	Rc
TN	NPT
TF	G

Clamp stroke

	Clamp stroke	Rotary stroke	Applicable bore size
10	10 mm	29 mm	ø32, ø40
20	20 mm		
20	20 mm	33 mm	ø50, ø63
50	50 mm		

Number of auto switches

Nil	2 pcs.
S	1 pc.

Rod material

XC89	S45C
XC91	S45C

Auto switch

Nil	Without auto switch (Built-in magnet)
------------	---------------------------------------

* For applicable auto switches, refer to the table below.

Body option

Nil	Standard (Female thread)
N	With arm

* Arms are included when shipped, (but not assembled).

Rotary direction (Unclamp → Clamp)

R	Clockwise	L type	During unclamping (Extension end)
L	Counterclockwise	R type	During unclamping (Extension end)

* Direction of rotation viewed from the rod end when the rod is retracting.

R type
During unclamping (Extension end) 85° to 95° (90°±5°)

L type
During unclamping (Extension end) 85° to 95° (90°±5°)

Clamp part
Non-rotating accuracy ±0.5° to 1.0°
During clamping (Retraction end)

Made to Order

Part no.	Piston rod material (Hard chrome plating)	Coil scraper	Lube-retainer	Grease for welding
-XC89	S45C	●	●	●
-XC91		●	—	●

Note) Use the -XC91 in a place where the distance from the welding portion is far and the spatter scattering is minimized.

Applicable Auto Switches / Refer to pages 1755 to 1701 for further information on auto switches.

Type	Special function	Electrical entry	Indicator light	Wiring (Output)	Load voltage		Auto switch model		Lead wire length (m)				Pre-wired connector	Applicable load				
					DC	AC	Perpendicular	In-line	0.5 (Nil)	1 (M)	3 (L)	5 (Z)			None (N)			
Solid state auto switch	—	Grommet	Yes	3-wire (NPN)	24 V	—	M9NV	M9N	●	—	●	—	—	—	—	IC circuit		
				3-wire (PNP)					5 V, 12 V	●	—	●	—	—	—		—	
				2-wire					12 V	●	—	●	—	—	—		—	—
				3-wire (NPN)					5 V, 12 V	●	●	●	—	—	—		—	—
	3-wire (PNP)	5 V, 12 V	●	●	●	—	—	—	—	—								
	2-wire (Non-polar)	—	—	—	—	—	—	—	—	—	—							
	Reed auto switch	—	Grommet	Yes	3-wire (NPN equivalent)	—	—	A96V	A96	●	—	●	—	—	—	—	IC circuit	
2-wire					24 V	12 V	100 V	A93V	A93	●	●	●	●	—	—	—	Relay, PLC	
						5 V, 12 V	100 V or less	A90V	A90	●	—	●	—	—	—	—	IC circuit	

* Lead wire length symbols: 0.5 m..... Nil (Example) M9NW
 1 m..... M (Example) M9NWM
 3 m..... L (Example) M9NL
 5 m..... Z (Example) M9NZ

* Solid state auto switches marked with "○" are produced upon receipt of order.
 ** For D-P4DW, ø40 to ø63 are available.
 *** Only D-P4DW type is assembled at the time of shipment.

* Please contact SMC for auto switches, auto switch proper mounting positions and operating ranges other than the above.
 * For details about auto switches with pre-wired connector, refer to pages 1648 and 1649.
 * When D-M9□(V)/M9□W(V)/M9□A(V)/A9□(V) types are mounted on a side other than the port side, order auto switch mounting brackets separately. Refer to page 1684.
 * Auto switches are shipped together, (but not assembled).

Made to Order Common Specifications:

-XC88: Spatter Resistant Coil Scraper, Lube-retainer, Grease for Welding (Piston rod: Stainless steel 304)

-XC89: Spatter Resistant Coil Scraper, Lube-retainer, Grease for Welding (Piston rod: S45C)

-XC91: Spatter Resistant Coil Scraper, Grease for Welding (Piston rod: S45C)



62 Spatter Resistant Coil Scraper, Lube-retainer, Grease for Welding (Piston rod: Stainless steel 304)

63 Spatter Resistant Coil Scraper, Lube-retainer, Grease for Welding (Piston rod: S45C)

Reduces spatter adhesion and improves durability by the use of the coil scraper, Lube-retainer and grease for welding.

64 Spatter Resistant Coil Scraper, Grease for Welding (Piston rod: S45C)

With coil scraper and grease for welding

Specifications



Bore size (mm)	32	40	50	63
Action	Double acting			
Rotation angle <small>Note 1)</small>	90° ±5°			
Rotary direction <small>Note 2)</small>	Clockwise, Counterclockwise			
Rotary stroke (mm)	29		33	
Clamp stroke (mm)	10, 20		20, 50	
Theoretical clamp force (N) <small>Note 3)</small>	300	525	825	1300
Fluid	Air			
Proof pressure	1.5 MPa			
Operating pressure range	0.1 to 1 MPa			
Ambient and fluid temperature	Without auto switch: -10 to 70°C (No freezing) With auto switch: -10 to 60°C (No freezing)			
Lubrication	Non-Lube			
Piping port size	Rc1/8, NPT1/8, G1/8		Rc1/4, NPT1/4, G1/4	
Mounting	Through-hole/Both ends tapped common, Head end flange			
Cushion	Rubber bumper			
Stroke length tolerance	+1.0 0			
Piston speed	50 to 200 mm/s			
Non-rotating accuracy (Clamp part)	±0.5°			

Note 1) Refer to "Rotary Angle" figure in Best Pneumatics No.2-3.

Note 2) Direction of rotation viewed from the rod end when rod parts are retracting.

Note 3) At 0.5 MPa.

Theoretical Output

Unit: N

Bore size (mm)	Rod size (mm)	Operating direction	Piston area (cm ²)	Operating pressure (MPa)			
				0.3	0.5	0.7	1.0
32	16	R	6	182	300	418	600
		H	8	243	400	557	800
40	16	R	10.5	319	525	731	1050
		H	12.5	380	625	870	1250
50	20	R	16.5	502	825	1149	1648
		H	19.6	596	980	1365	1961
63	25	R	26	780	1300	1820	2600
		H	31.2	948	1560	2172	3121

Note) Theoretical output (N) = Pressure (MPa) x Piston area (cm²) x 100

Operating direction

R: Rod end (Clamp)

H: Head end (Unclamp)

Made to Order Common Specifications:
Spatter Resistant Coil Scraper, Lube-retainer, Grease for Welding (Piston rod: Stainless steel 304)
Spatter Resistant Coil Scraper, Lube-retainer, Grease for Welding (Piston rod: S45C)
Spatter Resistant Coil Scraper, Grease for Welding (Piston rod: S45C)

Symbol

-XC88

-XC89

-XC91

Bore Size

ø32 to ø63

Dimensions with mounting bracket are the same as standard type. For details, refer to Best Pneumatics No.2-3.

MK2T□-XC89

Through-hole/Both ends tapped (Standard): MK2TB

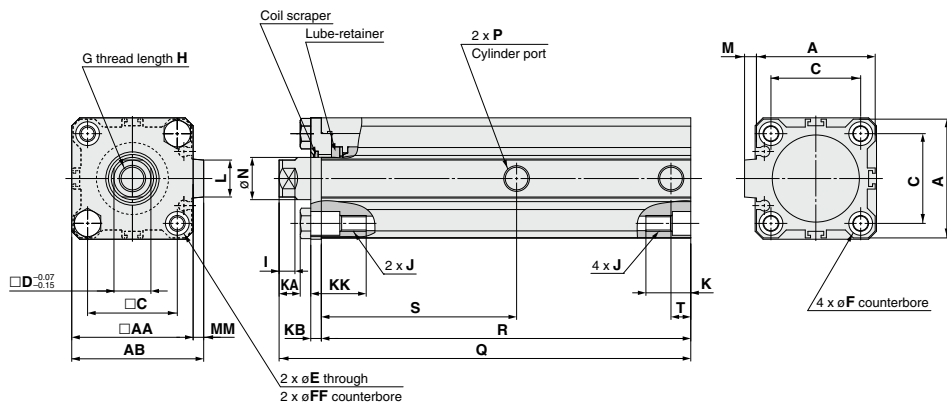

(mm)

Bore size	AA	AB	A	C	D	E	FF	F	G	H	I	J	KK	K	KA	KB	L	MM	M	øN	
32	46	50	45	34	14	$^{+0.07}$ $^{-0.15}$	5.5	9 depth 11	9 depth 7	M10 x 1.5	12	6	M6 x 1.0	21	17	8	4	14	4	4.5	16
40	52	57	52	40	14	$^{+0.07}$ $^{-0.15}$	5.5	9 depth 12	9 depth 7	M10 x 1.5	12	6	M6 x 1.0	22	17	7.5	5	14	5	5	16
50	64	71	64	50	17	$^{+0.07}$ $^{-0.15}$	6.6	11 depth 14	11 depth 8	M12 x 1.75	15	7	M8 x 1.25	28	22	12	6	19	7	7	20
63	77	84	77	60	22	$^{+0.07}$ $^{-0.15}$	9	14 depth 16.5	14 depth 10.5	M16 x 2	21	8	M10 x 1.5	34.5	28.5	10	6	19	7	7	25

Bore size	P			Clamp stroke: 10 mm				Clamp stroke: 20 mm				Clamp stroke: 50 mm			
	Nil	TN	TF	Q	R	S	T	Q	R	S	T	Q	R	S	T
32	Rc1/8	NPT1/8	G1/8	156	140	74	7.5	176	160	84	7.5	—	—	—	—
40	Rc1/8	NPT1/8	G1/8	160.5	144	75	8	180.5	164	85	8	—	—	—	—
50	Rc1/4	NPT1/4	G1/4	—	—	—	—	202.5	179	91.5	12.5	266	242.5	121.5	14
63	Rc1/4	NPT1/4	G1/4	—	—	—	—	205	182	93	10.5	269	246	123	15

Note 1) The cylinder rod is retracted.

Note 2) The overall length when the rod is extended is the value that the clamp stroke and rotary stroke are added to the dimension Q.

Made to Order Common Specifications:

- XC88: Spatter Resistant Coil Scraper, Lube-retainer, Grease for Welding (Piston rod: Stainless steel 304)
- XC89: Spatter Resistant Coil Scraper, Lube-retainer, Grease for Welding (Piston rod: S45C)
- XC91: Spatter Resistant Coil Scraper, Grease for Welding (Piston rod: S45C)



62 Spatter Resistant Coil Scraper, Lube-retainer, Grease for Welding (Piston rod: Stainless steel 304)

63 Spatter Resistant Coil Scraper, Lube-retainer, Grease for Welding (Piston rod: S45C)

Reduces spatter adhesion and improves durability by the use of the coil scraper, Lube-retainer and grease for welding.

64 Spatter Resistant Coil Scraper, Grease for Welding (Piston rod: S45C)

With coil scraper and grease for welding

Bore Size

ø32 to ø63

Dimensions with mounting bracket are the same as standard type. For details, refer to Best Pneumatics No.2-3.

MK2T□-XC91 * Dimensions are the same as the standard product (MK2T series).

Through-hole/Both ends tapped (Standard): MK2TB

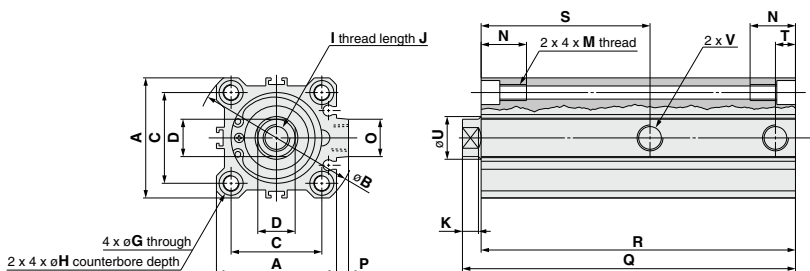

Through-hole/Both Ends Tapped Common (Standard)

(mm)

Bore size	A	øB	C	D	G	H	I	J	K	M	N	O	P	øU	V		
															NII	TN	TF
32	45	60	34	14 ^{-0.07} _{-0.15}	5.5	9 depth 7	M10 x 1.5	12	6	M6 x 1.0	17	14	4.5	16	Rc1/8	NPT1/8	G1/8
40	52	69	40	14 ^{-0.07} _{-0.15}	5.5	9 depth 7	M10 x 1.5	12	6	M6 x 1.0	17	14	5	16	Rc1/8	NPT1/8	G1/8
50	64	86	50	17 ^{-0.07} _{-0.15}	6.6	11 depth 8	M12 x 1.75	15	7	M8 x 1.25	22	19	7	20	Rc1/4	NPT1/4	G1/4
63	77	103	60	22 ^{-0.07} _{-0.15}	9	14 depth 10.5	M16 x 2	21	8	M10 x 1.5	28.5	19	7	25	Rc1/4	NPT1/4	G1/4

Bore size	Clamp stroke 10 mm				Clamp stroke 20 mm				Clamp stroke 50 mm			
	Q	R	S	T	Q	R	S	T	Q	R	S	T
32	148	140	74	7.5	168	160	84	7.5	—	—	—	—
40	151.5	144	75	8	171.5	164	85	8	—	—	—	—
50	—	—	—	—	191	179	91.5	12.5	254.5	242.5	121.5	14
63	—	—	—	—	192	182	93	10.5	256	246	123	15

Made to Order Common Specifications:
Spatter Resistant Coil Scraper, Lube-retainer, Grease for Welding (Piston rod: Stainless steel 304)
Spatter Resistant Coil Scraper, Lube-retainer, Grease for Welding (Piston rod: S45C)
Spatter Resistant Coil Scraper, Grease for Welding (Piston rod: S45C)

Symbol

-XC88

-XC89

-XC91

CKG1 Series: Rod Mounting Type How to Order

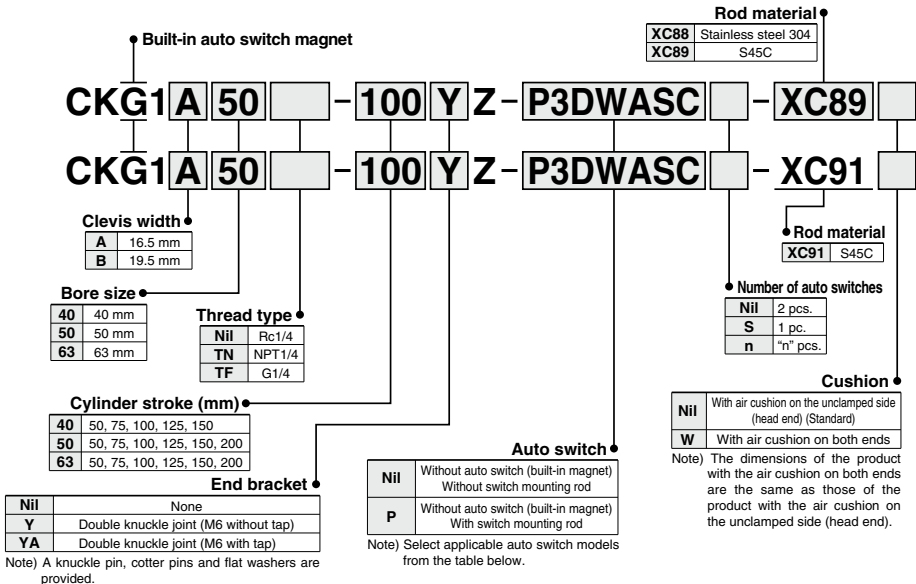

Made to Order

Part no.	Piston rod material (Hard chrome plated)		Coil scraper	Lube-retainer	Grease for welding
	S45C	Stainless steel 304			
-XC88	—	●	●	●	●
-XC89	●	—	●	●	●
-XC91	●	—	●	—	●

Note) Use the -XC91 in a place where the distance from the welding portion is far and the spatter scattering is minimized.

Built-in Auto Switch Magnet Cylinder Part No.

- 1) Built-in auto switch magnet type without auto switch, without switch mounting rod
Symbol for the auto switch type is "Nil" as shown below.
(Example) CKG1A50-50YZ-XC89
- 2) Built-in auto switch magnet type without auto switch, with switch mounting rod
Symbol for the auto switch type is "P" as shown below.
(Example) CKG1A50-50YZ-P-XC89

Applicable Auto Switches/Refer to pages 1575 to 1701 for further information on auto switches.

Type	Special function	Auto switch model	Applicable magnetic field	Electrical entry	Indicator light	Wiring (Pin no. in use)	Load voltage	Lead wire length	Applicable load	
Solid state auto switch	Magnetic field resistant (2-color indicator)	D-P3DWASC	AC magnetic field (Single-phase AC welding magnetic field)	Pre-wired connector	2-color display	2-wire (3-4)	24 VDC	0.3 m	Relay, PLC (Note 1)	
		D-P4DWASC								
		D-P3DWASE								
		D-P4DWSE								
		D-P3DWA				Grommet		2-wire		0.5 m
		D-P3DWAL								3 m
		D-P4DWL								5 m
		D-P3DWAZ								
D-P4DWZ										

Note 1) PLC: Programmable Logic Controller

Note 2) Please contact SMC for auto switches, auto switch proper mounting positions and operating ranges other than the above.

Note 3) Refer to page 1692 when ordering the auto switch mounting bracket assembly or switch mounting rod assembly.

Note 4) For the D-P3DWA□, the auto switch and auto switch mounting bracket are packed together, (but not assembled).



Made to Order Common Specifications:

-XC88: Spatter Resistant Coil Scraper, Lube-retainer, Grease for Welding (Piston rod: Stainless steel 304)

-XC89: Spatter Resistant Coil Scraper, Lube-retainer, Grease for Welding (Piston rod: S45C)

-XC91: Spatter Resistant Coil Scraper, Grease for Welding (Piston rod: S45C)



62 Spatter Resistant Coil Scraper, Lube-retainer, Grease for Welding (Piston rod: Stainless steel 304)

63 Spatter Resistant Coil Scraper, Lube-retainer, Grease for Welding (Piston rod: S45C)

Reduces spatter adhesion and improves durability by the use of the coil scraper, Lube-retainer and grease for welding.

64 Spatter Resistant Coil Scraper, Grease for Welding (Piston rod: S45C)

With coil scraper and grease for welding

CKG1 Series: Band Mounting Type How to Order

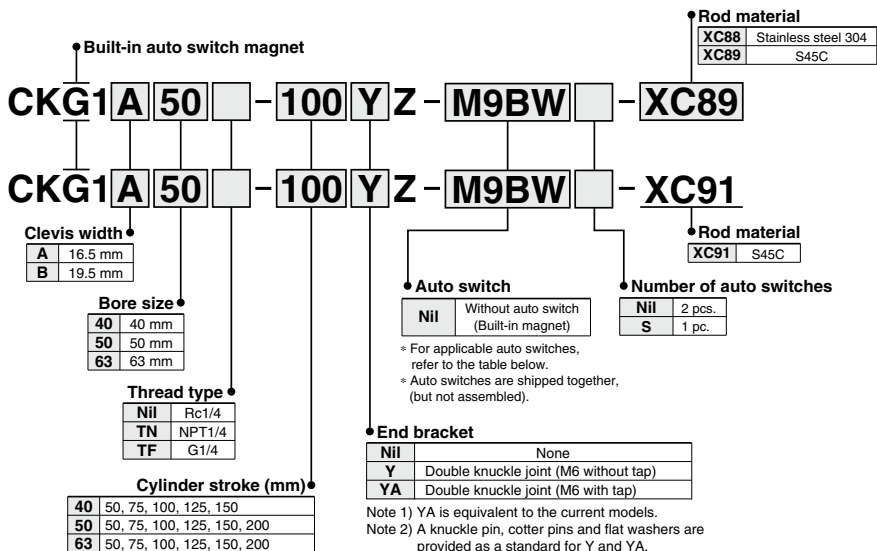

Made to Order

Part no.	Piston rod material (Hard chrome plated)		Coil scraper	Lube-retainer	Grease for welding
	S45C	Stainless steel 304			
-XC88	—	●	●	●	●
-XC89	●	—	●	●	●
-XC91	●	—	●	—	●

Note) Use the -XC91 in a place where the distance from the welding portion is far and the spatter scattering is minimized.

⚠ Caution

The standard auto switch cannot be used in a magnetic field environment. For information on our cylinders that can be fitted with a magnetic field resistant auto switch, refer to page 1889.

Standard Auto Switches (Refer to pages 1575 to 1701 for detailed auto switch specifications.)

Applicable cylinder series	Type	Electrical entry	Indicator light	Wiring (Output)	Load voltage		Auto switch model	Lead wire length (m)				Applicable load		
					DC	AC		Band mounting	0.5(Nil)	1(M)	3(L)		5(Z)	
CKG1	Solid state auto switch	Grommet	Yes	2-wire	24 V	5 V	—	M9B	●	●	●	○	—	Relay, PLC
						12 V		M9BW	●	●	●	○		
	Reed auto switch	Grommet	Yes	2-wire	24 V	12 V	A93	●	●	●	●			
						100 V	B54	●	—	●	●			
						200 V								

Note 1) Lead wire length symbol: 0.5 m..... Nil
1 m..... M
3 m..... L
5 m..... Z

Note 2) Auto switches marked with "O" are produced upon receipt of order.
Note 3) Refer to pages 1680 and 1681 when ordering the auto switch mounting bracket assembly.

Made to Order Common Specifications:
Spatter Resistant Coil Scraper, Lube-retainer, Grease for Welding (Piston rod: Stainless steel 304)
Spatter Resistant Coil Scraper, Lube-retainer, Grease for Welding (Piston rod: S45C)
Spatter Resistant Coil Scraper, Grease for Welding (Piston rod: S45C)

Symbol

-XC88

-XC89

-XC91



Specifications

Bore size (mm)	40	50	63
Fluid	Air		
Proof pressure	1.5 MPa		
Maximum operating pressure	1.0 MPa		
Minimum operating pressure	0.05 MPa		
Ambient and fluid temperature	-10°C to +60°C (No freezing)		
Piston speed	50 to 500 mm/s		
Cushion ^{Note 1)}	Unclamped side (head end): With air cushion		
Speed controller	Equipped on both ends		
Lubrication	Non-lube		
Stroke length tolerance	+1.0 0		
Mounting ^{Note 2)}	Double clevis		

Note 1) The model with air cushion on both ends (Symbol: W) is also available.
 Note 2) A clevis pin, cotter pins, flat washers are equipped as a standard.

Clevis width	16.5 mm	CKG1A
	19.5 mm	CKG1B

Standard Strokes

Bore size (mm)	Standard stroke (mm)
40	50, 75, 100, 125, 150
50, 63	50, 75, 100, 125, 150, 200

End Bracket/Options

Symbol	Description		Part no.	
			CKG1A series	CKG1B series
Y	Double knuckle joint (A knuckle pin, cotter pins, flat washers are equipped.)	M6 without tap	CKA-Y04	CKB-Y04
YA		M6 with tap	CKA-YA04	CKB-YA04

Weight (Basic weight includes the switch mounting rod. At 0 stroke)

Unit: kg

Bore size (mm)	40	50	63
Basic weight	0.76	0.98	1.18
Additional weight per 25 mm of stroke	0.11	0.12	0.14
Double knuckle joint (A knuckle pin, cotter pins, flat washers are equipped.)	0.34		

Calculation

Example) **CKG1□50-100YZ-P-XC88**

- Basic weight 1.03 (ø50)
- Additional weight 0.12/25 mm
- Cylinder stroke 100 mm
- Double knuckle joint 0.34 (Y)

$$1.03 + 0.12 \times 100/25 + 0.34 = 1.85 \text{ kg}$$

Theoretical Output

Unit: N

Bore size (mm)	Rod size (mm)	Operating direction	Piston area (mm ²)	Operating pressure (MPa)			
				0.3	0.4	0.5	0.6
40	20	OUT	1260	378	504	630	756
		IN	943	283	377	472	566
50	20	OUT	1960	588	784	980	1180
		IN	1650	495	660	825	990
63	20	OUT	3120	934	1250	1560	1870
		IN	2800	840	1120	1400	1680



Made to Order Common Specifications:

-XC88: Spatter Resistant Coil Scraper, Lube-retainer, Grease for Welding (Piston rod: Stainless steel 304)

-XC89: Spatter Resistant Coil Scraper, Lube-retainer, Grease for Welding (Piston rod: S45C)

-XC91: Spatter Resistant Coil Scraper, Grease for Welding (Piston rod: S45C)



62 Spatter Resistant Coil Scraper, Lube-retainer, Grease for Welding (Piston rod: Stainless steel 304) **-XC88**

63 Spatter Resistant Coil Scraper, Lube-retainer, Grease for Welding (Piston rod: S45C) **-XC89**

Reduces spatter adhesion and improves durability by the use of the coil scraper, Lube-retainer and grease for welding.

64 Spatter Resistant Coil Scraper, Grease for Welding (Piston rod: S45C) **-XC91**

With coil scraper and grease for welding

Bore Size

ø40 to ø63

CKG1□40, 50, 63-XC88□ With auto switch (D-P4DWS□)

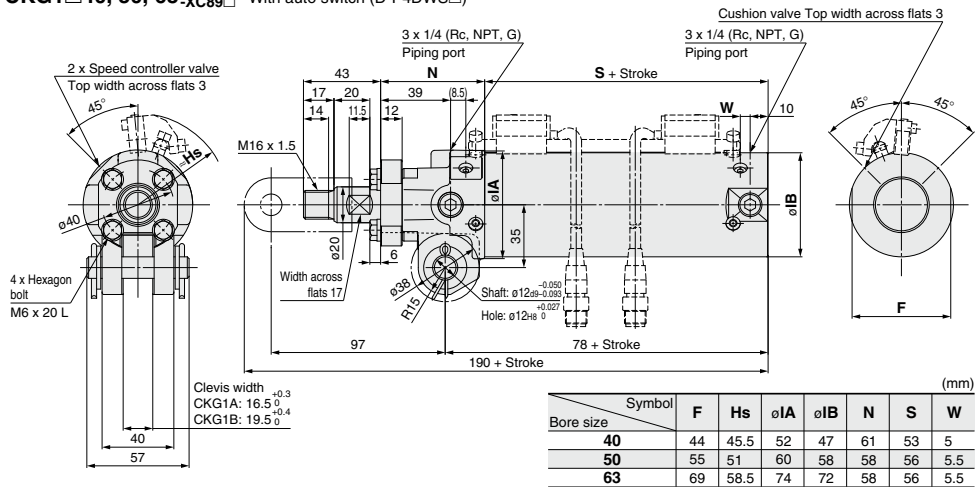

CKG1□40, 50, 63-XC91□ With auto switch (D-P4DWS□)

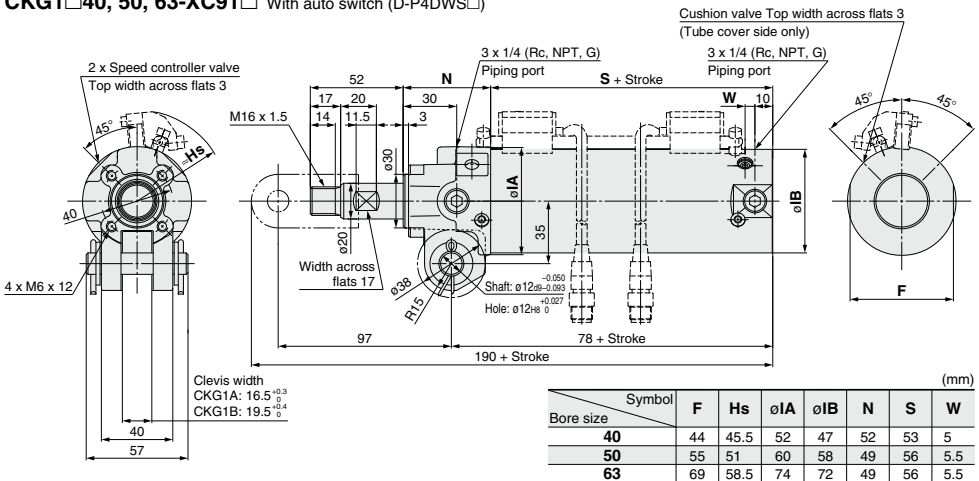

Made to Order Common Specifications: -XC92: Dust Resistant Actuator



65 Dust Resistant Actuator

Symbol
-XC92

Applicable for environments with flying micro-powder (20 to 30 µm or less) such as ceramic powder, toner powder, paper powder, and metallic powder (except weld spatter). 4 times stronger than the standard model

Applicable series

Series	Description/Type	Model	Action	Remark (s)	Vol. No. (for std model)
CM2	Air Cylinder	CM2	Double acting, Single rod	Compatible with cylinders with rubber bumper	②-1 P. 172
CQS	Compact Cylinder	CQS	Double acting, Single rod		②-1 P. 693
CQ2	Compact Cylinder	CQ2-Z	Double acting, Single rod	Applicable to ø32 to ø100.	②-1 P. 773
MGP	Compact Guide Cylinder	MGP	Double acting, Single rod		②-2 P. 432

How to Order

C(D)M2 [Mounting bracket] [Bore size] - [Stroke] - [Auto switch] [Suffix] - **XC92**
 * Auto switch is applicable for CDM2 only. Dust resistant actuator

Bore size (mm)	Standard stroke	Minimum operating pressure
20	25, 50, 75, 100, 125, 150, 200, 250, 300	0.1 MPa
25		
32		
40		

C(D)QS [Mounting bracket] [Bore size] - [Stroke] **D** [Body option] - [Auto switch] [Suffix] - **XC92**
 * Auto switch is applicable for CDQS only.
 * Body option with rear slip fit is not available. Dust resistant actuator

Bore size (mm)	Standard stroke	Minimum operating pressure
12, 16	5, 10, 15, 20, 25, 30	0.14 MPa
20, 25	5, 10, 15, 20, 25, 30, 35, 40, 45, 50	0.1 MPa

C(D)Q2 [Mounting bracket] [Bore size] - [Stroke] **D** [Body option] **Z** - [Auto switch] [Suffix] - **XC92**
 * Auto switch is applicable for CDQ2 only.
 * Body option with rear slip fit is not available. Dust resistant actuator

Bore size (mm)	Standard stroke	Minimum operating pressure
32, 40	5, 10, 15, 20, 25, 30, 35, 40, 45, 50, 75, 100	0.1 MPa
50 to 100	10, 15, 20, 25, 30, 35, 40, 45, 50, 75, 100	0.1 MPa

MGPM [Bore size] - [Stroke] - [Auto switch] [Suffix] - **XC92**
 Dust resistant actuator

Bore size (mm)	Standard stroke
12, 16	10, 20, 30, 40, 50, 75, 100
20, 25	20, 30, 40, 50, 75, 100, 125, 150, 175, 200
32 to 100	25, 50, 75, 100, 125, 150, 175, 200

Symbol	Type	Drive unit	Guide unit	
			Rod side	Head end
Nil	With lube-retainers on one side	○	○	—
W	With lube-retainers on both sides	○	○	○

XC92	Bore size		Minimum operating pressure
	ø12, ø16	ø20 to ø100	
			0.2 MPa
			0.15 MPa
XC92W	Bore size		Minimum operating pressure
	ø12, ø16	ø20 to ø100	
			0.25 MPa
			0.2 MPa

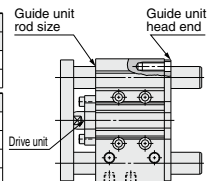

Specifications other than minimum operating pressure are the same as standard model.

Made to Order Common Specifications: -XC92: Dust Resistant Actuator



65 Dust Resistant Actuator

Dimensions (Other dimensions are the same as the standard type.)

CM2 series: The same as the standard type CQS series

6 x ϕ OB counterbore
4 locations on the
back side

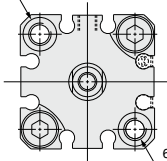

6 x OA effective
depth RA (Note 1)
4 locations on the
back side (Note 4)

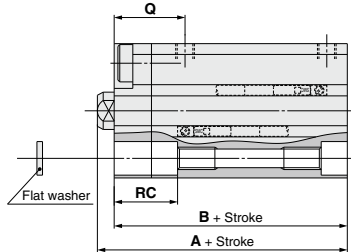

Note 1) For the standard type ϕ 12 and ϕ 16 with 5 strokes, ϕ 20 with 15 strokes or less, and ϕ 25 with 5 or 10 strokes, and for models with an auto switch and built-in magnet of ϕ 20 with 5 strokes, the through-hole is threaded over the entire length.

Note 2) Be sure to use the attached flat washer for mounting cylinder with through-holes.

Note 3) For models with a rubber bumper, the stroke tolerance does not include bumper deflection.

Note 4) 2 locations on the back side for the standard-type ϕ 20 with 15 strokes or less and ϕ 25 with 10 strokes, and for models with an auto switch and built-in magnet of ϕ 20 with 5 strokes.

Bore size (mm)	A		B		Q	OA	OB	RA	RC
	Without auto switch	With auto switch	Without auto switch	With auto switch					
12	30.5	35.5	27	32	17.5	M4 x 0.7	6.5	7	14
16	30.5	35.5	27	32	17.5	M4 x 0.7	6.5	7	14
20	34	44	29.5	39.5	19	M6 x 1.0	9	10	17
25	37.5	47.5	32.5	42.5	21	M6 x 1.0	9	10	17

CQ2 series

2 x ϕ 5.5 through
2 x 2 x ϕ 9 counterbore depth 17
(Bottom side counterbore depth 7)

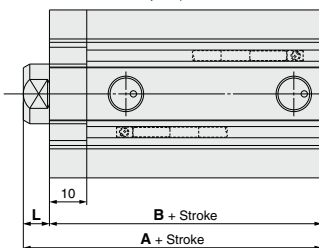
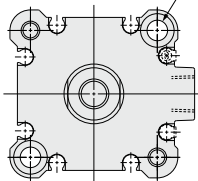

ϕ 32

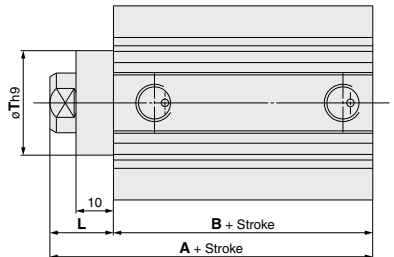

ϕ 40 to ϕ 100

Bore size (mm)	A		B		T	
	Without auto switch	With auto switch	Without auto switch	With auto switch	L	T
32	40 (50)	50	33 (43)	43	7	—
40	46.5 (56.5)	56.5	29.5 (39.5)	39.5	17	28
50	48.5 (58.5)	58.5	30.5 (40.5)	40.5	18	35
63	54 (64)	64	36 (46)	46	18	35
80	63.5 (73.5)	73.5	43.5 (53.5)	53.5	20	43
100	75 (85)	85	53 (63)	63	22	59

Note 1) For cylinders with rubber bumper, stroke tolerance does not include the amount of bumper change.

Note 2) Dimensions inside () are for 75, 100st.

Dimensions (Other dimensions are the same as the standard type.)

MGP series

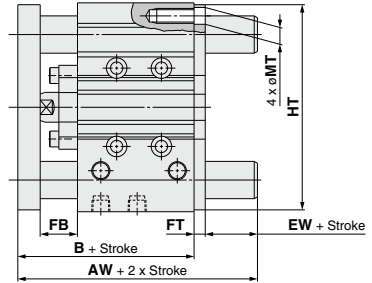
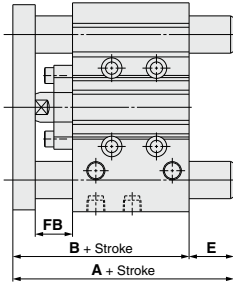

With Lube-retainers on one side (mm)

Bore size (mm)	A		B	E		FB
	50 st or less	Over 50 st and 200 st or less*		50 st or less	Over 50 st and 200 st or less*	
12	52	70.5	52	0	18.5	15
16	56	74.5	56	0	18.5	15
20	63	94.5	63	0	31.5	16
25	63.5	95	63.5	0	31.5	16
32	97	112	69.5	27.5	42.5	20
40	97	112	76	21	36	20
50	106.5	128	82	24.5	46	22
63	106.5	128	87	19.5	41	22
80	125	152	106.5	18.5	45.5	28
100	147	172	126	21	46	35

* The standard stroke for ø12 and ø16 is 100 st.

With Lube-retainers on both sides (mm)

Bore size (mm)	AW	B	EW	FB	FT	MT	HT
12	63	52	6	15	5	5	57
16	67	56	6	15	5	6	64
20	74	63	6	16	5	6	80
25	74.5	63.5	6	16	5	7	92
32	82.5	69.5	7	20	6	8.5	110
40	89	76	7	20	6	8.5	118
50	95	82	7	22	6	11	146
63	100	87	7	22	6	11	160
80	120.5	106.5	8	28	6	14	200
100	143	126	8	35	9	16	238



Made to Order Common Specifications: -XC93□: With Greater Water Resistance + Stable Lubrication Function



66 With Greater Water Resistance + Stable Lubrication Function

Symbol
-XC93

- 5 times stronger against water (liquids) than the standard model
- Equipped with the greater water resistant scraper (Fluororubber). The Lube-retainer creates grease coating around the piston rod, which improves lubrication.
- Stainless steel can be selected for the piston rod and rod end nut.

Applicable Series

Series	Description	Model	Action	Note	Vol. no. (for std model)
RHC	High power cylinder	RHC	Double acting, Single rod	Applicable bore size: ø32, ø40 Rc port only	②-3 From P. 351

How to Order

Standard model no.

-XC93 □

With greater water resistance + stable lubrication function

● Piston rod,
Rod end nut material

NII	Standard (Carbon steel)
S	Stainless steel

Dimensions (Dimensions other than below are the same as standard type.)

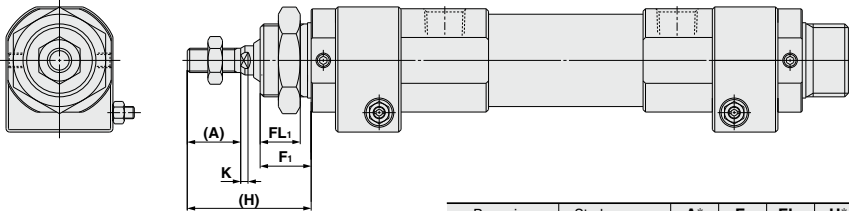

Bore size	Stroke range	A*	F ₁	FL ₁	H*	K	(mm)
32	Up to 1000	22	21	16.5	51	3	
40	Up to 1000	24	22.5	18	54.5	3	

*: Same as the standard model.