

Smooth/Low Speed Cylinders

C□Y/C□X Series

Reducing stick-slip in a low speed range

Smooth Cylinders C□Y Series

Stable operation possible even at

a low speed of **5 mm/s** (Measurement based on JIS B 8377)

Low sliding possible even in bi-directional operation

Can be operated regardless of the direction of pressure.

Interchangeable with the standard models

(CJ2Y, CM2Y, MBY, CA2Y, CS2Y)

Lightweight/Improved functions

(New structure equivalent to the standard models)

- Better visibility for auto switches (only when the D-M9□/A9□ are used in the CJ2Y, CM2Y, CG1Y)
- Female rod end available as standard (CG1Y, CM2Y, CQSY, CQ2Y)

CJ2Y
(ø10, ø16)



CM2Y
(ø20 to ø40)



CG1Y
(ø20 to ø100)



MBY
(ø32 to ø100)



CA2Y
(ø40 to ø100)



CS2Y
(ø125 to ø160)

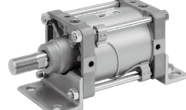

CQSY
(ø12 to ø25)



CQ2Y
(ø32 to ø100)



Reducing adhesion/quick extension

Low Speed Cylinders C□X Series

Smooth operation possible even at **0.5 mm/s**

(1 mm/s for ø16 or smaller)

Minimum operating pressure is reduced in half.

(Compared to previous version)

The new structure has improved low friction characteristics. (CM2X, CQSX, CQ2X)

Interchangeable with the standard models

Improved functions

(New structure equivalent to the standard models)

- Better visibility for auto switches (only when the D-M9□/A9□ are used in the CJ2X, CM2X)
- Female rod end available as standard (CM2X, CQSX, CQ2X)

CJ2X
(ø10, ø16)



CM2X
(ø20 to ø40)



CQSX
(ø12 to ø25)



CQ2X
(ø32 to ø100)

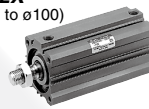

CUX
(ø10 to ø32)



Clean room specification
10/-11- Series



Low-Speed Rotary Actuators

* Refer to the Best Pneumatics No. 3 for details.

Low-speed compact rotary actuator
CRQ2X Series



Low-speed rotary table
MSQX Series



REA

REB

REC

Smooth

Low Speed

MQ

RHC

RZQ

D-□

-X□

Smooth/Low Speed Cylinders

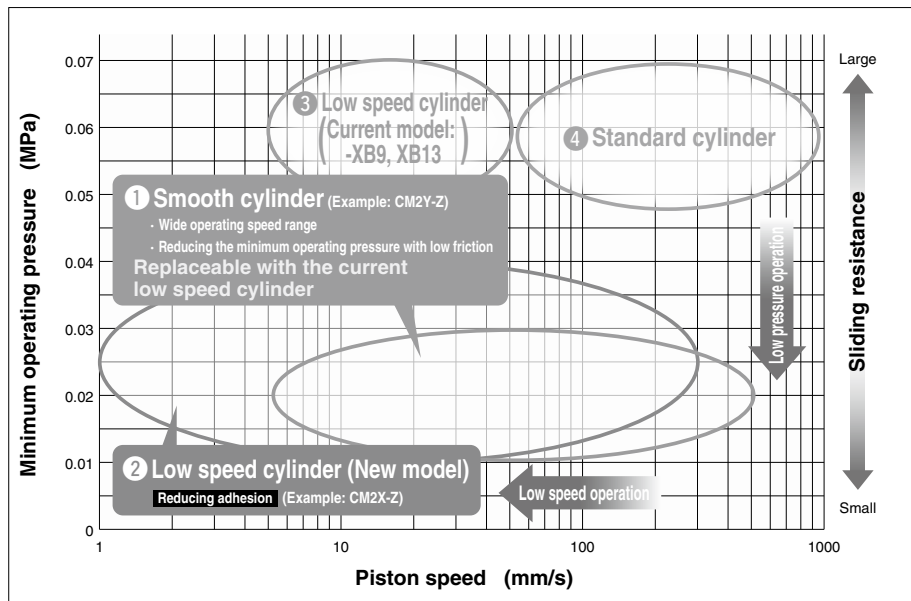

1 Smooth cylinder

- Low speed operation (from 5 mm/s)
- Low pressure operation
- Pressure on both sides

- Pressing force control
- Balance control of winders etc.
- General low-speed operating applications
- Tension control

2 Low speed cylinder (New model)

- Low speed operation (from 0.5 mm/s)
- Low pressure operation
- Pressure on both sides
- Reducing adhesion

- Load transfer without a lateral load (Lightweight trays etc.)
- Transfer with less adhesion (Wafers etc.)
- Higher-accuracy pressing force control

3 Low speed cylinder (Current model: -XB9, XB13)

- Low speed operation

4 Standard non-lube cylinder

- General applications

Function	1 Smooth cylinder	2 Low speed cylinder (New model)	3 Low speed cylinder (Current model: -XB9, XB13)	4 Standard non-lube cylinder
1 Low pressure operation	⊙	CUX10: x Others: ⊙	△	△
2 Low speed operation	○	⊙	○	△
3 Reducing adhesion	○	⊙	○	△
4 Reducing quick extension	○	⊙	○	△
5 Pressing force control	⊙	CUX10: x Others: ⊙	○	△
6 Low sliding	⊙	⊙	○	△

⊙: Excellent ○: Good △: Usable x: Handle with caution.

■ Selection Procedures (Reference Example)

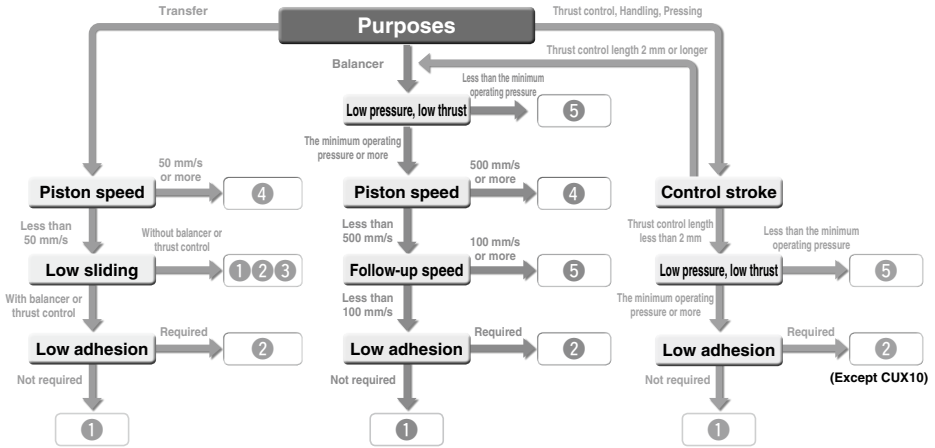

- ① Consider using the smooth cylinder.
- ② Consider using the low speed cylinder (New model).
- ③ Consider using the low speed cylinder (Current model: -XB9, XB13).
- ④ Consider using the standard non-lube cylinder.
- ⑤ Please consult with SMC.

■ Glossary Explanation

Average piston speed	Cylinder full stroke (length) divided by air pressure operating time.
Adhesive phenomenon	Quick extension or delay occurs when cylinders are not operated for long hours.
Thrust control	Control the pressing force by controlling air pressure in the cylinder.
Balancer	Cylinders move along with the moving workpiece.
Balancer follow-up speed	The speed of an air cylinder moving along with the workpiece at a small stroke.
Calculating thrust controlled	Calculate the cylinder thrust multiplying piston area by pressure. Piston area varies depending on models and bore sizes.

■ Applicable Model/Bore Size

Type	① Smooth cylinder	② Low speed cylinder (New model)	③ Low speed cylinder (Current model: -XB9, XB13)	Representative model
Small	●	●	●	CJ2
Round	●	●	●	CM2
	●	●	●	CG1
Tie-rod	●	●	●	MB
	●	●	●	CA2
Compact	●	●	●	CS2
	●	●	●	CQS
Free mount	●	●	●	CQ2

○: Standard

Bore size (mm)	① Smooth cylinder						② Low speed cylinder (New model)						
	Round	Tie-rod	Compact	Round	Compact	Free mount	Round	Compact	Free mount	Free mount			
Model	CJ2Y	CM2Y	CG1Y	CA2Y	CS2Y	MBY	CQSY	CQ2Y	CJ2X	CM2X	CQSX	CQ2X	CUX
ø10	●								●				●
ø12							●				●		
ø16	●						●				●		●
ø20		●	●						●		●		●
ø25		●	●						●		●		●
ø32		●	●						●		●		●
ø40		●	●	●					●		●		●
ø50			●	●									●
ø63			●	●									●
ø80			●	●									●
ø100			●	●									●
ø125				●									
ø140				●									
ø160				●									
	P. 141	P. 155	P. 172	P. 198	P. 212	P. 183	P. 225	P. 233	P. 251	P. 265	P. 285	P. 294	P. 309

- REA
- REB
- REC
- Smooth
- Low Speed
- MQ
- RHC
- RZQ

- D-□
- X□

Added compact foot brackets.

- Compact foot bracket has the same width as the cylinder. Overall width reduced by up to **43%** (ø12)

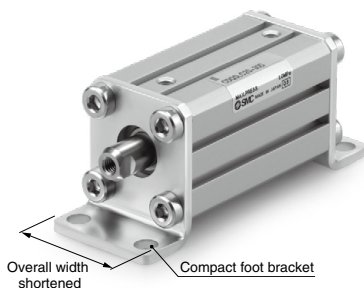

- More compact installation space possible

- Short pitch mounting is possible.
- Allows installation close against a wall.

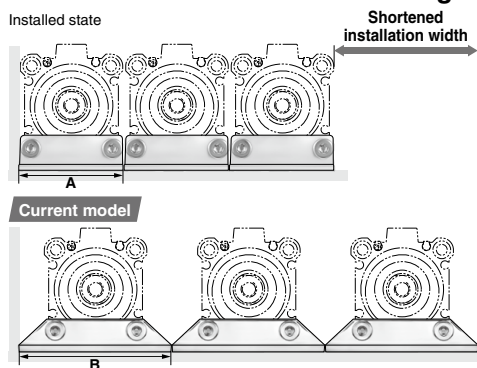

Bore size (mm)	Compact foot type width A (mm)	Current foot type width B (mm)	Reduced width for short pitch mounting (mm)		
			1 unit	2 units	3 units
12	25	44	19	38	57
16	29	48	19	38	57
20	36	62	26	52	78
25	40	66	26	52	78
32	45	71	26	52	78
40	52	78	26	52	78
50	64	95	31	62	93
63	77	113	36	72	108
80	98	140	42	84	126
100	117	162	45	90	135

* Short pitch mounting is possible only without auto switch. Please consult with SMC for mounting with auto switch.

- Height from the bottom of brackets to the center of a cylinder is the same as the current model.

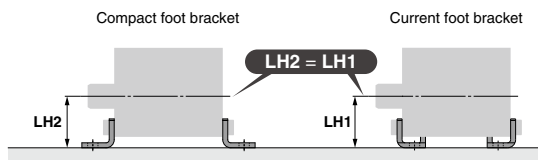

Applicable Cylinders: CQSY (P. 225), CQ2Y (P. 233) (Smooth Cylinders), CQSX (P. 285), CQ2X (P. 294) (Low Speed Cylinders)

Part numbers with rod end bracket and/or pivot bracket available

Not necessary to order a bracket for the applicable cylinder separately

Note) Mounting bracket is shipped together with the product, but not assembled.

For CM2Y

Example) CDM2Y **C** 20-50Z- **N** **W** -M9BW

● Mounting

Pivot bracket

Nil	None
N	Pivot bracket is shipped together with the product, but not assembled.

* Applicable to only mounting C, T, U, E, V, and UZ.

Kit of pivot bracket and single clevis



Kit of pivot bracket and trunnion



Rod end bracket

Nil	None
V	Single knuckle joint
W	Double knuckle joint

With rod end bracket

V: Single knuckle joint **W**: Double knuckle joint



For CA2Y

Example) CDA2Y **D** 40-100Z- **N** **W** -M9BW

● Mounting

Pivot bracket

Nil	None
N	Pivot bracket is shipped together with the product, but not assembled.

* Applicable to only mounting D (Double clevis) and T (Center trunnion).

Kit of pivot bracket and double clevis



Kit of pivot bracket and trunnion

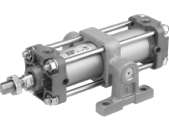

Rod end bracket

Nil	None
V	Single knuckle joint
W	Double knuckle joint

With rod end bracket

V: Single knuckle joint **W**: Double knuckle joint

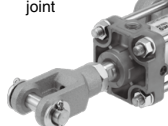
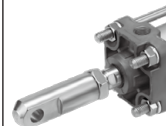

Applicable Cylinders: CJ2Y (P. 141), CM2Y (P. 155), CG1Y (P. 172), CA2Y (P. 198), MBY (P. 183) (Smooth Cylinders)

Smooth Cylinders

CJ2Y/CM2Y/CG1Y/MBY/ CA2Y/CS2Y/CQSY/CQ2Y Series

Series	Action	Bore size (mm)	Minimum operating pressure (MPa)	Page
CJ2Y 	Double acting	10, 16	0.03	141
CM2Y 		20, 25, 32, 40	0.02	155
CG1Y 		20, 25, 32, 40	0.02	172
		50, 63, 80, 100	0.01	
MBY 		32, 40	0.02	183
		50, 63, 80, 100	0.01	
CA2Y 		40	0.02	198
		50, 63, 80, 100	0.01	
CS2Y 		125, 140, 160	0.005	212
CQSY 		12, 16	0.03	225
	20, 25	0.02		
CQ2Y 	32, 40	0.02	233	
	50, 63, 80, 100	0.01		

Smooth Cylinder

Double Acting, Single Rod

CJ2Y Series

ø10, ø16



How to Order

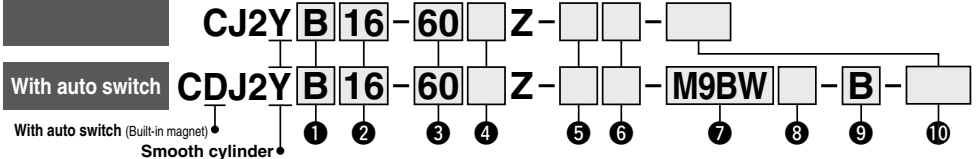

With auto switch
CDJ2Y B 16 - 60 [] Z - [] [] - M9BW [] - B - []

1 Mounting

B	Basic
E	Double-side bossed
D	Double clevis
L	Single foot
M	Double foot
F	Rod flange
G	Head flange

* Foot/Flange brackets are shipped together with the product, but not assembled.

6 Rod end bracket

Nil	None
V	Single knuckle joint
W**	Double knuckle joint
T	Rod end cap (Flat type)
U	Rod end cap (Round type)

* Rod end bracket is shipped together with the product, but not assembled.
* A knuckle joint pin is not provided with the single knuckle joint.
** Refer to page 148 for the double knuckle joint (with one-touch connecting pin).

2 Bore size

10	10 mm
16	16 mm

3 Cylinder standard stroke (mm)

Refer to "Standard Strokes" on page 142.

4 Head cover port location

Nil	Perpendicular to axis	
R	Axial	

* For double clevis, the product is perpendicular to the cylinder axis.
* For double-side bossed, the product is perpendicular to the cylinder axis.

5 Pivot bracket

Nil	None
N	Pivot bracket is shipped together with the product.

* Only for CJ2D (double clevis)
* Pivot bracket is shipped together with the product, but not assembled.

7 Auto switch

Nil	Without auto switch
-----	---------------------

* For applicable auto switches, refer to the table below.

9 Auto switch mounting type

A	Rail mounting
B	Band mounting

* For rail mounting, screws and nuts for 2 auto switches come with the rail.
* Refer to page 153 for auto switch mounting brackets.

8 Number of auto switches

Nil	2 pcs.
S	1 pc.
n	"n" pcs.

10 Made to Order

Refer to page 142 for details.

* Refer to "Ordering Example of Cylinder Assembly" on page 142.

Applicable Auto Switches/Refer to pages 941 to 1067 for further information on auto switches.

Type	Special function	Electrical entry	Indicator light	Wiring (Output)	Load voltage		Auto switch model				Lead wire length (m)				Pre-wired connector	Applicable load			
					DC	AC	Band mounting		Rail mounting		0.5 (Nil)	1 (M)	3 (L)	5 (Z)			None (N)		
							Perpendicular	In-line	Perpendicular	In-line									
Solid state auto switch	—	Grommet	—	3-wire (NPN)	5 V, 12 V	—	M9NV	M9N	M9NV	M9N	●	●	○	—	○	IC circuit			
				3-wire (PNP)			M9PV	M9P	M9PV	M9P	●	●	○	—	○				
		Connector	2-wire	12 V	—	M9BV	M9B	M9BV	M9B	●	●	○	—	○					
		—	—	—	H7C	J79C	—	●	—	●	—	●	—	—					
	Diagnostic indication (2-color indicator)	Grommet	Yes	—	3-wire (NPN)	5 V, 12 V	—	M9NWV	M9NW	M9NWV	M9NW	●	●	○	—	○	IC circuit		
					3-wire (PNP)			M9PWV	M9PW	M9PWV	M9PW	●	●	○	—	○			
	Water resistant (2-color indicator)	Grommet	—	—	2-wire	12 V	—	M9BWV	M9BW	M9BWV	M9BW	●	●	○	—	○	—		
					3-wire (NPN)			M9NAV ^{*1}	M9NA ^{*1}	M9NAV ^{*1}	M9NA ^{*1}	○	○	●	○	○		○	
	With diagnostic output (2-color indicator)	Grommet	—	—	3-wire (PNP)	5 V, 12 V	—	M9PAV ^{*1}	M9PA ^{*1}	M9PAV ^{*1}	M9PA ^{*1}	○	○	●	○	○	IC circuit		
					2-wire			M9BAV ^{*1}	M9BA ^{*1}	M9BAV ^{*1}	M9BA ^{*1}	○	○	●	○	○			
Reed auto switch	—	Grommet	Yes	3-wire (NPN equivalent)	—	—	A96V	A96	A96V	A96	●	—	●	—	—	IC circuit			
							—	200 V	—	A72	A72H	●	—	●	—		—		
							—	100 V	A93V ^{*2}	A93	A93V ^{*2}	A93	●	●	●		—	—	
							—	100 V or less	A90V	A90	A90V	A90	●	—	●		—	—	
		Grommet	No	—	—	2-wire	24 V	12 V	—	C73C	A73C	—	●	—	●	●	—	IC circuit	
									—	C80C	A80C	—	●	—	●	●	—		
									—	24 V or less	—	A79W	—	●	—	●	—		—
									—	—	—	—	—	●	—	●	—		—

*1 Water resistant type auto switches can be mounted on the above models, but in such case SMC cannot guarantee water resistance. Please consult with SMC regarding water resistant types with the above model numbers.
*2 1 m type lead wire is only applicable to D-A93.
* Lead wire length symbols: 0.5 m Nil (Example) M9NW 1 m M (Example) M9NWM 3 m L (Example) M9NWL 5 m Z (Example) M9NWZ None N (Example) H7CN

* Since there are other applicable auto switches than listed above, refer to page 154 for details.
* Solid state auto switches marked with "C" are produced upon receipt of order.
* The D-A90/M90/A70/A80/C70/J70 auto switches are shipped together, but not assembled. (For band mounting, only the auto switch mounting brackets are assembled before shipment.)



- REA
- REB
- REC
- Smooth
- Low Speed
- MQ
- RHC
- RZQ



CJ2Y Series



Symbol

Rubber bumper

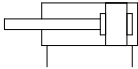

Made to Order
[Click here for details](#)

Symbol	Specifications
-XA□	Change of rod end shape
-XC3	Special port location
-XC9	Adjustable stroke cylinder/Adjustable retraction type

Mounting Brackets/Part No.

Mounting bracket	Bore size (mm)	
	10	16
Foot	CJ-L010C	CJ-L016C
Flange	CJ-F010C	CJ-F016C
T-bracket*	CJ-T010C	CJ-T016C

* A T-bracket is used with double clevis (D).

Specifications

Bore size (mm)		10	16
Action	Double acting, Single rod		
Fluid	Air		
Proof pressure	1.05 MPa		
Maximum operating pressure	0.7 MPa		
Ambient and fluid temperature	Without auto switch: -10°C to 70°C With auto switch: -10°C to 60°C (No freezing)		
Cushion	Rubber bumper (Standard equipment)		
Lubrication	Not required (Non-lube)		
Stroke length tolerance	+1.0 0		
Piston speed	5 to 500 mm/s		
Allowable kinetic energy	ø10	0.035 J	
	ø16	0.090 J	

Minimum Operating Pressure

Unit: MPa

Bore size (mm)		10	16
Minimum operating pressure	0.03		

Standard Strokes

Bore size (mm)	Standard stroke (mm)	Maximum manufacturable stroke (mm)
10	15, 30, 45, 60, 75, 100, 125, 150	400
16	15, 30, 45, 60, 75, 100, 125, 150, 175, 200	400

Note 1) Manufacture of intermediate strokes at 1 mm intervals is possible. (Spacers are not used.)
 Note 2) Applicable strokes should be confirmed according to the usage. For details, refer to "Air Cylinders Model Selection" on front matter pages of the Best Pneumatics No. 2-1. In addition, the products that exceed the standard stroke might not be able to fulfill the specifications due to the deflection etc.

Mounting and Accessories/For details about accessories, refer to page 148.

●--Mounted on the product. ○--Please order these separately. △--Order separately.

Mounting		Basic	Foot	Flange	Double*1 clevis
Standard	Mounting nut	●	●	●	—
	Rod end nut	●	●	●	●
	Clevis pin	—	—	—	●
Option	Single knuckle joint	○	○	○	○
	Double knuckle joint*1	○	○	○	○
	Double knuckle joint (With one-touch connecting pin)	△	△	△	△
	Rod end cap (Flat/Round type)	○	○	○	○
	T-bracket	—	—	—	○

*1 A pin and retaining rings are included with double clevis and/or double knuckle joint.

*2 Stainless steel mounting brackets and accessories are also available. Refer to page 148-1 for details.

Ordering Example of Cylinder Assembly

Cylinder model: CDJ2YD16-60Z-NW-M9BW-B

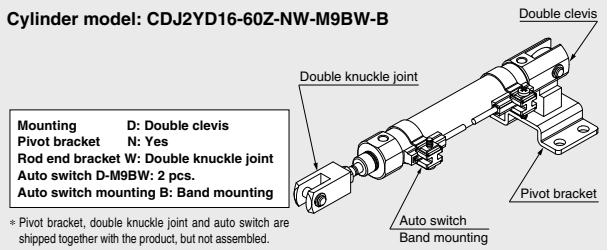

Mounting D: Double clevis
Pivot bracket N: Yes
Rod end bracket W: Double knuckle joint
Auto switch D-M9BW: 2 pcs.
Auto switch mounting B: Band mounting

* Pivot bracket, double knuckle joint and auto switch are shipped together with the product, but not assembled.

⚠ Precautions

Be sure to read this before handling the products.
Refer to back page 50 for Safety Instructions and pages 3 to 12 for Actuator and Auto Switch Precautions.

Mounting

⚠ Caution

- During installation, secure the rod cover and tighten by applying an appropriate tightening force to the retaining nut or to the rod cover body.
 If the head cover is secured or the head cover is tightened, the cover could rotate, leading to the deviation.
- Tighten the retaining screws to an appropriate tightening torque within the range given below. Apply a Loctite® (no. 242 Blue) for mounting thread.

Bore size (mm)	Proper tightening torque for mounting thread (N·m) (Tightening torque for mounting nut)
10	3.0 to 3.2
16	5.4 to 5.9

- To remove and install the retaining ring for the knuckle pin or the clevis pin, use an appropriate pair of pliers (tool for installing a type C retaining ring).
 Especially with ø10, use ultra thin pliers.
- In the case of auto switch rail mounting type, do not remove the rail that is mounted. Because retaining screws extend into the cylinder, this could lead to an air leak.

Weights

		(g)	
Bore size (mm)		10	16
Basic weight (When the stroke is zero)	Basic	22	46
	Axial piping	22	46
	Double clevis (including clevis pin)	24	54
	Head-side bossed	23	48
Additional weight per 15 mm of stroke		4	7
	Single foot	8	25
	Double foot	16	50
Mounting bracket weight	Rod flange	5	13
	Head flange	5	13
	Single knuckle joint	17	23
Accessories	Double knuckle joint (including knuckle pin)	25	21
	Double knuckle joint (With one-touch connecting pin)	26	22
	Rod end cap (Flat type)	1	2
	Rod end cap (Round type)	1	2
	T-bracket	32	50

* Mounting nut and rod end nut are included in the basic weight.
 Note) Mounting nut is not included in the basic weight for the double clevis.

Calculation: Example) **CJ2YL10-45Z**
 • Basic weight..... 22 (ø10)
 • Additional weight..... 4/15 stroke
 • Cylinder stroke..... 45 stroke
 • Mounting bracket weight..... 8 (Axial foot)
 $22 + 4/15 \times 45 + 8 = 42 \text{ g}$

REA
REB
REC
Smooth
Low Speed
MQ
RHC
RZQ

D-□
-X□

CJ2Y Series

Dimensions

Basic (B)

CJ2YB **Bore size** – **Stroke** **Head cover port location** **Z**

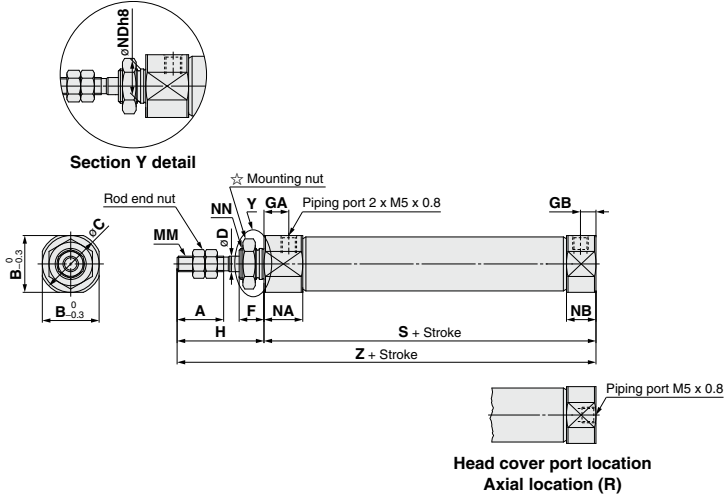

☆ Refer to page 148 for details of the mounting nut.

Bore size	A	B	C	D	F	GA	GB	H	MM	NA	NB	NDh8	NN	S	Z
10	15	12	14	4	8	8	5	28	M4 x 0.7	12.5	9.5	8 ⁰ _{-0.022}	M8 x 1.0	46	74
16	15	18.3	20	5	8	8	5	28	M5 x 0.8	12.5	9.5	10 ⁰ _{-0.022}	M10 x 1.0	47	75

Single foot (L)

CJ2YL **Bore size** – **Stroke** **Head cover port location** **Z**

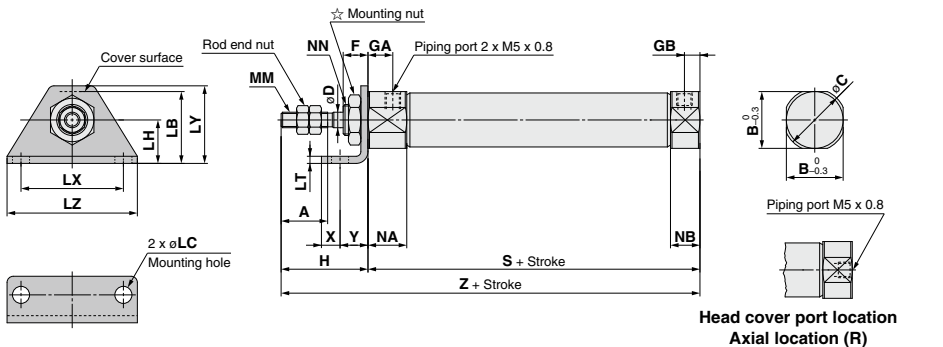

☆ Refer to page 148 for details of the mounting nut.

Bore size	A	B	C	D	F	GA	GB	H	LB	LC	LH	LT	LX	LY	LZ	MM	NA	NB	NN	S	X	Y	Z
10	15	12	14	4	8	8	5	28	15	4.5	9	1.6	24	16.5	32	M4 x 0.7	12.5	9.5	M8 x 1.0	46	5	7	74
16	15	18.3	20	5	8	8	5	28	23	5.5	14	2.3	33	25	42	M5 x 0.8	12.5	9.5	M10 x 1.0	47	6	9	75

Dimensions

Double foot (M)

CJ2YM **Bore size** – **Stroke** Z

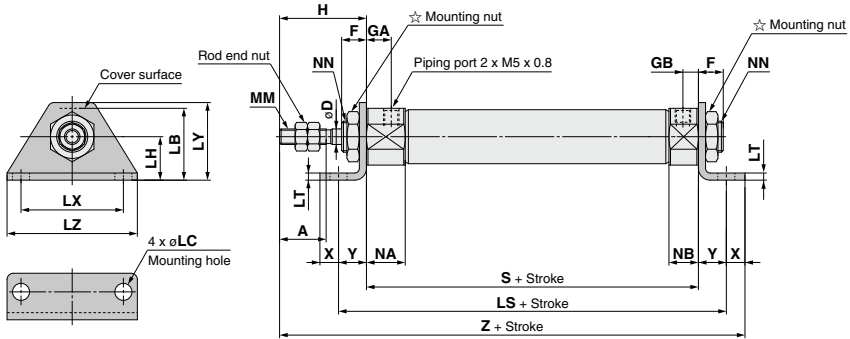

☆ Refer to page 148 for details of the mounting nut.

Bore size	A	D	F	GA	GB	H	LB	LC	LH	LS	LT	LX	LY	LZ	MM	NA	NB	NN	S	X	Y	Z
10	15	4	8	8	5	28	15	4.5	9	60	1.6	24	16.5	32	M4 x 0.7	12.5	9.5	M8 x 1.0	46	5	7	86
16	15	5	8	8	5	28	23	5.5	14	65	2.3	33	25	42	M5 x 0.8	12.5	9.5	M10 x 1.0	47	6	9	90

REA
REB
REC
Smooth
Low Speed
MQ
RHC
RZQ

Rod flange (F)

CJ2YF **Bore size** – **Stroke** **Head cover port location** Z

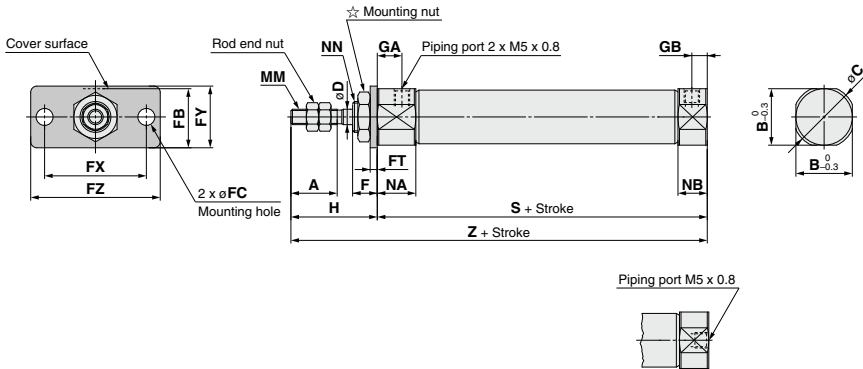

Head cover port location Axial location (R)

☆ Refer to page 148 for details of the mounting nut.

* The overall cylinder length does not change.

Bore size	A	B	C	D	F	FB	FC	FT	FX	FY	FZ	GA	GB	H	MM	NA	NB	NN	S	Z
10	15	12	14	4	8	13	4.5	1.6	24	14	32	8	5	28	M4 x 0.7	12.5	9.5	M8 x 1.0	46	74
16	15	18.3	20	5	8	19	5.5	2.3	33	20	42	8	5	28	M5 x 0.8	12.5	9.5	M10 x 1.0	47	75

D-□
-X□

CJ2Y Series

Dimensions

Head flange (G)

CJ2YG Bore size – Stroke Z

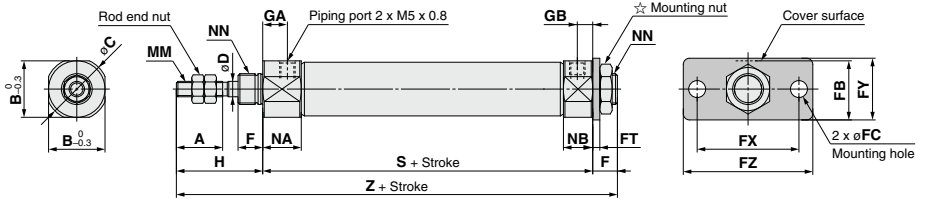

☆ Refer to page 148 for details of the mounting nut.

Bore size	A	B	C	D	F	FB	FC	FT	FX	FY	FZ	GA	GB	H	MM	NA	NB	NN	S	Z
10	15	12	14	4	8	13	4.5	1.6	24	14	32	8	5	28	M4 x 0.7	12.5	9.5	M8 x 1.0	46	82
16	15	18.3	20	5	8	19	5.5	2.3	33	20	42	8	5	28	M5 x 0.8	12.5	9.5	M10 x 1.0	47	83

Double clevis (D)

CJ2YD Bore size – Stroke Z

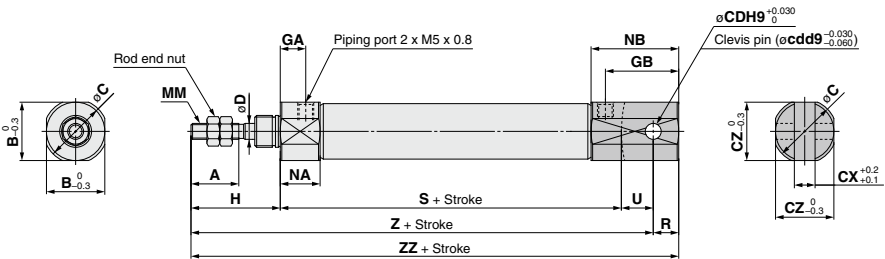

* A clevis pin and retaining rings are included.

Bore size	A	B	C	CD (cd)	CX	CZ	D	GA	GB	H	MM	NA	NB	R	S	U	Z	ZZ
10	15	12	14	3.3	3.2	12	4	8	18	28	M4 x 0.7	12.5	22.5	5	46	8	82	87
16	15	18.3	20	5	6.5	18.3	5	8	23	28	M5 x 0.8	12.5	27.5	8	47	10	85	93

Dimensions

Double-side bossed (E)

CJ2YE **Bore size** – **Stroke Z**

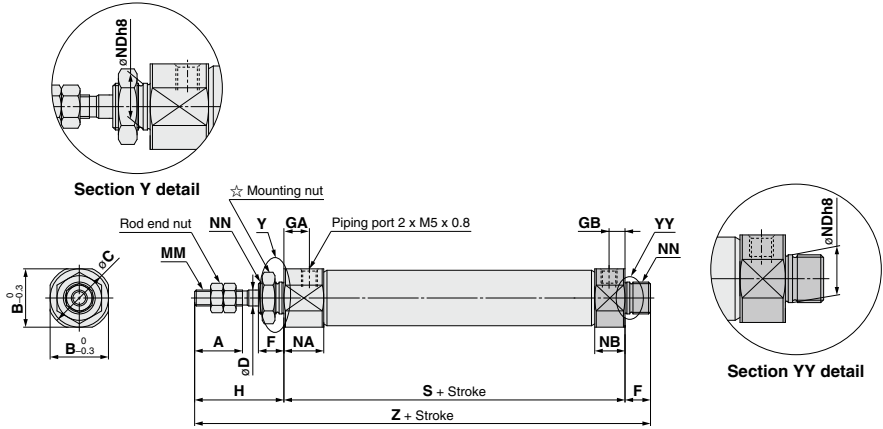

☆ Refer to page 148 for details of the mounting nut.

Bore size	A	B	C	D	F	GA	GB	H	MM	NA	NB	NDh8	NN	S	Z
10	15	12	14	4	8	8	5	28	M4 x 0.7	12.5	9.5	$8_{-0.022}^0$	M8 x 1.0	46	82
16	15	18.3	20	5	8	8	5	28	M5 x 0.8	12.5	9.5	$10_{-0.022}^0$	M10 x 1.0	47	83

REA

REB

REC

Smooth

Low Speed

MQ

RHC

RZQ

D-□

-X□

CJ2Y Series

Dimensions of Accessories (options)

Single Knuckle Joint Material: Rolled steel

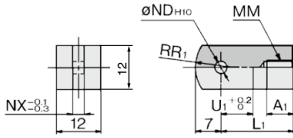

(mm)

Part no.	Applicable bore size	A ₁	L ₁	MM	ND _{H10}	NX	R ₁	U ₁
I-J010C	10	8	21	M4 x 0.7	3.3 ^{+0.048} ₀	3.1	8	9
I-J016C	16	8	25	M5 x 0.8	5 ^{+0.048} ₀	6.4	12	14

Double Knuckle Joint Material: Rolled steel

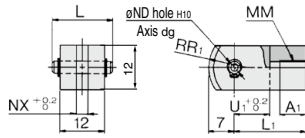

(mm)

Part no.	Applicable bore size	A ₁	L	L ₁	MM
Y-J010C	10	8	15.2	21	M4 x 0.7
Y-J016C	16	11	16.6	21	M5 x 0.8

Part no.	ND _{d9}	ND _{H10}	NX	R ₁	U ₁
Y-J010C	3.3 ^{+0.030} _{-0.060}	3.3 ^{+0.048} ₀	3.2	8	10
Y-J016C	5 ^{+0.030} _{-0.060}	5 ^{+0.048} ₀	6.5	12	10

* A knuckle pin and retaining rings are included.

Knuckle Pin Material: Stainless steel

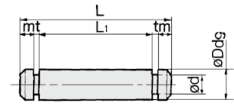

(mm)

Part no.	Applicable bore size	Dd9	d	L	L ₁	m	t	Included retaining ring
CD-J010	10	3.3 ^{+0.030} _{-0.060}	3	15.2	12.2	1.2	0.3	Type C 3.2
IY-J015	16	5 ^{+0.030} _{-0.060}	4.8	16.6	12.2	1.5	0.7	Type C 5

* For $\phi 10$, a clevis pin is diverted.
* Retaining rings are included with a knuckle pin.

Double Knuckle Joint (With One-touch Connecting Pin)

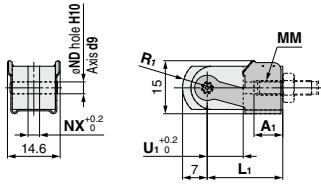

(mm)

Part no.	Applicable bore size	A ₁	L ₁	MM	ND _{d9}	ND _{H10}	NX	R ₁	U ₁
Y-J10	10	8	21	M4 x 0.7	3.3 ^{+0.030} _{-0.060}	3.3 ^{+0.048} ₀	3.2	8	10
Y-J16	16	11	21	M5 x 0.8	5 ^{+0.030} _{-0.060}	5 ^{+0.048} ₀	6.5	12	10

One-touch Connecting Pin for Double Knuckle Joint Material: Stainless steel

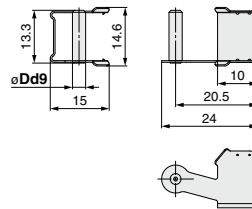

(mm)

Part no.	Applicable bore size	Dd9
IY-J10	10	3.3 ^{+0.030} _{-0.060}
IY-J16	16	5 ^{+0.030} _{-0.060}

Mounting Nut Material: Carbon steel

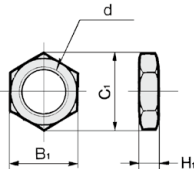

(mm)

Part no.	Applicable bore size	B ₁	C ₁	d	H ₁
SNJ-010C	10	11	12.7	M8 x 1.0	4
SNJ-016C	16	14	16.2	M10 x 1.0	4

Rod End Nut Material: Carbon steel

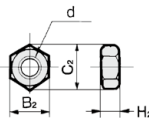

(mm)

Part no.	Applicable bore size	B ₂	C ₂	d	H ₂
NTJ-010C	10	7	8.1	M4 x 0.7	3.2
NTJ-015C	16	8	9.2	M5 x 0.8	4

Pivot Bracket (T-bracket)

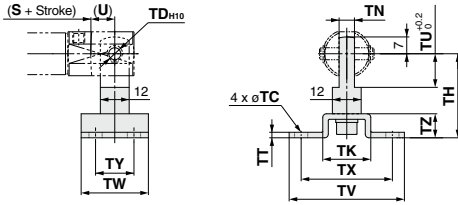

Part no.	Applicable bore size	TC	TD _{H10}	TH	TK	TN	TT	TU	TV	TW	TX	TY	TZ
CJ-T010C	10	4.5	3.3 ^{+0.048} ₀	29	18	3.1	2	9	40	22	32	12	8
CJ-T016C	16	5.5	5 ^{+0.048} ₀	35	20	6.4	2.3	14	48	28	38	16	10

* A T-bracket includes a T-bracket base, single knuckle joint, hexagon socket head bolt and spring washer.

* For dimensions of (U) and (S + Stroke), refer to the double clevis drawing on page 146.

Clevis Pin

Material: Stainless steel

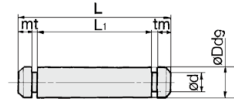

Part no.	Applicable bore size	Dd9	d	L	L ₁	m	t	Included retaining ring
CD-J010	10	3.3 ^{+0.030} _{-0.060}	3	15.2	12.2	1.2	0.3	Type C 3.2
CD-Z015	16	5 ^{+0.030} _{-0.060}	4.8	22.7	18.3	1.5	0.7	Type C 5

* Retaining rings are included with a clevis pin.

One-touch Connecting Pin for Double Clevis

Material: Stainless steel

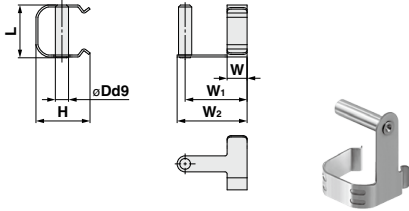

Part no.	Applicable bore size	Dd9	H	L	W
CD-J10	10	3.3 ^{+0.030} _{-0.060}	13.4	13.2	4
CD-J16	16	5 ^{+0.030} _{-0.060}	18.2	19.5	5

Part no.	W ₁	W ₂	Note
CD-J10	12	15	Cannot be mounted on cylinders with air cushion, or rail mounting type auto switches.
CD-J16	15	18	

* Please pay attention to the applicable cylinder.

Rod End Cap

Material: Polycacetal

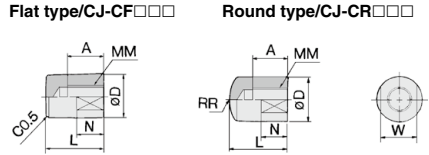

Part no.		Applicable bore size	A	D	L	MM	N	R	W
Flat type	Round type								
CJ-CF010	CJ-CR010	10	8	10	13	M4 x 0.7	6	10	8
CJ-CF016	CJ-CR016	16	10	12	15	M5 x 0.8	7	12	10

Mounting Brackets, Rod End Brackets, and Nut Material: Stainless Steel

Part No. (Dimensions: Same as standard type)

Bore size (mm)	Foot	Flange	Single knuckle joint	Double knuckle joint*	Mounting nut	Rod end nut
10	—	—	I-J010SUS	Y-J010SUS	—	NTJ-010SUS
16	CJ-L016SUS	CJ-F016SUS	I-J016SUS	Y-J016SUS	SNJ-016SUS	NTJ-015SUS

* A knuckle pin and retaining rings are shipped together.

REA

REB

REC

Smooth

Low Speed

MQ

RHC

RZQ

D-□

-X□

Precautions

Assembly Procedures

1. Double Clevis (With One-touch Connecting Pin) (CD-J□)

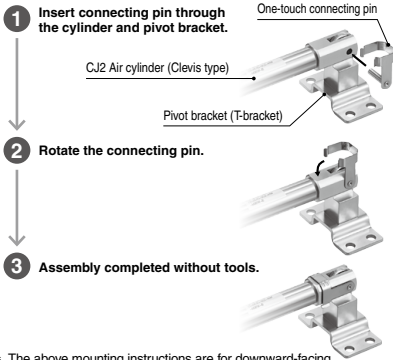

* The above mounting instructions are for downward-facing ports. Refer to the following for upward-facing ports.

2. Double Knuckle Joint (With One-touch Connecting Pin) (IV-J□)

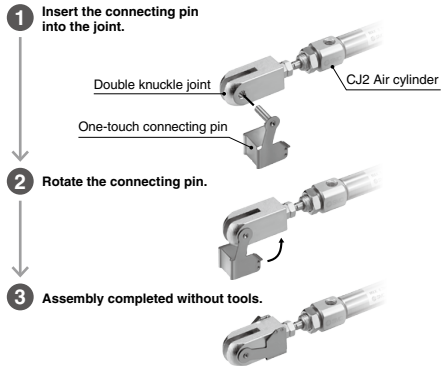

How to Mount the Double Clevis (With One-touch Connecting Pin)

When connecting a double clevis cylinder to a pivot bracket (T-bracket), it is recommended that the pivot bracket (T-bracket) and the cylinder be connected with the one-touch connecting pin first, before fastening the pivot bracket.

When connecting the cylinder after the pivot bracket (T-bracket) has been fastened, mount the cylinder according to the following procedure.

⚠ Warning

For assembling the clevis type to the pivot bracket, refer to the figure below.

1. Insert the double clevis (One-touch connecting pin) from the direction in the figure.

When port is facing upward

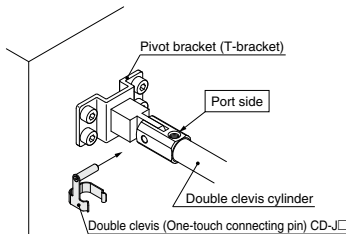

When port is facing downward

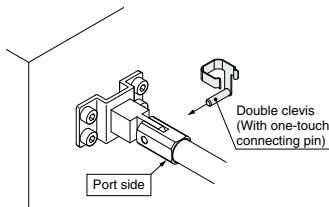

⚠ Warning

* Perform the mounting within the following range.

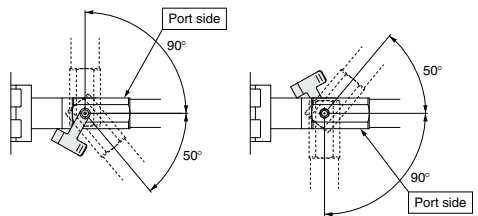

2. Push the one-touch connecting pin into the cylinder body (Double clevis) until it clicks and is firmly fastened.

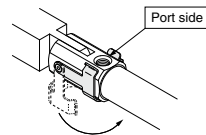

* Attach the double knuckle joint within 180° (±90° from center). Other mounting methods are the same as the above.

CJ2Y Series Auto Switch Mounting

Auto Switch Proper Mounting Position (Detection at stroke end) and Its Mounting Height

Solid state auto switch

<Band mounting>

D-M9□
D-M9□W
D-M9□A

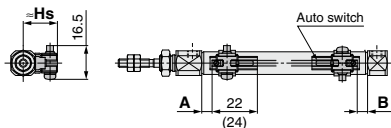

() : Dimension of the D-M9□A
A and B are the dimensions from the end of the head cover/rod cover to the end of the auto switch.

D-M9□V
D-M9□MV
D-M9□AV

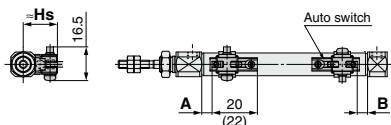

() : Dimension of the D-M9□AV
A and B are the dimensions from the end of the head cover/rod cover to the end of the auto switch.

D-H7□
D-H7□W
D-H7BA
D-H7NF
D-H7C

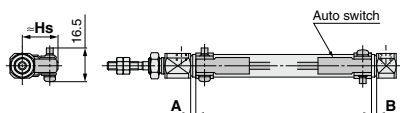

Reed auto switch <Band mounting>

D-A9□

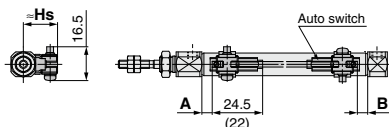

() : Dimension of the D-A96
A and B are the dimensions from the end of the head cover/rod cover to the end of the auto switch.

D-A9□V

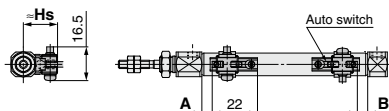

A and B are the dimensions from the end of the head cover/rod cover to the end of the auto switch.

D-C7□/C80
D-C73C□/C80C

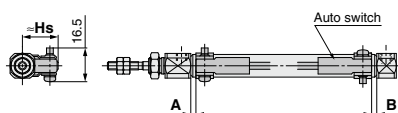

REA

REB

REC

Smooth

Low
Speed

MQ

RHC

RZQ

D-□

-X□

CJ2Y Series

Auto Switch Proper Mounting Position (Detection at stroke end) and Its Mounting Height

<Rail mounting>

D-M9□
D-M9□W
D-M9□A

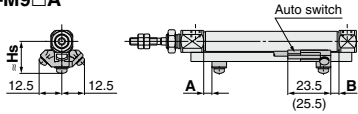

() : Dimension of the D-M9□A

D-M9□V
D-M9□WV
D-M9□AV

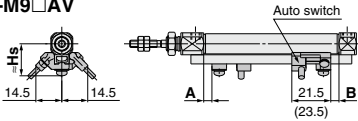

() : Dimension of the D-M9□AV

D-F7□/J79
D-F7□W/J79W
D-F79F/F7BA

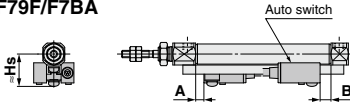

D-F7□V/F7□WV
D-F7BAV
D-J79C

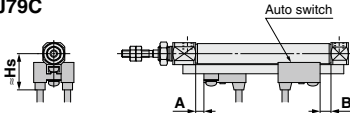

<Rail mounting>

D-A9□

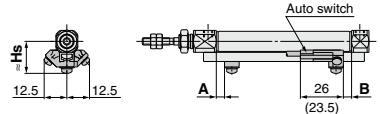

() : Dimension of the D-A9□

D-A9□V

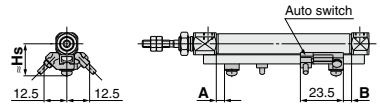

D-A7□/A80
D-A73C/A80C
D-A79W

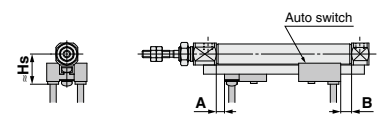

D-A7□H/A80H

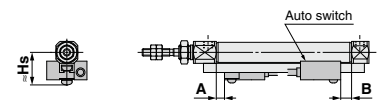

Auto Switch Proper Mounting Position (Detection at stroke end) and Its Mounting Height

Auto Switch Proper Mounting Position

Auto switch model		Band mounting (mm)							
		D-M9□ D-M9□V D-M9□W D-M9□WV D-M9□A D-M9□AV		D-A9□ D-A9□V		D-C7□ D-C80 D-C73C D-C80C		D-H7□ D-H7C D-H7NF D-H7□W D-H7BA	
Bore size		A	B	A	B	A	B	A	B
10		(5) 6	(5) 6	(1) 2	(1) 2	2.5	2.5	1.5	1.5
16		(5.5) 6.5	(5.5) 6.5	(1.5) 2.5	(1.5) 2.5	3	3	2	2

* The values in () are measured from the end of the auto switch mounting bracket.

Auto switch model		Rail mounting (mm)											
		D-M9□ D-M9□V D-M9□W D-M9□WV D-M9□A D-M9□AV		D-A9□ D-A9□V		D-A7□ D-A80		D-A7□H/A80H D-A73C/A80C D-F7□/J79 D-F7□W/J79W D-F7□V/F7□WV D-F79F D-J79C D-F7BA D-F7BAV		D-F7NT		D-A79W	
Bore size		A	B	A	B	A	B	A	B	A	B	A	B
10		4.5	4.5	0.5	0.5	3	3	3.5	3.5	8.5	8.5	0.5	0.5
16		5	5	1	1	3.5	3.5	4	4	9	9	1	1

* Adjust the auto switch after confirming the operating condition in the actual setting.

Auto Switch Mounting Height

Auto switch model		Band mounting (mm)											
		D-M9□ D-M9□W D-M9□A D-A9□		D-M9□V D-M9□WV D-M9□AV D-A9□V		D-C7□/C80 D-H7□/H7□W D-H7NF D-H7BA		D-C73C D-C80C		D-H7C		D-A7□ D-A80	
Bore size		Hs		Hs		Hs		Hs		Hs		Hs	
10		17		18		17		19.5		20		16.5	
16		20.5		21		20.5		23		23.5		19.5	

Auto switch model		Rail mounting (mm)											
		D-M9□ D-M9□V D-M9□W D-M9□WV D-M9□A D-M9□AV D-A9□ D-A9□V		D-A7□H/A80H D-F7□/J79 D-F7□W/J79W D-F7BA/F79F D-F7NT		D-A73C D-A80C		D-F7□V D-F7□WV D-F7BAV		D-J79C		D-A79W	
Bore size		Hs		Hs		Hs		Hs		Hs		Hs	
10		17.5		17.5		23.5		20		23		19	
16		21		20.5		26.5		23		26		22	

REA

REB

REC

Smooth

Low Speed

MQ

RHC

RZQ

D-□

-X□

Minimum Stroke for Auto Switch Mounting

		(mm)				
Auto switch mounting	Auto switch model	Number of auto switches				
		With 1 pc.	With 2 pcs.		With n pcs. (n: Number of auto switches)	
			Different surfaces	Same surface	Different surfaces	Same surface
Band mounting	D-M9□ D-M9□W D-M9□A D-A9□	10	15 Note 1)	45 Note 1)	$15 + 35 \frac{(n-2)}{2}$ (n = 2, 4, 6... Note 3)	45 + 15 (n - 2) (n = 2, 3, 4, 5...)
	D-M9□V	5	15 Note 1)	35	$15 + 35 \frac{(n-2)}{2}$ (n = 2, 4, 6... Note 3)	35 + 25 (n - 2) (n = 2, 3, 4, 5...)
	D-M9□WV D-M9□AV	10	15 Note 1)	35	$15 + 35 \frac{(n-2)}{2}$ (n = 2, 4, 6... Note 3)	35 + 25 (n - 2) (n = 2, 3, 4, 5...)
	D-A9□V	5	10	35	$10 + 35 \frac{(n-2)}{2}$ (n = 2, 4, 6... Note 3)	35 + 25 (n - 2) (n = 2, 3, 4, 5...)
	D-C7□ D-C80	10	15	50	$15 + 40 \frac{(n-2)}{2}$ (n = 2, 4, 6... Note 3)	50 + 20 (n - 2) (n = 2, 3, 4, 5...)
	D-H7□/H7□W D-H7BA D-H7NF	10	15	60	$15 + 45 \frac{(n-2)}{2}$ (n = 2, 4, 6... Note 3)	60 + 22.5 (n - 2) (n = 2, 3, 4, 5...)
	D-C73C D-C80C D-H7C	10	15	65	$15 + 50 \frac{(n-2)}{2}$ (n = 2, 4, 6... Note 3)	50 + 27.5 (n - 2) (n = 2, 3, 4, 5...)
Rail mounting	D-M9□V	5	—	5	—	10 + 10 (n - 2) (n = 4, 6... Note 4)
	D-A9□V	5	—	10	—	10 + 15 (n - 2) (n = 4, 6... Note 4)
	D-M9□ D-A9□	10	—	10	—	15 + 15 (n - 2) (n = 4, 6... Note 4)
	D-M9□WV D-M9□AV	10	—	15	—	15 + 15 (n - 2) (n = 4, 6... Note 4)
	D-M9□W	15	—	15	—	20 + 15 (n - 2) (n = 4, 6... Note 4)
	D-M9□A	15	—	20	—	20 + 15 (n - 2) (n = 4, 6... Note 4)
	D-A7□/A80 D-A7□H/A80H D-A73C/A80C	5	—	10	—	15 + 10 (n - 2) (n = 4, 6... Note 4)
	D-A7□H D-A80H	5	—	10	—	15 + 15 (n - 2) (n = 4, 6... Note 4)
	D-A79W	10	—	15	—	10 + 15 (n - 2) (n = 4, 6... Note 4)
	D-F7□ D-J79	5	—	5	—	15 + 15 (n - 2) (n = 4, 6... Note 4)
	D-F7□V D-J79C	5	—	5	—	10 + 10 (n - 2) (n = 4, 6... Note 4)
	D-F7□W/J79W D-F7BA/F79F/F7NT	10	—	15	—	15 + 20 (n - 2) (n = 4, 6... Note 4)
	D-F7□WV D-F7BAV	10	—	15	—	10 + 15 (n - 2) (n = 4, 6... Note 4)

Note 3) When "n" is an odd number, an even number that is one larger than this odd number is used for the calculation.

Note 4) When "n" is an odd number, an even number that is one larger than this odd number is used for the calculation.

However, the minimum even number is 4. So, 4 is used for the calculation when "n" is 1 to 3.

Note 1) Auto switch mounting

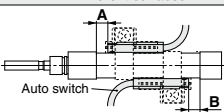
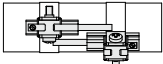
Auto switch model	With 2 auto switches	
	Different surfaces Note 1)	Same surface Note 1)
 <p>The proper auto switch mounting position is 5.5 mm inward from the switch holder edge. The above A and B indicate values for band mounting in the table of page 151.</p>	 <p>The auto switch is mounted by slightly displacing it in a direction (cylinder tube circumferential exterior) so that the auto switch and lead wire do not interfere with each other.</p>	
D-M9□/M9□W/M9□A	Less than 20 stroke Note 2)	Less than 55 stroke Note 2)
D-A90/A93	—	Less than 50 stroke Note 2)

Note 2) Minimum stroke for auto switch mounting in types other than those mentioned in Note 1.

Operating Range

	Auto switch model	Bore size (mm)	
		10	16
Band mounting	D-M9□/M9□V D-M9□W/M9□WV D-M9□A/M9□AV	2.5	3
	D-A9□	6	7
	D-C7□/C80/C73C/C80C	7	7
	D-H7□/H7□W D-H7BA/H7NF	4	4
	D-H7C	8	9
Rail mounting	D-M9□/M9□V D-M9□W/M9□WV D-M9□A/M9□AV	3	3.5
	D-A9□/A9□V	6	6.5
	D-A7□/A80/A7H/A80H D-A73C/A80C	8	9
	D-A79W	11	13
	D-F7□/J79/F7□W/J79W D-F7□V/F7□WV/F79F D-J79C/F7BA/F7BAV D-F7NT	5	5

* Values which include hysteresis are for guideline purposes only, they are not a guarantee (assuming approximately ±30% dispersion) and may change substantially depending on the ambient environment.

Auto Switch Mounting Brackets/Part No.

Auto switch mounting	Auto switch model	Bore size (mm)	
		10	16
Band mounting	D-M9□ D-M9□V D-M9□W D-M9□WV D-A9□ D-A9□V	BJ6-010 (A set of a, b, c, d)	BJ6-016 (A set of a, b, c, d)
	D-M9□A ^{Note 2)} D-M9□AV ^{Note 2)}	BJ6-010S (A set of a, b, d, e)	BJ6-016S (A set of a, b, d, e)
Band mounting	D-C7□/C80 D-C73C/C80C D-H7□/H7□W D-H7BA/H7NF	BJ2-010 (A set of band and screw)	BJ2-016 (A set of band and screw)
Rail mounting ^{Note 4)}	D-M9□ D-M9□V D-M9□W D-M9□WV D-M9□A ^{Note 5)} D-M9□AV ^{Note 5)} D-A9□ D-A9□V	BQ2-012(S) (A set of a and b)	BQ2-012(S) (A set of a and b)

Note 1) Since the switch bracket (made from nylon) are affected in an environment where alcohol, chloroform, methylamines, hydrochloric acid or sulfuric acid is splashed over, so it cannot be used. Please contact SMC regarding other chemicals.

Note 2) When the indicator LED for mounting the switch bracket. As the indicator LED is projected from the switch unit, indicator LED may be damaged if the switch bracket is fixed on the indicator LED.

Note 3) When the cylinder is shipped, the auto switch mounting bracket and the auto switch will be included.

Note 4) For the D-M9□A(V), order the BQ2-012S, which uses stainless steel mounting screws.

Band Mounting Brackets Set Part No.

Set part no.	Contents
BJ2-□□□	• Auto switch mounting band (a) • Auto switch mounting screw (b)
BJ4-1	• Switch bracket (White/PBT) (e) • Switch holder (d)
BJ5-1	• Switch bracket (Transparent/Nylon) (c) • Switch holder (d)

[Stainless Steel Mounting Screw]

The following stainless steel mounting screw kit is available. Use it in accordance with the operating environment. (Since the auto switch mounting bracket is not included, order it separately.)

BBA4: For D-C7/C8/H7 types

Note 5) Refer to page 1048 for details on the BBA4.

When the D-H7BA type auto switch is shipped independently, the BBA4 is attached.

REA

REB

REC

Smooth

Low Speed

MQ

RHC

RZQ

D-□

-X□

CJ2Y Series

Other than the applicable auto switches listed in “How to Order”, the following auto switches are mountable.

Refer to pages 941 to 1067 for the detailed specifications.

Type	Mounting	Model	Electrical entry	Features	
Solid state	Band mounting	D-H7A1/H7A2/H7B	Grommet (In-line)	—	
		D-H7NW/H7PW/H7BW		Diagnostic indication (2-color indicator)	
	Rail mounting	D-F79/F7P/J79		—	
		D-F79W/F7PW/J79W		Diagnostic indication (2-color indicator)	
		D-F7NV/F7PV/F7BV	—		
		D-F7NVV/F7BVV	Diagnostic indication (2-color indicator)		
Reed	Band mounting	D-C73/C76	Grommet (In-line)	—	
		D-C80		Without indicator light	
	Rail mounting	D-A73H/A76H		—	
		D-A80H		Without indicator light	
		D-A73		—	
		D-A80		Without indicator light	
			Grommet (Perpendicular)		

* With pre-wired connector is also available for solid state auto switches. For details, refer to pages 1014 and 1015.

* Normally closed (NC = b contact) solid state auto switches (D-M9□E(V)) are also available. For details, refer to page 1592-1.

Smooth Cylinder

CM2Y Series

ø20, ø25, ø32, ø40



How to Order

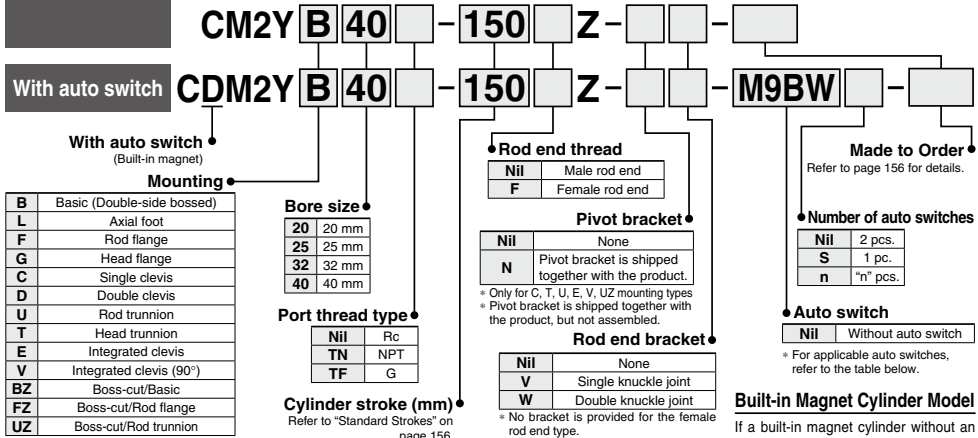

* Refer to "Ordering Example of Cylinder Assembly" on page 157.

Applicable Auto Switches

Refer to pages 941 to 1067 for further information on auto switches.

Type	Special function	Electrical entry	Indicator Light	Wiring (Output)	Load voltage		Auto switch model		Lead wire length (m)					Pre-wired connector	Applicable load					
					DC	AC	Perpendicular	In-line	0.5 (Nil)	1 (M)	3 (L)	5 (Z)	None (N)							
Solid state auto switch	—	Grommet	Yes	3-wire (NPN)	5 V, 12 V	—	M9NV	M9N	●	●	○	○	○	—	IC circuit					
				3-wire (PNP)			M9PV	M9P	●	●	○	○	○							
		Connector		2-wire	12 V	—	M9BV	M9B	●	●	○	○	○	—	—					
				Terminal conduit			3-wire (NPN)	—	G39A	—	—	●	—			—	—	IC circuit		
	Diagnostic indication (2-color indicator)	Water resistant (2-color indicator)	Grommet	Yes	3-wire (NPN)	24 V	—	M9NVV	M9NW	●	●	○	○	○	—	Relay, PLC				
					3-wire (PNP)			M9PVV	M9PW	●	●	○	○	○						
					2-wire	12 V	—	M9BWW	M9BW	●	●	○	○	○	—	—				
					3-wire (NPN)			M9NAV*1	M9NA*1	○	○	○	○	○			—	IC circuit		
					3-wire (PNP)	M9PAV*1	M9PA*1	○	○	○	○	○	○	—	—					
					2-wire	12 V	—	M9BAV*1	M9BA*1	○	○	○	○			○	—	—		
4-wire (NPN)	5 V, 12 V	—	—	H7NF	●			●	○	○	○	—	IC circuit							
Reed auto switch	—	Grommet	Yes	3-wire (NPN equivalent)	5 V	—	A96V	A96	●	●	●	●	—	—	—					
				100 V			A93V*2	A93	●	●	●	●	—			—	—			
				Connector	2-wire	24 V	—	100 V or less	12 V	—	A90V	A90	●	●	●			●	—	IC circuit
								100 V, 200 V			—	B54	●	●	●	●	—	—		
								200 V or less			—	B64	●	●	●	●				
		Terminal conduit		—	—	—	24 V or less	12 V	—	C73C	—	●	●	●	●	—	IC circuit			
							—			—	C80C	●	●	●	●			—	—	
							100 V, 200 V			—	A33A	—	—	●	●					—
		DIN terminal		Grommet	Yes	—	—	—	—	A34A	—	—	—	—	—	—	Relay, PLC			
							—	—	—	A44A	—	—	—	—	—			—		
—	—	—	—	—	—	—	B59W	●	●	●	●	—	—	—						

*1 Water resistant type auto switches can be mounted on the above models, but in such case SMC cannot guarantee water resistance.
Please consult with SMC regarding water resistant types with the above model numbers.

*2 1 m type lead wire is only applicable to D-A93.

* Lead wire length symbols: 0.5 m Nil (Example) M9NW
1 m M (Example) M9NWW
3 m L (Example) M9NWL
5 m Z (Example) M9NZ
None N (Example) H7CN

* Solid state auto switches marked with "○" are produced upon receipt of order.
* Do not indicate suffix "N" for no lead wire on the D-A93/A44A/G39A/K39A models.

* Since there are other applicable auto switches than listed above, refer to page 171 for details.
* For details about auto switches with pre-wired connector, refer to pages 1014 and 1015.
* The D-A93/M9C auto switches are shipped together, (but not assembled). (However, only the auto switch mounting brackets are assembled before shipment).
* The D-C73/C80/H7C auto switches are assembled before shipment.

- REA
- REB
- REC
- Smooth
- Low Speed
- MQ
- RHC
- RZQ



CM2Y Series



Integrated clevis

Symbol

Double acting, Single rod, Rubber bumper

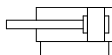

Made to Order
Click here for details

Symbol	Specifications
-XA□	Change of rod end shape
-XC3	Special port location
-XC6	Made of stainless steel
-XC9	Adjustable stroke cylinder/Adjustable retraction type
-XC10	Dual stroke cylinder/Double rod type
-XC13	Auto switch rail mounting
-XC20	Head cover axial port
-XC25	No fixed throttle of connection port
-XC27	Double clevis and double knuckle joint pins made of stainless steel
-XC29	Double knuckle joint with spring pin
-XC52	Mounting nut with set screw
-X1854	Low friction cylinder mounting

* Refer to page 157 for "-X1854".

Replacement Parts/Rod Seal

Bore size (mm)	Part no.
20	CM20Z-PS
25	CM25Z-PS
32	CM32Z-PS
40	CM40Z-PS

Grease Pack for Maintenance

When maintenance requires only grease, use the following part numbers to order.

Grease pack part number: GR-L-005 (5 g)
GR-L-010 (10 g)
GR-L-150 (150 g)

Specifications

Bore size (mm)	20	25	32	40
Action	Double acting, Single rod			
Piston speed	5 to 500 mm/s			
Fluid	Air			
Proof pressure	1.05 MPa			
Maximum operating pressure	0.7 MPa			
Ambient and fluid temperature	Without auto switch: -10°C to 70°C With auto switch: -10°C to 60°C (No freezing)			
Lubrication	Not required (Non-lube)			
Stroke length tolerance	$^{+1.4}_{-0}$ mm			
Cushion	Rubber bumper			
Allowable leakage rate	0.5 L/min (ANR) or less			

Minimum Operating Pressure

Unit: MPa				
Bore size (mm)	20	25	32	40
Minimum operating pressure	0.02			

Mounting Brackets/Part No.

Mounting bracket	Min. order qty	Bore size (mm)				Contents (for minimum order quantity)
		20	25	32	40	
Axial foot*	2	CM-L020B	CM-L032B	CM-L040B	CM-L040B	2 feet, 1 mounting nut
Flange	1	CM-F020B	CM-F032B	CM-F040B	CM-F040B	1 flange
Single clevis**	1	CM-C020B	CM-C032B	CM-C040B	CM-C040B	1 single clevis, 3 liners
Double clevis (with pin)***	1	CM-D020B	CM-D032B	CM-D040B	CM-D040B	1 double clevis, 3 liners, 1 clevis pin, 2 retaining rings
Trunnion (with nut)	1	CM-T020B	CM-T032B	CM-T040B	CM-T040B	1 trunnion, 1 trunnion nut

* Order 2 feet per cylinder.

** 3 liners are included with a clevis bracket for adjusting the mounting angle.

*** A clevis pin and retaining rings (split pins for ø40) are included.

Mounting and Accessories/For details about accessories, refer to pages 165 to 167.

Accessories	Standard				Option			
	Mounting nut	Rod end nut	Clevis pin	Single knuckle joint	Note 3) Double knuckle joint	Note 4) Clevis pivot bracket	Note 6) Pivot bracket	Note 7) Pivot bracket pin
Basic (Double-side bossed)	● (1 pc.)	●	—	●	●	—	—	—
Axial foot	● (2)	●	—	●	●	—	—	—
Rod flange	● (1)	●	—	●	●	—	—	—
Head flange	● (1)	●	—	●	●	—	—	—
Integrated clevis	— Note 1)	●	—	●	●	●	—	—
Single clevis	— Note 1)	●	—	●	●	—	●	●
Double clevis Note 3)	— Note 1)	●	● Note 5)	●	●	—	—	—
Rod trunnion	● (1) Note 2)	●	—	●	●	—	—	—
Head trunnion	● (1) Note 2)	●	—	●	●	—	●	—
Boss-cut/Basic	● (1)	●	—	●	●	—	—	—
Boss-cut/Flange	● (1)	●	—	●	●	—	—	—
Boss-cut/Trunnion	● (1) Note 2)	●	—	●	●	—	—	—

Note 1) Mounting nuts are not attached to the integrated clevis, single clevis and double clevis types.

Note 2) Trunnion nuts are mounted on the rod trunnion and head trunnion types.

Note 3) A pin and retaining rings (split pins for ø40) are included with the double clevis and double knuckle joint types.

Note 4) A pin and retaining rings are included with the clevis pivot bracket.

Note 5) Retaining rings (split pins for ø40) are included with the clevis pin.

Note 6) A pin and retaining rings are included with the pivot bracket.

Note 7) Retaining rings are included with the pivot bracket pin.

* Stainless steel mounting brackets and accessories are also available.

Refer to page 166 for details.

Standard Strokes

Bore size (mm)	Standard stroke (mm)
20, 25, 32, 40	25, 50, 75, 100, 125, 150, 200, 250, 300

Note 1) Manufacture of intermediate strokes in 1 mm increments is possible. (Spacers are not used.)

Note 2) Applicable strokes should be confirmed according to the usage. For details, refer to "Air Cylinders Model Selection" on front matter pages of the Best Pneumatics No. 2-1. In addition, the products that exceed the standard stroke might not be able to fulfill the specifications due to the deflection etc.

Option: Ordering Example of Cylinder Assembly

Cylinder model: **CDM2YC40-150Z-NV-M9BW**

Mounting	C: Single clevis
Pivot bracket	N: Yes
Rod end bracket V:	Single knuckle joint
Auto switch D-M9BW:	2 pcs.

* Pivot bracket, single knuckle joint and auto switch are shipped together with the product, but not assembled.

* Pivot bracket is only applicable to mounting C, T, U, E, V and UZ.

* No rod end bracket is provided for the female rod end type.

Weights

Bore size (mm)		20	25	32	40
Basic weight	Basic (Double-side bossed)	0.14	0.21	0.28	0.56
	Axial foot	0.29	0.37	0.44	0.83
	Flange	0.20	0.30	0.37	0.68
	Integrated clevis	0.12	0.19	0.27	0.52
	Single clevis	0.18	0.25	0.32	0.65
	Double clevis	0.19	0.27	0.33	0.69
	Trunnion	0.18	0.28	0.34	0.66
	Boss-cut/Basic	0.13	0.19	0.26	0.53
	Boss-cut/Flange	0.19	0.28	0.35	0.65
Boss-cut/Trunnion	0.17	0.26	0.32	0.63	
Additional weight per 50 mm of stroke		0.04	0.06	0.08	0.13
Option bracket	Clevis bracket (with pin)	0.07	0.07	0.14	0.14
	Single knuckle joint	0.06	0.06	0.06	0.23
	Double knuckle joint (with pin)	0.07	0.07	0.07	0.20
	Pivot bracket	0.06	0.06	0.06	0.06
	Pivot bracket pin	0.02	0.02	0.02	0.03

Calculation: Example) **CM2YL32-100Z**

- Basic weight.....0.44 (Foot, ø32)
- Additional weight.....0.08/50 stroke
- Cylinder stroke.....100 stroke

$0.44 + 0.08 \times 100/50 = 0.60 \text{ kg}$

Same Mounting Dimensions as the Low Friction Cylinder

CM2Y **Mounting** **Bore size** - **Stroke** **Z-X1854**

Same mounting dimensions as the CM2Q ↓

In order to adjust the mounting dimensions of the low friction cylinder (CM2Q), extend the longitudinal dimension (S, ZZ) by 3 mm.

Specifications

Cylinder bore size (mm)	20	25	32	40
Action	Double acting, Single rod			
Direction of low friction	Bi-directional			
Fluid	Air			
Proof pressure	1.05 MPa			
Maximum operating pressure	0.7 MPa			

* Low friction operates bi-directionally.

⚠ Precautions

- Be sure to read this before handling the products.
- Refer to back page 50 for Safety Instructions and pages 3 to 12 for Actuator and Auto Switch Precautions.

Operating Precautions

⚠ Warning

- Do not rotate the cover.

If a cover is rotated when installing a cylinder or screwing a fitting into the port, it is likely to damage the junction part with cover.

⚠ Caution

- Not able to disassemble.

Cover and cylinder tube are connected to each other by caulking method, thus making it impossible to disassemble. Therefore, internal parts of a cylinder other than rod seal are not replaceable.

- Use caution to the popping of a retaining ring.

When replacing rod seals and removing and mounting a retaining ring, use a proper tool (retaining ring plier: tool for installing a type C retaining ring). Even if a proper tool is used, it is likely to inflict damage to a human body or peripheral equipment, as a retaining ring may be flown out of the tip of a plier. Be much careful with the popping of a retaining ring. Besides, be certain that a retaining ring is placed firmly into the groove of rod cover before supplying air at the time of installment.

- Do not use an air cylinder as an air-hydro cylinder.

If it uses turbine oil in place of fluids for cylinder, it may result in oil leakage.

- The oil stuck to the cylinder is grease.
- The base oil of grease may seep out.

The base oil of grease in the cylinder may seep out of the tube, cover, crimped part or rod bushing depending on the operating conditions (ambient temperature 40°C or more, pressurized condition, low frequency operation).

Dimensions

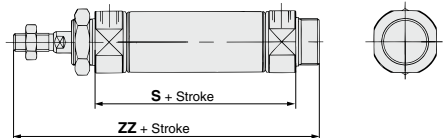

Bore size (mm)	S	ZZ
20	65	119
25	65	123
32	67	125
40	91	157

* Add 3 mm to S and ZZ dimensions of the double acting, single rod type on pages 158 to 164 for the dimensions for each mounting bracket other than the basic type.

REA

REB

REC

Smooth

Low Speed

MQ

RHC

RZQ

D-□

-X□

CM2Y Series

Basic (Double-side Bossed) (B)

CM2YB –

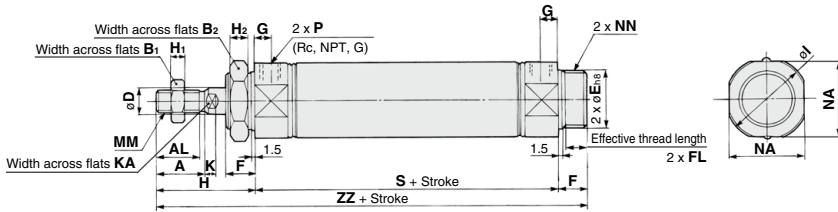

Boss-cut

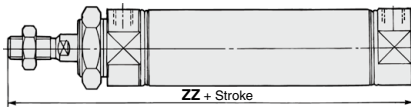

Female rod end

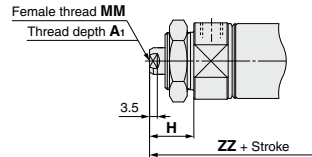

Bore size	A	AL	B ₁	B ₂	D	E	F	FL	G	H	H ₁	H ₂	I	K	KA	MM	NA	NN	P	S	ZZ
20	18	15.5	13	26	8	20 ⁰ _{-0.033}	13	10.5	8	41	5	8	28	5	6	M8 x 1.25	24	M20 x 1.5	1/8	62	116
25	22	19.5	17	32	10	26 ⁰ _{-0.033}	13	10.5	8	45	6	8	33.5	5.5	8	M10 x 1.25	30	M26 x 1.5	1/8	62	120
32	22	19.5	17	32	12	26 ⁰ _{-0.033}	13	10.5	8	45	6	8	37.5	5.5	10	M10 x 1.25	34.5	M26 x 1.5	1/8	64	122
40	24	21	22	41	14	32 ⁰ _{-0.039}	16	13.5	11	50	8	10	46.5	7	12	M14 x 1.5	42.5	M32 x 2	1/4	88	154

Boss-cut (mm)

Bore size	ZZ
20	103
25	107
32	109
40	138

Female Rod End (mm)

Bore size	A ₁	H	MM	ZZ
20	8	20	M4 x 0.7	95
25	8	20	M5 x 0.8	95
32	12	20	M6 x 1	97
40	13	21	M8 x 1.25	125

- * When female thread is used, use a thin wrench when tightening the piston rod.
- * When female thread is used, use a washer etc. to prevent the contact part at the rod end from being deformed depending on the material of the workpiece.

Axial Foot (L)

CM2YL Bore size Stroke Z

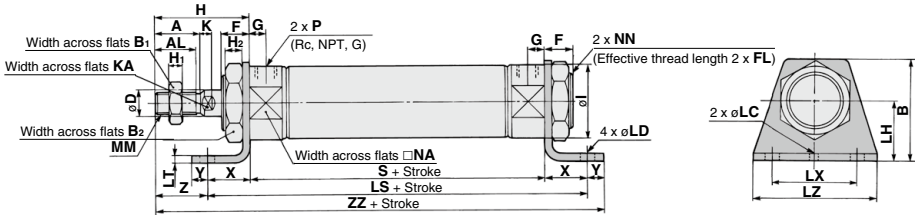

Female rod end

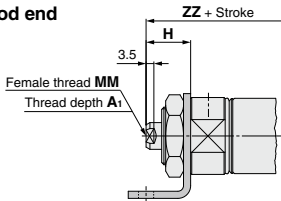

Female Rod End

		(mm)									
Bore size	A1	H	MM	ZZ							
20	8	20	M4 x 0.7	110							
25	8	20	M5 x 0.8	110							
32	12	20	M6 x 1	112							
40	13	21	M8 x 1.25	142							

- * When female thread is used, use a thin wrench when tightening the piston rod.
- * When female thread is used, use a washer etc. to prevent the contact part at the rod end from being deformed depending on the material of the workpiece.

* Mounting bracket is shipped together with the product.

Bore size	A	AL	B	B1	B2	D	F	FL	G	H	H1	H2	I	K	KA	LC	LD	LH	LS	LT	LX	LZ	MM	NA	NN	P	S	X	Y	Z	ZZ
20	18	15.5	40	13	26	8	13	10.5	8	41	5	8	28	5	6	4	6.8	25	102	3.2	40	55	M8 x 1.25	24	M20 x 1.5	1/8	62	20	8	21	131
25	22	19.5	47	17	32	10	13	10.5	8	45	6	8	33.5	5.5	8	4	6.8	28	102	3.2	40	55	M10 x 1.25	30	M26 x 1.5	1/8	62	20	8	25	135
32	22	19.5	47	17	32	12	13	10.5	8	45	6	8	37.5	5.5	10	4	6.8	28	104	3.2	40	55	M10 x 1.25	34.5	M26 x 1.5	1/8	64	20	8	25	137
40	24	21	54	22	41	14	16	13.5	11	50	8	10	46.5	7	12	4	7	30	134	3.2	55	75	M14 x 1.5	42.5	M32 x 2	1/4	88	23	10	27	171

Rod Flange (F)

CM2YF Bore size Stroke Z

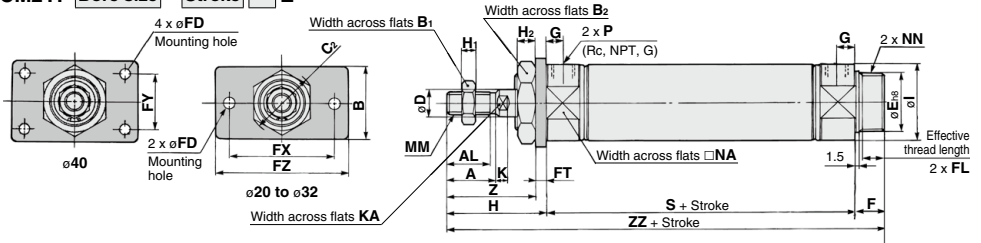

Boss-cut

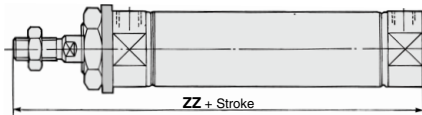

Boss-cut (mm)	
Bore size	ZZ
20	103
25	107
32	109
40	138

Female rod end

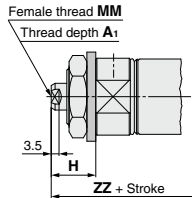

		(mm)									
Bore size	A1	H	MM	ZZ							
20	8	20	M4 x 0.7	95							
25	8	20	M5 x 0.8	95							
32	12	20	M6 x 1	97							
40	13	21	M8 x 1.25	125							

- * When female thread is used, use a thin wrench when tightening the piston rod.
- * When female thread is used, use a washer etc. to prevent the contact part at the rod end from being deformed depending on the material of the workpiece.

* Mounting bracket is shipped together with the product.

Bore size	A	AL	B	B1	B2	C2	D	E	F	FL	FD	FT	FX	FY	FZ	G	H	H1	H2	I	K	KA	MM	NA	NN	P	S	Z	ZZ
20	18	15.5	34	13	26	30	8	20 ^{0.0233}	13	10.5	7	4	60	—	75	8	41	5	8	28	5	6	M8 x 1.25	24	M20 x 1.5	1/8	62	37	116
25	22	19.5	40	17	32	37	10	26 ^{0.0233}	13	10.5	7	4	60	—	75	8	45	6	8	33.5	5.5	8	M10 x 1.25	30	M26 x 1.5	1/8	62	41	120
32	22	19.5	40	17	32	37	12	26 ^{0.0233}	13	10.5	7	4	60	—	75	8	45	6	8	37.5	5.5	10	M10 x 1.25	34.5	M26 x 1.5	1/8	64	41	122
40	24	21	52	22	41	47.3	14	32 ^{0.0219}	16	13.5	7	5	66	36	82	11	50	8	10	46.5	7	12	M14 x 1.5	42.5	M32 x 2	1/4	88	45	154

REA

REB

REC

Smooth

Low Speed

MQ

RHC

RZQ

D-□

X-□

CM2Y Series

Head Flange (G)

CM2YG –

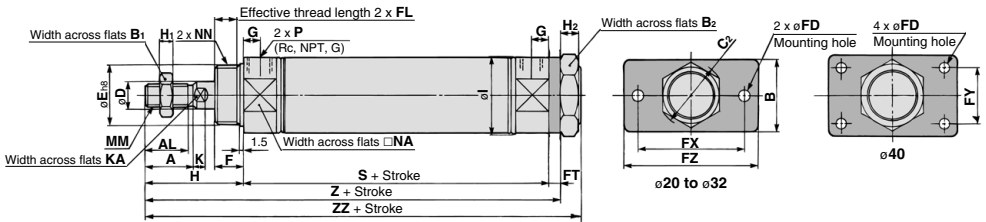

Female rod end

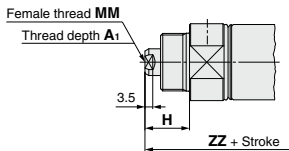

* Mounting bracket is shipped together with the product.

Bore size	A	AL	B	B ₁	B ₂	C ₂	D	E	F	FL	FD	FT	FX	FY	FZ	G	H	H ₁	H ₂	I
20	18	15.5	34	13	26	30	8	20 ⁰ _{-0.033}	13	10.5	7	4	60	—	75	8	41	5	8	28
25	22	19.5	40	17	32	37	10	26 ⁰ _{-0.033}	13	10.5	7	4	60	—	75	8	45	6	8	33.5
32	22	19.5	40	17	32	37	12	26 ⁰ _{-0.033}	13	10.5	7	4	60	—	75	8	45	6	8	37.5
40	24	21	52	22	41	47.3	14	32 ⁰ _{-0.039}	16	13.5	7	5	66	36	82	11	50	8	10	46.5

Bore size	K	KA	MM	NA	NN	P	S	Z	ZZ
20	5	6	M8 x 1.25	24	M20 x 1.5	1/8	62	107	116
25	5.5	8	M10 x 1.25	30	M26 x 1.5	1/8	62	111	120
32	5.5	10	M10 x 1.25	34.5	M26 x 1.5	1/8	64	113	122
40	7	12	M14 x 1.5	42.5	M32 x 2	1/4	88	143	154

Bore size	A ₁	H	MM	ZZ
20	8	20	M4 x 0.7	95
25	8	20	M5 x 0.8	95
32	12	20	M6 x 1	97
40	13	21	M8 x 1.25	125

* When female thread is used, use a thin wrench when tightening the piston rod.

* When female thread is used, use a washer etc. to prevent the contact part at the rod end from being deformed depending on the material of the workpiece.

Single Clevis (C)

CM2YC –

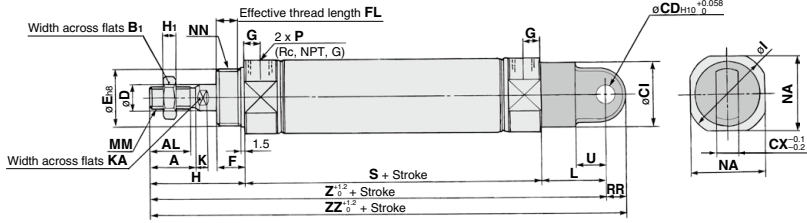

Female rod end

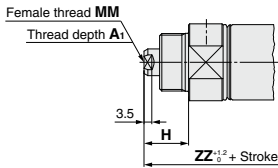

Female Rod End

Bore size	A ₁	H	MM	(ZZ)
20	8	20	M4 x 0.7	121
25	8	20	M5 x 0.8	121
32	12	20	M6 x 1	123
40	13	21	M8 x 1.25	159

- * When female thread is used, use a thin wrench when tightening the piston rod.
- * When female thread is used, use a washer etc. to prevent the contact part at the rod end from being deformed depending on the material of the workpiece.

Bore size	A	AL	B ₁	CI	CD	CX	D	E	F	FL	G	H	H ₁	I	K	KA	L	MM	NA	NN	P	RR	S	U	(Z)	(ZZ)
20	18	15.5	13	24	9	10	8	20 ⁰ _{-0.033}	13	10.5	8	41	5	28	5	6	30	M8 x 1.25	24	M20 x 1.5	1/8	9	62	14	133	142
25	22	19.5	17	30	9	10	10	26 ⁰ _{-0.033}	13	10.5	8	45	6	33.5	5.5	8	30	M10 x 1.25	30	M26 x 1.5	1/8	9	62	14	137	146
32	22	19.5	17	30	9	10	12	26 ⁰ _{-0.033}	13	10.5	8	45	6	37.5	5.5	10	30	M10 x 1.25	34.5	M26 x 1.5	1/8	9	64	14	139	148
40	24	21	22	38	10	15	14	32 ⁰ _{-0.039}	16	13.5	11	50	8	46.5	7	12	39	M14 x 1.5	42.5	M32 x 2	1/4	11	88	18	177	188

Double Clevis (D)

CM2YD –

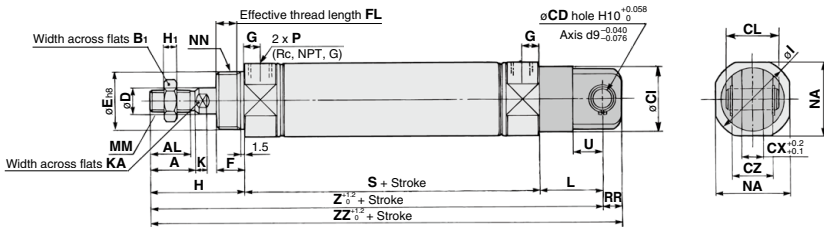

Female rod end

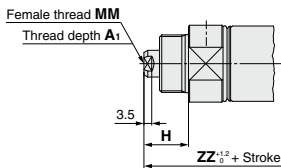

Female Rod End

Bore size	A ₁	H	MM	(ZZ)
20	8	20	M4 x 0.7	121
25	8	20	M5 x 0.8	121
32	12	20	M6 x 1	123
40	13	21	M8 x 1.25	159

- * When female thread is used, use a thin wrench when tightening the piston rod.
- * When female thread is used, use a washer etc. to prevent the contact part at the rod end from being deformed depending on the material of the workpiece.

Bore size	A	AL	B ₁	CI	CL	CX	CZ	D	E	F	FL	G	H	H ₁	I	K	KA	L	MM	NA	NN	P	RR	S	U	(Z)	(ZZ)	
20	18	15.5	13	9	24	25	10	19	8	20 ⁰ _{-0.033}	13	10.5	8	41	5	28	5	6	30	M8 x 1.25	24	M20 x 1.5	1/8	9	62	14	133	142
25	22	19.5	17	9	30	25	10	19	10	26 ⁰ _{-0.033}	13	10.5	8	45	6	33.5	5.5	8	30	M10 x 1.25	30	M26 x 1.5	1/8	9	62	14	137	146
32	22	19.5	17	9	30	25	10	19	12	26 ⁰ _{-0.033}	13	10.5	8	45	6	37.5	5.5	10	30	M10 x 1.25	34.5	M26 x 1.5	1/8	9	64	14	139	148
40	24	21	22	10	38	41.2	15	30	14	32 ⁰ _{-0.039}	16	13.5	11	50	8	46.5	7	12	39	M14 x 1.5	42.5	M32 x 2	1/4	11	88	18	177	188

* A clevis pin and retaining rings (split pins for ø40) are shipped together.

- REA
- REB
- REC
- Smooth
- Low Speed
- MQ
- RHC
- RZQ

- D
- X

CM2Y Series

Rod Trunnion (U)

CM2YU -

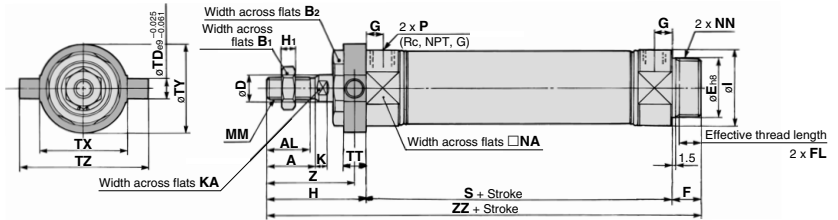

Boss-cut

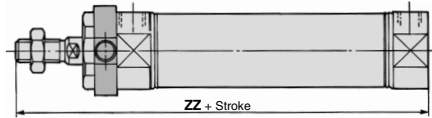

Female rod end

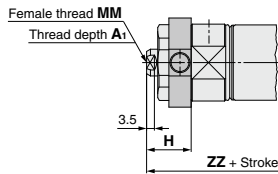

* Mounting bracket is shipped together with the product.

Bore size	A	AL	B ₁	B ₂	D	E	F	FL	G	H	H ₁	I	K	KA	MM	NA	NN	P
20	18	15.5	13	26	8	20 ⁰ _{-0.033}	13	10.5	8	41	5	28	5	6	M8 x 1.25	24	M20 x 1.5	1/8
25	22	19.5	17	32	10	26 ⁰ _{-0.033}	13	10.5	8	45	6	33.5	5.5	8	M10 x 1.25	30	M26 x 1.5	1/8
32	22	19.5	17	32	12	26 ⁰ _{-0.033}	13	10.5	8	45	6	37.5	5.5	10	M10 x 1.25	34.5	M26 x 1.5	1/8
40	24	21	22	41	14	32 ⁰ _{-0.039}	16	13.5	11	50	8	46.5	7	12	M14 x 1.5	42.5	M32 x 2	1/4

Bore size	S	TD	TT	TX	TY	TZ	Z	ZZ
20	62	8	10	32	32	52	36	116
25	62	9	10	40	40	60	40	120
32	64	9	10	40	40	60	40	122
40	88	10	11	53	53	77	44.5	154

Bore size	ZZ
20	103
25	107
32	109
40	138

Bore size	A ₁	H	MM	ZZ
20	8	20	M4 x 0.7	95
25	8	20	M5 x 0.8	95
32	12	20	M6 x 1	97
40	13	21	M8 x 1.25	125

- * When female thread is used, use a thin wrench when tightening the piston rod.
- * When female thread is used, use a washer etc. to prevent the contact part at the rod end from being deformed depending on the material of the workpiece.

Head Trunnion (T)

CM2YT -

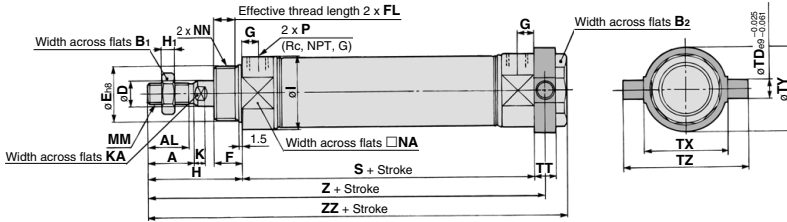

Female rod end

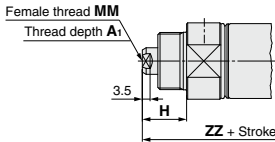

* Mounting bracket is shipped together with the product.

Bore size	A	AL	B1	B2	D	E	F	FL	G	H	H1	I	K	KA	MM	NA	NN	P
20	18	15.5	13	26	8	20 ⁰ _{-0.033}	13	10.5	8	41	5	28	5	6	M8 x 1.25	24	M20 x 1.5	1/8
25	22	19.5	17	32	10	26 ⁰ _{-0.033}	13	10.5	8	45	6	33.5	5.5	8	M10 x 1.25	30	M26 x 1.5	1/8
32	22	19.5	17	32	12	26 ⁰ _{-0.033}	13	10.5	8	45	6	37.5	5.5	10	M10 x 1.25	34.5	M26 x 1.5	1/8
40	24	21	22	41	14	32 ⁰ _{-0.039}	16	13.5	11	50	8	46.5	7	12	M14 x 1.5	42.5	M32 x 2	1/4

Bore size	S	TD	TT	TX	TY	TZ	Z	ZZ
20	62	8	10	32	32	52	108	118
25	62	9	10	40	40	60	112	122
32	64	9	10	40	40	60	114	124
40	88	10	11	53	53	77	143.5	154

Bore size	A1	H	MM	ZZ
20	8	20	M4 x 0.7	97
25	8	20	M5 x 0.8	97
32	12	20	M6 x 1	99
40	13	21	M8 x 1.25	125

- * When female thread is used, use a thin wrench when tightening the piston rod.
- * When female thread is used, use a washer etc. to prevent the contact part at the rod end from being deformed depending on the material of the workpiece.

- REA
- REB
- REC
- Smooth
- Low Speed
- MQ
- RHC
- RZQ

- D-□
- X□

CM2Y Series

Integrated Clevis (E)

CM2YE -

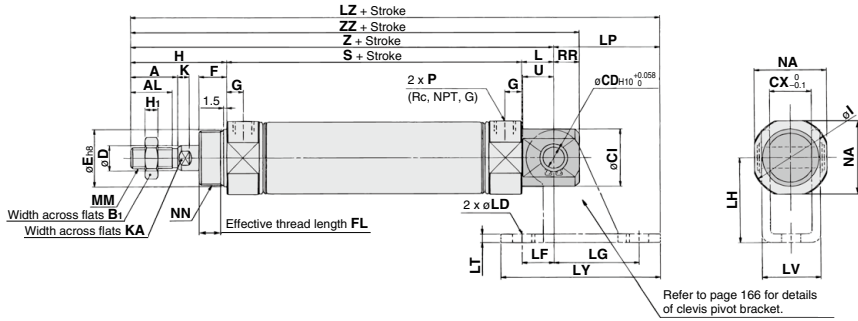

Female rod end

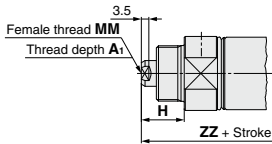

Integrated clevis (90°) (V)

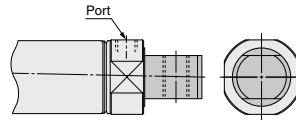

* The outer dimensions are the same as those for the integrated clevis (E).

Bore size	A	AL	B ₁	CD	CI	CX	D	E	F	FL	G	H	H ₁	I	K	KA	L	MM	NA	NN
20	18	15.5	13	8	20	12	8	20 $^{0}_{-0.033}$	13	10.5	8	41	5	28	5	6	12	M8 x 1.25	24	M20 x 1.5
25	22	19.5	17	8	22	12	10	26 $^{0}_{-0.033}$	13	10.5	8	45	6	33.5	5.5	8	12	M10 x 1.25	30	M26 x 1.5
32	22	19.5	17	10	27	20	12	26 $^{0}_{-0.033}$	13	10.5	8	45	6	37.5	5.5	10	15	M10 x 1.25	34.5	M26 x 1.5
40	24	21	22	10	33	20	14	32 $^{0}_{-0.039}$	16	13.5	11	50	8	46.5	7	12	15	M14 x 1.5	42.5	M32 x 2

Bore size	P	RR	S	U	Z	ZZ
20	1/8	9	62	11.5	115	124
25	1/8	9	62	11.5	119	128
32	1/8	12	64	14.5	124	136
40	1/4	12	88	14.5	153	165

Bore size	A ₁	H	MM	ZZ
20	8	20	M4 x 0.7	103
25	8	20	M5 x 0.8	103
32	12	20	M6 x 1	111
40	13	21	M8 x 1.25	136

- * When female thread is used, use a thin wrench when tightening the piston rod.
- * When female thread is used, use a washer etc. to prevent the contact part at the rod end from being deformed depending on the material of the workpiece.

CM2Y Series

Dimensions of Accessories

With Single Knuckle Joint

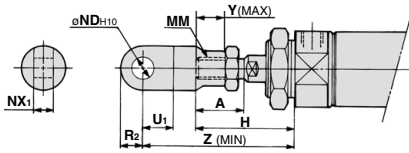

Bore size	A	H	MM	ND _{H10}	NX ₁	U ₁	R ₂	Y	Z
20	18	41	M8 x 1.25	9 ^{+0.058} ₀	9 ^{+0.1} _{-0.2}	14	10	11	66
25, 32	22	45	M10 x 1.25	9 ^{+0.058} ₀	9 ^{+0.1} _{-0.2}	14	10	14	69
40	24	50	M14 x 1.5	12 ^{+0.070} ₀	16 ^{+0.1} _{-0.3}	20	14	13	92

Single Knuckle Joint

I-020B, 032B Material: Carbon steel I-040B Material: Free-cutting steel

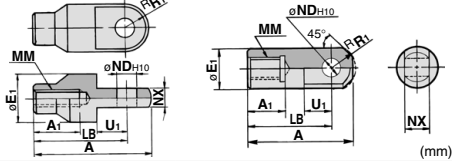

Part no.	Applicable bore size	A	A ₁	E ₁	LB	MM	ND _{H10}	NX	R ₁	U ₁
I-020B	20	46	16	20	36	M8 x 1.25	9 ^{+0.058} ₀	9 ^{+0.1} _{-0.2}	10	14
I-032B	25, 32	48	18	20	38	M10 x 1.25	9 ^{+0.058} ₀	9 ^{+0.1} _{-0.2}	10	14
I-040B	40	69	22	24	55	M14 x 1.5	12 ^{+0.070} ₀	16 ^{+0.1} _{-0.3}	15.5	20

With Double Knuckle Joint

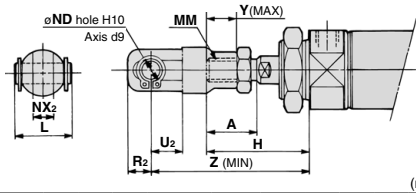

Bore size	A	H	L	MM	ND	NX ₂	R ₂	U ₂	Y	Z
20	18	41	25	M8 x 1.25	9	9 ^{+0.1} _{-0.1}	10	14	11	66
25, 32	22	45	25	M10 x 1.25	9	9 ^{+0.1} _{-0.1}	10	14	14	69
40	24	50	49.7	M14 x 1.5	12	16 ^{+0.3} _{-0.1}	13	25	13	92

Double Knuckle Joint

Y-020B, 032B Material: Carbon steel

Y-040B Material: Cast iron

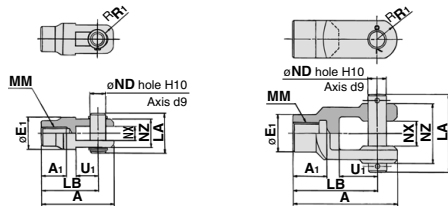

Part no.	Applicable bore size	A	A ₁	E ₁	LA	LB	MM	ND	NX	NZ	R ₁	U ₁	Included pin part number	Retaining ring size Split pin
Y-020B	20	46	16	20	25	36	M8 x 1.25	9	9 ^{+0.2} _{-0.1}	18	5	14	CDP-1	Type C 9 for axis
Y-032B	25, 32	48	18	20	25	38	M10 x 1.25	9	9 ^{+0.2} _{-0.1}	18	5	14	CDP-1	Type C 9 for axis
Y-040B	40	68	22	24	49.7	55	M14 x 1.5	12	16 ^{+0.3} _{-0.1}	38	13	25	CDP-3	ø3 x 18 L

* A knuckle pin and retaining rings (split pins for ø40) are included.

Double Clevis Pin / Material: Carbon steel (mm)

Bore size/ø20, ø25, ø32
CDP-1

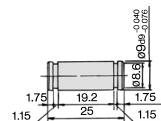

Retaining ring: Type C9 for axis

Bore size/ø40
CDP-2

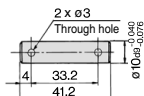

Split pin: ø3 x 18 L

Double Knuckle Pin / Material: Carbon steel (mm)

Bore size/ø20, ø25, ø32
CDP-1

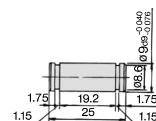

Retaining ring: Type C9 for axis

Bore size/ø40
CDP-3

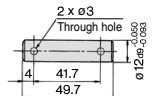

Split pin: ø3 x 18 L

* Retaining rings (split pins for ø40) are included.

* Retaining rings (split pins for ø40) are included.

- REA
- REB
- REC
- Smooth
- Low Speed
- MQ
- RHC
- RZQ

- D-□
- X□

CM2Y Series

Rod End Nut

Material: Carbon steel

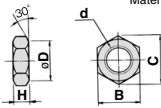

Part no.	Applicable bore size	B	C	D	d	H
NT-02	20	13	15.0	12.5	M8 x 1.25	5
NT-03	25, 32	17	19.6	16.5	M10 x 1.25	6
NT-04	40	22	25.4	21.0	M14 x 1.5	8

Mounting Nut

Material: Carbon steel

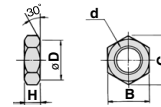

Part no.	Applicable bore size	B	C	D	d	H
SN-020B	20	26	30	25.5	M20 x 1.5	8
SN-032B	25, 32	32	37	31.5	M26 x 1.5	8
SN-040B	40	41	47.3	40.5	M32 x 2.0	10

Trunnion Nut

Material: Carbon steel

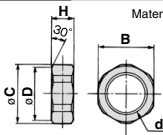

Part no.	Applicable bore size	B	C	D	d	H
TN-020B	20	26	28	25.5	M20 x 1.5	10
TN-032B	25, 32	32	34	31.5	M26 x 1.5	10
TN-040B	40	41	45	40.5	M32 x 2	10

Mounting Brackets, Rod End Brackets, and Nut Material: Stainless Steel

Part No. (Dimensions: Same as standard type)

Bore size (mm)	Foot	Flange	Single knuckle joint	Double knuckle joint*	Mounting nut	Rod end nut
20	CM-L020BSUS	CM-F020BSUS	I-020BSUS	Y-020BSUS	SN-020BSUS	NT-02SUS
25, 32	CM-L032BSUS	CM-F032BSUS	I-032BSUS	Y-032BSUS	SN-032BSUS	NT-03SUS
40	CM-L040BSUS	CM-F040BSUS	I-040BSUS	Y-040BSUS	SN-040BSUS	NT-04SUS

* A knuckle pin and retaining rings are shipped together. Refer to the XC27 for details on stainless steel double clevis pins and double knuckle pins. The accessories need to be ordered separately from the cylinder.

Clevis Pivot Bracket (For CM2YE(V))

Material: Carbon steel

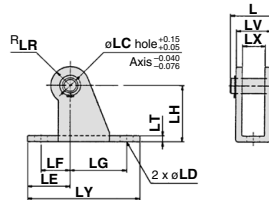

Part no.	Applicable bore size	L	LC	LD	LE	LF	LG	LH	LR	LT	LX	LY	LV	Included pin part no.
CM-E020B	20, 25	24.5	8	6.8	22	15	30	30	10	3.2	12	59	18.4	CD-S02
CM-E032B	32, 40	34	10	9	25	15	40	40	13	4	20	75	28	CD-S03

Note 1) A clevis pivot bracket pin and retaining rings are included.
 Note 2) It cannot be used for the single clevis (CM2YC) and the double clevis (CM2YD).

Clevis Pivot Bracket Pin (For CM2YE(V))

Material: Carbon steel

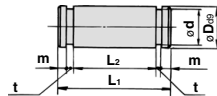

Part no.	Applicable bore size	D ₉₉	d	L ₁	L ₂	m	t	Included retaining ring
CD-S02	20, 25	8 ^{+0.040/-0.076}	7.6	24.5	19.5	1.6	0.9	Type C 8 for axis
CD-S03	32, 40	10 ^{+0.040/-0.076}	9.6	34	29	1.35	1.15	Type C 10 for axis

Note) Retaining rings are included.

With Single Clevis

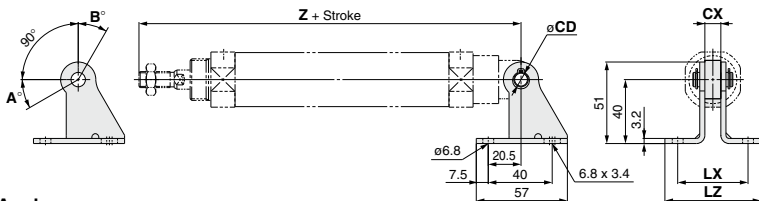

Rotation Angle

Bore size (mm)	A°	B°	A° + B° + 90°
20	25	85	200
25, 32	21	81	192
40	26	86	202

Mounting	Part no.	Applicable bore size	CX	Z + Stroke	CD	LX	LZ
CM2YC (Single clevis)	CM-B032	20	10	133	9	44	60
		25		137			
		32		139			
	CM-B040	40	15	177	10	49	65

Note) A pivot bracket pin and retaining rings are not included with the pivot bracket.

With Rod Trunnion

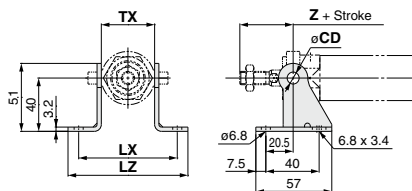

With Head Trunnion

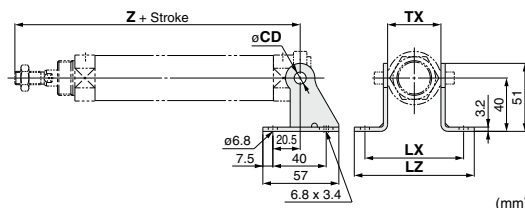

Mounting	Part no.	Applicable bore size	TX	Rod trunnion	Head trunnion	CD	LX	LZ
				Z + Stroke	Z + Stroke			
CM2YU/CM2YT (Rod/Head trunnion)	CM-B020	20	32	36	108	8	66	82
		25	40	40	112	9	74	90
	CM-B032	32	53	44.5	114	10	87	103
		40			143.5			

Note) A pivot bracket pin and retaining rings are not included with the pivot bracket.

Pivot Bracket

* Pivot brackets consists of a set of two brackets.

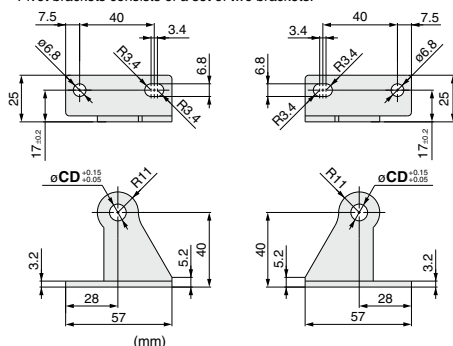

Part no.	CD
CM-B020 (Note 2)	8
CM-B032	9
CM-B040	10

Note 1) A pivot bracket pin and retaining rings are not included with the pivot bracket.
Note 2) Only for the trunnion

Pivot Bracket Pin (For CM2YC)

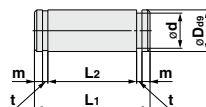

Applicable bore size	Part no.	D ₉₉	d	L ₁	L ₂	m	t	Included retaining ring
20 to 32	CDP-1	9 ^{+0.040} _{-0.078}	8.6	25	19.2	1.75	1.15	Type C 9 for axis
40	CD-S03	10 ^{+0.040} _{-0.078}	9.6	34	29	1.35	1.15	Type C 10 for axis

Note) Retaining rings are included with the pivot bracket pin.

REA

REB

REC

Smooth

Low Speed

MQ

RHC

RZQ

CM2Y Series Auto Switch Mounting

Auto Switch Proper Mounting Position (Detection at stroke end) and Its Mounting Height

Solid state auto switch

- D-M9□
- D-M9□W
- D-M9□A

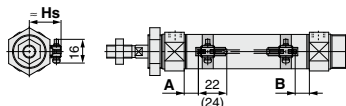

() : Dimension of the D-M9□A

A and B are the dimensions from the end of the head cover/rod cover to the end of the auto switch.

- D-M9□V
- D-M9□WV
- D-M9□AV

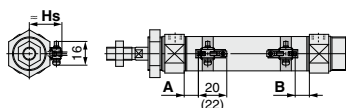

() : Dimension of the D-M9□AV

A and B are the dimensions from the end of the head cover/rod cover to the end of the auto switch.

D-H7□/H7□W/H7NF/H7BA/H7C

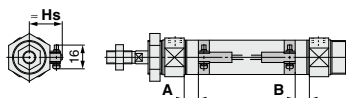

D-G5NT

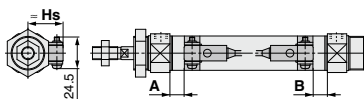

D-G39A/K39A

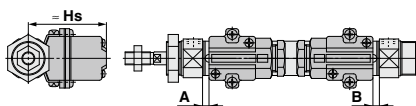

Reed auto switch

D-A9□

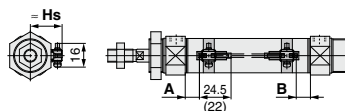

() : Dimension of the D-A96

A and B are the dimensions from the end of the head cover/rod cover to the end of the auto switch.

D-A9□V

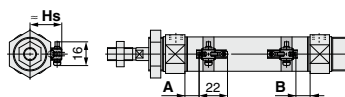

A and B are the dimensions from the end of the head cover/rod cover to the end of the auto switch.

D-C7/C8/C73C/C80C

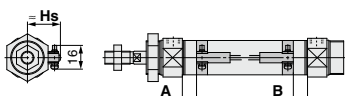

D-B5/B6/B59W

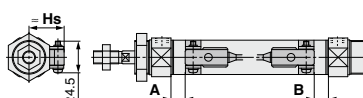

D-A33A/A34A

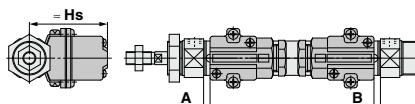

D-A44A

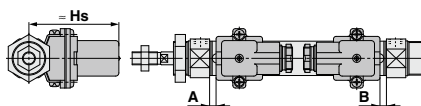

Auto Switch Proper Mounting Position (Detection at stroke end) and Its Mounting Height

Auto Switch Proper Mounting Position

(mm)

Auto switch model	D-M9□(V) D-M9□W(V) D-M9□A(V)		D-A9□(V)		D-B5□ D-B64		D-C7□ D-C80 D-C73C D-C80C		D-B59W		D-A3□A D-G39A D-K39A D-A44A		D-H7□ D-H7C D-H7□W D-H7NF		D-G5NT	
	A	B	A	B	A	B	A	B	A	B	A	B	A	B	A	B
Bore size																
20	11	9.5	7	5.5	1.5	0	7.5	6	4	2.5	1	0	6.5	5	3	1.5
25	10	10	6	6	0.5	0.5	6.5	6.5	3.5	3.5	0	0	5.5	5.5	2	2
32	11.5	10.5	7.5	6.5	2	1	8	7	5	4	1.5	0.5	7	6	3.5	2.5
40	17.5	15.5	13.5	11.5	8	6	14	12	11	9	7.5	5.5	13	11	9.5	7.5

Note) Adjust the auto switch after confirming the operating condition in the actual setting.

Auto Switch Mounting Height

(mm)

Auto switch model	D-M9□V D-M9□WV D-M9□AV D-A9□V		D-B5□ D-B64 D-B59W D-G5NT D-H7C		D-M9□W D-M9□A D-A9□ D-C7□ D-C80 D-H7□ D-H7NF		D-C73C D-C80C		D-A3□A D-G39A D-K39A		D-A44A	
	Hs	Hs	Hs	Hs	Hs	Hs	Hs	Hs	Hs	Hs	Hs	
Bore size												
20	23.5	25.5	22.5	25	60	69.5						
25	26	28	25	27.5	62.5	72						
32	29.5	31.5	28.5	31	66	75.5						
40	33.5	35.5	32.5	35	70	79.5						

REA

REB

REC

Smooth

Low Speed

MQ

RHC

RZQ

D-□

-X□

Minimum Stroke for Auto Switch Mounting

Auto switch model	(mm)				
	With 1 pc.	With 2 pcs.		With n pcs. (n: Number of auto switches)	
		Different surfaces	Same surface	Different surfaces	Same surface
D-M9□	5	15 <small>Note 1)</small>	40 <small>Note 1)</small>	$20 + 35 \frac{(n-2)}{2}$ <small>(n = 2, 4, 6...)^{Note 3)}</small>	$55 + 35 (n-2)$ <small>(n = 2, 3, 4, 5...)</small>
D-M9□W	10	15 <small>Note 1)</small>	40 <small>Note 1)</small>	$20 + 35 \frac{(n-2)}{2}$ <small>(n = 2, 4, 6...)^{Note 3)}</small>	$55 + 35 (n-2)$ <small>(n = 2, 3, 4, 5...)</small>
D-M9□A	10	25	40 <small>Note 1)</small>	$25 + 35 \frac{(n-2)}{2}$ <small>(n = 2, 4, 6...)^{Note 3)}</small>	$60 + 35 (n-2)$ <small>(n = 2, 3, 4, 5...)</small>
D-A9□	5	15	30	$15 + 35 \frac{(n-2)}{2}$ <small>(n = 2, 4, 6...)^{Note 3)}</small>	$50 + 35 (n-2)$ <small>(n = 2, 3, 4, 5...)</small>
D-M9□V	5	20	35	$20 + 35 \frac{(n-2)}{2}$ <small>(n = 2, 4, 6...)^{Note 3)}</small>	$35 + 35 (n-2)$ <small>(n = 2, 3, 4, 5...)</small>
D-A9□V	5	15	25	$15 + 35 \frac{(n-2)}{2}$ <small>(n = 2, 4, 6...)^{Note 3)}</small>	$25 + 35 (n-2)$ <small>(n = 2, 3, 4, 5...)</small>
D-M9□WV D-M9□AV	10	20	35	$20 + 35 \frac{(n-2)}{2}$ <small>(n = 2, 4, 6...)^{Note 3)}</small>	$35 + 35 (n-2)$ <small>(n = 2, 3, 4, 5...)</small>
D-C7□ D-C80	10	15	50	$15 + 45 \frac{(n-2)}{2}$ <small>(n = 2, 4, 6...)^{Note 3)}</small>	$50 + 45 (n-2)$ <small>(n = 2, 3, 4, 5...)</small>
D-H7□ D-H7□W D-H7NF	10	15	60	$15 + 45 \frac{(n-2)}{2}$ <small>(n = 2, 4, 6...)^{Note 3)}</small>	$60 + 45 (n-2)$ <small>(n = 2, 3, 4, 5...)</small>
D-C73C D-C80C D-H7C	10	15	65	$15 + 50 \frac{(n-2)}{2}$ <small>(n = 2, 4, 6...)^{Note 3)}</small>	$65 + 50 (n-2)$ <small>(n = 2, 3, 4, 5...)</small>
D-B5□/B64 D-G5NT	10	15	75	$15 + 50 \frac{(n-2)}{2}$ <small>(n = 2, 4, 6...)^{Note 3)}</small>	$75 + 55 (n-2)$ <small>(n = 2, 3, 4, 5...)</small>
D-B59W	15	20	75	$20 + 50 \frac{(n-2)}{2}$ <small>(n = 2, 4, 6...)^{Note 3)}</small>	$75 + 55 (n-2)$ <small>(n = 2, 3, 4, 5...)</small>
D-A3□A/G39A D-K39A/A44A	10	35	100	$35 + 30 (n-2)$ <small>(n = 2, 3, 4, 5...)</small>	$100 + 100 (n-2)$ <small>(n = 2, 3, 4, 5...)</small>

Note 3) When "n" is an odd number, an even number that is one larger than this odd number is used for the calculation.

Note 1) Auto switch mounting

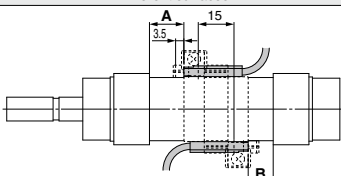
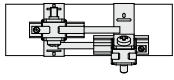
Auto switch model	With 2 auto switches	
	Different surfaces	Same surface
	 <p>The proper auto switch mounting position is 3.5 mm inward from the switch holder edge.</p>	 <p>The auto switch is mounted by slightly displacing it in a direction (cylinder tube circumferential exterior) so that the auto switch and lead wire do not interfere with each other.</p>
D-M9□ D-M9□W	Less than 20 stroke <small>Note 2)</small>	Less than 55 stroke <small>Note 2)</small>
D-M9□A	Less than 25 stroke <small>Note 2)</small>	Less than 60 stroke <small>Note 2)</small>
D-A9□	—	Less than 50 stroke <small>Note 2)</small>

Note 2) Minimum stroke for auto switch mounting in types other than those in Note 1.

Operating Range

Auto switch model	(mm)				Auto switch model	(mm)			
	20	25	32	40		20	25	32	40
D-M9□(V)	3.5	3	3.5	3	D-B59W	12	12	13	13
D-M9□W(V)					D-H7□/H7□W	4	4	4.5	5
D-M9□A(V)					D-G5NT/H7NF	7	8.5	9	10
D-A9□(V)	6	6	6	6	D-H7C	8	9	9	9
D-C7□/C80 D-C73C/C80C	7	8	8	8	D-G39A/K39A				
D-B5□/B64 D-A3□A/A44A	8	8	9	9					

* Values which include hysteresis are for guideline purposes only, they are not a guarantee (assuming approximately ±30% dispersion) and may change substantially depending on the ambient environment.
Note) The D-A9□ and D-A9□V cannot be mounted on ø50.

Auto Switch Mounting Brackets/Part No.

Auto switch model	Bore size (mm)			
	ø20	ø25	ø32	ø40
D-M9□(V) D-M9□W(V) D-A9□(V)	BM5-020 (A set of a, b, c, d)	BM5-025 (A set of a, b, c, d)	BM5-032 (A set of a, b, c, d)	BM5-040 (A set of a, b, c, d)
D-M9□A(V)	BM5-020S (A set of b, c, d, e)	BM5-025S (A set of b, c, d, e)	BM5-032S (A set of b, c, d, e)	BM5-040S (A set of b, c, d, e)

D-C7□/C80 D-C73C/C80C D-H7□ D-H7□W D-H7NF	BM2-020A (A set of band and screw)	BM2-025A (A set of band and screw)	BM2-032A (A set of band and screw)	BM2-040A (A set of band and screw)
D-H7BA	BM2-020AS (A set of band and screw)	BM2-025AS (A set of band and screw)	BM2-032AS (A set of band and screw)	BM2-040AS (A set of band and screw)
D-B5□/B64 D-B59W D-G5NT	BA2-020 (A set of band and screw)	BA2-025 (A set of band and screw)	BA2-032 (A set of band and screw)	BA2-040 (A set of band and screw)
D-A3□A/A44A Note 3) D-G39A/K39A	BM3-020 (A set of band and screw)	BM3-025 (A set of band and screw)	BM3-032 (A set of band and screw)	BM3-040 (A set of band and screw)

Note 1) Since the switch bracket (made from nylon) are affected in an environment where alcohol, chloroform, methylamines, hydrochloric acid or sulfuric acid is splashed over, so it cannot be used. Please contact SMC regarding other chemicals.

Note 2) Avoid the indicator LED for mounting the switch bracket. As the indicator LED is projected from the switch unit, indicator LED may be damaged if the switch bracket is fixed on the indicator LED.

Note 3) The D-A3□A/A44A/G39A/K39A cannot be mounted on the CDM2□□ series centralized piping type.

Band Mounting Brackets Set Part No.

Set part no.	Contents
BM2-□□□A(S) * S: Stainless steel screw	<ul style="list-style-type: none"> •Auto switch mounting band (c) •Auto switch mounting screw (d)
BJ4-1	<ul style="list-style-type: none"> •Switch bracket (White/PBT) (e) •Switch holder (b)
BJ5-1	<ul style="list-style-type: none"> •Switch bracket (Transparent/Nylon) (a) •Switch holder (b)

Other than the applicable auto switches listed in “How to Order”, the following auto switches are mountable.

Refer to pages 941 to 1067 for the detailed specifications.

Type	Model	Electrical entry	Features
Solid state	D-H7A1/H7A2/H7B	Grommet (In-line)	—
	D-H7NW/H7PW/H7BW		Diagnostic indication (2-color indicator)
	D-H7BA		Water resistant (2-color indicator)
	D-G5NT		With timer
Reed	D-B53/C73/C76		—
	D-C80	Without indicator light	

* With pre-wired connector is also available for solid state auto switches. For details, refer to pages 1014 and 1015.

* Normally closed (NC = b contact) solid state auto switches (D-M9□E(V)) are also available. For details, refer to page 1592-1.

REA

REB

REC

Smooth

Low Speed

MQ

RHC

RZQ

D-□

-X□

Smooth Cylinder

CG1Y Series

RoHS

ø20, ø25, ø32, ø40, ø50, ø63, ø80, ø100

How to Order

CG1Y B 25 - 100 Z - - -

With auto switch CDG1Y B 25 - 100 Z - - - M9BW - - -

With auto switch (Built-in magnet)

Mounting

B	Basic
Z*	Basic (without trunnion mounting female thread)
L	Axial foot
F	Rod flange
G	Head flange
U*	Rod trunnion
T*	Head trunnion
D	Clevis

Bore size

20	20 mm
25	25 mm
32	32 mm
40	40 mm
50	50 mm
63	63 mm
80	80 mm
100	100 mm

Port thread type

Nil	Rc	ø20 to ø100
TN	NPT	ø20 to ø100
TF	M5 x 0.8	ø20, ø25
	G	ø32 to ø100

Rod end thread

Nil	Male rod end
F	Female rod end

Pivot bracket

Nil	None
N	Pivot bracket is shipped together with the product.

Rod end bracket

Nil	None
V	Single knuckle joint
W	Double knuckle joint

Made to Order
Refer to page 173 for details.

Number of auto switches

Nil	2 pcs.
S	1 pc.
n	"n" pcs.

Auto switch

Nil	Without auto switch
------------	---------------------

* Not available for ø80 or ø100.
* Mounting bracket is shipped together with the product, but not assembled.
* The cylinder for F, G, L, D mounting types is Z: Basic (without trunnion mounting female thread).

Cylinder stroke (mm)
Refer to "Standard Strokes" on page 173.

* Refer to "Ordering Example of Cylinder Assembly" on page 173.

Built-in Magnet Cylinder Model

If a built-in magnet cylinder without an auto switch is required, there is no need to enter the symbol for the auto switch. (Example) CDG1YB32-150Z

Applicable Auto Switches/Refer to pages 941 to 1067 for further information on auto switches.

Type	Special function	Electrical entry	Indicator light	Wiring (Output)	Load voltage		Auto switch model Applicable bore size			Lead wire length (m)					Pre-wired connector	Applicable load			
					DC	AC	ø20 to ø63	ø80, ø100	0.5 (Nil)	1 (M)	3 (L)	5 (Z)	None (N)						
Solid state auto switch	Diagnostic indication (2-color indicator)	Grommet	Yes	3-wire (NPN)	24 V	5 V, 12 V	—	Perpendicular	In-line	In-line	●	●	●	○	○	○	IC circuit	Relay, PLC	
								M9NV	M9N	G59	●	●	●	○	○	○			
				M9PV				M9P	G5P	●	●	●	○	○	○				
		M9BV		M9B				K59	●	●	●	○	○	○					
		—		H7C				—	●	●	●	○	○	○					
		M9NVV		M9NV				G59W	●	●	●	○	○	○					
	Water resistant (2-color indicator)	Grommet	Yes	3-wire (NPN)	24 V	5 V, 12 V	—	—	Perpendicular	In-line	In-line	●	●	●	○	○	○		IC circuit
									M9PAV ^{#1}	M9PA ^{#1}	—	○	○	○	○	○	○		
				M9BAV ^{#1}					M9BA ^{#1}	—	○	○	○	○	○	○			
		—		G5BA ^{#1}					—	●	●	●	○	○	○				
		—		H7NF					G59F	●	●	●	○	○	○				
		—		A96V					A96	●	●	●	○	○	○				
Feed auto switch	Grommet	No	2-wire	24 V	12 V	—	—	Perpendicular	In-line	In-line	●	●	●	○	○	○	IC circuit		
								A93V ^{#2}	A93	—	●	●	●	○	○	○			
								A90V	A90	—	●	●	●	○	○	○			
	—							B54	—	●	●	●	○	○	○				
	—							B64	—	●	●	●	○	○	○				
	—							C73C	—	●	●	●	○	○	○				
Connector	No	2-wire	24 V	12 V	—	—	—	Perpendicular	In-line	In-line	●	●	●	○	○	○	IC circuit		
								—	C80C	—	●	●	●	○	○	○			
								—	B59W	—	●	●	●	○	○	○			

*1 Water resistant type auto switches can be mounted on the above models, but in such case SMC cannot guarantee the water resistance. Please consult with SMC regarding water resistant types with the above model numbers.

*2 1 m type lead wire is only applicable to D-A93.

* Lead wire length symbols: 0.5 m..... Nil (Example) M9NW
1 m..... M (Example) M9NWM
3 m..... L (Example) M9NLW
5 m..... Z (Example) M9NZW
None..... N (Example) H7CN

* Solid state auto switches marked with "○" are produced upon receipt of order.

* Since there are other applicable auto switches than listed, refer to page 182 for details.

* For details about auto switches with pre-wired connector, refer to pages 1014 and 1015.

* The D-A9□□M9□□□ auto switches are shipped together, (but not assembled). (However, only the auto switch mounting brackets are assembled before shipment.)



Symbol

Rubber bumper

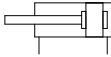

Made to Order
[Click here for details](#)

Symbol	Specifications
-XA□	Change of rod end shape
-XC6	Made of stainless steel

Replacement Parts/Seal Kit

Bore size (mm)	Kit no.	Contents
20	CG1Y20Z-PS	Piston seal 1 pc.
25	CG1Y25Z-PS	Rod seal 1 pc.
32	CG1Y32Z-PS	Tube gasket 1 pc.
40	CG1Y40Z-PS	Grease pack (10 g) 1 pc.

When maintenance requires only grease, use the following part numbers to order.

Grease pack part number: GR-L-005 (5 g)
 GR-L-010 (10 g)
 GR-L-150 (150 g)

Specifications

Bore size (mm)		20	25	32	40	50	63	80	100	
Action		Double acting, Single rod								
Type		Non-lube								
Fluid		Air								
Proof pressure		1.05 MPa								
Maximum operating pressure		0.7 MPa								
Ambient and fluid temperature		Without auto switch: -10°C to 70°C With auto switch: -10°C to 60°C (No freezing)								
Piston speed		5 to 500 mm/s								
Stroke length tolerance		Up to 1000 ^{+1.4} ₀ mm, Up to 1500 ^{+1.8} ₀ mm								
Cushion		Rubber bumper								
Mounting		Basic, Basic (without trunnion mounting female thread), Axial foot, Rod flange, Head flange, Rod trunnion, Head trunnion, Clevis (used for changing the port location by 90°)								
Allowable leakage rate		0.5 L/min (ANR) or less								
Allowable kinetic energy (J)	Rubber bumper	Male rod end	0.28	0.41	0.66	1.20	2.00	3.40	5.90	9.90
		Female rod end	0.11	0.18	0.29	0.52	0.91	1.54	2.71	4.54

* Cylinder sizes ø80 and ø100 do not have rod trunnion and head trunnion types.
 Foot, flange and clevis types of cylinder sizes from ø20 to ø63 do not have trunnion mounting female thread.
 Operate the cylinder within the allowable kinetic energy.

Minimum Operating Pressure

Bore size (mm)		20	25	32	40	50	63	80	100
Minimum operating pressure		0.02				0.01			

Unit: MPa

Standard Strokes

Bore size (mm)	Standard stroke (mm) Note 1)	Max. manufacturable stroke (mm)
20	25, 50, 75, 100, 125, 150, 200	Up to 1500
25, 32, 40, 50, 63, 80, 100	25, 50, 75, 100, 125, 150, 200, 250, 300	Up to 1500

Note 1) Intermediate strokes not listed above are also available.

Note 2) Applicable strokes should be confirmed according to the usage. For details, refer to "Air Cylinders Model Selection" on front matter pages of the Best Pneumatics No. 2-1. In addition, the products that exceed the standard stroke might not be able to fulfill the specifications due to the deflection etc.

Ordering Example of Cylinder Assembly

Cylinder model: **CDG1YD20-100Z-NW-M9BW**

Mounting D: Clevis
Pivot bracket N: Yes
Rod end bracket W: Double knuckle joint
Auto switch D-M9BW: 2 pcs.

* Pivot bracket, double knuckle joint and auto switch are shipped together with the product, but not assembled.

REA

REB

REC

Smooth

Low Speed

MQ

RHC

RZQ

D-□

-X□

Mounting Brackets/Part No.

Mounting bracket	Order qty	Bore size (mm)								Contents
		20	25	32	40	50	63	80	100	
Foot	2 (Note)	CG-L020	CG-L025	CG-L032	CG-L040	CG-L050	CG-L063	CG-L080	CG-L100	2 foots, 8 mounting bolts
Flange	1	CG-F020	CG-F025	CG-F032	CG-F040	CG-F050	CG-F063	CG-F080	CG-F100	1 flange, 4 mounting bolts
Trunnion pin	1	CG-T020	CG-T025	CG-T032	CG-T040	CG-T050	CG-T063	—	—	2 trunnion pins, 2 trunnion bolts, 2 flat washers
Clevis	1	CG-D020	CG-D025	CG-D032	CG-D040	CG-D050	CG-D063	CG-D080	CG-D100	1 clevis, 4 mounting bolts, 1 clevis pin, 2 retaining rings
Pivot bracket	1	CG-020/24A	CG-025/24A	CG-032/24A	CG-040/24A	CG-050/24A	CG-063/24A	CG-080/24A	CG-100/24A	1 pivot bracket

(Note) Order two foots per cylinder.

Accessory

- * For details about the single knuckle joint, double knuckle joint, knuckle pin, clevis pin, and rod end nut, refer to page 178.
- * Stainless steel mounting brackets and accessories are also available. Refer to page 178-1 for details.

Weights

		(mm)							
Bore size (mm)		20	25	32	40	50	63	80	100
Basic weight	Basic	0.11	0.18	0.28	0.44	0.83	1.17	2.23	3.43
	Axial foot	0.22	0.31	0.44	0.66	1.31	1.89	3.19	5.18
	Flange	0.19	0.28	0.42	0.64	1.17	1.67	2.94	4.78
	Trunnion	0.12	0.20	0.31	0.49	0.97	1.31	—	—
	Clevis	0.16	0.26	0.43	0.67	1.23	1.85	2.94	4.71
Pivot bracket		0.08	0.09	0.17	0.25	0.44	0.80	0.98	1.75
Single knuckle joint		0.05	0.09	0.09	0.10	0.22	0.22	0.39	0.57
Double knuckle joint (with pin)		0.05	0.09	0.09	0.13	0.26	0.26	0.64	1.31
Additional weight per 50 mm of stroke		0.05	0.07	0.09	0.15	0.22	0.26	0.35	0.49
Weight reduction for female rod end		-0.01	-0.02	-0.02	-0.05	-0.10	-0.10	-0.18	-0.27

Calculation (Example) **CG1YL20-100Z** (Foot, ø20, 100 st)

- Basic weight 0.22 (Foot, ø20)
- Additional weight 0.05/50 stroke
- Air cylinder stroke 100 stroke

$$0.22 + 0.05 \times 100/50 = 0.32 \text{ kg}$$

Mounting Procedure

Mounting procedure for trunnion

Follow the procedures below when mounting a pivot bracket on the trunnion.

ø20 to ø63

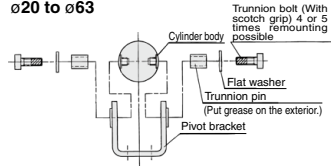

Mounting procedure for clevis

Follow the procedures below when mounting a pivot bracket on the clevis.

ø20 to ø63

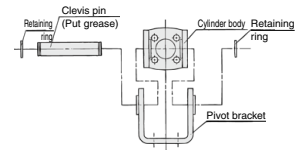

ø80, ø100

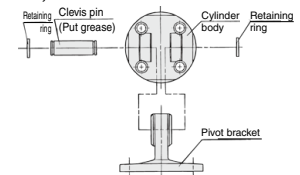

⚠ Precautions

Be sure to read this before handling the products.

Refer to back page 50 for Safety Instructions and pages 3 to 12 for Actuator and Auto Switch Precautions.

Operating Precautions

⚠ Warning

1. Operate within the specified cylinder speed.
Otherwise, cylinder and seal damage may occur.
2. When the cylinder is used as mounted with a single side fixed or free (basic, flange types), a bending moment will be applied to the cylinder due to the vibration generated at the stroke end, and the cylinder may be damaged. In such a case, mount a bracket to reduce the vibration of the cylinder or use the cylinder at a piston speed low enough to prevent the cylinder from vibrating at the stroke end.

⚠ Caution

1. Tighten clevis bracket mounting bolts with the following proper tightening torque.
ø20: 1.5 N·m, ø25 to 32: 2.9 N·m, ø40: 4.9 N·m, ø50: 11.8 N·m, ø63 to 80: 24.5 N·m, ø100: 42.2 N·m

Disassembly/Replacement

⚠ Caution

1. Do not replace the bushings.
The bushings are press-fit. To replace them, they must be replaced together with the cover assembly.
2. To replace a seal, apply grease to the new seal before installing it.
If the cylinder is put into operation without applying grease to the seal, it could cause the seal to wear significantly, leading to premature air leakage.
3. Cylinders with ø50 or larger bore sizes cannot be disassembled.
When disassembling cylinders with bore sizes of ø20 through ø40, grip the double flat part of either the head cover or the rod cover with a vise and loosen the other side with a wrench or a monkey wrench etc., and then remove the cover. When retightening, tighten approximately 2 degrees more than the original position. (Cylinders with ø50 or larger bore sizes are tightened with a large tightening torque and cannot be disassembled. If disassembly is required, please contact SMC.)

Dimensions: $\phi 20$ to $\phi 100$

Basic: CG1YB

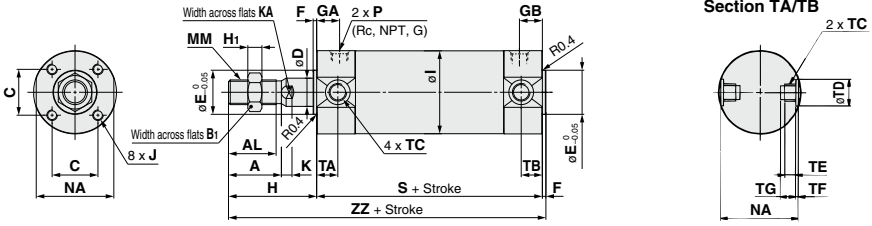

Female rod end

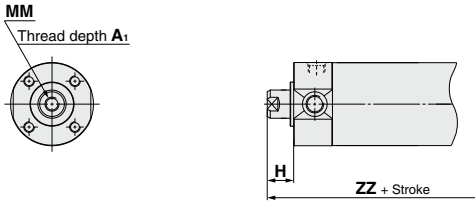

Section TA/TB

Bore size (mm)	*TC	TD	TE	TF	TG
20	M5 x 0.8	$8^{+0.08}_0$	4	0.5	5.5
25	M6 x 0.75	$10^{+0.08}_0$	5	1	6.5
32	M8 x 1.0	$12^{+0.08}_0$	5.5	1	7.5
40	M10 x 1.25	$14^{+0.08}_0$	6	1.25	8.5
50	M12 x 1.25	$16^{+0.08}_0$	7.5	2	10
63	M14 x 1.5	$18^{+0.08}_0$	11.5	3	14.5

* Cylinder sizes $\phi 80$ and $\phi 100$ do not have trunnion mounting female thread on the width across flats NA.

Bore size (mm)	Stroke range (mm)	A	AL	B ₁	C	D	E	F	H	H ₁	I	J	K	KA	MM	NA
20	Up to 1500	18	15.5	13	14	8	12	2	35	5	26	M4 x 0.7 depth 7	5	6	M8 x 1.25	24
25		22	19.5	17	16.5	10	14	2	40	6	31	M5 x 0.8 depth 7.5	5.5	8	M10 x 1.25	29
32		22	19.5	17	20	12	18	2	40	6	38	M5 x 0.8 depth 8	5.5	10	M10 x 1.25	35.5
40		30	27	19	26	16	25	2	50	8	47	M6 x 1 depth 12	6	14	M14 x 1.5	44
50		35	32	27	32	20	30	2	58	11	58	M8 x 1.25 depth 16	7	18	M18 x 1.5	55
63		35	32	27	38	20	32	2	58	11	72	M10 x 1.5 depth 16	7	18	M18 x 1.5	69
80		40	37	32	50	25	40	3	71	13	89	M10 x 1.5 depth 22	10	22	M22 x 1.5	86
100		40	37	41	60	30	50	3	71	16	110	M12 x 1.75 depth 22	10	26	M26 x 1.5	106

Bore size (mm)	Stroke range (mm)	S	TA	TB	ZZ	Rc, NPT port			G port		
						GA	GB	P	GA	GB	P
						20	77	11	11	114	12
25	77	11	11	119	12	12	1/8	12.5	12.5	M5 x 0.8	
32	79	11	11	121	12	12	1/8	10.5	10.5	1/8	
40	87	12	12	139	13	13	1/8	13	10	1/8	
50	102	13	13	162	14	14	1/4	14	14	1/4	
63	102	13	13	162	14	14	1/4	14	14	1/4	
80	122	—	—	196	20	20	3/8	17.5	17.5	3/8	
100	122	—	—	196	20	20	1/2	17.5	17.5	1/2	

Female Rod End

Bore size	A ₁	H	MM	ZZ
20	8	13	M4 x 0.7	92
25	8	14	M5 x 0.8	93
32	12	14	M6 x 1	95
40	13	15	M8 x 1.25	104
50	18	16	M10 x 1.5	120
63	18	16	M10 x 1.5	120
80	21	19	M14 x 1.5	144
100	25	22	M16 x 1.5	147

* When female thread is used, use a washer etc. to prevent the contact part at the rod end from being deformed depending on the material of the workpiece.

REA

REB

REC

Smooth

Low Speed

MQ

RHC

RZQ

CG1Y Series

Mounting Bracket

Axial foot: CG1YL

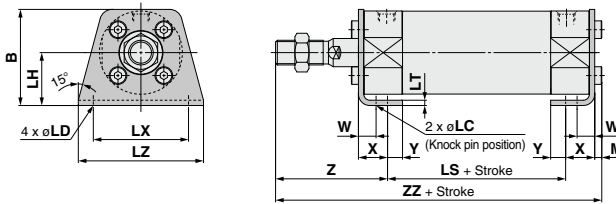

Axial Foot

Bore size (mm)	B	LC	LD	LH	LS	LT	LX	LZ	M	W	X	Y	Z	ZZ
20	34	4	6	20	53	3	32	44	3	10	15	7	47	118
25	38.5	4	6	22	53	3	36	49	3.5	10	15	7	52	123.5
32	45	4	7	25	53	3	44	58	3.5	10	16	8	53	125.5
40	54.5	4	7	30	60	3	54	71	4	10	16.5	8.5	63.5	144
50	70.5	5	10	40	67	4.5	66	86	5	17.5	22	11	75.5	169.5
63	82.5	5	12	45	67	4.5	82	106	5	17.5	22	13	75.5	169.5
80	101	6	11	55	74	4.5	100	125	5	20	28.5	14	95	202.5
100	121	6	14	65	74	6	120	150	7	20	30	16	95	206

* Other dimensions are the same as basic type.
 * For female rod end, since the wrench flap (K and KA portions) will be inside of the bracket when the piston rod is retracted at the stroke end, extend the piston rod to tighten the nut using a tool, and mount a workpiece on the rod end.
 * Refer to the basic type for the female rod end.

Rod flange: CG1YF

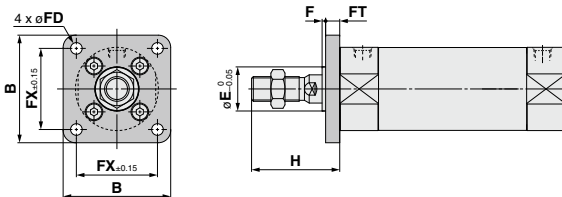

Head flange: CG1YG

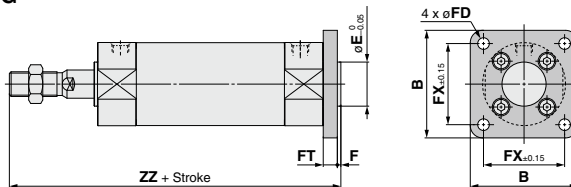

Flange

Bore size (mm)	B	E	F	FX	FD	FT	H	Head flange ZZ
20	40	12	2	28	5.5	6	35	120
25	44	14	2	32	5.5	7	40	126
32	53	18	2	38	6.6	7	40	128
40	61	25	2	46	6.6	8	50	147
50	76	30	2	58	9	9	58	171
63	92	32	2	70	11	9	58	171
80	104	40	3	82	11	11	71	207
100	128	50	3	100	14	14	71	210

Note) End boss is machined on the flange for øE.
 * Other dimensions are the same as basic type.
 * Refer to the basic type for the female rod end.

Mounting Bracket

Rod trunnion: CG1YU

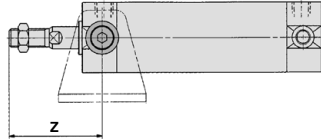
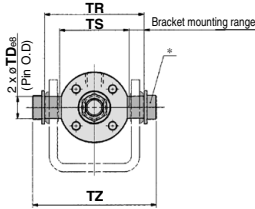

Trunnion (mm)

Bore size (mm)	TDe δ	TR	TS
20	8 ^{+0.025} _{-0.047}	39	28
25	10 ^{+0.025} _{-0.047}	43	33
32	12 ^{+0.032} _{-0.059}	54.5	40
40	14 ^{+0.032} _{-0.059}	65.5	49
50	16 ^{+0.032} _{-0.059}	80	60
63	18 ^{+0.032} _{-0.059}	98	74

Head trunnion: CG1YT

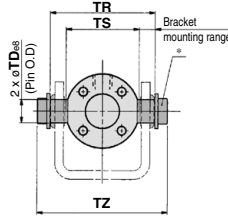
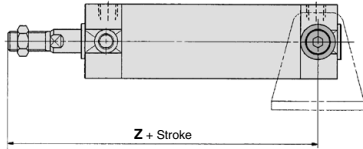

Bore size (mm)	TZ	Rod side	
		Z	Z
20	47.6	46	101
25	53	51	106
32	67.7	51	108
40	78.7	62	125
50	98.6	71	147
63	119.2	71	147

* Constructed of a trunnion pin, flat washer and hexagon socket head cap bolt.

Note) Refer to page 178 for pivot bracket.

* Other dimensions are the same as basic type.

* Refer to the basic type for the female rod end.

Clevis: CG1YD

ø20 to ø63

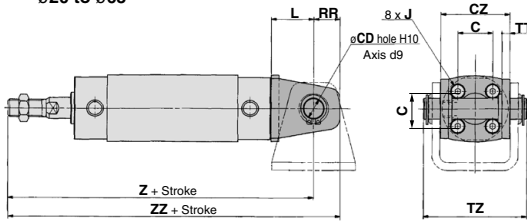

(The above shows the case port location is changed by 90°.)

Clevis (mm)

Bore size (mm)	CD	CX	CZ	L	RR	V
20	8	—	29	14	11	—
25	10	—	33	16	13	—
32	12	—	40	20	15	—
40	14	—	49	22	18	—
50	16	—	60	25	20	—
63	18	—	74	30	22	—
80	18	28	56	35	18	26
100	22	32	64	43	22	32

Bore size (mm)	TZ	Z	ZZ	Applicable pin part no.
20	43.4	126	137	CD-G02
25	48	133	146	CD-G25
32	59.4	139	154	CD-G03
40	71.4	159	177	CD-G04
50	86	185	205	CD-G05
63	105.4	190	212	CD-G06
80	64	228	246	IY-G08
100	72	236	258	IY-G10

Note) * Refer to page 178 for pivot bracket.

* Other dimensions are the same as basic type.

* Refer to the basic type for the female rod end.

ø80, ø100

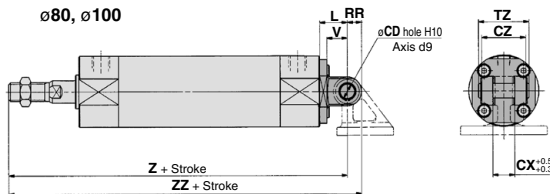

* A clevis pin and retaining rings are shipped together for the clevis type.

REA

REB

REC

Smooth

Low Speed

MQ

RHC

RZQ

CG1Y Series

Dimensions of Accessories

Single Knuckle Joint

I-G02, G03

Material: Carbon steel

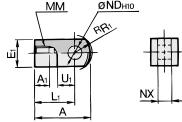

I-G04, G05, G08, G10

Material: Cast iron

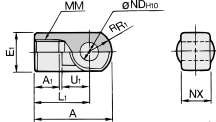

Part no.	Applicable bore size (mm)	A	A ₁	E ₁	L ₁	MM	R ₁	U ₁	ND _{H10}	NX
I-G02	20	34	8.5	□16	25	M8 x 1.25	10.3	11.5	8 ^{+0.058} _{-0.058}	8 ^{+0.2} _{-0.2}
I-G03	25, 32	41	10.5	□20	30	M10 x 1.25	12.8	14	10 ^{+0.058} _{-0.058}	10 ^{+0.2} _{-0.2}
I-G04	40	42	14	□22	30	M14 x 1.5	12	14	10 ^{+0.058} _{-0.058}	18 ^{+0.3} _{-0.3}
I-G05	50, 63	56	18	□28	40	M18 x 1.5	16	20	14 ^{+0.070} _{-0.070}	22 ^{+0.3} _{-0.3}
I-G08	80	71	21	□38	50	M22 x 1.5	21	27	18 ^{+0.070} _{-0.070}	28 ^{+0.3} _{-0.3}
I-G10	100	79	21	□44	55	M26 x 1.5	24	31	22 ^{+0.084} _{-0.084}	32 ^{+0.3} _{-0.3}

Knuckle Pin

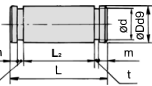

Material: Carbon steel (mm)

Part no.	Applicable bore size (mm)	Dd9	L	d	L ₂	m	t	Included retaining ring
IY-G02	20	8 ^{-0.040} _{-0.076}	21	7.6	16.2	1.5	0.9	Type C8 for axis
IY-G03	25, 32	10 ^{-0.040} _{-0.076}	25.6	9.6	20.2	1.55	1.15	Type C10 for axis
IY-G04	40	10 ^{-0.040} _{-0.076}	41.6	9.6	36.2	1.55	1.15	Type C10 for axis
IY-G05	50, 63	14 ^{-0.050} _{-0.085}	50.6	13.4	44.2	2.05	1.15	Type C14 for axis
IY-G08	80	18 ^{-0.050} _{-0.117}	64	17	56.2	2.55	1.35	Type C18 for axis
IY-G10	100	22 ^{-0.050} _{-0.117}	72	21	64.2	2.55	1.35	Type C22 for axis

* Retaining rings are included.

Clevis Pin

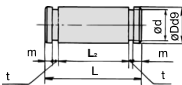

Material: Carbon steel (mm)

Part no.	Applicable bore size (mm)	Dd9	L	d	L ₂	m	t	Included retaining ring
CD-G02	20	8 ^{-0.040} _{-0.076}	43.4	7.6	38.6	1.5	0.9	Type C8 for axis
CD-G25	25	10 ^{-0.040} _{-0.076}	48	9.6	42.6	1.55	1.15	Type C10 for axis
CD-G03	32	12 ^{-0.050} _{-0.085}	59.4	11.5	54	1.55	1.15	Type C12 for axis
CD-G04	40	14 ^{-0.050} _{-0.085}	71.4	13.4	65	2.05	1.15	Type C14 for axis
CD-G05	50	16 ^{-0.050} _{-0.085}	86	15.2	79.6	2.05	1.15	Type C16 for axis
CD-G06	63	18 ^{-0.050} _{-0.117}	105.4	17	97.8	2.45	1.35	Type C18 for axis

* Retaining rings are included.

* A clevis pin and a knuckle pin are common for the bore size ø80 and ø100.

Rod End Nut

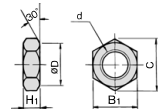

Material: Carbon steel (mm)

Part no.	Applicable bore size (mm)	d	H ₁	B ₁	C	D
NT-02	20	M8 x 1.25	5	13	(15)	12.5
NT-03	25, 32	M10 x 1.25	6	17	(19.6)	16.5
NT-G04	40	M14 x 1.5	8	19	(21.9)	18
NT-05	50, 63	M18 x 1.5	11	27	(31.2)	26
NT-08	80	M22 x 1.5	13	32	(37.0)	31
NT-10	100	M26 x 1.5	16	41	(47.3)	39

Double Knuckle Joint

Y-G02, G03

Material: Carbon steel

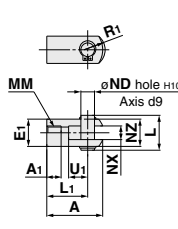

Y-G04, G05, G08, G10

Material: Cast iron

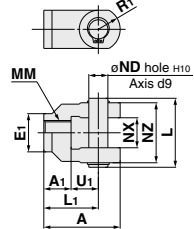

Part no.	Applicable bore size (mm)	A	A ₁	E ₁	L ₁	MM	R ₁	U ₁	ND	NX	NZ	L	Included pin part no.
Y-G02	20	34	8.5	□16	25	M8 x 1.25	10.3	11.5	8	8 ^{+0.2} _{-0.2}	16	21	IY-G02
Y-G03	25, 32	41	10.5	□20	30	M10 x 1.25	12.8	14	10	10 ^{+0.2} _{-0.2}	20	25.6	IY-G03
Y-G04	40	42	14	□22	30	M14 x 1.5	12	14	10	18 ^{+0.3} _{-0.3}	36	41.6	IY-G04
Y-G05	50, 63	56	18	□28	40	M18 x 1.5	16	20	14	22 ^{+0.3} _{-0.3}	44	50.6	IY-G05
Y-G08	80	71	21	□38	50	M22 x 1.5	21	27	18	28 ^{+0.3} _{-0.3}	56	64	IY-G08
Y-G10	100	79	24	□44	55	M26 x 1.5	24	31	22	32 ^{+0.3} _{-0.3}	64	72	IY-G10

* A knuckle pin and retaining rings are included.

Pivot Bracket (Order separately)

ø20 to ø63

Material: Carbon steel

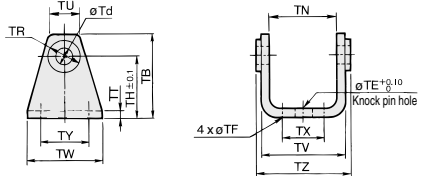

ø80, ø100

Material: Cast iron

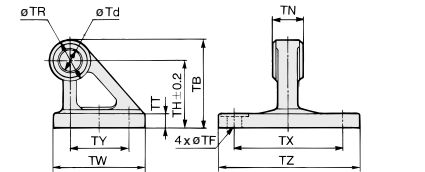

Part no.	Applicable bore size (mm)	TB	Td	TE	TF	TH	TN	TR	TT
CG-020-24A	20	36	8	10	5.5	25 (29.3)	13	3.2	3.2
CG-025-24A	25	43	10	10	5.5	30 (33.1)	15	3.2	3.2
CG-032-24A	32	50	12	10	6.6	35 (40.4)	17	4.5	4.5
CG-040-24A	40	58	14	10	6.6	40 (49.2)	21	4.5	4.5
CG-050-24A	50	70	16	20	9	50 (60.4)	24	6	6
CG-063-24A	63	82	18	20	11	60 (74.6)	26	8	8
CG-080-24A	80	73	18	—	11	55 (28 ^{+0.1} _{-0.1})	36	11	11
CG-100-24A	100	90	22	—	13.5	65 (32 ^{+0.1} _{-0.1})	50	12	12

Part no.	Applicable bore size (mm)	TU	TV	TW	TX	TY	TZ	Applicable pin O.D.
CG-020-24A	20	(18.1)	(35.8)	42	16	28	38.3	8d _{-0.040} _{-0.076}
CG-025-24A	25	(20.7)	(39.8)	42	20	28	42.1	10d _{-0.040} _{-0.076}
CG-032-24A	32	(23.6)	(49.4)	48	22	28	53.8	12d _{-0.050} _{-0.085}
CG-040-24A	40	(27.3)	(58.4)	56	30	30	64.6	14d _{-0.050} _{-0.085}
CG-050-24A	50	(29.7)	(72.4)	64	36	36	79.2	16d _{-0.050} _{-0.085}
CG-063-24A	63	(34.3)	(90.4)	74	46	46	97.2	18d _{-0.050} _{-0.085}
CG-080-24A	80	—	—	72	85	45	110	18d _{-0.050} _{-0.085}
CG-100-24A	100	—	—	93	100	60	130	22d _{-0.065} _{-0.117}

CG1Y Series

Mounting Brackets, Rod End Brackets, and Nut Material: Stainless Steel

Part No.

Bore size (mm)	Axial foot*1	Flange*1	Single knuckle joint	Double knuckle joint*2	Rod end nut
20	—	—	I-G02SUS	Y-G02SUS	NT-02SUS
25	—	—	I-G03SUS	Y-G03SUS	NT-03SUS
32	CG-L032SUS	CG-F032SUS			
40	CG-L040SUS	CG-F040SUS	I-G04SUS	Y-G04SUS	NT-G04SUS
50	CG-L050SUS	CG-F050SUS	I-G05SUS	Y-G05SUS	NT-05SUS
63	CG-L063SUS	CG-F063SUS			
80	CG-L080SUS	CG-F080SUS			
100	CG-L100SUS	CG-F100SUS	I-G10SUS	Y-G10SUS	NT-10SUS

*1 A knuckle pin and retaining rings are shipped together. Refer to the XC27 for details on stainless steel double clevis pins and double knuckle pins. The accessories need to be ordered separately from the cylinder.

Dimensions

The single knuckle joint, double knuckle joint, mounting nut, and rod end nut are the same as the standard type.

Axial foot

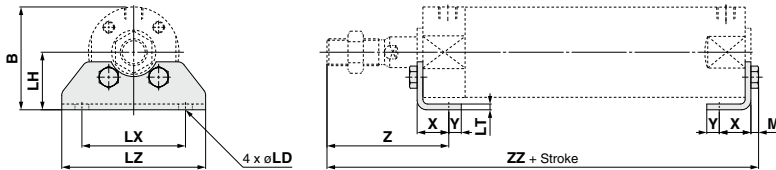

Bore size	B	LD	LH	LT	LX	LZ	M	X	Y	Z	ZZ
32	44	7.2	[25]	[3]	[44]	60	[3.5]	[16]	6	[53]	[117.5(125.5)]
40	53.5	7.2	[30]	[3]	[54]	75	[4]	[16.5]	6.5	[63.5]	[135(144)]
50	69	[10]	[40]	4	[66]	90	5.5	21.5	11.5	[75.5]	[157.5(169.5)]
63	81	[12]	[45]	4	[82]	110	7	21.5	11.5	[75.5]	159(171)
80	99.5	12	[55]	4	[100]	130	7	28	17	[95]	190(204)
100	125	[14]	[70]	[6]	[120]	160	8	[30]	15	[95]	193(207)

*1 []: Same as the standard type (): Denotes the dimensions for long strokes

*2 Supplied with 4 mounting screws.

Rod flange

The head flange has the same dimensions.

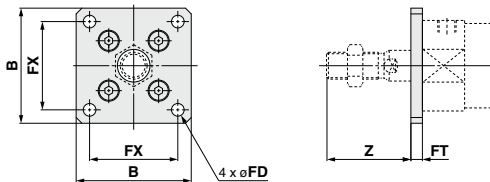

Bore size	B	FD	FT	FX	Z
32	50	[6.6]	6	[38]	34
40	60	[6.6]	6	[46]	44
50	75	[9]	[9]	[58]	[49]
63	90	[11]	[9]	[70]	[49]
80	100	[11]	9	[82]	62
100	125	[14]	10	[100]	61

*1 []: Same as the standard type

*2 Supplied with 4 mounting screws.

CG1Y Series Auto Switch Mounting

Auto Switch Proper Mounting Position (Detection at stroke end) and Its Mounting Height

Solid state auto switch

D-M9□
D-M9□W
ø20 to ø63

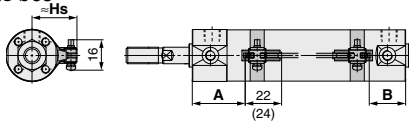

(): Dimension of the D-M9□A

A and B are the dimensions from the end of the head cover/rod cover to the end of the auto switch.

D-G5, K5, G5□W
D-K59W, D-G59F, D-G5NT
ø20 to ø100

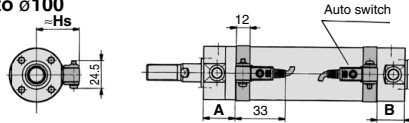

D-H7□, H7□W
D-H7NF
ø20 to ø63

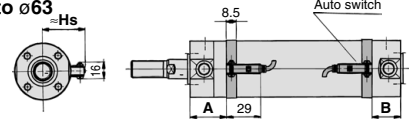

D-H7C
ø20 to ø63

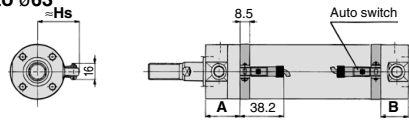

Reed auto switch

D-A9□
ø20 to ø63

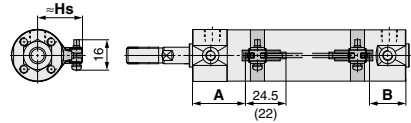

(): Dimension of the D-A9□

A and B are the dimensions from the end of the head cover/rod cover to the end of the auto switch.

D-C7, C8
ø20 to ø63

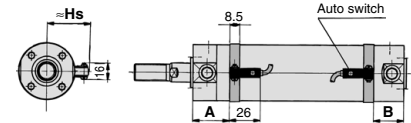

D-C73C, C80C
ø20 to ø63

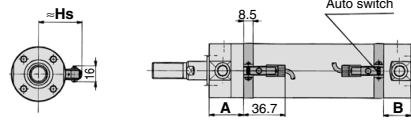

D-B5, B6, B59W
ø20 to ø100

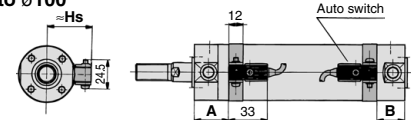

Auto Switch Proper Mounting Position (Detection at stroke end) (mm)

Auto switch model	D-M9□		D-A9□		D-H7□W		D-C7□		D-G5□K59		D-B5□		D-B59W	
	A	B	A	B	A	B	A	B	A	B	A	B	A	B
20	33	32	29	28	28.5	27.5	29.5	28.5	25	24	23.5	22.5	26.5	23.5
25	32.5	32.5	28.5	28.5	28	28	29	29	24.5	24.5	23	23	26	26
32	34	33	30	29	29.5	28.5	30.5	29.5	26	25	24.5	23.5	27.5	26.5
40	39	36	35	32	34.5	31.5	35.5	32.5	31	28	29.5	26.5	32.5	29.5
50	46	44	42	40	41.5	39.5	42.5	40.5	38	36	36.5	34.5	39.5	37.5
63	44.5	45.5	40.5	41.5	40	41	41	42	36.5	37.5	35	36	38	39
80	—	—	—	—	—	—	—	—	49.5	44.5	48	43	51	46
100	—	—	—	—	—	—	—	—	48.5	45.5	47	44	50	47

Auto Switch Mounting Height (mm)

Auto switch model	D-M9□ (V)		D-M9□W (V)		D-A9□ (V)		D-C73C		D-B5/B6		D-K59W	
	Hs	Hs	Hs	Hs	Hs	Hs	Hs	Hs	Hs	Hs	Hs	
20	25.5	24.5	27	27.5	—	—	—	—	—	—	—	
25	28	27	29.5	30	—	—	—	—	—	—	—	
32	31.5	30.5	33	33.5	—	—	—	—	—	—	—	
40	36	35	37.5	38	—	—	—	—	—	—	—	
50	41.5	40.5	43	43.5	—	—	—	—	—	—	—	
63	48.5	47.5	50	50.5	—	—	—	—	—	—	—	
80	—	—	—	59	—	—	—	—	—	—	—	
100	—	—	—	69.5	—	—	—	—	—	—	—	

Note) Adjust the auto switch after confirming the operating condition in the actual setting.

REA

REB

REC

Smooth

Low

Speed

MQ

RHC

RZQ

D-□

-X□

Minimum Stroke for Auto Switch Mounting

Auto switch model	Number of auto switches (mm)				
	With 1 pc.	With 2 pcs.		With n pcs. (n: Number of auto switches)	
		Different surfaces	Same surface	Different surfaces	Same surface
D-M9□	5	15 <small>Note 1)</small>	40 <small>Note 1)</small>	$20 + 35 \frac{(n-2)}{2}$ <small>(n = 2, 4, 6...)</small> <small>Note 3)</small>	$55 + 35 (n-2)$ <small>(n = 2, 3, 4, 5...)</small>
D-M9□W	10	15 <small>Note 1)</small>	40 <small>Note 1)</small>	$20 + 35 \frac{(n-2)}{2}$ <small>(n = 2, 4, 6...)</small> <small>Note 3)</small>	$55 + 35 (n-2)$ <small>(n = 2, 3, 4, 5...)</small>
D-M9□A	10	25	40 <small>Note 1)</small>	$25 + 35 \frac{(n-2)}{2}$ <small>(n = 2, 4, 6...)</small> <small>Note 3)</small>	$60 + 35 (n-2)$ <small>(n = 2, 3, 4, 5...)</small>
D-A9□	5	15	30 <small>Note 1)</small>	$15 + 35 \frac{(n-2)}{2}$ <small>(n = 2, 4, 6...)</small> <small>Note 3)</small>	$50 + 35 (n-2)$ <small>(n = 2, 3, 4, 5...)</small>
D-M9□V	5	20	35	$20 + 35 \frac{(n-2)}{2}$ <small>(n = 2, 4, 6...)</small> <small>Note 3)</small>	$35 + 35 (n-2)$ <small>(n = 2, 3, 4, 5...)</small>
D-A9□V	5	15	25	$15 + 35 \frac{(n-2)}{2}$ <small>(n = 2, 4, 6...)</small> <small>Note 3)</small>	$25 + 35 (n-2)$ <small>(n = 2, 3, 4, 5...)</small>
D-M9□WV D-M9□AV	10	20	35	$20 + 35 \frac{(n-2)}{2}$ <small>(n = 2, 4, 6...)</small> <small>Note 3)</small>	$35 + 35 (n-2)$ <small>(n = 2, 3, 4, 5...)</small>
D-C7□ D-C80	5	15	50	$15 + 45 \frac{(n-2)}{2}$ <small>(n = 2, 4, 6...)</small> <small>Note 3)</small>	$50 + 45 (n-2)$ <small>(n = 2, 3, 4, 5...)</small>
D-H7□ D-H7□W D-H7NF	10	15	60	$15 + 45 \frac{(n-2)}{2}$ <small>(n = 2, 4, 6...)</small> <small>Note 3)</small>	$60 + 45 (n-2)$ <small>(n = 2, 3, 4, 5...)</small>
D-C73C D-C80C	5	15	65	$15 + 50 \frac{(n-2)}{2}$ <small>(n = 2, 4, 6...)</small> <small>Note 3)</small>	$65 + 50 (n-2)$ <small>(n = 2, 3, 4, 5...)</small>
D-B5□ D-B64 D-G5□ D-K59□	5	15	75	$15 + 50 \frac{(n-2)}{2}$ <small>(n = 2, 4, 6...)</small> <small>Note 3)</small>	$75 + 55 (n-2)$ <small>(n = 2, 3, 4, 5...)</small>
D-B59W	10	20	75	$20 + 50 \frac{(n-2)}{2}$ <small>(n = 2, 4, 6...)</small> <small>Note 3)</small>	$75 + 55 (n-2)$ <small>(n = 2, 3, 4, 5...)</small>

Note 3) When "n" is an odd number, an even number that is one larger than this odd number is used for the calculation.

Note 1) Auto switch mounting

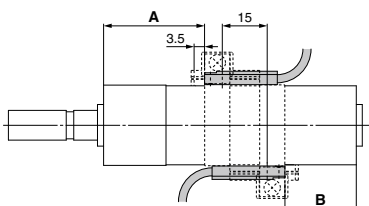
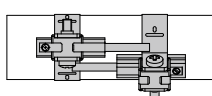
Auto switch model	With 2 auto switches	
	Different surfaces	Same surface
	 <p>Correct auto switch mounting position is 3.5 mm from the back face of the switch holder.</p>	 <p>The auto switch is mounted by slightly displacing it in a direction (cylinder tube circumferential exterior) so that the auto switch and lead wire do not interfere with each other.</p>
D-M9□ D-M9□W	Less than 20 stroke <small>Note 2)</small>	Less than 55 stroke <small>Note 2)</small>
D-M9□A	Less than 20 stroke <small>Note 2)</small>	Less than 60 stroke <small>Note 2)</small>
D-A9□	—	Less than 50 stroke <small>Note 2)</small>

Note 2) Minimum stroke for auto switch mounting in types other than those mentioned in Note 1.

Operating Range

Auto switch model	Bore size (mm)							
	20	25	32	40	50	63	80	100
D-M9□(V) D-M9□W(V) D-M9□A(V)	4.5	5	4.5	5.5	5	5.5	—	—
D-A9□(V)	7	6	8	8	8	9	—	—
D-C7/C80 D-C73C/C80C	8	10	9	10	10	11	—	—
D-B5□/B64	8	10	9	10	10	11	11	11
D-B59W	13	13	14	14	14	17	16	18

Auto switch model	Bore size (mm)							
	20	25	32	40	50	63	80	100
D-H7□/H7mW D-H7NF	4	4	4.5	5	6	6.5	—	—
D-H7C	7	8.5	9	10	9.5	10.5	—	—
D-G5□/G5□W/G59F D-G5BA/K59/K59W	4	4	4.5	5	6	6.5	6.5	7
D-G5NT	4	4	4.5	5	6	6.5	6.5	7

* Values which include hysteresis are for guideline purposes only, they are not a guarantee (assuming approximately ±30% dispersion) and may change substantially depending on the ambient environment.

Auto Switch Mounting Brackets/Part No.

Auto switch model	Bore size (mm)							
	20	25	32	40	50	63	80	100
D-M9□(V) D-M9□W(V) D-A9□(V)	BMA3-020 (A set of a, b, c, d)	BMA3-025 (A set of a, b, c, d)	BMA3-032 (A set of a, b, c, d)	BMA3-040 (A set of a, b, c, d)	BMA3-050 (A set of a, b, c, d)	BMA3-063 (A set of a, b, c, d)	—	—
D-M9□A(V) <small>Note 2)</small>	BMA3-020S (A set of b, c, d, e)	BMA3-025S (A set of b, c, d, e)	BMA3-032S (A set of b, c, d, e)	BMA3-040S (A set of b, c, d, e)	BMA3-050S (A set of b, c, d, e)	BMA3-063S (A set of b, c, d, e)	—	—

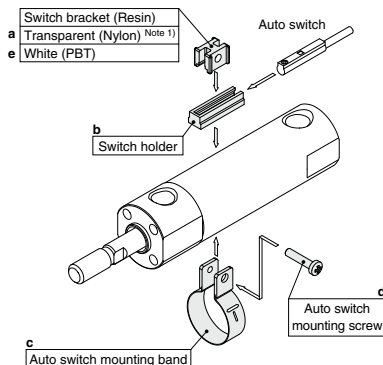

* Band (c) is mounted so that the projected part is on the internal side (contact side with the tube).

D-C7□/C80 D-C73C D-C80C D-H7□ D-H7mW D-H7NF	BMA2-020A (A set of band and screw)	BMA2-025A (A set of band and screw)	BMA2-032A (A set of band and screw)	BMA2-040A (A set of band and screw)	BMA2-050A (A set of band and screw)	BMA2-063A (A set of band and screw)	—	—
D-H7BA	BMA2-020AS (A set of band and screw)	BMA2-025AS (A set of band and screw)	BMA2-032AS (A set of band and screw)	BMA2-040AS (A set of band and screw)	BMA2-050AS (A set of band and screw)	BMA2-063AS (A set of band and screw)	—	—
D-B5□/B64 D-B59W D-G5□/K59 D-G5W/K59W D-G5BA/G59F D-G5NT	BA-01 (A set of band and screw)	BA-02 (A set of band and screw)	BA-32 (A set of band and screw)	BA-04 (A set of band and screw)	BA-05 (A set of band and screw)	BA-06 (A set of band and screw)	BA-08 (A set of band and screw)	BA-10 (A set of band and screw)

Note 1) Since the switch bracket (made from nylon) are affected in an environment where alcohol, chloroform, methylamines, hydrochloric acid or sulfuric acid is splashed over, so it cannot be used.
Please contact SMC regarding other chemicals.

Note 2) Avoid the indicator LED for mounting the switch bracket. As the indicator LED is projected from the switch unit, indicator LED may be damaged if the switch bracket is fixed on the indicator LED.

Band Mounting Brackets Set Part No.

Set part no.	Contents
BM2-□□□A(S) * S: Stainless steel screw	· Auto switch mounting band (c) · Auto switch mounting screw (d)
BJ4-1	· Switch bracket (White/PBT) (e) · Switch holder (b)
BJ5-1	· Switch bracket (Transparent/Nylon) (a) · Switch holder (b)

[Stainless Steel Mounting Screw]

The following stainless steel mounting screw kit is available. Use it in accordance with the operating environment. (Since the auto switch mounting bracket is not included, order it separately.)
BBA3: D-B5/B6/G5/K5 types

Note 3) Refer to page 1047 for details on the BBA3. When the D-G5BA type auto switch is shipped independently, the BBA3 is attached.

REA

REB

REC

Smooth

Low Speed

MQ

RHC

RZQ







D-□

-X□

Cylinder Mounting Bracket, by Stroke/Auto Switch Mounting Surfaces

Auto switch mounting surface varies depending on mounting brackets and cylinder strokes. Refer to the table below.

(mm)

Auto switch model	Basic, Foot, Flange, Clevis			Trunnion		
	With 1 pc. (Rod cover side)	With 2 pcs. (Different surfaces)	With 2 pcs. (Same surface)	With 1 pc. (Rod cover side)	With 2 pcs. (Different surfaces)	With 2 pcs. (Same surface)
Auto switch mounting surface	Port surface 	Port surface 	Port surface 			
Auto switch type						
D-M9□(V) D-M9□W(V) D-M9□A(V) D-A9□(V)	10 st or more	15 to 44 st	45 st or more	10 st or more	15 to 44 st	45 st or more
D-C7/C8	10 st or more	15 to 49 st	50 st or more	10 st or more	15 to 49 st	50 st or more
D-H7□/H7□W D-H7NF	10 st or more	15 to 59 st	60 st or more	10 st or more	15 to 59 st	60 st or more
D-C73C/C80C/H7C	10 st or more	15 to 64 st	65 st or more	10 st or more	15 to 64 st	65 st or more
D-B5/B6/G5/K5 D-G5□W/K59W D-G59F/G5NT	10 st or more	15 to 74 st	75 st or more	10 st or more	15 to 74 st	75 st or more
D-B59W	15 st or more	20 to 74 st	75 st or more	15 st or more	20 to 74 st	75 st or more

* Trunnion type is not available for ø80 and ø100.

Other than the applicable auto switches listed in "How to Order", the following auto switches are mountable.

Refer to pages 941 to 1067 for the detailed specifications.

Type	Model	Electrical entry	Features	Applicable bore size (mm)
Solid state	D-H7A1/H7A2/H7B	Grommet (In-line)	—	ø20 to ø63
	D-H7NW/H7PW/H7BW		Diagnostic indication (2-color indicator)	
	D-H7BA		Water resistant (2-color indicator)	
	D-G5NT		With timer	ø20 to ø100
Reed	D-C73/C76		—	ø20 to ø63
	D-C80		Without indicator light	
	D-B53	—	ø20 to ø100	

* With pre-wired connector is also available for solid state auto switches. For details, refer to pages 1014 and 1015.

* Normally closed (NC = b contact) solid state auto switches (D-M9□E(V)) are also available. For details, refer to page 1592-1.

Smooth Cylinder

MBY Series

∅32, ∅40, ∅50, ∅63, ∅80, ∅100

RoHS

How to Order

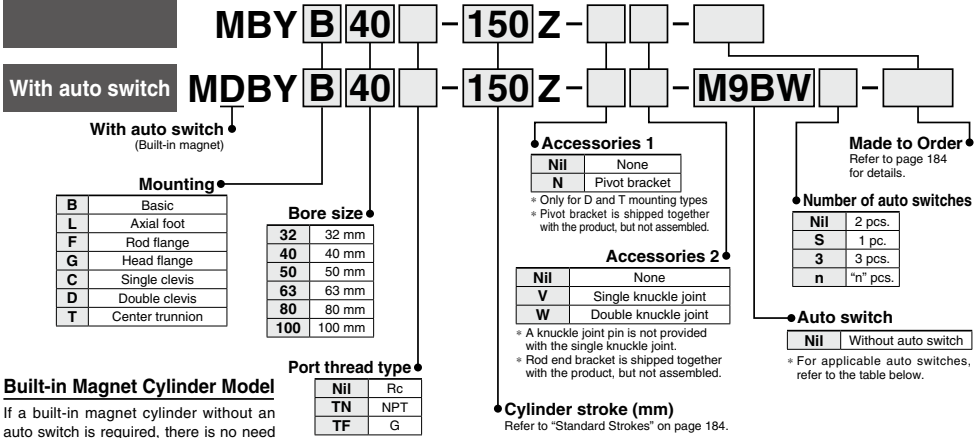

* Refer to "Ordering Example of Cylinder Assembly" on page 185.

Applicable Auto Switches/Refer to pages 941 to 1067 for further information on auto switches.

Type	Special function	Electrical entry	Indicator light	Wiring (Output)	Load voltage		Auto switch model		Lead wire length (m)				Pre-wired connector	Applicable load				
					DC	AC	Tie-rod mounting	Band mounting	0.5 (Nil)	1 (M)	3 (L)	5 (Z)						
															3-wire (NPN)	3-wire (PNP)	2-wire	3-wire (NPN)
Solid state auto switch	—	Grommet	No	3-wire (NPN)	24 V	5 V, 12 V	—	M9N	●	●	○	○	—	IC circuit				
				3-wire (PNP)				M9P	●	●	○	○						
		Terminal conduit	Yes	2-wire	12 V	M9B	●	●	○	○	—	—						
				3-wire (NPN)	5 V, 12 V	G39	—	—	—	—								
	Diagnostic indication (2-color indicator)	Grommet	Yes	2-wire	12 V	24 V	—	—	—	—	—	—	—	—				
				3-wire (NPN)	5 V, 12 V										M9NW	●	●	○
		Water resistant (2-color indicator)	Grommet	No	3-wire (PNP)	24 V	5 V, 12 V	—	—	—	—	—	—	—	—			
					2-wire											12 V	M9PW	●
		With diagnostic output (2-color indicator)	Grommet	Yes	3-wire (NPN)	24 V	5 V, 12 V	—	—	—	—	—	—	—	—			
					3-wire (PNP)											5 V, 12 V	M9BWA*1	●
Magnetic field resistant (2-color indicator)	Grommet	No	2-wire	24 V	5 V, 12 V	—	—	—	—	—	—	—	—					
			4-wire (NPN)											5 V, 12 V	M9BA*1	—	○	●
Reed auto switch	—	Grommet	Yes	3-wire (NPN equivalent)	24 V	12 V	—	A96	●	●	●	●	—	IC circuit	Relay, PLC			
								A93	—	●	●	●	—	—				
								A90	—	●	—	●	—	—		IC circuit		
								A54	—	●	—	●	—	—		—		
								A64	—	●	—	●	—	—		—		
		Terminal conduit	No	Yes	2-wire	24 V	12 V	—	—	A33	—	—	—	—	—	PLC		
										A34	—	—	—	—	—	—	—	
										A44	—	—	—	—	—	—	—	Relay, PLC
										A59W	—	●	—	●	—	—	—	—
										DIN terminal	Yes	Grommet	2-wire	24 V	—	—	—	—
Diagnostic indication (2-color indicator)																		

*1 Water resistant type auto switches can be mounted on the above models, but in such case SMC cannot guarantee water resistance.
A water resistant type cylinder is recommended for use in an environment which requires water resistance.

* Lead wire length symbols: 0.5 m.....Nil (Example) M9NW 3 m.....L (Example) M9NLW 1 m.....M (Example) M9NWM 5 m.....Z (Example) M9NZW

* Solid state auto switches marked with "C" are produced upon receipt of order.

* Since there are other applicable auto switches then listed above, refer to page 197 for details.

* The D-A9□/M9□/P3DWA□ auto switches are shipped together, (but not assembled). (However, only the auto switch mounting brackets are assembled for the D-A9□/M9□ before shipment.)



- REA
- REB
- REC
- Smooth
- Low Speed
- MQ
- RHC
- RZQ

- D-□
- X□

MBY Series



Symbol



Minimum Operating Pressure

Unit: MPa						
Bore size (mm)	32	40	50	63	80	100
Min. operating pressure	0.02		0.01			



Made to Order
[Click here for details](#)

Symbol	Specifications
-XA□	Change of rod end shape
-XC7	Tie-rod, Cushion valve, Tie-rod nut, etc. made of stainless steel
-XC14	Change of trunnion bracket mounting position
-XC27	Double clevis and double knuckle joint pins made of stainless steel
-XC29	Double knuckle joint with spring pin
-XC30	Rod trunnion
-XC65	Made of stainless steel (Combination of XC7 and XC68)
-XC68	Made of stainless steel (with hard chrome plated piston rod)

Replacement Parts/Seal Kit

Bore size (mm)	Kit no.	Contents
32	MBY32Z-PS	
40	CA2Y40Z-PS	Rod seal 1 pc.
50	CA2Y50Z-PS	Piston seal 1 pc.
63	CA2Y63Z-PS	Cylinder tube gasket 2 pcs.
80	CA2Y80Z-PS	Grease pack (10 g) 1 pc.
100	CA2Y100Z-PS	

When maintenance requires only grease, use the following part numbers to order.

Grease pack part number: GR-L-005 (5 g)
 GR-L-010 (10 g)
 GR-L-150 (150 g)

Specifications

Bore size (mm)	32	40	50	63	80	100
Action	Double acting					
Piston speed	5 to 500 mm/s					
Fluid	Air					
Proof pressure	1.05 MPa					
Maximum operating pressure	0.7 MPa					
Ambient and fluid temperature	Without auto switch: -10°C to 70°C With auto switch: -10°C to 60°C (No freezing)					
Cushion	None					
Lubrication	Not required (Non-lube)					
Mounting	Basic, Axial foot, Rod flange, Head flange, Single clevis, Double clevis, Center trunnion					
Allowable leakage rate	0.5 L/min (ANR)					

Standard Strokes

Bore size (mm)	Standard stroke (mm)	Max. manufacturable stroke
32	25, 50, 75, 100, 125, 150, 175, 200, 250, 300, 350, 400, 450, 500	1000
40	25, 50, 75, 100, 125, 150, 175, 200, 250, 300, 350, 400, 450, 500	1000
50	25, 50, 75, 100, 125, 150, 175, 200, 250, 300, 350, 400, 450, 500, 600	1000
63	25, 50, 75, 100, 125, 150, 175, 200, 250, 300, 350, 400, 450, 500, 600	1000
80	25, 50, 75, 100, 125, 150, 175, 200, 250, 300, 350, 400, 450, 500, 600, 700, 800	1000
100	25, 50, 75, 100, 125, 150, 175, 200, 250, 300, 350, 400, 450, 500, 600, 700, 800	1000

Note 1) Intermediate strokes not listed above are also available.

Please consult with SMC for strokes outside the above ranges.

Note 2) Applicable strokes should be confirmed according to the usage. For details, refer to "Air Cylinders Model Selection" on front matter pages of the Best Pneumatics No. 2-1. In addition, the products that exceed the standard stroke might not be able to fulfill the specifications due to the deflection etc.

Accessories

For details, refer to page 191.

Mounting		Basic	Axial foot	Rod flange	Head flange	Single clevis	Double clevis	Center trunnion
Standard	Rod end nut	●	●	●	●	●	●	●
	Clevis pin	—	—	—	—	—	●	—
Option	Single knuckle joint	●	●	●	●	●	●	●
	Double knuckle joint (with pin)	●	●	●	●	●	●	●
	Rod boot	●	●	●	●	●	●	●

Mounting Brackets/Part No.

Bore size (mm)	32	40	50	63	80	100
Axial foot ^{Note 1)}	MB-L03	MB-L04	MB-L05	MB-L06	MB-L08	MB-L10
Flange	MB-F03	MB-F04	MB-F05	MB-F06	MB-F08	MB-F10
Single clevis	MB-C03	MB-C04	MB-C05	MB-C06	MB-C08	MB-C10
Double clevis	MB-D03	MB-D04	MB-D05	MB-D06	MB-D08	MB-D10

Note 1) Order two foots per cylinder.

Note 2) Accessories for each mounting bracket are as follows: Axial foot, Flange, Single clevis: Body mounting bolt, Double clevis: Body mounting bolt, Clevis pin, Flat washers and Split pins. → Refer to page 191 for details.

Ordering Example of Cylinder Assembly

Cylinder model: **MDBYD40-150Z-NW-M9BW**

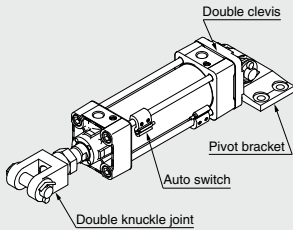

Mounting	D : Double clevis
Pivot bracket	N : Yes
Rod end bracket W:	Double knuckle joint
Auto switch D-M9BW:	2 pcs.

* Pivot bracket, double knuckle joint and auto switch are shipped together with the product, but not assembled.

Weights

Bore size (mm)		32	40	50	63	80	100
Basic weight	Basic	0.44	0.59	1.04	1.29	2.41	3.36
	Axial foot	0.56	0.73	1.26	1.57	2.91	4.02
	Flange	0.73	0.96	1.49	2.08	3.86	5.19
	Single clevis	0.69	0.82	1.38	1.92	3.52	4.94
	Double clevis	0.7	0.86	1.47	2.08	3.81	5.21
	Trunnion	0.73	0.95	1.52	2.09	3.96	5.05
Additional weight per 50 mm of stroke	All mounting brackets	0.11	0.16	0.26	0.27	0.42	0.56
Accessories	Single knuckle joint	0.15	0.23	0.26	0.26	0.60	0.83
	Double knuckle joint (with pin)	0.22	0.37	0.43	0.43	0.87	1.27

Calculation Example **MBYB32-100Z** (Basic, ø32, 100 st)

- Basic weight.....0.44 (Basic, ø32)
 - Additional weight.....0.11/50 stroke
 - Cylinder stroke.....100 stroke
-
- 0.44 + 0.11 x 100/50 = **0.66 kg**

REA

REB

REC

Smooth

Low Speed

MQ

RHC

RZQ

D-□

-X□

MBY Series

Standard

Basic: MBYB

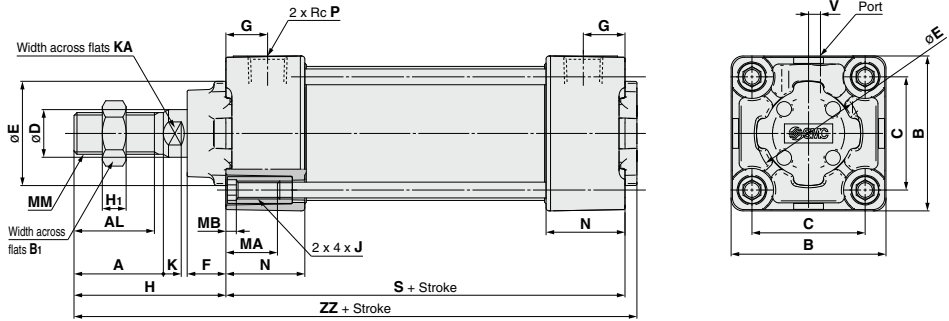

Dimensions

(mm)

Bore size (mm)	A	AL	B	B ₁	C	D	E	F	G	H	H ₁	J	K	KA	MA	MB	MM	N	P	S	V	ZZ
32	22	19.5	46	17	32.5	12	30	13	13	47	6	M6 x 1	6	10	16	4	M10 x 1.25	27	1/8	84	4	135
40	30	27	52	22	38	16	35	13	14	51	8	M6 x 1	6	14	16	4	M14 x 1.5	27	1/4	84	4	139
50	35	32	65	27	46.5	20	40	14	15.5	58	11	M8 x 1.25	7	18	16	5	M18 x 1.5	31.5	1/4	94	5	156
63	35	32	75	27	56.5	20	45	14	16.5	58	11	M8 x 1.25	7	18	16	5	M18 x 1.5	31.5	3/8	94	9	156
80	40	37	95	32	72	25	45	20	19	72	13	M10 x 1.5	10	22	16	5	M22 x 1.5	38	3/8	114	11.5	190
100	40	37	114	41	89	30	55	20	19	72	16	M10 x 1.5	10	26	16	5	M26 x 1.5	38	1/2	114	17	190

Standard/With Mounting Bracket

* Refer to Basic (B) for other dimensions.

Axial foot: MBYL

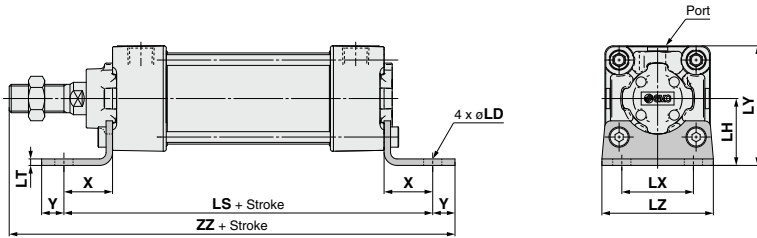

Axial Foot (mm)

Bore size (mm)	LD	LH	LS	LT	LX	LY	LZ	X	Y	ZZ
32	7	30	128	3.2	32	53	50	22	9	162
40	9	33	132	3.2	38	59	55	24	11	170
50	9	40	148	3.2	46	72.5	70	27	11	190
63	12	45	148	3.6	56	82.5	80	27	14	193
80	12	55	174	4.5	72	102.5	100	30	14	230
100	14	65	178	4.5	89	122	120	32	16	234

Rod flange: MBYF

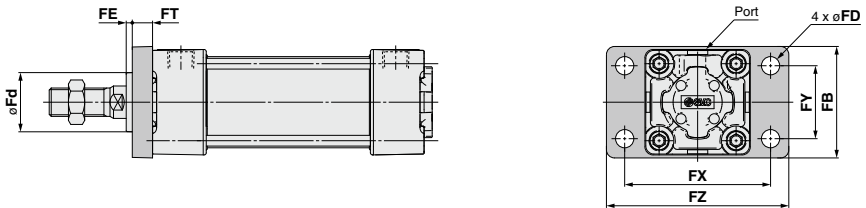

Rod Flange (mm)

Bore size (mm)	FB	FD	FE	FT	FX	FY	FZ	Fd
32	50	7	3	10	64	32	79	24.5
40	55	9	3	10	72	36	90	30.5
50	70	9	2	12	90	45	110	36.5
63	80	9	2	12	100	50	120	39.5
80	100	12	4	16	126	63	153	39.5
100	120	14	4	16	150	75	178	46.5

- REA
- REB
- REC
- Smooth
- Low Speed
- MQ
- RHC
- RZQ

- D-
- X

MBY Series

Standard/With Mounting Bracket

* Refer to Basic (B) for other dimensions.

Head flange: MBYG

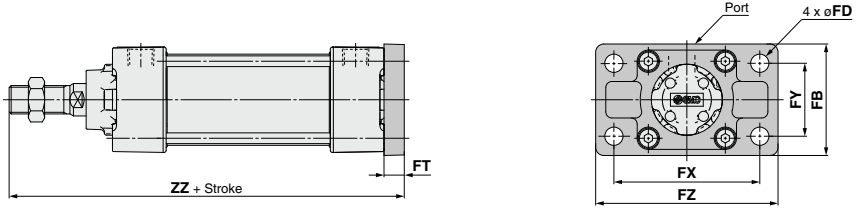

Head Flange (mm)

Bore size (mm)	FB	FD	FT	FX	FY	FZ	ZZ
32	50	7	10	64	32	79	141
40	55	9	10	72	36	90	145
50	70	9	12	90	45	110	164
63	80	9	12	100	50	120	164
80	100	12	16	126	63	153	202
100	120	14	16	150	75	178	202

Single clevis: MBYC

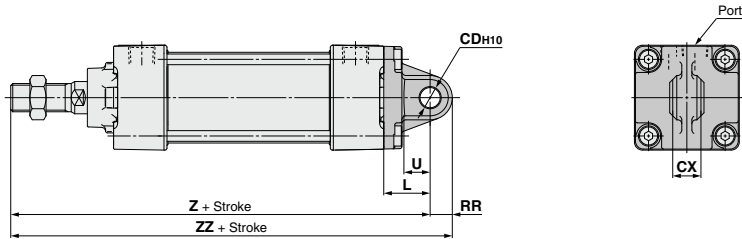

Single Clevis (mm)

Bore size (mm)	CDH10	CX	L	RR	U	Z	ZZ
32	10 ^{+0.058} ₀	14 ^{-0.1} _{-0.3}	23	10.5	13	154	164.5
40	10 ^{+0.058} ₀	14 ^{-0.1} _{-0.3}	23	11	13	158	169
50	14 ^{+0.070} ₀	20 ^{-0.1} _{-0.3}	30	15	17	182	197
63	14 ^{+0.070} ₀	20 ^{-0.1} _{-0.3}	30	15	17	182	197
80	22 ^{+0.084} ₀	30 ^{-0.1} _{-0.3}	42	23	26	228	251
100	22 ^{+0.084} ₀	30 ^{-0.1} _{-0.3}	42	23	26	228	251

Standard/With Mounting Bracket

* Refer to Basic (B) for other dimensions.

Double clevis: MBYD

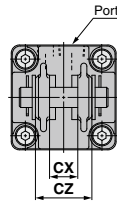
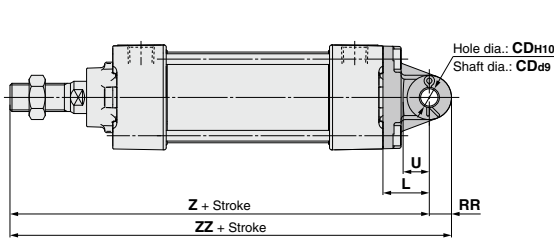

Double Clevis

(mm)

Bore size (mm)	CDH10	CD49	CX	CZ	L	RR	U	Z	ZZ
32	10 ^{+0.058} ₀	10 ^{-0.040} _{-0.076}	14 ^{+0.3} _{-0.1}	28	23	10.5	13	154	164.5
40	10 ^{+0.058} ₀	10 ^{-0.040} _{-0.076}	14 ^{+0.3} _{-0.1}	28	23	11	13	158	169
50	14 ^{+0.070} ₀	14 ^{-0.050} _{-0.093}	20 ^{+0.3} _{-0.1}	40	30	15	17	182	197
63	14 ^{+0.070} ₀	14 ^{-0.050} _{-0.093}	20 ^{+0.3} _{-0.1}	40	30	15	17	182	197
80	22 ^{+0.084} ₀	22 ^{-0.065} _{-0.117}	30 ^{+0.3} _{-0.1}	60	42	23	26	228	251
100	22 ^{+0.084} ₀	22 ^{-0.065} _{-0.117}	30 ^{+0.3} _{-0.1}	60	42	23	26	228	251

Center trunnion: MBYT

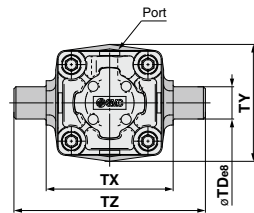
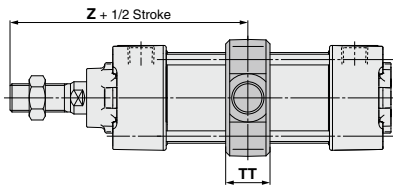

Center Trunnion

(mm)

Bore size (mm)	TD66	TT	TX	TY	TZ	Z
32	12 ^{-0.032} _{-0.059}	17	50	49	74	89
40	16 ^{-0.032} _{-0.059}	22	63	58	95	93
50	16 ^{-0.032} _{-0.059}	22	75	71	107	105
63	20 ^{-0.040} _{-0.073}	28	90	87	130	105
80	20 ^{-0.040} _{-0.073}	34	110	110	150	129
100	25 ^{-0.040} _{-0.073}	40	132	136	182	129

REA

REB

REC

Smooth

Low Speed

MQ

RHC

RZQ

D-□

-X□

MBY Series

Pivot Bracket/Trunnion and Double Clevis Pivot Bracket

Part No.

Bore size	MB□32	MB□40	MB□50	MB□63	MB□80	MB□100
Description	MB-S03	MB-S04	MB-S06	MB-S10		
Trunnion pivot bracket (Note)	MB-S03		MB-S04		MB-S06	
Double clevis pivot bracket	MB-B03		MB-B05		MB-B08	

(Note) Order 2 trunnion pivot brackets per cylinder.

Trunnion pivot bracket

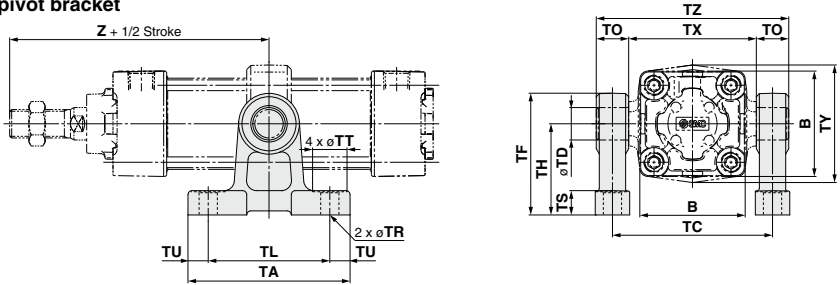

(mm)

Part no.	Bore size (mm)	B	TA	TL	TU	TC	TX	TE	TO	TR	TT	TS	TH	TF	Z ^{±s}	TD _{H10}
MB-S03	32	46	62	45	8.5	62	50	74	12	7	13	10	35	47	89	12 ^{+0.070} ₀
	40	52	80	60	10	80	63	97	17	9	17	12	45	60	93	16 ^{+0.070} ₀
MB-S04	50	65	80	60	10	92	75	109	17	9	17	12	45	60	105	16 ^{+0.070} ₀
	63	75	100	70	15	110	90	130	20	11	22	14	60	80	105	20 ^{+0.084} ₀
MB-S06	80	95	100	70	15	130	110	150	20	11	22	14	60	80	129	20 ^{+0.084} ₀
	100	114	120	90	15	158	132	184	26	13.5	24	17	75	100	129	25 ^{+0.084} ₀

Double clevis pivot bracket

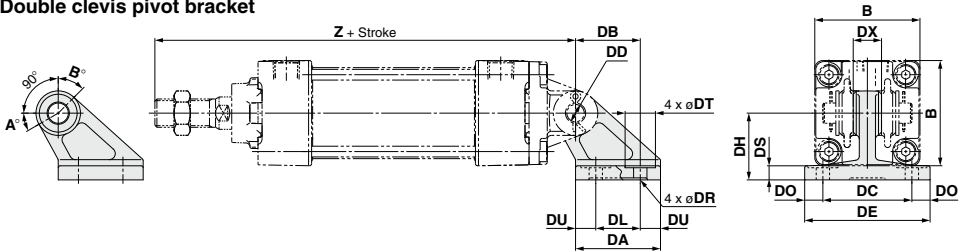

(mm)

Part no.	Bore size (mm)	B	DA	DB	DL	DU	DC	DX	DE	DO	DR	DT	DS	DH	Z ^{±s}	DD _{H10}
MB-B03	32	46	42	32	22	10	44	14	62	9	6.6	15	7	33	154	10 ^{+0.058} ₀
	40	52	42	32	22	10	44	14	62	9	6.6	15	7	33	158	10 ^{+0.058} ₀
MB-B05	50	65	53	43	30	11.5	60	20	81	10.5	9	18	8	45	182	14 ^{+0.070} ₀
	63	75	53	43	30	11.5	60	20	81	10.5	9	18	8	45	182	14 ^{+0.070} ₀
MB-B08	80	95	73	64	45	14	86	30	111	12.5	11	22	10	65	228	22 ^{+0.084} ₀
	100	114	73	64	45	14	86	30	111	12.5	11	22	10	65	228	22 ^{+0.084} ₀

Rotating Angle

Bore size (mm)	A°	B°	A° + B° + 90°
32, 40	25°	45°	160°
50, 63	40°	60°	190°
80, 100	30°	55°	175°

Dimensions of Accessories

Rod end nut
(Standard)

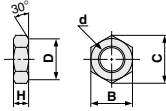

Part no.	Bore size (mm)	d	H	B	C	D
NT-03	32	M10 x 1.25	6	17	19.6	16.5
NT-04	40	M14 x 1.5	8	22	25.4	21
NT-05	50, 63	M18 x 1.5	11	27	31.2	26
NT-08	80	M22 x 1.5	13	32	37.0	31
NT-10	100	M26 x 1.5	16	41	47.3	39

I type
Single knuckle joint

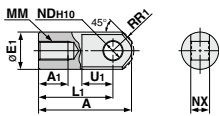

Part no.	Bore size (mm)	A	A ₁	E ₁	L ₁	MM	R ₁	U ₁	NDH10	NX
I-03M	32	40	14	20	30	M10 x 1.25	12	16	10 ^{+0.058} ₀	14 ^{+0.10} _{-0.30}
I-04M	40	50	19	22	40	M14 x 1.5	12.5	19	10 ^{+0.058} ₀	14 ^{+0.10} _{-0.30}
I-05M	50, 63	64	24	28	50	M18 x 1.5	16.5	24	14 ^{+0.070} ₀	20 ^{+0.10} _{-0.30}
I-08M	80	80	26	40	60	M22 x 1.5	23.5	34	22 ^{+0.084} ₀	30 ^{+0.10} _{-0.30}
I-10M	100	80	26	40	60	M26 x 1.5	23.5	34	22 ^{+0.084} ₀	30 ^{+0.10} _{-0.30}

Knuckle joint pin
Clevis pin

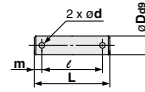

Part no.	Bore size (mm) Clevis/Knuckle	Dø8	L	l	m	d	Applicable split pin
CD-M03	32, 40	10 ^{+0.040} _{-0.076}	44	36	4	3	ø3 x 18 ℓ
CD-M05	50, 63	14 ^{+0.050} _{-0.093}	60	51	4.5	4	ø4 x 25 ℓ
CD-M08	80, 100	22 ^{+0.075} _{-0.117}	82	72	5	4	ø4 x 35 ℓ

Note) Split pins and flat washers are included.

Y type
Double knuckle joint

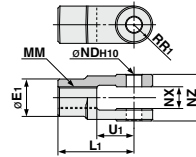

Part no.	Bore size (mm)	E ₁	L ₁	MM	R ₁	U ₁	NDH10	NX	NZ
Y-03M	32	20	30	M10 x 1.25	10	16	10 ^{+0.058} ₀	14 ^{+0.30} _{-0.10}	28 ^{+0.10} _{-0.30}
Y-04M	40	22	40	M14 x 1.5	11	19	10 ^{+0.058} ₀	14 ^{+0.30} _{-0.10}	28 ^{+0.10} _{-0.30}
Y-05M	50, 63	28	50	M18 x 1.5	14	24	14 ^{+0.070} ₀	20 ^{+0.30} _{-0.10}	40 ^{+0.10} _{-0.30}
Y-08M	80	40	65	M22 x 1.5	20	34	22 ^{+0.084} ₀	30 ^{+0.30} _{-0.10}	60 ^{+0.10} _{-0.30}
Y-10M	100	40	65	M26 x 1.5	20	34	22 ^{+0.084} ₀	30 ^{+0.30} _{-0.10}	60 ^{+0.10} _{-0.30}

Note) A pin, split pins and flat washers are included.

Bracket Combinations

Bracket combination available Refer to the figure below.

Bracket for cylinder	Bracket for workpiece				
	Single clevis	Double clevis	Single knuckle joint	Double knuckle joint	Clevis pivot bracket
Single clevis	—	①	—	②	—
Double clevis	③	—	④	—	⑨
Single knuckle joint	—	⑤	—	⑥	—
Double knuckle joint	⑦	—	⑧	—	⑩

No.	Appearance	No.	Appearance
①	Single clevis + Double clevis 	⑥	Single knuckle joint + Double knuckle joint
②	Single clevis + Double knuckle joint 	⑦	Double knuckle joint + Single clevis
③	Double clevis + Single clevis 	⑧	Double knuckle joint + Single knuckle joint
④	Double clevis + Single knuckle joint 	⑨	Double clevis + Clevis pivot bracket
⑤	Single knuckle joint + Double clevis 	⑩	Double knuckle joint + Clevis pivot bracket

REA

REB

REC

Smooth

Low Speed

MQ

RHC

RZQ

D-□

-X□

MBY Series

Auto Switch Mounting

Auto Switch Proper Mounting Position (Detection at stroke end) and Its Mounting Height

<Tie-rod mounting>

D-M9□/M9□V

D-M9□W/M9□VV

D-M9□A/M9□AV

D-A9□/A9□V

D-Z7□/Z80

D-Y59□/Y69□/Y7P/Y7PV

D-Y7□W/Y7□WV/Y7BA

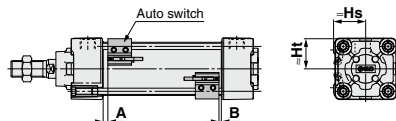

D-A5□/A6□

D-A59W

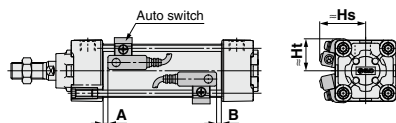

D-F5□/J59

D-F5□W/J59W/F5BA

D-F59F/F5NT

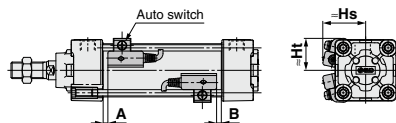

D-P3DWA

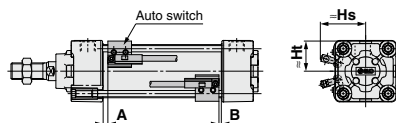

D-P4DW

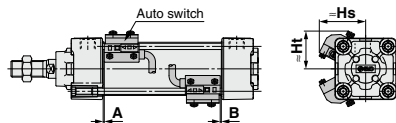

<Band mounting>

D-A3□/G39/K39

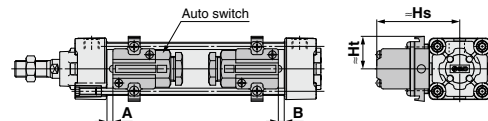

D-A44

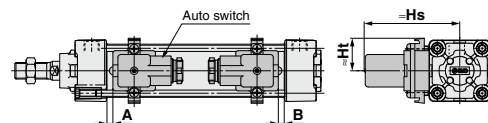

Auto Switch Proper Mounting Position (Detection at stroke end) and Its Mounting Height

Auto Switch Proper Mounting Position (mm)

Auto switch model	D-M9□ D-M9□V D-M9□W D-M9□WV D-M9□A D-M9□AV		D-A9□ D-A9□V		D-A5□ D-A6□		D-A59W		D-F5□ D-J59 D-F59F		D-F5NT		D-A3□ D-A44 D-G39 D-K39		D-Z7□ D-Z8□ D-Y59□ D-Y69□ D-Y7P D-Y7PV D-Y7H D-Y7□W D-Y7□WV		D-P3DWA		D-P4DW	
	A	B	A	B	A	B	A	B	A	B	A	B	A	B	A	B	A	B	A	B
32	10	8	6	4	0	0	4	2	6.5	4.5	11.5	9.5	0	0	3.5	1.5	5.5	3.5	3	1
40	9	9	5	5	0	0	3	3	5.5	5.5	10.5	10.5	0	0	2.5	2.5	4.5	4.5	2	2
50	10	9	6	5	0	0	4	3	6.5	5.5	11.5	10.5	0	0	3.5	2.5	5.5	4.5	3	2
63	10	9	6	5	0	0	4	3	6.5	5.5	11.5	10.5	0	0	3.5	2.5	5.5	4.5	3	2
80	14.5	11.5	10.5	7.5	4.5	1.5	8.5	5.5	11	8	16	13	4.5	1.5	8	5	10	7	7.5	4.5
100	14	12	10	8	4	2	8	6	10.5	8.5	15.5	13.5	4	2	7.5	5.5	9.5	7.5	7	5

Note) Adjust the auto switch after confirming the operating conditions in the actual setting.

Auto Switch Proper Mounting Height (mm)

Auto switch model	D-M9□ D-M9□W D-M9□A D-A9□		D-M9□V D-M9□WV D-M9□AV		D-A9□V		D-A5□ D-A6□ D-A59W		D-F5□ D-J59 D-F59F D-F5□W D-J59W D-F5BA D-F5NT		D-A3□ D-G39 D-K39		D-A44		D-Z7□ D-Z8□ D-Y59□ D-Y7P D-Y7PV D-Y7□W D-Y7BA		D-Y69□ D-Y7PV D-Y7□WV		D-P3DWA		D-P4DW	
	Hs	Ht	Hs	Ht	Hs	Ht	Hs	Ht	Hs	Ht	Hs	Ht	Hs	Ht	Hs	Ht	Hs	Ht	Hs	Ht	Hs	Ht
32	24.5	23	30.5	23	27.5	23	35	24.5	32.5	25	67	27.5	77	27.5	25.5	23	26.5	23	38	31	38	31
40	28.5	25.5	34	25.5	31.5	25.5	38.5	27.5	36.5	27.5	71.5	27.5	81.5	27.5	29.5	26	30	26	39	25.5	42	33
50	33.5	31	38.5	31	36	31	43.5	34.5	41	34	77	—	87	—	33.5	31	34.5	31	43	31	46.5	39
63	38.5	36	43	36	40.5	36	48.5	39.5	46	39	83.5	—	93.5	—	39	36	40	36	48	36	51.5	44
80	46.5	45	52	45	49	45	55	46.5	52.5	46.5	92.5	—	103	—	47.5	45	48.5	45	56.5	45	58	51.5
100	54	53.5	59.5	53.5	57	53.5	62	55	59.5	55	103	—	113.5	—	55.5	53.5	56.5	53.5	64.5	53.5	65.5	60.5

Operating Range (mm)

Auto switch model	Bore size					
	32	40	50	63	80	100
D-M9□/M9□V D-M9□W/M9□WV D-M9□A/M9□AV	4	4.5	5	6	6	6
D-A9□/A9□V	7	7.5	8.5	9.5	9.5	10.5
D-Z7□/Z80	7.5	8.5	7.5	9.5	9.5	10.5
D-A5□/A6□	9	9	10	11	11	11
D-A59W	13	13	13	14	14	15
D-A3□/A44	9	9	10	11	11	11
D-Y59□/Y69□ D-Y7P/Y7□V D-Y7□W/Y7□WV D-Y7BA	5.5	5.5	7	7.5	6.5	5.5
D-F5□/J59 D-F5□W/J59W D-F5BA/F5NT D-F59F	3.5	4	4	4.5	4.5	4.5
D-G39/K39	9	9	9	10	10	11
D-P3DWA	3	4.5	4.5	5	5	5.5
D-P4DW	4	4	4	4.5	4	4.5

* Values which include hysteresis are for guideline purposes only, they are not a guarantee (assuming approximately ±30% dispersion) and may change substantially depending on the ambient environment.

REA

REB

REC

Smooth

Low Speed

MQ

RHC

RZQ

D-□

-X□

Minimum Stroke for Auto Switch Mounting/Mounting Brackets other than Center Trunnion

		n: Number of auto switches (mm)	
Auto switch model	Number of auto switches mounted	Mounting brackets other than center trunnion	
		ø32, ø40, ø50, ø63	ø80, ø100
D-M9□ D-M9□W	2 (Different surfaces, same surface)	15	
	1	15	
D-M9□V D-M9□WV	2 (Different surfaces, same surface)	10	
	1	10	
D-M9□A	2 (Different surfaces, same surface)	15	
	1	15	
D-M9□AV	2 (Different surfaces, same surface)	15	
	1	15	
D-A9□	2 (Different surfaces, same surface)	15	
	1	15	
D-A9□V	2 (Different surfaces, same surface)	10	
	1	10	
D-A3□ D-G39 D-K39	2 (Different surfaces)	35	
	2 (Same surface)	100	
	n (Different surfaces)	$35 + 30(n - 2)$ (n = 2, 3, 4...)	
	n (Same surface)	$100 + 100(n - 2)$ (n = 2, 3, 4...)	
	1	10	
D-A44	2 (Different surfaces)	35	
	2 (Same surface)	55	
	n (Different surfaces)	$35 + 30(n - 2)$ (n = 2, 3, 4...)	
	n (Same surface)	$55 + 50(n - 2)$ (n = 2, 3, 4...)	
	1	10	
D-A5□ D-A6□	2 (Different surfaces, same surface)	15	20
	1	15	20
D-A59W	2 (Different surfaces, same surface)	20	25
	n (Same surface)	$20 + 55 \frac{(n-2)}{2}$ (n = 2, 4, 6, 8...)	$25 + 55 \frac{(n-2)}{2}$ (n = 2, 4, 6, 8...)
	1	15	25
	2 (Different surfaces, same surface)	15	25
	1	15	25
D-F5□ D-J5□ D-F5□W D-J59W D-F5BA D-F59F	2 (Different surfaces, same surface)	15	25
	n (Same surface)	$15 + 55 \frac{(n-2)}{2}$ (n = 2, 4, 6, 8...)	$25 + 55 \frac{(n-2)}{2}$ (n = 2, 4, 6, 8...)
	1	10	25
	2 (Different surfaces, same surface)	15	25
	1	10	25
D-F5NT	2 (Different surfaces, same surface)	15	25
	n (Same surface)	$15 + 55 \frac{(n-2)}{2}$ (n = 2, 4, 6, 8...)	$25 + 55 \frac{(n-2)}{2}$ (n = 2, 4, 6, 8...)
	1	10	25
D-Z7□ D-Z80 D-Y59□ D-Y7P D-Y7W	2 (Different surfaces, same surface)	15	
	1	15	
	n	$15 + 40 \frac{(n-2)}{2}$ (n = 2, 4, 6, 8...)	

Note 1) When "n" is an odd number, an even number that is one larger than this odd number is used for the calculation.

Minimum Stroke for Auto Switch Mounting/Mounting Brackets other than Center Trunnion

n: Number of auto switches (mm)

Auto switch model	Number of auto switches mounted	Mounting brackets other than center trunnion	
		ø32, ø40, ø50, ø63, ø80, ø100	
D-Y69□ D-Y7PV D-Y7□WV	2 (Different surfaces, same surface)	10	
	n	$10 + 30 \frac{(n-2)}{2}$ (n = 2, 4, 6, 8...) ^{Note 1)}	
D-Y7BA	2 (Different surfaces, same surface)	20	
	n	$20 + 45 \frac{(n-2)}{2}$ (n = 2, 4, 6, 8...) ^{Note 1)}	
D-P3DWA	2 (Different surfaces, same surface)	15	
	n	$15 + 50 \frac{(n-2)}{2}$ (n = 2, 4, 6, 8...) ^{Note 1)}	
D-P4DW	2 (Different surfaces, same surface)	15	
	n	$15 + 65 \frac{(n-2)}{2}$ (n = 2, 4, 6, 8...) ^{Note 1)}	

Note 1) When "n" is an odd number, an even number that is one larger than this odd number is used for the calculation.

Minimum Stroke for Auto Switch Mounting/Center Trunnion

n: Number of auto switches (mm)

Auto switch model	Number of auto switches mounted	Center trunnion						
		ø32	ø40	ø50	ø63	ø80	ø100	
D-M9□ D-M9□W	2 (Different surfaces, same surface)	75	80			85	90	95
	n	$75 + 40 \frac{(n-4)}{2}$ (n = 4, 8, 12, 16...) ^{Note 2)}	$80 + 40 \frac{(n-4)}{2}$ (n = 4, 8, 12, 16...) ^{Note 2)}			$85 + 40 \frac{(n-4)}{2}$ (n = 4, 8, 12, 16...) ^{Note 2)}	$90 + 40 \frac{(n-4)}{2}$ (n = 4, 8, 12, 16...) ^{Note 2)}	$95 + 40 \frac{(n-4)}{2}$ (n = 4, 8, 12, 16...) ^{Note 2)}
D-M9□V D-M9□WV	2 (Different surfaces, same surface)	50	55			60	65	70
	n	$50 + 30 \frac{(n-4)}{2}$ (n = 4, 8, 12, 16...) ^{Note 2)}	$55 + 30 \frac{(n-4)}{2}$ (n = 4, 8, 12, 16...) ^{Note 2)}			$60 + 30 \frac{(n-4)}{2}$ (n = 4, 8, 12, 16...) ^{Note 2)}	$65 + 30 \frac{(n-4)}{2}$ (n = 4, 8, 12, 16...) ^{Note 2)}	$70 + 30 \frac{(n-4)}{2}$ (n = 4, 8, 12, 16...) ^{Note 2)}
D-M9□A	2 (Different surfaces, same surface)	80	85			90	95	100
	n	$80 + 40 \frac{(n-4)}{2}$ (n = 4, 8, 12, 16...) ^{Note 2)}	$85 + 40 \frac{(n-4)}{2}$ (n = 4, 8, 12, 16...) ^{Note 2)}			$90 + 40 \frac{(n-4)}{2}$ (n = 4, 8, 12, 16...) ^{Note 2)}	$95 + 40 \frac{(n-4)}{2}$ (n = 4, 8, 12, 16...) ^{Note 2)}	$100 + 40 \frac{(n-4)}{2}$ (n = 4, 8, 12, 16...) ^{Note 2)}
D-M9□AV	2 (Different surfaces, same surface)	55	60			65	70	75
	n	$55 + 30 \frac{(n-4)}{2}$ (n = 4, 8, 12, 16...) ^{Note 2)}	$60 + 30 \frac{(n-4)}{2}$ (n = 4, 8, 12, 16...) ^{Note 2)}			$65 + 30 \frac{(n-4)}{2}$ (n = 4, 8, 12, 16...) ^{Note 2)}	$70 + 30 \frac{(n-4)}{2}$ (n = 4, 8, 12, 16...) ^{Note 2)}	$75 + 30 \frac{(n-4)}{2}$ (n = 4, 8, 12, 16...) ^{Note 2)}
D-A9□	2 (Different surfaces, same surface)	70	75			80	85	95
	n	$70 + 40 \frac{(n-4)}{2}$ (n = 4, 8, 12, 16...) ^{Note 2)}	$75 + 40 \frac{(n-4)}{2}$ (n = 4, 8, 12, 16...) ^{Note 2)}			$80 + 40 \frac{(n-4)}{2}$ (n = 4, 8, 12, 16...) ^{Note 2)}	$85 + 40 \frac{(n-4)}{2}$ (n = 4, 8, 12, 16...) ^{Note 2)}	$95 + 40 \frac{(n-4)}{2}$ (n = 4, 8, 12, 16...) ^{Note 2)}
D-A9□V	2 (Different surfaces, same surface)	45	50			55	60	70
	n	$45 + 30 \frac{(n-4)}{2}$ (n = 4, 8, 12, 16...) ^{Note 2)}	$50 + 30 \frac{(n-4)}{2}$ (n = 4, 8, 12, 16...) ^{Note 2)}			$55 + 30 \frac{(n-4)}{2}$ (n = 4, 8, 12, 16...) ^{Note 2)}	$60 + 30 \frac{(n-4)}{2}$ (n = 4, 8, 12, 16...) ^{Note 2)}	$70 + 30 \frac{(n-4)}{2}$ (n = 4, 8, 12, 16...) ^{Note 2)}

Note 2) When "n" is an odd number, a multiple of 4 that is larger than this odd number is used for the calculation.

- REA
- REB
- REC
- Smooth
- Low Speed
- MQ
- RHC
- RZQ

- D-□
- X□

Minimum Stroke for Auto Switch Mounting/Center Trunnion

		n: Number of auto switches (mm)					
Auto switch model	Number of auto switches mounted	Center trunnion					
		ø32	ø40	ø50	ø63	ø80	ø100
D-A3□ D-G39 D-K39	2 (Different surfaces)	60		65	75	80	85
	2 (Same surface)	90		95	100	105	110
	n (Different surfaces)	$60 + 30(n-2)$ <small>(n = 2, 4, 6, 8...)^{Note 1}</small>		$65 + 30(n-2)$ <small>(n = 2, 4, 6, 8...)^{Note 1}</small>	$75 + 30(n-2)$ <small>(n = 2, 4, 6, 8...)^{Note 1}</small>	$80 + 30(n-2)$ <small>(n = 2, 4, 6, 8...)^{Note 1}</small>	$85 + 30(n-2)$ <small>(n = 2, 4, 6, 8...)^{Note 1}</small>
	n (Same surface)	$90 + 100(n-2)$ <small>(n = 2, 4, 6, 8...)^{Note 1}</small>		$95 + 100(n-2)$ <small>(n = 2, 4, 6, 8...)^{Note 1}</small>	$100 + 100(n-2)$ <small>(n = 2, 4, 6, 8...)^{Note 1}</small>	$105 + 100(n-2)$ <small>(n = 2, 4, 6, 8...)^{Note 1}</small>	$110 + 100(n-2)$ <small>(n = 2, 4, 6, 8...)^{Note 1}</small>
	1	60		65	75	80	85
D-A44	2 (Different surfaces)	70		75		80	85
	2 (Same surface)						
	n (Different surfaces)	$70 + 30(n-2)$ <small>(n = 2, 4, 6, 8...)^{Note 1}</small>		$75 + 30(n-2)$ <small>(n = 2, 4, 6, 8...)^{Note 1}</small>		$80 + 30(n-2)$ <small>(n = 2, 4, 6, 8...)^{Note 1}</small>	$85 + 30(n-2)$ <small>(n = 2, 4, 6, 8...)^{Note 1}</small>
	n (Same surface)	$70 + 50(n-2)$ <small>(n = 2, 4, 6, 8...)^{Note 1}</small>		$75 + 50(n-2)$ <small>(n = 2, 4, 6, 8...)^{Note 1}</small>		$80 + 50(n-2)$ <small>(n = 2, 4, 6, 8...)^{Note 1}</small>	$85 + 50(n-2)$ <small>(n = 2, 4, 6, 8...)^{Note 1}</small>
	1	70		75		80	85
D-A5□ D-A6□	2 (Different surfaces, same surface)		60		80	105	110
	1						115
D-A59W	n (Same surface)	$60 + 55 \frac{(n-4)}{2}$ <small>(n = 4, 8, 12, 16...)^{Note 2}</small>		$80 + 55 \frac{(n-4)}{2}$ <small>(n = 4, 8, 12, 16...)^{Note 2}</small>	$105 + 55 \frac{(n-4)}{2}$ <small>(n = 4, 8, 12, 16...)^{Note 2}</small>	$110 + 55 \frac{(n-4)}{2}$ <small>(n = 4, 8, 12, 16...)^{Note 2}</small>	$115 + 55 \frac{(n-4)}{2}$ <small>(n = 4, 8, 12, 16...)^{Note 2}</small>
	2 (Different surfaces, same surface)	60	70	85	110	115	120
	1	60	70	85	110	115	120
D-F5□/J59 D-F5□W D-J59W D-F5BA D-F59F	2 (Different surfaces, same surface)	90		95	110	115	120
	n (Same surface)	$90 + 55 \frac{(n-4)}{2}$ <small>(n = 4, 8, 12, 16...)^{Note 2}</small>		$95 + 55 \frac{(n-4)}{2}$ <small>(n = 4, 8, 12, 16...)^{Note 2}</small>	$110 + 55 \frac{(n-4)}{2}$ <small>(n = 4, 8, 12, 16...)^{Note 2}</small>	$115 + 55 \frac{(n-4)}{2}$ <small>(n = 4, 8, 12, 16...)^{Note 2}</small>	$120 + 55 \frac{(n-4)}{2}$ <small>(n = 4, 8, 12, 16...)^{Note 2}</small>
	1	90		95	110	115	120
	2 (Different surfaces, same surface)	100		105	120	125	130
D-F5NT	n (Same surface)	$100 + 55 \frac{(n-4)}{2}$ <small>(n = 4, 8, 12, 16...)^{Note 2}</small>		$105 + 55 \frac{(n-4)}{2}$ <small>(n = 4, 8, 12, 16...)^{Note 2}</small>	$120 + 55 \frac{(n-4)}{2}$ <small>(n = 4, 8, 12, 16...)^{Note 2}</small>	$125 + 55 \frac{(n-4)}{2}$ <small>(n = 4, 8, 12, 16...)^{Note 2}</small>	$130 + 55 \frac{(n-4)}{2}$ <small>(n = 4, 8, 12, 16...)^{Note 2}</small>
	1	100		105	120	125	130
	2 (Different surfaces, same surface)	80	85		90	95	100
D-Z7□ D-Z80 D-Y59□ D-Y7P D-Y7□W	1						
	n	$80 + 40 \frac{(n-4)}{2}$ <small>(n = 4, 8, 12, 16...)^{Note 2}</small>	$85 + 40 \frac{(n-4)}{2}$ <small>(n = 4, 8, 12, 16...)^{Note 2}</small>		$90 + 40 \frac{(n-4)}{2}$ <small>(n = 4, 8, 12, 16...)^{Note 2}</small>	$95 + 40 \frac{(n-4)}{2}$ <small>(n = 4, 8, 12, 16...)^{Note 2}</small>	$100 + 40 \frac{(n-4)}{2}$ <small>(n = 4, 8, 12, 16...)^{Note 2}</small>
D-Y69□ D-Y7PV D-Y7□WV	2 (Different surfaces, same surface)	60		65	70	75	85
	1						
	n	$60 + 30 \frac{(n-4)}{2}$ <small>(n = 4, 8, 12, 16...)^{Note 2}</small>		$65 + 30 \frac{(n-4)}{2}$ <small>(n = 4, 8, 12, 16...)^{Note 2}</small>	$70 + 30 \frac{(n-4)}{2}$ <small>(n = 4, 8, 12, 16...)^{Note 2}</small>	$75 + 30 \frac{(n-4)}{2}$ <small>(n = 4, 8, 12, 16...)^{Note 2}</small>	$85 + 30 \frac{(n-4)}{2}$ <small>(n = 4, 8, 12, 16...)^{Note 2}</small>
D-Y7BA	2 (Different surfaces, same surface)	85		90	100	105	110
	1						
	n	$85 + 45 \frac{(n-4)}{2}$ <small>(n = 4, 8, 12, 16...)^{Note 2}</small>		$90 + 45 \frac{(n-4)}{2}$ <small>(n = 4, 8, 12, 16...)^{Note 2}</small>	$100 + 45 \frac{(n-4)}{2}$ <small>(n = 4, 8, 12, 16...)^{Note 2}</small>	$105 + 45 \frac{(n-4)}{2}$ <small>(n = 4, 8, 12, 16...)^{Note 2}</small>	$110 + 45 \frac{(n-4)}{2}$ <small>(n = 4, 8, 12, 16...)^{Note 2}</small>
D-P3DWA	2 (Different surfaces, same surface)	80		85		90	95
	1						
	n	$80 + 50 \frac{(n-4)}{2}$ <small>(n = 4, 8, 12, 16...)^{Note 2}</small>		$85 + 45 \frac{(n-4)}{2}$ <small>(n = 4, 8, 12, 16...)^{Note 2}</small>		$90 + 45 \frac{(n-4)}{2}$ <small>(n = 4, 8, 12, 16...)^{Note 2}</small>	$95 + 50 \frac{(n-4)}{2}$ <small>(n = 4, 8, 12, 16...)^{Note 2}</small>
D-P4DW	2 (Different surfaces, same surface)		120		130		140
	1						
	n	$120 + 65 \frac{(n-4)}{2}$ <small>(n = 4, 8, 12, 16...)^{Note 2}</small>		$130 + 65 \frac{(n-4)}{2}$ <small>(n = 4, 8, 12, 16...)^{Note 2}</small>		$140 + 65 \frac{(n-4)}{2}$ <small>(n = 4, 8, 12, 16...)^{Note 2}</small>	

Note 1) When "n" is an odd number, an even number that is one larger than this odd number is used for the calculation.

Note 2) When "n" is an odd number, a multiple of 4 that is larger than this odd number is used for the calculation.

Auto Switch Mounting Brackets/Part No.

Auto switch model	Bore size (mm)					
	ø32	ø40	ø50	ø63	ø80	ø100
D-M9□W/M9□WV D-M9□A/M9□AV D-M9□/M9□V D-A9□/A9□V	BMB5-032	BMB5-032	BA7-040	BA7-040	BA7-063	BA7-063
D-A3□/A44 D-G39/K39	BMB2-032	BMB2-040	BMB1-050	BMB1-063	BMB1-080	BMB1-100
D-A5□/A6□/A59W D-F5□/J59 D-F5□W/J59W D-F59F/F5BA D-F5NT	BT-03	BT-03	BT-05	BT-05	BT-06	BT-06
D-P3DWA	BA10-032S	BA10-040S	BA10-050S	BA10-050S	BA10-063S	BA10-063S
D-P4DW	BMB3T-040	BMB3T-040	BMB3T-050	BMB3T-050	BMB3T-080	BMB3T-080
D-Z7□/Z80 D-Y59□/Y69□ D-Y7P/Y7PV D-Y7□W/Y7□WV D-Y7BA	BMB4-032	BMB4-032	BMB4-050	BMB4-050	BA4-063	BA4-063

The figure shows the mounting example for the D-A9□(V)/M9□(V)/M9□W(V)/M9□A(V).

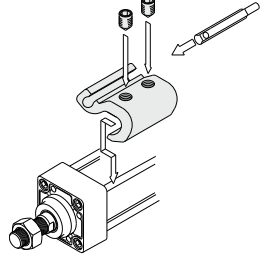

<Mounting example for ø32, D-P3DWA>

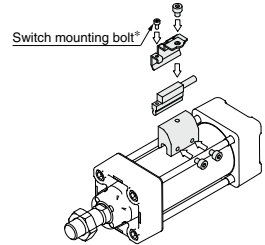

* The switch mounting bolt is supplied with the switch.

[Stainless Steel Mounting Screw]

The following stainless steel mounting screw kit (including set screws) is available. Use it in accordance with the operating environment. (Since the auto switch mounting bracket is not included, order it separately.)

BBA1: For D-A5/A6/F5/J5 types

Note 1) Refer to page 1055 for details on the BBA1.

The above stainless steel screws are used when a cylinder is shipped with the D-F5BA auto switch. When only the auto switch is shipped independently, the BBA1 is attached.

Note 2) When using the D-M9□A(V) or Y7BA, do not use the steel set screws which are included with the auto switch mounting brackets above (BMB5-032, BA7-□□□, BMB4-□□□, BA4-□□□). Order a stainless steel screw kit (BBA1) separately, and use the M4 x 6 L stainless steel set screws included in the BBA1.

- REA
- REB
- REC
- Smooth
- Low Speed
- MQ
- RHC
- RZQ

Other than the applicable auto switches listed in “How to Order”, the following auto switches are mountable.

Refer to pages 941 to 1067 for the detailed specifications.

Type	Model	Electrical entry	Features
Reed	D-A93V/A96V	Grommet (Perpendicular)	—
	D-A90V		Without indicator light
	D-B35	Grommet (In-line)	—
	D-A53/A56/Z73/Z76		Without indicator light
	D-A67/Z80		—
Solid state	D-M9NV/M9PV/M9BV	Grommet (Perpendicular)	—
	D-Y69A/Y69B/Y7PV		Diagnostic indication (2-color indicator)
	D-M9NWV/M9PWW/M9BWW		Water resistant (2-color indicator)
	D-Y7NWV/Y7PWW/Y7BWW		Magnetic field resistant (2-color indicator)
	D-M9NAV/M9PAV/M9BAV		—
	D-P4DW	Grommet (In-line)	—
	D-F59/F5P/J59		Diagnostic indication (2-color indicator)
	D-Y59A/Y59B/Y7P		Water resistant (2-color indicator)
	D-Y7H		With timer
	D-F59W/F5PW/J59W		Diagnostic indication (2-color indicator)
	D-Y7NW/Y7PW/Y7BW		Water resistant (2-color indicator)
	D-F5BA/Y7BA		With timer
	D-F5NT		Magnetic field resistant (2-color indicator)
	D-P5DW		—

* With pre-wired connector is also available for solid state auto switches. For details, refer to pages 1014 and 1015.

* Normally closed (NC = b contact) solid state auto switches (D-M9□E(V)/Y7G/Y7H) are also available. For details, refer to pages 1592-1 and 961.

- D-□
- X□

Smooth Cylinder

CA2Y Series

ø40, ø50, ø63, ø80, ø100



How to Order

CA2Y B 40 - 150 Z -

With auto switch CDA2Y B 40 - 150 Z - M9BW -

With auto switch (Built-in magnet)

Mounting

B	Basic
L	Axial foot
F	Rod flange
G	Head flange
C	Single clevis
D	Double clevis
T	Center trunnion

Bore size

40	40 mm
50	50 mm
63	63 mm
80	80 mm
100	100 mm

Port thread type

Nil	Rc
TN	NPT
TF	G

Accessories 1

Nil	No bracket
N	Pivot bracket

* Only for D and T mounting types
* Pivot bracket is shipped together with the product, but not assembled.

Accessories 2

Nil	No bracket
V	Single knuckle joint
W	Double knuckle joint

* A knuckle joint pin is not provided with the single knuckle joint.
* Rod end bracket is shipped together with the product, but not assembled.

Cylinder stroke (mm)
Refer to "Standard Strokes" on page 199.

Made to Order
Refer to page 199 for details.

Number of auto switches

Nil	2 pcs.
S	1 pc.
3	3 pcs.
n	"n" pcs.

Auto switch

Nil	Without auto switch
-----	---------------------

* For applicable auto switches, refer to the table below.

Built-in Magnet Cylinder Model

If a built-in magnet cylinder without an auto switch is required, there is no need to enter the symbol for the auto switch. (Example) CDA2YB40-100Z

*** Refer to "Ordering Example of Cylinder Assembly" on page 200.**

Applicable Auto Switches/Refer to pages 941 to 1067 for further information on auto switches.

Type	Special function	Electrical entry	Indicator light	Wiring (Output)	Load voltage		Auto switch model		Lead wire length (m)					Pre-wired connector	Applicable load		
					DC	AC	Tie-rod mounting	Band mounting	0.5 (Nil)	1 (M)	3 (L)	5 (Z)					
Solid state auto switch	—	Grommet	—	3-wire (NPN)	24 V	5 V, 12 V	—	M9N	●	●	●	○	○	IC circuit	—		
				3-wire (PNP)				M9P	●	●	●	○	○				
				2-wire	M9B	●	●	●	○	○							
		Terminal conduit		3-wire (NPN)	12 V	—	G39C	G39	—	—	—	—	—			—	
				2-wire			K39C	K39	—	—	—	—	—			—	
				3-wire (NPN)	5 V, 12 V	—	M9NW	●	●	●	○	○					
	3-wire (PNP)	M9PW	●	●			●	○	○								
	Diagnostic indication (2-color indicator)	Yes	Grommet	—	2-wire	24 V	12 V	—	M9B	●	●	●	○	○	IC circuit	Relay, PLC	
					3-wire (NPN)				M9NW	●	●	●	○	○			
					3-wire (PNP)	M9PW	●	●	●	○	○						
		Water resistant (2-color indicator)	Grommet		2-wire	24 V	12 V	—	M9B	●	●	●	○	○	—		
					3-wire (NPN)				M9NA*1	○	○	○	●	●			
3-wire (PNP)					M9PA*1	○	○	○	●	●							
With diagnostic output (2-color indicator)	Grommet	2-wire	24 V	12 V	—	M9B	●	●	●	○	○	IC circuit					
		4-wire (NPN)				F59F	●	●	●	○	○						
		2-wire (Non-polar)	P3DWA	●	●	●	○	○									
		—	P4DW	●	●	●	○	○									
Reed auto switch	—	Grommet	Yes	3-wire (NPN equivalent)	24 V	12 V	—	A96	●	●	●	—	—	IC circuit	—		
				—				A93	●	●	●	—	—				
				Terminal conduit	100 V or less	24 V	12 V	—	A90	●	●	●	—	—	IC circuit		
					100 V, 200 V				A54	B54	●	●	●	—		—	
					200 V or less				A64	B64	●	●	●	—		—	
		DIN terminal		Grommet	—	24 V	12 V	—	A33C	A33	●	●	●	—	—	—	PLC
					—				A34C	A34	●	●	●	—	—		
		Diagnostic indication (2-color indicator)		Grommet	—	24 V	12 V	—	A44C	A44	●	●	●	—	—	—	Relay, PLC
					—				A59W	B59W	●	●	●	—	—		
					—				—	—	—	—	—	—	—		

*1 Water resistant type auto switches can be mounted on the above models, but in such case SMC cannot guarantee water resistance. Please consult with SMC regarding water resistant types with the above model numbers.

* Lead wire length symbols: 0.5 m..... Nil (Example) M9NW
1 m..... M (Example) M9NWM
3 m..... L (Example) M9NWL
5 m..... Z (Example) M9NWZ

* Solid state auto switches marked with "○" are produced upon receipt of order.

* Since there are other applicable auto switches then listed above, refer to page 211 for details.

* For details about auto switches with pre-wired connector, refer to pages 1014 and 1015.

* The D-A9□M9□□□/P3DWA□ auto switches are shipped together, (but not assembled). (However, only the auto switch mounting brackets are assembled for the D-A9□M9□□□ before shipment.)





Symbol

Without cushion

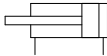

Made to Order
[Click here for details](#)

Symbol	Specifications
-XA□	Change of rod end shape
-XC7	Tie-rod, Cushion valve, Tie-rod nut, etc. made of stainless steel
-XC14	Change of trunnion bracket mounting position
-XC15	Change of tie-rod length
-XC27	Double clevis and double knuckle joint pins made of stainless steel
-XC28	Compact flange made of SS400
-XC29	Double knuckle joint with spring pin
-XC30	Rod trunnion
-XC65	Made of stainless steel (Combination of XC7 and XC68)
-XC68	Made of stainless steel (with hard chrome plated piston rod)

Replacement Parts/Seal Kit

Bore size (mm)	Kit no.	Contents
40	CA2Y40Z-PS	Rod seal 1 pc.
50	CA2Y50Z-PS	Piston seal 1 pc.
63	CA2Y63Z-PS	Cylinder tube gasket 2 pcs.
80	CA2Y80Z-PS	Grease pack (10 g) 1 pc.
100	CA2Y100Z-PS	

When maintenance requires only grease, use the following part numbers to order.

Grease pack part number: GR-L-005 (5 g)
 GR-L-010 (10 g)
 GR-L-150 (150 g)

Specifications

Bore size (mm)	40	50	63	80	100
Action	Double acting				
Piston speed	5 to 500 mm/s				
Fluid	Air				
Proof pressure	1.05 MPa				
Maximum operating pressure	0.7 MPa				
Ambient and fluid temperature	Without auto switch: -10°C to 70°C (No freezing) With auto switch: -10°C to 60°C				
Cushion	None				
Lubrication	Not required (Non-lube)				
Mounting	Basic, Axial foot, Rod flange, Head flange Single clevis, Double clevis, Center trunnion				
Allowable leakage rate	0.5 L/min (ANR)				

Minimum Operating Pressure

Bore size (mm)	40	50	63	80	100
Minimum operating pressure	0.02			0.01	

Unit: MPa

Standard Strokes

Bore size (mm)	Standard stroke (mm)	Max. manufacturable stroke (mm)
40	25, 50, 75, 100, 125, 150, 175, 200, 250, 300, 350, 400, 450, 500	1000
50, 63	25, 50, 75, 100, 125, 150, 175, 200, 250, 300, 350, 400, 450, 500, 600	1000
80, 100	25, 50, 75, 100, 125, 150, 175, 200, 250, 300, 350, 400, 450, 500, 600, 700	1000

Note 1) Intermediate strokes not listed above are also available.

Please consult with SMC for strokes outside the above ranges.

Note 2) Applicable strokes should be confirmed according to the usage. For details, refer to "Air Cylinders Model Selection" on front matter pages of the Best Pneumatics No. 2-1. In addition, the products that exceed the standard stroke might not be able to fulfill the specifications due to the deflection etc.

Accessories For details, refer to page 206.

Mounting		Basic	Foot	Rod flange	Head flange	Single clevis	Double clevis	Center trunnion
Standard	Rod end nut	●	●	●	●	●	●	●
	Clevis pin	—	—	—	—	—	●	—
Option	Single knuckle joint	●	●	●	●	●	●	●
	Double knuckle joint (with pin)	●	●	●	●	●	●	●

REA

REB

REC

Smooth

Low Speed

MQ

RHC

RZQ

D-□

-X□

CA2Y Series

Ordering Example of Cylinder Assembly

Cylinder model:
CDA2YD40-150Z-NW-M9BW

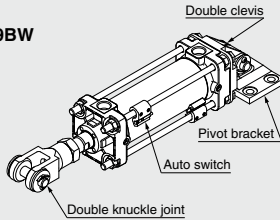

Mounting D: Double clevis
Pivot bracket N: Yes
Rod end bracket W: Double knuckle joint
Auto switch D-M9BW: 2 pcs.

* Pivot bracket, double knuckle joint and auto switch are shipped together with the product, but not assembled.

Weights/Aluminum Tube

Bore size (mm)		40	50	63	80	100
Basic weight	Basic	0.73	1.06	1.53	2.73	3.71
	Axial foot	0.91	1.25	1.83	3.40	4.64
	Flange	1.09	1.48	2.28	4.18	5.57
	Single clevis	0.95	1.37	2.12	3.84	5.43
	Double clevis	0.99	1.46	2.28	4.13	5.95
	Trunnion	1.08	1.51	2.29	4.28	5.93
Additional weight per 50 mm of stroke	All mounting brackets	0.20	0.25	0.31	0.46	0.58
Accessories	Single knuckle joint	0.23	0.26	0.26	0.60	0.83
	Double knuckle joint (with pin)	0.37	0.43	0.43	0.87	1.27

Calculation (Example) CA2YL40-100Z (Axial foot, ø40, 100 st)

- Basic weight.....0.91kg
- Additional weight.....0.20/50 stroke
- Cylinder stroke.....100 stroke

$$\frac{0.91 + 0.20 \times 100/50}{1} = 1.31 \text{ kg}$$

Basic: CA2YB

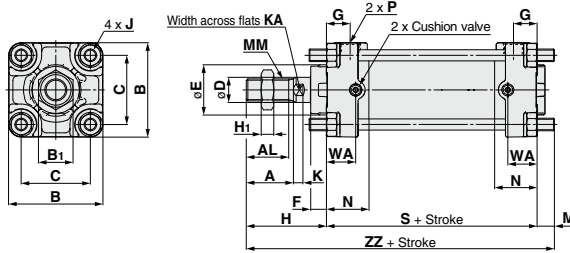

Bore size (mm)	A	AL	B	B ₁	C	D	E	F	G	H	H ₁	J	K	KA
40	30	27	60	22	44	16	32	10	15	51	8	M8 x 1.25	6	14
50	35	32	70	27	52	20	40	10	17	58	11	M8 x 1.25	7	18
63	35	32	85	27	64	20	40	10	17	58	11	M10 x 1.25	7	18
80	40	37	102	32	78	25	52	14	21	71	13	M12 x 1.75	10	22
100	40	37	116	41	92	30	52	14	21	72	16	M12 x 1.75	10	26

Bore size (mm)	M	MM	N	P	S	WA	ZZ
40	11	M14 x 1.5	27	1/4	84	18.5	146
50	11	M18 x 1.5	30	3/8	90	18.5	159
63	14	M18 x 1.5	31	3/8	98	23	170
80	17	M22 x 1.5	37	1/2	116	28.5	204
100	17	M26 x 1.5	40	1/2	126	28.5	215

Axial Foot: CA2YL

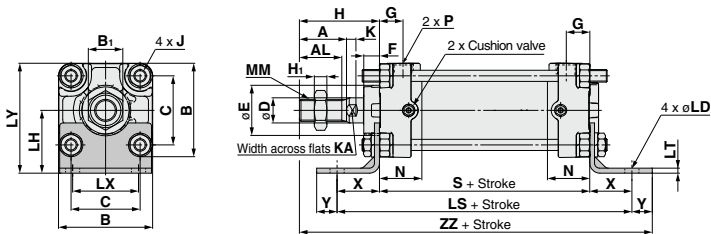

Bore size (mm)	A	AL	B	B ₁	C	D	E	F	G	H	H ₁	J	K	KA	LD	LH	LS	LT
40	30	27	60	22	44	16	32	10	15	51	8	M8 x 1.25	6	14	9	40	138	3.2
50	35	32	70	27	52	20	40	10	17	58	11	M8 x 1.25	7	18	9	45	144	3.2
63	35	32	85	27	64	20	40	10	17	58	11	M10 x 1.25	7	18	11.5	50	166	3.2
80	40	37	102	32	78	25	52	14	21	71	13	M12 x 1.75	10	22	13.5	65	204	4.5
100	40	37	116	41	92	30	52	14	21	72	16	M12 x 1.75	10	26	13.5	75	212	6

Bore size (mm)	LX	LY	MM	N	P	S	X	Y	ZZ
40	42	70	M14 x 1.5	27	1/4	84	27	13	175
50	50	80	M18 x 1.5	30	3/8	90	27	13	188
63	59	93	M18 x 1.5	31	3/8	98	34	16	206
80	76	116	M22 x 1.5	37	1/2	116	44	16	247
100	92	133	M26 x 1.5	40	1/2	126	43	17	258

- REA
- REB
- REC
- Smooth
- Low Speed
- MQ
- RHC
- RZQ

- D
- X

CA2Y Series

Rod Flange: CA2YF

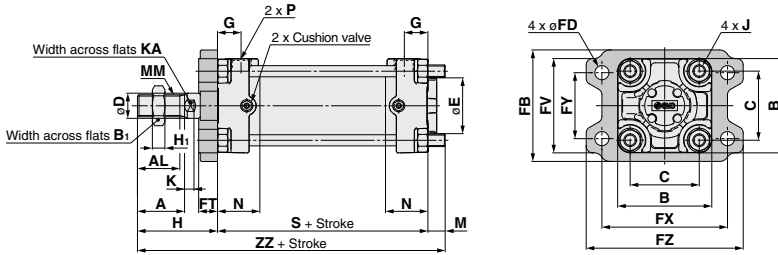

Bore size (mm)	A	AL	B	B ₁	C	D	E	FB	FD	FT	FV	FX	FY	FZ	G	H	H ₁	J	K
40	30	27	60	22	44	16	32	71	9	12	60	80	42	100	15	51	8	M8 x 1.25	6
50	35	32	70	27	52	20	40	81	9	12	70	90	50	110	17	58	11	M8 x 1.25	7
63	35	32	85	27	64	20	40	101	11.5	15	86	105	59	130	17	58	11	M10 x 1.25	7
80	40	37	102	32	78	25	52	119	13.5	18	102	130	76	160	21	71	13	M12 x 1.75	10
100	40	37	116	41	92	30	52	133	13.5	18	116	150	92	180	21	72	16	M12 x 1.75	10

Bore size (mm)	KA	M	MM	N	P	S	ZZ
40	14	11	M14 x 1.5	27	1/4	84	146
50	18	11	M18 x 1.5	30	3/8	90	159
63	18	14	M18 x 1.5	31	3/8	98	170
80	22	17	M22 x 1.5	37	1/2	116	204
100	26	17	M26 x 1.5	40	1/2	126	215

Head Flange: CA2YG

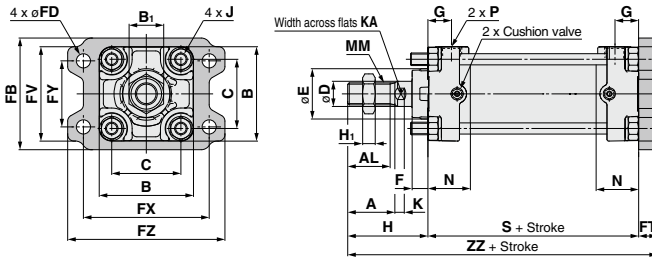

Bore size (mm)	A	AL	B	B ₁	C	D	E	F	FB	FD	FT	FV	FX	FY	FZ	G	H	H ₁
40	30	27	60	22	44	16	32	10	71	9	12	60	80	42	100	15	51	8
50	35	32	70	27	52	20	40	10	81	9	12	70	90	50	110	17	58	11
63	35	32	85	27	64	20	40	10	101	11.5	15	86	105	59	130	17	58	11
80	40	37	102	32	78	25	52	14	119	13.5	18	102	130	76	160	21	71	13
100	40	37	116	41	92	30	52	14	133	13.5	18	116	150	92	180	21	72	16

Bore size (mm)	J	K	KA	MM	N	P	S	ZZ
40	M8 x 1.25	6	14	M14 x 1.5	27	1/4	84	147
50	M8 x 1.25	7	18	M18 x 1.5	30	3/8	90	160
63	M10 x 1.25	7	18	M18 x 1.5	31	3/8	98	171
80	M12 x 1.75	10	22	M22 x 1.5	37	1/2	116	205
100	M12 x 1.75	10	26	M26 x 1.5	40	1/2	126	216

Single Clevis: CA2YC

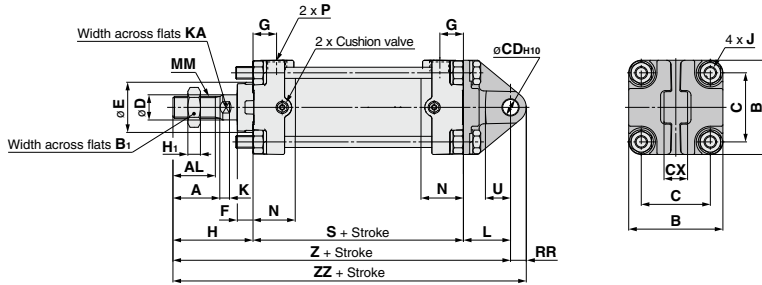

Bore size (mm)	A	AL	B	B ₁	C	CDH ₁₀	CX	D	E	F	G	H	H ₁	J	K	KA
40	30	27	60	22	44	10 ^{+0.058} ₀	15 ^{+0.1} _{-0.3}	16	32	10	15	51	8	M8 x 1.25	6	14
50	35	32	70	27	52	12 ^{+0.070} ₀	18 ^{+0.1} _{-0.3}	20	40	10	17	58	11	M8 x 1.25	7	18
63	35	32	85	27	64	16 ^{+0.070} ₀	25 ^{+0.1} _{-0.3}	20	40	10	17	58	11	M10 x 1.25	7	18
80	40	37	102	32	78	20 ^{+0.084} ₀	31.5 ^{+0.1} _{-0.3}	25	52	14	21	71	13	M12 x 1.75	10	22
100	40	37	116	41	92	25 ^{+0.084} ₀	35.5 ^{+0.1} _{-0.3}	30	52	14	21	72	16	M12 x 1.75	10	26

Bore size (mm)	L	MM	N	P	RR	S	U	Z	ZZ
40	30	M14 x 1.5	27	1/4	10	84	16	165	175
50	35	M18 x 1.5	30	3/8	12	90	19	183	195
63	40	M18 x 1.5	31	3/8	16	98	23	196	212
80	48	M22 x 1.5	37	1/2	20	116	28	235	255
100	58	M26 x 1.5	40	1/2	25	126	36	256	281

- REA
- REB
- REC
- Smooth
- Low Speed
- MQ
- RHC
- RZQ

Double Clevis: CA2YD

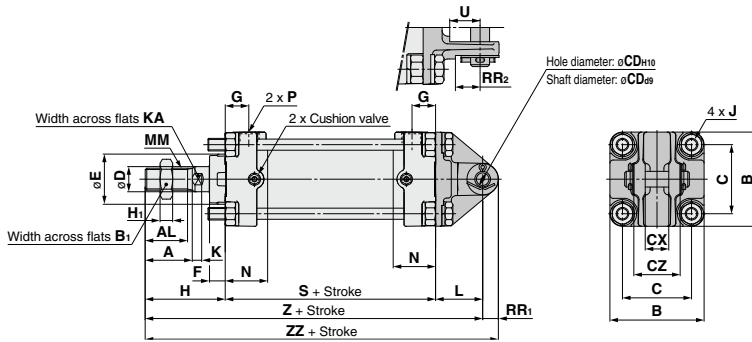

* A pin and retaining rings are shipped together with double clevis and/or double knuckle joint.

Bore size (mm)	A	AL	B	B ₁	C	CDH ₁₀	CX	CZ	D	E	F	G	H	H ₁	J	K	KA
40	30	27	60	22	44	10 ^{+0.058} ₀	15 ^{+0.3} _{-0.1}	29.5	16	32	10	15	51	8	M8 x 1.25	6	14
50	35	32	70	27	52	12 ^{+0.070} ₀	18 ^{+0.3} _{-0.1}	38	20	40	10	17	58	11	M8 x 1.25	7	18
63	35	32	85	27	64	16 ^{+0.070} ₀	25 ^{+0.3} _{-0.1}	49	20	40	10	17	58	11	M10 x 1.25	7	18
80	40	37	102	32	78	20 ^{+0.084} ₀	31.5 ^{+0.3} _{-0.1}	61	25	52	14	21	71	13	M12 x 1.75	10	22
100	40	37	116	41	92	25 ^{+0.084} ₀	35.5 ^{+0.3} _{-0.1}	64	30	52	14	21	72	16	M12 x 1.75	10	26

Bore size (mm)	L	MM	N	P	RR ₁	RR ₂	S	U	Z	ZZ
40	30	M14 x 1.5	27	1/4	10	16	84	16	165	175
50	35	M18 x 1.5	30	3/8	12	19	90	19	183	195
63	40	M18 x 1.5	31	3/8	16	23	98	23	196	212
80	48	M22 x 1.5	37	1/2	20	28	116	28	235	255
100	58	M26 x 1.5	40	1/2	25	23.5	126	36	256	281

* A clevis pin, flat washers and split pins are included.

- D-□
- X□

CA2Y Series

Center Trunnion: CA2YT

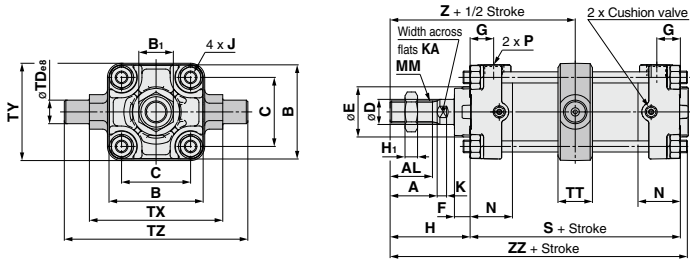

Bore size (mm)	A	AL	B	B ₁	C	D	E	F	G	H	H ₁	J	K	KA	MM	N	P
40	30	27	60	22	44	16	32	10	15	51	8	M8 x 1.25	6	14	M14 x 1.5	27	1/4
50	35	32	70	27	52	20	40	10	17	58	11	M8 x 1.25	7	18	M18 x 1.5	30	3/8
63	35	32	85	27	64	20	40	10	17	58	11	M10 x 1.25	7	18	M18 x 1.5	31	3/8
80	40	37	102	32	78	25	52	14	21	71	13	M12 x 1.75	10	22	M22 x 1.5	37	1/2
100	40	37	116	41	92	30	52	14	21	72	16	M12 x 1.75	10	26	M26 x 1.5	40	1/2

Bore size (mm)	S	TDø8	TT	TX	TY	TZ	Z	ZZ
40	84	15 ^{+0.032} / _{-0.050}	22	85	62	117	93	140
50	90	15 ^{+0.032} / _{-0.050}	22	95	74	127	103	154
63	98	18 ^{+0.032} / _{-0.050}	28	110	90	148	107	162
80	116	25 ^{+0.040} / _{-0.072}	34	140	110	192	129	194
100	126	25 ^{+0.040} / _{-0.072}	40	162	130	214	135	206

* Do not disassemble the trunnion type. (Refer to the standard type.)

Trunnion and Double Clevis Pivot Bracket

- Strength is the same as cylinder brackets.

Type

Bore size	CA2□40	CA2□50	CA2□63	CA2□80	CA2□100
Description	CA2-S04		CA2-S06	MB-S10	
Trunnion pivot bracket	CA2-B04		CA2-B05	CA2-B08	CA2-B10

* Order 2 trunnion pivot brackets per cylinder.

Trunnion pivot bracket

Material: Cast iron

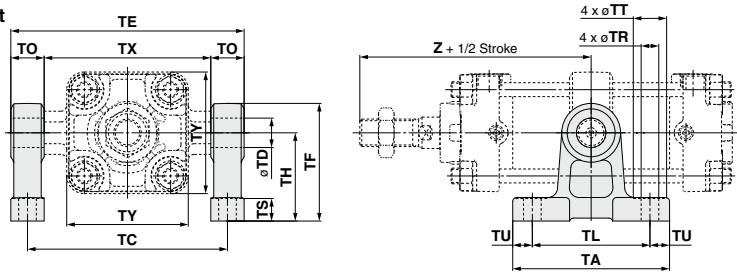

(mm)

Part no.	Bore size (mm)	TA	TL	TU	TC	TX	TE	TO	TR	TT	TS	TH	TF	TY	Z	TD-H10 (Hole)
CA2-S04	40	80	60	10	102	85	119	17	9	17	12	45	60	62	93	15 ^{+0.070} ₀
	50	80	60	10	112	95	129	17	9	17	12	45	60	74	103	15 ^{+0.070} ₀
CA2-S06	63	100	70	15	130	110	150	20	11	22	14	55	73	90	107	18 ^{+0.070} ₀
	80	120	90	15	166	140	192	26	13.5	24	17	75	100	110	129	25 ^{+0.084} ₀
MB-S10	100	120	90	15	188	162	214	26	13.5	24	17	75	100	130	135	25 ^{+0.084} ₀

Double clevis pivot bracket

Material: Cast iron

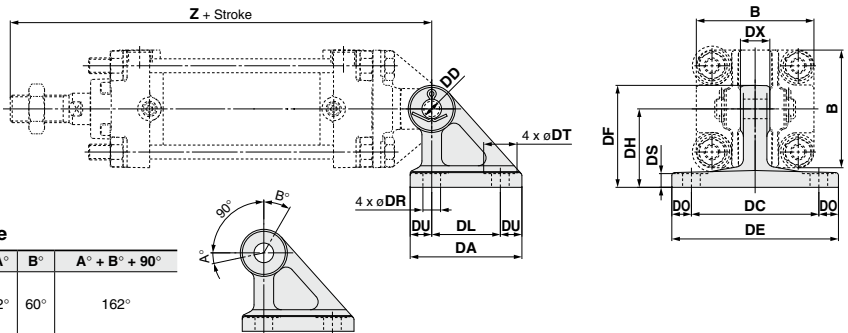

Rotating Angle

Bore size (mm)	A°	B°	A° + B° + 90°
40 to 100	12°	60°	162°

(mm)

Part no.	Bore size (mm)	DA	DL	DU	DC	DX	DE	DO	DR	DT	DS	DH	DF	B	Z	DDH10 (Hole)
CA2-B04	40	57	35	11	65	15	85	10	9	17	8	40	52	60	165	10 ^{+0.058} ₀
CA2-B05	50	57	35	11	65	18	85	10	9	17	8	40	52	70	183	12 ^{+0.070} ₀
CA2-B06	63	67	40	13.5	80	25	105	12.5	11	22	10	50	66	85	196	16 ^{+0.070} ₀
CA2-B08	80	93	60	16.5	100	31.5	130	15	13.5	24	12	65	90	102	235	20 ^{+0.084} ₀
CA2-B10	100	93	60	16.5	100	35.5	130	15	13.5	24	12	65	90	116	256	25 ^{+0.084} ₀

REA

REB

REC

Smooth

Low Speed

MQ

RHC

RZQ

D-□

-X□

CA2Y Series

Dimensions of Accessories

Y Type Double Knuckle Joint

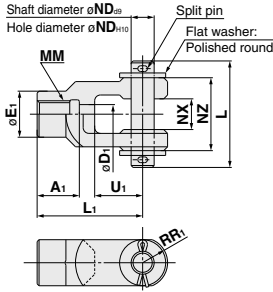

Material: Cast iron (mm)

Part no.	Applicable bore size (mm)	Bore size				MM	RR ₁	U ₁	ND	NX	NZ	L	Split pin size	Flat washer size
		A ₁	E ₁	D ₁	L ₁									
Y-04D	40	22	24	10	55	M14 x 1.5	13	25	12	16 ^{+0.3} _{-0.1}	38	55.5	ø3 x 18 ℓ	Polished round 12
Y-05D	50, 63	27	28	14	60	M18 x 1.5	15	27	12	16 ^{+0.3} _{-0.1}	38	55.5	ø3 x 18 ℓ	Polished round 12
Y-08D	80	37	36	18	71	M22 x 1.5	19	28	18	28 ^{+0.3} _{-0.1}	55	76.5	ø4 x 25 ℓ	Polished round 18
Y-10D	100	37	40	21	83	M26 x 1.5	21	38	20	30 ^{+0.3} _{-0.1}	61	83	ø4 x 30 ℓ	Polished round 20

* A knuckle pin, split pins and flat washers are included.

Clevis Pin/Knuckle Pin

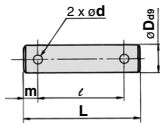

Material: Carbon steel (mm)

Part no.	Applicable bore size		Dd9	L	ℓ	m	d Drill through	Included split pin	Included flat washer
	Clevis	Knuckle							
CDP-2A	40	—	10 ^{-0.040} _{-0.076}	46	38	4	3	ø3 x 18 ℓ	Polished round 10
CDP-3A	50	40, 50, 63	12 ^{-0.050} _{-0.099}	55.5	47.5	4	3	ø3 x 18 ℓ	Polished round 12
CDP-4A	63	—	16 ^{-0.050} _{-0.093}	71	61	5	4	ø4 x 25 ℓ	Polished round 16
CDP-5A	—	80	18 ^{-0.050} _{-0.099}	76.5	66.5	5	4	ø4 x 25 ℓ	Polished round 18
CDP-6A	80	100	20 ^{-0.065} _{-0.117}	83	73	5	4	ø4 x 30 ℓ	Polished round 20
CDP-7A	100	—	25 ^{-0.065} _{-0.117}	88	78	5	4	ø4 x 36 ℓ	Polished round 24

* Split pins and flat washers are included.

I Type Single Knuckle Joint

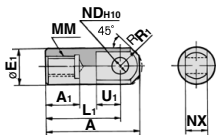

Material: Free cutting sulfur steel (mm)

Part no.	Applicable bore size (mm)	Bore size				MM	R ₁	U ₁	ND#110	NX
		A	E ₁	L ₁	L					
I-04A	40	69	22	24	55	M14 x 1.5	15.5	20	12 ^{+0.070} _{-0.1}	16 ^{-0.1} _{-0.3}
I-05A	50, 63	74	27	28	60	M18 x 1.5	15.5	20	12 ^{+0.070} _{-0.1}	16 ^{-0.1} _{-0.3}
I-08A	80	91	37	36	71	M22 x 1.5	22.5	26	18 ^{+0.070} _{-0.1}	28 ^{-0.1} _{-0.3}
I-10A	100	105	37	40	83	M26 x 1.5	24.5	28	20 ^{+0.084} _{-0.1}	30 ^{-0.1} _{-0.3}

Rod End Nut (Standard)

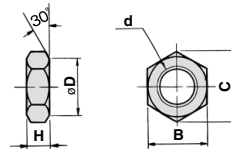

Material: Rolled steel (mm)

Part no.	Applicable bore size (mm)	d	H	Bore size		
				B	C	D
NT-04	40	M14 x 1.5	8	22	25.4	21
NT-05	50, 63	M18 x 1.5	11	27	31.2	26
NT-08	80	M22 x 1.5	13	32	37.0	31
NT-10	100	M26 x 1.5	16	41	47.3	39

CA2Y Series Auto Switch Mounting

Auto Switch Proper Mounting Position (Detection at stroke end) and Its Mounting Height

<Tie-rod mounting>

- D-M9□/M9□V D-Z7□/Z80
 D-M9□W/M9□WV D-Y59□/Y69□/Y7P/Y7PV
 D-M9□A/M9□AV D-Y7□W/Y7□WV
 D-A9□/A9□V D-Y7BA

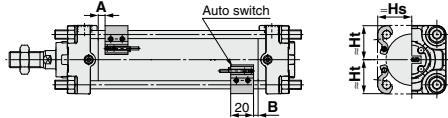

- D-A5□/A6□
 D-A59W

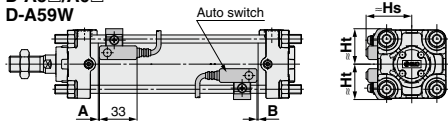

- D-A3□C
 D-G39C/K39C

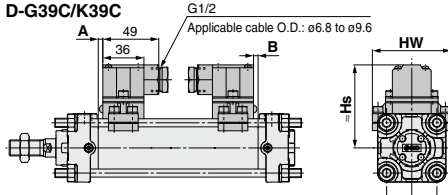

- D-F5□/J59 D-F5□W/J59W
 D-F5NT D-F5BA/F59F

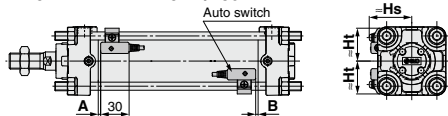

- D-A44C

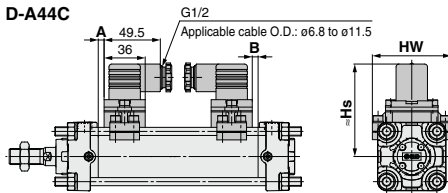

- D-P3DWA

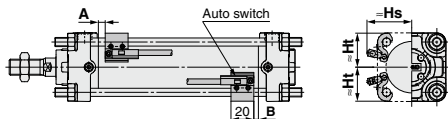

- D-P4DW

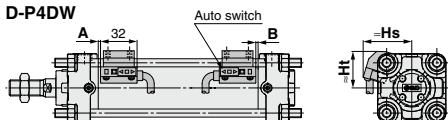

<Band mounting>

- D-B5□/B64/B59W

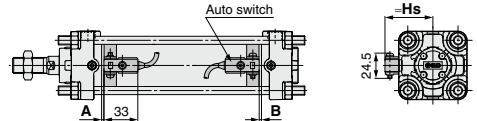

- D-A3□
 D-G39/K39

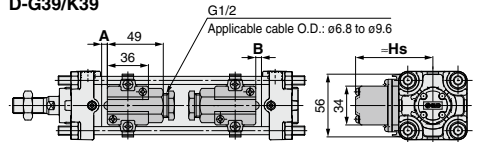

- D-G5□/K59
 D-G5□W/K59W

- D-G5BAL
 D-G59F/G5NTL

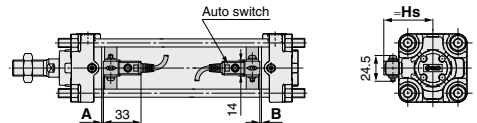

- D-A44

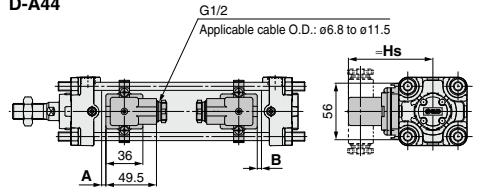

REA

REB

REC

Smooth

Low Speed

MQ

RHC

RZQ

D-□

-X□

CA2Y Series

Auto Switch Proper Mounting Position (Detection at stroke end) and Its Mounting Height

Auto Switch Proper Mounting Position

(mm)

Auto switch model	D-M9□ D-M9□V D-M9□WV D-M9□A D-M9□AV		D-A9□ D-A9□V		D-Y59□ D-Y69□ D-Y7P D-Y7PV D-Y7□WV D-Y7BA D-Z7□ D-Z80 D-B59W		D-P3DWA		D-P4DW		D-F5□ D-J59 D-F59F D-F5□W D-J59W D-F5BA		D-A59W		D-F5NT		D-G39 D-G39C D-K39 D-K39C D-A5□ D-A6□ D-A3□ D-A3□C D-A44 D-A44C		D-G5□ D-K59 D-G5NT D-G5□W D-K59W D-G5BA D-G59F		D-B5□ D-B64	
	A	B	A	B	A	B	A	B	A	B	A	B	A	B	A	B	A	B	A	B	A	B
40	9	9	5	5	2.5	2.5	4.5	4.5	2	2	5.5	5.5	3	3	10.5	10.5	0	0	1	1	0	0
50	9.5	8.5	5.5	4.5	3	2	5	4	2.5	1.5	6	5	3.5	2.5	11	10	0	0	1.5	0.5	0	0
63	12.5	11.5	8.5	7.5	6	5	8	7	5.5	4.5	9	8	6.5	5.5	14	13	2.5	1.5	4.5	3.5	3	2
80	16.5	13.5	12.5	9.5	10	7	12	9	9.5	6.5	13	10	10.5	7.5	18	15	6.5	3.5	8.5	5.5	7	4
100	18	16	14	12	11.5	9.5	13.5	11.5	11	9	14.5	12.5	12	10	19.5	17.5	8	6	10	8	8.5	6.5

Note) Adjust the auto switch after confirming the operating conditions in the actual setting.

Auto Switch Mounting Height

(mm)

Auto switch model	D-M9□ D-M9□V D-M9□WV D-M9□A D-A9□		D-M9□V D-M9□WV D-M9□AV		D-A9□V		D-Z7□ D-Z80 D-Y59□ D-Y7P D-Y7BA D-Y7□W		D-Y69□ D-Y7PV D-Y7□WV		D-P3DWA		D-P4DW		D-B5□ D-B64 D-B59W D-G5□ D-K59 D-G5NT D-G5□W D-K59W D-G5BA D-G59F		D-A3□ D-G39 D-K39		D-A44		D-A5□ D-A6□ D-A59W		D-F5□ D-J59 D-F5□W D-F5BA D-F59F D-F5NT		D-A3□C D-G39C D-K39C		D-A44C		
	Hs	Ht	Hs	Ht	Hs	Ht	Hs	Ht	Hs	Ht	Hs	Ht	Hs	Ht	Hs	Hs	Hs	Ht	Hs	Ht	Hs	Ht	Hs	Ht	Hs	Ht	Hs	Ht	Hs
40	30	30	34	30	31	30	30	30	30	37.5	35	42.5	33	37	71.5	81.5	81.5	38.5	31.5	38	31.5	73	69	81	69				
50	34	34	38	34	35	34	34	34	34	41.5	39	46.5	37.5	42	76.5	86.5	42	35.5	42	35.5	78.5	77	86.5	77					
63	41	41	44	41	41.5	41	41	41	41	50	41	52	43	49	83.5	93.5	46.5	43	47	43	85.5	91	93.5	91					
80	49.5	49	52.5	49	50	49	49.5	49	49.5	58	49	58.5	51.5	57.5	92	102	53.5	51	53.5	51	94	107	102	107					
100	56.5	56	61	56	58.5	56	56.5	55.5	57.5	66	56	66	58.5	68	102.5	112.5	61.5	57.5	61	57.5	104	121	112	121					

Operating Range

(mm)

Auto switch model	Bore size				
	40	50	63	80	100
D-M9□/M9□V D-M9□W/M9□WV D-M9□A/M9□AV	4.5	5	5.5	5	6
D-A9□/A9□V	7.5	8.5	9.5	9.5	10.5
D-Z7□/Z80	8.5	7.5	9.5	9.5	10.5
D-A3□/A44 D-A3□C/A44C	9	10	11	11	11
D-A5□/A6□					
D-B5□/B64					
D-A59W	13	13	14	14	15
D-B59W	14	14	17	16	18

Auto switch model	Bore size				
	40	50	63	80	100
D-Y59□/Y69□ D-Y7P/Y7□V D-Y7□W/Y7□WV D-Y7BA	8	7	5.5	6.5	6.5
D-F5□/J59/F5□W D-J59W/F5BA D-F5NT/F59F	4	4	4.5	4.5	4.5
D-G5□/K59/G5□W D-K59W/G5BA D-G5NT/G59F	5	6	6.5	6.5	7
D-G39/K39 D-G39C/K39C	9	9	10	10	11
D-P3DWA	4.5	4.5	5.5	5.5	5.5
D-P4DW	4	4	4.5	4	4.5

* Values which include hysteresis are for guideline purposes only, they are not a guarantee (assuming approximately ±30% dispersion) and may change substantially depending on the ambient environment.

Minimum Stroke for Auto Switch Mounting

		n: Number of auto switches (mm)					
Auto switch model	Number of auto switches mounted	Mounting brackets other than center trunnion	Center trunnion				
			ø40	ø50	ø63	ø80	ø100
D-M9□ D-M9□W	2 (Different surfaces and same surface) 1	15	80	85	90	95	
	n	$15 + 40 \frac{(n-2)}{2}$ (n = 2, 4, 6, 8... Note 1)	$80 + 40 \frac{(n-4)}{2}$ (n = 4, 8, 12, 16... Note 2)	$85 + 40 \frac{(n-4)}{2}$ (n = 4, 8, 12, 16... Note 2)	$90 + 40 \frac{(n-4)}{2}$ (n = 4, 8, 12, 16... Note 2)	$95 + 40 \frac{(n-4)}{2}$ (n = 4, 8, 12, 16... Note 2)	
D-M9□V D-M9□WV	2 (Different surfaces and same surface) 1	10	55	60	65	70	
	n	$10 + 30 \frac{(n-2)}{2}$ (n = 2, 4, 6, 8... Note 1)	$55 + 30 \frac{(n-4)}{2}$ (n = 4, 8, 12, 16... Note 2)	$60 + 30 \frac{(n-4)}{2}$ (n = 4, 8, 12, 16... Note 2)	$65 + 30 \frac{(n-4)}{2}$ (n = 4, 8, 12, 16... Note 2)	$70 + 30 \frac{(n-4)}{2}$ (n = 4, 8, 12, 16... Note 2)	
D-M9□A	2 (Different surfaces and same surface) 1	15	80	85	95	100	
	n	$15 + 40 \frac{(n-2)}{2}$ (n = 2, 4, 6, 8... Note 1)	$80 + 40 \frac{(n-4)}{2}$ (n = 4, 8, 12, 16... Note 2)	$85 + 40 \frac{(n-4)}{2}$ (n = 4, 8, 12, 16... Note 2)	$95 + 40 \frac{(n-4)}{2}$ (n = 4, 8, 12, 16... Note 2)	$100 + 40 \frac{(n-4)}{2}$ (n = 4, 8, 12, 16... Note 2)	
D-M9□AV	2 (Different surfaces and same surface) 1	10	60	65	70	75	
	n	$10 + 30 \frac{(n-2)}{2}$ (n = 2, 4, 6, 8... Note 1)	$60 + 30 \frac{(n-4)}{2}$ (n = 4, 8, 12, 16... Note 2)	$65 + 30 \frac{(n-4)}{2}$ (n = 4, 8, 12, 16... Note 2)	$70 + 30 \frac{(n-4)}{2}$ (n = 4, 8, 12, 16... Note 2)	$75 + 30 \frac{(n-4)}{2}$ (n = 4, 8, 12, 16... Note 2)	
D-A9□	2 (Different surfaces and same surface) 1	15	75	80	85	90	
	n	$15 + 40 \frac{(n-2)}{2}$ (n = 2, 4, 6, 8... Note 1)	$75 + 40 \frac{(n-4)}{2}$ (n = 4, 8, 12, 16... Note 2)	$80 + 40 \frac{(n-4)}{2}$ (n = 4, 8, 12, 16... Note 2)	$85 + 40 \frac{(n-4)}{2}$ (n = 4, 8, 12, 16... Note 2)	$90 + 40 \frac{(n-4)}{2}$ (n = 4, 8, 12, 16... Note 2)	
D-A9□V	2 (Different surfaces and same surface) 1	10	50	55	60	65	
	n	$10 + 30 \frac{(n-2)}{2}$ (n = 2, 4, 6, 8... Note 1)	$50 + 30 \frac{(n-4)}{2}$ (n = 4, 8, 12, 16... Note 2)	$55 + 30 \frac{(n-4)}{2}$ (n = 4, 8, 12, 16... Note 2)	$60 + 30 \frac{(n-4)}{2}$ (n = 4, 8, 12, 16... Note 2)	$65 + 30 \frac{(n-4)}{2}$ (n = 4, 8, 12, 16... Note 2)	
D-A5□/A6 D-F5□/J5 D-F5□W/J59W D-F5BA/F59F	2 (Different surfaces and same surface) 1	15	90	100	110	120	
	n (Same surface)	$15 + 55 \frac{(n-2)}{2}$ (n = 2, 4, 6, 8... Note 1)	$90 + 55 \frac{(n-4)}{2}$ (n = 4, 8, 12, 16... Note 2)	$100 + 55 \frac{(n-4)}{2}$ (n = 4, 8, 12, 16... Note 2)	$110 + 55 \frac{(n-4)}{2}$ (n = 4, 8, 12, 16... Note 2)	$120 + 55 \frac{(n-4)}{2}$ (n = 4, 8, 12, 16... Note 2)	
D-A59W	2 (Different surfaces and same surface) 1	20	90	100	110	120	
	n (Same surface)	$20 + 55 \frac{(n-2)}{2}$ (n = 2, 4, 6, 8... Note 1)	$90 + 55 \frac{(n-4)}{2}$ (n = 4, 8, 12, 16... Note 2)	$100 + 55 \frac{(n-4)}{2}$ (n = 4, 8, 12, 16... Note 2)	$110 + 55 \frac{(n-4)}{2}$ (n = 4, 8, 12, 16... Note 2)	$120 + 55 \frac{(n-4)}{2}$ (n = 4, 8, 12, 16... Note 2)	
	1	15	90	100	110	120	
D-F5NT	2 (Different surfaces and same surface) 1	25	110	120	130	140	
	n (Same surface)	$25 + 55 \frac{(n-2)}{2}$ (n = 2, 4, 6, 8... Note 1)	$110 + 55 \frac{(n-4)}{2}$ (n = 4, 8, 12, 16... Note 2)	$120 + 55 \frac{(n-4)}{2}$ (n = 4, 8, 12, 16... Note 2)	$130 + 55 \frac{(n-4)}{2}$ (n = 4, 8, 12, 16... Note 2)	$140 + 55 \frac{(n-4)}{2}$ (n = 4, 8, 12, 16... Note 2)	
D-B5□/B64 D-G5□/K59 D-G5□W D-K59W D-G5BA D-G59F D-G5NT	2	Different surfaces	15	90	100	110	
	Same surface	75					
	n	Different surfaces	$15 + 50 \frac{(n-2)}{2}$ (n = 2, 4, 6, 8... Note 1)	$90 + 50 \frac{(n-4)}{2}$ (n = 4, 8, 12, 16... Note 2)	$100 + 50 \frac{(n-4)}{2}$ (n = 4, 8, 12, 16... Note 2)	$110 + 50 \frac{(n-4)}{2}$ (n = 4, 8, 12, 16... Note 2)	
		Same surface	$75 + 50 (n-2)$ (n = 2, 3, 4...)	$90 + 50 (n-2)$ (n = 2, 4, 6, 8... Note 1)	$100 + 50 (n-2)$ (n = 2, 4, 6, 8... Note 1)	$110 + 50 (n-2)$ (n = 2, 4, 6, 8... Note 1)	
	1	10	90	100	110		
D-B59W	2	Different surfaces	20	90	100	110	
	Same surface	75					
	n	Different surfaces	$20 + 50 \frac{(n-2)}{2}$ (n = 2, 4, 6, 8... Note 1)	$90 + 50 \frac{(n-4)}{2}$ (n = 4, 8, 12, 16... Note 2)	$100 + 50 \frac{(n-4)}{2}$ (n = 4, 8, 12, 16... Note 2)	$110 + 50 \frac{(n-4)}{2}$ (n = 4, 8, 12, 16... Note 2)	
		Same surface	$75 + 50 (n-2)$ (n = 2, 3, 4...)	$90 + 50 (n-2)$ (n = 2, 4, 6, 8... Note 1)	$100 + 50 (n-2)$ (n = 2, 4, 6, 8... Note 1)	$110 + 50 (n-2)$ (n = 2, 4, 6, 8... Note 1)	
1	15	90	100	110			

Note 1) When "n" is an odd number, an even number that is one larger than this odd number is used for the calculation.
 Note 2) When "n" is an odd number, a multiple of 4 that is larger than this odd number is used for the calculation.

REA

REB

REC

Smooth

Low Speed

MQ

RHC

RZQ

D-□

-X□

Minimum Stroke for Auto Switch Mounting

		n: Number of auto switches (mm)					
Auto switch model	Number of auto switches mounted	Mounting brackets other than center trunnion	Center trunnion				
			ø40	ø50	ø63	ø80	ø100
D-A3□ D-G39 D-K39	2	Different surfaces	35	75	80	90	
		Same surface	100	100	100	100	
	n	Different surfaces	$35 + 30(n - 2)$ (n = 2, 3, 4...)	$75 + 30(n - 2)$ (n = 2, 4, 6, 8...) ^{Note 1}	$80 + 30(n - 2)$ (n = 2, 4, 6, 8...) ^{Note 1}	$90 + 30(n - 2)$ (n = 2, 4, 6, 8...) ^{Note 1}	
		Same surface	$100 + 100(n - 2)$ (n = 2, 3, 4...)		$100 + 100(n - 2)$ (n = 2, 4, 6, 8...) ^{Note 1}		
	1	10	75	80	90		
D-A44	2	Different surfaces	35	75	80	90	
		Same surface	55				
	n	Different surfaces	$35 + 30(n - 2)$ (n = 2, 3, 4...)	$75 + 30(n - 2)$ (n = 2, 4, 6, 8...) ^{Note 1}	$80 + 30(n - 2)$ (n = 2, 4, 6, 8...) ^{Note 1}	$90 + 30(n - 2)$ (n = 2, 4, 6, 8...) ^{Note 1}	
		Same surface	$55 + 50(n - 2)$ (n = 2, 3, 4...)	$75 + 50(n - 2)$ (n = 2, 4, 6, 8...) ^{Note 1}	$80 + 50(n - 2)$ (n = 2, 4, 6, 8...) ^{Note 1}	$90 + 50(n - 2)$ (n = 2, 4, 6, 8...) ^{Note 1}	
	1	10	75	80	90		
D-A3□C D-G39C D-K39C	2	Different surfaces	20	75	80	90	
		Same surface	100	100	100	100	
	n	Different surfaces	$20 + 35(n - 2)$ (n = 2, 3, 4...)	$75 + 35(n - 2)$ (n = 2, 4, 6, 8...) ^{Note 1}	$80 + 35(n - 2)$ (n = 2, 4, 6, 8...) ^{Note 1}	$90 + 35(n - 2)$ (n = 2, 4, 6, 8...) ^{Note 1}	
		Same surface	$100 + 100(n - 2)$ (n = 2, 3, 4, 5...)		$100 + 100(n - 2)$ (n = 2, 4, 6, 8...) ^{Note 1}		
	1	10	75	80	90		
D-A44C	2	Different surfaces	20	75	80	90	
		Same surface	55				
	n	Different surfaces	$20 + 35(n - 2)$ (n = 2, 3, 4...)	$75 + 35(n - 2)$ (n = 2, 4, 6, 8...) ^{Note 1}	$80 + 35(n - 2)$ (n = 2, 4, 6, 8...) ^{Note 1}	$90 + 35(n - 2)$ (n = 2, 4, 6, 8...) ^{Note 1}	
		Same surface	$55 + 50(n - 2)$ (n = 2, 3, 4...)	$75 + 50(n - 2)$ (n = 2, 4, 6, 8...) ^{Note 1}	$80 + 50(n - 2)$ (n = 2, 4, 6, 8...) ^{Note 1}	$90 + 50(n - 2)$ (n = 2, 4, 6, 8...) ^{Note 1}	
	1	10	75	80	90		
D-Z7□/Z80 D-Y59□/Y7P D-Y7□W	2 (Different surfaces and same surface) 1	15	80	85	90	95	105
	n	$15 + 40 \frac{(n-2)}{2}$ (n = 2, 4, 6, 8...) ^{Note 1}	$80 + 40 \frac{(n-4)}{2}$ (n = 4, 8, 12, 16...) ^{Note 2}	$85 + 40 \frac{(n-4)}{2}$ (n = 4, 8, 12, 16...) ^{Note 2}	$90 + 40 \frac{(n-4)}{2}$ (n = 4, 8, 12, 16...) ^{Note 2}	$95 + 40 \frac{(n-4)}{2}$ (n = 4, 8, 12, 16...) ^{Note 2}	$105 + 40 \frac{(n-4)}{2}$ (n = 4, 8, 12, 16...) ^{Note 2}
D-Y69□/Y7PV D-Y7□WV	2 (Different surfaces and same surface) 1	10	65	75	80	90	
	n	$10 + 30 \frac{(n-2)}{2}$ (n = 2, 4, 6, 8...) ^{Note 1}	$65 + 30 \frac{(n-4)}{2}$ (n = 4, 8, 12, 16...) ^{Note 2}	$75 + 30 \frac{(n-4)}{2}$ (n = 4, 8, 12, 16...) ^{Note 2}	$80 + 30 \frac{(n-4)}{2}$ (n = 4, 8, 12, 16...) ^{Note 2}	$90 + 30 \frac{(n-4)}{2}$ (n = 4, 8, 12, 16...) ^{Note 2}	
D-Y7BA	2 (Different surfaces and same surface) 1	20	95	100	105	110	
	n	$20 + 45 \frac{(n-2)}{2}$ (n = 2, 4, 6, 8...) ^{Note 1}	$95 + 45 \frac{(n-4)}{2}$ (n = 4, 8, 12, 16...) ^{Note 2}	$100 + 45 \frac{(n-4)}{2}$ (n = 4, 8, 12, 16...) ^{Note 2}	$105 + 45 \frac{(n-4)}{2}$ (n = 4, 8, 12, 16...) ^{Note 2}	$110 + 45 \frac{(n-4)}{2}$ (n = 4, 8, 12, 16...) ^{Note 2}	
D-P3DWA	2 (Different surfaces and same surface) 1	15		85			
	n	$15 + 50 \frac{(n-2)}{2}$ (n = 2, 4, 6, 8...) ^{Note 1}		$85 + 50 \frac{(n-4)}{2}$ (n = 4, 8, 12, 16...) ^{Note 2}			
D-P4DW	2 (Different surfaces and same surface) 1	15	120	130	140		
	n	$15 + 65 \frac{(n-2)}{2}$ (n = 2, 4, 6, 8...) ^{Note 1}	$120 + 65 \frac{(n-4)}{2}$ (n = 4, 8, 12, 16...) ^{Note 2}	$130 + 65 \frac{(n-4)}{2}$ (n = 4, 8, 12, 16...) ^{Note 2}	$140 + 65 \frac{(n-4)}{2}$ (n = 4, 8, 12, 16...) ^{Note 2}		

Note 1) When "n" is an odd number, an even number that is one larger than this odd number is used for the calculation.

Note 2) When "n" is an odd number, a multiple of 4 that is larger than this odd number is used for the calculation.

Auto Switch Mounting Brackets/Part No.

<Tie-rod mounting>

Auto switch model	Bore size (mm)				
	40	50	63	80	100
D-M9□/M9□V D-M9□W/M9□WV D-M9□A/M9□AV D-A9□/A9□V	BA7-040	BA7-040	BA7-063	BA7-080	BA7-080
D-A5□/A6□ D-A59W D-F5□/J59 D-F5□W/J59W D-F59F/F5NT	BT-04	BT-04	BT-06	BT-08	BT-08
D-A3□C/A44C D-G39C/K39C	BA3-040	BA3-050	BA3-063	BA3-080	BA3-100
D-Z7□/Z80 D-Y59□/Y69□ D-Y7P/Y7PV D-Y7□W/Y7□WV D-Y7BA	BA4-040	BA4-040	BA4-063	BA4-080	BA4-080
D-P3DWA	BK7-040S	BK7-040S	BA10-063S	BA10-080S	BA10-080S
D-P4DW	BAP2-040	BAP2-040	BAP2-063	BAP2-080	BAP2-080

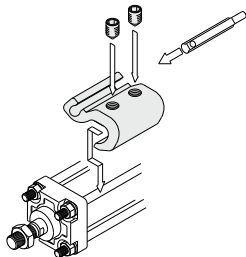

* The figure shows the mounting example for the D-A9□(V)/M9□(V)/M9□W(V)/M9□A(V) types.

<Band mounting>

Auto switch model	Bore size (mm)				
	40	50	63	80	100
D-A3□/A44 D-G39/K39	BDS-04M	BDS-05M	BMB1-063	BMB1-080	BMB1-100
D-B5□/B64 D-B59W D-G5□/K59 D-G5□W/K59W D-G59F D-G5NT	BH2-040	BA5-050	BAF-06	BAF-08	BAF-10

Note 1) The auto switch mounting bracket is included in the D-A3□C/A44C/G39C/K39C types. Specify the part number as follows depending on the cylinder size when ordering.
(Example) ø40: D-A3□C-4, ø50: D-A3□C-5, ø63: D-A3□C-6, ø80: D-A3□C-8, ø100: D-A3□C-10

[Stainless Steel Mounting Screw]

The following stainless steel mounting screw kit (including set screws) is also available. Use it in accordance with the operating environment.

(Since the auto switch mounting bracket is not included, order it separately.)

BBA1: For D-A5/A6/F5/J5 types

BBA3: For D-B5/B6/G5/K5 types

Note 2) Refer to pages 1047 and 1055 for details on the BBA1 and BBA3. The above stainless steel screws are used when a cylinder is shipped with D-F5BA or G5BA auto switches. When only an auto switch is shipped independently, the BBA1 or BBA3 is attached.

Note 3) When using the D-M9□A(V) or Y7BA, do not use the steel set screws which are included with the auto switch mounting brackets above (BA7-□□□, BA4-□□□). Order a stainless steel screw kit (BBA1) separately, and use the M4 x 6L stainless steel set screws included in the BBA1.

Note 4) There is a difference in the cylinder tube thickness depending on the cylinder model. When a band mounting type is used as an applicable auto switch and a cylinder model is changed, use caution.

REA

REB

REC

Smooth

Low Speed

MQ

RHC

RZQ

Other than the applicable auto switches listed in "How to Order", the following auto switches are mountable.

Refer to pages 941 to 1067 for the detailed specifications.

Type	Model	Electrical entry	Features
Reed	D-A93V/A96V	Grommet (Perpendicular)	—
	D-A90V		Without indicator light
	D-A53/A56/B53/Z73/Z76	Grommet (In-line)	—
	D-A67/Z80		Without indicator light
Solid state	D-M9NV/M9PV/M9BV	Grommet (Perpendicular)	—
	D-Y69A/Y69B/Y7PV		—
	D-M9NWV/M9PWW/M9BWW		Diagnostic indication (2-color indicator)
	D-Y7NWW/Y7PWW/Y7BWW		Water resistant (2-color)
	D-M9NAV/M9PAV/M9BAV		—
	D-Y59A/Y59B/Y7P		—
	D-F59/F5P/J59	Grommet (In-line)	—
	D-Y7NW/Y7PW/Y7BW		Diagnostic indication (2-color indicator)
	D-F59W/F5PW/J59W		Water resistant (2-color)
	D-F5BA/Y7BA		With timer
	D-F5NT/G5NT		Magnetic field resistant (2-color)
D-P5DW			

* With pre-wired connector is also available for solid state auto switches. For details, refer to pages 1014 and 1015.

* Normally closed (NC = b contact) solid state auto switches (D-M9□E(V)/Y7G/Y7H) are also available. For details, refer to pages 1592-1 and 961.

D-□

-X□

Smooth Cylinder

CS2Y Series

∅125, ∅140, ∅160

How to Order

CS2Y L 160 - **300** - **M9BW**

With auto switch **CDS2Y L 160** - **300** - **M9BW**

With auto switch (Built-in magnet)

Smooth cylinder

Mounting

B	Basic
L	Foot
F	Rod flange
G	Head flange
C	Single clevis
D	Double clevis
T	Center trunnion

Bore size

125	125 mm
140	140 mm
160	160 mm

Port thread type

Nil	Rc
TN	NPT
TF	G

Number of auto switches

Nil	2 pcs.
S	1 pc.
3	3 pcs.
n	"n" pcs.

Made to Order
Refer to page 213 for details.

Auto switch

Nil	Without auto switch
-----	---------------------

* For applicable auto switches, refer to the table below.

Suffix for cylinder

Rod boot	J	Nylon tarpaulin
	K	Heat resistant tarpaulin
With/without cushion	A	With double-side cushion
	R	With rod cushion
	H	With head cushion
	Nil	Without cushion

* When more than one symbol is specified, indicate them in alphabetical order.

Built-in Magnet Cylinder Model

If a built-in magnet cylinder without an auto switch is required, there is no need to enter the symbol for the auto switch. (Example) CDS2YL125-200

Cylinder stroke (mm)
Refer to "Maximum Strokes" on page 213.

Applicable Auto Switches/Refer to pages 941 to 1067 for further information on auto switches.

Type	Special function	Electrical entry	Indicator light	Wiring (Output)	Load voltage		Auto switch model		Lead wire length (m)				Pre-wired connector	Applicable load				
					DC	AC	Tie-rod mounting	Band mounting	0.5 (Nil)	1 (M)	3 (L)	5 (Z)						
Solid state auto switch	—	Grommet	No	3-wire (NPN)	24 V	5 V, 12 V	—	M9N	●	●	●	○	○	IC circuit	Relay, PLC			
				3-wire (PNP)				M9P	●	●	●	○	○					
		2-wire	M9B	●	●	●	○	○										
		—	G39	—	—	—	—	—										
	Diagnostic indication (2-color indicator)	Grommet	Yes	3-wire (NPN)	24 V	5 V, 12 V	—	M9NW	●	●	●	○	○	IC circuit				
				3-wire (PNP)				M9PW	●	●	●	○	○					
		2-wire	M9BW	●	●	●	○	○										
		3-wire (NPN)	M9NA*1	—	○	○	●	○	○									
		3-wire (PNP)	M9PA*1	—	○	○	●	○	○									
		2-wire	M9BA*1	—	○	○	●	○	○									
Water resistant (2-color indicator)	Grommet	No	4-wire (NPN)	24 V	5 V, 12 V	—	F59F	●	—	●	○	○	IC circuit					
			2-wire (Non-polar)				P3DWA	●	●	●	○	○						
Reed auto switch	—	Grommet	Yes	3-wire (NPN equivalent)	24 V	5 V	—	A96	●	●	●	—	—	IC circuit	Relay, PLC			
								12 V	A93	●	●	●	—			—		
								5 V, 12 V	A90	—	●	●	—			—		
								100 V or less	A54	—	●	●	●			—		
								100 V, 200 V	A64	—	●	—	—			—		
		Terminal conduit	No	2-wire	24 V	12 V	—	—	—	A33	—	—	—	—		—	PLC	
										—	A34	—	—	—		—		—
										—	A44	—	—	—		—		—
										100 V, 200 V	—	—	—	—		—		—
										—	A59W	—	●	—		—		—

*1 Water resistant type auto switches can be mounted on the above models, but in such case SMC cannot guarantee water resistance.

Please consult with SMC regarding water resistant types with the above model numbers.

* Lead wire length symbols: 0.5 m Nil (Example) M9NW 3 m L (Example) M9NWL
1 m M (Example) M9NWM 5 m Z (Example) M9NWZ

* Solid state auto switches marked with "○" are produced upon receipt of order.

* Since there are other applicable auto switches than listed, refer to page 224 for details.

* For details about auto switches with pre-wired connector, refer to pages 1014 and 1015.

* The D-A9□/M9□/M9□/W/M9□/A/P3DWA□ auto switches are shipped together, (but not assembled). (However, only the auto switch mounting brackets are assembled before shipment.)

Designed with a low sliding resistance of the piston, this air cylinder is ideal for applications such as contact pressure control, which requires smooth movements at low pressure.

Low sliding resistance

Min. operating pressure — 0.005 MPa

Auto switch mounting is possible.

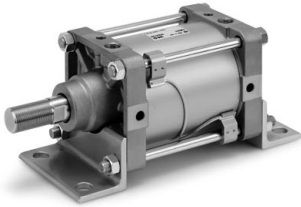

Symbol

Double acting/Without cushion

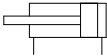

Made to Order

[Click here for details](#)

Symbol	Specifications
-XA□	Change of rod end shape
-XC3	Special port position
-XC9	Adjustable stroke cylinder/Adjustable retraction type
-XC10	Dual stroke cylinder/Double rod type
-XC14	Change of trunnion bracket mounting position
-XC15	Change of tie-rod length
-XC26	With split pins for double clevis pin/double knuckle joint pin and flat washers
-XC27	Double clevis and double knuckle pins made of stainless steel
-XC30	Rod side trunnion
-XC68	Made of stainless steel (with hard chrome plated piston rod)
-XC86	With rod end bracket

Refer to pages 222 to 224 for cylinders with auto switches.

- Auto switch proper mounting position (detection at stroke end) and its mounting height
- Minimum stroke for auto switch mounting
- Operating range
- Auto switch mounting brackets/Part no.

Application Example

Low friction cylinder is used in combination with precision regulator (IR series).

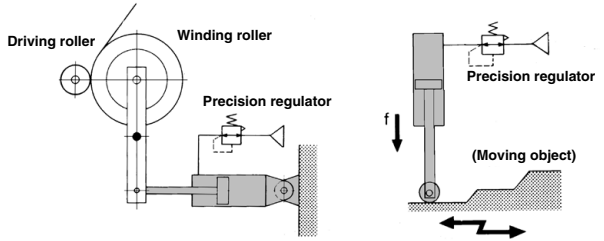

Specifications

Bore size (mm)	125	140	160
Action	Double acting, Single rod		
Direction of low friction	Both directions		
Fluid	Air		
Proof pressure	1.05 MPa		
Maximum operating pressure	0.7 MPa		
Ambient and fluid temperature	Without auto switch: 0°C to 70°C With auto switch: 0°C to 60°C (No freezing)		
Allowable leakage	Less than 0.5 L/min (ANR)		
Cushion	Without cushion* (manufacturable with cushion)		
Lubrication	Not required (Non-lube)		
Mounting	Basic, Foot, Rod flange, Head flange, Single clevis, Double clevis, Center trunnion		

* If an air cushion is not used, set the energy at the stroke end to 0.36J (ø125, ø140) or less, 0.3J (ø160) or less.

Minimum Operating Pressure

Unit: MPa			
Bore size (mm)	125	140	160
Minimum operating pressure	0.005 MPa*		

* If a cushion is used, this value will not include the operating pressure within the cushion stroke.

Maximum Strokes

Mounting bracket Bore size (mm)	(mm)	
	Basic, Head flange, Single clevis, Double clevis, Center trunnion	Foot, Rod flange
125	1000 or less	1600 or less
140	1200 or less	1600 or less
160	1200 or less	1600 or less

Accessories For details, refer to page 221.

Mounting		Basic	Foot	Rod flange	Head flange	Single clevis	Double clevis	Center trunnion
Standard	Clevis pin	—	—	—	—	—	●	—
Option	Rod end nut	●	●	●	●	●	●	●
	Single knuckle joint	●	●	●	●	●	●	●
	Double knuckle joint (with knuckle pin, split pin)	●	●	●	●	●	●	●
	Rod boot	●	●	●	●	●	●	●

REA

REB

REC

Smooth

Low Speed

MQ

RHC

RZQ

D-□

-X□

CS2Y Series

Mounting Brackets/Part No.

Bore size (mm)	125	140	160
Foot*	CS2-L12	CS2-L14	CS2-L16
Flange	CS2-F12	CS2-F14	CS2-F16
Single clevis	CS2-C12	CS2-C14	CS2-C16
Double clevis**	CS2-D12	CS2-D14	CS2-D16

* Order two foot brackets per cylinder.

** When ordering the double clevis type, the clevis pin and 2 split pins are included as accessories.

Weights

Bore size (mm)		125	140	160
Basic weight	Basic	5.46	6.50	9.07
	Foot	7.49	9.50	12.45
	Rod flange	8.51	12.03	15.80
	Head flange	8.51	12.03	15.80
	Single clevis	8.53	10.79	14.56
	Double clevis	8.99	11.54	15.41
	Trunnion	9.59	12.23	15.47
Additional weight with magnet (With built-in magnet and auto switch)		0.07	0.07	0.08
Additional weight per 100 mm of stroke		1.55	1.67	2.23
Accessories	Single knuckle	0.91	1.16	1.56
	Double knuckle (With Knuckle pin, Split pin)	1.37	1.81	2.48
	Rod end nut	0.16	0.16	0.23

Calculation: (Example) **CS2Y160-500**

- Basic weight.....12.45 (kg)
- Additional weight.....2.23 (kg/100 mm)
- Cylinder stroke.....500 (mm)

$$12.45 + 2.23 \times 500/100 = \mathbf{23.60 \text{ kg}}$$

Sliding Resistance

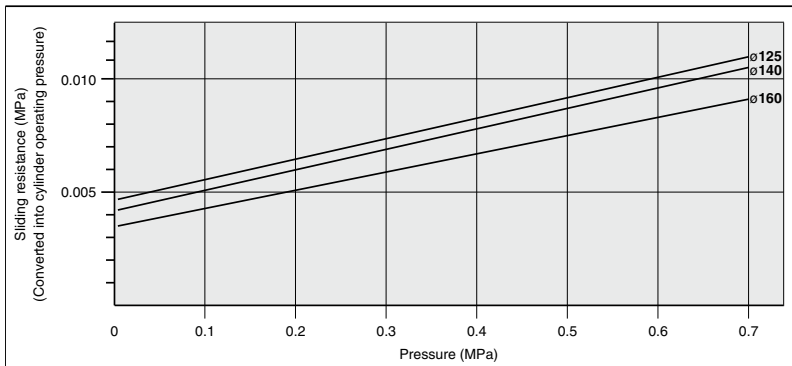

Rod Boot Material

Symbol	Material	Max. ambient temperature
J	Nylon tarpaulin	70°C
K	Heat resistant tarpaulin	110°C*

* Maximum ambient temperature for the rod boot itself.

Replacement Parts: Seal kit.

Bore size (mm)	Kit no.	Content
125	CS2Y125A-PS	Without cushion
		· Rod seal 1 pc.
140	CS2Y140A-PS	· Piston seal 1 pc.
		· Tube gasket 2 pcs.
160	CS2Y160A-PS	· Tube gasket 2 pcs.
		· Tube gasket 2 pcs.
125	CS2Y125AA-PS	With single-side cushion
		· Rod seal 1 pc.
140	CS2Y140AA-PS	· Cushion seal 2 pcs.
		· Piston seal 1 pc.
160	CS2Y160AA-PS	· Tube gasket 2 pcs.
		· Tube gasket 2 pcs.
125	CS2Y125AR-PS	With single-side cushion
		· Rod seal 1 pc.
140	CS2Y140AR-PS	· Cushion seal 1 pc.
		· Piston seal 1 pc.
160	CS2Y160AR-PS	· Tube gasket 2 pcs.
		· Tube gasket 2 pcs.

* Seal kit does not include a grease pack.

Order with the following part number when only the grease pack is needed.

Grease pack part number: GR-L-005 (5 g), GR-L-010 (10 g), GR-L-150 (150 g)

Relationship between Cylinder Size and Maximum Stroke

The below table shows the applicable maximum stroke (in cm units), found by calculation assuming the case where the force generated by the cylinder itself acts as buckling force on the piston rod, or piston rod and cylinder tube.

Therefore, it is possible to find the applicable maximum stroke for each cylinder size using the relationship between the size of the operating pressure and the cylinder support type, regardless of the load ratio.

[Reference] If it is stopped with the external stopper on the cylinder extension side, even with a light load, the maximum generated force of the cylinder will act on the cylinder itself.

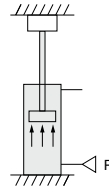

Mounting			Operating pressure (MPa)	Applicable maximum stroke according to buckling strength (cm)				
Support bracket nominal symbol and schematic diagram		Nominal symbol		125	140	160		
Foot: L	Rod flange: F	Head flange: G	0.3 0.5 0.7 0.3 0.5 0.7 0.3 0.5 0.7 0.3 0.5 0.7 0.3 0.5 0.7 0.3 0.5 0.7 0.3 0.5 0.7	103	92	113		
				79	70	86		
					66	58	72	
						45	38	47
	33	27				34		
	26	22				27		
Clevis: C, D	Center trunnion: T			96	83	106		
				71	61	76		
				59	50	62		
			135	119	147			
			101	89	111			
			84	74	91			
Foot: L	Rod flange: F	Head flange: G	301	267	330			
			231	207	253			
			193	172	212			
			144	126	156			
			109	94	118			
			90	78	97			
			Foot: L	Rod flange: F	Head flange: G	433	386	476
						334	297	367
						281	250	309
210	185	229						
160	141	175						
134	117	129						

(cm)

REA

REB

REC

Smooth

Low Speed

MQ

RHC

RZQ

D-□

-X□

Dimensions

Basic: CS2YB

With rod boot

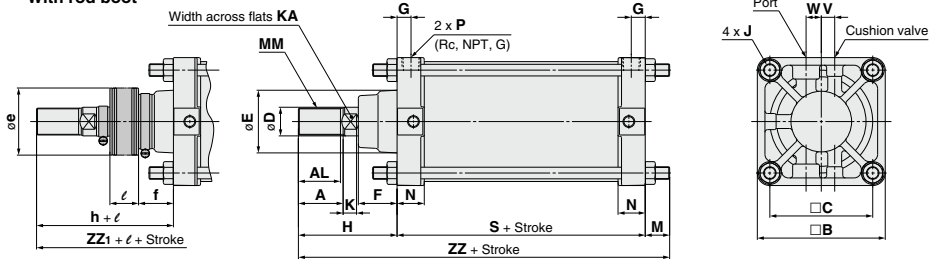

Bore size (mm)	A	AL	□B	□C	D	E	F	G	J	V	W	K	KA	M	MM
125	50	47	143	115	32	71	43	15	M14 x 1.5	15	17	15	27	27	M30 x 1.5
140	50	47	157	128	32	71	43	15	M14 x 1.5	15	17	15	27	27	M30 x 1.5
160	56	53	177	144	38	78.5	42	18	M16 x 1.5	15	20	17	34	30.5	M36 x 1.5

Bore size (mm)	N	P	S	Without rod boot		With rod boot				
				H	ZZ	e	f	h	ℓ	ZZ ₁
125	30.5	1/2	98	110	235	75	40	133	1/5 Stroke	258
140	30.5	1/2	98	110	235	75	40	133	1/5 Stroke	258
160	34.5	3/4	106	120	256.5	75	40	141	1/5 Stroke	277.5

* The minimum stroke with rod boot is 30 mm or more.
 ** For auto switch mounting position and its mounting height, refer to page 222.
 *** Refer to "Minimum Stroke for Auto Switch Mounting" on page 223.

Foot: CS2YL

With rod boot

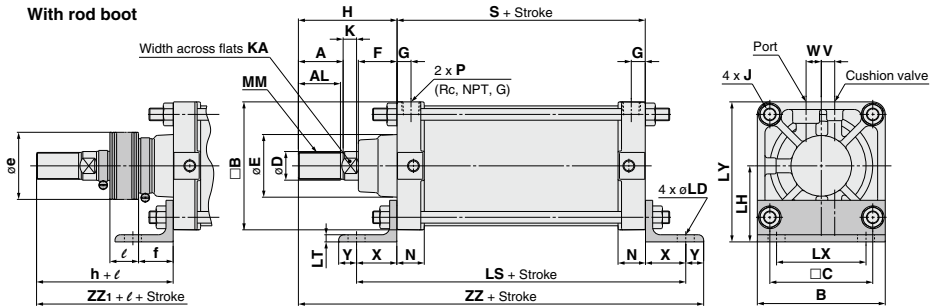

Bore size (mm)	A	AL	□B	B	□C	D	E	F	G	J	V	W	K	KA	LD	LH	LS
125	50	47	143	143	115	32	71	43	15	M14 x 1.5	15	17	15	27	19	85	188
140	50	47	157	157	128	32	71	43	15	M14 x 1.5	15	17	15	27	19	100	188
160	56	53	177	177	144	38	78.5	42	18	M16 x 1.5	15	20	17	34	19	106	206

Bore size (mm)	LT	LX	LY	MM	N	P	S	X	Y	Without rod boot		With rod boot				
										H	ZZ	e	f	h	ℓ	ZZ ₁
125	8	100	156.5	M30 x 1.5	30.5	1/2	98	45	20	110	273	75	40	133	1/5 Stroke	296
140	9	112	178.5	M30 x 1.5	30.5	1/2	98	45	30	110	283	75	40	133	1/5 Stroke	306
160	9	118	194.5	M36 x 1.5	34.5	3/4	106	50	25	120	301	75	40	141	1/5 Stroke	322

* The minimum stroke with rod boot is 30 mm or more.
 ** For auto switch mounting position and its mounting height, refer to page 222.
 *** Refer to "Minimum Stroke for Auto Switch Mounting" on page 223.

- REA
- REB
- REC
- Smooth
- Low Speed
- MQ
- RHC
- RZQ

- D-□
- X□

CS2Y Series

Dimensions

Rod flange: CS2YF

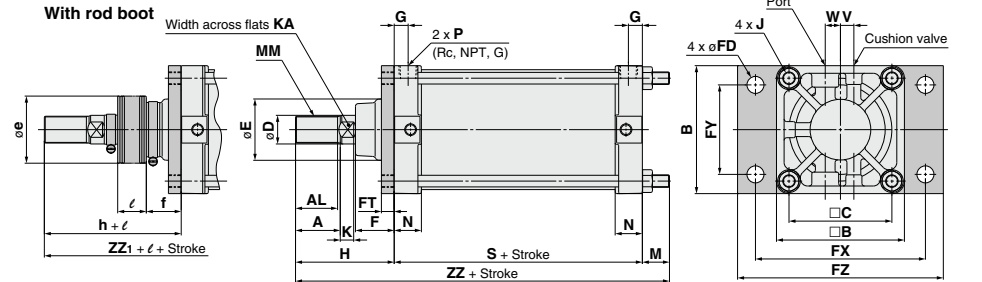

Bore size (mm)	A	AL	□B	B	□C	D	E	F	FD	FT	FX	FY	FZ	G	J	V
125	50	47	143	145	115	32	71	43	19	14	190	100	230	15	M14 x 1.5	15
140	50	47	157	160	128	32	71	43	19	20	212	112	255	15	M14 x 1.5	15
160	56	53	177	180	144	38	78.5	42	19	20	236	118	275	18	M16 x 1.5	15

Bore size (mm)	W	K	KA	M	MM	N	P	S	Without rod boot		With rod boot					
									H	ZZ	e	f	h	ℓ	ZZ ₁	
125	17	15	27	13	M30 x 1.5	30.5	1/2	98	110	221	75	40	133	1/5 Stroke	244	
140	17	15	27	13	M30 x 1.5	30.5	1/2	98	110	221	75	40	133	1/5 Stroke	244	
160	20	17	34	15	M36 x 1.5	34.5	3/4	106	120	241	75	40	141	1/5 Stroke	262	

- * The minimum stroke with rod boot is 30 mm or more.
- ** For auto switch mounting position and its mounting height, refer to page 222.
- *** Refer to "Minimum Stroke for Auto Switch Mounting" on page 223.

Head flange: CS2YG

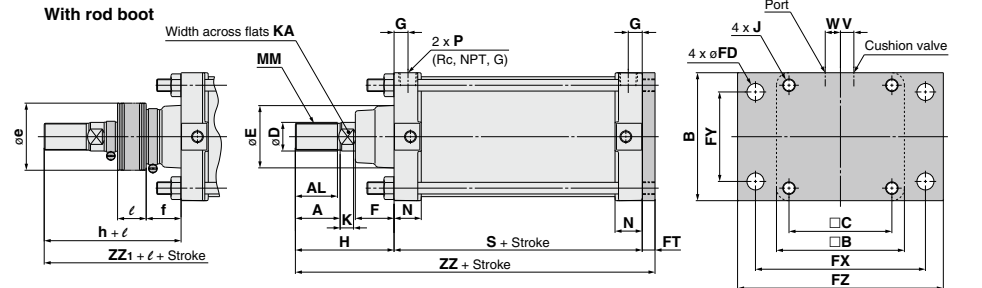

Bore size (mm)	A	AL	□B	B	□C	D	E	F	FD	FT	FX	FY	FZ	G	J	V
125	50	47	143	145	115	32	71	43	19	14	190	100	230	15	M14 x 1.5	15
140	50	47	157	160	128	32	71	43	19	20	212	112	255	15	M14 x 1.5	15
160	56	53	177	180	144	38	78.5	42	19	20	236	118	275	18	M16 x 1.5	15

Bore size (mm)	W	K	KA	MM	N	P	S	Without rod boot		With rod boot					
								H	ZZ	e	f	h	ℓ	ZZ ₁	
125	17	15	27	M30 x 1.5	30.5	1/2	98	110	222	75	40	133	1/5 Stroke	245	
140	17	15	27	M30 x 1.5	30.5	1/2	98	110	228	75	40	133	1/5 Stroke	251	
160	20	17	34	M36 x 1.5	34.5	3/4	106	120	246	75	40	141	1/5 Stroke	267	

- * The minimum stroke with rod boot is 30 mm or more.
- ** For auto switch mounting position and its mounting height, refer to page 222.
- *** Refer to "Minimum Stroke for Auto Switch Mounting" on page 223.

Dimensions

Single clevis: CS2YC

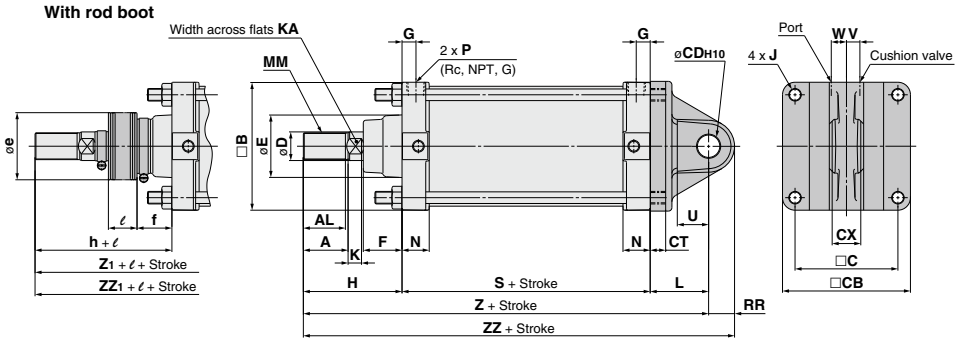

- REA
- REB
- REC
- Smooth
- Low Speed
- MQ
- RHC
- RZQ

Double clevis: CS2YD

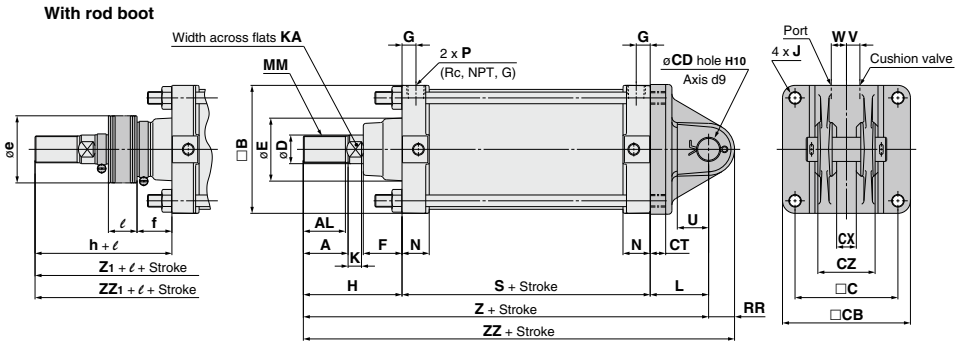

Bore size (mm)	A	AL	□B	□C	□CB	CDH10	CT	Single clevis			D	E	F	G	J	V	W
								CX	CX	CZ							
125	50	47	143	115	145	25 ^{+0.084} ₀	17	32 ^{±0.1} _{±0.1}	32 ^{+0.3} _{±0.1}	64 ^{±0.2} _{±0.2}	32	71	43	15	M14 x 1.5	15	17
140	50	47	157	128	160	28 ^{+0.084} ₀	17	36 ^{±0.1} _{±0.1}	36 ^{+0.3} _{±0.1}	72 ^{±0.2} _{±0.2}	32	71	43	15	M14 x 1.5	15	17
160	56	53	177	144	180	32 ^{+0.100} ₀	20	40 ^{±0.1} _{±0.1}	40 ^{+0.3} _{±0.1}	80 ^{±0.2} _{±0.2}	38	78.5	42	18	M16 x 1.5	15	20

Bore size (mm)	K	KA	L	MM	N	P	S	U	RR	Without rod boot			With rod boot					
										H	Z	ZZ	e	f	h	ℓ	Z1	ZZ1
125	15	27	65	M30 x 1.5	30.5	1/2	98	35	29	110	273	302	75	40	133	1/5 Stroke	296	325
140	15	27	75	M30 x 1.5	30.5	1/2	98	40	32	110	283	315	75	40	133	1/5 Stroke	306	338
160	17	34	80	M36 x 1.5	34.5	3/4	106	45	36	120	306	342	75	40	141	1/5 Stroke	327	363

* The minimum stroke with rod boot is 30 mm or more.
 ** For auto switch mounting position and its mounting height, refer to page 222.
 *** Refer to "Minimum Stroke for Auto Switch Mounting" on page 223.

- D
- X

CS2Y Series

Dimensions

Center trunnion: CS2YT

With rod boot

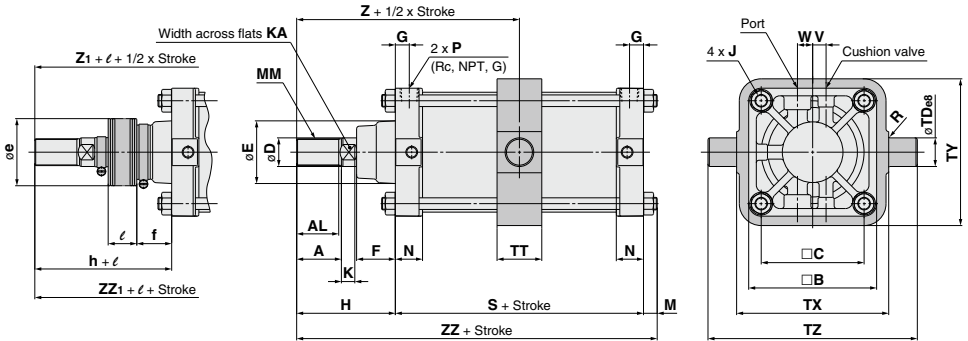

(mm)

Bore size (mm)	A	AL	□B	□C	D	E	F	G	J	V	W	K	KA	M	MM	N
125	50	47	143	115	32	71	43	15	M14 x 1.5	15	17	15	27	13	M30 x 1.5	30.5
140	50	47	157	128	32	71	43	15	M14 x 1.5	15	17	15	27	13	M30 x 1.5	30.5
160	56	53	177	144	38	78.5	42	18	M16 x 1.5	15	20	17	34	15	M36 x 1.5	34.5

(mm)

Bore size (mm)	P	R	S	TD88	TT	TX	TY	TZ	Without rod boot			With rod boot					
									H	Z	ZZ	e	f	h	ℓ	Z1	ZZ1
125	1/2	1	98	32 ^{-0.050} _{-0.059}	50	170	164	234	110	159	221	75	40	133	1/5 Stroke	182	244
140	1/2	1.5	98	36 ^{-0.050} _{-0.059}	55	190	184	262	110	159	221	75	40	133	1/5 Stroke	182	244
160	3/4	1.5	106	40 ^{-0.050} _{-0.059}	60	212	204	292	120	173	241	75	40	141	1/5 Stroke	194	262

* The minimum stroke with rod boot is 30 mm or more for ø125, ø140 and 35 mm or more for ø160.

** For auto switch mounting position and its mounting height, refer to page 222.

*** Refer to "Minimum Stroke for Auto Switch Mounting" on page 223.

CS2Y Series

Dimensions of Accessories

I Type Single Knuckle Joint*

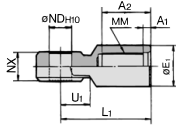

Material: Cast iron
(mm)

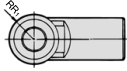

Part no.	Applicable bore size (mm)	A1	A2	E1	L1	MM	ND _{H10}	NX	RR	U1
I-12A	125	8	54	46	100	M30 x 1.5	25 ^{+0.084} ₀	32 ^{-0.1} _{-0.3}	27	33
I-14A	140	8	54	48	105	M30 x 1.5	28 ^{+0.084} ₀	36 ^{-0.1} _{-0.3}	30	39
I-16A	160	8	60	55	110	M36 x 1.5	32 ^{+0.1} ₀	40 ^{-0.1} _{-0.3}	34	39

Knuckle Pin/Clevis Pin

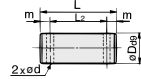

Material: Carbon steel
(mm)

Part no.	Applicable bore size (mm)	D _{ø9}	L	L2	m	d	Applicable split pin
IY-12	125	25 ^{-0.065} _{-0.117}	79.5	69.5	5	4	ø4 x 40
IY-14	140	28 ^{-0.065} _{-0.117}	86.5	76.5	5	4	ø4 x 40
IY-16	160	32 ^{-0.080} _{-0.142}	94.5	84.5	5	4	ø4 x 40

* Split pins are included.

Y Type Double Knuckle Joint*

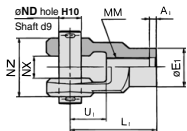

Material: Cast iron
(mm)

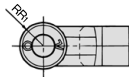

Part no.	Applicable bore size (mm)	A1	E1	L1	MM	ND _{H10}	NX	NZ	RR	U1
Y-12A	125	8	46	100	M30 x 1.5	25 ^{+0.084} ₀	32 ^{+0.3} _{-0.1}	64 ^{-0.1} _{-0.3}	27	42
Y-14A	140	8	48	105	M30 x 1.5	28 ^{+0.084} ₀	36 ^{+0.3} _{-0.1}	72 ^{-0.1} _{-0.3}	30	47
Y-16A	160	8	55	110	M36 x 1.5	32 ^{+0.1} ₀	40 ^{+0.3} _{-0.1}	80 ^{-0.1} _{-0.3}	34	46

- * Use a single knuckle joint or a double knuckle joint individually. (Screw it entirely over the rod end threads and tighten it.)
- * Extend the dimensions of A, H, when using a single/double knuckle joint together with a rod end nut. (To extend dimensions A, H, refer to the below table, and specify the product as made-to-order -XA0.)
- * A pin and split pins are included with the double knuckled joint.

● "Made to Order" with rod end bracket (-XC86) is available when ordering cylinders and accessories together. Refer to page 1221 for details.

Rod End Nut

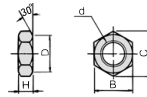

Material: Rolled steel
(mm)

Part no.	Applicable bore size (mm)	d	H	B	C	D
NT-12	125, 140	M30 x 1.5	18	46	53.1	44
NT-16	160	M36 x 1.5	21	55	63.5	53

Single/Double Knuckle Joint

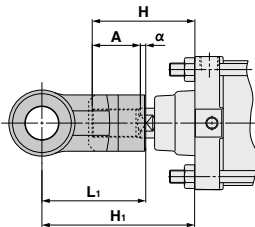

(mm)

Bore size (mm)	Symbol	H	A	α	L1	H1	Applicable knuckle joint part number	
							I type single knuckle	Y type double knuckle
125		110	50	3.5	100	156.5	I-12A	Y-12A
140		110	50	3.5	105	161.5	I-14A	Y-14A
160		120	56	3.5	110	170.5	I-16A	Y-16A

A, H Dimensions when Mounting a Single/Double Knuckle Joint together with a Rod End Nut

Bore size (mm)	A	H
125	65	125
140	65	125
160	76	140

REA

REB

REC

Smooth

Low Speed

MQ

RHC

RZQ

D-□

-X□

CS2Y Series

Auto Switch Mounting

Auto Switch Proper Mounting Position (Detection at stroke end) and Its Mounting Height

<Band mounting>

D-A3□
D-G3/K3

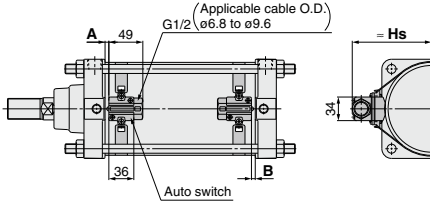

D-A44

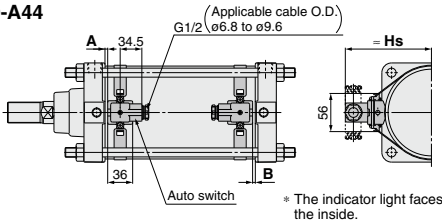

D-F5□/J59/D-F5NT
D-F5BA/F59F
D-F5□W/J59W

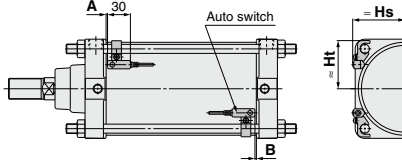

<Tie-rod mounting>

D-M9□/M9□V
D-M9□W/M9□WV
D-M9□A/M9□AV
D-A9□/A9□V
D-Z7□/Z80
D-Y59□/Y69□/Y7P/Y7PV
D-Y7□W/Y7□WV
D-Y7BA

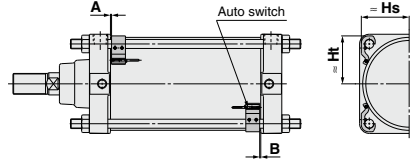

D-A5□/A6□

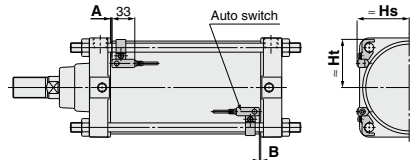

D-P3DWA

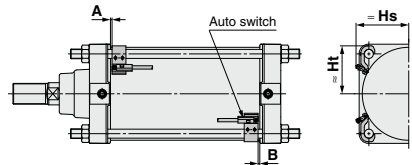

Auto Switch Proper Mounting Position

(mm)

Auto switch model	D-M9□ D-M9□V D-M9□W D-M9□WV D-M9□A D-M9□AV		D-A9□ D-A9□V		D-Z7□/Z80 D-Y5□/Y6□ D-Y7P/Y7PV D-Y7□W D-Y7□WV D-Y7BA		D-A5□ D-A6□ D-A3□ D-A44 D-G39 D-K39		D-A59W		D-F5□W D-J59W D-F5BA D-F5□ D-J59 D-F59F		D-F5NT		D-P3DWA	
	A	B	A	B	A	B	A	B	A	B	A	B	A	B	A	B
125	13	12	9	8	6.5	5.5	3	2	7	6	9.5	8.5	14.5	13.5	8.5	7.5
140	13	12	9	8	6.5	5.5	3	2	7	6	9.5	8.5	14.5	13.5	8.5	7.5
160	13	12	9	8	6.5	5.5	3	2	7	6	9.5	8.5	14.5	13.5	8.5	7.5

* Provided as guidelines for auto switch proper mounting position (detection at stroke end).
Adjust the auto switch after confirming the operating condition in the actual setting.

Auto Switch Mounting Height

(mm)

Auto switch model	D-M9□ D-M9□W D-M9□A D-A9□ D-A9□V		D-M9□V D-M9□WV D-M9□AV		D-Z7□/Z80 D-Y5□/Y6□ D-Y7P D-Y7PV D-Y7□W D-Y7□WV D-Y7BA		D-A3□ D-G39 D-K39		D-A44		D-A5□ D-A6□ D-A59W		D-F5□ D-J59 D-F5□W D-J59W D-F5BA D-F59F D-F5NT		D-P3DWA	
	Hs	Ht	Hs	Ht	Hs	Ht	Hs	Ht	Hs	Ht	Hs	Ht	Hs	Ht	Hs	Ht
125	69	69.5	71.5	69.5	69	69.5	116	116	126	75.5	69.5	74.5	70	76	69	69.5
140	76	76	77.5	76	76	76	124	124	134	81	76.5	80	76.5	82	76	
160	85	85	86	85	85	85	134.5	134.5	144.5	89	87.5	88	87.5	91	85	

Minimum Stroke for Auto Switch Mounting

Auto switch model	Number of auto switches	Mounting brackets other than center trunnion	Center trunnion		
			ø125	ø140	ø160
			n: Number of auto switches (mm)		
D-M9□ D-M9□W	With 2 pcs. (Different surfaces, Same surface), With 1 pc.	15	105	110	115
	With n pcs.	$15 + 40 \frac{(n-2)}{2}$ (n = 2, 4, 6, 8...) ^{Note 1)}	$105 + 40 \frac{(n-4)}{2}$ (n = 4, 8, 12, 16...) ^{Note 2)}	$110 + 40 \frac{(n-4)}{2}$ (n = 4, 8, 12, 16...) ^{Note 2)}	$115 + 40 \frac{(n-4)}{2}$ (n = 4, 8, 12, 16...) ^{Note 2)}
D-M9□V D-M9□WV	With 2 pcs. (Different surfaces, Same surface), With 1 pc.	10	80	85	90
	With n pcs.	$10 + 30 \frac{(n-2)}{2}$ (n = 2, 4, 6, 8...) ^{Note 1)}	$80 + 30 \frac{(n-4)}{2}$ (n = 4, 8, 12, 16...) ^{Note 2)}	$85 + 30 \frac{(n-4)}{2}$ (n = 4, 8, 12, 16...) ^{Note 2)}	$90 + 30 \frac{(n-4)}{2}$ (n = 4, 8, 12, 16...) ^{Note 2)}
D-M9□A	With 2 pcs. (Different surfaces, Same surface), With 1 pc.	20	115	120	
	With n pcs.	$20 + 40 \frac{(n-2)}{2}$ (n = 2, 4, 6, 8...) ^{Note 1)}	$115 + 40 \frac{(n-4)}{2}$ (n = 4, 8, 12, 16...) ^{Note 2)}	$120 + 40 \frac{(n-4)}{2}$ (n = 4, 8, 12, 16...) ^{Note 2)}	
D-M9□AV	With 2 pcs. (Different surfaces, Same surface), With 1 pc.	15	90	95	
	With n pcs.	$15 + 30 \frac{(n-2)}{2}$ (n = 2, 4, 6, 8...) ^{Note 1)}	$90 + 30 \frac{(n-4)}{2}$ (n = 4, 8, 12, 16...) ^{Note 2)}	$95 + 30 \frac{(n-4)}{2}$ (n = 4, 8, 12, 16...) ^{Note 2)}	
D-A9□	With 2 pcs. (Different surfaces, Same surface), With 1 pc.	15	100	105	110
	With n pcs.	$15 + 40 \frac{(n-2)}{2}$ (n = 2, 4, 6, 8...) ^{Note 1)}	$100 + 40 \frac{(n-4)}{2}$ (n = 4, 8, 12, 16...) ^{Note 2)}	$105 + 40 \frac{(n-4)}{2}$ (n = 4, 8, 12, 16...) ^{Note 2)}	$110 + 40 \frac{(n-4)}{2}$ (n = 4, 8, 12, 16...) ^{Note 2)}
D-A9□V	With 2 pcs. (Different surfaces, Same surface), With 1 pc.	10	75	80	85
	With n pcs.	$10 + 30 \frac{(n-2)}{2}$ (n = 2, 4, 6, 8...) ^{Note 1)}	$75 + 30 \frac{(n-4)}{2}$ (n = 4, 8, 12, 16...) ^{Note 2)}	$80 + 30 \frac{(n-4)}{2}$ (n = 4, 8, 12, 16...) ^{Note 2)}	$85 + 30 \frac{(n-4)}{2}$ (n = 4, 8, 12, 16...) ^{Note 2)}
D-A5□/A6□ D-A59W D-F5□/J59 D-F5□W D-J59W D-F5BA D-F59F	With 2 pcs. (Different surfaces, Same surface), With 1 pc.	25	125	135	
	With n pcs. (Same surface)	$25 + 55 \frac{(n-2)}{2}$ (n = 2, 4, 6, 8...) ^{Note 1)}	$125 + 55 \frac{(n-4)}{2}$ (n = 4, 8, 12, 16...) ^{Note 2)}	$135 + 55 \frac{(n-4)}{2}$ (n = 4, 8, 12, 16...) ^{Note 2)}	
D-F5NT	With 2 pcs. (Different surfaces, Same surface), With 1 pc.	35	145	155	
	With n pcs. (Same surface)	$35 + 55 \frac{(n-2)}{2}$ (n = 2, 4, 6, 8...) ^{Note 1)}	$145 + 55 \frac{(n-4)}{2}$ (n = 4, 8, 12, 16...) ^{Note 2)}	$155 + 55 \frac{(n-4)}{2}$ (n = 4, 8, 12, 16...) ^{Note 2)}	
D-A3□ D-G39 D-K39	With 2 pcs.	Different surfaces	35	110	
		Same surface	100	110	
	With n pcs.	Different surfaces	$35 + 30(n-2)$	$110 + 30(n-2)$ (n = 2, 4, 6, 8...) ^{Note 1)}	
Same surface		$100 + 100(n-2)$	$110 + 100(n-2)$ (n = 2, 4, 6, 8...) ^{Note 1)}		
D-A44	With 2 pcs.	With 1 pc.	15	110	
		Different surfaces	35	110	
	With n pcs.	Same surface	55	110	
		Different surfaces	$35 + 30(n-2)$	$110 + 30(n-2)$ (n = 2, 4, 6, 8...) ^{Note 1)}	
	Same surface	$55 + 55(n-2)$	$110 + 50(n-2)$ (n = 2, 4, 6, 8...) ^{Note 1)}		
With 1 pc.	15	110			
D-Z7□ D-Z80 D-Y59□ D-Y7P D-Y7□W	With 2 pcs. (Different surfaces, Same surface), With 1 pc.	15	105	110	115
	With n pcs.	$15 + 40 \frac{(n-2)}{2}$ (n = 2, 4, 6, 8...) ^{Note 1)}	$105 + 40 \frac{(n-4)}{2}$ (n = 4, 8, 12, 16...) ^{Note 2)}	$110 + 40 \frac{(n-4)}{2}$ (n = 4, 8, 12, 16...) ^{Note 2)}	$115 + 40 \frac{(n-4)}{2}$ (n = 4, 8, 12, 16...) ^{Note 2)}
D-Y69□ D-Y7P□ D-Y7□WV	With 2 pcs. (Different surfaces, Same surface), With 1 pc.	10	90	95	100
	With n pcs.	$10 + 30 \frac{(n-2)}{2}$ (n = 2, 4, 6, 8...) ^{Note 1)}	$90 + 30 \frac{(n-4)}{2}$ (n = 4, 8, 12, 16...) ^{Note 2)}	$95 + 30 \frac{(n-4)}{2}$ (n = 4, 8, 12, 16...) ^{Note 2)}	$100 + 30 \frac{(n-4)}{2}$ (n = 4, 8, 12, 16...) ^{Note 2)}
D-Y7BA	With 2 pcs. (Different surfaces, Same surface), With 1 pc.	20	115	120	125
	With n pcs.	$20 + 45 \frac{(n-2)}{2}$ (n = 2, 4, 6, 8...) ^{Note 1)}	$115 + 45 \frac{(n-4)}{2}$ (n = 4, 8, 12, 16...) ^{Note 2)}	$120 + 45 \frac{(n-4)}{2}$ (n = 4, 8, 12, 16...) ^{Note 2)}	$125 + 45 \frac{(n-4)}{2}$ (n = 4, 8, 12, 16...) ^{Note 2)}
D-P3DWA	With 2 pcs. (Different surfaces, Same surface), With 1 pc.	20	105	110	115
	With n pcs.	$20 + 50 \frac{(n-2)}{2}$ (n = 2, 4, 6, 8...) ^{Note 1)}	$105 + 50 \frac{(n-4)}{2}$ (n = 4, 8, 12, 16...) ^{Note 2)}	$110 + 50 \frac{(n-4)}{2}$ (n = 4, 8, 12, 16...) ^{Note 2)}	$115 + 50 \frac{(n-4)}{2}$ (n = 4, 8, 12, 16...) ^{Note 2)}

Note 1) When "n" is an odd number, an even number that is one larger than this odd number is used for the calculation.
 Note 2) When "n" is an odd number, a multiple of 4 that is larger than this odd number is used for the calculation.

REA
REB
REC
Smooth
Low Speed
MQ
RHC
RZQ

D-□
-X□

Operating Range

Auto switch model	Bore size (mm)		
	125	140	160
D-M9□/M9□V D-M9□W/M9□WV D-M9□A/M9□AV	6	6.5	6.5
D-A9□/A9□V D-Z7□/Z80	12	12.5	11.5
D-A3□/A44 D-A5□/A6□	14	14.5	13
D-A59W	10	10	10
D-A59W	17	17	17
D-Y59□/Y69□ D-Y7P/Y7PV D-Y7□W/Y7□WV D-Y7BA	12	13	7
D-F5□/J59/F5□W D-J59W/F5BA D-F5NT/F59F	5	5	5.5
D-G39/K39	11	11	10
D-P3DWA	7	7	7

* Values which include hysteresis are for guideline purposes only, they are not a guarantee (assuming approximately ±30% dispersion) and may change substantially depending on the ambient environment.

Auto Switch Mounting Brackets/Part No.

Auto switch model	Bore size (mm)		
	ø125	ø140	ø160
D-M9□/M9□V D-M9□W/M9□WV D-M9□A/M9□AV D-A9□/A9□V	BS5-125	BS5-125	BS5-160
D-A5□/A6□ D-A59W D-F5□/J59 D-F5NT D-F5□W/J59W D-F5BA/F59F	BT-12	BT-12	BT-16
D-A3□/A44 D-G39/K39	BS1-125	BS1-140	BS1-160
D-Z7□/Z80 D-Y59□/Y69□ D-Y7P/Y7PV D-Y7□W/Y7□WV D-Y7BA	BS4-125	BS4-125	BS4-160
D-P3DWA	BS7-125S	BS7-125S	BS7-160S

[Stainless Steel Mounting Screw]

The following stainless steel mounting screw kit (including set screws) is available. Use it in accordance with the operating environment. (Since the auto switch mounting bracket is not included, order it separately.)

BBA1: For D-A5/A6/F5/J5 types

The above stainless steel screws are used when a cylinder is shipped with the D-F5BA auto switch. When only the auto switch is shipped independently, the BBA1 is attached.

(Note) When using the D-M9□A/M9□AV or Y7BA, do not use the steel set screws which are included with the auto switch mounting brackets above (BS5-□□□, BS4-□□□). Order a stainless steel screw kit (BBA1) separately, and use the M4 × 8L stainless steel set screws included in the BBA1.

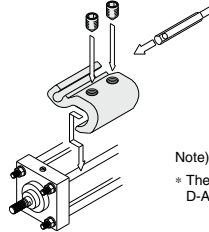

(Note) Refer to page 1055. for details on the BBA1.

* The figure shows the mounting example for the D-A9□(V)/M9□(V)/M9□W(V)/M9□A(V) types.

Other than the applicable auto switches listed in “How to Order”, the following auto switches are mountable.

Refer to pages 941 to 1067 for the detailed specifications.

Type	Model	Electrical entry	Features		
Reed	D-A90V	Grommet (Perpendicular)	Without indicator light		
	D-A93V/A96V		Grommet (In-line)	—	
	D-Z73/Z76			Without indicator light	
	D-A53/A56	2-color indicator			
	D-A67		Water resistant (2-color indicator)		
	D-Z80		With timer		
Solid state	D-F59/F5P/J59	Grommet (In-line)	—		
	D-Y59A/Y59B/Y7P		2-color indicator		
	D-F59W/F5PW/J59W			Water resistant (2-color indicator)	
	D-Y7NW/Y7PW/Y7BW				With timer
	D-F5BA/Y7BA				
	D-F5NT	Grommet (Perpendicular)		2-color indicator	
	D-M9NV/M9PV/M9BV		Water resistant (2-color indicator)		
	D-Y69A/Y69B/Y7PV			2-color indicator	
	D-M9NWV/M9PWV/M9BWW				Water resistant (2-color indicator)
	D-Y7NWV/Y7PWV/Y7BWW				
D-M9NAV/M9PAV/M9BAV	Water resistant (2-color indicator)				

* With pre-wired connector is also available for solid state auto switches. For details, refer to pages 1014 and 1015.

* Normally closed (NC = b contact) solid state auto switches (D-M9□E(V)/Y7G/Y7H) are also available. For details, refer to pages 1592-1 and 961.



CS2Y Series Specific Product Precautions

Be sure to read this before handling the products. Refer to back page 50 for Safety Instructions and pages 3 to 12 for Actuator and Auto Switch Precautions.

Operating Precautions

⚠ Warning

- Do not use the cylinder as a shock absorber.**
Using the cylinder as a shock absorber may cause damage.
- Do not open the cushion valve beyond the stopper.**
As a retaining mechanism for the cushion valve, retaining ring is installed, and the cushion valve should not be opened beyond that point.
If not operated in accordance with the above precautions, the cushion valve may be ejected from the cover when air pressure is supplied.
To adjust the cushion valve, use the JIS B 4648 hexagon wrench key 4 (width across flats of cushion valve: 4).
- Use the air cushion at the end of cylinder stroke.**

⚠ Caution

- Do not use a pneumatic type as an air-hydro cylinder. It can cause oil leak.**
- Do not rotate the piston rod when the rod boot is fixed.**
Before rotating the piston rod, loosen the band to avoid twisting the rod boot.
- Install the rod boot with the breathing hole facing downwards or in a direction suitable to prevent dust, moisture etc. from entering easily into the rod boot.**

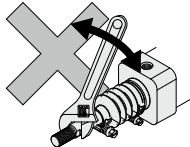

- Regarding the installation of a knuckle joint**
Please contact SMC if a knuckle joint must be installed on the piston rod by using the rod end nut.
- Regarding the screw-in of fittings when piping**
When ports and fittings are screwed in, tighten them with the proper tightening torque below.

Bore size [mm]	Connecting thread nominal size	Proper tightening torque N·m
125, 140	1/2	28 to 30
160	3/4	

- Do not deform cushion rings when removing and assembling.**
Cushion rings are press molded products. If a cushion ring bumps with something when removing and assembling, the air cushion may not function properly due to cushion ring deformation.
- Do not place tape or other objects onto the painted surface of the unit.**

The paint of the CS cylinder is dried naturally, so it may peel off if tape or another object is placed onto it.

Disassembly/Replacement

⚠ Caution

- Do not replace the bushing.**
As the bushing is press-fit, replace the cover assembly when the bushing must be replaced.
- When a seal is replaced, apply grease to the new seal before it is assembled.**
If the cylinder is put into operation without applying grease to the seal, it could cause the seal to wear significantly, leading to premature air leakage.
- Do not disassemble the trunnion type cylinder because the mounting precision is required.**
The trunnion type cylinder may lose dimensional accuracy and malfunction when it is disassembled and reassembled because the axial center of the trunnion and that of the cylinder will not be aligned easily.

REA

REB

REC

Smooth

Low Speed

MQ

RHC

RZQ

D-□

-X□

Smooth Cylinder

CQSY Series

ø12, ø16, ø20, ø25

How to Order

With auto switch **CDQSY B 20 - 30 D C - M9BW**

With auto switch
(Built-in magnet)

Mounting

B	Through-hole/Both ends tapped (Standard)
L	Foot (Note)
LC	Compact foot
F	Rod flange
G	Head flange
D	Double clevis

* Mounting bracket is shipped together with the product, (but not assembled).

Bore size

12	12 mm
16	16 mm
20	20 mm
25	25 mm

Cylinder stroke (mm)
Refer to "Standard Strokes" on page 226.

Action

D	Double acting
----------	---------------

Body option

Nil	Standard
F	With boss on head end

Number of auto switches

Nil	2 pcs.
S	1 pc.
n	"n" pcs.

Auto switch

Nil	Without auto switch
------------	---------------------

* For applicable auto switches, refer to the table below.

Rod end thread

Nil	Standard (Female rod end)
M	Male rod end

Cushion

C	Rubber bumper
----------	---------------

Built-in Magnet Cylinder Model

If a built-in magnet cylinder without an auto switch is required, there is no need to enter the symbol for the auto switch. (Example) CDQSYL25-30DC

Applicable Auto Switches/Refer to pages 941 to 1067 for further information on auto switches.

Type	Special function	Electrical entry	Indicator light	Wiring (Output)	Load voltage		Auto switch model		Lead wire (m)				Pre-wired connector	Applicable load		
					DC	AC	Perpendicular	In-line	0.5 (Nil)	1 (M)	3 (L)	5 (Z)		IC circuit	Relay, PLC	
Solid state auto switch	Diagnostic indication (2-color indicator)	Grommet	Yes	3-wire (NPN)	24 V	—	M9NV	M9N	●	●	●	○	○			—
				3-wire (PNP)			M9PV	M9P	●	●	○	○				
				2-wire			M9BV	M9B	●	●	○	○				
				3-wire (NPN)			M9NVW	M9NW	●	●	○	○				
	3-wire (PNP)			M9PVW			M9PW	●	●	○	○					
	2-wire			M9BWW			M9BW	●	●	○	○					
	3-wire (NPN)			M9NAV *1			M9NA *1	○	○	●	○					
	3-wire (PNP)			M9PAV *1			M9PA *1	○	○	●	○					
2-wire	M9BAV *1	M9BA *1	○	○	○	○										
2-wire (Non-polar)	—	P3DWA **2	●	—	●	●	○									
Reed auto switch	—	Grommet	Yes	3-wire (NPN equivalent)	24 V	12 V	A96V	A96	●	—	●	—	—	—	IC circuit	—
				2-wire			A93V **2	A93	●	●	●	—	—	—	—	Relay, PLC
				—			A90V	A90	●	—	●	—	—	—	—	IC circuit
				—			—	—	—	—	—	—	—	—	—	—

*1 Water resistant type auto switches can be mounted on the above models, but in such case SMC cannot guarantee water resistance. Please consult with SMC regarding water resistant types with the above model numbers.

*2 1 m type lead wire is only applicable to D-A93.

* Lead wire length symbols: 0.5 m Nil (Example) M9NW
 1 m M (Example) M9NWM
 3 m L (Example) M9NWL
 5 m Z (Example) M9NWZ

* Solid state auto switches marked with "○" are produced upon receipt of order.
 ** The D-P3DW□ is only compatible with ø25. It is mounted away from the port side to avoid interference with fittings.

* Since there are other applicable auto switches than listed, refer to page 232 for details.

* For details about auto switches with pre-wired connector, refer to pages 1014 and 1015.

* Auto switches are shipped together, (but not assembled).

Note) The D-A9□V/M9□V/M9□WV/M9□AV auto switches may not be mounted on the port side depending on the cylinder stroke or the fitting size of piping.

REA

REB

REC

Smooth

Low Speed

MQ

RHC

RZQ

D-□

-X□

CQSY Series

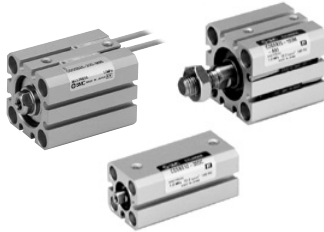

Symbol

Rubber bumper

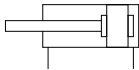

Replacement Parts/Seal Kit

Bore size (mm)	Kit no.	Contents
12	CQSY12-PS	Piston seal 1 pc. Rod seal 1 pc.
16	CQSY16-PS	Tube gasket 1 pc. Grease pack (10 g) 1 pc.
20	CQSY20-PS	
25	CQSY25-PS	

When maintenance requires only grease, use the following part numbers to order.

Grease pack part number: GR-L-005 (5 g)
GR-L-010 (10 g)
GR-L-150 (150 g)

Accessory

* For details about the single knuckle joint, double knuckle joint, knuckle pin, and rod end nut, refer to page 244.

Specifications

Bore size (mm)	12	16	20	25
Type	Pneumatic (Non-lube)			
Action	Double acting, Single rod			
Fluid	Air			
Proof pressure	1.05 MPa			
Maximum operating pressure	0.7 MPa			
Ambient and fluid temperature	Without auto switch: -10°C to 70°C With auto switch: -10°C to 60°C (No freezing)			
Cushion	Rubber bumper			
Rod end thread	Female thread			
Stroke length tolerance	+1.0 mm (Note) 0			
Piston speed	5 to 500 mm/s			
Allowable leakage rate	0.5 L/min (ANR) or less			

Note) Stroke length tolerance does not include the amount of bumper change.

Minimum Operating Pressure

Unit: MPa

Bore size (mm)	12	16	20	25
Minimum operating pressure	0.03		0.02	

Standard Strokes

Bore size (mm)	Standard stroke (mm)
12, 16	5, 10, 15, 20, 25, 30
20, 25	5, 10, 15, 20, 25, 30, 35, 40, 45, 50

Theoretical Output

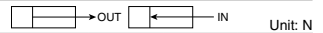

Bore size (mm)	Rod size (mm)	Operating direction	Piston area (mm ²)	Operating pressure (MPa)		
				0.3	0.5	0.7
12	6	IN	84.8	25	42	59
		OUT	113	34	57	79
16	8	IN	151	45	75	106
		OUT	201	60	101	141
20	10	IN	236	71	118	165
		OUT	314	94	157	220
25	12	IN	378	113	189	264
		OUT	491	147	245	344

Intermediate Stroke

Method	Installation of spacer on standard stroke body.		
Model no.	Refer to page 225 for standard model no.		
Standard stroke	Method	Intermediate strokes at 1 mm intervals are available by using spacers with standard stroke cylinders.	
	Stroke range	Bore size (mm)	Stroke range (mm)
		12, 16	1 to 29
20, 25	1 to 49		
Example	Part no.: CQSYB25-47DC CQSYB25-50DC with 3 mm width spacer inside. B dimension is 77.5 mm. Calculation: $\phi 25$, B dimension 27.5 mm (without auto switch) 27.5 (B dimension) + 50 (st) = 77.5 (mm)		

Weights/Without Auto Switch (g)

Bore size (mm)	Cylinder stroke (mm)									
	5	10	15	20	25	30	35	40	45	50
12	37	43	50	57	63	70	—	—	—	—
16	49	57	66	74	83	92	—	—	—	—
20	75	88	101	114	127	140	153	165	178	191
25	109	125	140	156	172	188	204	220	236	252

Weights/With Auto Switch (Built-in magnet) (g)

Bore size (mm)	Cylinder stroke (mm)									
	5	10	15	20	25	30	35	40	45	50
12	45	51	58	65	71	78	—	—	—	—
16	59	67	76	85	94	103	—	—	—	—
20	106	119	132	145	157	170	183	195	208	221
25	151	167	183	199	215	231	246	262	278	294

Additional Weights (g)

Bore size (mm)		12	16	20	25
Male rod end	Male thread	1.5	3	6	12
	Nut	1	2	4	8
With boss on head end		0.7	1.3	2	3
Foot (Including mounting bolt)		55	65	159	181
Compact foot (Including mounting bolt)		32	40	97	116
Rod flange (Including mounting bolt)		58	70	143	180
Head flange (Including mounting bolt)		56	66	137	171
Double clevis (Including pin, retaining ring, mounting bolt)		34	40	92	127

Mounting Bolt for CQSYB without Auto Switch

Mounting method: Mounting bolt for through-hole mounting type of the CQSYB is available as an option.

Refer to the following for ordering procedures. Order the actual number of bolts that will be used.

Example CQ-M3X30L 4 pcs.

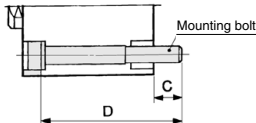

Note) When mounting a cylinder with through-hole, be sure to use the attached plain washer.

Cylinder model	C	D	Mounting bolt part no.
CQSYB12-5DC	6.5	30	CQ-M3X30L
-10DC		35	X35L
-15DC		40	X40L
-20DC		45	X45L
-25DC		50	X50L
-30DC		55	X55L
CQSYB16-5DC	6.5	30	CQ-M3X30L
-10DC		35	X35L
-15DC		40	X40L
-20DC		45	X45L
-25DC		50	X50L
-30DC		55	X55L
CQSYB20-5DC	6.5	30	CQ-M5X30L
-10DC		35	X35L
-15DC		40	X40L
-20DC		45	X45L

Cylinder model	C	D	Mounting bolt part no.
CQSYB20-25DC	6.5	50	CQ-M5X50L
-30DC		55	X55L
-35DC		60	X60L
-40DC		65	X65L
-45DC		70	X70L
-50DC		75	X75L
CQSYB25-5DC	8.5	35	CQ-M5X35L
-10DC		40	X40L
-15DC		45	X45L
-20DC		50	X50L
-25DC		55	X55L
-30DC		60	X60L
-35DC		65	X65L
-40DC		70	X70L
-45DC		75	X75L
-50DC		80	X80L

Material: Chromium molybdenum steel
Surface treatment: Zinc chromated

Mounting Bolt for CDQSYB with Auto Switch

Mounting method: Mounting bolt for through-hole mounting type of the CDQSYB is available as an option.

Refer to the following for ordering procedures. Order the actual number of bolts that will be used.

Example CQ-M3X35L 4 pcs.

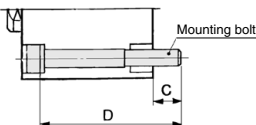

Note) When mounting a cylinder with through-hole, be sure to use the attached plain washer.

Cylinder model	C	D	Mounting bolt part no.
CDQSYB12-5DC	6.5	35	CQ-M3X35L
-10DC		40	X40L
-15DC		45	X45L
-20DC		50	X50L
-25DC		55	X55L
-30DC		60	X60L
CDQSYB16-5DC	6.5	35	CQ-M3X35L
-10DC		40	X40L
-15DC		45	X45L
-20DC		50	X50L
-25DC		55	X55L
-30DC		60	X60L
CDQSYB20-5DC	6.5	40	CQ-M5X40L
-10DC		45	X45L
-15DC		50	X50L
-20DC		55	X55L
-25DC		60	X60L

Cylinder model	C	D	Mounting bolt part no.
CDQSYB20-25DC	6.5	60	CQ-M5X60L
-30DC		65	X65L
-35DC		70	X70L
-40DC		75	X75L
-45DC		80	X80L
-50DC		85	X85L
CDQSYB25-5DC	8.5	45	CQ-M5X45L
-10DC		50	X50L
-15DC		55	X55L
-20DC		60	X60L
-25DC		65	X65L
-30DC		70	X70L
-35DC		75	X75L
-40DC		80	X80L
-45DC		85	X85L
-50DC		90	X90L

Material: Chromium molybdenum steel
Surface treatment: Zinc chromated

REA

REB

REC

Smooth

Low Speed

MQ

RHC

RZQ

CQSY Series

Dimensions: $\phi 12$ to $\phi 25$

Standard (Through-hole/Both ends tapped): CQSYB/CDQSYB

$\phi 12$

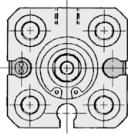

$\phi 16$

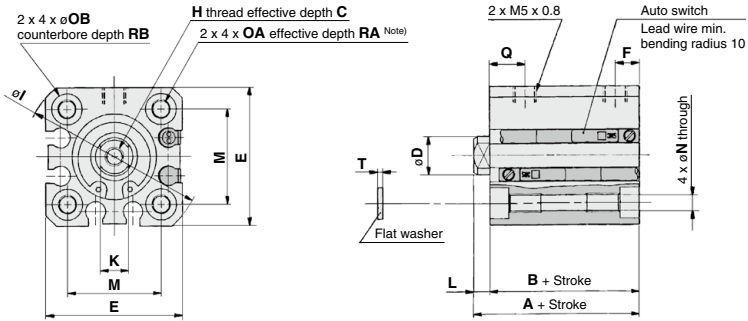

$\phi 20, \phi 25$

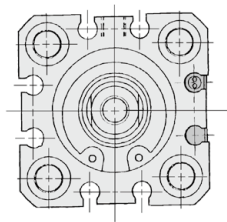

Male rod end

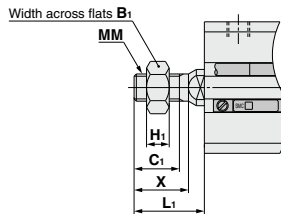

With boss on head end

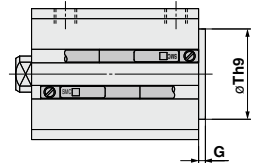

Male Rod End

Bore size (mm)	B1	C1	H1	L1	MM	X
12	8	9	4	14	M5 x 0.8	10.5
16	10	10	5	15.5	M6 x 1.0	12
20	13	12	5	18.5	M8 x 1.25	14
25	17	15	6	22.5	M10 x 1.25	17.5

With Boss on Head End (mm)

Bore size (mm)	G	Th9
12	1.5	15.0 _{0.043}
16	1.5	20.0 _{0.052}
20	2	13.0 _{0.043}
25	2	15.0 _{0.043}

Note) The product with boss on head end is applicable to only the standard stroke.

Standard

Bore size (mm)	Stroke range (mm)	Without auto switch		With auto switch		C	D	E	F	H	I	K	L	M	N	OA	OB	Q	RA	RB	T
		A	B	A	B																
12	5 to 30	25.5	22	30.5	27	6	6	25	5	M3 x 0.5	32	5	3.5	15.5	3.5	M4 x 0.7	6.5	7.5	7	4	0.5
16	5 to 30	25.5	22	30.5	27	8	8	29	5	M4 x 0.7	38	6	3.5	20	3.5	M4 x 0.7	6.5	7.5	7	4	0.5
20	5 to 50	29	24.5	39	34.5	7	10	36	5.5	M5 x 0.8	47	8	4.5	25.5	5.4	M6 x 1.0	9	8	10	7	1
25	5 to 50	32.5	27.5	42.5	37.5	12	12	40	5.5	M6 x 1.0	52	10	5	28	5.4	M6 x 1.0	9	9	10	7	1

Note) Threaded through-hole is used for the standard of $\phi 20$ with 5 to 10 mm strokes and $\phi 25$ with a 5 mm stroke.

Dimensions: $\phi 12$ to $\phi 25$

Foot: CQSYL/CDQSYL

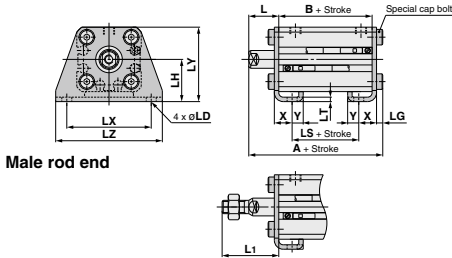

Male rod end

Foot

Bore size (mm)	Stroke range (mm)	Without auto switch			With auto switch		
		A	B	LS	A	B	LS
12	5 to 30	40.3	22	10	45.3	27	15
16	5 to 30	40.3	22	10	45.3	27	15
20	5 to 50	46.2	24.5	12.5	56.2	34.5	22.5
25	5 to 50	49.7	27.5	12.5	59.7	37.5	22.5

Bore size (mm)	L	L ₁	LD	LG	LH	LT	LX	LY	LZ	X	Y
12	13.5	24	4.5	2.8	17	2	34	29.5	44	8	4.5
16	13.5	25.5	4.5	2.8	19	2	38	33.5	48	8	5
20	14.5	28.5	6.6	4	24	3.2	48	42	62	9.2	5.8
25	15	32.5	6.6	4	26	3.2	52	46	66	10.7	5.8

Foot bracket material: Carbon steel
Surface treatment: Nickel plating

Compact foot: CQSYLC/CDQSYLC

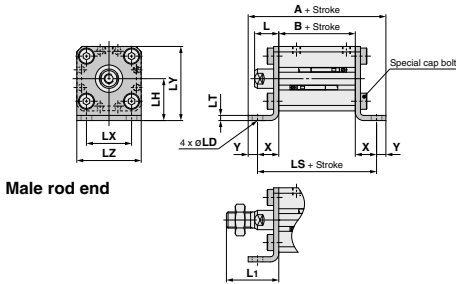

Male rod end

Compact Foot

Bore size (mm)	Stroke range (mm)	Without auto switch			With auto switch		
		A	B	LS	A	B	LS
12	5 to 30	49.6	22	40.6	54.6	27	45.6
16	5 to 30	50.6	22	40.6	55.6	27	45.6
20	5 to 50	62.5	24.5	50.9	72.5	34.5	60.9
25	5 to 50	65.5	27.5	53.9	75.5	37.5	63.9

Bore size (mm)	L	L ₁	LD	LH	LT	LX	LY	LZ	X	Y
12	13.5	24	4.5	17	2	15.5	29.5	25	9.3	4.5
16	13.5	25.5	4.5	19	2	20	33.5	29	9.3	5
20	14.5	28.5	6.6	24	3.2	25.5	42	36	13.2	5.8
25	15	32.5	6.6	26	3.2	28	46	40	13.2	5.8

Compact foot bracket material: Carbon steel
Surface treatment: Zinc chromated

Rod flange: CQSYF/CDQSYF

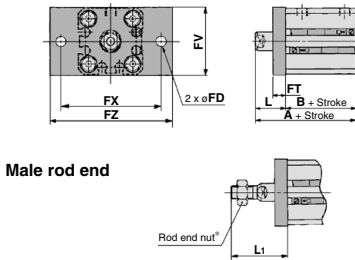

Male rod end

Rod Flange

Bore size (mm)	Stroke range (mm)	Without auto switch		With auto switch	
		A	B	A	B
12	5 to 30	35.5	22	40.5	27
16	5 to 30	35.5	22	40.5	27
20	5 to 50	39	24.5	49	34.5
25	5 to 50	42.5	27.5	52.5	37.5

Bore size (mm)	FD	FT	FV	FX	FZ	L	L ₁
12	4.5	5.5	25	45	55	13.5	24
16	4.5	5.5	30	45	55	13.5	25.5
20	6.6	8	39	48	60	14.5	28.5
25	6.6	8	42	52	64	15	32.5

Flange bracket material: Carbon steel
Surface treatment: Nickel plating

* For details about the rod end nut and accessory brackets, refer to page 244.

REA

REB

REC

Smooth

Low Speed

MQ

RHC

RZQ

D-□

-X□

CQSY Series

Dimensions: $\varnothing 12$ to $\varnothing 25$

Head flange: CQSYG/CDQSYG

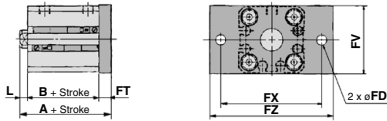

Male rod end

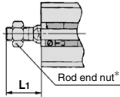

Head Flange

Bore size (mm)	Stroke range (mm)	Without auto switch		With auto switch	
		A	B	A	B
12	5 to 30	31	22	36	27
16	5 to 30	31	22	36	27
20	5 to 50	37	24.5	47	34.5
25	5 to 50	40.5	27.5	50.5	37.5

Bore size (mm)	FD	FT	FV	FX	FZ	L	L ₁
12	4.5	5.5	25	45	55	3.5	14
16	4.5	5.5	30	45	55	3.5	15.5
20	6.6	8	39	48	60	4.5	18.5
25	6.6	8	42	52	64	5	22.5

Flange bracket material: Carbon steel
Surface treatment: Nickel plating

Double clevis: CQSYD/CDQSYD

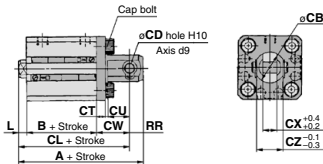

Male rod end

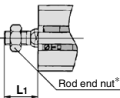

Double Clevis

Bore size (mm)	Stroke range (mm)	Without auto switch			With auto switch		
		A	B	CL	A	B	CL
12	5 to 30	45.5	22	39.5	50.5	27	44.5
16	5 to 30	46.5	22	40.5	51.5	27	45.5
20	5 to 50	56	24.5	47	66	34.5	57
25	5 to 50	62.5	27.5	52.5	72.5	37.5	62.5

Bore size (mm)	CB	CD	CT	CU	CW	CX	CZ	L	L ₁	RR
12	12	5	4	7	14	5	10	3.5	14	6
16	14	5	4	10	15	6.5	12	3.5	15.5	6
20	20	8	5	12	18	8	16	4.5	18.5	9
25	24	10	5	14	20	10	20	5	22.5	10

Double clevis bracket material: Carbon steel
Surface treatment: Nickel plating

* For details about the rod end nut and accessory brackets, refer to page 244.

CQSY Series Auto Switch Mounting

Minimum Stroke for Auto Switch Mounting

(mm)							
Number of auto switches	D-M9□V	D-A9□V	D-M9□WV D-M9□AV	D-A9□	D-M9□W D-M9□A	D-M9□	D-P3DWA <small>Note 1)</small>
With 1 pc.	5	5	10	10 (5)	15 (10)	15 (5)	15
With 2 pcs.	5	10	10	10	15 (10)	15 (5)	15

Note 1) ø25 is only applicable for the D-P3DWA□.

Note 2) The dimensions stated in () shows the minimum stroke for the auto switch mounting when the auto switch does not project from the end surface of the cylinder body and hinder the lead wire bending space. (Refer to the figure on the right.)

Order auto switches separately.

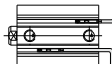

Auto Switch Proper Mounting Position (Detection at stroke end) and Its Mounting Height

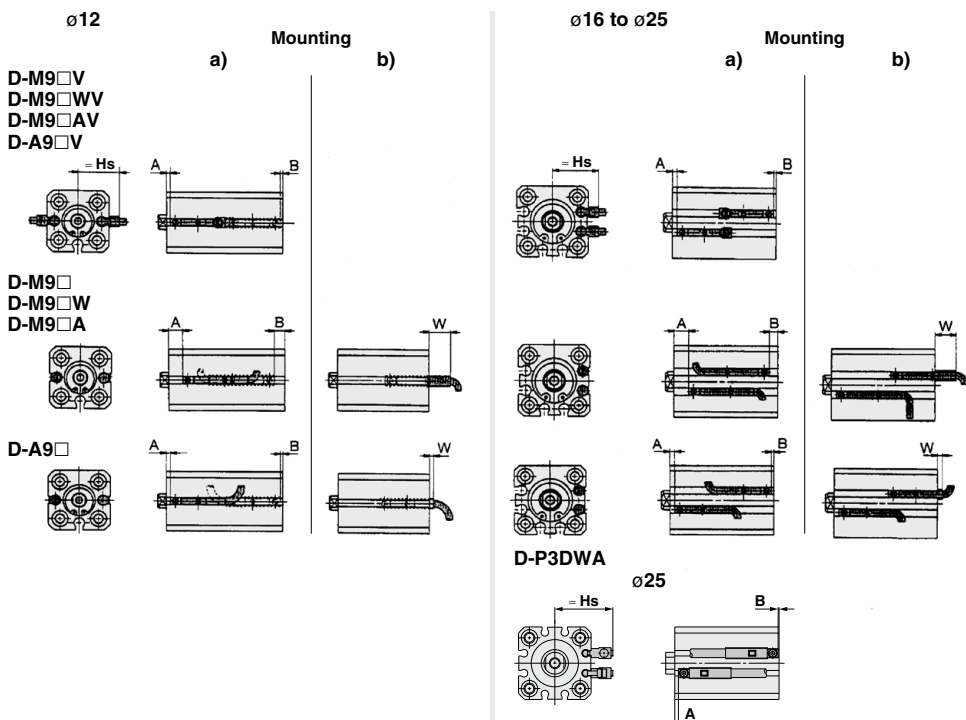

Auto Switch Proper Mounting Position

Auto switch model	D-M9□/M9□W			D-M9□V/M9□WV M9□AV			D-M9□A			D-A9□			D-A9□V			D-P3DWA		
	A	B	W	A	B	Hs	A	B	W	A	B	W	A	B	Hs	A	B	Hs
Bore size 12	10	5	5	10	5	19.5	10	5	7	6	1	1 [3.5]	6	1	17	—	—	—
16	9.5	5.5	4.5	9.5	5.5	21.5	9.5	5.5	6.5	5.5	1.5	0.5 [3]	5.5	1.5	19	—	—	—
20	13	9.5	0.5	13	9.5	25	13	9.5	2.5	9	5.5	-3.5 [-1]	9	5.5	22.5	—	—	—
25	14	11.5	-1.5	14	11.5	27	14	11.5	0.5	10	7.5	-5.5 [-3]	10	7.5	24.5	9.5	7	33

Note 1) []: Denotes the dimensions of the D-A9□.

Note 2) Adjust the auto switch after confirming the operating condition in the actual setting.

Note 3) The product is shipped out of the factory in installation state "a)". To change the electrical entry direction of the switch on the head, refer to installation state "b)".

Note 4) Negative figures for W indicate an auto switch is mounted inward from the edge of the cylinder body.

REA

REB

REC

Smooth

Low Speed

MQ

RHC

RZQ

Operating Range

Auto switch model	(mm)			
	Bore size			
	12	16	20	25
D-M9□/M9□V D-M9□W/M9□WV D-M9□A/M9□AV	3	3.5	5.5	4.5
D-A9□/A9□V	6	7.5	10	10
D-P3DWA	—	—	—	6

* Values which include hysteresis are for guideline purposes only, they are not a guarantee (assuming approximately $\pm 30\%$ dispersion) and may change substantially depending on the ambient environment.

Other than the applicable auto switches listed in “How to Order”, the following auto switches are mountable.

* With pre-wired connector is also available for solid state auto switches. For details, refer to pages 1014 and 1015.

* Normally closed (NC = b contact) solid state auto switches (D-M9□E(V)) are also available. For details, refer to page 1592-1.

⚠ Precautions

Be sure to read this before handling the products.

Refer to back page 50 for Safety Instructions and pages 3 to 12 for Actuator and Auto Switch Precautions.

- If the cylinder is used in an application in which a magnetic material is placed in close contact around the cylinder as shown in the figure on the right (including cases in which even one of the sides is in close contact) the operation of auto switches could become unstable. Therefore, please consult with SMC for this type of application.

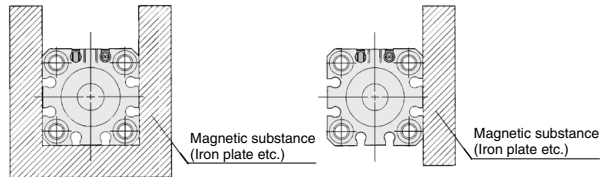

Smooth Cylinder

CQ2Y Series

ø32, ø40, ø50, ø63, ø80, ø100

How to Order

With auto switch CQ2Y B 32 - 30 D C Z

With auto switch CDQ2Y B 32 - 30 D C Z - M9BW

Mounting

B	Through-hole (Standard)
A	Both ends tapped
L	Foot (Note)
LC	Compact foot
F	Rod flange
G	Head flange
D	Double clevis

Bore size

32	32 mm
40	40 mm
50	50 mm
63	63 mm
80	80 mm
100	100 mm

Thread type

Nil	Rc
TN	NPT
TF	G

Cylinder stroke (mm)
Refer to "Standard Strokes" on page 234.

Action

D	Double acting
---	---------------

Body option 1

Nil	Standard
F	With boss on head end

Auto switch

Nil	Without auto switch
S	1 pc.
n	"n" pcs.

* For applicable auto switches, refer to the table below.

Auto switch mounting groove

Z	4 surfaces
---	------------

Body option 2

Nil	Standard (Female rod end)
M	Male rod end

Cushion

C	Rubber bumper
---	---------------

Number of auto switches

With auto switch (Built-in magnet)

Built-in Magnet Cylinder Model

If a built-in magnet cylinder without an auto switch is required, there is no need to enter the symbol for the auto switch. (Example) CDQ2YL40-50DCZ

Applicable Auto Switches/Refer to pages 941 to 1067 for further information on auto switches.

Type	Special function	Electrical entry	Indicator light	Wiring (Output)	Load voltage		Auto switch model		Lead wire (m)					Pre-wired connector	Applicable load		
					DC	AC	Perpendicular	In-line	0.5 (Nil)	1 (M)	3 (L)	5 (Z)	None (N)				
									—	—	—	—				—	—
Solid state auto switch	—	Grommet	Yes	3-wire (NPN)	24 V	5 V, 12 V	—	M9NV	M9N	●	●	○	—	○	IC circuit		
				3-wire (PNP)				M9PV	M9P	●	●	○	—	○			
				2-wire				M9BV	M9B	●	●	○	—	○		—	
				3-wire (NPN)				M9NWV	M9NW	●	●	○	—	○		IC circuit	
	2-wire			M9PWW	M9PW	●	●	○	—	○	—						
	3-wire (PNP)			M9BWW	M9BW	●	●	○	—	○	—						
	3-wire (NPN)			M9NAV ^{*1}	M9NA ^{*1}	○	○	●	—	○	IC circuit						
	3-wire (PNP)			M9PAV ^{*1}	M9PA ^{*1}	○	○	●	—	○		—					
Reed auto switch	—	Grommet	No	3-wire (NPN equivalent)	24 V	5 V, 12 V	100 V	A96V	A96	●	—	●	—	—	IC circuit	Relay, PLC	
				2-wire				A93V ^{*2}	A93	●	●	●	—	—	—		
				—				A90V	A90	●	—	●	—	—	—		IC circuit
				—				—	P3DWA	●	—	●	—	—	—		—

*1 Water resistant type auto switches can be mounted on the above models, but in such case SMC cannot guarantee water resistance.

Please consult with SMC regarding water resistant types with the above model numbers.

*2 1 m type lead wire is only applicable to D-A93.

* Lead wire length symbols: 0.5 m Nil (Example) M9NW
 1 m M (Example) M9NW
 3 m L (Example) M9NL
 5 m Z (Example) M9WZ

* Solid state auto switches marked with "○" are produced upon receipt of order.

* Since there are other applicable auto switches than listed, refer to page 249 for details.

* For details about auto switches with pre-wired connector, refer to pages 1014 and 1015.

REA

REB

REC

Smooth

Low Speed

MQ

RHC

RZQ

D-□

-X□

CQ2Y Series



Symbol

Rubber bumper

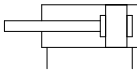

Replacement Parts/Seal Kit

Bore size (mm)	Kit no.	Contents
32	CQ2Y32-PS	
40	CQ2Y40-PS	Piston seal 1 pc.
50	CQ2Y50-PS	Rod seal 1 pc.
63	CQ2Y63-PS	Tube gasket 1 pc.
80	CQ2Y80-PS	Grease pack (10 g) 1 pc.
100	CQ2Y100-PS	

When maintenance requires only grease, use the following part numbers to order.

Grease pack part number: GR-L-005 (5 g)
GR-L-010 (10 g)
GR-L-150 (150 g)

Accessory

- * For details about the single knuckle joint, double knuckle joint, knuckle pin, and rod end nut, refer to page 244.
- * Stainless steel mounting brackets and accessories are also available. Refer to page 244 for details.

Specifications

Bore size (mm)	32	40	50	63	80	100
Type	Pneumatic (Non-lube)					
Fluid	Air					
Proof pressure	1.05 MPa					
Maximum operating pressure	0.7 MPa					
Ambient and fluid temperature	Without auto switch: -10°C to 70°C (No freezing) With auto switch: -10°C to 60°C					
Cushion	Rubber bumper (Standard)					
Stroke length tolerance	+1.0 mm (Note) 0					
Piston speed range	5 to 500 mm/s					
Allowable leakage rate	0.5 L/min (ANR) or less					

Note) Stroke length tolerance does not include the amount of bumper change.

Minimum Operating Pressure

Bore size (mm)	32	40	50	63	80	100
Minimum operating pressure	0.02		0.01			

Unit: MPa

Standard Strokes

Bore size (mm)	Standard stroke (mm)
32, 40	5, 10, 15, 20, 25, 30, 35, 40, 45, 50, 75, 100
50, 63, 80, 100	10, 15, 20, 25, 30, 35, 40, 45, 50, 75, 100

Theoretical Output

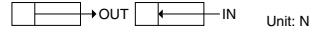

Bore size (mm)	Operating direction	Operating pressure (MPa)		
		0.3	0.5	0.7
32	IN	181	302	422
	OUT	241	402	563
40	IN	317	528	739
	OUT	377	628	880
50	IN	495	825	1155
	OUT	589	982	1374
63	IN	841	1402	1962
	OUT	935	1559	2182
80	IN	1361	2268	3175
	OUT	1508	2513	3519
100	IN	2144	3574	5003
	OUT	2356	3927	5498

Unit: N

Intermediate Stroke

Method	Installation of spacer on standard stroke body.				
Model no.	Refer to page 233 for standard model no.				
Standard stroke	Method	Intermediate strokes at 1 mm intervals are available by using spacers with standard stroke cylinders.			
	Stroke range	<table border="1"> <thead> <tr> <th>Bore size (mm)</th> <th>Stroke range (mm)</th> </tr> </thead> <tbody> <tr> <td>32 to 100</td> <td>1 to 99</td> </tr> </tbody> </table>	Bore size (mm)	Stroke range (mm)	32 to 100
Bore size (mm)	Stroke range (mm)				
32 to 100	1 to 99				
Example	Part no.: CQ2YB50-57DCZ CQ2YB50-75DCZ with 18 mm width spacer inside. B dimension is 125.5 mm. Calculation: $\phi 50$, B dimension 50.5 mm (without switch) $50.5 \text{ (B dimension)} + 75 \text{ (st)} = 125.5 \text{ (mm)}$				

Weights

Weights/Without Auto Switch

(g)

Bore size (mm)	Cylinder stroke (mm)											
	5	10	15	20	25	30	35	40	45	50	75	100
32	134	154	174	193	213	233	252	272	291	311	457	556
40	211	232	254	275	297	318	340	361	383	404	577	689
50	—	369	402	435	467	500	533	566	598	632	902	1073
63	—	557	595	633	671	709	747	786	824	862	1189	1386
80	—	983	1043	1104	1164	1224	1284	1345	1405	1465	1985	2281
100	—	1711	1792	1872	1952	2033	2113	2194	2274	2354	3086	3494

REA

REB

REC

Smooth

Low Speed

MQ

RHC

RZQ

Weights/With Auto Switch (Built-in magnet)

(g)

Bore size (mm)	Cylinder stroke											
	5	10	15	20	25	30	35	40	45	50	75	100
32	191	211	230	250	270	289	309	329	348	368	468	567
40	284	305	327	348	369	391	412	434	455	477	589	701
50	—	480	513	546	579	611	644	677	710	743	915	1087
63	—	710	748	787	825	863	901	939	977	1015	1211	1408
80	—	1229	1289	1350	1410	1470	1530	1591	1651	1711	2008	2305
100	—	2070	2150	2231	2311	2391	2472	2552	2633	2713	3121	3529

Additional Weights

(g)

Bore size (mm)		32	40	50	63	80	100
Both ends tapped		6	6	6	19	45	45
Male rod end	Male thread	26	27	53	53	120	175
	Nut	17	17	32	32	49	116
With boss on head end		5	7	13	25	45	96
Foot (Including mounting bolt)		142	154	243	320	690	1057
Compact foot (Including mounting bolt)		99	114	177	241	501	770
Rod flange (Including mounting bolt)		180	214	373	559	1056	1365
Head flange (Including mounting bolt)		165	198	348	534	1017	1309
Double clevis (Including pin, retaining ring, mounting bolt)		151	196	393	554	1109	1887

Calculation (Example) **CQ2YD32-20DCMZ**

- Basic weight: CQ2YB32-20DCZ..... 193 g
- Additional weight: Both ends tapped..... 6 g
- Male rod end..... 43 g
- Double clevis 151 g

Total **393 g**

CQ2Y Series

Mounting Bolt

Mounting method: Mounting bolt for through-hole mounting type of the CQ2YB is available as an option.

Refer to the following for ordering procedures.
Order the actual number of bolts that will be used.

Example) CQ-M5X40L 2 pcs.

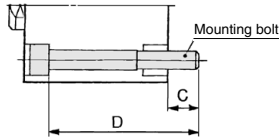

Mounting Bolt for CQ2YB without Auto Switch

Cylinder model	C	D	Mounting bolt part no.
CQ2YB32- 5DC	9	40	CQ-M5X40L
- 10DC		45	X45L
- 15DC		50	X50L
- 20DC		55	X55L
- 25DC		60	X60L
- 30DC		65	X65L
- 35DC		70	X70L
- 40DC		75	X75L
- 45DC		80	X80L
- 50DC		85	X85L
- 75DC		120	X120L
-100DC	145	X145L	
CQ2YB40- 5DC	7.5	45	CQ-M5X45L
- 10DC		50	X50L
- 15DC		55	X55L
- 20DC		60	X60L
- 25DC		65	X65L
- 30DC		70	X70L
- 35DC		75	X75L
- 40DC		80	X80L
- 45DC		85	X85L
- 50DC		90	X90L
- 75DC		125	X125L
-100DC	150	X150L	
CQ2YB50- 10DC	12.5	55	CQ-M6X55L
- 15DC		60	X60L
- 20DC		65	X65L
- 25DC		70	X70L
- 30DC		75	X75L
- 35DC		80	X80L
- 40DC		85	X85L
- 45DC		90	X90L
- 50DC		95	X95L
- 75DC		130	X130L
-100DC		155	X155L

Cylinder model	C	D	Mounting bolt part no.
CQ2YB63- 10DC	14.5	60	CQ-M8X60L
- 15DC		65	X65L
- 20DC		70	X70L
- 25DC		75	X75L
- 30DC		80	X80L
- 35DC		85	X85L
- 40DC		90	X90L
- 45DC		95	X95L
- 50DC		100	X100L
- 75DC		135	X135L
-100DC		160	X160L
CQ2YB80- 10DC	15	65	CQ-M10X65L
- 15DC		70	X70L
- 20DC		75	X75L
- 25DC		80	X80L
- 30DC		85	X85L
- 35DC		90	X90L
- 40DC		95	X95L
- 45DC		100	X100L
- 50DC		105	X105L
- 75DC		140	X140L
-100DC		165	X165L
CQ2YB100- 10DC	15.5	75	CQ-M10X75L
- 15DC		80	X80L
- 20DC		85	X85L
- 25DC		90	X90L
- 30DC		95	X95L
- 35DC		100	X100L
- 40DC		105	X105L
- 45DC		110	X110L
- 50DC		115	X115L
- 75DC		150	X150L
-100DC		175	X175L

Material: Chromium molybdenum steel
Surface treatment: Zinc chromated

Mounting Bolt for CDQ2YB with Auto Switch (Built-in magnet)

Cylinder model	C	D	Mounting bolt part no.	
CDQ2YB32-	5	50	CQ-M5X50L	
- 10		55	X55L	
- 15		60	X60L	
- 20		65	X65L	
- 25		70	X70L	
- 30		75	X75L	
- 35		80	X80L	
- 40		85	X85L	
- 45		90	X90L	
- 50		95	X95L	
- 75		120	X120L	
-100		145	X145L	
CDQ2YB40-		7.5	55	CQ-M5X55L
- 10			60	X60L
- 15	65		X65L	
- 20	70		X70L	
- 25	75		X75L	
- 30	80		X80L	
- 35	85		X85L	
- 40	90		X90L	
- 45	95		X95L	
- 50	100		X100L	
- 75	125		X125L	
-100	150		X150L	
CDQ2YB50-	12.5		65	CQ-M6X65L
- 15			70	X70L
- 20		75	X75L	
- 25		80	X80L	
- 30		85	X85L	
- 35		90	X90L	
- 40		95	X95L	
- 45		100	X100L	
- 50		105	X105L	
- 75		130	X130L	
-100		155	X155L	

Cylinder model	C	D	Mounting bolt part no.	
CDQ2YB63-	10	70	CQ-M8X70L	
- 15		75	X75L	
- 20		80	X80L	
- 25		85	X85L	
- 30		90	X90L	
- 35		95	X95L	
- 40		100	X100L	
- 45		105	X105L	
- 50		110	X110L	
- 75		135	X135L	
-100		160	X160L	
CDQ2YB80-		14.5	75	CQ-M10X75L
- 15			80	X80L
- 20			85	X85L
- 25	90		X90L	
- 30	95		X95L	
- 35	100		X100L	
- 40	105		X105L	
- 45	110		X110L	
- 50	115		X115L	
- 75	140		X140L	
-100	165		X165L	
CDQ2YB100-	15		85	CQ-M10X85L
- 15			90	X90L
- 20			95	X95L
- 25		100	X100L	
- 30		105	X105L	
- 35		110	X110L	
- 40		115	X115L	
- 45		120	X120L	
- 50		125	X125L	
- 75		150	X150L	
-100		175	X175L	

Material: Chromium molybdenum steel
Surface treatment: Zinc chromated

REA

REB

REC

Smooth

Low
Speed

MQ

RHC

RZQ

D-□

-X□

CQ2Y Series

Bore Size

ø32 to ø50

(Types with auto switch and without auto switch only differ in the A and B dimensions. Refer to the table below.)

Through-hole: CQ2YB/CDQ2YB

Both ends tapped: CQ2YA/CDQ2YA

CDQ2YA

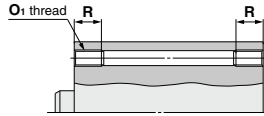

Both Ends Tapped (mm)

Bore size (mm)	O1	R
32	M6 x 1.0	10
40	M6 x 1.0	10
50	M8 x 1.25	14

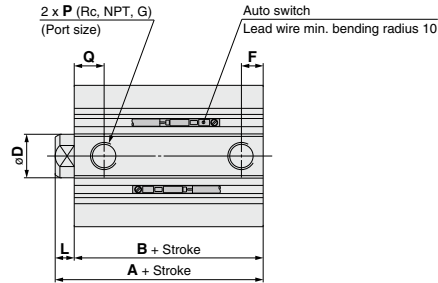
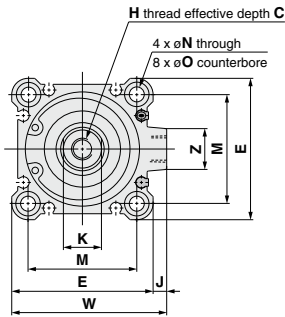

With boss on head end

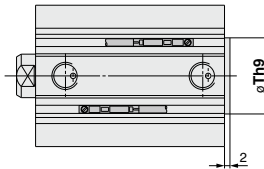

With Boss on Head End (mm)

Bore size (mm)	Th9
32	21 ⁰ _{-0.052}
40	28 ⁰ _{-0.052}
50	35 ⁰ _{-0.062}

Male rod end

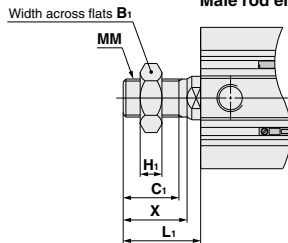

Male Rod End

(mm)

Bore size (mm)	B1	C1	H1	L1	MM	X
32	22	20.5	8	28.5	M14 x 1.5	23.5
40	22	20.5	8	28.5	M14 x 1.5	23.5
50	27	26	11	33.5	M18 x 1.5	28.5

Bore size (mm)	Stroke range (mm)	Without auto switch		With auto switch		C	D	E	F	H	J	K	L	M	N	O	P	Q	W	Z
		A	B	A	B															
32	5 to 50	40	33	50	43	13	16	45	7.5	M8 x 1.25	4.5	14	7	34	5.5	9 depth 7	1/8	10	49.5	14
	75, 100	50	43																	
40	5 to 50	46.5	39.5	56.5	49.5	13	16	52	7.5	M8 x 1.25	5	14	7	40	5.5	9 depth 7	1/8	12.5	57	14
	75, 100	56.5	49.5																	
50	10 to 50	48.5	40.5	58.5	50.5	15	20	64	10.5	M10 x 1.5	7	17	8	50	6.6	11 depth 8	1/4	10.5	71	19
	75, 100	58.5	50.5																	

Bore Size

ø32 to ø50

(Types with auto switch and without auto switch only differ in the A and B dimensions. Refer to the table below.)

Foot: CQ2YL/CDQ2YL

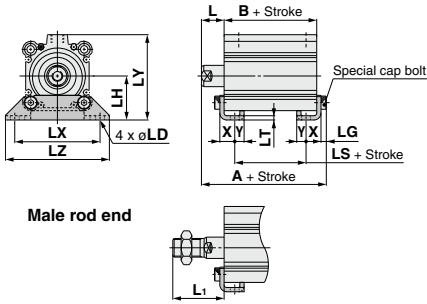

Foot

Bore size (mm)	Stroke range (mm)	Without auto switch			With auto switch			L	L ₁	LD
		A	B	LS	A	B	LS			
32	5 to 50	57.2	33	17	67.2	43	27	17	38.5	6.6
	75, 100	67.2	43	27						
40	5 to 50	63.7	39.5	23.5	73.7	49.5	33.5	17	38.5	6.6
	75, 100	73.7	49.5	33.5						
50	10 to 50	66.7	40.5	17.5	76.7	50.5	27.5	18	43.5	9
	75, 100	76.7	50.5	27.5						

Bore size (mm)	Stroke range (mm)	LG	LH	LT	LX	LY	LZ	X	Y
32	5 to 50	4	30	3.2	57	57	71	11.2	5.8
	75, 100								
40	5 to 50	4	33	3.2	64	64	78	11.2	7
	75, 100								
50	10 to 50	5	39	3.2	79	78	95	14.7	8
	75, 100								

Foot bracket material: Carbon steel
Surface treatment: Nickel plating

Compact foot: CQ2YLC/CDQ2YLC

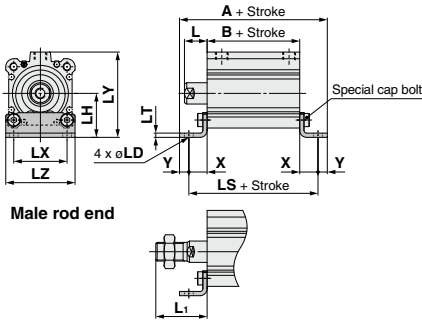

Compact Foot

Bore size (mm)	Stroke range (mm)	Without auto switch			With auto switch			L	L ₁	LD
		A	B	LS	A	B	LS			
32	5 to 50	72	33	60.4	82	43	70.4	17	38.5	6.6
	75, 100	82	43	70.4						
40	5 to 50	80.9	39.5	66.9	90.9	49.5	76.9	17	38.5	6.6
	75, 100	90.9	49.5	76.9						
50	10 to 50	89.9	40.5	73.9	99.9	50.5	83.9	18	43.5	9
	75, 100	99.9	50.5	83.9						

Bore size (mm)	Stroke range (mm)	LH	LT	LX	LY	LZ	X	Y
32	5 to 50	30	3.2	34	57	45	13.7	5.8
	75, 100							
40	5 to 50	33	3.2	40	64	52	13.7	7
	75, 100							
50	10 to 50	39	3.2	50	78	64	16.7	8
	75, 100							

Compact foot bracket material: Carbon steel
Surface treatment: Zinc chromated

Rod flange: CQ2YF/CDQ2YF

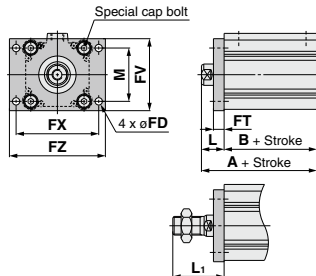

Rod Flange

Bore size (mm)	Stroke range (mm)	Without auto switch		With auto switch		FD	FT	FV	FX	FZ
		A	B	A	B					
32	5 to 50	50	33	60	43	5.5	8	48	56	65
	75, 100	60	43							
40	5 to 50	56.5	39.5	66.5	49.5	5.5	8	54	62	72
	75, 100	66.5	49.5							
50	10 to 50	58.5	40.5	68.5	50.5	6.6	9	67	76	89
	75, 100	68.5	50.5							

Bore size (mm)	Stroke range (mm)	L	L ₁	M
32	5 to 50	17	38.5	34
	75, 100			
40	5 to 50	17	38.5	40
	75, 100			
50	10 to 50	18	43.5	50
	75, 100			

Flange bracket material: Carbon steel
Surface treatment: Nickel plating

* For details about the rod end nut and accessory brackets, refer to page 244.

REA

REB

REC

Smooth

Low

Speed

MQ

RHC

RZQ

CQ2Y Series

Bore Size

ø32 to ø50

(Types with auto switch and without auto switch only differ in the A and B dimensions. Refer to the table below.)

Head flange: CQ2YG/CDQ2YG

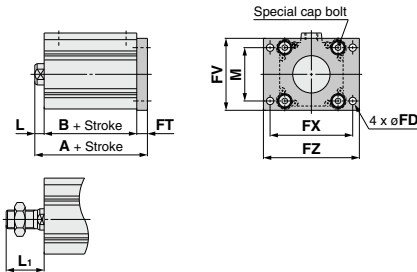

Head Flange

Bore size (mm)	Stroke range (mm)	(mm)			
		Without auto switch	With auto switch	L	L ₁
32	5 to 50	48	58	7	28.5
	75, 100	58			
40	5 to 50	54.5	64.5	7	28.5
	75, 100	64.5			
50	10 to 50	57.5	67.5	8	33.5
	75, 100	67.5			

Flange bracket material: Carbon steel

Surface treatment: Nickel plating

(* Dimensions except A, L and L₁ are the same as rod flange type.)

Double clevis: CQ2YD/CDQ2YD

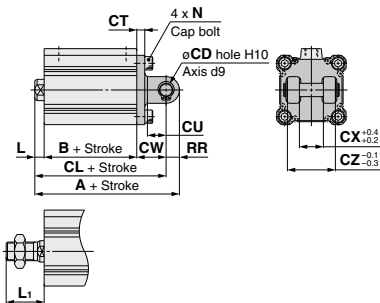

Double Clevis

Bore size (mm)	Stroke range (mm)	(mm)								
		Without auto switch			With auto switch			CD	CT	CU
32	5 to 50	70	33	60	80	43	70	10	5	14
	75, 100	80	43	70						
40	5 to 50	78.5	39.5	68.5	88.5	49.5	78.5	10	6	14
	75, 100	88.5	49.5	78.5						
50	10 to 50	90.5	40.5	76.5	100.5	50.5	86.5	14	7	20
	75, 100	100.5	50.5	86.5						

Bore size (mm)	Stroke range (mm)	CW	CX	CZ	L	L ₁	N	RR
32	5 to 50	20	18	36	7	28.5	M6 x 1.0	10
	75, 100							
40	5 to 50	22	18	36	7	28.5	M6 x 1.0	10
	75, 100							
50	10 to 50	28	22	44	8	33.5	M8 x 1.25	14
	75, 100							

Double clevis bracket material: Cast iron

Surface treatment: Painted

* For details about the rod end nut and accessory brackets, refer to page 244.

* A double clevis pin and retaining rings are included.

Bore Size

ø63 to ø100

(Types with auto switch and without auto switch only differ in the A and B dimensions. Refer to the table below.)

Through-hole: CQ2YB/CDQ2YB

Both ends tapped: CQ2YA/CDQ2YA

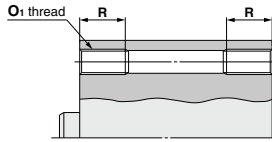

Both Ends Tapped (mm)

Bore size (mm)	O1	R
63	M10 x 1.5	18
80	M12 x 1.75	22
100	M12 x 1.75	22

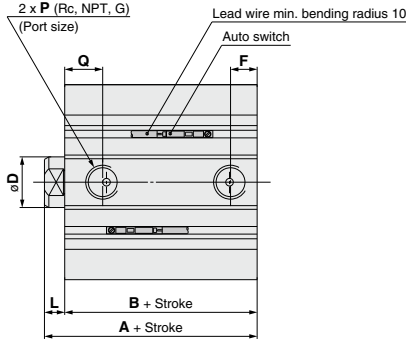
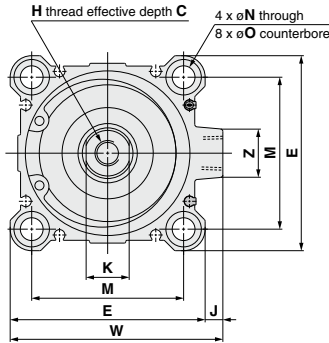

With boss on head end

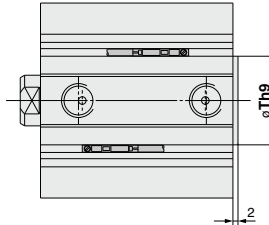

With Boss on Head End (mm)

Bore size (mm)	Th9
63	35 ⁰ _{0.062}
80	43 ⁰ _{0.062}
100	59 ⁰ _{0.074}

Male rod end

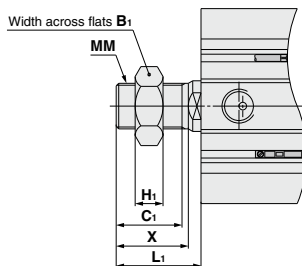

Male Rod End

Bore size (mm)	B1	C1	H1	L1	MM	X
63	27	26	11	33.5	M18 x 1.5	28.5
80	32	32.5	13	43.5	M22 x 1.5	35.5
100	41	32.5	16	43.5	M26 x 1.5	35.5

Bore size (mm)	Stroke range (mm)	Without auto switch		With auto switch		C	D	E	F	H	J	K	L	M	N	O	P	Q	W	Z	
		A	B	A	B																
63	10 to 50	54	46	64	56	15	20	77	10.5	M10 x 1.5	7	17	8	60	9	14 depth	10.5	1/4	15	84	19
	75, 100	64	56																		
80	10 to 50	63.5	53.5	73.5	63.5	21	25	98	12.5	M16 x 2.0	6	22	10	77	11	17.5 depth	13.5	3/8	16	104	25
	75, 100	73.5	63.5																		
100	10 to 50	75	63	85	73	27	30	117	13	M20 x 2.5	6.5	27	12	94	11	17.5 depth	13.5	3/8	23	123.5	25
	75, 100	85	73																		

REA

REB

REC

Smooth

Low Speed

MQ

RHC

RZQ

D-□

-X□

CQ2Y Series

Bore Size

Ø63 to Ø100

(Types with auto switch and without auto switch only differ in the A and B dimensions. Refer to the table below.)

Foot: CQ2YL/CDQ2YL

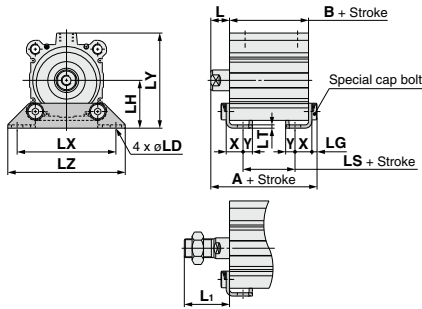

Foot

Bore size (mm)	Stroke range (mm)	Without auto switch			With auto switch			L	L ₁	LD
		A	B	LS	A	B	LS			
63	10 to 50	72.2	46	20	82.2	56	30	18	43.5	11
	75, 100	82.2	56	30						
80	10 to 50	85	53.5	23.5	95	63.5	33.5	20	53.5	13
	75, 100	95	63.5	33.5						
100	10 to 50	98	63	29	108	73	39	22	53.5	13
	75, 100	108	73	39						

Bore size (mm)	Stroke range (mm)	LG	LH	LT	LX	LY	LZ	X	Y
63	10 to 50	5	46	3.2	95	91.5	113	16.2	9
	75, 100								
80	10 to 50	7	59	4.5	118	114	140	19.5	11
	75, 100								
100	10 to 50	7	71	6	137	136	162	23	12.5
	75, 100								

Foot bracket material: Carbon steel
Surface treatment: Nickel plating

Compact foot: CQ2YLC/CDQ2YLC

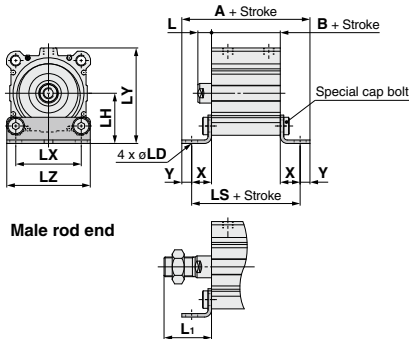

Male rod end

Compact Foot

Bore size (mm)	Stroke range (mm)	Without auto switch			With auto switch			L	L ₁	LD
		A	B	LS	A	B	LS			
63	10 to 50	100.4	46	82.4	110.4	56	92.4	18	43.5	11
	75, 100	110.4	56	92.4						
80	10 to 50	120.5	53.5	98.5	130.5	63.5	108.5	20	53.5	13
	75, 100	130.5	63.5	108.5						
100	10 to 50	136	63	111	146	73	121	22	53.5	13
	75, 100	146	73	121						

Bore size (mm)	Stroke range (mm)	LH	LT	LX	LY	LZ	X	Y
63	10 to 50	46	3.2	60	91.5	77	18.2	9
	75, 100							
80	10 to 50	59	4.5	77	114	98	22.5	11
	75, 100							
100	10 to 50	71	6	94	136	117	24	12.5
	75, 100							

Compact foot bracket material: Carbon steel
Surface treatment: Zinc chromated

Rod flange: CQ2YF/CDQ2YF

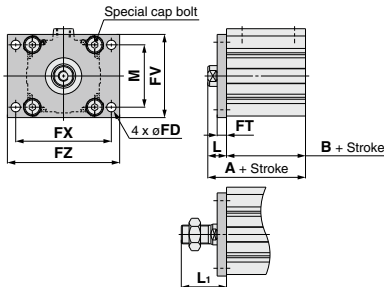

Rod Flange

Bore size (mm)	Stroke range (mm)	Without auto switch		With auto switch		FD	FT	FV	FX	FZ
		A	B	A	B					
63	10 to 50	64	46	74	56	9	9	80	92	108
	75, 100	74	56							
80	10 to 50	73.5	53.5	83.5	63.5	11	11	99	116	134
	75, 100	83.5	63.5							
100	10 to 50	85	63	95	73	11	11	117	136	154
	75, 100	95	73							

Bore size (mm)	Stroke range (mm)	L	L ₁	M
63	10 to 50	18	43.5	60
	75, 100			
80	10 to 50	20	53.5	77
	75, 100			
100	10 to 50	22	53.5	94
	75, 100			

Flange bracket material: Carbon steel
Surface treatment: Nickel plating

* For details about the rod end nut and accessory brackets, refer to page 244.

Bore Size

∅63 to ∅100

(Types with auto switch and without auto switch only differ in the A and B dimensions. Refer to the table below.)

Head flange: CQ2YG/CDQ2YG

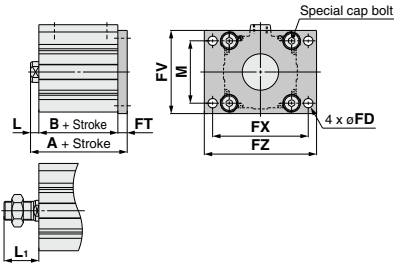

Head Flange

Bore size (mm)	Stroke range (mm)	Without auto switch		With auto switch		L	L ₁
		A	B	A	B		
63	10 to 50	63		73		8	33.5
	75, 100						
	10 to 50	74.5		84.5		10	43.5
80	10 to 50	86		96		12	43.5
	75, 100						
	10 to 50	96					

Flange bracket material: Carbon steel

Surface treatment: Nickel plating

(∗ Dimensions except A, L and L₁ are the same as rod flange type.)

Double clevis: CQ2YD/CDQ2YD

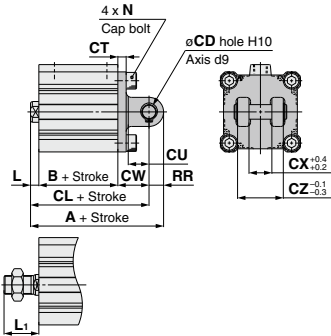

Double Clevis

Bore size (mm)	Stroke range (mm)	Without auto switch			With auto switch			CD	CT	CU
		A	B	CL	A	B	CL			
63	10 to 50	98	46	84	108	56	94	14	8	20
	75, 100	108	56	94						
	10 to 50	119.5	53.5	101.5	129.5	63.5	111.5	18	10	27
80	10 to 50	129.5	63.5	111.5						
	75, 100									
	10 to 50	142	63	120	152	73	130	22	13	31
100	75, 100	152	73	130						

Bore size (mm)	Stroke range (mm)	CW	CX	CZ	L	L ₁	N	RR
63	10 to 50	30	22	44	8	33.5	M10 x 1.5	14
	75, 100							
80	10 to 50	38	28	56	10	43.5	M12 x 1.75	18
	75, 100							
100	10 to 50	45	32	64	12	43.5	M12 x 1.75	22
	75, 100							

Double clevis bracket material: Cast iron

Surface treatment: Painted

∗ For details about the rod end nut and accessory brackets, refer to page 244.

∗ A double clevis pin and retaining rings are included.

REA

REB

REC

Smooth

Low Speed

MQ

RHC

RZQ

D-□

-X□

CQ2Y Series

Dimensions of Accessories

Single Knuckle Joint

For I-G012, I-Z015A
I-G02, I-G03

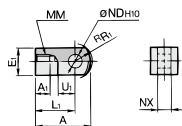

Material: Carbon steel
Surface treatment: Nickel plating

For I-G04, I-G05
I-G08, I-G10

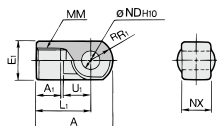

Material: Cast iron
Surface treatment: Nickel plating
(mm)

Part no.	Applicable bore size (mm)	A	A ₁	E ₁	L ₁	MM	^h R ₁	U ₁	ND _{H10}	NX
I-G04	32, 40	42	14	∅22	30	M14 x 1.5	12	14	10 ^{+0.058} ₀	18 ^{+0.3} ₀
I-G05	50, 63	56	18	∅28	40	M18 x 1.5	16	20	14 ^{+0.070} ₀	22 ^{+0.3} ₀
I-G08	80	71	21	∅38	50	M22 x 1.5	21	27	18 ^{+0.070} ₀	28 ^{+0.3} ₀
I-G10	100	79	21	∅44	55	M26 x 1.5	24	31	22 ^{+0.084} ₀	32 ^{+0.3} ₀

Double Knuckle Joint

For Y-G012, Y-Z015A
Y-G02, Y-G03

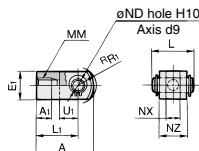

Material: Carbon steel
Surface treatment: Nickel plating

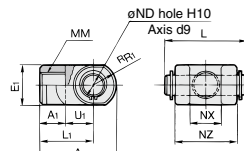

Material: Cast iron
Surface treatment: Nickel plating
(mm)

Part no.	Applicable bore size (mm)	A	A ₁	E ₁	L ₁	MM	^h R ₁	U ₁	ND _{H10}	NX	NZ	L	Applicable pin part no.
Y-G04	32, 40	42	16	∅22	30	M14 x 1.5	12	14	10 ^{+0.058} ₀	18 ^{+0.3} ₀	36	41.5	IY-G04
Y-G05	50, 63	56	20	∅28	40	M18 x 1.5	16	20	14 ^{+0.070} ₀	22 ^{+0.3} ₀	44	50.5	IY-G05
Y-G08	80	71	23	∅38	50	M22 x 1.5	21	27	18 ^{+0.070} ₀	28 ^{+0.3} ₀	56	64	IY-G08
Y-G10	100	79	24	∅44	55	M26 x 1.5	24	31	22 ^{+0.084} ₀	32 ^{+0.3} ₀	64	72	IY-G10

* A knuckle pin and retaining rings are included.

Knuckle Pin (Common with double clevis pin)

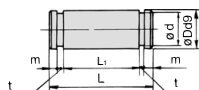

Material: Carbon steel
(mm)

Part no.	Applicable bore size (mm)	Dd9	L	d	L ₁	m	t	Applicable retaining ring
IY-G04	32, 40	10 ^{+0.040} _{-0.016}	41.6	9.6	36.2	1.55	1.15	Type C 10 for axis
IY-G05	50, 63	14 ^{+0.050} _{-0.023}	50.6	13.4	44.2	2.05	1.15	Type C 14 for axis
IY-G08	80	18 ^{+0.050} _{-0.023}	64	17	56.2	2.55	1.35	Type C 18 for axis
IY-G10	100	22 ^{+0.070} _{-0.027}	72	21	64.2	2.55	1.35	Type C 22 for axis

* Type C retaining rings for axis are included.

Mounting Brackets, Rod End Brackets, and Nut Material: Stainless Steel

Part No. (Dimensions: Same as standard type)

Bore size (mm)	Single knuckle joint	Double knuckle joint*	Rod end nut
32	I-G04SUS	Y-G04SUS	NT-G04SUS
40			
50	I-G05SUS	Y-G05SUS	NT-05SUS
63			
80	I-G08SUS	Y-G08SUS	NT-08SUS
100			

* A knuckle pin and retaining rings are shipped together. Refer to the XC27 for details on stainless steel double clevis pins and double knuckle pins. The accessories need to be ordered separately from the cylinder.

Rod End Nut

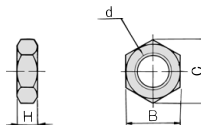

Material: Carbon steel
Surface material: Nickel plating
(mm)

Part no.	Applicable bore size (mm)	d	H	B	C
NT-04	32, 40	M14 x 1.5	8	22	25.4
NT-05	50, 63	M18 x 1.5	11	27	31.2
NT-08	80	M22 x 1.5	13	32	37.0
NT-10	100	M26 x 1.5	16	41	47.3

Simple Joint: $\phi 32$ to $\phi 100$

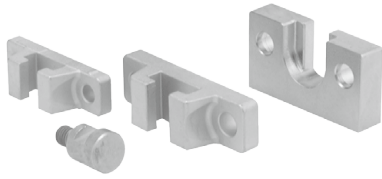

Joint and Mounting Bracket (Type A, Type B) Part No.

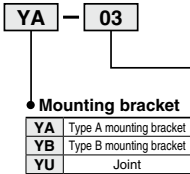

• Applicable air cylinder bore

03	For $\phi 32, \phi 40$
05	For $\phi 50, \phi 63$
08	For $\phi 80$
10	For $\phi 100$

Allowable Eccentricity (mm)

Bore size	$\phi 32$	$\phi 40$	$\phi 50$	$\phi 63$	$\phi 80$	$\phi 100$
Eccentricity tolerance	± 1			± 1.5		± 2
Backlash	0.5					

- <Ordering>
 • Joints are not included with the A or B type mounting brackets. Order them separately.
 (Example)
 Bore size $\phi 40$ Part no.YA-03
 • Type A mounting bracket part no.YA-03
 • Joint.....YU-03

Joint and Mounting Bracket (Type A, Type B) Part No.

Bore size (mm)	Joint part no.	Applicable mounting bracket	
		Type A mounting bracket	Type B mounting bracket
32, 40	YU-03	YA-03	YB-03
50, 63	YU-05	YA-05	YB-05
80	YU-08	YA-08	YB-08
100	YU-10	YA-10	YB-10

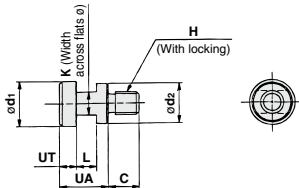

Material: Chromium molybdenum steel (Nickel plating)

Part no.	Applicable bore size (mm)	UA	C	d ₁	d ₂	H	K	L	UT	Weight (g)
YU-03	32, 40	17	11	15.8	14	M8 x 1.25	8	7	6	25
YU-05	50, 63	17	13	19.8	18	M10 x 1.5	10	7	6	40
YU-08	80	22	20	24.8	23	M16 x 2	13	9	8	90
YU-10	100	26	26	29.8	28	M20 x 2.5	14	11	10	160

Type A Mounting Bracket

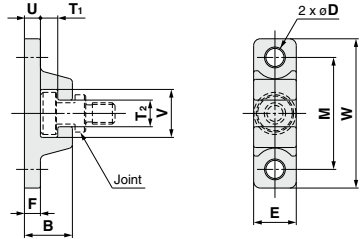

Material: Chromium molybdenum steel (Nickel plating) (mm)

Part no.	Bore size (mm)	B	D	E	F	M	T ₁	T ₂
YA-03	32, 40	18	6.8	16	6	42	6.5	10
YA-05	50, 63	20	9	20	8	50	6.5	12
YA-08	80	26	11	25	10	62	8.5	16
YA-10	100	31	14	30	12	76	10.5	18

Part no.	Bore size (mm)	U	V	W	Weight (g)
YA-03	32, 40	6	18	56	55
YA-05	50, 63	8	22	67	100
YA-08	80	10	28	83	195
YA-10	100	12	36	100	340

Type B Mounting Bracket

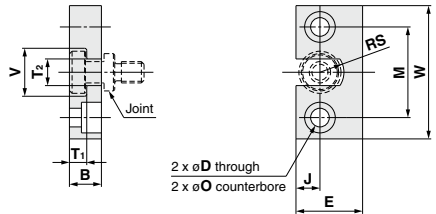

Material: Stainless steel (mm)

Part no.	Bore size (mm)	B	D	E	J	M	øO
YB-03	32, 40	12	7	25	9	34	11.5 depth 7.5
YB-05	50, 63	12	9	32	11	42	14.5 depth 8.5
YB-08	80	16	11	38	13	52	18 depth 12
YB-10	100	19	14	50	17	62	21 depth 14

Part no.	Bore size (mm)	T ₁	T ₂	V	W	RS	Weight (g)
YB-03	32, 40	6.5	10	18	50	9	80
YB-05	50, 63	6.5	12	22	60	11	120
YB-08	80	8.5	16	28	75	14	230
YB-10	100	10.5	18	36	90	18	455

REA
 REB
 REC
 Smooth
 Low Speed
 MQ
 RHC
 RZQ

D-□
 -X□

CQ2Y Series Auto Switch Mounting

Auto Switch Proper Mounting Position (Detection at stroke end) and Its Mounting Height

D-M9□
D-M9□W
D-M9□A
D-A9□V
D-M9□V
D-M9□WV
D-M9□AV
D-A9□

ø32 to ø100

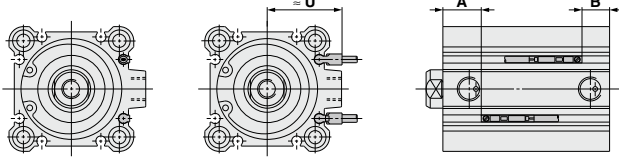

D-A7□
D-A80
D-A7□H
D-A80H
D-F7□
D-J79
D-F7□W
D-J79W
D-F79F

D-F7NT
D-A73C
D-A80C
D-J79C
D-A79W
D-F7□WV
D-F7□V

ø32 to ø100

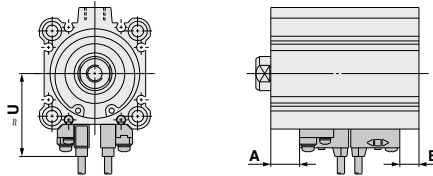

D-P3DWA

ø32 to ø100

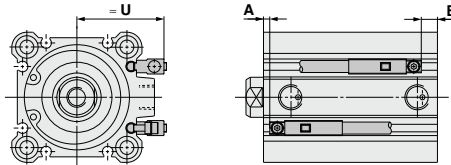

Auto Switch Proper Mounting Position

(mm)

Auto switch model	D-M9□/D-M9□V		D-A9□ D-A9□V		D-A73 D-A80		D-A72/A7□H/A80H D-A73C/A80C/F7□ D-F79F/J79/F7□V D-J79C/F7□W D-J79W/F7□WV		D-F7NT		D-A79W		D-P3DWA	
	A	B	A	B	A	B	A	B	A	B	A	B	A	B
Bore size														
32	18	13	14	9	15	10	15.5	10.5	20.5	15.5	12.5	7.5	13.5	8.5
40	21.5	16	17.5	12	18.5	13	19	13.5	24	18.5	16	10.5	17	11.5
50	19	19.5	15	15.5	16	16.5	16.5	17	21.5	22	13.5	14	14.5	15
63	21.5	22.5	17.5	18.5	18.5	19.5	19	20	24	25	16	17	17	18
80	24.5	27	20.5	23	21.5	24	22	24.5	27	29.5	19	21.5	20	22.5
100	27.5	33.5	23.5	29.5	24.5	30.5	25	31	30	36	22	28	23	29

Note) Adjust the auto switch after confirming the operating condition in the actual setting.

Auto Switch Mounting Height

(mm)

Auto switch model	D-M9□V	D-A9□V	D-F7□/J79 D-F7□W/J79W D-F7BA D-F79F/F7NT D-A7□H/A80H	D-F7□V D-F7□WV	D-J79C	D-A7□ D-A80	D-A73C D-A80C	D-A79W	D-P3DWA
	U	U	U	U	U	U	U	U	U
Bore size									
32	30	27.5	36	36.5	39.5	34	40.5	37.5	35.5
40	32	30	38	40	42.5	37.5	43.5	40.5	38
50	37.5	35	43.5	45	48	43	49	46	43
63	42.5	40.5	48.5	50.5	53.5	48	54.5	51.5	48
80	51	49	57	59	61.5	56.5	62.5	59.5	56.5
100	59	57	65.5	67	70	64.5	71	68	65

Minimum Stroke for Auto Switch Mounting

Number of auto switches	(mm)									
	D-M9□V D-F7□V D-J79C	D-A9□V D-A7□ D-A80 D-A73C D-A80C	D-A9□	D-M9□WV D-M9□AV D-F7□WV	D-M9□ D-F7□ D-J79	D-M9□W D-M9□A	D-A7□H D-A80H	D-A79W	D-F7□W D-J79W D-F79F D-F7NT	D-P3DWA
With 1 pc.	5	5	10 (5)	10	15 (5)	15 (10)	15 (5)	15	20 (10)	15
With 2 pcs.	5	10	10	15	15 (5)	15	15 (10)	20	20 (15)	15

Note) The dimensions stated in () shows the minimum stroke for the auto switch mounting when the auto switch does not project from the end surface of the cylinder body and hinder the lead wire bending space. (Refer to the figure below.)
Order auto switches and auto switch mounting brackets separately.

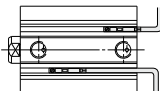

Operating Range

Auto switch model	(mm)					
	Bore size					
	32	40	50	63	80	100
D-M9□(V) D-M9□W(V) D-M9□A(V)	5	5	6	6.5	7	7.5
D-A9□(V)	9	9.5	9.5	11	10.5	10.5
D-A7□(H)(C) D-A80□(H)(C)	10.5	11.5	11	13	11.5	11.5
D-A79W	14	15.5	14.5	17	15	15.5
D-F7□(V) D-J79(C) D-F7□W(V) D-F7NT D-F79F	5	5	5	6	7	8
D-P3DWA	6	6	7	7.5	7.5	7.5

* Values which include hysteresis are for guideline purposes only, they are not a guarantee (assuming approximately ±30% dispersion) and may change substantially depending on the ambient environment.

* The auto switch mounting bracket BQ2-012 is not used for ø32 or more with the D-M9□(V)/M9□W(V)/M9□A(V)/A9□(V) types. The above values indicate the operating range when mounted with the current auto switch installation groove.

REA

REB

REC

Smooth

Low Speed

MQ

RHC

RZQ

D-□

-X□

Auto Switch Mounting Brackets/Part No.

Applicable Cylinder Series: CDQ2

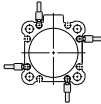
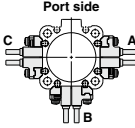
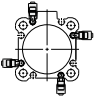
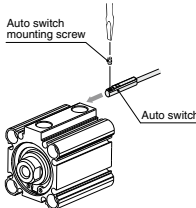
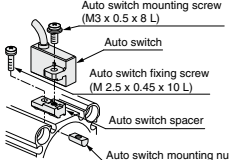
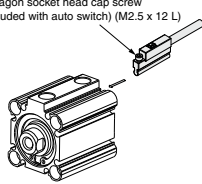
Applicable auto switch	D-M9□/M9□V D-M9□W/M9□WV D-M9□A/M9□AV D-A9□/A9□V	D-F7□/F7□V/J79/J79C/F7□W J79W/F7□WV/D-F7BA/F7BAV F79F/F7NT/D-A7□/A80/A7□H A80H/A73C/A80C/A79W	D-P3DWA										
Bore size (mm)	ø32 to ø100												
Auto switch mounting bracket part no.	—	BQ5-032	—										
Auto switch mounting bracket fitting parts lineup/Weight	—	<ul style="list-style-type: none"> • Auto switch fixing screw (M2.5 x 10 L) • Auto switch mounting screw (M3 x 8 L) • Auto switch spacer • Auto switch mounting nut Weight: 3.5 g When requesting the enclosure of the auto switch mounting brackets (2 pcs.) with the cylinder for shipment, add "BQ" to the end of the cylinder model number. Standard model no. + BQ Example) CDQ2B32-30DZ- BQ	—										
Auto switch mounting surface	Surfaces with auto switch mounting slot 	A/B/C side except port side 	Surfaces with auto switch mounting slot 										
Mounting of auto switch	 <ul style="list-style-type: none"> • When tightening the auto switch mounting screw, use a watchmakers' screwdriver with a handle 5 to 6 mm in diameter. <p>Tightening torque for auto switch mounting screw (N·m)</p> <table border="1"> <thead> <tr> <th>Auto switch model</th> <th>Tightening torque</th> </tr> </thead> <tbody> <tr> <td>D-M9□(V)</td> <td rowspan="3">0.05 to 0.15</td> </tr> <tr> <td>D-M9□W(V)</td> </tr> <tr> <td>D-A93</td> </tr> <tr> <td>D-M9□A(V)</td> <td>0.05 to 0.10</td> </tr> <tr> <td>D-A9□(V) (Excludes the D-A93)</td> <td>0.10 to 0.20</td> </tr> </tbody> </table>	Auto switch model	Tightening torque	D-M9□(V)	0.05 to 0.15	D-M9□W(V)	D-A93	D-M9□A(V)	0.05 to 0.10	D-A9□(V) (Excludes the D-A93)	0.10 to 0.20	<ol style="list-style-type: none"> ① Insert the nut into the auto switch mounting slot on the cylinder tube, and place it in the roughly estimated setting position. ② With the lower tapered part of the auto switch spacer facing the outside of the cylinder tube, line up the M2.5 through hole with the M2.5 female thread of the auto switch mounting nut. ③ Gently screw the auto switch mounting nut fixing screw (M2.5) into the thread of the auto switch mounting nut through the mounting hole. ④ Engage the ridge on the auto switch mounting arm with the recess in the auto switch spacer. ⑤ Tighten the auto switch mounting screw (M3) to fix the auto switch. The tightening torque of the M3 screw must be 0.35 to 0.45 N·m. ⑥ Confirm where the mounting position is, and tighten the auto switch fixing screw (M2.5) to fix the auto switch mounting nut. The tightening torque of the M2.5 screw must be 0.25 to 0.35 N·m. ⑦ The detection position can be changed under the conditions in step ⑤. 	<ol style="list-style-type: none"> ① Insert the mounting bracket into the mating groove of the cylinder tube. ② Check the detecting position of the auto switch and fix the auto switch firmly with the hexagon socket head cap screw (M2.5 x 12L)*. ③ If the detecting position is changed, go back to step ①. <p>Note 1) Ensure that the auto switch is covered with the mating groove to protect the auto switch.</p> <p>Note 2) The tightening torque for the hexagon socket head cap screw (M2.5 x 12L) is 0.2 to 0.3 N·m.</p> <p>Hexagon socket head cap screw (Included with auto switch) (M2.5 x 12 L)</p> 
Auto switch model	Tightening torque												
D-M9□(V)	0.05 to 0.15												
D-M9□W(V)													
D-A93													
D-M9□A(V)	0.05 to 0.10												
D-A9□(V) (Excludes the D-A93)	0.10 to 0.20												

Note) Auto switch mounting bracket and auto switch are enclosed with the cylinder for shipment.
 The auto switch mounting bracket for the D-F7BA(V) type uses the BQ5-032 with the normal specifications (iron screw).

Other than the applicable auto switches listed in "How to Order", the following auto switches are mountable.

Refer to pages 941 to 1067 for the detailed specifications.

Type	Model	Electrical entry	Features	Applicable bore size
Reed	D-A72	Grommet (Perpendicular)	—	ø32 to ø100
	D-A73		—	
	D-A80		Without indicator light	
	D-A79W		Diagnostic indication (2-color indicator)	
	D-A73C	Connector (Perpendicular)	—	
	D-A80C		Without indicator light	
	D-A72H	Grommet (In-line)	—	
	D-A73H/A76H		—	
	D-A80H		Without indicator light	
Solid state	D-F7NV/F7PV/F7BV	Grommet (Perpendicular)	—	
	D-F7NWV/F7BWV		Diagnostic indication (2-color indicator)	
	D-F7BAV	Water resistant (2-color indicator)		
	D-J79C	Connector (Perpendicular)	—	
	D-F79/F7P/J79	Grommet (In-line)	—	
	D-F79W/F7PW/J79W		Diagnostic indication (2-color indicator)	
	D-F7BA		Water resistant (2-color indicator)	
	D-F79F		With diagnostic output (2-color indicator)	
	D-F7NT		With timer	

* With pre-wired connector is also available for solid state auto switches. For details, refer to pages 1014 and 1015.

* Normally closed (NC = b contact) solid state auto switches (D-M9□E(V)) are also available. For details, refer to page 1592-1.

* Trimmer auto switch (D-F7K) and heat resistant solid state auto switch (D-F7NJ) are not available.

REA

REB

REC

Smooth

Low Speed

MQ

RHC

RZQ

D-□

-X□