

Series 10-ARP20 to 10-ARP40 Direct Operated Precision Regulator

Series 10-ARP20K to 10-ARP40K Direct Operated Precision Regulator with Backflow Function

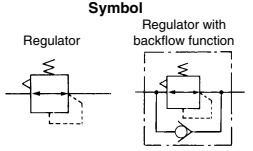

- Clean room compliant (10-ARP).
- Clean room compliant, copper-free, fluorine-free, silicone-free (21-ARP).
- With the backflow function it incorporates a mechanism to exhaust the air pressure in the outlet side reliably and quickly.

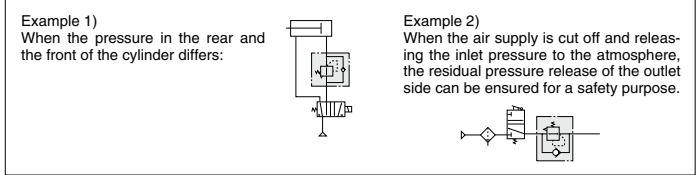

How to Order

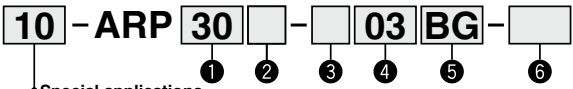

Special applications

10	Clean room compliant
21	Clean room compliant, copper-free, fluorine-free, silicone-free

• Option / Semi-standard: Select one each for a to f.
 • Option / Semi-standard symbol: Enter them alphanumerically.
 Example) 10-ARP30K-03BG-1RY

Clean room compliant	<ul style="list-style-type: none"> • Less particle generation in a clean room • Grease: Fluorine type • Packaging: Double packaging
Clean room compliant, copper-free, fluorine-free, silicone-free	<ul style="list-style-type: none"> • Less particle generation in a clean room • Wetted parts: Aluminum die-cast • Stainless steel, HNBR, NBR • Grease: Lithium soap based type

	Symbol	Description	①			①			
			Body size			Body size			
			20	30	40	20	30	40	
② With backflow function	Nil	Without backflow function	●	●	●	●	●	●	
	K	With backflow function	●	●	●	●	●	●	
③ Thread type	Nil	Rc	●	●	●	●	●	●	
	N	NPT	●	●	●	●	●	●	
	F	G	●	●	●	●	●	●	
④ Port size	01	1/8	●	—	—	●	—	—	
	02	1/4	—	●	●	—	●	●	
	03	3/8	—	●	●	—	●	●	
	04	1/2	—	—	●	—	—	●	
a Mounting	Nil	Without mounting option	●	●	●	●	●	●	
	B <small>Note 2)</small>	With bracket	●	●	●	●	●	●	
	H	With set nut (For panel mount)	●	●	●	●	●	●	
⑤ <small>Note 1)</small> Option	Pressure gauge	Nil	Without pressure gauge	●	●	●	●	●	●
		G	Round type pressure gauge (Without limit indicator)	●	●	●	●	●	●
	Digital pressure switch	E1 <small>Note 3)</small>	Output: NPN output / Electrical entry: Wiring bottom entry	●	●	●	—	—	—
		E2 <small>Note 3)</small>	Output: NPN output / Electrical entry: Wiring top entry	●	●	●	—	—	—
		E3 <small>Note 3)</small>	Output: PNP output / Electrical entry: Wiring bottom entry	●	●	●	—	—	—
E4 <small>Note 3)</small>	Output: PNP output / Electrical entry: Wiring top entry	●	●	●	—	—	—		



Direct Operated Precision Regulator Series ¹⁰⁻₂₁₋ARP20 to ¹⁰⁻₂₁₋ARP40
Direct Operated Precision Regulator with Backflow Function Series ¹⁰⁻₂₁₋ARP20K to ¹⁰⁻₂₁₋ARP40K



¹⁰⁻₂₁₋ARP20/ARP20K ¹⁰⁻₂₁₋ARP30/ARP30K ¹⁰⁻₂₁₋ARP40/ARP40K

Directional Control Valves
Air Cylinders
Rotary Actuators
Air Grippers
Air Preparation Equipment
Modular F. R.
Pressure Control Equipment
Fittings & Tubing
Flow Control Equipment
Pressure Switches/ Pressure Sensors

	Symbol	Description	①			①			
			Body size			Body size			
			20	30	40	20	30	40	
⑥ Semi-standard	c	Set pressure	Nil	●	●	●	●	●	●
			1 ^{Note 4)}	●	●	●	●	●	●
			3 ^{Note 4)}	●	●	●	●	●	●
		+							
	d	Flow direction	Nil	●	●	●	●	●	●
			R	●	●	●	●	●	●
		+							
	e	Knob	Nil	●	●	●	●	●	●
			Y	●	●	●	●	●	●
		+							
	f	Pressure unit	Nil	●	●	●	●	●	●
			Z ^{Note 5)}	○ ^{Note 7)}	○ ^{Note 7)}	○ ^{Note 7)}	○ ^{Note 7)}	○ ^{Note 7)}	○ ^{Note 7)}
ZA ^{Note 6)}			△ ^{Note 8)}	△ ^{Note 8)}	△ ^{Note 8)}	—	—	—	

Note 1) Options B, G, H are shipped together, (but not assembled).
 Note 2) Set nut is included for bracket.
 Note 3) When choosing with H (panel mount), the installation space for lead wires will not be secured. In this case, select "wiring top entry" for the lead wire entry. (Select "wiring bottom entry" when the semi-standard Y is chosen simultaneously.)
 Note 4) The only difference from the standard specifications is the pressure regulator spring.
 It does not restrict the setting of 0.2 MPa/0.6 MPa or more.
 When the pressure gauge is attached, a 0.2 MPa pressure gauge for 0.2 MPa setting will be fitted, and a 0.7 MPa pressure gauge for 0.6 MPa setting will be fitted.

Note 5) For thread type: NPT. This product is for overseas use only according to the new Measurement Law. (The SI unit type is provided for use in Japan.) The digital pressure switch will be equipped with the unit conversion function, setting to psi initially.
 Note 6) For options: E1, E2, E3, E4. This product is for overseas use only according to the new Measurement Law. (The SI unit is provided for use in Japan.)
 Note 7) ○ : For thread type, NPT only.
 Note 8) △ : Combination available for options : E1, E2, E3, E4.

Direct Operated Precision Regulator Series 10-~~21~~-ARP20 to 10-~~21~~-ARP40

Direct Operated Precision Regulator with Backflow Function Series 10-~~21~~-ARP20K to 10-~~21~~-ARP40K

Specifications

Model			10-ARP20 (K)	10-ARP30 (K)	10-ARP40 (K)
Port size			1/8, 1/4	1/4, 3/8	1/4, 3/8, 1/2
Fluid			Air		
Proof pressure			1.2 MPa		
Maximum operating pressure			0.7 MPa		
Set pressure range ^{Note 1)}	0.4 MPa setting	(Ex.)10-ARP30-02BG	0.005 to 0.4 MPa		
	0.2 MPa setting	(Ex.)10-ARP30-02BG-1	0.005 to 0.2 MPa		
	0.6 MPa setting	(Ex.)10-ARP30-02BG-3	0.008 to 0.6 MPa		
Setting sensitivity			Within 0.2% F.S.		
Repeatability ^{Note 2)}			Within ±1% F.S. (or ±3 kPa)		
Air consumption	0.4 MPa setting	(Ex.)10-ARP30-02BG	1 L/min [ANR] or less (at P2 = 0.4 MPa)		
	0.2 MPa setting	(Ex.)10-ARP30-02BG-1	0.6 L/min [ANR] or less (at P2 = 0.2 MPa)		
	0.6 MPa setting	(Ex.)10-ARP30-02BG-3	1.4 L/min [ANR] or less (at P2 = 0.6 MPa)		
Pressure gauge port size			1/8	1/8	1/4
Ambient and fluid temperature			-5 to 60°C (No freezing)		
	With a digital pressure switch	(Ex.)10-ARP30-02BE1	-5 to 50°C (No freezing)		
Construction			Bleed type		
Weight (kg) ^{Note 3)}			0.2	0.3	0.5

Note 1) When a product with backflow function (10-ARP20K to 40K) is chosen, set the inlet pressure 0.05 MPa or higher than the set pressure.

Note 2) For the type set to 0.2 MPa only, repeatability will be within ±3 kPa.

Note 3) Mass shown is for product without any options.

Optional Parts

Clean Room Compliant (10-)

Model			10-ARP20(K)	10-ARP30(K)	10-ARP40(K)	
Bracket assembly ^{Note 1)}			ARP20P-270AS	ARP30P-270AS	ARP40P-270AS	
Set nut			ARP20P-260S	ARP30P-260S	ARP40P-260S	
Pressure gauge	0.4 MPa	Round type ^{Note 2)}	G49-4-□01		G49-4-□02	
	0.2 MPa		G49-2-□01		G49-2-□02	
	0.7 MPa		G49-7-□01		G49-7-□02	
	Digital type ^{Note 3)}	NPN output / Wiring bottom entry		ISE35-N-25-MLA [ISE35-N-25-M (Switch body only)]		
		NPN output / Wiring top entry		ISE35-R-25-MLA [ISE35-R-25-M (Switch body only)]		
		PNP output / Wiring bottom entry		ISE35-N-65-MLA [ISE35-N-65-M (Switch body only)]		
		PNP output / Wiring top entry		ISE35-R-65-MLA [ISE35-R-65-M (Switch body only)]		

Copper, Fluorine and Silicone-free + Low Particle Generation (21-)

Model			21-ARP20(K)	21-ARP30(K)	21-ARP40(K)
Bracket assembly ^{Note 1)}			ARP20P-270AS	ARP30P-270AS	ARP40P-270AS
Set nut			ARP20P-260S	ARP30P-260S	ARP40P-260S
Pressure gauge	0.4 MPa	Round type ^{Note 2)}	G49-4-□01MS-X3		G49-4-□02MS-X3
	0.2 MPa		G49-2-□01MS-X3		G49-2-□02MS-X3
	0.7 MPa		G49-7-□01MS-X3		G49-7-□02MS-X3

Note 1) Assembly includes a bracket and set nuts.

Note 2) □ in part numbers for a round-type pressure gauge indicates a type of connection thread. No indication is necessary for R; however, indicate N for NPT. The G thread is unavailable. If it is required, select the R thread type (Nil) instead. Please contact SMC regarding the pressure gauge supply for psi unit specifications.

Note 3) Lead wire with connector (2 m), adapter, lock pin, O-ring (1 pc.), and mounting screws (2 pcs.) are included. []: Switch body only.

For how to order the digital pressure switch, refer to the following specific page for the digital pressure switch.

Condition:
Inlet pressure 0.7 MPa

Conditions: Inlet pressure 0.5 MPa Outlet pressure
0.2 MPa Flow rate 20 L/min (ANR)

Flow Rate Characteristics (Representative values)

Pressure Characteristics (Representative values)

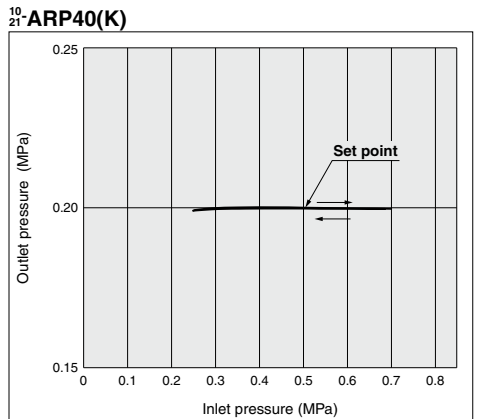
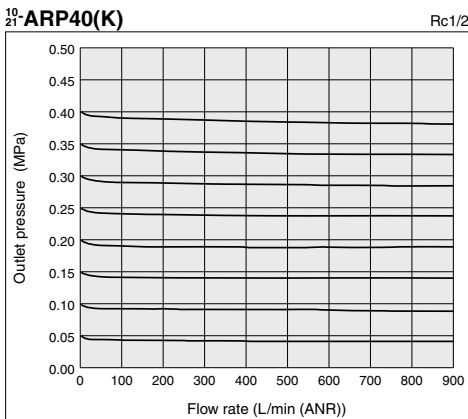
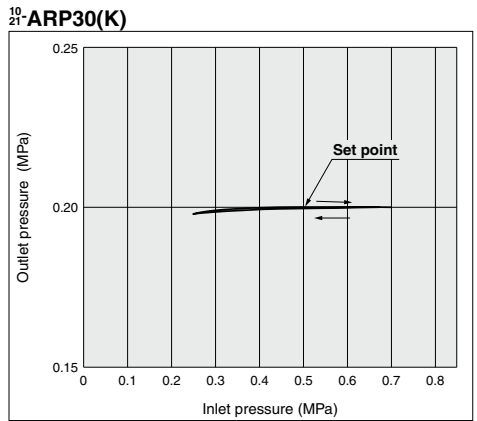
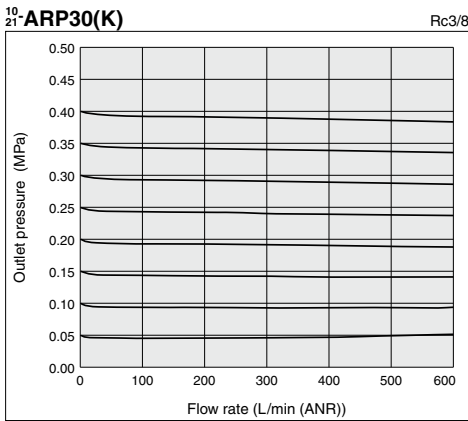
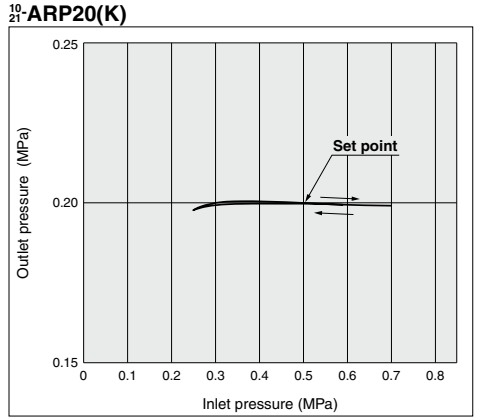
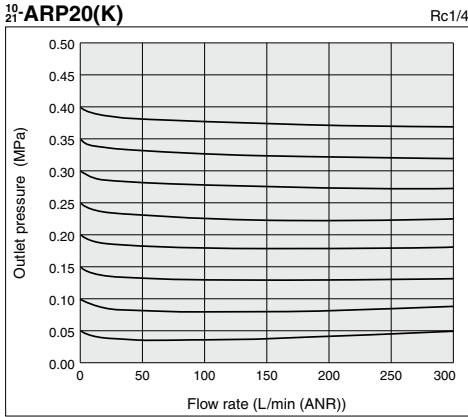

- Directional Control Valves
- Air Cylinders
- Rotary Actuators
- Air Grippers
- Air Preparation Equipment
- Modular F. R.
- Pressure Control Equipment
- Fittings & Tubing
- Flow Control Equipment
- Pressure Switches/ Pressure Sensors

Dimensions

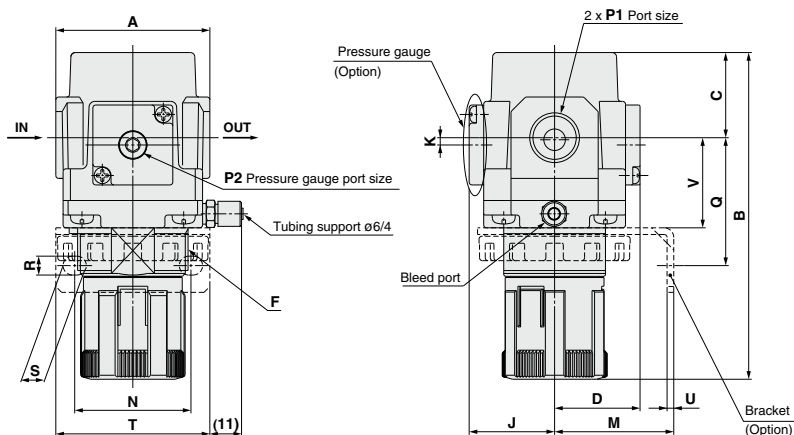

Panel fitting dimension

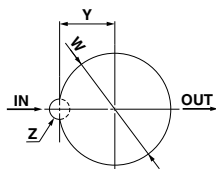

Plate thickness
 10-21-ARP20(K), ARP30(K) : Max. 3.5
 10-21-ARP40(K) : Max. 5

Pressure Gauge Option

Option	Digital pressure switch (Electrical entry: Wiring bottom entry)	Digital pressure switch (Electrical entry: Wiring top entry)	Round type pressure gauge
Dimensions			

Model	Standard specifications									
	P1	P2	A	B ^{Note 1)}	C	D	F	J	K	
10-21-ARP20(K)	1/8, 1/4	1/8	40	98	27	28.5	M28 x 1	28.5	2 ^{Note 2)}	
10-21-ARP30(K)	1/4, 3/8	1/8	53	117	29	29.5	M38 x 1.5	29.5	2.5	
10-21-ARP40(K)	1/4, 3/8, 1/2	1/4	70	148	41	34	M42 x 1.5	34	1	

Model	Optional specifications														
	Digital pressure switch		Round type pressure gauge ^{Note 3)}		Bracket mount dimension						Panel mount				
	H	J	H	J	M	N	Q	R	S	T	U	V	W	Y	Z
10-21-ARP20(K)	□27.8	40	ø44	69	30	34	47	5.4	15.4	55	2.3	28	28.5	14	6
10-21-ARP30(K)	□27.8	41	ø44	70	41	40	44	6.5	8	53	2.3	31	38.5	19	7
10-21-ARP40(K)	□27.8	45	ø44	74	50	54	54	8.5	10.5	70	2.3	35.5	42.5	21	7

Note 1) The total length of B direction is the length when the filter regulator knob is unlocked.
 Note 2) For 10-21-ARP20(K) only, the position of pressure gauge is above the center of the piping.
 Note 3) For dimensions of round-type pressure gauge for special application, please contact SMC.

Options Digital Pressure Switch



RoHS

ISE35-**N**-**25**-**M****L****A**

① ② ③ ④ ⑤

	Symbol	Description
① Electrical entry	N	Wiring bottom entry
	R	Wiring top entry
② Output	25	NPN output
	65	PNP output
③ Unit	Nil	With unit conversion function
	M	Fixed SI unit
	P	Pressure unit: psi (Initial value), with unit conversion function
④ Lead wire	Nil	Without lead wire
	L	Lead wire with connector (2 m)
⑤ Accessories	Nil	Without accessories (Switch body only)
	A	With accessories (Adapter, O-ring: 1 pc., Mounting screw: 2 pcs., Lock pin)

Digital Pressure Switch Construction

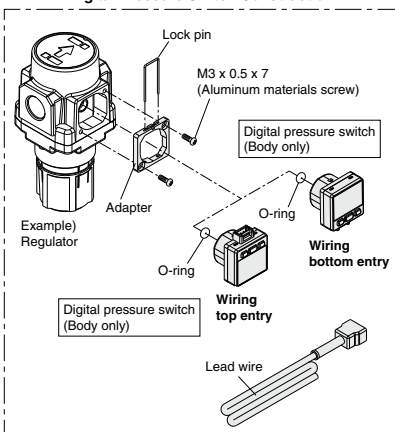

Note 1) Under the New Measurement Law, sales of switches with the unit switching function have not been allowed for use in Japan.
 Note 2) Unit name plate is attached.
 Note 3) Operation manual is included.
 Note 4) When ordering the body only, select the symbol from ① to ② respectively.

Specifications

Rated pressure range	0 to 1 MPa
Set pressure range	-0.1 to 1 MPa
Withstand pressure	1.5 MPa
Set pressure resolution	0.01 MPa
Power supply voltage	12 to 24 VDC, Ripple (p-p) 10% or less (with power supply polarity protection)
Current consumption	55 mA or less (at no load)
Switch output	NPN or PNP open collector 1 output
Maximum load current	80 mA
Maximum applied voltage	30 V (at NPN output)
Residual voltage	1 V or less (with load current of 80 mA)
Response time	1 s
Anti-chattering function	(0.25, 0.5, 2, 3)
Short-circuit protection	Yes
Repeatability	±1% F.S. or less
Hysteresis	Hysteresis mode Window comparator mode
	Variable (0 or above)
Display	3-digit, 7-segment indicator, 2-color display (Red/Green) can be interlocked with the switch output.
Display accuracy	±2% F.S. ±1 digit (25°C ±3°C)
Indicator light	Light up when output is turned ON. (Green)
Environment resistance	Enclosure IP40
Lead wire with connector	ø3.4 3-wire 25AWG 2 m

Output Specifications

NPN open collector output

Max. 30 V, 80 mA
Residual voltage 1 V or less

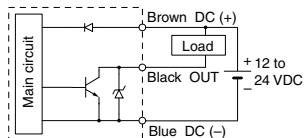

PNP open collector

Max. 80 mA
Residual voltage 1 V or less

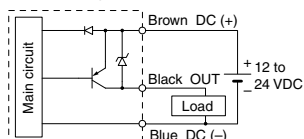

Directional Control Valves

Air Cylinders

Rotary Actuators

Air Grippers

Air Preparation Equipment

Modular F. R.

Pressure Control Equipment

Fittings & Tubing

Flow Control Equipment

Pressure Switches/Pressure Sensors



Series ¹⁰/₂₁ ARP20/30/40
Series ¹⁰/₂₁ ARP20K/30K/40K
Specific Product Precautions 1

Be sure to read this before handling. Refer to page 1382 for Safety Instructions.

Design

⚠ Warning

1. Be sure to install a safety device to prevent damage or malfunction of the outlet side components when the output pressure exceeds the set pressure value.
2. Please consult with SMC if the intended application calls for absolutely zero leakage due to special atmospheric requirements, or if the use of a fluid other than air is required.

⚠ Caution

1. Select a model that is suitable for the desired cleanliness by referring to the SMC's Best Pneumatics catalog.
2. Components cannot be used for applications that are outside the range of specifications.
Please consult with SMC when you anticipate using the component outside the range of its specifications (such as temperature and pressure).
3. Even when the product is used in the specified range, it may chatter depending on the operating conditions. Please contact SMC for the details of this chattering.

Selection

⚠ Warning

1. The mineral grease used on internal sliding parts and seals may run down to outlet side components.
Please consult with SMC if this is not desirable.
2. Residual pressure release (outlet pressure release) is not complete by releasing the inlet pressure.
To release residual pressure, select a model with a backflow function. Using a model without a backflow function makes for inconsistent residual pressure release (i.e., residual pressure may or may not be released) depending upon the operating conditions.
3. Please contact SMC if air will not be consumed in the system for a long period of time, or if the outlet side will be used with a sealed circuit and a balanced circuit, as this may cause the set pressure of the outlet side to fluctuate.
4. Set the regulating pressure range for the outlet pressure of the regulator in a range that is 90% or less of the inlet pressure.
If set to above 90%, the outlet pressure will be easily affected by fluctuations in the flow rate and inlet pressure, and become unstable.
5. A safety margin is calculated into the maximum regulating pressure range appearing in the catalog's specification table.
However, the outlet pressure may exceed the set pressure due to a delay in the valve's closing.
6. Please contact SMC when a circuit requires the use of a regulator having relief sensitivity with high precision and setting accuracy.

Mounting

⚠ Caution

1. To avoid reversed connections of the air inlet/outlet, make connections after confirming the "IN/OUT" mark or arrows that indicate the direction of air flow. Reversed connections can cause malfunction.
2. Leave a space of 100 mm or more for maintenance on the valve guide side (opposite side from the knob).
3. When the product is installed between a solenoid valve and an actuator, select a backflow function type.

Adjustment

⚠ Warning

1. Set the regulator while verifying the displayed values of the inlet and outlet pressure gauges.
Turning the knob excessively can cause damage to the internal parts.
2. Do not use a tool on the pressure regulator knob as this can cause damage. It must be operated manually.

⚠ Caution

1. Be sure to check the inlet pressure before setting the outlet pressure.
2. Be sure to unlock the knob before adjusting the pressure and lock it after setting the pressure.

Failure to follow this procedure can cause damage to the knob and the outlet pressure may fluctuate.

- Pull the pressure regulator knob to unlock. (You can visually verify this with the "orange mark" that appears in the gap.)
- Push the pressure regulator knob to lock. When the knob is not easily locked, turn it left and right a little and then push it (when the knob is locked, the "orange mark", i.e., the gap will disappear).

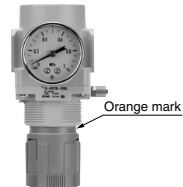

3. To set the pressure using the knob, turn the knob in the direction that increases pressure and lock the knob after the pressure is set.

If this is done in the direction that decreases pressure, the pressure may drop from the original set pressure. Turning the knob clockwise increases the outlet pressure, and turning it counterclockwise reduces the pressure.

4. Do not apply pressure exceeding the range of specifications.

It can damage the pressure gauge.



Series ¹⁰/₂₁ ARP20/30/40
 Series ¹⁰/₂₁ ARP20K/30K/40K
Specific Product Precautions 2

Be sure to read this before handling. Refer to page 1382 for Safety Instructions.

Adjustment

⚠ Caution

5. The product consumes a small amount of fluid from the bleed port.

The product is designed to have a bleed mechanism for highly accurate pressure adjustment, and consumes a small amount of fluid from the bleed port. This should not be considered abnormal.

Air Supply

⚠ Warning

1. Use a mist separator on the inlet side of the product.
If the supplied air contains condensate or dust, the bleed mechanism can malfunction.
2. Do not use a lubricator on the inlet side of the product, as the bleed mechanism can malfunction.

Piping

⚠ Warning

1. To screw piping materials into components, tighten with a recommended tightening torque while holding the female thread side.

If the minimum tightening torque is not observed, this can cause a looseness and seal failure. On the other hand, excess tightening torque can cause damage to the threads. Furthermore, tightening without holding the female thread side can cause damage due to the excess force that is applied directly to the piping bracket.

Recommended Tightening Torque [N·m]

Connection thread	1/8	1/4	3/8	1/2
Torque	7 to 9	12 to 14	22 to 24	28 to 30

2. Avoid excessive torsional moment or bending moment other than those caused by the equipment's own weight as this can cause damage.
Support external piping separately.
3. Piping materials without flexibility such as steel tube piping are prone to be affected by excess moment load and vibration from the piping side. Use flexible tubing in between to avoid such an effect.

Maintenance

⚠ Warning

1. When disassembly or installation is required during the maintenance, repair, or replacement of a device, be sure to follow the instructions provided in the operation manual or safety instructions in this catalog.
2. When using the regulator with backflow function between a solenoid valve and an actuator, check the pressure gauge periodically.

Sudden pressure fluctuations may shorten the durability of the pressure gauge. A digital pressure gauge is recommended for such situation or as deemed necessary.

⚠ Caution

1. For emergency action in the event of setting failure or leakage from the relief port, refer to "Troubleshooting" in the Operation Manual of the product.

Directional Control Valves

Air Cylinders

Rotary Actuators

Air Grippers

Air Preparation Equipment

Modular F. R.

Pressure Control Equipment

Fittings & Tubing

Flow Control Equipment

Pressure Switches/ Pressure Sensors