

## SEMIPACK® 4 Thyristor Modules

### SKET 330 SKET 400



SKET

#### Features

- Heat transfer through aluminium nitride ceramic isolated metal baseplate
- Precious metal pressure contacts for high reliability
- With amplifying gate
- UL recognized, file no. E 63 532

#### Typical Applications

- DC motor control (e. g. for machine tools)
- Temperature control (e. g. for ovens, chemical processes)
- Professional light dimming (studios, theaters)

$V_{RSM}$	$V_{RRM}$ $V_{DRM}$	$(dv/dt)_{cr}$	$I_{TRMS}$ (maximum values for continuous operation)	
			600 A	700 A
V	V	$V/\mu s$	$I_{TAV}$ (sin. 180; $T_{case} = \dots$ )	
			380 (68 °C)	440 A (78 °C)
900	800	500	<b>SKET 330/08 D</b>	<b>SKET 400/08 D</b>
1300	1200	1000	<b>SKET 330/12 E</b>	<b>SKET 400/12 E</b>
1500	1400	1000	<b>SKET 330/14 E</b>	<b>SKET 400/14 E</b>
1700	1600	1000	<b>SKET 330/16 E</b>	<b>SKET 400/16 E</b>
1900	1800	1000	<b>SKET 330/18 E</b>	<b>SKET 400/18 E</b>
2100	2000	1000	<b>SKET 330/20 E</b>	–
2300	2200	1000	<b>SKET 330/22 E</b>	–

Symbol	Conditions	SKET 330	SKET 400	Units
$I_{TAV}$	sin. 180; ( $T_{case} = \dots$ )	330 (78)	400 (84)	A °C
$I_D$	B2/B6 $T_{amb} = 35$ °C; P 16/300 F	530 / 665	700 / 880	A
$I_{RMS}$	W1/W3 $T_{amb} = 35$ °C; P 16/400 F	685 / 3 x 550	905 / 3 x 720	A
$I_{TSM}$	$T_{vj} = 25$ °C; 10 ms	9 000	14 000	A
	$T_{vj} = 130$ °C; 10 ms	8 000	12 000	A
$i^2t$	$T_{vj} = 25$ °C; 8,3 ... 10 ms	405 000	980 000	A <sup>2</sup> s
	$T_{vj} = 130$ °C; 8,3 ... 10 ms	320 000	720 000	A <sup>2</sup> s
$t_{gd}$	$T_{vj} = 25$ °C $I_G = 1$ A			$\mu s$
	$di_G/dt = 1$ A/ $\mu s$	1		$\mu s$
$t_{gr}$	$V_D = 0,67 \cdot V_{DRM}$	2		$\mu s$
$(di/dt)_{cr}$	$T_{vj} = 130$ °C		125	A/ $\mu s$
$t_q$	$T_{vj} = 130$ °C		typ. 150 ... 200	$\mu s$
$I_H$	$T_{vj} = 25$ °C		150 / 500	mA
$I_L$	$T_{vj} = 25$ °C; $R_G = 33$ $\Omega$ ; typ./max.		0,5 / 2	A
$V_T$	$T_{vj} = 25$ °C; ( $I_T = \dots$ ); max.	2,05 (1500)	1,7 (2400)	V A
$V_{T(TO)}$	$T_{vj} = 130$ °C	1,2	0,92	V
$r_T$	$T_{vj} = 130$ °C	0,55	0,3	m $\Omega$
$I_{DD}$ ; $I_{RD}$	$T_{vj} = 130$ °C; $V = V_{DRM} / V_{RRM}$	120	80	mA
$V_{GT}$	$T_{vj} = 25$ °C; d.c.		3	V
$I_{GT}$	$T_{vj} = 25$ °C; d.c.		200	mA
$V_{GD}$	$T_{vj} = 130$ °C; d.c.		0,25	V
$I_{GD}$	$T_{vj} = 130$ °C; d.c.		10	mA
$R_{thjc}$	cont.		0,09	°C/W
	sin. 180		0,095	°C/W
	rec. 120		0,11	°C/W
$R_{thch}$			0,02	°C/W
$T_{vj}$ ; $T_{stg}$			– 40 ... + 130	°C
$V_{isol}$	a. c. 50 Hz; r.m.s.; 1 s/1 min		3600 / 3000	V~
$M_1$	to heatsink to terminals } SI (US) units		5 (44 lb. in.) $\pm 15$ % <sup>1)</sup>	Nm
$M_2$			17 (150 lb. in.) $\pm 15$ % <sup>2)</sup>	Nm
a			5 · 9,81	m/s <sup>2</sup>
w	approx.		940	g
Case	→ page B 1 – 94		A 36	

1) See the assembly instructions

2) The screws must be lubricated

ET33001a

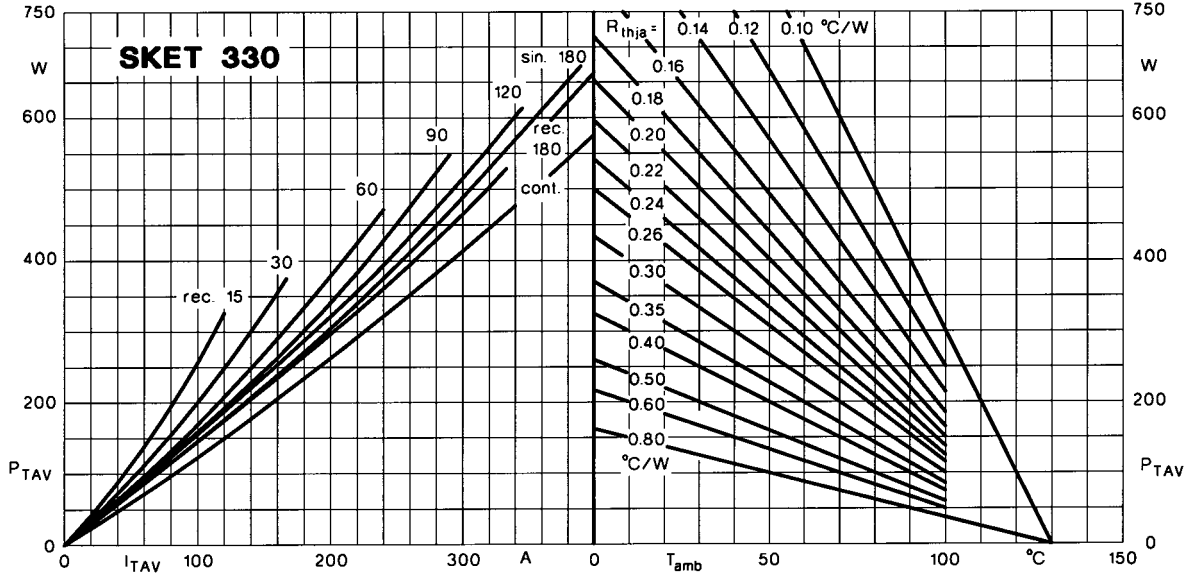

Fig. 1 a Power dissipation vs. on-state current and ambient temperature

ET40001b

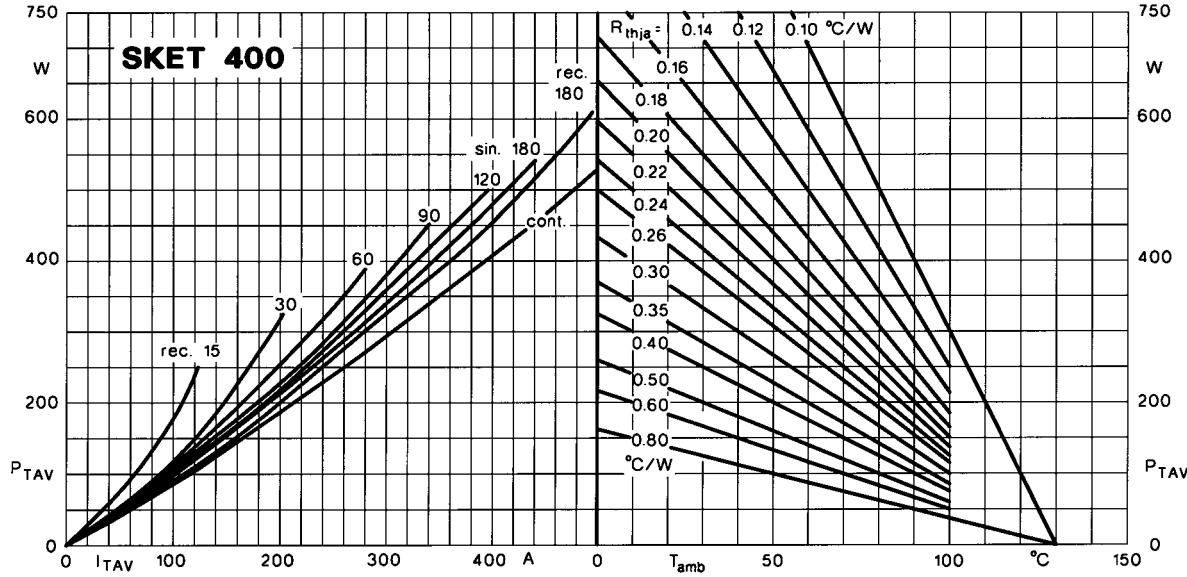

Fig. 1 b Power dissipation vs. on-state current and ambient temperature

ET40006

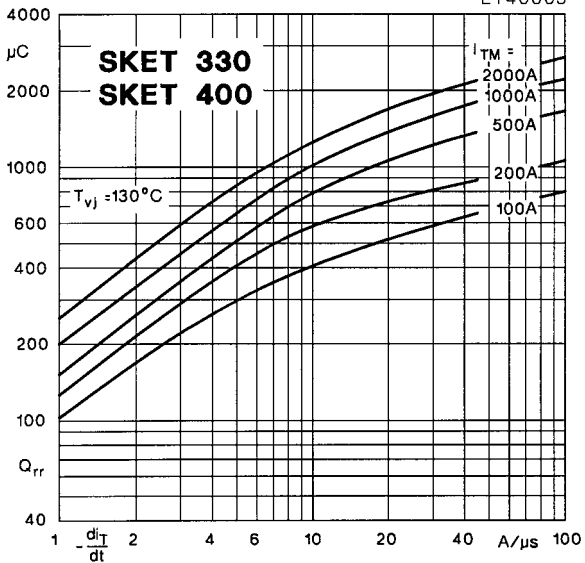

Fig. 5 Recovered charge vs. current decrease

ET40006

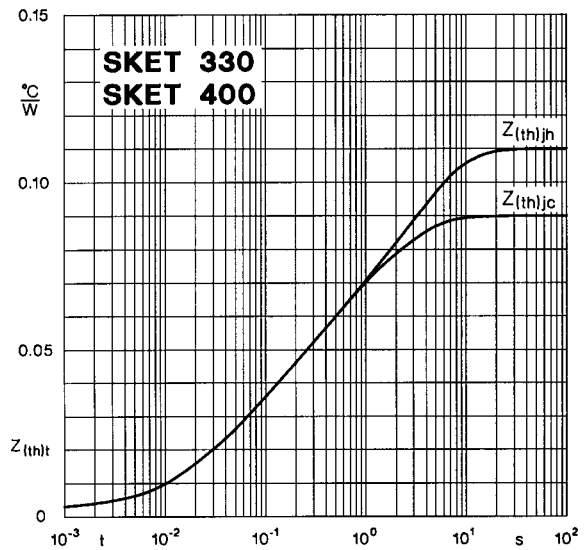

Fig. 6 Transient thermal impedance vs. time

ET40007

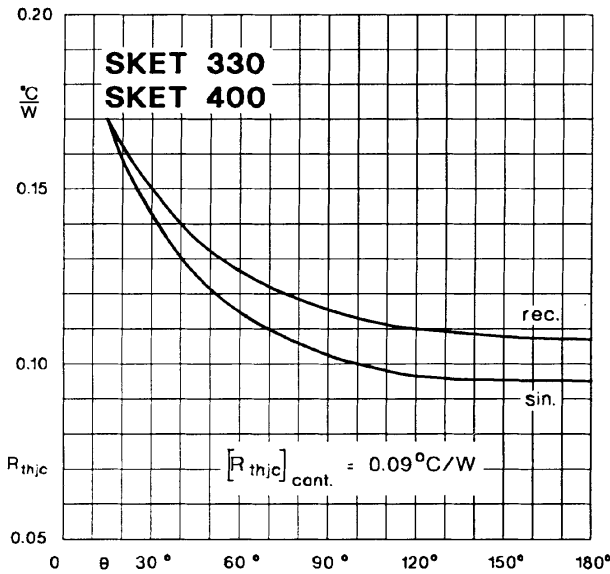

Fig. 7 Thermal resistance vs. conduction angle

ET33008a

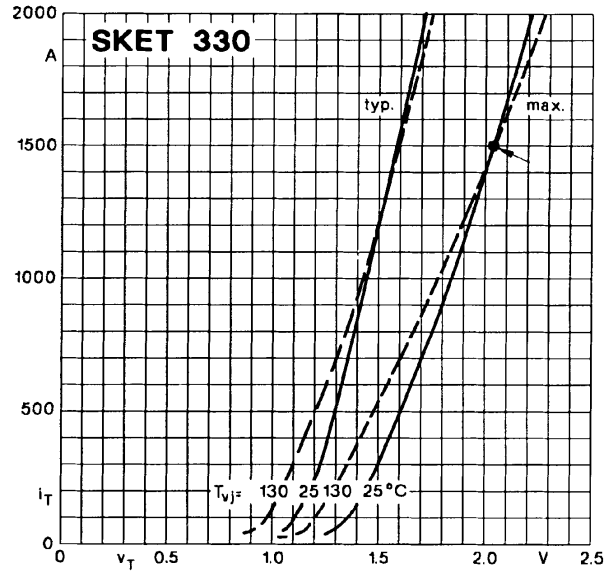

Fig. 8 a On-state characteristics

ET40008b

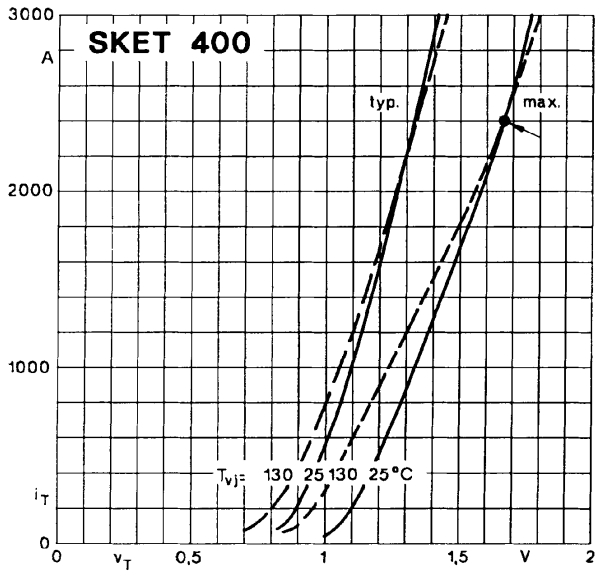

Fig. 8 b On-state characteristics

ET40009

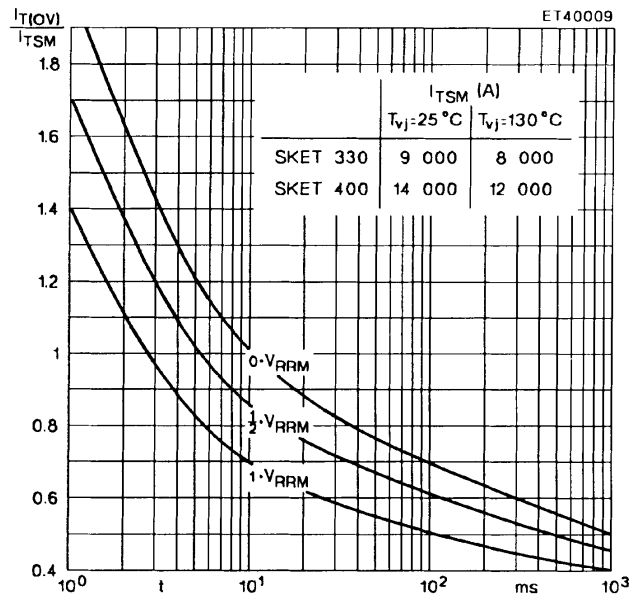

Fig. 9 Surge overload current vs. time

ET33010

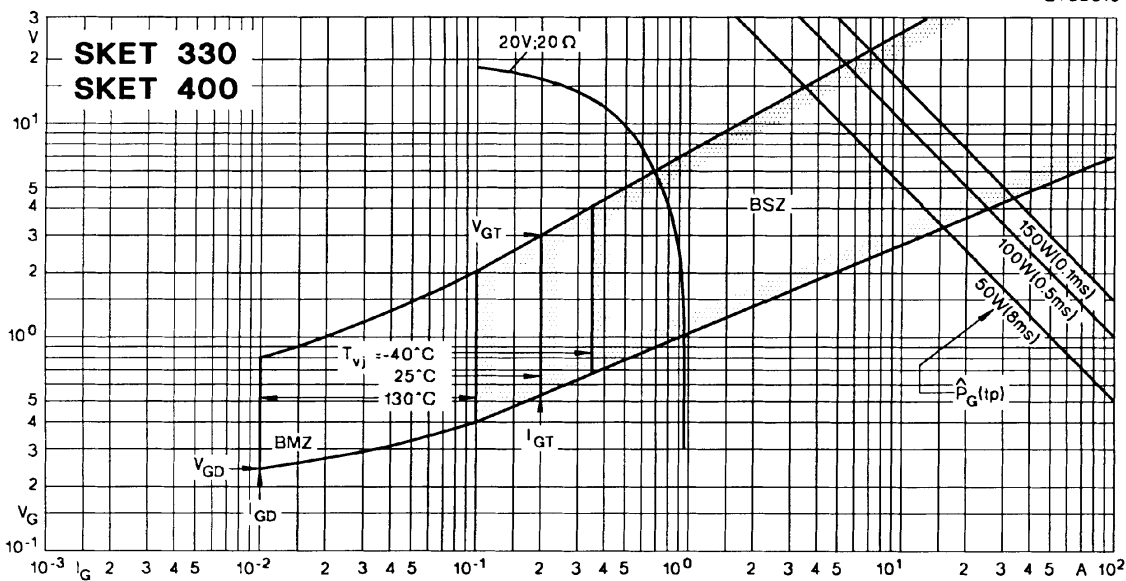
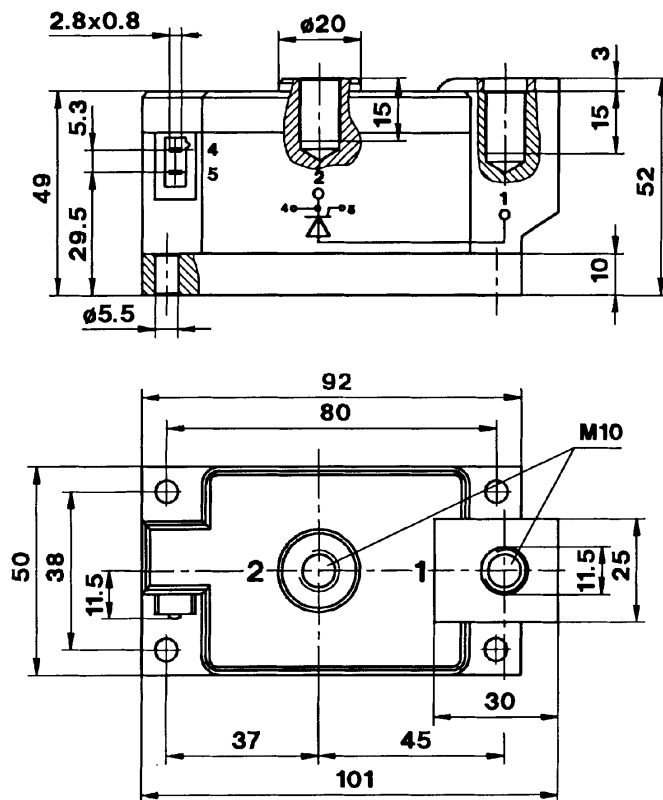

Fig. 10 Gate trigger characteristics

**SKET 330**  
**SKET 400**

Case A 36  
SEMIPACK® 4



Dimensions in mm

**SKKE 400**

Case A 42  
SEMIPACK® 4

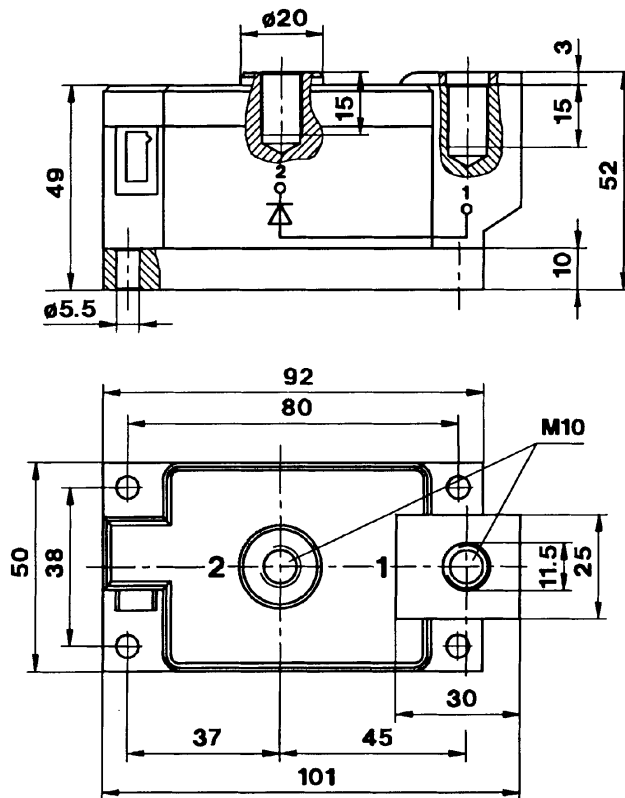

Dimensions in mm