



SEMIPONT® 3

Power Bridge Rectifiers

SKB 52

Features

- Robust plastic case with screw terminals
- Large, isolated base plate
- Blocking voltage up to 1800 V
- High surge currents
- Single phase bridge rectifier
- Easy chassis mounting
- UL recognized, file no. E 63 532

Typical Applications*

- Single phase rectifiers for power supplies
- Input rectifiers for variable frequency drives
- Rectifiers for DC motor field supplies
- Battery charger rectifiers

- 1) Freely suspended or mounted on an isolator
- 2) Mounted on a painted metal sheet of min. 250 x 250 x 1 mm:
 $R_{th(s-a)} = 1,8 \text{ K/W}$

V_{RSM} V	V_{RRM}, V_{DRM} V	$I_D = 50 \text{ A}$ (full conduction) ($T_c = 99 \text{ °C}$)
400	400	SKB 52/04
800	800	SKB 52/08
1200	1200	SKB 52/12
1400	1400	SKB 52/14
1600	1600	SKB 52/16
1800	1800	SKB 52/18

Symbol	Conditions	Values	Units
I_D	$T_c = 85 \text{ °C}$ resistive / inductive load	60	A
	$T_a = 45 \text{ °C}$; isolated ¹⁾	9,5	A
	$T_a = 45 \text{ °C}$; chassis ²⁾	21,5	A
	$T_a = 45 \text{ °C}$; P1A/120 (P1A/200)	40 (45)	A
I_{FSM}	$T_{vj} = 25 \text{ °C}$; 10 ms	500	A
i^2t	$T_{vj} = 150 \text{ °C}$; 10 ms	425	A
	$T_{vj} = 25 \text{ °C}$; 8,3 ... 10 ms	1250	A ² s
V_F	$T_{vj} = 25 \text{ °C}$; $I_F = 150 \text{ A}$	max. 1,8	V
	$T_{vj} = 150 \text{ °C}$	max. 0,85	V
r_T	$T_{vj} = 150 \text{ °C}$	max. 8	mΩ
I_{RD}	$T_{vj} = 25 \text{ °C}$; $V_{DD} = V_{DRM}$; $V_{RD} = V_{RRM}$	max. 0,5	mA
	$T_{vj} = 150 \text{ °C}$; $V_{RD} = V_{RRM}$	5	mA
$R_{th(j-c)}$	per diode	1,5	K/W
	total	0,375	K/W
$R_{th(c-s)}$	total	0,07	K/W
T_{vj}		-40 ... + 150	°C
T_{stg}		-40 ... + 125	°C
V_{isol}	a. c. 50 Hz; r.m.s.; 1 s / 1 min.	3600 (3000)	V
M_s	to heatsink	5 ± 15%	Nm
M_t	to terminals	5 ± 15%	Nm
m		165	g
Case		G 35	

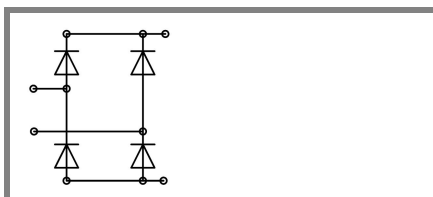

SKB

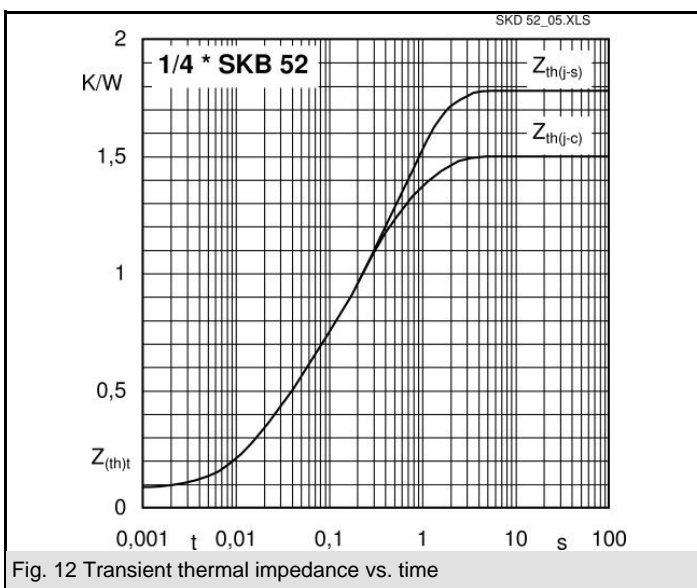
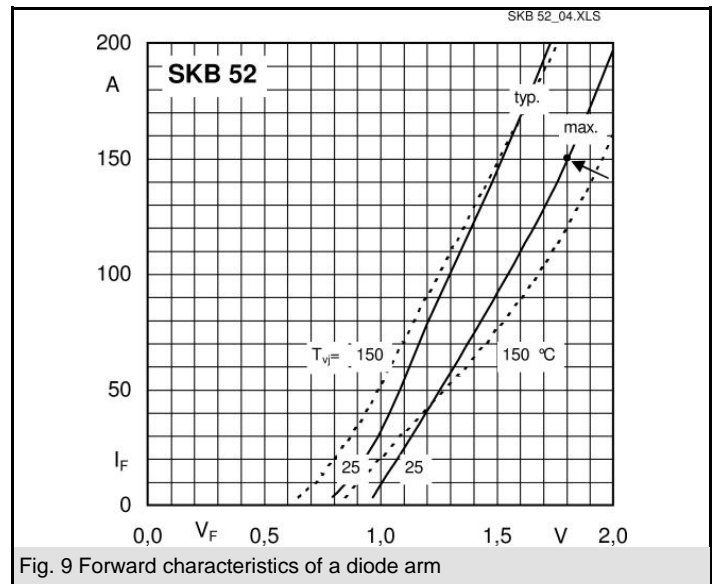
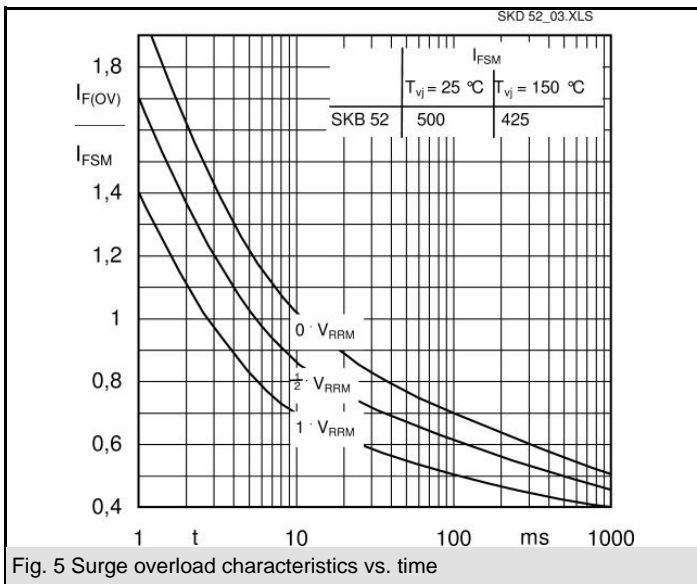
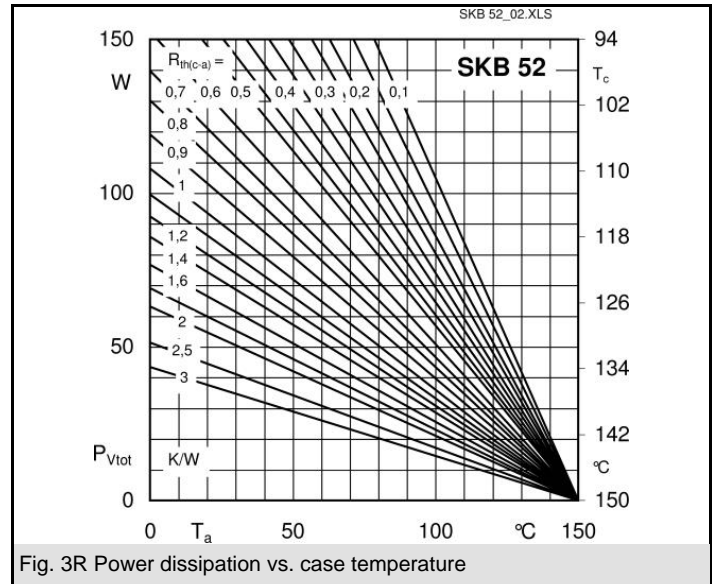
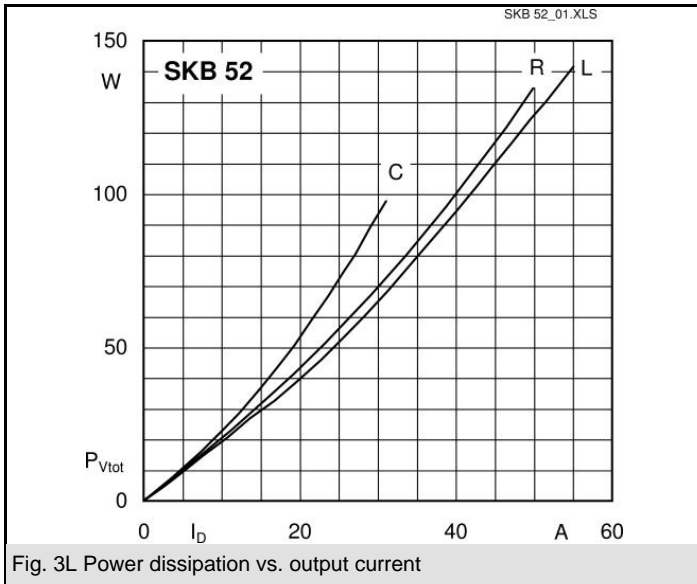

Dimensions in mm

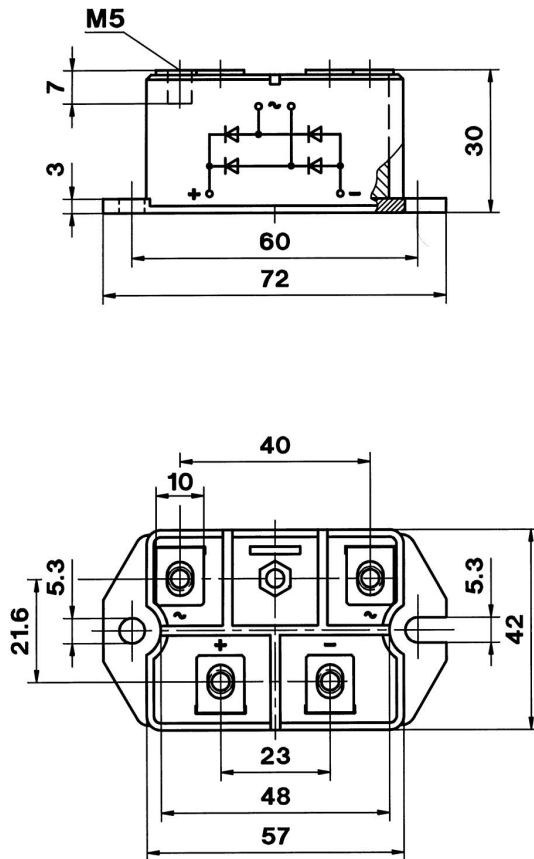

Case G 35

* The specifications of our components may not be considered as an assurance of component characteristics. Components have to be tested for the respective application. Adjustments may be necessary. The use of SEMIKRON products in life support appliances and systems is subject to prior specification and written approval by SEMIKRON. We therefore strongly recommend prior consultation of our personal.