



# Harmony<sup>®</sup> XAC

## Pendant control stations

# Quick access to product information

## Get technical information about your product

References

**Modicon TM3**  
I/O expansion modules for Modicon controllers  
Analog I/O modules

Number and type of channels	Input range	Output range	Resolution	Input format (mA)	Reference	Weight (kg)
2 voltage inputs	-15...+15 VDC 0...20 mA r.t. 20 mA	16.00V or 12.00V r.t.	16.00V or 12.00V r.t.	0VDC	TM3AI2H	0.110
4 voltage inputs	-15...+15 VDC 0...20 mA r.t. 20 mA	16.00V or 12.00V r.t.	16.00V or 12.00V r.t.	0VDC	TM3AI4	0.100
4 differential temperature inputs (I <sup>2</sup> C, R, S, T, N, E, C)	Thermopiles or RTD (PT100, NI1000, PT100, PT200)	16.00V or 12.00V r.t.	16.00V or 12.00V r.t.	0VDC	TM3T4	0.110
4 differential temperature inputs (I <sup>2</sup> C, R, S, T, N, E, C)	Thermopiles or RTD (PT100, NI1000, PT100, PT200)	16.00V or 12.00V r.t.	16.00V or 12.00V r.t.	0VDC	TM3T4G	0.100
8 self-diagnosing	-15...+15 VDC	16.00V or 12.00V r.t.	16.00V or 12.00V r.t.	0VDC	TM3I8	0.110

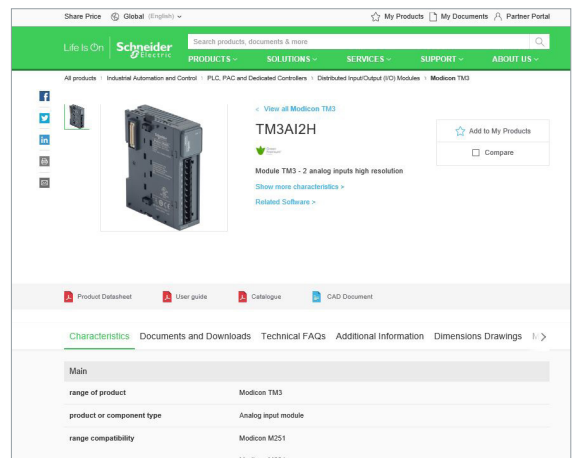

Each commercial reference presented in a catalog contains a hyperlink. Click on it to obtain the technical information of the product:

- Characteristics, Dimensions and drawings, Mounting and clearance, Connections and schemas, Performance curves
- Product image, Instruction sheet, User guide, Product certifications, End of life manual

## Find your catalog

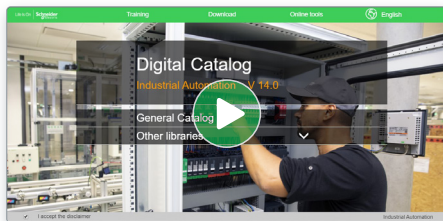

- > With just 3 clicks, you can access the Industrial Automation and Control catalogs, in both English and French
- > Consult digital automation catalogs at [Digi-Cat Online](#)

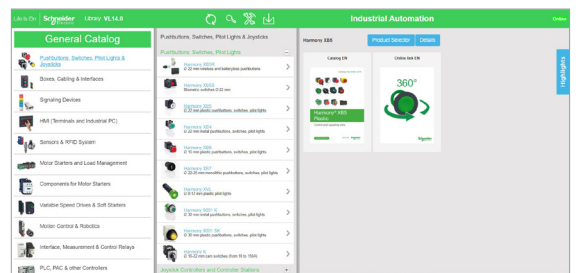

- Up-to-date catalogs
- Embedded product selectors, 360° pictures
- Optimized search by commercial references

## Select your training



- > Find the right [Training](#) for your needs on our Global website
- > Locate the training center with the selector tool, using this [link](#)

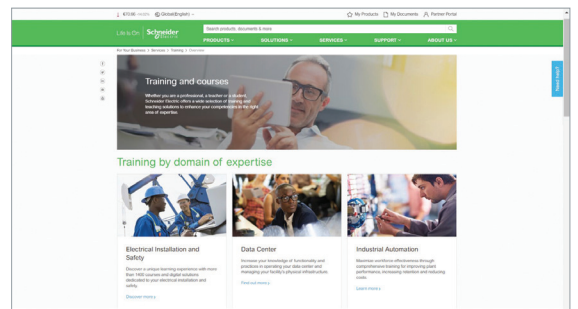

# General contents

Selection guide .....	1
Pendant control stations with intuitive operation .....	2
Pendant control stations .....	3
How to find products, index .....	4

Selection guide for pendant control stations

*Selection guide* ..... 1/2





# Pendant control stations

Complete stations "ready for use"

## Applications

Motor control

-  Single-speed
-  2-speed
-  Emergency stop

## Pendant control stations

Control circuits	
Simple hoisting: 1 movement	Handling-hoisting: 2 movements

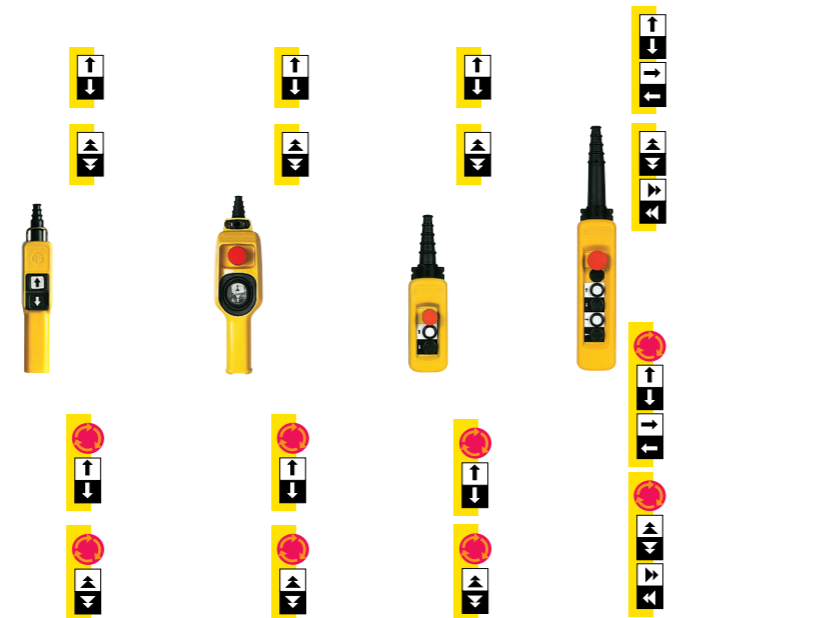

<b>Number of operators</b>	2	1 (2-directional)	2	4
<b>Enclosure material</b>	Polypropylene			Polypropylene
<b>Shock resistance</b>	100 gn	70 gn	100 gn	
<b>Conformity to standards</b>	EN/IEC 60947-5-1, EN/IEC 60204-32, UL 508, CSA 22-2 No. 14, and EN/IEC 60947-5-5, EN/ISO 13850 (1)			EN/IEC 60947-5-1, EN/IEC 60204-32, UL 508, CSA 22-2 No. 14, and EN/IEC 60947-5-5, EN/ISO 13850 (1)
<b>Protective treatment</b>	Standard version, "TH"			
<b>Degree of protection</b>	IP65	IK08		
<b>Cable entries</b>	Rubber sleeve with stepped entry diameter for cable Ø 7 to 15 mm/ 0.28 to 0.59 in.	Rubber sleeve with stepped entry diameter for cable Ø 7 to 18 mm/ 0.28 to 0.71 in.	Rubber sleeve with stepped entry diameter for cable Ø 8 to 26 mm/ 0.31 to 1.02 in.	Rubber sleeve with stepped entry diameter for cable Ø 8 to 26 mm/ 0.31 to 1.02 in.
<b>Operator control station type reference</b>	<b>XACA</b>	<b>XACD</b>	<b>XACA</b>	<b>XACA</b>

(1) For versions with trigger action Emergency stop.

[Click here for Pendant control station catalog](#)

More technical information on [www.se.com](http://www.se.com)

## Pendant control stations

Control circuits	
Handling-hoisting: 3 movements	

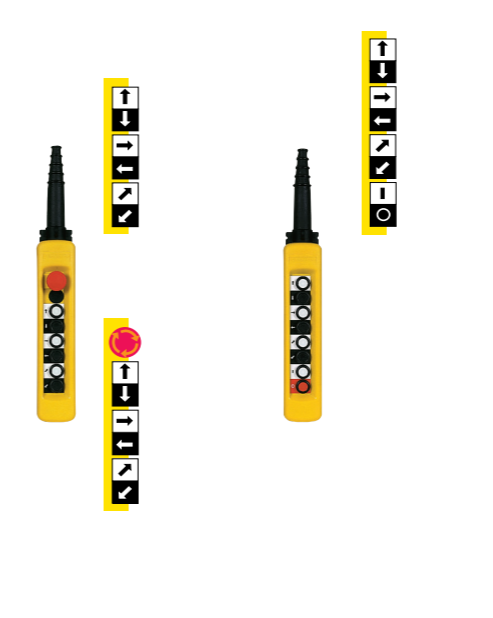

## Power circuits

Simple hoisting: 1 movement			Handling-hoisting:	
			2 movements	3 movements

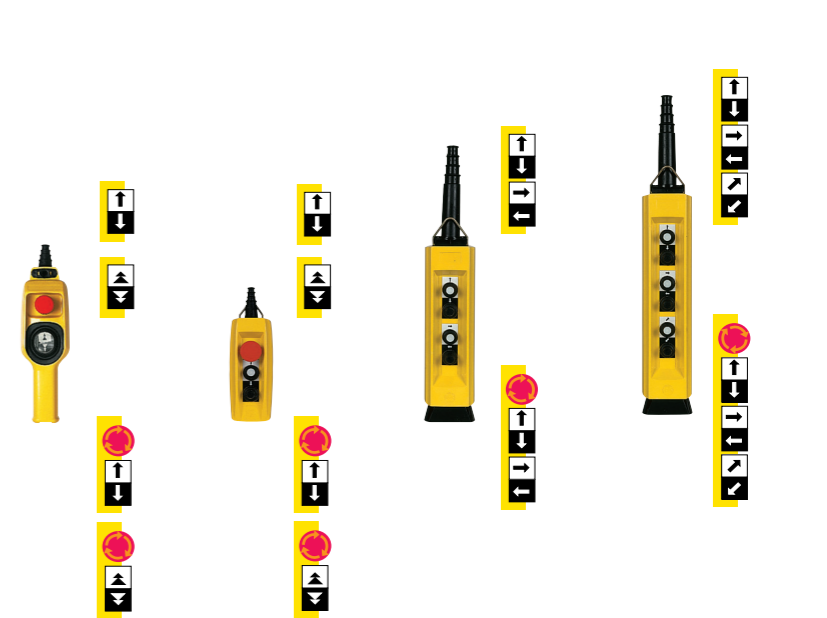

6	8	1 (2-directional)	2	4	6
Polypropylene	Polypropylene	Polypropylene	Polyester		
100 gn		100 gn			
EN/IEC 60947-5-1, EN/IEC 60204-32, UL 508, CSA 22-2 No. 14, and EN/IEC 60947-5-5, EN/ISO 13850 (1)	EN/IEC 60947-5-1, EN/IEC 60204-32, UL 508, CSA 22-2 No. 14, and EN/IEC 60947-5-5, EN/ISO 13850 (1)	EN/IEC 60947-5-1, EN/IEC 60204-32, UL 508, CSA 22-2 No. 14, EN/IEC 60947-3, and EN/IEC 60947-5-5, EN/ISO 13850 (1)			
Standard version, "TH"		Standard version, "TH"			
IP65		IP65			
IK08		IK08			
Rubber sleeve with stepped entry diameter for cable Ø 8 to 26 mm/ 0.31 to 1.02 in.	Rubber sleeve with stepped entry diameter for cable Ø 8 to 26 mm/ 0.31 to 1.02 in.	Rubber sleeve with stepped entry diameter for cable Ø 7 to 18 mm/ 0.28 to 0.71 in.	Rubber sleeve with stepped entry diameter for cable Ø 10 to 22 mm/ 0.39 to 0.87 in.		
<b>XACA</b>	<b>XACA</b>	<b>XACD</b>	<b>XACB</b>	<b>XACB</b>	<b>XACB</b>

More technical information on [www.se.com](http://www.se.com)

# Pendant control stations

## Variable composition stations

1

<b>Applications</b>	<b>Pendant control stations</b>	
<b>Number of cut-outs</b>	1 or 2	2, 3, 4, 5, 6, 8, or 12



<b>Enclosure material</b>	Polypropylene	
<b>Shock resistance</b> <small>Conforming to standard IEC 60068-2-27</small>	100 gn	
<b>Conformity to standards</b>	EN/IEC 60947-5-1, EN/IEC 60204-32, UL 508, CSA 22-2 No. 14, EN/IEC 60947-3, and EN/IEC 60947-5-5, EN/ISO 13850 (1)	
<b>Protective treatment</b>	Standard version, "TH"	
<b>Degree of protection</b> <small>Conforming to standard IEC 60529</small>	IP65	
<small>Conforming to standard EN 50102</small>	IK08	
<b>Equipment</b>	<ul style="list-style-type: none"> <li>■ Emergency stop (front mounted)</li> <li>■ Contact blocks for 1 or 2 speeds</li> </ul>	<ul style="list-style-type: none"> <li>■ Pushbuttons</li> <li>■ Selector/key switches</li> <li>■ Pilot lights</li> <li>■ Emergency stop (front or base mounted)</li> <li>■ Wobblesticks</li> <li>■ Contact blocks for 1 or 2 speeds</li> </ul>
<b>Cable entries</b>	Rubber sleeve with stepped entry diameter for cable Ø 7 to 18 mm/0.28 to 0.71 in.	Rubber sleeve with stepped entry diameter for cable Ø 8 to 26 mm/0.31 to 1.02 in.
<b>Operator control station type reference</b>	<b>XACD</b>	<b>XACA</b>

1

<b>Power circuits</b>	1 or 2	2, 3, 4, 6, 8, or 12 in 2 rows of 6
-----------------------	--------	-------------------------------------



<b>Enclosure material</b>	Polypropylene	Polyester
<b>Shock resistance</b> <small>Conforming to standard IEC 60068-2-27</small>	100 gn	
<b>Conformity to standards</b>	EN/IEC 60947-5-1, EN/IEC 60204-32, UL 508, CSA 22-2 No. 14, EN/IEC 60947-3, and EN/IEC 60947-5-5, EN/ISO 13850 (1)	
<b>Protective treatment</b>	Standard version, "TH"	
<b>Degree of protection</b> <small>Conforming to standard IEC 60529</small>	IP65	
<small>Conforming to standard EN 50102</small>	IK08	
<b>Equipment</b>	<ul style="list-style-type: none"> <li>■ Emergency stop (front mounted)</li> <li>■ Contact blocks for 1 or 2 speeds</li> </ul>	<ul style="list-style-type: none"> <li>■ Pushbuttons</li> <li>■ Selector/key switches</li> <li>■ Pilot lights</li> <li>■ Emergency stop (front or base mounted)</li> <li>■ Wobblesticks</li> <li>■ Contact blocks for 1 or 2 speeds</li> </ul>
<b>Cable entries</b>	Rubber sleeve with stepped entry diameter for cable Ø 7 to 18 mm/0.28 to 0.71 in.	Rubber sleeve with stepped entry diameter for cable Ø 10 to 22 mm/0.39 to 0.87 in.
<b>Operator control station type reference</b>	<b>XACD</b>	<b>XACB</b>

[Click here for Pendant control station catalog](#)

More technical information on [www.se.com](http://www.se.com)

More technical information on [www.se.com](http://www.se.com)

# Wireless industrial radio remote control stations

Complete stations “ready for use”

Type of control station
Applications

<b>Compact</b>
Wireless remote control stations
Handling-hoisting



Number of operators	6
Enclosure material	Polyurethane
Shock resistance	Conforming to standard IEC 60068-2-27
Conformity to standards	For receiver: EN 300 328 V2.1.1: 2016-11 EN 301 489-1 V2.1.1: 2017-02 EN 301 489-17 V3.1.1: 2017-02 EN 60950-1:2006 + A11: 2009 EN 50581: 2012 EN ISO 13849-1:2016  For transmitter: EN 300 440 V2.1.1: 2017-03 EN 301 489-1 V2.1.1: 2017-02 EN 301 489-3 V2.1.1: 2017-03 EN 60950-1:2006 + A11: 2009 + A1: 2010 + A12: 2011 EN 62479: 2010 EN 50581: 2012 EN ISO 13849-1:2016
Protective treatment	Standard version, “TC”
Degree of protection	Conforming to standard IEC 60529 IP65 for transmitter IP66 for receiver
Cable entries	PVC torsion cable, largest single wire Ø 0.21 mm/0.008 in., outer Ø 12.0 mm/0.47 in.
Operator control station type reference	<b>ZART8LS + ZARB</b>

(1) For versions with trigger action Emergency stop.  
(2) For more information, refer to Harmony eXLhoist Pocket catalog.

[Click here for Harmony eXLhoist catalog](#)

More technical Information on [www.se.com](http://www.se.com)

<b>Pocket</b>
Wireless remote control stations
Machine application



Number of operators	3, 4, 6, 8, and 10
Enclosure material	Polyurethane
Shock resistance	-
Conformity to standards	For receiver: EN 300 328 V2.1.1: 2016-11 EN 301 489-1 V2.1.1: 2017-02 EN 301 489-17 V3.1.1: 2017-02 EN 60950-1:2006 + A11: 2009 EN 50581: 2012  For transmitter: EN 300 440 V2.1.1: 2017-03 EN 301 489-1 V2.1.1: 2017-02 EN 301 489-3 V2.1.1: 2017-03 EN 60950-1:2006 + A11: 2009 + A1: 2010 + A12: 2011 EN 62479: 2010 EN 50581: 2012
Protective treatment	Standard version, “TC”
Degree of protection	IP67 for transmitter and IP66 for receiver
Cable entries	PVC torsion cable, largest single wire Ø 0.21 mm (0.008 in.), outer Ø 12.0 mm (0.47 in.)
Operator control station type reference	<b>ZAR (2)</b>

[Click here for Harmony Pocket catalog](#)

More technical Information on [www.se.com](http://www.se.com)

---

## Pendant control stations with intuitive operations

### ■ Double insulated, for control circuits

- Complete stations “ready for use”, “Pistol grip”, type XACA..... 2/2
- Complete stations “ready for use”, type XACD ..... 2/2

### ■ Double insulated, for power circuits (direct switching)

- Complete stations “ready for use”, type XACD ..... 2/3

### ■ Double insulated, for control or power circuits

- Empty enclosures, type XACD..... 2/5
- Separate components and spare parts ..... 2/6
- Variable composition stations, factory assembled ..... 2/7





# Pendant control stations

Double insulated with intuitive operation, type XACA “Pistol grip”

For control circuits

Complete stations “ready for use”

2

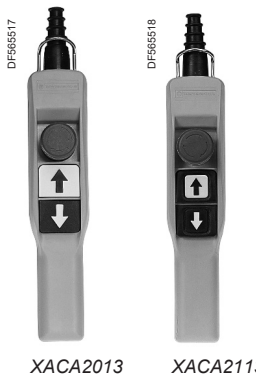

For control of single-speed hoist motors						
Functions	Number of operators	Type of operators	Contact block(s) and scheme		Reference	Weight kg
			Per direction	For Emergency stop		
	2 mechanically interlocked	Standard	1 N/O ZB2BE101	-	<a href="#">XACA201</a>	0.270
			1 N/C + 1 N/O ZB2BE102 + ZB2BE101	-	<a href="#">XACA205</a>	0.300
		Booted	1 N/O ZB2BE101	-	<a href="#">XACA211</a>	0.290
			1 N/C + 1 N/O ZB2BE102 + ZB2BE101	-	<a href="#">XACA215</a>	0.320
	2 mechanically interlocked + 1 trigger action latching Emergency stop Ø 30 mm operator ZB5AS834 (1)	Standard	1 N/O ZB2BE101	1 N/C ZB2BE102	<a href="#">XACA2013</a>	0.310
			1 N/C + 1 N/O ZB2BE102 + ZB2BE101	1 N/C ZB2BE102	<a href="#">XACA2053</a>	0.340
		Booted	1 N/O ZB2BE101	1 N/C ZB2BE102	<a href="#">XACA2113</a>	0.310
			1 N/C + 1 N/O ZB2BE102 + ZB2BE101	1 N/C ZB2BE102	<a href="#">XACA2153</a>	0.340

(1) Harmony XB5, trigger action mechanically latching Emergency stop pushbuttons conform to standards EN/IEC 60204-32, EN/ISO 13850, Machinery directive 98/37/EC and standard EN/IEC 60947-5-5.

# Pendant control stations

Double insulated with intuitive operation, type XACA "Pistol grip"

For control circuits

Complete stations "ready for use"

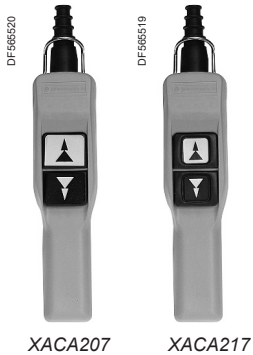

## For control of 2-speed hoist motors

Functions	Number of operators	Type of operators	Contact block(s) and scheme	Reference	Weight kg
2 mechanically interlocked	2	Standard	2 step 1 N/O + 1 N/O staggered ZB2BE101 + ZB2BE201	XACA207	0.320
		Booted	2 step 1 N/O + 1 N/O staggered ZB2BE101 + ZB2BE201	XACA217	0.320
		Standard	2 step 1 N/O + 1 N/O staggered ZB2BE101 + ZB2BE201	1 N/C ZB2BE102  XACA2073	0.360
		Booted	2 step 1 N/O + 1 N/O staggered ZB2BE101 + ZB2BE201	1 N/C ZB2BE102  XACA2173	0.360

## Separate components and spare parts

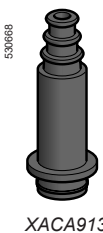
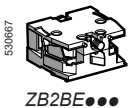

Description	For use with	Marking/Function	Scheme	Reference	Weight kg
<b>Booted pushbutton operators</b> with fixing screws	XACA217● (2-speed)	▲	-	XACA923	0.010
		▼	-	XACA924	0.010
<b>Contact blocks</b> spring return, slow break	XACA all models	N/O		ZB2BE101	0.015
		N/C		ZB2BE102	0.015
		N/O staggered		ZB2BE201	0.015
<b>Protective cable sleeve</b> + suspension ring + cable clamp	Cable Ø 7 to Ø 13 mm	-	-	XACA913	0.070

(1) Harmony XB5, trigger action mechanically latching Emergency stop pushbuttons conform to standards EN/IEC 60204-32, EN/ISO 13850, Machinery directive 98/37/EC and standard EN/IEC 60947-5-5.

# Pendant control stations

Double insulated with intuitive operation,  
type XACD

For control circuits

Complete stations “ready for use”

2

DF66503



XACD21A0101

DF66501



XACD24A0105

### For control of single-speed hoist motors

Functions	Number of operators	Contact block(s) and scheme	Reference	Weight kg
 Reversing, mechanically interlocked	1	1 N/O	XACD21A0101	0.340
	2-directional operator	ZB2BE101		
	1	1 N/C + 1 N/O	XACD24A0105	0.425
	2-directional operator + 1 trigger action Emer. stop Ø 30 mm ZA2BS834 operator (2)	ZB2BE102 + ZB2BE101		

(1) Reference of double contact block for reversing operation.

(2) Trigger action mechanically latching Emergency stop pushbuttons conform to standards EN/IEC 60204-32, EN/ISO 13850, Machinery directive 98/37/EC and standard EN/IEC 60947-5-5.

# Pendant control stations

Double insulated with intuitive operation, type XACD

For control or power circuits

Empty enclosures, separate components and spare parts



XACD021



XACD022



ZB2BE10



XEDS1231



XEDS2121

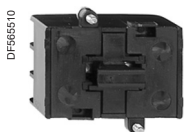

XENT1991

## Empty enclosures

Description	Enclosure cut-outs	Reference	Weight kg
<b>Empty enclosure</b> comprising: - the enclosure, - protective cable sleeve for Ø 7 to 18 mm cable, - internal cable clamp, - cable tie (for tightening sleeve onto cable), - the directional operator, - legends.	For directional operator + operating head (Ø 22.5 mm cut-out)	<a href="#">XACD022</a>	0.345

## Variable composition stations, factory assembled

Use the order form on page 30073/7 to define the required configuration.

**Equipment:** contact blocks and operating heads

See separate components, page 30073/5

## Contact blocks

Description	Application	Function (1)	Scheme (1)	Max. power/ 400 V	Reference	Weight kg
<b>For control circuits</b>						
<b>Single block</b> spring return, slow break	Single-speed	N/O		-	<a href="#">ZB2BE101</a>	0.015
		N/C		-	<a href="#">ZB2BE102</a>	0.015
<b>Double block</b> spring return, snap action	2-speed	N/O + N/O staggered		-	<a href="#">XEDS1231</a>	0.015
		N/C + N/O + N/O staggered		-	<a href="#">XEDS1241</a>	0.015
<b>For power circuits</b>						
<b>Double block</b> spring return, snap action	Single-speed	2-pole		1.1 kW	<a href="#">XEDS2111</a>	0.080
				2.2 kW	<a href="#">XEDS3111</a>	0.090
	2-speed	2-pole		1.1 kW	<a href="#">XEDS2231</a>	0.110
				2.2 kW	<a href="#">XEDS3231</a>	0.110
				2.2 kW	<a href="#">XEDS3241</a>	0.120
<b>Single block</b> spring return, slow break	N/C			-	<a href="#">ZB2BE102</a>	0.015
				N/C + N/C + N/C		-

(1) Function or scheme per direction for double contact blocks.

# Pendant control stations

Double insulated with intuitive operation,  
type XACD

For control or power circuits

Separate components and spare parts

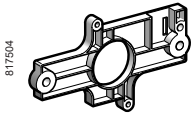

817504

XACD912



DF538494

ZA2BS934



DF56513

ZA2BD2



DF56514

ZA2BG2

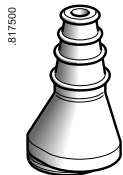

817500

XACD901

## Operating heads for Ø 22.5 mm cut-out

Description	Colour	Reference	Weight kg
<b>1 trigger action latching Emergency stop Ø 30 mm operator</b> Key release, n° 455 (2) Key withdrawal in rest (unactuated) position	Red	<a href="#">ZA2BS934</a>	0.060
<b>Selector switch, standard handle</b> 2 position, stay put	Black	<a href="#">ZA2BD2</a>	0.018
<b>Key switch (key n° 455) (2)</b> 2 position, stay put Key withdrawal in left-hand position	–	<a href="#">ZA2BG2</a>	0.020
<b>Key switch (key n° 455) (2)</b> 2 position, spring return from right to left Key withdrawal in left-hand position	–	<a href="#">ZA2BG6</a>	0.020
<b>Key switch (key n° 455) (2)</b> 2 position, stay put Key withdrawal in left and right-hand position	–	<a href="#">ZA2BG4</a>	0.020
<b>Key switch (key n° 455) (2) (3)</b> 3 position, stay put Key withdrawal in left and right-hand position	–	<a href="#">ZA2BG5</a>	0.020
<b>Key switch (key n° 455) (2) (3)</b> 3 position, stay put Key withdrawal in centre position	–	<a href="#">ZA2BG3</a>	0.020

## Complementary accessories

<b>Protective cable sleeve</b> for cable Ø 7 to 18 mm	–	<a href="#">XACD901</a>	0.030
---	---	-------------------------	-------

# Pendant control stations

Double insulated with intuitive operation,  
type XACD

For control or power circuits

Variable composition stations, factory assembled

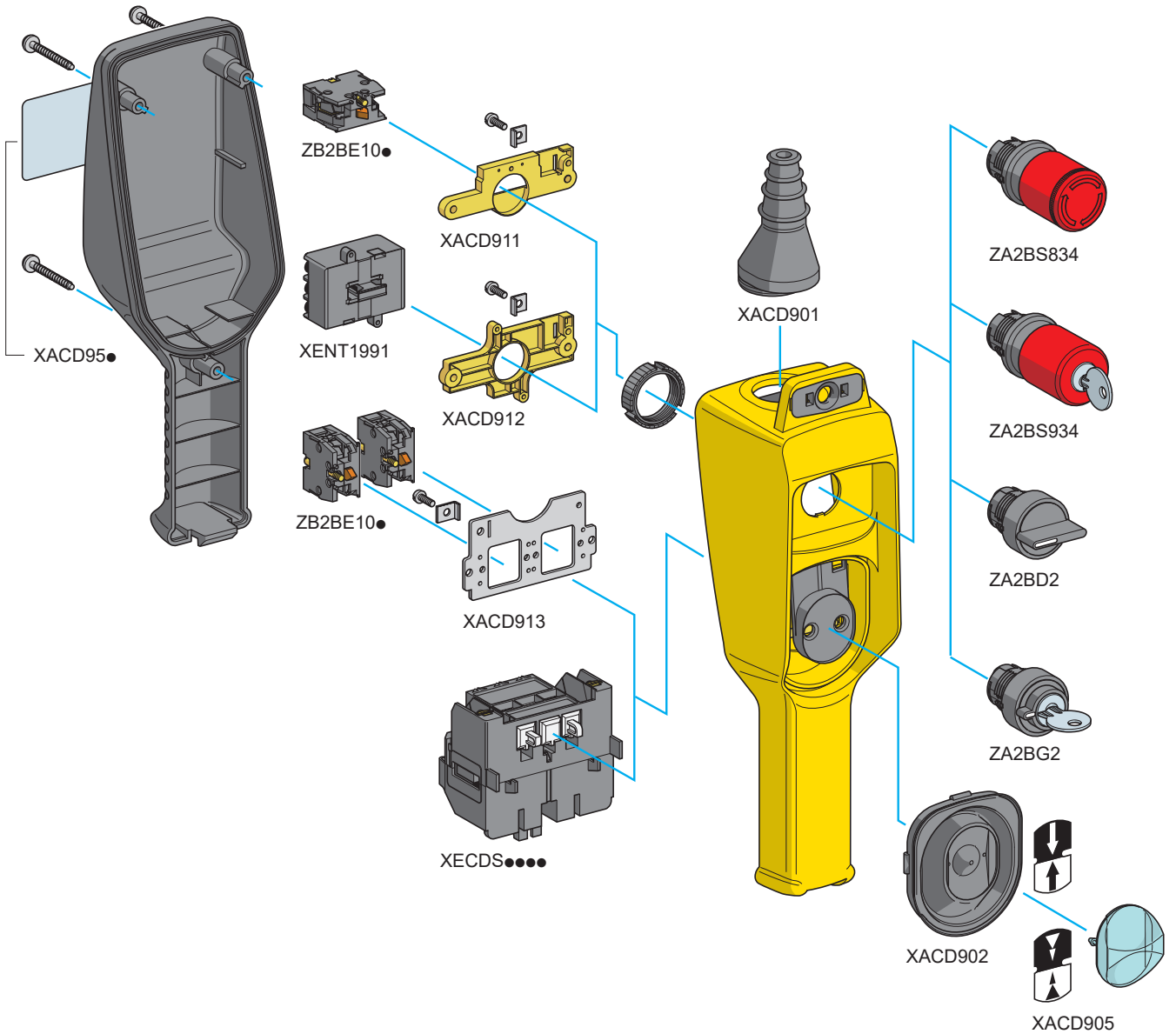

# Pendant control stations

Double insulated with intuitive operation, type XACD  
For control or power circuits  
Variable composition stations, factory assembled

2

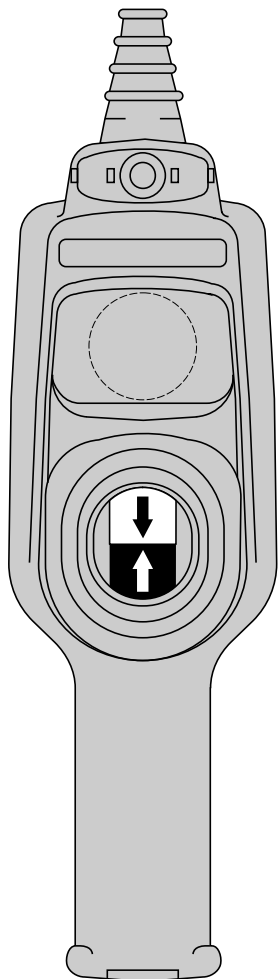

<b>Customer</b>			<b>Schneider Electric Industries</b>	
Company	Order N°	Delivery date	Sales office - Subsidiary Co.	Order N°

Enter the order with XACD09 reference

Unit reference of empty enclosure, see page 30073/4				Number of identical stations	Enclosure price (1)
XAC	D	0	2		

- The reference of the empty enclosure above comprises:
- the enclosure,
  - internal cable clamp,
  - cable tie (for tightening sleeve onto cable),
  - the directional operator with set of legends, **XACD905**,
  - protective cable sleeve for Ø 7 to 18 mm cable, **XACD901**,
  - diaphragm for directional operator, **XACD902**.

<b>Operating head</b> see page 30073/5		<b>Contact blocks</b> see page 30073/4		<b>Support plate</b> see page 30073/5		<b>Total price</b>
Reference	Unit price	Reference	Unit price	Reference	Unit price	

<b>Contact blocks</b> see page 30073/4			<b>Support plate (for ZB2BE●●● only)</b> see page 30073/5			<b>Total price</b>
Reference	Qty.	Unit price	Reference	Qty.	Unit price	

**Factory assembly:**  
Add an additional cost for assembly **XAC9VA**

**Total price of assembled pendant station**

(1) Obtain the empty enclosure price.

---

Pendant control stations

■ **Double insulated, type XACA, for control circuits**

- Complete stations “ready for use” ..... 3/2
- Empty enclosures ..... 3/5
- Separate components and spare parts ..... 3/6
- Variable composition stations, factory assembled ..... 3/12

■ **Double insulated, type XACB or metal, type XACM**

- Complete stations “ready for use”, type XACB, for control circuits..... 3/14
- Complete stations “ready for use”, type XACB, for power circuits..... 3/15
- Empty enclosures, type XACB, for control or power circuits..... 3/16
- Separate components and spare parts ..... 3/17
- Variable composition stations, factory assembled ..... 3/23



# Pendant control stations

Double insulated, type XACA

For control circuits

Complete stations "ready for use"

## For control of single-speed motors

Functions	Number of operators	Contact block(s) and scheme		Reference	Weight kg
		Per direction	For Emergency stop		
	2 mechanically interlocked	1 N/O ZB2BE101	-	XACA271	0.475
		1 N/C + 1 N/O ZB2BE102 + ZB2BE101	-	XACA281	0.500
	2 mechanically interlocked + 1 trigger action latching Emergency stop Ø 30 mm operator ZA2BS834 (1)	1 N/O ZB2BE101	1 N/C ZB2BE102	XACA2713 (1)	0.575
		1 N/C + 1 N/O ZB2BE102 + ZB2BE101	1 N/C ZB2BE102	XACA2813 (1)	0.600
		1 N/O ZB2BE101	1 N/C + N/C + N/C XENT1192	XACA27131 (1)	0.615
		1 N/C + 1 N/O ZB2BE102 + ZB2BE101	1 N/C + N/C + N/C XENT1192	XACA28131 (1)	0.635
	4 mechanically interlocked between pairs	1 N/O ZB2BE101	-	XACA471	0.625
		1 N/C + 1 N/O ZB2BE102 + ZB2BE101	-	XACA481	0.675
		1 N/O ZB2BE101	1 N/C ZB2BE102	XACA4713 (1)	0.800
		1 N/C + 1 N/O ZB2BE102 + ZB2BE101	1 N/C ZB2BE102	XACA4813 (1)	0.815
	4 mechanically interlocked between pairs + 1 trigger action latching Emergency stop Ø 40 mm operator ZA2BS844 (1)	1 N/O ZB2BE101	1 N/C + N/C + N/C XENT1192	XACA47131 (1)	0.835
		1 N/C + 1 N/O ZB2BE102 + ZB2BE101	1 N/C + N/C + N/C XENT1192	XACA48131 (1)	0.850

(1) Trigger action mechanically latching Emergency stop pushbuttons conform to standards EN/IEC 60204-32, EN/ISO 13850, Machinery directive 98/37/EC and standard EN/IEC 60947-5-5.

DF56523



XACA271  
XACA281

DF56524



XACA2714  
XACA2814

DF56524



XACA27141  
XACA28141

DF56525



XACA471  
XACA481

530226



XACA4714  
XACA4814  
XACA47141  
XACA48141

3

# Pendant control stations

Double insulated, type XACA

For control circuits

Complete stations "ready for use"



XACA671  
XACA681

XACA6714  
XACA6814



XACA67141  
XACA68141

XACA871  
XACA881

## For control of single-speed motors (continued)

Functions	Number of operators	Contact block(s) and scheme		Reference	Weight kg
		Per direction	For Emergency stop		
	6 mechanically interlocked between pairs	1 N/O ZB2BE101	-	XACA671	0.860
		1 N/C + 1 N/O ZB2BE102 + ZB2BE101	-	XACA681	0.950
	6 mechanically interlocked between pairs + 1 trigger action latching Emergency stop Ø 40 mm operator ZA2BS844 (1)	1 N/O ZB2BE101	1 N/C ZB2BE102	XACA6713 (1)	0.845
		1 N/C + 1 N/O ZB2BE102 + ZB2BE101	1 N/C ZB2BE102	XACA6813 (1)	0.935
	6 mechanically interlocked between pairs + 1 trigger action latching Emergency stop Ø 40 mm operator ZA2BS844 (1)	1 N/O ZB2BE101	1 N/C + N/C + N/C XENT1192	XACA67141 (1)	0.880
		1 N/C + 1 N/O ZB2BE102 + ZB2BE101	1 N/C + N/C + N/C XENT1192	XACA68141 (1)	0.970
	8 mechanically interlocked between pairs	1 N/O on 7 operators ZB2BE101 and 1 N/C on the 8 <sup>th</sup> operator ZB2BE102	-	XACA871	0.940
		1 N/C + 1 N/O ZB2BE102 + ZB2BE101	-	XACA881	1.045

(1) Trigger action mechanically latching Emergency stop pushbuttons conform to standards EN/IEC 60204-32, EN/ISO 13850, Machinery directive 98/37/EC and standard EN/IEC 60947-5-5.

# Pendant control stations

Double insulated, type XACA

For control circuits

Complete stations "ready for use"

## For control of 2-speed motors

Functions	Number of operators	Contact block(s) and scheme	Reference	Weight kg
		Per direction	For Emergency stop	
	2 mechanically interlocked between pairs	1 N/C + N/O + N/O staggered XENG1191	-	XACA291 0.525
	2 mechanically interlocked between pairs + 1 trigger action latching Emergency stop Ø 30 mm operator ZA2BS834 (1)	1 N/C + N/O + N/O staggered XENG1191	1 N/C ZB2BE102	XACA4913 (1) 0.570
	1 N/C + N/O + N/O staggered ZA2BS834 (1)	1 N/C + N/C + N/C XENT1192		XACA49131 (1) 0.605
	4 mechanically interlocked between pairs	1 N/C + N/O + N/O staggered XENG1191	-	XACA491 0.625
	4 mechanically interlocked between pairs + 1 trigger action latching Emergency stop Ø 40 mm operator ZA2BS844 (1)	1 N/C + N/O + N/O staggered XENG1191	1 N/C + N/C + N/C XENT1192	XACA49141 (1) 0.700
	1 N/C + N/O + N/O staggered (a) XENG1191			XACA492 0.675
	1 N/O (b) ZB2BE101			
	4 mechanically interlocked between pairs + 1 trigger action latching Emergency stop Ø 40 mm operator ZA2BS844 (1)	1 N/C + N/O + N/O staggered (a) XENG1191	1 N/C ZB2BE102	XACA4923 (1) 0.700
	1 N/O (b) ZB2BE101			
	1 N/C + N/O + N/O staggered (a) XENG1191		1 N/C + N/C + N/C XENT1192	XACA49231 (1) 0.735
	1 N/O (b) ZB2BE101			

(1) Trigger action mechanically latching Emergency stop pushbuttons conform to standards EN/IEC 60204-32, EN/ISO 13850, Machinery directive 98/37/EC and standard EN/IEC 60947-5-5.

# Pendant control stations

Double insulated, type XACA

For control circuits

Empty enclosures

530233



XACA02

530234



XACA03

530234



XACA12

## Empty enclosures

Description	Number of cut-outs	Reference	Weight kg
<b>Enclosure</b> comprising: - the enclosure, - internal mounting plate, - protective cable sleeve, - internal cable clamp, - suspension ring, - cable tie (for tightening sleeve onto cable).	2	XACA02	0.440
	3	XACA03 (1)	0.440
	4	XACA04	0.540
	5	XACA05 (1)	0.625
	6	XACA06	0.665
	8	XACA08	0.770
	12	XACA12	1.000

## Variable composition stations, factory assembled

Use the order form on page 3/13 to define the required configuration.

**Equipment:** contact blocks, operating heads (control and signalling), complementary accessories

See separate components, page 30075/6

(1) Enclosures with 3 cut-outs XACA03 and 5 cut-outs XACA05 cannot be fitted with a mounting adaptor for base mounted units. The first cut-out can only be used for the Emergency stop function.



# Pendant control stations

Double insulated, type XACA

For control circuits

Separate components and spare parts

530238



ZB2BE101  
ZB2BE102

Contact blocks for front mounting					
Description	Application	Function	Scheme	Reference	Weight kg
Single block, spring return slow break	Single-speed	N/O		ZB2BE101	0.015
		N/C		ZB2BE102	0.015
	N/C + N/O + N/O simultaneous (1)			XENG1491	0.040
	2-speed	N/C + N/O + N/O staggered (1)		XENG1191	0.040
Double block, latching slow break (2)	Single-speed	N/O		XENG3781	0.060
		N/O		XENG3791	0.060
		N/O		XENG3791	0.060
		N/C		XENG3791	0.060

530237



XENG1191  
XENG1491

530236

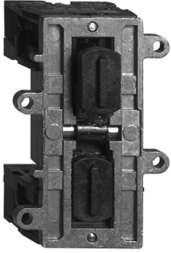

XENG3781  
XENG3791

530239



XENT1192

Isolating switch, slow break, for front mounting					
For mounting in enclosures	Application	Function	Scheme	Reference	Weight kg
XACA03 (frontal cut-out) XACA05, A06, A08 (frontal or base cut-out)	Emergency stop	N/C + N/C + N/C with positive opening operation		XENT1192	0.050

(1) Only for use with XACA9●●● operators.

(2) Not suitable for use with the following operating heads: ZA2BB, ZA2BD, ZA2BG and ZA2BS.

## Pendant control stations

Double insulated, type XACA

For control circuits

Separate components and spare parts

530240

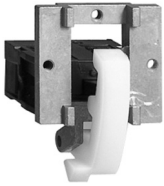

XACS10●

## Contact blocks for base mounting

Description	Function	Scheme	Reference	Weight kg
Spring return slow break (1)	N/O		XACS101	0.030
	N/C		XACS102	0.030
	N/O + N/O		XACS103	0.045
	N/C + N/C		XACS104	0.045
	N/C + N/O		XACS105	0.045

PF110461



ZB2BV006

## Pilot light bodies for front mounting

Description	Supply voltage	Scheme	Reference	Weight kg
Direct supply Bulb not included (2)	≤ 400 V		ZB2BV006	0.015

(1) Not suitable for use with 3-position operating heads ZA2BD and ZA2BG or for mounting in enclosures XACA039 and XACA03.

(2) Bulb type for use with direct supply units: BA 9s base fitting incandescent bulb  $U \leq 130$  V or neon bulb  $110$  V  $\leq U \leq 400$  V. Maximum power: 2.6 W, maximum  $\varnothing$ : 11 mm, maximum length: 28 mm. See [page 3/8](#).

# Pendant control stations

Double insulated, type XACA

For control circuits

Separate components and spare parts

530243



XACA94●●

Operating heads for front mounting				
Description	Colour	Sold in lots of	Unit reference	Weight kg
Booted operators	White	10	XACA9411	0.010
	Black	10	XACA9412	0.010
	Green	10	XACA9413	0.010
	Red	10	XACA9414	0.010
	Yellow	10	XACA9415	0.010
	Blue	10	XACA9416	0.010
	Brown	10	XACA9419	0.010

3

530249



ZA2BS834

DF539493



ZA2BS944

530245



ZA2BD●

530246



ZA2BG●

DF565529



ZA2BB2

Operating heads for front or base mounting				
Description	Colour	Type	Reference	Weight kg
Trigger action latching Emergency stop (1) Turn to release	Red	Ø 30 mm	ZA2BS834	0.040
		Ø 40 mm	ZA2BS844	0.050
Trigger action latching Emergency stop (2) Key release (n° 455) Key withdrawal in rest (unactuated) position	Red	Ø 30 mm	ZA2BS934	0.060
		Ø 40 mm	ZA2BS944	0.065
Selector switches (3), standard handle (Not to be used with XENG●●●● contact blocks)	Black	2 position, stay put	ZA2BD2	0.018
		3 position, stay put (4)	ZA2BD3	0.018
Key switches (2) (key n° 455) Key withdrawal in left and right-hand position	-	2 position, stay put	ZA2BG4	0.042
		3 position, stay put (4)	ZA2BG5	0.042
Key switch (2) (key n° 455) Key withdrawal in left-hand position	-	2 position, stay put	ZA2BG2	0.042
Key switch (2) (key n° 455) Spring return from right to left Key withdrawal in left-hand position	-	2-position	ZA2BG6	0.042
Key switch (4) (2) (key n° 455) Key withdrawal in centre position	-	3 position, stay put	ZA2BG3	0.042
Wobblesticks (5) Operates in all directions for fast stop	Black	-	ZA2BB2	0.060

(1) Trigger action mechanically latching Emergency stop pushbuttons conform to standards EN/IEC 60204-32, EN/ISO 13850, Machinery directive 98/37/EC and standard EN/IEC 60947-5-5.

(2) Other key numbers available on request, please consult our Customer Care Centre.

(3) Selector switches available with other mechanical functions, please consult our Customer Care Centre.

(4) Only suitable for front mounting.

(5) Base mounting recommended.

# Pendant control stations

Double insulated, type XACA

For control circuits

Separate components and spare parts

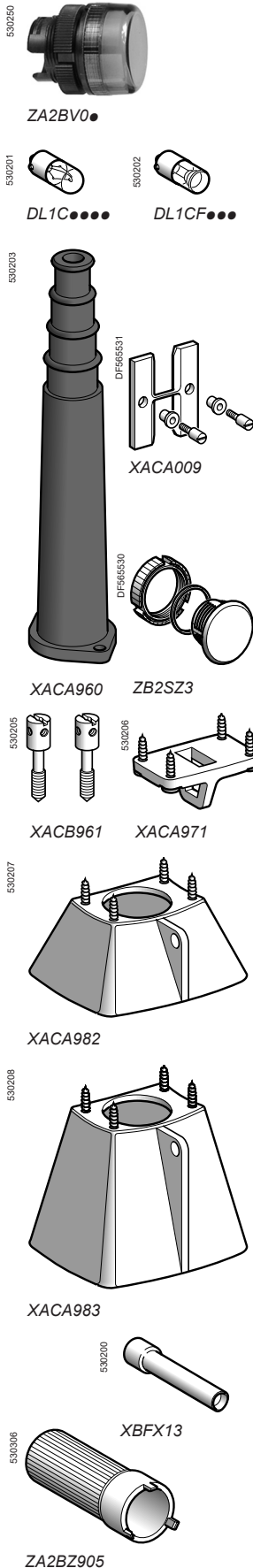

## Pilot light heads

Description	Colour	Reference	Weight kg
<b>For use with incandescent bulbs</b>			
Lens cap with bezel and fixing nut	White	ZA2BV01	0.015
	Green	ZA2BV03	0.015
	Red	ZA2BV04	0.015
	Yellow	ZA2BV05	0.015
	Blue	ZA2BV06	0.015
	Clear	ZA2BV07	0.015
	<b>For use with neon bulbs</b>		
Lens cap with bezel and fixing nut	Green	ZA2BV033	0.015
	Red	ZA2BV043	0.015
	Yellow	ZA2BV053	0.015
	Clear	ZA2BV073	0.015

## Bulbs

Description	Voltage	Sold in lots of	Unit reference	Weight kg
Incandescent BA 9s base fitting Maximum power: 2.6 W Maximum Ø: 11 mm Maximum length: 28 mm	6 V	10	DL1CB006	0.002
	12 V	10	DL1CE012	0.002
	24 V	10	DL1CE024	0.002
	48 V	10	DL1CE048	0.002
	130 V	10	DL1CE130	0.002
Neon BA 9s base fitting Maximum power: 2.6 W Maximum Ø: 11 mm Maximum length: 28 mm	110 V	10	DL1CF110	0.002
	230 V	10	DL1CF220	0.002
	400 V	10	DL1CF380	0.002

## Complementary accessories, tools

Description	Reference	Weight kg
Protective cable sleeve	For cable Ø 8 to 22 mm	XACA950 0.070
	For cable Ø 8 to 26 mm	XACA960 0.090
Mechanical interlock for 2 operators	With fixing screws	XACA009 0.003
Blanking plug	With seal and fixing nut	ZB2SZ3 0.005
Tightening tool for fixing nut	–	ZA2BZ905 0.060
Adaptor for self-supporting cable type BBAP	Mounted with protective sleeve for cable Ø 8 to 26 mm	XACB961 0.025
Lower support ring	–	XACA971 0.010
Protective guards for base mounted units	For selector switch (standard handle) or Emergency stop head pushbutton	XACA982 0.025
	For key switch or key release latching Emergency stop head pushbutton	XACA983 0.045
Bulb extractor	For BA 9s base fitting bulbs	XBFX13 0.025



# Pendant control stations

Double insulated, type XACA

For control circuits

Legends 30 x 40 mm with symbols conforming to NF E 52-124

5342019

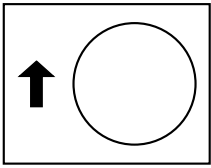

White background, black symbol

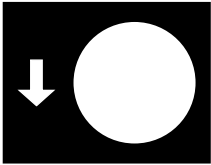



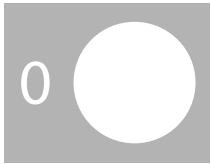



























Black background, white symbol



Red background, white symbol

3

Function Symbol	Reference	Weight kg	Function Symbol	Reference	Weight kg
	ZB2BY4901	0.001		ZB2BY2904	0.001
	ZB2BY4902	0.001		ZB2BY2905	0.001
	ZB2BY4903	0.001		ZB2BY2906	0.001
	ZB2BY4907	0.001		ZB2BY2910	0.001
	ZB2BY4908	0.001		ZB2BY2911	0.001
	ZB2BY4909	0.001		ZB2BY2912	0.001
	ZB2BY4913	0.001		ZB2BY2916	0.001
	ZB2BY4914	0.001		ZB2BY2917	0.001
	ZB2BY4915	0.001		ZB2BY2918	0.001
	ZB2BY4919	0.001		ZB2BY2922	0.001
	ZB2BY4920	0.001		ZB2BY2923	0.001
	ZB2BY4921	0.001		ZB2BY2924	0.001
	ZB2BY4933	0.001		ZB2BY4934	0.001
	ZB2BY4932	0.001		ZB2BY4935	0.001
	ZB2BY4930	0.001		ZB2BY2931	0.001

# Pendant control stations

## Double insulated, type XACA

### For control circuits

### Legends 30 x 40 mm

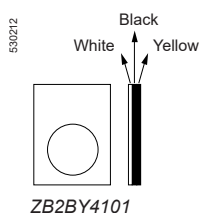
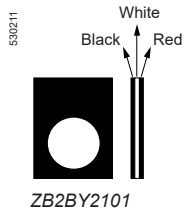

Text	Reference	Weight kg	Text	Reference	Weight kg
■ Start functions: white characters on black background					
■ Stop functions: white characters on red background					
<b>Blank</b>					
Black or red background	ZB2BY2101	0.001	White or yellow background	ZB2BY4101	0.001
<b>With English text</b>			<b>With French text</b>		
<b>For pushbuttons</b>			<b>For pushbuttons</b>		
Start	ZB2BY2303	0.001	Marche	ZB2BY2103	0.001
Stop	ZB2BY2304	0.001	Arrêt	ZB2BY2104	0.001
Forward	ZB2BY2305	0.001	Avant	ZB2BY2105	0.001
Reverse	ZB2BY2306	0.001	Arrière	ZB2BY2106	0.001
Up	ZB2BY2307	0.001	Montée	ZB2BY2107	0.001
Down	ZB2BY2308	0.001	Descente	ZB2BY2108	0.001
Right	ZB2BY2309	0.001	Droite	ZB2BY2109	0.001
Left	ZB2BY2310	0.001	Gauche	ZB2BY2110	0.001
On	ZB2BY2311	0.001	En service	ZB2BY2111	0.001
Off	ZB2BY2312	0.001	Hors service	ZB2BY2112	0.001
Power on	ZB2BY2326	0.001	Sous tension	ZB2BY2126	0.001
Slow	ZB2BY2327	0.001	Lent	ZB2BY2127	0.001
Fast	ZB2BY2328	0.001	Vite	ZB2BY2128	0.001
Klaxon	ZB2BY2125	0.001	Klaxon	ZB2BY2125	0.001
<b>For selector switches</b>			<b>For selector switches</b>		
-	-	0.001	Arrêt-Marche	ZB2BY2166	-
Off-On	ZB2BY2367	0.001	Hors-en	ZB2BY2167	0.001
<b>With special texts</b>					
■ Specify text when ordering,					
■ 2 lines maximum, 11 characters per line.					
White characters on black background	ZB2BY2002	0.001	Black characters on white background	ZB2BY4001	0.001
White characters on red background	ZB2BY2004	0.001	Black characters on yellow background	ZB2BY4005	0.001
<b>Other versions</b>	Legends with texts in other languages. Please consult our Customer Care Centre.				

# Pendant control stations

Double insulated, type XACA

For control circuits

Variable composition stations, factory assembled

3

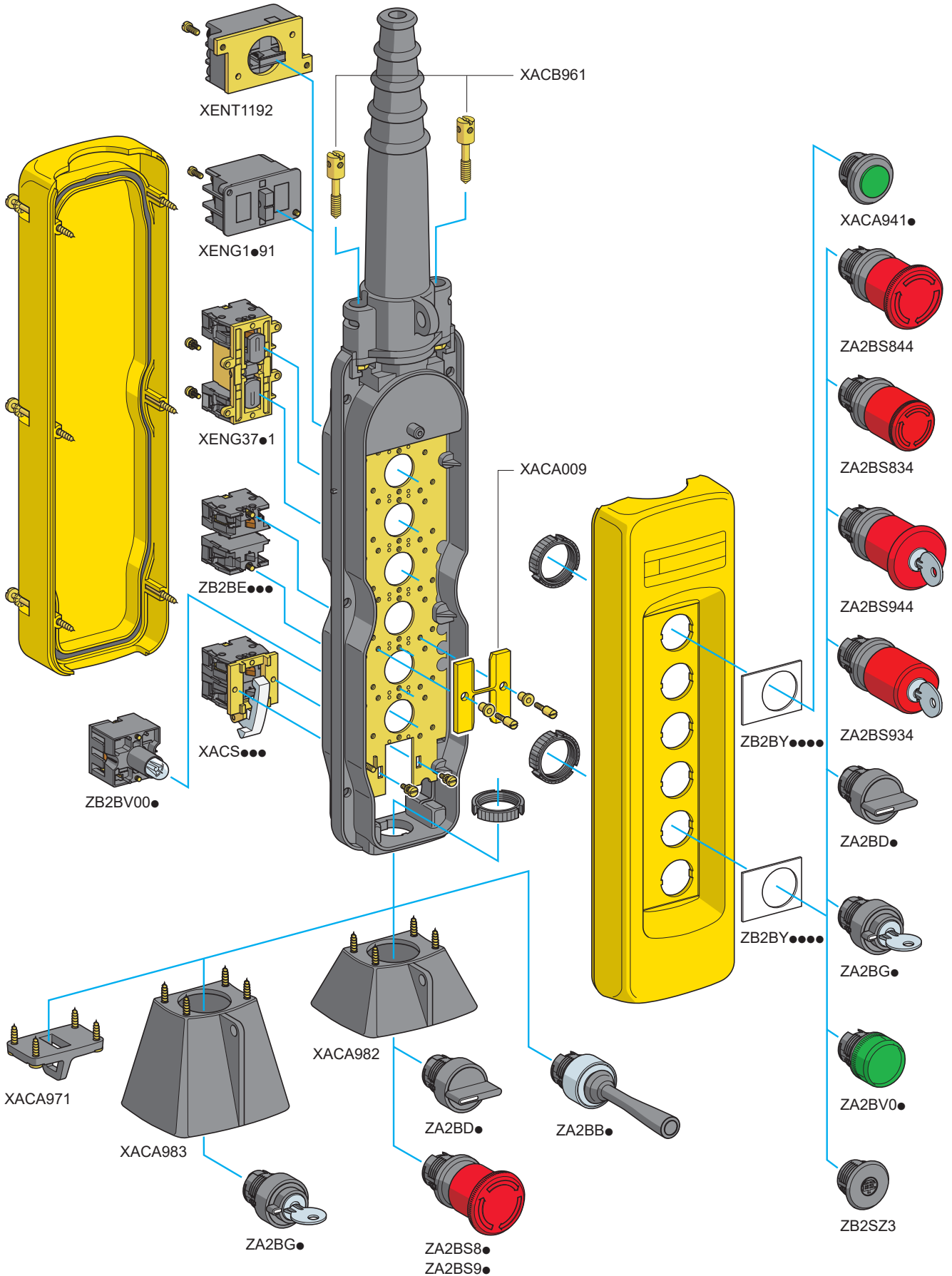

# Pendant control stations

Double insulated, type XACA  
For control circuits  
Variable composition stations, factory assembled

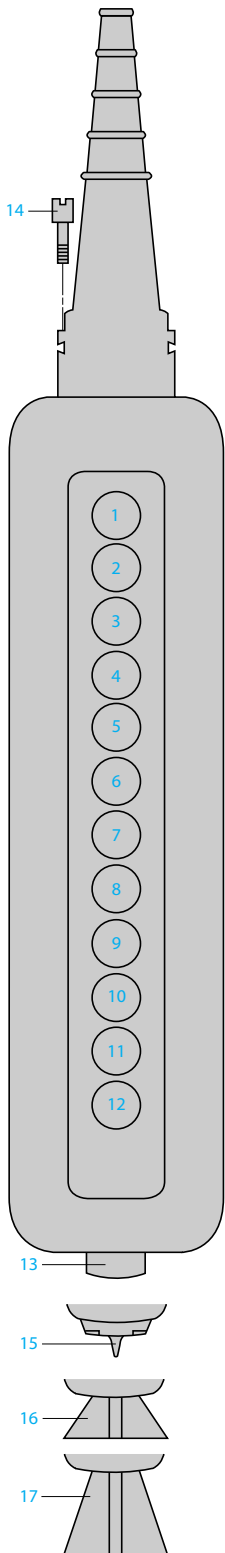

<b>Customer</b>			<b>Schneider Electric Industries</b>	
Company	Order N°	Delivery date	Sales office - Subsidiary Co.	Order N°

Enter the order with XACA09 reference

Unit reference of empty enclosure, see page 30075/5	Number of identical stations	Enclosure price (1)
XAC <input type="text" value="A"/> <input type="text" value=""/> <input type="text" value=""/>		

Legends see page 30075/10		Contact blocks or pilot light bodies see page 30075/6		Operating heads or pilot light heads or blanking plug see page 30075/8		Total price
Reference	Unit price	Reference	Unit price	Reference	Unit price	
1						
2						
3						
4						
5						
6						
7						
8						
9						
10						
11						
12						

Unit mounted in base of enclosure (if required) (Except when using XACA03 and XACA05)

13						
----	--	--	--	--	--	--

Complementary accessories, see page 30075/9 (cross the appropriate box or boxes)

Description	<input checked="" type="checkbox"/>	Reference	Unit price
14 Adaptor for self-supporting cable type BBAP for use with cable entry sleeve Ø 8 to 26 mm		XACB961	
15 Lower support ring		XACA971	
16 Protective guard for selector switch (std. handle) or Emergency stop head pushbutton, mounted in base		XACA982	
17 Protective guard for key switch or key release Emergency stop head pushbutton, mounted in base		XACA983	

Mechanical interlocking (2)

Reference	Quantity	Unit price
XACA009		
<b>Factory assembly:</b>		
Number of heads or blanking plugs to be fitted	<input type="text" value=""/> X	Additional cost XAC9VA for fitting of 1 head or 1 blanking plug
		<input type="text" value=""/>

Total price of assembled pendant station

(1) Obtain the empty enclosure price.  
(2) Connect with a line the 2 ways which require mechanical interlocking.

Examples: combinations possible

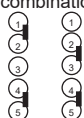

Combinations not possible



# Pendant control stations

Double insulated, type XACB  
For power circuits (direct switching)  
Complete stations "ready for use"



XACB219  
XACB220

XACB3195  
XACB3205



XACB491  
XACB493

XACB4916  
XACB4936

## For control of single-speed motors

Functions	Number of operators	Contact blocks Per direction	For Emergency stop	Maximum operational power/400 V	Reference	Weight kg
	2 mechanically interlocked	2-pole XESD1191(1)	–	2.2 kW	<a href="#">XACB219</a>	0.355
		3-pole XESD2201(1)	–	3 kW	<a href="#">XACB220</a>	0.355
	2 mechanically interlocked + 1 trigger action latching Emergency stop Ø 40 mm operator ZA2BS844	2-pole XESD1191(1)	1 N/C + N/C + N/C XACS499	2.2 kW	<a href="#">XACB3195</a>	0.940
		3-pole XESD2201(1)	1 N/C + N/C + N/C XACS499	3 kW	<a href="#">XACB3205</a>	1.000
	4 mechanically interlocked between pairs	2-pole XESD1191(1)	–	2.2 kW	<a href="#">XACB491</a>	1.200
		3-pole XESD2201(1)	–	3 kW	<a href="#">XACB493</a>	1.330

(1) Trigger action mechanically latching Emergency stop pushbuttons conform to standards EN/IEC 60204-32, EN/ISO 13850, Machinery directive 98/37/EC and standard EN/IEC 60947-5-5.

# Pendant control stations

Double insulated, type XACB  
For power circuits (direct switching)  
Complete stations "ready for use"

DF565573



XACB691  
XACB693

For control of single-speed motors (continued)							
Functions	Number of operators	Contact blocks	Per direction	For Emergency stop	Maximum operational power/400 V	Reference	Weight kg
	6 mechanically interlocked between pairs	2-pole XESD1191(1)		-	2.2 kW	XACB691	1.350

DF565574



XACB6916  
XACB6936

DF565575



XACB6915  
XACB6935

For control of 2-speed motors							
Functions	Number of operators	Contact blocks	Per direction	For Emergency stop	Maximum operational power/400 V	Reference	Weight kg
	2 mechanically interlocked	2-pole XESD1291(1)		-	2.2 kW	XACB229	0.405

2 mechanically interlocked + 1 trigger action latching Emergency stop Ø 40 mm operator ZA2BS844	2-pole XESD1291(1)	1 N/C + N/C + N/C XACS499		-	2.2 kW	XACB3295 ▲	0.990
---	--------------------	---------------------------	--	---	--------	------------	-------

DF565576



XACB229

DF565577



XACB3295

(1) Trigger action mechanically latching Emergency stop pushbuttons conform to standards EN/IEC 60204-32, EN/ISO 13850, Machinery directive 98/37/EC and standard EN/IEC 60947-5-5.

▲ Available 4<sup>th</sup> quarter of 2013

# Pendant control stations

Double insulated, type XACB

For power circuits

Empty enclosures

DF56580



XACB02●●

22189SE



XACB04●●

3

DF56582



XACB06●●

22189SE



XACB08●●

DF56584



XACB12●●

DF56585



XACB120

## Empty enclosures for control circuits or power circuits (1)

Description	Protective cable sleeve	Number of cut-outs	Cut-out in base of enclosure	Reference	Weight kg
<b>Empty enclosures (1)</b> <b>Double insulated for "Small hoist" applications</b> Operator cut-out centres: 40 mm	For cable Ø 7...13 mm	2	Without	<a href="#">XACB020</a>	0.760
		3	Without	<a href="#">XACB030</a>	0.760
<b>Empty enclosures (1)</b> <b>Double insulated for "General purpose" applications</b> Operator cut-out centres: 40 mm	For cable Ø 10...22 mm	2	Without	<a href="#">XACB02</a>	0.760
			With	<a href="#">XACB021</a>	0.760
		4	Without	<a href="#">XACB04</a>	1.000
			With	<a href="#">XACB041</a>	1.000
		6	Without	<a href="#">XACB06</a>	1.160
			With	<a href="#">XACB061</a>	1.160
		8	Without	<a href="#">XACB08</a>	1.330
			With	<a href="#">XACB081</a>	1.330
12 in 2 rows of 6	Without	<a href="#">XACB12</a>	1.460		
	With	<a href="#">XACB121</a>	1.460		
For cable Ø 22...35 mm		2	Without	<a href="#">XACB025</a>	0.960
			4	Without	<a href="#">XACB045</a>
		4	With	<a href="#">XACB0415</a>	1.200
			6	Without	<a href="#">XACB065</a>
		8	Without	<a href="#">XACB085</a>	1.530
			With	<a href="#">XACB0815</a>	1.530
		12 in 2 rows of 6	Without	<a href="#">XACB125</a>	1.660
			With	<a href="#">XACB1215</a>	1.660

## Empty enclosures for control circuits (1)

Description	Protective cable sleeve	Number of cut-outs	Cut-out in base of enclosure	Reference	Weight kg
<b>Empty enclosures (1)</b> <b>Double insulated for "General purpose" applications</b> Operator cut-out centres: 30 mm	For cable Ø 10...22 mm	12 in 1 row	Without	<a href="#">XACB120</a>	1.330
			With	<a href="#">XACB1201</a>	1.330
Operator cut-out centres: 30 mm	For cable Ø 22...35 mm	12 in 1 row	Without	<a href="#">XACB1205</a>	1.530

## Variable composition stations, factory assembled

Use the order form on [page 3/24](#) to define the required configuration

**Equipment:** contact blocks, operating heads (control and signalling), complementary accessories

(1) Enclosure comprising:

- the enclosure,
- protective cable sleeve,
- cable tie (for tightening sleeve onto cable): for cable Ø 7...13 mm, Ø 10...22 mm or Ø 22...35 mm,
- internal cable clamp,
- suspension ring,
- bezel tightening key.

# Pendant control stations

Double insulated, type XACB

For power circuits (direct switching)

Separate components and spare parts

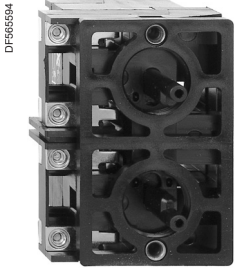

XESD1191

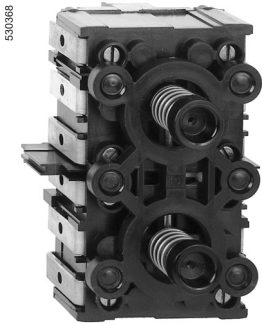

XESD2201

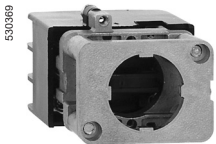

XACS399

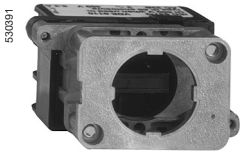

XACS499

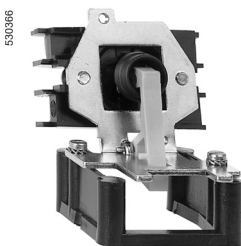

XACS399

## Contact blocks, snap action

Description	Application	Function	Max. power/400 V	Scheme	Reference	Weight kg
<b>Double block 2-pole</b> 2 spring return operators mechanically interlocked (operator centres: 40 mm)	Single-speed	N/O + N/O	2.2 kW		XESD1191	0.140
	2-speed	N/O + N/O + 1 C/O staggered auxiliary contact (1)	2.2 kW		XESD1291	0.190
<b>Double block 3-pole</b> 2 spring return operators mechanically interlocked (operator centres: 40 mm)	Single-speed	N/O + N/O + N/O	3 kW		XESD2201	0.200
		N/O + N/O + N/O + 1 N/O simultaneous auxiliary contact (1)	3 kW		XESD2241	0.210

## Isolating block, slow break

In the interests of safety, it is imperative that these isolating blocks only be used with a stay put or latching type operating head to ensure complete isolation when the pendant station is not in use.

Mounting position	Application	Function	Max. power/400 V	Scheme	Reference	Weight kg
On front 40 mm centres (2)	Emergency stop	N/C + N/C + N/C with positive opening operation	3 kW		XACS399	0.100
On front 30 mm centres (2)	Emergency stop	N/C + N/C + N/C with positive opening operation	3 kW		XACS499	0.100

(1) Auxiliary contacts are slow break.

(2) Mounting with operating heads ZA2B●●●, except ZA2BD● and ZA2BG● (see page 3/19).

(3) Mounting with operating head ZA2BS944 (see page 3/19).



# Pendant control stations

Double insulated, type XACB

Fo power circuits

Separate components and spare parts



XACB911●

Booted operators							
For use with contact block	Travel	Operating temperature	Colour of insert	Sold in lots of	Unit reference	Weight kg	
XENB●●●●	4 mm	- 25...+ 70 °C (1)	White	10	XACB9111	0.005	
XENC●●●●			Black	10	XACB9112	0.005	
XEND●●●●			Green	10	XACB9113	0.005	
XESB2011			Red	10	XACB9114	0.005	
XESD2201			Yellow	10	XACB9115	0.005	
XESD2241			Blue	10	XACB9116	0.005	
XESD2251			- 40...+ 70 °C (2)	White	10	XACB9121	0.005
			Black	10	XACB9122	0.005	
			Yellow	10	XACB9125	0.005	

3

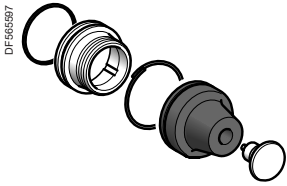

XACB921●

XESD1181	16 mm	- 25...+ 70 °C (1)	White	10	XACB9211	0.005	
XESD1191			Black	10	XACB9212	0.005	
XESD1281			Green	10	XACB9213	0.005	
XESD1291			Red	10	XACB9214	0.005	
			Yellow	10	XACB9215	0.005	
			Blue	10	XACB9216	0.005	
			- 40...+ 70 °C (2)	White	10	XACB9221	0.005
			Black	10	XACB9222	0.005	
			Green	10	XACB9223	0.005	
			Yellow	10	XACB9225	0.005	
	Blue	10	XACB9226	0.005			



ZA2BP●

Booted operators (silicone boot)				
For use with contact block	Operating temperature	Colour of boot	Reference	Weight kg
XACS41●	- 25...+ 70 °C	Blue	ZA2BP6	0.015

(1) Polychloroprene boots.  
(2) Silicone boots.

# Pendant control stations

Double insulated, type XACB

For power circuits

Separate components and spare parts



ZA2BS844



ZA2BS944



ZA2BD●



ZA2BG●



ZA2BB2

## Operating heads for front or base mounting (1)

Description	Colour	Type	Reference	Weight kg
<b>Trigger action latching Emergency stop (2)</b>	Red	Ø 30 mm	<a href="#">ZA2BS834</a>	0.028
Turn to release (Emergency stop function)		Ø 40 mm	<a href="#">ZA2BS844</a>	0.033
<b>Trigger action latching Emergency stop (2) (3)</b>	Red	Ø 30 mm	<a href="#">ZA2BS934</a>	0.060
Key release (n° 455) Key withdrawal in rest (unactuated) position (Emergency stop function)		Ø 40 mm	<a href="#">ZA2BS944</a>	0.065
<b>Selector switches, standard handle (4)</b>	Black	2 position, stay put 3 position, stay put (5)	<a href="#">ZA2BD2</a> <a href="#">ZA2BD3</a>	0.018 0.018
<b>Key switches</b> (key n° 455) (3) Key withdrawal in left and right-hand positions	–	2 position, stay put 3 position, stay put (5)	<a href="#">ZA2BG4</a> <a href="#">ZA2BG5</a>	0.042 0.042
<b>Key switches</b> (key n° 455) (3) Key withdrawal in left-hand position	–	2 position, stay put	<a href="#">ZA2BG2</a>	0.042
<b>Key switches</b> (key n° 455) (3) Spring return from right to left Key withdrawal in left-hand position	–	2 position	<a href="#">ZA2BG6</a>	0.042
<b>Key switches</b> (key n° 455) (4) (3) Key withdrawal in centre position	–	3 position, stay put (5)	<a href="#">ZA2BG3</a>	0.042
<b>Wobblesticks (6)</b> Operates in all directions for fast stop	Black	–	<a href="#">ZA2BB2</a>	0.060

## Pilot light heads

Description	Colour	Reference	Weight kg
<b>For use with incandescent bulbs</b>			
<b>Lens cap with fixing bezel</b>	White	<a href="#">ZA2BV01</a>	0.015
	Green	<a href="#">ZA2BV03</a>	0.015
	Red	<a href="#">ZA2BV04</a>	0.015
	Yellow	<a href="#">ZA2BV05</a>	0.015
	Blue	<a href="#">ZA2BV06</a>	0.015
	Clear	<a href="#">ZA2BV07</a>	0.015
<b>For use with neon bulbs</b>			
<b>Lens cap with fixing bezel</b>	Green	<a href="#">ZA2BV033</a>	0.015
	Red	<a href="#">ZA2BV043</a>	0.015
	Yellow	<a href="#">ZA2BV053</a>	0.015
	Clear	<a href="#">ZA2BV073</a>	0.015

(1) The technical characteristics of pendant control stations XACB can only be guaranteed by using the operating heads ZA2B●● listed above.

(2) Trigger action mechanically latching Emergency stop pushbuttons conform to standards EN/IEC 60204-32, EN/ISO 13850, Machinery directive 98/37/EC and standard EN/IEC 60947-5-5.

(3) Other key numbers available on request, please consult our Customer Care Centre.

(4) Selector switches or key switches with other mechanical functions: please consult our Customer Care Centre.

(5) Only suitable for front mounting.

(6) Base mounting recommended.



ZA2BV0●

# Pendant control stations

Double insulated, type XACB

For power circuits

Separate components and spare parts



530307

DL1C●●●●



530308

DL1CF●●●●



530311

XACB91●



530310

XACB92●



530309

XACB90●

## Bulbs

Description	Voltage	Sold in lots of	Unit reference	Weight kg
<b>Incandescent</b> BA 9s base fitting Maximum power: 2.6 W Maximum Ø: 11 mm Maximum length: 28 mm	6 V	10	DL1CB006	0.002
	12 V	10	DL1CE012	0.002
	24 V	10	DL1CE024	0.002
	48 V	10	DL1CE048	0.002
	130 V	10	DL1CE130	0.002
<b>Neon</b> BA 9s base fitting Maximum power: 2.6 W Maximum Ø: 11 mm Maximum length: 28 mm	120 V	10	DL1CF110	0.002
	230 V	10	DL1CF220	0.002
	400 V	10	DL1CF380	0.002

## Accessories for booted operators

Description	Travel	Material/ Colour	Operating temperature	Sold in lots of	Unit reference	Weight kg
<b>Boots with circlip, without coloured insert</b>	4 mm	Polychloroprene	- 25...+ 70° C	10	XACB911	0.002
		Silicone	- 40...+ 70° C	10	XACB912	0.002
	16 mm	Polychloroprene	- 25...+ 70° C	10	XACB921	0.002
		Silicone	- 40...+ 70° C	10	XACB922	0.002
<b>Coloured inserts for booted operators (4 and 16 mm travel)</b>		White	–	10	XACB901	0.001
		Black	–	10	XACB902	0.001

# Pendant control stations

Double insulated, type XACB

For control or power circuits

Separate components and spare parts

530312

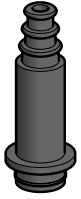

XACB913

530313

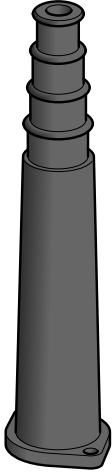

XACB960

DF565604

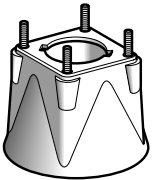

XACB982

530319



XACX905

## Complementary accessories

Description	For use with	Diameter of cable	Reference	Weight kg
<b>Protective cable sleeve</b> with cable tie (for tightening sleeve onto cable)	Enclosures XACB219 and XACB220 (2 operators)	Ø 7...13 mm	<a href="#">XACB913</a>	0.065
	Enclosures XACB●●● with 4 to 12 operators	Ø 10...22 mm	<a href="#">XACB960</a>	0.110
<b>Blanking plug</b> with seal and fixing nut	—		<a href="#">ZB2SZ3</a>	0.005
<b>Adaptor</b> for use with protective cable sleeve for cable Ø 10...22 mm	Self-supporting cable type BBAP		<a href="#">XACB961</a>	0.025
<b>Protective guards</b> for base mounted units	Emergency stop pushbutton		<a href="#">XACB982</a>	0.050

## Tools

Description	For use with	Reference	Weight kg
<b>Tightening key</b>	Units mounted in base of enclosure	<a href="#">XACX905</a>	0.015
<b>Bulb extractor</b>	BA 9s base fitting bulbs	<a href="#">XBFX13</a>	0.003

# Pendant control stations

Double insulated, type XACB

For control or power circuits

Legends 30 x 40 mm (with symbols conforming to NF E 52-124)

3

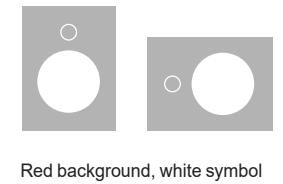
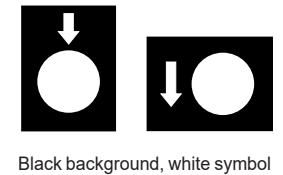
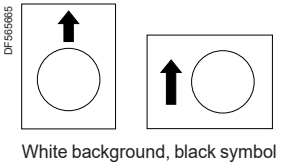
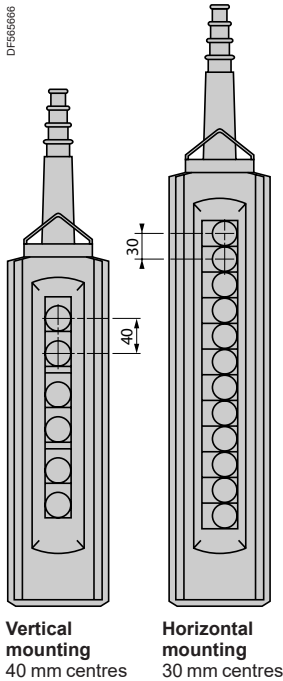

Symbol Reference	Symbol	Reference	Weight kg
<b>Vertical mounting 40 mm centres</b>			
<b>Horizontal mounting 30 mm centres</b>			
<b>Raise, slow</b>			
ZB2BY4951		ZB2BY4901	0.001
<b>Raise, fast</b>			
ZB2BY4952		ZB2BY4902	0.001
<b>Raise, slow-fast</b>			
ZB2BY4953		ZB2BY4903	0.001
<b>Right, slow</b>			
ZB2BY4901		ZB2BY4907	0.001
<b>Right, fast</b>			
ZB2BY4902		ZB2BY4908	0.001
<b>Right, slow-fast</b>			
ZB2BY4903		ZB2BY4909	0.001
<b>Forward, slow</b>			
ZB2BY4963		ZB2BY4913	0.001
<b>Forward, fast</b>			
ZB2BY4964		ZB2BY4914	0.001
<b>Forward, slow-fast</b>			
ZB2BY4965		ZB2BY4915	0.001
<b>Slew right, slow</b>			
ZB2BY4919		ZB2BY4919	0.001
<b>Slew right, fast</b>			
ZB2BY4920		ZB2BY4920	0.001
<b>Slew right, slow-fast</b>			
ZB2BY4921		ZB2BY4921	0.001
<b>Slow</b>			
ZB2BY4933		ZB2BY4933	0.001
<b>Klaxon</b>			
ZB2BY4982		ZB2BY4932	0.001
<b>Start</b>			
ZB2BY4980		ZB2BY4930	0.001

Symbol Reference	Symbol	Reference	Weight kg
<b>Vertical mounting 40 mm centres</b>			
<b>Horizontal mounting 30 mm centres</b>			
<b>Lower, slow</b>			
ZB2BY2954		ZB2BY2904	0.001
<b>Lower, fast</b>			
ZB2BY2955		ZB2BY2905	0.001
<b>Lower, slow-fast</b>			
ZB2BY2956		ZB2BY2906	0.001
<b>Left, slow</b>			
ZB2BY2904		ZB2BY2910	0.001
<b>Left, fast</b>			
ZB2BY2905		ZB2BY2911	0.001
<b>Left, slow-fast</b>			
ZB2BY2906		ZB2BY2912	0.001
<b>Reverse, slow</b>			
ZB2BY2966		ZB2BY2916	0.001
<b>Reverse, fast</b>			
ZB2BY2967		ZB2BY2917	0.001
<b>Reverse, slow-fast</b>			
ZB2BY2968		ZB2BY2918	0.001
<b>Slew left, slow</b>			
ZB2BY2922		ZB2BY2922	0.001
<b>Slew left, fast</b>			
ZB2BY2923		ZB2BY2923	0.001
<b>Slew left, slow-fast</b>			
ZB2BY2924		ZB2BY2924	0.001
<b>Fast</b>			
ZB2BY4934		ZB2BY4934	0.001
<b>Start-Klaxon</b>			
ZB2BY4985		ZB2BY4935	0.001
<b>Stop</b>			
ZB2BY2931		ZB2BY2931	0.001



# Pendant control stations

Double insulated, type XACB  
For control or power circuits  
Variable composition stations, factory assembled

3

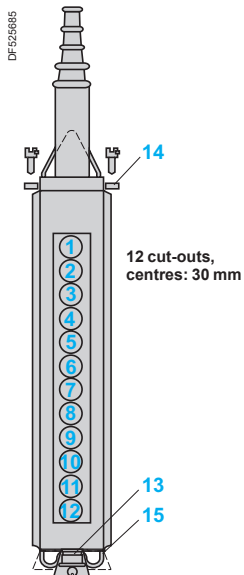
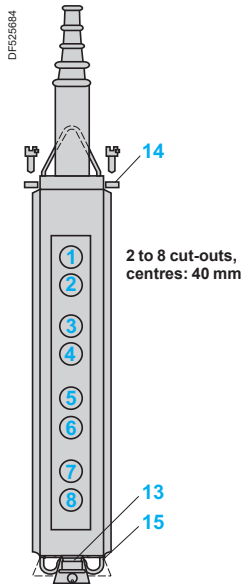
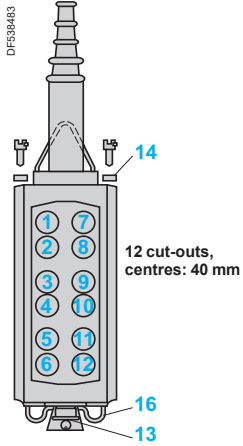

<b>Customer</b>			<b>Schneider Electric Industries</b>	
Company	Order N°	Delivery date	Sales office - Subsidiary Co.	Order N°

Enter the order with XACB09 reference

<b>Unit reference of empty enclosure</b> see page 30076/5	<b>Number of identical stations</b>	<b>Enclosure price (1)</b>
XAC B 0 9		

<b>Legends</b> see page 30076/17	<b>Contact blocks or pilot light bodies</b> see page 30076/6	<b>Operating heads or pilot light heads or blanking plug</b> see page 30076/11
-------------------------------------	---	---

Reference	Unit price	Reference	Unit price	Reference	Unit price	Total price
1						
2						
3						
4						
5						
6						
7						
8						
9						
10						
11						
12						

Unit mounted in base of enclosure (if required)

13						
----	--	--	--	--	--	--

Factory assembled:

Number of heads or blanking plugs to be fitted

X

Additional cost XAC9VA for fitting of 1 head or 1 blanking plug



Complementary accessories, see page 30076/14 (cross the appropriate box or boxes)

Description	<input checked="" type="checkbox"/>	Reference	Unit price
14 Adaptor for self-supporting cable type BBAP for use with cable entry sleeve Ø 10 to 22 mm		XACB961	
15 Lower support ring for single row enclosures		XACB971	
15 Lower support ring for 2 row enclosures		XACB972	
16 Protective guard for key release latching mushroom head pushbutton, mounted in base		XACB982	

Total price of assembled pendant station

(1) Obtain the empty enclosure price.

■ Product reference index..... 4/2



<b>D</b>							
DL1CB006	3/9 3/20	XACA4923	3/4	XACB3205	3/14	XEDS2111	2/5
DL1CE012	3/9 3/20	XACA49231	3/4	XACB3295	3/15	XEDS2121	2/5
DL1CE024	3/9 3/20	XACA671	3/3	XACB491	3/14	XEDS2231	2/5
DL1CE048	3/9 3/20	XACA6713	3/3	XACB493	3/14	XEDS3111	2/5
DL1CE130	3/9 3/20	XACA67141	3/3	XACB691	3/15	XEDS3121	2/5
DL1CF110	3/9 3/20	XACA681	3/3	XACB901	3/20	XEDS3231	2/5
DL1CF220	3/9 3/20	XACA6813	3/3	XACB902	3/20	XEDS3241	2/5
DL1CF380	3/9 3/20	XACA68141	3/3	XACB911	3/20	XENG1191	3/6
<b>X</b>		XACA871	3/3	XACB9111	3/18	XENG1491	3/6
XACA009	3/9	XACA881	3/3	XACB9112	3/18	XENG3781	3/6
XACA02	3/5	XACA913	3/3	XACB9113	3/18	XENG3791	3/6
XACA03	3/5	XACA923	3/3	XACB9114	3/18	XENT1192	3/6
XACA04	3/5	XACA924	3/3	XACB9115	3/18	XENT1991	2/5
XACA05	3/5	XACA9411	3/8	XACB9116	3/18	XESD1191	3/17
XACA06	3/5	XACA9412	3/8	XACB9116	3/18	XESD1291	3/17
XACA08	3/5	XACA9413	3/8	XACB912	3/20	XESD1291	3/17
XACA12	3/5	XACA9414	3/8	XACB9121	3/18	XESD2201	3/17
XACA201	2/2	XACA9415	3/8	XACB9122	3/18	XESD2241	3/17
XACA2013	2/2	XACA9416	3/8	XACB9125	3/18	<b>Z</b>	
XACA205	2/2	XACA9419	3/8	XACB913	3/21	ZA2BB2	3/8 3/19
XACA2053	2/2	XACA950	3/9	XACB921	3/18	ZA2BD3	3/8 3/19
XACA207	2/3	XACA960	3/9	XACB9211	3/18	ZA2BG2	2/6 3/8 3/19
XACA2073	2/3	XACA971	3/9	XACB9212	3/18	ZA2BG3	2/6 3/8 3/19
XACA211	2/2	XACA982	3/9	XACB9213	3/18	ZA2BG4	2/6 3/8 3/19
XACA2113	2/2	XACA983	3/9	XACB9214	3/18	ZA2BG5	2/6 3/8 3/19
XACA215	2/2	XACA983	3/9	XACB9215	3/18	ZA2BG6	2/6 3/8 3/19
XACA2153	2/2	XACB02	3/16	XACB9216	3/18	ZA2BP6	3/18
XACA217	2/3	XACB020	3/16	XACB922	3/18 3/20	ZA2BS834	3/8 3/19
XACA2173	2/3	XACB021	3/16	XACB9221	3/18	ZA2BS844	3/8 3/19
XACA271	3/2	XACB025	3/16	XACB9222	3/18	ZA2BS934	2/6 3/8 3/19
XACA2713	3/2	XACB030	3/16	XACB9223	3/18	ZA2BS944	3/8 3/19
XACA27131	3/2	XACB04	3/16	XACB9225	3/18	ZA2BV01	3/9 3/19
XACA281	3/2	XACB041	3/16	XACB9226	3/18	ZA2BV03	3/9 3/19
XACA28131	3/2	XACB0415	3/16	XACB9226	3/18	ZA2BV033	3/9 3/19
XACA291	3/4	XACB045	3/16	XACB960	3/21	ZA2BV04	3/9 3/19
XACA471	3/2	XACB06	3/16	XACB961	3/9 3/21	ZA2BV043	3/9 3/19
XACA4713	3/2	XACB061	3/16	XACB982	3/21	ZA2BV05	3/9 3/19
XACA47131	3/2	XACB065	3/16	XACD022	2/5	ZA2BV053	3/9 3/19
XACA481	3/2	XACB08	3/16	XACD21A0101	2/4		
XACA4813	3/2	XACB081	3/16	XACD24A0105	2/4		
XACA48131	3/2	XACB0815	3/16	XACD901	2/6		
XACA491	3/4	XACB085	3/16	XACS101	3/7		
XACA4913	3/4	XACB12	3/16	XACS102	3/7		
XACA49131	3/4	XACB120	3/16	XACS103	3/7		
XACA492	3/4	XACB1201	3/16	XACS104	3/7		
		XACB1205	3/16	XACS105	3/7		
		XACB121	3/16	XACS399	3/17		
		XACB1215	3/16	XACS499	3/17		
		XACB125	3/16	XACX905	3/21		
		XACB219	3/14	XBFX13	3/9 3/21		
		XACB220	3/14	XEDS1231	2/5		
		XACB229	3/15	XEDS1241	2/5		
		XACB3195	3/14				
						ZA2BV06	3/9 3/19
						ZA2BV07	3/9 3/19
						ZA2BV073	3/9 3/19
						ZA2BZ905	3/9
						ZB2BE101	2/3 2/5 3/6
						ZB2BE102	2/3 2/5 3/6
						ZB2BE201	2/3
						ZB2BV006	3/7
						ZB2BY2002	3/11
						ZB2BY2004	3/11
						ZB2BY2101	3/11
						ZB2BY2103	3/11
						ZB2BY2104	3/11
						ZB2BY2105	3/11
						ZB2BY2106	3/11
						ZB2BY2107	3/11
						ZB2BY2108	3/11
						ZB2BY2109	3/11
						ZB2BY2110	3/11
						ZB2BY2111	3/11
						ZB2BY2112	3/11
						ZB2BY2125	3/11
						ZB2BY2126	3/11
						ZB2BY2127	3/11
						ZB2BY2128	3/11
						ZB2BY2166	3/11
						ZB2BY2167	3/11
						ZB2BY2303	3/11
						ZB2BY2304	3/11
						ZB2BY2305	3/11
						ZB2BY2306	3/11
						ZB2BY2307	3/11
						ZB2BY2308	3/11
						ZB2BY2309	3/11
						ZB2BY2310	3/11
						ZB2BY2311	3/11
						ZB2BY2312	3/11
						ZB2BY2326	3/11
						ZB2BY2327	3/11
						ZB2BY2328	3/11
						ZB2BY2367	3/11
						ZB2BY2904	3/10 3/22
						ZB2BY2905	3/10 3/22
						ZB2BY2906	3/10 3/22
						ZB2BY2910	3/10 3/22

ZB2BY2911	3/10 3/22	ZB2BY4951	3/22
ZB2BY2912	3/10 3/22	ZB2BY4952	3/22
ZB2BY2916	3/10 3/22	ZB2BY4953	3/22
ZB2BY2917	3/10 3/22	ZB2BY4963	3/22
ZB2BY2918	3/10 3/22	ZB2BY4964	3/22
ZB2BY2922	3/10 3/22	ZB2BY4965	3/22
ZB2BY2923	3/10 3/22	ZB2BY4980	3/22
ZB2BY2924	3/10 3/22	ZB2BY4982	3/22
ZB2BY2931	3/10 3/22	ZB2BY4985	3/22
ZB2BY2954	3/22	ZB2SZ3	3/9 3/21
ZB2BY2955	3/22		
ZB2BY2956	3/22		
ZB2BY2966	3/22		
ZB2BY2967	3/22		
ZB2BY2968	3/22		
ZB2BY4001	3/11		
ZB2BY4005	3/11		
ZB2BY4101	3/11		
ZB2BY4901	3/10 3/22		
ZB2BY4902	3/10 3/22		
ZB2BY4903	3/10 3/22		
ZB2BY4907	3/10 3/22		
ZB2BY4908	3/10 3/22		
ZB2BY4909	3/10 3/22		
ZB2BY4913	3/10 3/22		
ZB2BY4914	3/10 3/22		
ZB2BY4915	3/10 3/22		
ZB2BY4919	3/10 3/22		
ZB2BY4920	3/10 3/22		
ZB2BY4921	3/10 3/22		
ZB2BY4930	3/10 3/22		
ZB2BY4932	3/10 3/22		
ZB2BY4933	3/10 3/22		
ZB2BY4934	3/10 3/22		
ZB2BY4935	3/10 3/22		



Learn more about our products at  
[www.se.com](http://www.se.com)

The information provided in this documentation contains general descriptions and/or technical characteristics of the performance of the products contained herein. This documentation is not intended as a substitute for and is not to be used for determining suitability or reliability of these products for specific user applications. It is the duty of any such user or integrator to perform the appropriate and complete risk analysis, evaluation and testing of the products with respect to the relevant specific application or use thereof. Neither Schneider Electric nor any of its affiliates or subsidiaries shall be responsible or liable for misuse of the information contained herein.

Design: Schneider Electric  
Photos: Schneider Electric

**Schneider Electric Industries SAS**

Head Office  
35, rue Joseph Monier - CS 30323  
F-92500 Rueil-Malmaison Cedex  
France

DIA5ED2130507EN  
February 2024 - V3.0