

# Operation Manual

## Smart-UPS<sup>™</sup> X Uninterruptible Power Supply

Low Voltage 100-127 VA

SMX2000LV / SMX2000LVNC  
SMX2000LVUS / SMX2000LVNCUS  
SMX3000LV / SMX3000LVNC  
SMX3000LVUS / SMX3000LVNCUS

High Voltage 200-240 VA

SMX2200HV / SMX2200HVNC  
SMX3000HV / SMX3000HVNC  
SMX3000HVT / SMX3000HVUS

**Tower/Rack- Mount 4U**

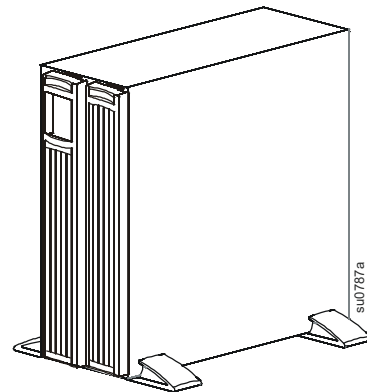

# Legal Information

---

The APC brand and any trademarks of Schneider Electric SE and its subsidiaries referred to in this guide are the property of Schneider Electric SE or its subsidiaries. All other brands may be trademarks of their respective owners.

This guide and its content are protected under applicable copyright laws and furnished for informational use only. No part of this guide may be reproduced or transmitted in any form or by any means (electronic, mechanical, photocopying, recording, or otherwise), for any purpose, without the prior written permission of APC.

APC does not grant any right or license for commercial use of the guide or its content, except for a non-exclusive and personal license to consult it on an "as is" basis. APC products and equipment should be installed, operated, serviced, and maintained only by qualified personnel.

As standards, specifications, and designs change from time to time, information contained in this guide may be subject to change without notice.

To the extent permitted by applicable law, no responsibility or liability is assumed by APC and its subsidiaries for any errors or omissions in the informational content of this material or consequences arising out of or resulting from the use of the information contained herein.

# IMPORTANT SAFETY INSTRUCTIONS

SAVE THESE INSTRUCTIONS - This manual contains important instructions that should be followed during installation and maintenance of the Smart-UPS and batteries.



Read the Safety Guide supplied with the equipment to become familiar with the safety requirements before trying to install or operate the UPS.

Read the user documentation to become familiar with the equipment before trying to install or operate it.

The following special messages may appear throughout this document or on the equipment to warn of potential hazards or to call attention to information that clarifies or simplifies a procedure.



The addition of this symbol either to a “Danger” or “Warning” safety label indicates that an electrical hazard exists which will result in personal injury if the instructions are not followed.



This is the safety alert symbol. It is used to alert you to potential personal injury hazards. Obey all safety messages that follow this symbol to avoid possible injury or death.

## DANGER

**DANGER** indicates a hazardous situation which, if not avoided, **will result in** death or serious injury.

## WARNING

**WARNING** indicates a hazardous situation which, if not avoided, **can result in** death or serious injury.

## CAUTION

**CAUTION** indicates a hazardous situation which, if not avoided, **can result in** minor or moderate injury.

## NOTICE

**NOTICE** is used to address practices not related to physical injury.

## Product Handling Guidelines



<18 kg  
<40 lb



18-32 kg  
40-70 lb



32-55 kg  
70-120 lb



>55 kg  
>120 lb



# Safety and General Information

Inspect the package contents upon receipt. Notify the carrier and dealer if there is any damage.

Additional safety information can be found in the safety Guide supplied with this unit.

- Adhere to all local and national electrical codes.
- Do not work alone under hazardous conditions.
- All wiring must be performed by a qualified electrician.
- Changes and modifications to this unit not expressly approved by APC by Schneider Electric could void the warranty.
- This equipment is intended for indoor use only.
- Always install peripheral equipment above the UPS in rack-mount configurations.
- The UPS is intended for IT environments. Do not operate this unit in direct sunlight, in contact with fluids, or where there is excessive dust or humidity.
- Be sure the air vents on the UPS are not blocked. Allow adequate space for proper ventilation.
- For a UPS with a factory installed power cord, connect the UPS power cable directly to a wall outlet. Do not use surge protectors or extension cords.
- The equipment is heavy. Always practice safe lifting techniques adequate for the weight of the equipment.

## Battery Safety

### CAUTION

#### **RISK OF HYDROGEN SULPHIDE GAS AND EXCESSIVE SMOKE**

- Replace the battery at least every 5 years or at the end of its service life, whichever is earlier.
- Replace the battery immediately when the UPS indicates battery replacement is necessary.
- Replace batteries with the same number and type of batteries as originally installed in the equipment.
- Replace the battery immediately when the UPS indicates a battery over-temperature condition, or when there is evidence of electrolyte leakage. Power off the UPS, unplug it from the AC input, and disconnect the batteries. Do not operate the UPS until the batteries have been replaced.
- \*Replace all battery modules (including the modules in External Battery Packs) which are older than one year, when installing additional battery packs or replacing the battery module(s).

**Failure to follow these instructions can result in minor or moderate injury and equipment damage.**

\*Contact APC by Schneider Electric Worldwide Customer Support to determine the age of the installed battery modules.

- CAUTION: Do not dispose of batteries in a fire. The batteries may explode.
- CAUTION: Do not open or mutilate batteries. Released material is harmful to the skin and eyes and may be toxic.
- CAUTION: Failed batteries can reach temperatures that exceed the burn thresholds for touchable surfaces.
- Batteries typically last for two to five years. Environmental factors impact battery life. Elevated ambient temperatures, poor quality utility power, and frequent short duration discharges will shorten battery life. Batteries should be replaced before end of life.
- Schneider Electric uses Maintenance-Free sealed Lead Acid batteries. Under normal use and handling, there is no contact with the internal components of the battery. Over charging, over heating or other misuse of batteries can result in a discharge of battery electrolyte. Released electrolyte is toxic and may be harmful to the skin and eyes.
- Servicing of batteries should be performed or supervised by personnel knowledgeable about batteries and required precautions.
- CAUTION: A battery can present a risk of electrical shock and high short circuit current. The following precautions should be observed when working on batteries:
  - Disconnect the charging source prior to connecting or disconnecting battery terminals.
  - Do not wear any metal objects including watches and rings.
  - Do not lay tools or metal parts on top of batteries.

- Use tools with insulated handles.
- Wear rubber gloves and boots.
- Determine if battery is either intentionally or inadvertently grounded. Contact with any part of a grounded battery can result in electric shock and burns by high short-circuit current. The risk of such hazards can be reduced if grounds are removed during installation and maintenance by a skilled person.

## Deenergizing safety

- The UPS contains internal battery modules and may present a shock hazard even when disconnected from the branch circuit (mains).
- Before installing the UPS or any accessory be sure that the:
  - Input circuit breaker is in **OFF** position.
  - Internal UPS battery modules are removed.
  - External Battery Packs (XBP(s)) is(are) disconnected.

## Electrical safety

- Do not handle any metallic connector before power has been disconnected.
- For models with a hardwired input, the connection to the branch circuit (mains) must be performed by a qualified electrician.
- 230 V models only: In order to maintain compliance with the EMC regulations, output cords and network cables attached to the UPS must not exceed 10 meters in length.
- The protective earth conductor for the UPS carries the leakage current from the load devices (computer equipment). An insulated ground conductor is to be installed as part of the branch circuit that supplies the UPS. The conductor must have the same size and insulation material as the grounded and ungrounded branch circuit supply conductors. The conductor will typically be green, with or without a yellow stripe.
- Leakage current for a pluggable, Type A UPS may exceed 3.5 mA when a separate ground terminal is used.
- The UPS input ground conductor must be properly bonded to protective earth at the service panel.
- If provided, connect the ground cable between the external battery pack(s) and the UPS.
- If the UPS input power is supplied by a separately derived system, the ground conductor must be properly bonded at the supply transformer or motor generator set.

## General information

- The UPS display interface will recognize as many as 10 external battery packs connected to the UPS.  
**NOTE: For each XLBP added, the charging time will increase.**
- The model and serial numbers are located on a small, rear panel label. For some models, an additional label is located on the chassis under the front bezel.
- The batteries are heavy. Remove the batteries before installing the UPS and external battery packs (XLBPs), in a rack.
- Always install external battery packs (XLBPs) at the bottom of the rack. The UPS must be installed above the XLBPs.
- Recycle the packaging materials or save them for reuse.

## FCC Warning

This equipment has been tested and found to comply with the limits for a Class A digital device, pursuant to part 15 of the FCC Rules. These limits are designed to provide reasonable protection against harmful interference when the equipment is operated in a commercial environment. This equipment generates, uses, and can radiate radio frequency energy and, if not installed and used in accordance with the instruction manual, may cause harmful interference to radio communications. Operation of this equipment in a residential area is likely to cause harmful interference in which case the user will be required to correct the interference at his own expense.

## Radio frequency warning

**WARNING:** This is a category C2 UPS product. In a residential environment, this product may cause radio interference, in which case the user may be required to take additional measures.

# Product Description

The APC by Schneider Electric Smart-UPS™ is a high performance uninterruptible power supply (UPS). The UPS provides protection for electronic equipment from utility power blackouts, brownouts, sags, and surges, small utility power fluctuations and large disturbances. The UPS also provides battery backup power for connected equipment until utility power returns to specified levels or the batteries are fully discharged.

This user manual is available on the APC by Schneider Electric Web site, [www.apc.com](http://www.apc.com).

## Product Overview

### High and Low Voltage Models

| Low Voltage (100-127 V) | High Voltage (200-240 V) |
|-------------------------|--------------------------|
| SMX2000LV               | SMX2200HV                |
| SMX2000LVNC             | SMX2200HVNC              |
| SMX3000LV               | SMX3000HV                |
| SMX3000LVNC             | SMX3000HVT               |
| SMX2000LVUS             | SMX3000HVNC              |
| SMX2000LVNCUS           | SMX3000HVTUS             |
| SMX3000LVUS             |                          |
| SMX3000LVNCUS           |                          |

### Front Panel Features

- ❶ Display interface panel
- ❷ UPS battery cable and connector
- ❸ Battery Compartment
- ❹ Bezels

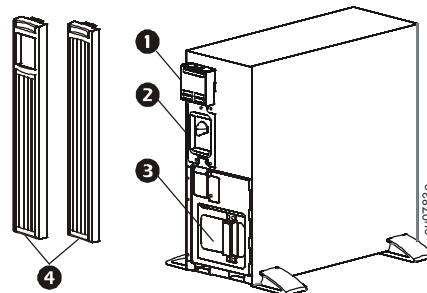

# Rear Panel Features

2000 VA Low Voltage

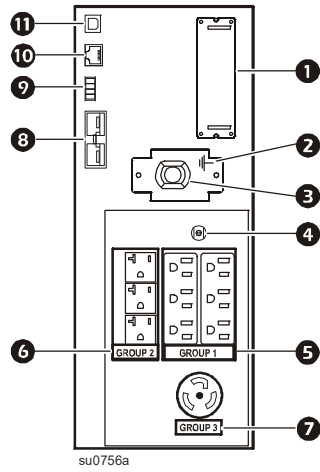

3000 VA Low Voltage

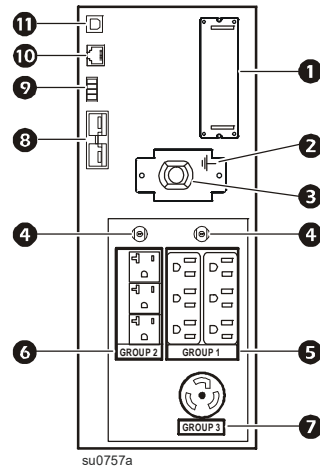

2200 VA High Voltage

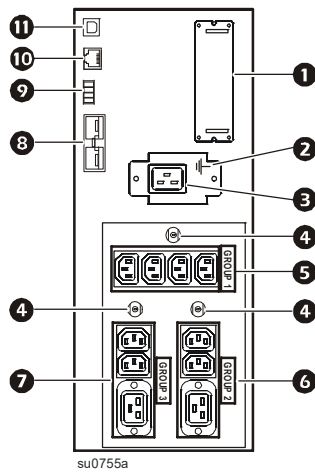

3000 VA High Voltage

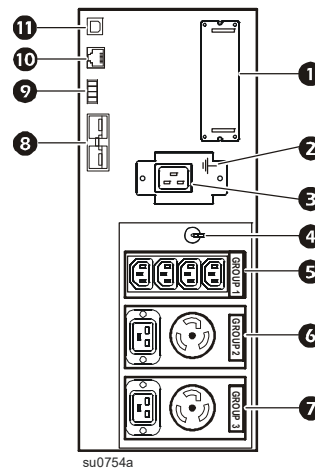

## Rear panel features continued

|   |                                  |  |
|---|----------------------------------|--|
| ① | SmartSlot                        | Use the SmartSlot to install an optional Network Management Card (NMC).  |
| ② | Chassis ground screw             | The UPS has a ground screw for connecting the ground leads on transient voltage devices. Prior to connecting a ground lead, disconnect the UPS from AC power.  |
| ③ | Utility power cable              | Use the power cable (supplied), to connect the UPS to utility power.   |
| ④ | UPS circuit breaker reset button | Press this button to reset the UPS circuit breaker after an overload condition has occurred.   |
| ⑤ | Controllable Outlet Group 1      | Connect essential electronic devices such as a computer, monitor, modem or other data sensitive devices to these outlets.  |
| ⑥ | Controllable Outlet Group 2      | Connect peripheral electronic devices to these outlets.  |
| ⑦ | Controllable Outlet Group 3      | Connect peripheral electronic devices to these outlets   |
| ⑧ | External battery connector       | Use the external battery cable to connect the UPS to an XLBP.<br>XLBPs provide extended runtime during power outages. The UPS can support up to 10 external battery packs.   |
| ⑨ | EPO terminal                     | The Emergency Power Off (EPO) terminal allows the user to connect the UPS to a central EPO system.   |
| ⑩ | Serial port                      | To use PowerChute software, connect the serial cable (supplied), to the Serial port. <b>Use only interface kits supplied or approved by APC by Schneider Electric. Any other serial interface cable will be incompatible with the UPS connector.:</b> Use this serial port for monitoring the UPS. <b>Refer to “Connect and Install Management software” on page 12.</b> |
| ⑪ | USB port                         | Connect a USB cable from a computer to use power management software. <b>NOTE:</b> Serial and USB communication can only be used individually, they cannot be used at the same time. Use this port to connect to a computer for monitoring or gracefully shutting down the UPS using PowerChute software. Refer to “Connect and Install Management software” on page 12  |

## Specifications

### Environmental Specifications

For additional specifications, refer to the APC by Schneider Electric Web site at [www.apc.com](http://www.apc.com).

|  |                  |   |
|--|------------------|---|
| <b>Temperature</b>                                     | <b>Operating</b> | 0° to 40° C (32° to 104° F)   |
|  | <b>Storage</b>   | -15° to 45° C (5° to 113° F)<br>Charge UPS battery every six months |
| <b>Maximum Elevation</b>                               | <b>Operating</b> | 3,000 m (10,000 ft)   |
|  | <b>Storage</b>   | 15,000 m (50,000 ft)  |
| <b>Humidity</b>  |                  | 0% to 95% relative humidity, non-condensing                         |
| <b>International Protection Code</b>                   |                  | IP20  |
| <b>Pollution degree</b>                                |                  | 2   |
| <b>Overvoltage category</b>                            |                  | II  |
| <b>Applicable power grid power distribution system</b> |                  | TN Power System   |
| <b>Applicable standard</b>                             |                  | IEC 62040-1   |



# Installation

## UPS

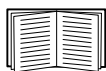

For UPS installation information, refer to the Smart-UPS X 2000-3000 VA Installation Guide that is included with the UPS. The guide is also available from the APC by Schneider Electric Web site at [www.apc.com](http://www.apc.com).

## External Battery Pack

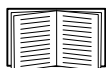

For installation information, refer to the SMX120BP external battery pack Installation Guide that is included with the external battery pack (XLBP). The guide is also available from the APC by Schneider Electric Web site at [www.apc.com](http://www.apc.com). For UPS installation information, refer to the Installation Guide included with the UPS.

The Installation Guide is also available on the APC by Schneider Electric Web site, [www.apc.com](http://www.apc.com).

## Battery Replacement



**Always recycle used batteries.**

**For information on recycling a used battery, refer to the Battery Disposal Information sheet included with the replacement battery.**

Battery life is highly dependent on temperature and use. To identify when to replace batteries, Smart-UPS have a predictive battery replacement date indicator in the “About” menu and automatic (and configurable) self-tests.

Proactively replace batteries to maintain the highest availability. To ensure protection and high performance, use only genuine APC replacement battery cartridges (RBC™). The APC RBC contains instructions for battery replacement and disposal. To order a replacement battery go to the APC by Schneider Electric Web site, [www.apc.com](http://www.apc.com).

| UPS Model   | Replacement Battery | Battery Module              |
|---|---------------------|-----------------------------|
| SMX2000LV, SMX2000LVNC,<br>SMX3000LVNC, SMX2200HV,<br>SMX2200HVNC, SMX3000HV, SMX3000HV,<br>SMX3000HVT, SMX3000HVNC | APCRBC143           | Lead acid, 1 module, 120Vdc |
| SMX2000LVUS, SMX2000LVNCUS,<br>SMX3000LVUS, SMX3000LVNCUS,<br>SMX3000HVTUS  | APCRBC143US         |                             |

# Network Management Card

---

## Introduction

The Schneider Electric Network Management Card (NMC) enables essential and secure remote monitoring and management of your UPS. Connecting your Smart-UPS will improve the availability, resiliency and efficiency of your UPS and the IT workloads it supports.

If you purchased a UPS model that includes a pre-installed NMC (AP9641) please refer to the NMC Installation Guide for steps on how to configure the NMC.

To ensure your Network Management Card has the latest firmware which is independently certified to the IEC 62443-4-2 standard, your NMC includes a 1-year Secure NMC System (SNS) subscription.

For further information including the latest documentation, please visit [www.apc.com/secure-nmc](http://www.apc.com/secure-nmc)

## Features

### The Network Management Card:

- Connects to the network through a 10/100/1000 Base-T Network Port.
- Provides UPS control and self-test scheduling features.
- Provides data and event logs.
- Enables you to set up notifications through event logging, e-mail, Syslog and SNMP traps.
- Provides support for PowerChute™ Network Shutdown for unattended graceful shutdown of your physical servers, virtual machines and hyperconverged infrastructure.
- Supports using a Dynamic Host Configuration Protocol (DHCP) or BOOTstrap Protocol (BOOTP) server to provide the network (TCP/IP) values of the NMC.
- Provides the ability to export a user configuration (.ini) file from a configured NMC to one or more unconfigured NMCs without converting the file to a binary file.
- Provides a selection of security protocols for authentication and encryption.
- Communicates with EcoStruxure™ IT Expert or Data Center Expert for enhanced monitoring and management capabilities.
- Provides two USB ports, which support upgrading the UPS firmware from a USB flash drive.
- Supports two universal input/output ports to which you can connect:
  - Temperature probe, AP9335T (supplied).
  - Temperature/humidity sensor, AP9335TH (optional).
  - Relay input/output connector that supports two input contacts and one output relay using the Dry Contact I/O Accessory, AP9810 (optional).

### Network Management Card Settings

These settings are available only on units that have a Network Management Card (NMC).

- NMC IP Address Mode
- NMC Default Gateway

# Operation

## Connect Equipment to the UPS

**NOTE:** The UPS will charge to 90% capacity in the first three hours of normal operation.  
**Do not expect full battery runtime capability during this initial charge period.**

### CAUTION





#### RISK OF ELECTRIC SHOCK

- Adhere to all local and national electrical codes.
- Wiring should be performed by qualified electrician.
- Always connect the UPS to a grounded outlet.

**Failure to follow these instructions can result in minor or moderate injury.**

1. Connect equipment to the outlets on the rear panel of the UPS.  
**Refer to “Switched Outlet Groups” on page 15.**
2. Connect the UPS to the building utility power.  
**Always connect the UPS to a two pole, three wire, grounded source.**
3. To use the UPS as a master ON/OFF switch, turn on all the equipment that is connected to the UPS.
4. Press the ON/OFF button on the front panel of the UPS to turn on the UPS and all connected equipment.
5. Follow the prompts to configure the UPS using the set up wizard the first time the UPS is turned on. Refer to “Configuration” on page 14 and “Menu overview” on page 11.

### Basic Connectors

|   |  |
|---|--|
|  | <b>Serial port:</b> Connect to a computer to use PowerChute™ software.   |
|  | <b>USB port:</b> Connect to a computer to use PowerChute™ software.<br><b>NOTE:</b> Serial and USB communication can not be used simultaneously.   |
|  | <b>External Battery Pack connector:</b> Connect external battery packs to provide extended runtime during power outages. The UPS can support up to 10 external battery packs.  |
|  | <b>Ground Screw:</b> The UPS features a ground screw for connecting the ground lead on surge suppression devices such as a telephone and network line protectors. When connecting a ground cable, disconnect the UPS from utility power. |

# Display Panel

## Overview

- ❶ Online LED
- ❷ Power ON/OFF button
- ❸ On Battery LED
- ❹ Error Detected LED
- ❺ Replace Battery LED
- ❻ Multi-lingual display screen
- ❼ UP/DOWN arrow buttons
- ❽ ENTER button
- ❾ ESCAPE button

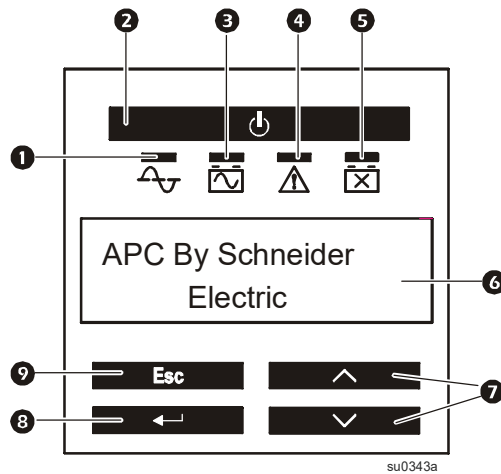

## Display interface operation

Use the UP/DOWN arrow buttons to scroll through the main menu options. Press ENTER to view the submenus under each main menu option. Press ESCAPE to exit a submenu and return to a MAIN menu.

## Menu Overview

The Smart-UPS has Standard and Advanced menu screens. The Standard menu screens are the most commonly used screens. The Advanced menu screens are for more advanced users to configure additional features on the UPS.

**NOTE:** Actual menu screens may vary.

| Main Menu   | Display Description                  | Standard Option | Advanced Option    |
|---|--------------------------------------|-----------------|--------------------|
| <b>Status</b><br><br>Some of these options are displayed as scrolling menus | Operating mode                       | x               | x (scrolling menu) |
|   | Efficiency                           | x               | x                  |
|   | Load power (Watts, %, VA)            | x               | x (scrolling menu) |
|   | Load amperage                        |                 | x                  |
|   | Load energy meter                    |                 | x                  |
|   | Battery charge level %               | x               | x                  |
|   | Battery runtime (hours, min)         | x               | x (scrolling menu) |
|   | Battery temperature                  | x               | x                  |
|   | Battery voltage                      |                 | x                  |
|   | Number of external battery packs     |                 | x                  |
|   | Input voltage and frequency          | x               | x (scrolling menu) |
|   | Output voltage and frequency         | x               | x (scrolling menu) |
|   | Last transfer reason                 | x               | x (scrolling menu) |
|   | Last UPS self test result            | x               | x                  |
|   | Outlet group status                  |                 | x (scrolling menu) |
|   | NMC IP address (if used)             |                 | x                  |
| <b>Control</b>  | UPS control                          |                 | x                  |
|   | Group outlet control                 |                 | x                  |
| <b>Configuration</b>  | Language                             | x               | x                  |
|   | Output voltage setting               |                 | x                  |
|   | Green mode                           | x               | x                  |
|   | Power quality                        | x               | x                  |
|   | Menu type                            | x               | x                  |
|   | Audible alarms                       | x               | x                  |
|   | Display mode                         | x               | x                  |
|   | Sensitivity                          |                 | x                  |
|   | Low and high voltage transfer points |                 | x                  |
|   | Low battery alarm threshold          |                 | x                  |
|   | Automatic self test interval         |                 | x                  |
|   | Battery install date                 | x               | x                  |
|   | Reset energy meter                   |                 | x                  |
|   | Enter start up wizard                |                 | x                  |
|   | Perform firmware update              |                 | x                  |
|   | Reset to factory defaults            | x               | x                  |
| Outlet group configuration (delays, reboot, min return, load shedding)      |                                      | x               |                    |
| <b>Test &amp; Diagnostics</b>   | UPS self test                        | x               | x                  |
|   | UPS alarms test                      | x               | x                  |
|   | UPS calibration test                 | x               | x                  |

| Main Menu    | Display Description  | Standard Option | Advanced Option |
|--------------|--|-----------------|-----------------|
| <b>Logs</b>  | Last 10 transfer events (if applicable)  |                 | X               |
|              | Last 10 events (if applicable)   |                 | X               |
| <b>About</b> | Model identification   | X               | X               |
|              | Part number  | X               | X               |
|              | Serial number  | X               | X               |
|              | UPS manufacture date   | X               | X               |
|              | Replace battery part number  | X               | X               |
|              | External battery part number   | X               | X               |
|              | Battery install date   | X               | X               |
|              | Replace battery date   | X               | X               |
|              | UPS firmware revision  | X               | X               |
|              | NMC Information - part/serial/version numbers/manufacture date/MAC address/firmware revision (if applicable) |                 | X               |

## Connect and Install Management software

Smart-UPS is provided with PowerChute UPS Management Software for unattended operating system shutdown, UPS monitoring, UPS control and energy reporting. The following diagram is a representation of a typical server installation.

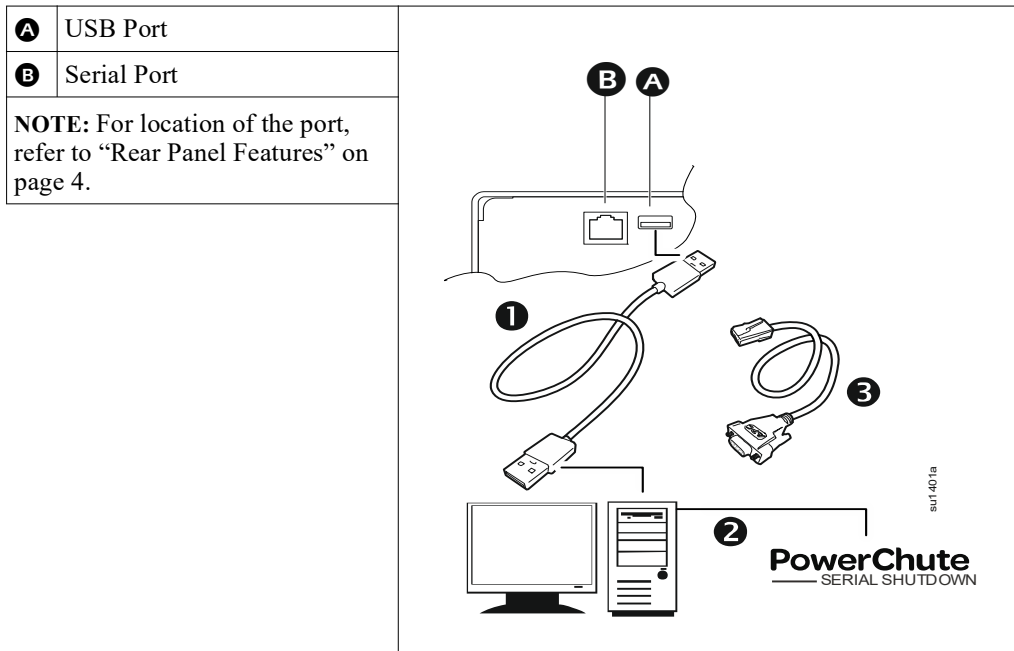

|   |   |
|---|---|
| <b>1</b>  | Connect the USB cable from the rear of the UPS to the protected device such as a server.  |
| <b>2</b>  | For a server or other device with an operating system, download and install latest version of the PowerChute Serial Shutdown from <a href="https://www.apc.com/pess">https://www.apc.com/pess</a> . PowerChute Serial Shutdown supports graceful shutdown in the event of an extended power outage.<br><b>NOTE:</b> PowerChute is a 64-bit only application and cannot be installed on a 32-bit operating system. |
| <b>3</b>  | A built-in Serial port is also available for additional communication options with serial cable.<br><b>NOTE:</b> Serial and USB cannot be used at the same time.  |
| Even more communication options are available via the built-in Smartslot. Refer to <a href="http://www.apc.com">www.apc.com</a> for more information. |   |

# Configuration

## UPS Settings

### Start up Settings

Configure these settings at initial start up, using the display interface or PowerChute™ software.

**NOTE:** During start up, use the display interface to configure these settings. If nothing is selected, the unit will use the default settings.

| Function                   | Factory Default                | Options   | Description  |
|----------------------------|--------------------------------|---|--|
| <b>Language</b>            | English                        | <ul style="list-style-type: none"><li>• English</li><li>• French*</li><li>• German*</li><li>• Spanish*</li><li>• Italian*</li><li>• Portuguese*</li></ul> | The language for the display interface.<br>*Language options will vary by model.   |
| <b>Output Voltage</b>      | Low Voltage: 120 V             | <ul style="list-style-type: none"><li>• 100</li><li>• 110</li><li>• 120</li><li>• 127</li></ul>   | Set the output voltage setting while the UPS is in <b>Standby</b> mode.  |
|                            | High Voltage: 230 V            | <ul style="list-style-type: none"><li>• 200</li><li>• 208</li><li>• 220</li><li>• 230</li><li>• 240</li></ul>   |  |
| <b>Local Power Quality</b> | Good                           | <ul style="list-style-type: none"><li>• Good</li><li>• Fair</li><li>• Poor</li></ul>  | Select the quality of input utility power. <ul style="list-style-type: none"><li>• If Good is selected, the unit will go on <b>battery</b> power more often to provide the cleanest power supply to the connected equipment.</li><li>• If Poor is selected, the UPS will tolerate more fluctuations in power and will go on battery power less often.</li></ul> If unsure of the local power quality, select Good. |
| <b>Menu Type</b>           | Standard                       | Standard or Advanced  | The Standard menus display a limited set of menus and options. The advanced menus include all parameters.  |
| <b>Date</b>                | UPS manufacture date + 90 days | mm-yyyy   | Enter the current date.  |

## General Settings

Configuration settings may be changed at any time using PowerChute™ software or Network Management Card. This table provides a brief description of the general settings, for more detailed information on each of these parameters consult applicationnote 80 at [www.apc.com](http://www.apc.com) Outlet group configuration settings.

| Function                                | Factory Default   | Options  | Description   |
|---|---|--|---|
| <b>High Transfer</b>                    | <b>Low Voltage</b>  |  | To avoid unnecessary battery usage, set the transfer point higher if the utility voltage is chronically high and the connected equipment is known to work under this condition. The POWER QUALITY setting will automatically change this setting.<br><b>NOTE:</b> Use the Advanced Menus to configure this setting.   |
|   | 100 V: 108 Vac  | 108-114 Vac  |   |
|   | 110 V: 116 Vac  | 116-125 Vac  |   |
|   | 120 V: 127 Vac  | 127-136 Vac  |   |
|   | 127 V: 134 Vac  | 134-143 Vac  |   |
|   | <b>High Voltage</b>   |  |   |
|   | 200 V: 216 Vac  | 216-228 Vac  |   |
|   | 208 V: 220 Vac  | 220-235 Vac  |   |
|   | 220 V: 242 Vac  | 242-254 Vac  |   |
|   | 230 V: 253 Vac  | 253-265 Vac  |   |
| 240 V: 264 Vac                          | 264-276 Vac   |  |   |
| <b>Low Transfer</b>                     | <b>Low Voltage</b>  |  | Set the transfer point lower if the utility voltage is chronically low and the connected equipment can tolerate this condition. The POWER QUALITY setting will automatically change this setting.<br><b>NOTE:</b> Use the Advanced Menus to configure this setting.   |
|   | 100 V: 92 Vac   | 86-92 Vac  |   |
|   | 110 V: 98 Vac   | 89-98 Vac  |   |
|   | 120 V: 106 Vac  | 97-106 Vac   |   |
|   | 127 V: 112 Vac  | 103-112 Vac  |   |
|   | <b>High Voltage</b>   |  |   |
|   | 200 V: 184 Vac  | 172-184 Vac  |   |
|   | 208 V: 184 Vac  | 169-184 Vac  |   |
|   | 220 V: 198 Vac  | 186-198 Vac  |   |
|   | 230 V: 207 Vac  | 195-207 Vac  |   |
| 240 V: 216 Vac                          | 204-216 Vac   |  |   |
| <b>Green Mode</b>                       | If the UPS input voltage is between the high transfer point and the lower transfer point, the unit will operate in green mode. Configure this setting using the Advanced menus. |  |   |
| <b>Sensitivity</b>                      | Normal  | <ul style="list-style-type: none"> <li>• Normal</li> <li>• Reduced</li> <li>• Low</li> </ul> | Select the level of sensitivity to power events that the UPS will tolerate. <ul style="list-style-type: none"> <li>• Normal: The UPS will go on battery power more often to provide the cleanest power supply to the connected equipment.</li> <li>• Reduced: The UPS will tolerate some fluctuations in power.</li> <li>• Low: The UPS will tolerate more fluctuations in power and will go on battery power less often.</li> </ul> If the connected load is sensitive to power disturbances, set the sensitivity to Normal using the advanced Configuration menu. |
| <b>Low Battery Setting</b>              | 150 sec   | Set the value in seconds   | The UPS will emit an audible alarm when the remaining runtime has reached this level.   |
| <b>Date of Last Battery Replacement</b> | Date set at factory   | Reset this date when the battery module is replaced.   |   |
| <b>Audible Alarm</b>                    | On  | <ul style="list-style-type: none"> <li>• On</li> <li>• Off</li> </ul>                        | The UPS will never beep if all audible alarms are set to Off or when the display buttons are pressed.   |



| Function                               | Factory Default                                   | Options  | Description   |
|--|---|--|---|
| <b>Auto Self-Test Interval Setting</b> | On start-up and every 14 days since the last test | <ul style="list-style-type: none"> <li>• Last test + 14 days</li> <li>• Last test + 7 days</li> <li>• Turn on + 14 days</li> <li>• Turn on + 7 days</li> <li>• On startup only</li> <li>• Never</li> </ul> | The interval at which the UPS will execute a self-test. The batteries must be charged to at least 70% capacity to perform the test. |
| <b>Reset to Factory Default</b>        | No  | <ul style="list-style-type: none"> <li>• Yes</li> <li>• No</li> </ul>  | Restore the UPS factory default settings.   |

## Switched Outlet Groups

### Overview

The Switched Outlet Groups can be configured to independently turn off, turn on, shut down, put into sleep mode, and reboot connected equipment.

The Switched Outlet Groups can be commanded to do the following:

- Turn off: Disconnect from power immediately and restart only with a manual command
- Turn on: Connect to power immediately
- Shutdown: Disconnect power in sequence, and automatically reapply power in sequence when utility power becomes available
- Reboot: Shut down and restart
- Sleep: Reboot after a long delay

In addition, the Switched Outlet Groups can be configured to do the following:

- Turn on or off in a specified sequence
- Automatically turn off or shut down when various conditions occur

**NOTE:** Whether the Switched Outlet Groups are configured or not, all of the outlets provide battery backup power.

### Using the Switched Outlet Groups

1. Connect essential equipment to a Switched Outlet Group.
2. Connect peripheral equipment to the other Switched Outlet Groups.
  - During a power outage, to conserve battery runtime, nonessential equipment can be configured to shut down after a short delay
  - If equipment has dependent peripherals that must restart or shut down in a specific order, such as an ethernet switch that must restart before a connected server, connect the devices to separate groups
  - Equipment that needs to reboot independently from other equipment should be added to a separate group
3. Use the Configuration menus to configure how the Switched Outlet Groups will react in the event of a power outage.

## Customize the Switched Outlet Groups

Use the **Control** menus to customize the Switched Outlet Groups.

| Function                              | Factory Default      | Options  | Description   |
|---------------------------------------|----------------------|--|---|
| <b>Name String<br/>Outlet Group</b>   | Outlet Group 1, 2, 3 | Edit these names using an external interface, such as the Network Management Card web interface.   |   |
| <b>UPS Name String</b>                | APC UPS              |  |   |
| <b>Turn On Delay</b>                  | 0 sec                | Set the value in seconds   | The amount of time the Switched Outlet Groups will wait between receiving the command to turn on and the actual startup.  |
| <b>Turn Off Delay</b>                 | 90 sec               | Set the value in seconds   | The amount of time that the Switched Outlet Groups will wait between receiving the command to turn off and the actual shut down.  |
| <b>Reboot Duration</b>                | 8 sec                | Set the value in seconds   | The amount of time that the Switched Outlet Groups must remain off before it will restart.  |
| <b>Minimum Return Time</b>            | 0 sec                | Set the value in seconds   | The amount of battery runtime that must be available before the Switched Outlet Groups will turn on again after a shutdown.   |
| <b>Load Shed On Battery</b>           | Disabled             | <ul style="list-style-type: none"> <li>• Shutdown with Delay</li> <li>• Shutdown immediately</li> <li>• Turn off immediately</li> <li>• Turn off with delay</li> <li>• Disabled</li> </ul> | <p>When the unit switches to battery power, the UPS can disconnect power to the Switched Outlet Groups to save runtime.</p> <p>Configure this delay time, use the LOAD SHED TIME WHEN ON BATTERY setting.</p>                 |
| <b>Load Shed Time when On Battery</b> | Disabled             | Set the value in seconds   | The amount of time the outlets will function on battery power before they will turn off.  |
| <b>Load Shed On Runtime</b>           | Disabled             | <ul style="list-style-type: none"> <li>• Shutdown with delay</li> <li>• Shutdown immediately</li> <li>• Turn off immediately</li> <li>• Turn off with delay</li> <li>• Disabled</li> </ul> | Configure this time using the LOAD SHED RUNTIME REMAINING setting.  |
| <b>Load Shed On Runtime Remaining</b> | Disabled             | Set the value in seconds   | When the remaining runtime reaches this level, the Switched Outlet Groups will turn off.  |
| <b>Load Shed on Overload</b>          | Disabled             | <ul style="list-style-type: none"> <li>• Disabled</li> <li>• Enabled</li> </ul>  | In the event of an overload (greater than 105% output), the Switched Outlet Groups will immediately turn off to conserve power for essential loads. The Switched Outlet Groups will only turn on again with a manual command. |

# Emergency Power Off

## Overview

The Emergency Power Off (EPO) option is a feature that will immediately disconnect all connected equipment from mains power. The UPS will immediately shut down and will not switch to battery power. Connect each UPS to the EPO switch. If multiple units are to be controlled with an EPO switch, each UPS must be connected separately to the EPO switch.

The UPS must be restarted for power to return to connected equipment. Press the ON/OFF button on the front panel of the UPS.

## ⚠ CAUTION

### RISK OF ELECTRIC SHOCK

- Adhere to all local and national electrical codes.
- Wiring must be performed by a qualified electrician.
- Always connect the UPS to a grounded outlet.

**Failure to follow these instructions can result in minor or moderate injury.**

## Normally open contacts

1. If the EPO switch or relay contacts are normally open, insert the wires from the switch or contacts at pins 1 and 2 of the EPO terminal block. Use 16-28 AWG wire.
2. Secure the wires by tightening the screws.

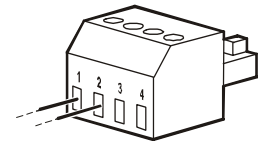

If the contacts are closed, the UPS will turn OFF and power will be removed from the load.

## Normally closed contacts

1. If the EPO switch or relay contacts are normally closed, insert the wires from the switch or contacts at pins 2 and 3 of the EPO terminal block. Use 16-28 AWG wire.
2. Insert a wire jumper between pins 1 and 2. Secure the wires by tightening the three screws at positions 1, 2, and 3.

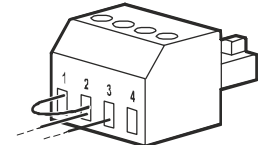

If the contacts are opened, the UPS will turn OFF and power will be removed from the load.

**NOTE:** Pin 1 is the power source for the EPO circuit, it provides a few milliamperes of 24 V power.

If the normally closed (NC) EPO configuration is used, the EPO switch or relay should be rated for dry circuit applications, the rating should be for low voltage and low current applications. This normally implies the contacts are gold-plated.

The EPO interface is a Safety Extra Low Voltage (SELV) circuit. Connect the EPO interface only to other SELV circuits. The EPO interface monitors circuits that have no determined voltage potential. SELV circuits are controlled by a switch or relay properly isolated from utility power. To avoid damage to the UPS, do not connect the EPO interface to any circuit other than a SELV circuit.

Use one of the following cable types to connect the UPS to the EPO switch.

- CL2: Class 2 cable for general use.
- CL2P: Plenum cable for use in ducts, plenums, and other spaces used for environmental air.
- CL2R: Riser cable for use in a vertical run in a floor-to-floor shaft.
- CLEX: Limited use cable for use in dwellings and for use in raceways.
- Installation in Canada: Use only CSA certified, type ELC, (extra low voltage control cable).
- Installation in countries other than Canada and the USA: Use standard low voltage cable in accordance with national and local regulations.

# Troubleshooting

| <b>Problem and Possible Cause</b>   | <b>Solution</b>   |
|---|---|
| <b>The UPS will not turn on or there is no output</b>   |   |
| The unit has not been turned on.  | Press the ON button once to turn on the UPS.  |
| The UPS is not connected to utility power.  | Be sure the power cable is securely connected to the unit and to the utility power supply.  |
| The input circuit breaker has tripped.  | Reduce the load on the UPS. Disconnect nonessential equipment and reset the circuit breaker.  |
| The unit shows very low or no utility power.  | Check the utility power supply to the UPS by plugging in a table lamp. If the light is very dim, check the utility voltage.   |
| The battery is not securely connected.  | Be sure that all battery connections are secure.  |
| There is an internal UPS event.   | Do not attempt to use the UPS. Unplug the UPS and have it serviced immediately.   |
| <b>The UPS is operating on battery, while connected to input utility power</b>                            |   |
| The input circuit breaker has tripped.  | Disconnect nonessential equipment and reset the circuit breaker.  |
| There is very high, very low, or distorted input line voltage.  | Move the UPS to a different outlet on a different circuit. Test the input voltage with the utility voltage display. If acceptable to the connected equipment, reduce the UPS sensitivity.   |
| <b>UPS is beeping</b>   |   |
| The UPS is operating normally.  | None. The UPS is helping protect the connected equipment.   |
| <b>UPS does not provide expected backup time</b>  |   |
| The UPS battery is weak due to a recent power outage or is near the end of its service life.              | Charge the battery. Batteries require recharging after extended outages and wear out faster when put into service often or when operated at elevated temperatures. If the battery is near the end of its service life, consider replacing the battery even if the replace battery LED is not illuminated. |
| The UPS is experiencing an overload condition.  | Check the UPS load display. Unplug unnecessary equipment, such as printers.   |
| <b>Display interface LEDs flash sequentially</b>  |   |
| The UPS has been shut down remotely through software or an optional accessory card.                       | None. The UPS will restart automatically when utility power is restored.  |
| <b>The Event LED is illuminated, the UPS displays an event message and emits a constant beeping sound</b> |   |
| Internal UPS event detected.  | Do not attempt to use the UPS. Turn the UPS off and have it serviced immediately.   |
| <b>All LEDs are illuminated and the UPS is plugged into a wall outlet</b>                                 |   |
| The UPS has shut down and the battery has discharged from an extended outage.                             | None. The UPS will return to normal operation when the power is restored and the battery has a sufficient charge.   |
| <b>The Replace Battery LED is illuminated</b>   |   |
| The battery has a weak charge.  | Allow the battery to recharge for at least four hours. Then, perform a self-test. If the problem persists after recharging, replace the battery.  |

| Problem and Possible Cause  | Solution  |
|---|---|
| The replacement battery is not properly connected.  | Be sure the battery connector is securely connected.  |
| <b>The display interface shows a Site Wiring Fault message</b>  |   |
| Site wiring faults detected include missing ground, hot-neutral, polarity reversal, and overloaded neutral circuit. | If the UPS indicates a site wiring fault, have a qualified electrician inspect the building wiring. Applicable for 120 Vac models only. |

## Service

**If the unit requires service, do not return it to the dealer. Follow these steps:**

1. Review the Troubleshooting section of the manual to eliminate common problems.
2. If the problem persists, contact APC by Schneider Electric Customer Support through the Web site, **www.apc.com**.
  - a. Note the model number and serial number and the date of purchase. The model and serial numbers are located on the rear panel of the unit and are available through the LCD display on select models.
  - b. Call APC by Schneider Electric Customer Support and a technician will attempt to solve the problem over the phone. If this is not possible, the technician will issue a Returned Material Authorization Number (RMA#).
  - c. If the unit is under warranty, the repairs are free.
  - d. Service procedures and returns may vary internationally. Refer to the APC by Schneider Electric Web site for country specific instructions.
3. Pack the unit in the original packaging whenever possible to avoid damage in transit. Never use foam beads for packaging. Damage sustained in transit is not covered under warranty.
  - a. **Always DISCONNECT THE UPS BATTERIES before shipping. The United States Department of Transportation (DOT), and the International Air Transport Association (IATA) regulations require that UPS batteries be disconnected before shipping. The internal batteries may remain in the UPS.**
  - b. External Battery Pack products are deenergized when disconnected from the associated UPS product. It is not necessary to disconnect the internal batteries for shipping. Not all units utilize an external battery pack.
4. Write the RMA# provided by Customer Support on the outside of the package.
5. Return the unit by insured, prepaid carrier to the address provided by Customer Support.

### Transport the unit

1. Shut down and disconnect all connected equipment.
2. Disconnect the unit from utility power.
3. Disconnect all internal and external batteries (if applicable).
4. Follow the shipping instructions outlined in the *Service* section of this manual.

# Limited Factory Warranty

Schneider Electric IT Corporation (SEIT), warrants its products to be free from defects in materials and workmanship for a period of three (3) years excluding the batteries, which are warranted for two (2) years from the date of purchase. The SEIT obligation under this warranty is limited to repairing or replacing, at its own sole option, any such defective products. Repair or replacement of a defective product or part thereof does not extend the original warranty period.

This warranty applies only to the original purchaser who must have properly registered the product within 10 days of purchase. Products may be registered online at [warranty.apc.com](http://warranty.apc.com).

SEIT shall not be liable under the warranty if its testing and examination disclose that the alleged defect in the product does not exist or was caused by end user or any third person misuse, negligence, improper installation, testing, operation or use of the product contrary to SEIT recommendations of specifications. Further, SEIT shall not be liable for defects resulting from: 1) unauthorized attempts to repair or modify the product, 2) incorrect or inadequate electrical voltage or connection, 3) inappropriate on site operation conditions, 4) Acts of God, 5) exposure to the elements, or 6) theft. In no event shall SEIT have any liability under this warranty for any product where the serial number has been altered, defaced, or removed.

**EXCEPT AS SET FORTH ABOVE, THERE ARE NO WARRANTIES, EXPRESS OR IMPLIED, BY OPERATION OF LAW OR OTHERWISE, APPLICABLE TO PRODUCTS SOLD, SERVICED OR FURNISHED UNDER THIS AGREEMENT OR IN CONNECTION HEREWITH.**

**SEIT DISCLAIMS ALL IMPLIED WARRANTIES OF MERCHANTABILITY, SATISFACTION AND FITNESS FOR A PARTICULAR PURPOSE.**

**SEIT EXPRESS WARRANTIES WILL NOT BE ENLARGED, DIMINISHED, OR AFFECTED BY AND NO OBLIGATION OR LIABILITY WILL ARISE OUT OF, SEIT RENDERING OF TECHNICAL OR OTHER ADVICE OR SERVICE IN CONNECTION WITH THE PRODUCTS.**

**THE FOREGOING WARRANTIES AND REMEDIES ARE EXCLUSIVE AND IN LIEU OF ALL OTHER WARRANTIES AND REMEDIES. THE WARRANTIES SET FORTH ABOVE CONSTITUTE SEIT'S SOLE LIABILITY AND PURCHASER EXCLUSIVE REMEDY FOR ANY BREACH OF SUCH WARRANTIES. SEIT WARRANTIES EXTEND ONLY TO ORIGINAL PURCHASER AND ARE NOT EXTENDED TO ANY THIRD PARTIES.**

**IN NO EVENT SHALL SEIT, ITS OFFICERS, DIRECTORS, AFFILIATES OR EMPLOYEES BE LIABLE FOR ANY FORM OF INDIRECT, SPECIAL, CONSEQUENTIAL OR PUNITIVE DAMAGES, ARISING OUT OF THE USE, SERVICE OR INSTALLATION OF THE PRODUCTS, WHETHER SUCH DAMAGES ARISE IN CONTRACT OR TORT, IRRESPECTIVE OF FAULT, NEGLIGENCE OR STRICT LIABILITY OR WHETHER SEIT HAS BEEN ADVISED IN ADVANCE OF THE POSSIBILITY OF SUCH DAMAGES. SPECIFICALLY, SEIT IS NOT LIABLE FOR ANY COSTS, SUCH AS LOST PROFITS OR REVENUE, WHETHER DIRECT OR INDIRECT, LOSS OF EQUIPMENT, LOSS OF USE OF EQUIPMENT, LOSS OF SOFTWARE, LOSS OF DATA, COSTS OF SUBSTITUANTS, CLAIMS BY THIRD PARTIES, OR OTHERWISE.**

**NOTHING IN THIS LIMITED WARRANTY SHALL SEEK TO EXCLUDE OR LIMIT SEIT LIABILITY FOR DEATH OR PERSONAL INJURY RESULTING FROM ITS NEGLIGENCE OR ITS FRAUDULENT MISREPRESENTATION OF TO THE EXTENT THAT IT CANNOT BE EXCLUDED OR LIMITED BY APPLICABLE LAW.**

To obtain service under warranty you must obtain a Returned Material Authorization (RMA) number from customer support. Customers with warranty claims issues may access the SEIT worldwide customer support network through the APC by Schneider Electric Web site: [www.apc.com](http://www.apc.com). Select your country from the country selection drop down menu. Open the Support tab at the top of the web page to obtain information for customer support in your region. Products must be returned with transportation charges prepaid and must be accompanied by a brief description of the problem encountered and proof of date and place of purchase.



# APC™ by Schneider Electric Worldwide Customer Support

Access to Customer Support terms may vary by product. Customer support is available in the following ways:

- Visit the APC by Schneider Electric Web site to access documents in the APC by Schneider Electric Knowledge Base and to submit customer support requests.
  - **www.apc.com** (Corporate Headquarters)  
Connect to localized APC by Schneider Electric Web sites for specific countries, each of which provides customer support information.
  - **www.apc.com/support/**  
Global support searching APC by Schneider Electric Knowledge Base and using e-support.
- Contact the APC by Schneider Electric Customer Support Center by telephone or e-mail.
  - Local, country specific centers: go to **www.apc.com/support/contact** for contact information.
  - For information on how to obtain local customer support, contact the APC by Schneider Electric representative or other distributors from whom you purchased your APC by Schneider Electric product.



Select models are ENERGY STAR® qualified.

For more information go to [www.apc.com/site/recycle/index.cfm/energy-efficiency/energy-star/](http://www.apc.com/site/recycle/index.cfm/energy-efficiency/energy-star/)

© 2024 Schneider Electric. All Rights Reserved. Schneider Electric, APC, Smart-UPS, Network Management Card, and PowerChute are trademarks and the property of Schneider Electric SE, its subsidiaries and affiliated companies. All other trademarks are property of their respective owners.