



# Harmony Electromechanical Relays

Interface, miniature, and power  
electromechanical relays



# Harmony

## Discover **Harmony**

Advanced operator interface and industrial relays

**Harmony** operator interface and industrial relays enhance operational efficiency and equipment availability across industrial and building applications. **Harmony** includes intelligent connected products and edge terminals that visualize, gather and process data, enabling informed operator decisions

## Explore our offer

- **Harmony** Push Buttons and Switches
- **Harmony** HMI Operator Terminals, IPC and EdgeBox
- **Harmony** Signaling Devices
- **Harmony** Electrical Relays
- **Harmony** Safety

Life Is **On**

**Schneider**  
Electric

# Quick access to product information

## Get technical information about your product

References

**Modicon TM3**  
I/O expansion modules for Modicon controllers  
Analog I/O modules

References	Modicon TM3 analog input modules	Input range	Resolution	Input terminal block (T)	Reference	Weight (kg)
2 voltage/current inputs	-10...+10 VDC 0...+10 VDC 0...20 mA / -20 mA	16 bits of	16 bits of	0 581.2	TM3AI2H	0.150
		16 bits of	16 bits of	0 581.2	TM3AI2H	0.254
4 voltage/current inputs	-10...+10 VDC 0...+10 VDC 0...20 mA / -20 mA	12 bits of	12 bits of	3 310.15	TM3AI4	0.200
		11 bits of	11 bits of	3 310.15	TM3AI4	0.200
4 voltage/current or temperature inputs (I, K, R, S, E, T, N, E, C)	-10...+10 VDC 0...+10 VDC 0...20 mA / -20 mA	16 bits of	16 bits of	3 310.15	TM3AI4	0.200
		11 bits of	11 bits of	3 310.15	TM3AI4	0.200
4 differential temperature inputs (I, K, R, S, E, T, N, E, C)	-10...+10 VDC 0...+10 VDC 0...20 mA / -20 mA	16 bits of	16 bits of	3 310.15	TM3AI4	0.200
		11 bits of	11 bits of	3 310.15	TM3AI4	0.200
4 voltage/current	-10...+10 VDC 0...+10 VDC 0...20 mA / -20 mA	16 bits of	16 bits of	3 310.15	TM3AI4	0.200
		11 bits of	11 bits of	3 310.15	TM3AI4	0.200

Life Is On Schneider Electric

Search products, documents & more

My Products My Documents Partner Portal

PRODUCTS SOLUTIONS SERVICES SUPPORT ABOUT US

All products Industrial Automation and Control PLC, PAC and Discrete Controllers Distributed Input/Output (I/O) Modules Modicon TM3

View all Modicon TM3

**TM3AI2H**

Modbus TM3 - 2 analog inputs high resolution

Show more characteristics

Related Software

Product Datasheet User guide Catalogue CAD Document

Characteristics Documents and Downloads Technical FAQs Additional Information Dimensions Drawings

Main

range of product Modicon TM3

product or component type Analog input module

range compatibility Modicon M351 Modicon M221 Modicon M241

Each commercial reference presented in a catalog contains a hyperlink. Click on it to obtain the technical information of the product:

- Characteristics, Dimensions and drawings, Mounting and clearance, Connections and schemas, Performance curves
- Product image, Instruction sheet, User guide, Product certifications, End of life manual

## Find your catalog

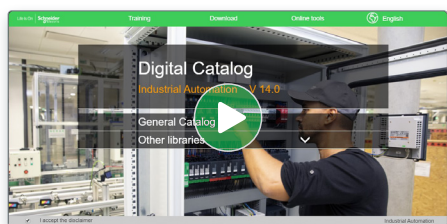

- > With just 3 clicks, you can access the Industrial Automation and Control catalogs, in both English and French
- > Consult digital automation catalogs at [Digi-Cat Online](#)

General Catalog

Four-Function, Switches, Pilot Lights & Indicators

Pushbuttons, Switches, Pilot Lights & Indicators

Buttons, Callings & Interlocks

Displaying Devices

LED (Green and red) and PC

Devices & RFID Systems

Motor Starters and Load Management

Components for Motor Starters

Variable Speed Drives & Soft Starters

Motor Control & Protection

Interface, Measurement & Control Relays

PLC, PAC & other Controllers

- Up-to-date catalogs
- Embedded product selectors, 360° pictures
- Optimized search by commercial references

## Select your training



- > Find the right [Training](#) for your needs on our Global website
- > Locate the training center with the selector tool, using this [link](#)

Training and courses

Training by domain of expertise

Electrical Installation and Safety

Data Center

Industrial Automation

Life Is On

Schneider Electric

# Harmony Electromechanical Relays

Interface, miniature, and power electromechanical relays

## General presentation

- RSL relays for compactness ..... page 2
- RXG relays for reliability ..... page 2
- RXM relays for automation control ..... page 3
- Selection guide of Plug-in relays and relays with clamp fixing* ..... page 4

## RSL slim interface relays

- **Presentation**
  - Presentation of the range ..... page 10
  - Relay description ..... page 10
  - Socket description ..... page 10
- **References**
  - Pre-assembled slim interface relays ..... page 11
  - Slim interface relays for customer assembly ..... page 11
  - Accessories for sockets ..... page 11

## RSB interface relays

- **Presentation**
  - Presentation of the range ..... page 12
  - Socket description ..... page 12
- **References**
  - Pre-assembled interface relays ..... page 13
  - Interface relays for customer assembly ..... page 14
  - Sockets with separate contact terminal arrangement and connector connection ..... page 14
  - Protection modules ..... page 14
  - Accessories ..... page 13

## RXG interface relays

- **Presentation**
  - Presentation of the range ..... page 16
  - Relay description ..... page 16
  - Socket description ..... page 16
- **References**
  - Pre-assembled interface relays ..... page 17
  - Interface relays for customer assembly ..... page 17
  - Sockets with separate contact terminals, mixed contact terminals, and built-in clamp ..... page 19
  - Protection modules ..... page 19
  - Accessories ..... page 19

## RXM miniature relays

- **Presentation**
  - Presentation of the range ..... page 20
  - Relay description ..... page 20
  - Socket description ..... page 20
- **References**
  - Pre-assembled interface relays ..... page 21
  - Miniature relays for customer assembly ..... page 22
  - Sockets ..... page 23
  - Protection modules ..... page 23
  - Timing relays ..... page 23
  - Accessories ..... page 24

# Harmony Electromechanical Relays

Interface, miniature, and power electromechanical relays

## 782H hermetically sealed relays

- **Presentation**
- Presentation of the range..... [page 26](#)
- Relay description ..... [page 26](#)
- Socket description ..... [page 26](#)
- **References** ..... [page 26](#)
- 782H Hermetically sealed relays ..... [page 27](#)
- Sockets..... [page 27](#)
- Socket modules ..... [page 27](#)
- Socket accessories..... [page 27](#)

## 725 power relays

- **Presentation**
- Presentation of the range..... [page 28](#)
- Relay description ..... [page 28](#)
- Socket description ..... [page 28](#)
- **References** ..... [page 29](#)
- 725 power relays ..... [page 29](#)
- Sockets..... [page 29](#)
- Socket modules ..... [page 29](#)
- Socket accessories..... [page 29](#)

## RPM power relays

- **Presentation**
- Presentation of the range..... [page 30](#)
- Relay description ..... [page 30](#)
- Socket description ..... [page 30](#)
- **References** ..... [page 31](#)
- Power relays for customer assembly ..... [page 31](#)
- Sockets..... [page 32](#)
- Protection modules..... [page 32](#)
- Timer module..... [page 32](#)
- Accessories ..... [page 33](#)

## RUM universal relays

- **Presentation**
- Presentation of the range..... [page 34](#)
- Relay description ..... [page 34](#)
- Socket description ..... [page 35](#)
- **References** ..... [page 36](#)
- Universal relays for customer assembly ..... [page 36](#)
- Sockets..... [page 37](#)
- Protection modules..... [page 37](#)
- Timer module..... [page 37](#)
- Timing relays ..... [page 37](#)
- Accessories ..... [page 37](#)

## RPF power relays

- **Presentation**..... [page 38](#)
- **References** ..... [page 39](#)

## Technical presentation

- **Relays**..... [page 40](#)
- **Protection modules**..... [page 41](#)

## Index

- **Product reference index**..... [page 42](#)

# Harmony Electromechanical Relays

Interface, miniature, and power electromechanical relays

## Harmony Electromechanical Relays

Used to multiply the number of input and output contacts, or for logic processing control

RSL relays are compact modular relays conforming to IEC/EN 61810-1, UL508, CSA C22.2 No. 14, and EAC international standards.

Harmony relays offer interface, miniature, universal, and power electromechanical relays, from 1 CO to 4 CO contacts, up to 30 A. The electromechanical relays help to reduce the size of enclosures and at the same time increase machine reliability.

### RSL relays for compactness

#### Flexible offer

- > Available as a single-referenced complete product (relay and socket) or customer-assembled product
- > Wide choice of sockets ranging from 12 to 230 V ~
- > Standard and low level contact types

#### Enhanced performance

- > Sockets with integrated reverse polarity protection circuit
- > Relays for high breaking capacity or low-level current application requirements
- > Power-on and Relay status LED indicator

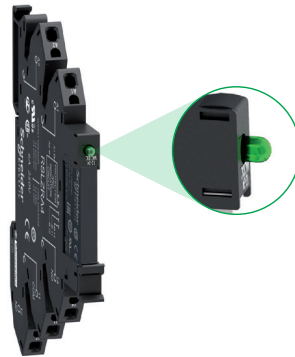

LED indicator for RSL relay status

#### Simple installation and cabling

- > Locking/unlocking lever for removing and replacing the relay in the socket
- > Simple DIN rail mounting and commoning link accessory
- > Choice of screw connector or spring terminal connection for sockets

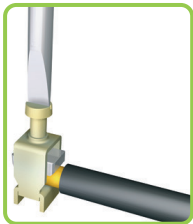

Screw connector



Spring terminal

### RXG relays for reliability

#### Complete offer

RXG relays offer a broad range of coil voltages, from 6 V to 110 V  $\text{---}$  and 24 V to 230 V ~. The relays are available with/without lockable test button, LED, and clear cover.



#### Easy to mount and use

These are the latest relays with a single-step lockable test button. The Faston pin terminal mounts quickly and securely. The slim 16 mm/0.629 in. socket for 2 CO saves panel space.



Single-step lockable test button

## Harmony RXG → Latest interface relay with easy testing function

## RXG relays for reliability (continued)

### Expandable relays

RXG relays can be expanded with protection modules such as diode, diode with LED, varistor with LED, and RC circuit.



RXM industrial relays bring features for easy and improved control of simple and complex automation systems.

## RXM relays for automation control

### Easy to select

- > Wider choice of contacts (2, 3, and 4 CO)
- > Broad range of control circuit voltages and different socket types



### Convenient to use

- > One-step lockable test button
- > Mechanical indicator for contact status
- > "Power On" LED for readiness

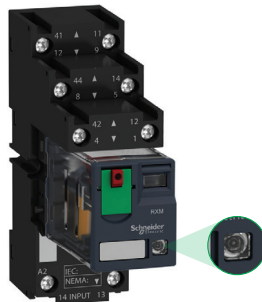

LED indicator for relay status

### Simple to install

- > 64% less wiring time with Push-in Sockets (no screwdriver required)
- > Sockets for both DIN rail and panel mounting, time-saving bus jumper
- > Direct mounting with DIN rail or flange adapter

### Designed to perform

- > Eco-design with RoHS and REACH
- > Flexible add-on protection modules
- > Push-in Socket with 223.75 Newton max pull out force, reliable in vibration environment

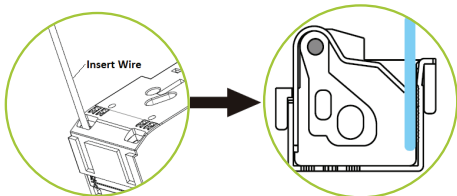

Push-in terminal: insert without tool

**Note:** The Zelio Relays range name has been changed in 2020 to Harmony Relays. As the timeline for each range is different, during the transition period there will be both Zelio and Harmony ranges shown on different product datasheets and packaging.

Harmony RXM → Miniature in size and powerful in performance

# Harmony Electromechanical Relays

Interface, miniature, and power electromechanical relays

<b>Type of product</b>	<b>Plug-in relays</b>
	<b>Interface relays</b>
	
<b>Number and type of contacts/conventional thermal current (Ith on NO contact)</b>	1 CO/10 A 2 CO/5 A
<b>Control circuit voltage</b>	24...230 V 6...110 V
<b>Pin type</b>	Flat (Faston type)
<b>Operational voltage</b>	Up to 250 V ~
<b>Durability</b> (operating cycles per hour)	Electrical, resistive load: 100,000 Mechanical, no-load: 10,000,000 for AC coil 10,000,000 for DC coil
<b>Functions</b>	LED: Yes (depending on version) Mechanical indicator: Yes (depending on version) Test button: Yes, lockable (depending on version) Contact type: Standard
<b>Accessories</b>	Mounting adapters for DIN rail: No Mounting adapters with fixing lugs: No
<b>Type references</b>	<b>RXG●●●● (1)</b>
<b>Pages</b>	17
<b>Type of associated sockets</b>	<b>Sockets</b>



<b>Contact terminal arrangements</b>	Separate	Mixed
<b>Connection</b>	Screw connector	Push-in terminals
<b>Accessories</b>	Yes	No
	No	No
	Yes (plastic, integrated)	No
	Yes	Yes
	Yes	Yes, 2-pole
<b>Conventional thermal current (Ith)</b>	10 A for 1 CO 5 A for 2 CO	10 A 5 A
<b>Type references</b>	<b>RGZE1S35M</b>	<b>RGZE1S48M</b>
<b>Pages</b>	<b>RGZE05P</b>	<b>RGZE08P</b>
	<b>RGZE05E</b>	<b>RGZE08E</b>
	18	

(1) Pre-assembled interface relays RSL1PV●● and RSL1PR●● (standard type relay + socket), RSB (relay + socket + clamp + protection module + label), and RXG (relay + socket + protection module) are also available.  
(2) When using relay RSB1A160●● with socket RSZE1S48M, terminals must be linked.

<b>Plug-in relays</b>	<b>Interface relays</b>
<b>Slim interface relays</b>	
	
<b>Number and type of contacts/conventional thermal current (Ith on NO contact)</b>	1 CO/6 A 1 CO/16 A 1 CO/12 A 2 CO/8 A
<b>Control circuit voltage</b>	24...240 V 6...110 V
<b>Pin type</b>	Flat (PCB type, reinforced) Flat (PCB type)
<b>Operational voltage</b>	Up to 400 V ~/300 V ~
<b>Durability</b> (operating cycles per hour)	60,000 10,000,000
<b>Functions</b>	LED: No Mechanical indicator: No Test button: No Contact type: Standard and low level
<b>Accessories</b>	Mounting adapters for DIN rail: No Mounting adapters with fixing lugs: No
<b>Type references</b>	<b>RSL1●B4●D (1)</b>
<b>Pages</b>	11
<b>Type of associated sockets</b>	<b>Sockets with LED and protection circuit</b>



<b>Contact terminal arrangements</b>	Separate	Separate
<b>Connection</b>	Screw connector	Spring terminals
<b>Accessories</b>	Yes	No
	No	No
	Yes (plastic, integrated)	No
	Yes	Yes
	Yes, 20-pole	Yes, 20-pole
<b>Conventional thermal current (Ith)</b>	6 A	12 A (2 terminals) × 10 A (2)
<b>Type references</b>	<b>RSLZV●●</b>	<b>RSLZR●●</b>
<b>Pages</b>	11	13
	<b>RSZE1S35M</b>	<b>RSZE1S48M</b>
	<b>RSZE05P</b>	<b>RSZE08P</b>
	12 A	10 A



# Harmony Electromechanical Relays

Interface, miniature, and power electromechanical relays

<b>Type of product</b>		<b>Plug-in relays</b>	
		<b>Miniature relays</b>	
			
<b>Number and type of contacts/conventional thermal current (Ith on NO contact)</b>		2 CO/12 A 3 CO/10 A 4 CO/6 A 4 CO/3 A (low level)	
<b>Control circuit voltage</b>	~ ≡	24...240 V 12...220 V	
<b>Pin type</b>		Flat (Faston type)	
<b>Operational voltage</b>		Up to 250 V ~	
<b>Durability</b> (operating cycles per hour)	Electrical, resistive load Mechanical, no-load	100,000 10,000,000	
<b>Functions</b>	LED Mechanical indicator Test button Contact type	Yes (depending on version) Yes Yes, lockable Standard and low level	
<b>Accessories</b>	Mounting adapters for DIN rail Mounting adapters with fixing lugs	Yes Yes	
<b>Type references</b>		<b>RXM●●●●● (1)</b>	
<b>Pages</b>		21	
<b>Type of associated sockets</b>		<b>Sockets without LED</b>	



<b>Contact terminal arrangements</b>	Mixed		Separate	
<b>Connection</b>	Screw connector	Screw clamp terminals	Screw connector	Push-in terminals
<b>Accessories</b>	Protection modules Timer module Maintaining clamps Socket identification legend Bus jumper			
<b>Conventional thermal current (Ith)</b>	10 A	10 A	12 A for 2 CO (2) 6 A for 4 CO	12 A for 2 CO 6 A for 4 CO
<b>Type references</b>	<b>RXZE2M114M</b>	<b>RXZE2M114</b>	<b>RXZE2S●●●M</b>	<b>RXZE14P</b>
<b>Pages</b>	23			

(1) Pre-assembled miniature relays RXM (relay + socket + clamp + label) are also available.  
 (2) Except for sockets RXZE2S11●M: 10 A.  
 (3) To be used with specified sockets only.  
 (4) When using relay RSB1A160●● with socket RSZE1S48M, terminals must be linked.

<b>Type of product</b>		<b>Plug-in relays</b>	
		<b>Hermetically sealed relays</b>	
			
<b>Number and type of contacts/conventional thermal current (Ith on NO contact)</b>		4 CO/5 A 4 CO/3 A (low level) 2 CO/5 A	
<b>Control circuit voltage</b>		6...240 V 6...110 V	
<b>Pin type</b>		Flat (Plug-in type) (3)	
<b>Operational voltage</b>		Up to 264 V ~/121 V ≡	
<b>Durability</b> (operating cycles per hour)		100,000 10,000,000	
<b>Functions</b>		No No No Standard and low level	
<b>Accessories</b>		No No	
<b>Type references</b>		<b>782X●XH●●● (3)</b>	
<b>Pages</b>		27	
<b>Type of associated sockets</b>		<b>Sockets</b>	



<b>Contact terminal arrangements</b>	Mixed		Separate	-	-
<b>Connection</b>	Screw connector	Screw clamp terminals	Screw connector	Solder lug	PCB pins
<b>Accessories</b>	Protection modules Timer module Maintaining clamps Socket identification legend Bus jumper				
<b>Conventional thermal current (Ith)</b>	10 A	10 A	10 A	5 A	10 A
<b>Type references</b>	<b>70-782E14-1</b>	<b>70-461-1</b>	<b>70-782EL14-1</b>	<b>70-378-1</b>	<b>70-379-1</b>
<b>Pages</b>	27				

# Harmony Electromechanical Relays

Interface, miniature, and power electromechanical relays

Type of product	Plug-in socket mount	Panel/DIN rail mount with flat (Faston type) terminals	Panel/DIN rail mount with screw terminals
	Power relays		
			
Number and type of contacts/conventional thermal current (Ith on NO contact)	1 NO/30 A 2 NO/25 A		
Control circuit voltage	24...240 V 12...24 V		
Pin type	Flat (Faston type)	Flat (Faston type)	Screw type
Operational voltage	Up to 264 V ~/26.4 V ---		
Durability (operating cycles per hour)	100,000 5,000,000		
Functions	LED Mechanical indicator Test button Contact type	Yes No Yes, lockable	Yes No Yes, non-lockable
Accessories	Mounting adapters for DIN rail Mounting adapters with fixing lugs		
Type references	<b>725●XX●BM4L-●</b>	<b>725●XX●BC3ML-●</b>	<b>725●XX●SC3ML-●</b>
Pages	29	29	29
Type of associated sockets	Socket		



Contact terminal arrangements	Separate	-
Connection	Screw connector	-
Accessories	Protection modules Timer module Maintaining clamps Socket identification legend Bus jumper	Yes No Yes - No
Conventional thermal current (Ith)	30 A	-
Type references	<b>70-725-1</b>	-
Pages	29	-

(1) 100,000 for RPM1 and RPM2; 60,000 for RPM3 and RPM4.

(2) 30 A when mounted with 13 mm (0.51 in.) gap between two relays and 25 A when mounted side-by-side without a gap.

Note: The Zelio Relays range name has been changed in 2020 to Harmony Relays. As the timeline for each range is different, during the transition period there will be both Zelio and Harmony ranges shown on different product datasheets and packaging.

Plug-in relays	Relays with clamp fixing	
Power relays	Universal relays	Power relays
		
1 CO/15 A 2 CO/15 A 3 CO/15 A 4 CO/15 A	2 CO/10 A 3 CO/10 A	2 CO/10 A 3 CO/10 A
12...110 V	24...230 V 12...220 V	12...110 V
Flat (Faston type)	Cylindrical	Flat (Faston type)
Up to 250 V ~	Up to 250 V ~	Up to 250 V ~
100,000 (1) 10,000,000	100,000 5,000,000	100,000 5,000,000
Yes (depending on version)	Yes (depending on version)	-
Yes	Yes	-
Yes, lockable	Yes, lockable	-
Standard	Low level (depending on version)	Standard
Yes	No	-
Yes	No	-
<b>RPM●●●●</b>	<b>RUM●●●●</b>	<b>RPF●●●●</b>
31	35	39
Sockets without LED	Sockets without LED	



Mixed	Mixed	Separate	-
Screw clamp terminals	Screw connector	-	-
Yes	Yes	-	-
Yes (for 3-pole and 4-pole)	Yes	-	-
Yes (on socket RPZF1)	Yes	-	-
Yes	Yes	-	-
No	No	Yes, 2-pole (Ith = 5 A)	-
16 A	12 A	-	-
<b>RPZF●</b>	<b>RUZC●M</b>	<b>RUZSC●M</b>	<b>RUZSF3M</b>
32	35	-	-

#### Presentation of the range

RSL slim interface relays offer the advantages of compact size and modular design. Their slim width (6 mm/0.236 in.) saves space when mounting on a DIN rail at the back of an enclosure.

RSL relays are available as:

- **Pre-assembled offer:** a single reference comprising a standard relay mounted on its socket.
  - The socket includes a protection circuit (against reverse polarity and surge) and an LED indicator as standard.
  - 2 types of connector are available for wire connection: screw connectors or spring terminals.
  - This pre-assembled solution covers a wide range of operating voltages from 12 to 230 V.
- **Customer assembly offer:**
  - The relay (standard or low level) and the socket are selected, as required, according to the operating voltage of the application.
  - For maintenance, an RSL slim relay can be replaced without disconnecting the socket wiring.

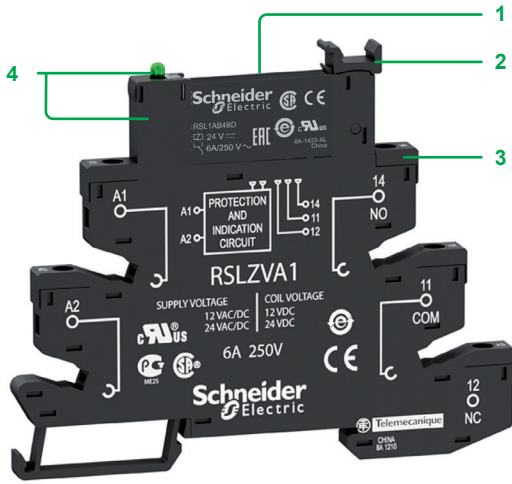

#### Relay description

##### RSL slim interface relays, pre-assembled

- 1 6 A standard relay with 1 CO contact
- 2 Lever for retaining or easy withdrawal of the relay from its socket
- 3 Sockets: wire connection by screw connectors or spring terminals
- 4 Built-in protection circuit and LED indicator on all sockets

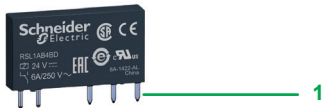

##### RSL slim interface relay

- 1 5 flat (PCB type) standard pins

#### Socket description

##### Sockets for RSL slim interface relays

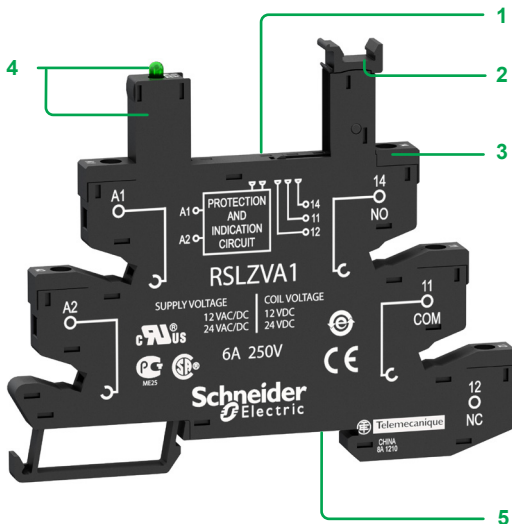

- 1 5 female contacts for the relay pins
- 2 Retaining lever with marker label
- 3 Wire connection by screw connectors or spring terminals
- 4 Built-in protection circuit and LED indicator
- 5 Locating slot for mounting on DIN rail



Pre-assembled slim interface relays					
Standard relays mounted on socket equipped with LED and protection circuit					
1 CO contact - 6A thermal current (Ith)					
Operating voltage V	Control circuit voltage V	Socket type		Spring terminal	
		Screw connector Unit reference	Weight kg/lb	Unit reference	Weight kg/lb
~/~ 12	~ 12	RSL1PVJU (RSL1AB4JD + RSLZVA1)	0.031/0.068	RSL1PRJU (RSL1AB4JD + RSLZRA1)	0.029/0.064
~/~ 24	~ 24	RSL1PVBU (RSL1AB4BD + RSLZVA1)	0.031/0.068	RSL1PRBU (RSL1AB4BD + RSLZRA1)	0.029/0.064
~/~ 48	~ 48	RSL1PVEU (RSL1AB4ED + RSLZVA2)	0.031/0.068	RSL1PREU (RSL1AB4ED + RSLZRA2)	0.029/0.064
~/~ 110	~ 60	RSL1PVFU (RSL1AB4ND + RSLZVA3)	0.031/0.068	RSL1PRFU (RSL1AB4ND + RSLZRA3)	0.029/0.064
~/~ 230	~ 60	RSL1PVPU (RSL1AB4ND + RSLZVA4)	0.031/0.068	RSL1PRPU (RSL1AB4ND + RSLZRA4)	0.029/0.064



Slim interface relays for customer assembly				
Relays with flat (PCB type) standard pins				
1 CO contact - 6A Thermal current (Ith)				
Control circuit voltage V	Standard		Low level	
	Unit reference	Weight kg/lb	Unit reference	Weight kg/lb
~ 12	RSL1AB4JD	0.006/0.013	RSL1GB4JD	0.006/0.013
~ 24	RSL1AB4BD	0.006/0.013	RSL1GB4BD	0.006/0.013
~ 48	RSL1AB4ED	0.006/0.013	RSL1GB4ED	0.006/0.013
~ 60	RSL1AB4ND	0.006/0.013	RSL1GB4ND	0.006/0.013

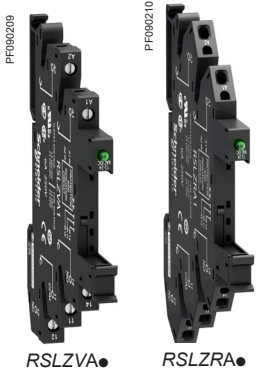

Sockets equipped with LED and protection circuit (Sold in lots of 10)					
Operating voltage V	For use with relays	Socket type		Spring terminal	
		Screw connector Unit reference	Weight kg/lb	Unit reference	Weight kg/lb
~/~ 12 and ~/~ 24	RSL1B4JD RSL1B4BD	RSLZVA1	0.025/0.055	RSLZRA1	0.023/0.051
~/~ 48 and ~/~ 60	RSL1B4ED RSL1B4ND	RSLZVA2	0.025/0.055	RSLZRA2	0.023/0.051
~/~ 110	RSL1B4ND	RSLZVA3	0.025/0.055	RSLZRA3	0.023/0.051
~/~ 230	RSL1B4ND	RSLZVA4	0.025/0.055	RSLZRA4	0.023/0.051



Socket accessories			
Description	For use with	Reference	Weight kg/lb
Clip-in legends (2 sheets of 64 legends)	All sockets	RSLZ5	0.001/0.002
Bus jumper (10 x 20-pole jumper)	All sockets	RSLZ2	0.003/0.007
Partition plate (10 partition plates)	All sockets	RSLZ3	0.001/0.002

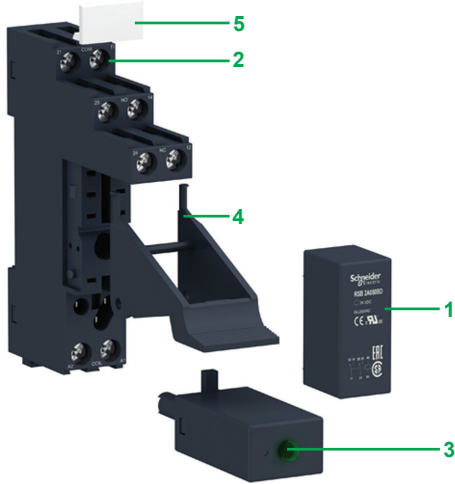

### Presentation of the range

The RSB interface relay range comprises:

- 1 12 A relays with 1 CO contact , 16 A relays with 1 CO contact, and 8 A relays with 2 CO contacts
- 2 Sockets with separate contact terminals
- 3 Protection modules (diode, diode + LED, RC circuit, or varistor + LED) common to all sockets
- 4 A plastic maintaining clamp for all sockets
- 5 Clip-in legend for all sockets

These relays are available in both pre-assembled (single reference) and customer assembled offers.

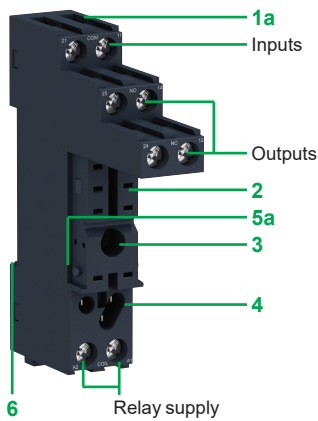

### Socket description

#### Sockets with separate contact terminals (1)

- 1a Connection by screw connector
- 1b Connection by push-in terminal
- 2 5 or 8 female contacts for the relay pins
- 3 Hole for panel mounting
- 4 Location for protection modules
- 5a Locking components for plastic maintaining clamp
- 5b Built-in plastic maintaining clamp for locking components
- 6 Locating slot for mounting on DIN rail
- 7 Test point
- 8 Push button to release wire
- 9 Location for bus jumpers

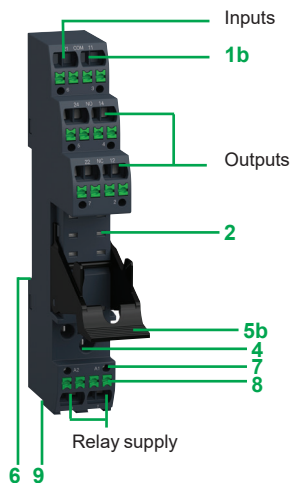

(1) The inputs and outputs are separate from the relay supply.



#### Pre-assembled interface relays

Relays mounted on sockets with protection module (LED version) and integrated clamp  
(sold in lots of 30)

Control circuit voltage V	Number and types of contact - Thermal current (Ith)					
	1 CO - 12 A		1 CO - 16 A		2 CO - 8 A	
	Unit Reference	Weight kg/lb	Unit Reference	Weight kg/lb	Unit Reference	Weight kg/lb
12 $\overline{\text{---}}$	<b>RSB1A120JDPV</b> (RSB1A120JD + RSZE1S35M + RSZR215 + RZM031RB + RSZL300)	0.050/ 0.110	—	—	<b>RSB2A080JDPV</b> (RSB2A080JD + RSZE1S48M + RSZR215 + RZM031RB + RSZL300)	0.057/ 0.126
24 $\overline{\text{---}}$	<b>RSB1A120BDPV</b> (RSB1A120BD + RSZE1S35M + RSZR215 + RZM031RB + RSZL300)	0.050/ 0.110	<b>RSB1A160BDPV</b> (RSB1A160BD + RSZE1S48M + RSZR215 + RZM031RB + RSZL300)	0.057/ 0.126	<b>RSB2A080BDPV</b> (RSB2A080BD + RSZE1S48M + RSZR215 + RZM031RB + RSZL300)	0.057/ 0.126
24 $\sim$	<b>RSB1A120B7PV</b> (RSB1A120B7 + RSZE1S35M + RSZR215 + RZM021RB + RSZL300)	0.050/ 0.110	—	—	<b>RSB2A080B7PV</b> (RSB2A080B7 + RSZE1S48M + RSZR215 + RZM021RB + RSZL300)	0.057/ 0.126
120 $\sim$	<b>RSB1A120F7PV</b> (RSB1A120F7 + RSZE1S35M + RSZR215 + RZM021FP + RSZL300)	0.050/ 0.110	—	—	<b>RSB2A080F7PV</b> (RSB2A080F7 + RSZE1S48M + RSZR215 + RZM021FP + RSZL300)	0.057/ 0.126
220 $\sim$	—	—	—	—	<b>RSB2A080M7PV</b> (RSB2A080M7 + RSZE1S48M + RSZR215 + RZM021FP + RSZL300)	0.057/ 0.126
230 $\sim$	<b>RSB1A120P7PV</b> (RSB1A120P7 + RSZE1S35M + RSZR215 + RZM021FP + RSZL300)	0.050/ 0.110	<b>RSB1A160P7PV</b> (RSB1A160P7 + RSZE1S48M + RSZR215 + RZM021FP + RSZL300)	0.057/ 0.126	<b>RSB2A080P7PV</b> (RSB2A080P7 + RSZE1S48M + RSZR215 + RZM021FP + RSZL300)	0.057/ 0.126



RSB1A120JD + RZM031RB + RSZE1S35M



RSB1A160JD + RSZE1S48M



RSZE05P

### Interface relays for customer assembly

#### RSB interface relays for standard applications (sold in lots of 10)

Control circuit voltage V	Number and type of contacts - Thermal current (lth)			Unit reference	Weight kg/lb
	1 CO - 12 A	1 CO - 16 A	2 CO - 8 A		
6 ---	—	<a href="#">RSB1A160RD</a>	—		0.014/0.031
12 ---	<a href="#">RSB1A120JD</a>	<a href="#">RSB1A160JD</a>	<a href="#">RSB2A080JD</a>		0.014/0.031
24 ---	<a href="#">RSB1A120BD</a>	<a href="#">RSB1A160BD</a>	<a href="#">RSB2A080BD</a>		0.014/0.031
48 ---	<a href="#">RSB1A120ED</a>	<a href="#">RSB1A160ED</a>	<a href="#">RSB2A080ED</a>		0.014/0.031
60 ---	—	<a href="#">RSB1A160ND</a>	—		0.014/0.031
110 ---	<a href="#">RSB1A120FD</a>	<a href="#">RSB1A160FD</a>	<a href="#">RSB2A080FD</a>		0.014/0.031
24 ~	<a href="#">RSB1A120B7</a>	<a href="#">RSB1A160B7</a>	<a href="#">RSB2A080B7</a>		0.014/0.031
48 ~	<a href="#">RSB1A120E7</a>	<a href="#">RSB1A160E7</a>	<a href="#">RSB2A080E7</a>		0.014/0.031
120 ~	<a href="#">RSB1A120F7</a>	<a href="#">RSB1A160F7</a>	<a href="#">RSB2A080F7</a>		0.014/0.031
220 ~	<a href="#">RSB1A120M7</a>	<a href="#">RSB1A160M7</a>	<a href="#">RSB2A080M7</a>		0.014/0.031
230 ~	<a href="#">RSB1A120P7</a>	<a href="#">RSB1A160P7</a>	<a href="#">RSB2A080P7</a>		0.014/0.031
240 ~	<a href="#">RSB1A120U7</a>	<a href="#">RSB1A160U7</a>	<a href="#">RSB2A080U7</a>		0.014/0.031

### Sockets for interface relays

#### Sockets with separate contact terminal arrangement and screw connector connection

Rated insulation voltage	Thermal current (lth)	Relay type	Sold in lots of	Unit reference	Weight kg/lb
250 V ~	12A	RSB1A120●●	10	<a href="#">RSZE1S35M</a>	0.060/0.132
	10A (1)	RSB1A160●● (2) RSB2A080●●	10	<a href="#">RSZE1S48M</a>	0.050/0.110

#### Sockets with separate contact terminal arrangement, push-in terminals, with built-in clamp

Rated insulation voltage	Thermal current (lth)	Relay type	Sold in lots of	Unit reference	Weight kg/lb
250 V ~	12A	RSB1A●●●●●	10	<a href="#">RSZE05P</a>	0.037/0.082
	10A	RSB2A●●●●●	10	<a href="#">RSZE08P</a>	0.042/0.093

### Protection modules

Description	For use with	Voltage V	Sold in lots of	Unit reference	Weight kg/lb
Diode	All sockets	6...230 ---	10	<a href="#">RZM040W</a>	0.003/0.007
RC circuit	All sockets	24...60 ~	10	<a href="#">RZM041BN7</a>	0.010/0.022
		110...240 ~	10	<a href="#">RZM041FU7</a>	0.010/0.022
Diode + green LED	All sockets	6...24 ---	10	<a href="#">RZM031RB</a>	0.004/0.009
		24...60 ---	10	<a href="#">RZM031BN</a>	0.004/0.009
		110...230 ---	10	<a href="#">RZM031FPD</a>	0.004/0.009
Varistor + green LED	All sockets	6...24 ---/~	10	<a href="#">RZM021RB</a>	0.005/0.011
		24...60 ---/~	10	<a href="#">RZM021BN</a>	0.005/0.011
		110...230 ---/~	10	<a href="#">RZM021FP</a>	0.005/0.011

(1) [RSZE1S48M](#) is a two terminal socket each carrying 10 A.

(2) If [RSZE1S48M](#)/[RSZE08P](#) socket terminals are linked, relay RSB1A160●● can be used up to 16 A. See "Wiring diagrams" on [www.se.com/harmonyelectromechanicalrelays](http://www.se.com/harmonyelectromechanicalrelays).

## Accessories

Description	For use with	Sold in lots of	Unit reference	Weight kg/lb
Plastic maintaining clamp	All sockets	10	RSZR215	0.002/0.004



RSZR215

Legend	All sockets	10	RSZL300	0.001/0.002
--------	-------------	----	---------	-------------



RGZS08

Bus jumper (10 x 8-pole jumper)	For inputs (A1, A2) of RSZE screw sockets (RSZE1S35M, RSZE1S48M)	10	RGZS08	0.006/0.013
------------------------------------	---	----	--------	-------------

RS\_SZ2\_CPSCT17003+88-Q



RSZS02

Bus jumper (10 x 2-pole jumper)	For input (A2) of RSZE push-in sockets (RSZE05P, RSZE08P)	10	RSZS02	0.002/0.004
------------------------------------	---	----	--------	-------------

XBK\_CP19318



# Harmony Electromechanical Relays

## Plug-in relays

### RXG interface relays

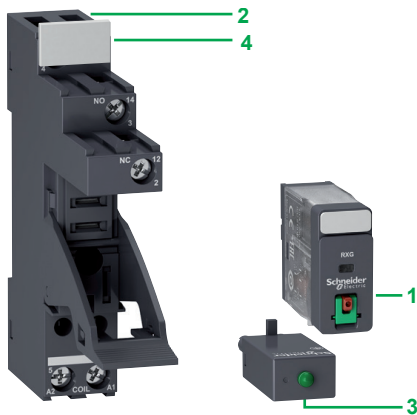

#### Presentation of the range

RXG relays are interface plug-in relays with Faston pins for better reliability and robust installation. They are used in PLC applications.

The RXG interface relay range comprises:

- 1 10 A relays with 1 CO contact and 5 A relays with 2 CO contacts
- 2 Sockets with separate or mixed contact terminals, built-in plastic maintaining clamp
- 3 Protection modules (diode, diode + LED, RC circuit, or varistor + LED) for RXG separate sockets
- 4 Clip-in legends for RXG separate sockets

These relays are available in both pre-assembled (single reference) and customer assembled offers.

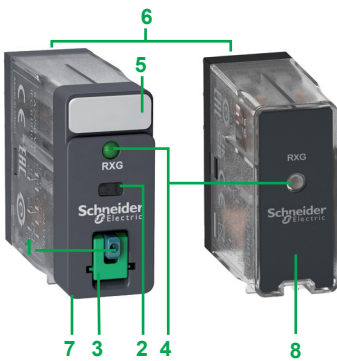

#### Relay description

- 1 Spring-return pushbutton for testing the contacts (green: c, red: a)
- 2 Mechanical "relay status" indicator
- 3 Removable lock-down door enabling forced maintaining of the contacts for test sequences or maintenance purposes
- 4 LED (depending on version) indicating the relay status
- 5 Removable legend for relay identification
- 6 5 or 8 Faston type pins
- 7 Standard cover-type relay with pushbutton, mechanical indicator, and LED options
- 8 Basic cover-type relay with LED option

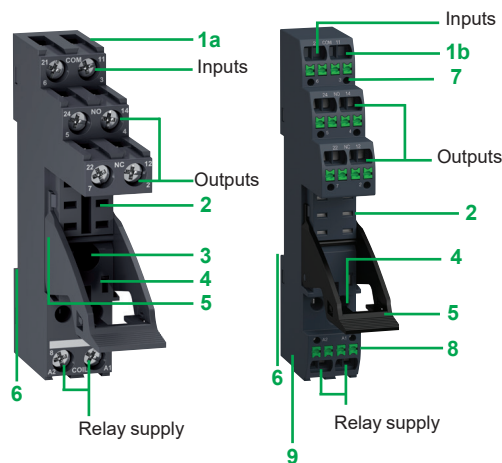

#### Socket description

##### Sockets with separate contact terminals (1)

- 1a Connection by screw connector
- 1b Connection by push-in terminal
- 2 5 or 8 female contacts for the relay pins
- 3 Hole for panel mounting
- 4 Location for protection modules
- 5 Built-in plastic maintaining clamp for locking components
- 6 Locating slot for mounting on DIN rail
- 7 Test point
- 8 Push button to release wire
- 9 Location for bus jumpers

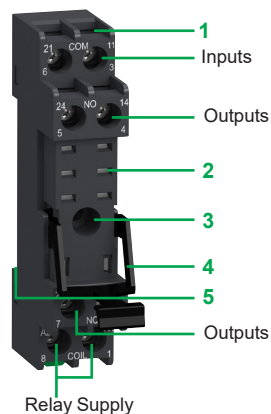

##### Sockets with mixed contact terminals (2)

- 1 Connection by screw clamp
- 2 5 or 8 female contacts for the relay pins
- 3 Hole for panel mounting
- 4 Built-in plastic maintaining clamp for locking components
- 5 Locating slot for mounting on DIN rail

(1) The inputs and outputs are separate from the relay supply.

(2) The outputs NC are mixed with the relay supply, with the outputs NO and inputs being located on the opposite side of the socket.



Pre-assembled interface relays					
Relays with lockable test button and LED, mounted on sockets with protection module and integrated clamp					
Control circuit voltage V	Sold in lots of	Number and type of contacts - Thermal current (Ith)			
		1 CO - 10 A		2 CO - 5 A	
		Unit reference	Weight kg/lb	Unit reference	Weight kg/lb
24 $\overline{\text{---}}$	30	<a href="#">RXG12BDPV</a> (RXG12BD + RGZE1S35M + RZM031RB)	0.059/0.130	<a href="#">RXG22BDPV</a> (RXG22BD + RGZE1S48M + RZM031RB)	0.066/0.145
24 $\sim$	30	<a href="#">RXG12B7PV</a> (RXG12B7 + RGZE1S35M + RZM021RB)	0.059/0.130	<a href="#">RXG22B7PV</a> (RXG22B7 + RGZE1S48M + RZM021RB)	0.067/0.148
230 $\sim$	30	<a href="#">RXG12P7PV</a> (RXG12P7 + RGZE1S35M + RZM021FP)	0.059/0.130	<a href="#">RXG22P7PV</a> (RXG22P7 + RGZE1S48M + RZM021FP)	0.067/0.148

Relays with LED, mounted on sockets with protection module, and integrated clamp					
24 $\overline{\text{---}}$	30	<a href="#">RXG13BDPV</a> (RXG13BD + RGZE1S35M + RZM031RB)	0.058/0.129	<a href="#">RXG23BDPV</a> (RXG23BD + RGZE1S48M + RZM031RB)	0.066/0.145
230 $\sim$	30	<a href="#">RXG13P7PV</a> (RXG13P7 + RGZE1S35M + RZM021FP)	0.059/0.130	<a href="#">RXG23P7PV</a> (RXG23P7 + RGZE1S48M + RZM021FP)	0.067/0.148

Relays with lockable test button and without LED, mounted on sockets with protection module, and integrated clamp					
24 $\overline{\text{---}}$	30			<a href="#">RXG21BDPV</a> (RXG21BD + RGZE1S48M + RZM031RB)	0.067/0.148
24 $\sim$	30			<a href="#">RXG21B7PV</a> (RXG21B7 + RGZE1S48M + RZM021RB)	0.067/0.148
230 $\sim$	30			<a href="#">RXG21P7PV</a> (RXG21P7 + RGZE1S48M + RZM021FP)	0.067/0.148



Interface relays for customer assembly					
Standard cover relays with lockable test button					
6 $\overline{\text{---}}$	10	–		<a href="#">RXG21RD</a>	0.020/0.044
12 $\overline{\text{---}}$	10	–		<a href="#">RXG21JD</a>	0.020/0.044
24 $\overline{\text{---}}$	10	<a href="#">RXG11BD</a>		<a href="#">RXG21BD</a>	0.020/0.044
24 $\sim$	10	<a href="#">RXG11B7</a>		<a href="#">RXG21B7</a>	0.020/0.044
48 $\sim$	10	–		<a href="#">RXG21E7</a>	0.020/0.044
120 $\sim$	10	<a href="#">RXG11F7</a>		<a href="#">RXG21F7</a>	0.020/0.044
230 $\sim$	10	<a href="#">RXG11P7</a>		<a href="#">RXG21P7</a>	0.020/0.044



RXG22B7



RXG13BD



RXG26BD



RXG18P7

**Interface relays for customer assembly**

**Standard cover relays with lockable test button and LED**

Control circuit voltage V	Sold in lots of	Number and type of contacts - Thermal current (Ith)		Weight kg/lb
		1 CO - 10 A	2 CO - 5 A	
		Unit reference	Unit reference	
6 ---	10	RXG12RD	—	0.020/0.044
12 ---	10	RXG12JD	RXG22JD	0.020/0.044
24 ---	10	RXG12BD	RXG22BD	0.020/0.044
48 ---	10	RXG12ED	RXG22ED	0.020/0.044
110 ---	10	RXG12FD	RXG22FD	0.020/0.044
24 ~	10	RXG12B7	RXG22B7	0.020/0.044
48 ~	10	RXG12E7	RXG22E7	0.020/0.044
120 ~	10	RXG12F7	RXG22F7	0.020/0.044
220 ~	10	—	RXG22M7	0.020/0.044
230 ~	10	RXG12P7	RXG22P7	0.020/0.044

**Standard cover relays with LED**

12 ---	10	RXG13JD	—	0.020/0.044
24 ---	10	RXG13BD	RXG23BD	0.020/0.044
24 ~	10	RXG13B7	RXG23B7	0.020/0.044
48 ~	10	—	RXG23E7	0.020/0.044
120 ~	10	RXG13F7	RXG23F7	0.020/0.044
220 ~	10	—	RXG23M7	0.020/0.044
230 ~	10	RXG13P7	RXG23P7	0.020/0.044

**Basic cover relays with LED**

24 ---	10	RXG16BD	RXG26BD	0.019/0.042
230 ~	10	RXG16P7	RXG26P7	0.019/0.042

**Basic cover relays without LED**

24 ---	10	RXG18BD	RXG28BD	0.019/0.042
230 ~	10	RXG18P7	RXG28P7	0.019/0.042

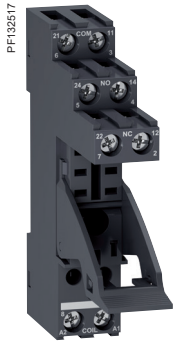

RGZE1S48M



RGZE05P



RGZE05E



RZM031RB



RSZL300



RGZS08



RGZR215

RSZS02

### Sockets for interface relays

Sockets with separate contact terminals arrangement, screw connector connection, and built-in clamp

Description	Thermal current (Ith)	Relay type	Sold in lots of	Unit reference	Weight kg/lb
1 CO socket with 1 pole	10 A	RXG1●●●	10	RGZE1S35M	0.034/0.075
2 CO socket with 2 poles	5 A	RXG2●●●	10	RGZE1S48M	0.042/0.093

Sockets with separate contact terminals arrangement, push-in terminals, and built-in clamp

Description	Thermal current (Ith)	Relay type	Sold in lots of	Unit reference	Weight kg/lb
1 CO socket with 1 pole	10 A	RXG1●●●	10	RGZE05P	0.039/0.086
2 CO socket with 2 poles	5 A	RXG2●●●	10	RGZE08P	0.042/0.093

Sockets with mixed contact terminals arrangement, screw clamp connection, and built-in clamp

Description	Thermal current (Ith)	Relay type	Sold in lots of	Unit reference	Weight kg/lb
1 CO socket with 1 pole	10 A	RXG1●●●	10	RGZE05E	0.024/0.053
2 CO socket with 2 poles	5 A	RXG2●●●	10	RGZE08E	0.026/0.057

### Protection modules

Description	For use with	Voltage V	Sold in lots of	Unit reference	Weight kg/lb
Diode	All separate sockets	6...230 ---	10	RZM040W	0.003/0.007
RC circuit	All separate sockets	24...60 ~	10	RZM041BN7	0.010/0.022
		110...240 ~	10	RZM041FU7	0.010/0.022
Diode + green LED	All separate sockets	6...24 ---	10	RZM031RB	0.004/0.009
		24...60 ---	10	RZM031BN	0.004/0.009
		110...230 ---	10	RZM031FPD	0.004/0.009
Varistor + green LED	All separate sockets	6...24 ~/---	10	RZM021RB	0.005/0.011
		24...60 ~/---	10	RZM021BN	0.005/0.011
		110...230 ~/---	10	RZM021FP	0.005/0.011

### Accessories

Description	For use with	Sold in lots of	Unit reference	Weight kg/lb
Plastic maintaining clamp	All separate sockets	10	RGZR215	0.002/0.004
Legend	All separate sockets	10	RSZL300	0.001/0.002
Clip-in legends (sheet of 16 legends)	All relays	10	RGZL520	0.001/0.002
Bus jumper (10 x 8-pole jumper)	For inputs (A1, A2) of RGZE screw sockets (RGZE1S35M, RGZE1S48M)	10	RGZS08	0.006/0.013
Bus jumper (10 x 2-pole jumper)	For input (A2) of RGZE push-in sockets (RGZE05P, RGZE08P)	10	RSZS02	0.002/0.004

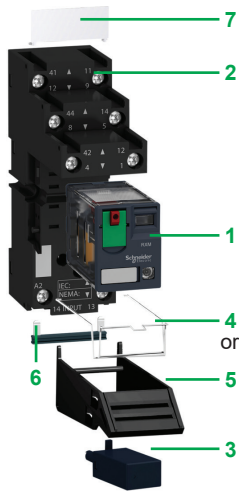

#### Presentation of the range

The RXM miniature relay range comprises:

- 1 12 A relays with 2 CO contacts, 10 A relays with 3 CO contacts, 6 A relays with 4 CO contacts, and 3 A "low level" relays with 4 CO contacts (all these relays have the same dimensions)
- 2 Sockets with mixed or separate contact terminals
- 3 Protection modules (diode, RC circuit, or varistor) common to all sockets
- 4 Metal maintaining clamp for all sockets
- 5 Plastic maintaining clamp for all sockets
- 6 2-pole bus jumper that can be used on sockets with separate contact terminals in order to simplify cabling when creating an equipotential link between the coil terminals
- 7 Clip-in legends for all sockets except RXZE2M114

These relays are available in both pre-assembled (single reference) and customer assembled offers.

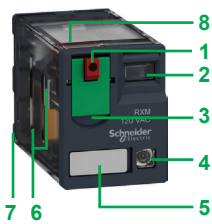

#### Relay description

- 1 Spring-return pushbutton for testing the contacts (green: c, red: a)
- 2 Mechanical "relay status" indicator
- 3 Removable lock-down door enabling forced maintaining of the contacts for test sequences or maintenance purposes
- 4 LED (depending on version) indicating the relay status
- 5 Removable legend for relay identification
- 6 4 notches for rail mounting adapter or panel mounting adapter with mounting lugs
- 7 8, 11, or 14 Faston type pins
- 8 Area by which the product can be easily gripped
- 9 Mounting adapter enabling direct mounting of the relay on a panel
- 10 Mounting adapter enabling direct mounting of the relay on a DIN rail

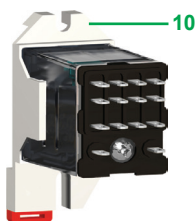

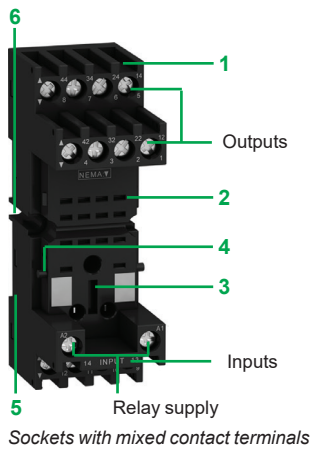

Sockets with mixed contact terminals

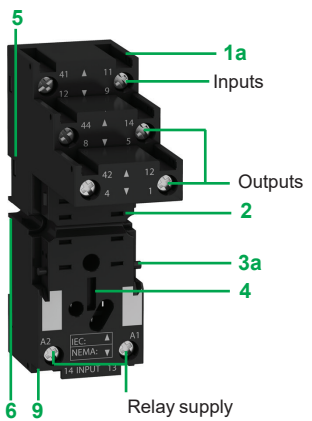

Sockets with separate contact terminals

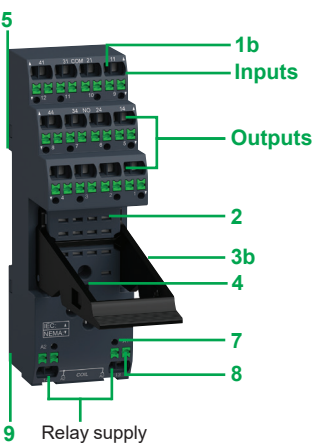

Sockets with separate contact terminals

### Socket description

#### Sockets with mixed contact terminals (1)

- 1 Connection by screw clamp terminals or screw connector
- 2 14 female contacts for the relay pins
- 3 Location for protection modules
- 4 Locking components for plastic and metal maintaining clamps
- 5 Locating slot for mounting on DIN rail with compression spring or mounting clip
- 6 2 or 4 holes for panel mounting

#### Sockets with separate contact terminals (2)

- 1a Connection by screw connector
- 1b Connection by push in terminal
- 2 8, 11, or 14 female contacts for the relay pins
- 3a Locking components for plastic and metal maintaining clamps
- 3b Built-in plastic maintaining clamp for locking components
- 4 Location for protection modules
- 5 Locating slot for mounting on DIN rail with compression spring or mounting clip
- 6 2 holes for panel mounting
- 7 Test point
- 8 Push button to release wire
- 9 Location for bus jumpers

(1) The inputs are mixed with the relay supply, with the outputs being located on the opposite side of the socket.

(2) The inputs and outputs are separate from the relay supply.

# Harmony Electromechanical Relays

## Plug-in relays

### RXM miniature relays

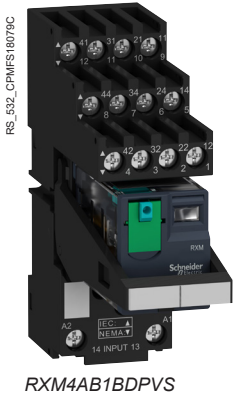

RXM4AB1BDPVS

Pre-assembled interface relays						
Relays without LED, mounted on sockets with clamp and socket legend (sold in lots of 30)						
Control circuit voltage V	Type of socket	Number and type of contacts - Thermal current (Ith)		Weight kg/lb	Unit reference	Weight kg/lb
		2 CO - 10 A	4 CO - 6 A			
24 ~	Mixed terminal socket	-	-	-	RXM4AB1BDPVM (RXM4AB1BD + RXZE2M114M + RXZR335 + RXZL520)	0.099/ 0.218
24 ~		-	-	-	RXM4AB1B7PVM (RXM4AB1B7 + RXZE2M114M + RXZR335 + RXZL520)	0.099/ 0.218
230 ~		-	-	-	RXM4AB1P7PVM (RXM4AB1P7 + RXZE2M114M + RXZR335 + RXZL520)	0.099/ 0.218
24 ~	Separate terminal socket	-	-	-	RXM4AB1BDPVS (RXM4AB1BD + RXZE2S114M + RXZR335 + RXZL520)	0.113/ 0.249
24 ~		-	-	-	RXM4AB1B7PVS (RXM4AB1B7 + RXZE2S114M + RXZR335 + RXZL520)	0.113/ 0.249
230 ~		-	-	-	RXM4AB1P7PVS (RXM4AB1P7 + RXZE2S114M + RXZR335 + RXZL520)	0.113/ 0.249
Relays with LED, mounted on sockets with clamp and socket legend (sold in lots of 30)						
24 ~	Mixed terminal socket	RXM2AB2BDPVM (RXM2AB2BD + RXZE2M114M + RXZR335 + RXZL520)	0.099/ 0.218	RXM4AB2BDPVM (RXM4AB2BD + RXZE2M114M + RXZR335 + RXZL520)	0.099/ 0.218	0.099/ 0.218
24 ~		RXM2AB2B7PVM (RXM2AB2B7 + RXZE2M114M + RXZR335 + RXZL520)	0.099/ 0.218	RXM4AB2B7PVM (RXM4AB2B7 + RXZE2M114M + RXZR335 + RXZL520)	0.099/ 0.218	0.099/ 0.218
230 ~		RXM2AB2P7PVM (RXM2AB2P7 + RXZE2M114M + RXZR335 + RXZL520)	0.099/ 0.218	RXM4AB2P7PVM (RXM4AB2P7 + RXZE2M114M + RXZR335 + RXZL520)	0.099/ 0.218	0.099/ 0.218
24 ~	Separate terminal socket	RXM2AB2BDPVS (RXM2AB2BD + RXZE2S108M + RXZR335 + RXZL520)	0.101/ 0.223	RXM4AB2BDPVS (RXM4AB2BD + RXZE2S114M + RXZR335 + RXZL520)	0.113/ 0.249	0.113/ 0.249
24 ~		RXM2AB2B7PVS (RXM2AB2B7 + RXZE2S108M + RXZR335 + RXZL520)	0.101/ 0.223	RXM4AB2B7PVS (RXM4AB2B7 + RXZE2S114M + RXZR335 + RXZL520)	0.113/ 0.249	0.113/ 0.249
230 ~		RXM2AB2P7PVS (RXM2AB2P7 + RXZE2S108M + RXZR335 + RXZL520)	0.101/ 0.223	RXM4AB2P7PVS (RXM4AB2P7 + RXZE2S114M + RXZR335 + RXZL520)	0.113/ 0.249	0.113/ 0.249



RXM2AB1BD



RXM2AB1F7



RXM2AB2ED



RXM2AB2F7



RXM4GB1BD



RXM4GB1P7



RXM4GB2BD



RXM4GB2F7

### Miniature relays for customer assembly

#### RXM miniature relays without LED (sold in lots of 10)

Control circuit voltage V	Number and type of contacts - Thermal current (Ith)					
	2 CO - 12 A		3 CO - 10 A		4 CO - 6 A	
	Unit reference	Weight kg/lb	Unit reference	Weight kg/lb	Unit reference	Weight kg/lb
12 ---	RXM2AB1JD	0.037/0.082	RXM3AB1JD	0.037/0.082	RXM4AB1JD	0.037/0.082
24 ---	RXM2AB1BD	0.037/0.082	RXM3AB1BD	0.037/0.082	RXM4AB1BD	0.037/0.082
48 ---	RXM2AB1ED	0.037/0.082	RXM3AB1ED	0.037/0.082	RXM4AB1ED	0.037/0.082
110 ---	RXM2AB1FD	0.037/0.082	RXM3AB1FD	0.037/0.082	RXM4AB1FD	0.037/0.082
220 ---	—	—	—	—	RXM4AB1MD	0.037/0.082
24 ~	RXM2AB1B7	0.037/0.082	RXM3AB1B7	0.037/0.082	RXM4AB1B7	0.037/0.082
48 ~	RXM2AB1E7	0.037/0.082	RXM3AB1E7	0.037/0.082	RXM4AB1E7	0.037/0.082
120 ~	RXM2AB1F7	0.037/0.082	RXM3AB1F7	0.037/0.082	RXM4AB1F7	0.037/0.082
230 ~	RXM2AB1P7	0.037/0.082	RXM3AB1P7	0.037/0.082	RXM4AB1P7	0.037/0.082
240 ~	—	—	—	—	RXM4AB1U7	0.037/0.082

#### RXM miniature relays with LED (sold in lots of 10)

12 ---	RXM2AB2JD	0.037/0.082	RXM3AB2JD	0.037/0.082	RXM4AB2JD	0.037/0.082
24 ---	RXM2AB2BD	0.037/0.082	RXM3AB2BD	0.037/0.082	RXM4AB2BD	0.037/0.082
48 ---	RXM2AB2ED	0.037/0.082	—	—	RXM4AB2ED	0.037/0.082
110 ---	RXM2AB2FD	0.037/0.082	RXM3AB2FD	0.037/0.082	RXM4AB2FD	0.037/0.082
125 ---	—	—	—	—	RXM4AB2GD	0.037/0.082
24 ~	RXM2AB2B7	0.037/0.082	RXM3AB2B7	0.037/0.082	RXM4AB2B7	0.037/0.082
48 ~	RXM2AB2E7	0.037/0.082	RXM3AB2E7	0.037/0.082	RXM4AB2E7	0.037/0.082
120 ~	RXM2AB2F7	0.037/0.082	RXM3AB2F7	0.037/0.082	RXM4AB2F7	0.037/0.082
230 ~	RXM2AB2P7	0.037/0.082	RXM3AB2P7	0.037/0.082	RXM4AB2P7	0.037/0.082

#### RXM miniature relays with low level contacts, without LED (sold in lots of 10)

Control circuit voltage V	Number and type of contacts Thermal current (Ith)	
	Unit reference	Weight kg/lb
12 ---	RXM4GB1JD	0.037/0.082
24 ---	RXM4GB1BD	0.037/0.082
24 ~	RXM4GB1B7	0.037/0.082
48 ~	RXM4GB1E7	0.037/0.082
120 ~	RXM4GB1F7	0.037/0.082
230 ~	RXM4GB1P7	0.037/0.082

#### RXM miniature relays with low level contacts, with LED (sold in lots of 10)

12 ---	RXM4GB2JD	0.037/0.082
24 ---	RXM4GB2BD	0.037/0.082
48 ---	RXM4GB2ED	0.037/0.082
125 ---	RXM4GB2GD	0.037/0.082
220 ---	RXM4GB2MD	0.037/0.082
24 ~	RXM4GB2B7	0.037/0.082
48 ~	RXM4GB2E7	0.037/0.082
120 ~	RXM4GB2F7	0.037/0.082
230 ~	RXM4GB2P7	0.037/0.082
240 ~	RXM4GB2U7	0.037/0.082





RXZE2M114M



RXZE14P

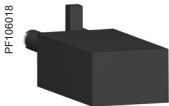

RXM04177

Sockets					
Contact terminal arrangement	Connection	Relay type	Sold in lots of	Unit reference	Weight kg/lb
Mixed	Screw clamp	RXM2●●●●● (3) RXM4●●●●●	10	RXZE2M114 (1)	0.048/0.106
	Screw connector	RXM2●●●●● (3) RXM4●●●●●	10	RXZE2M114M (1)	0.056/0.124
Seperate	Push-in terminal	RXM2●●●●● RXM4●●●●●	10	RXZE14P	0.080/0.176
	Screw connector	RXM2●●●●●	10	RXZE2S108M (2)	0.058/0.128
		RXM3●●●●●	10	RXZE2S111M (1)	0.066/0.146
		RXM4●●●●●	10	RXZE2S114M (1)	0.070/0.154

Protection modules					
Description	Voltage V	For use with	Sold in lots of	Unit reference	Weight kg/lb
Diode	6...250 ---	All sockets	10	RXM040W	0.003/0.007
RC circuit	24...60 ~	All sockets	10	RXM041BN7	0.010/0.022
	110...240 ~	All sockets	10	RXM041FU7	0.010/0.022
Varistor	6...24 ~/---	All sockets	10	RXM021RB	0.030/0.066
	24...60 ~/---	All sockets	10	RXM021BN	0.030/0.066
	110...240 ~/---	All sockets	10	RXM021FP	0.030/0.066

Timing relays			
Description	For use with	Unit reference	Weight kg/lb
2 or 4 timed CO contacts (function A)	RXZE●●●●● sockets	REXL2●● (4)	-
		REXL4●● (4)	-

(1) Thermal current (Ith): 10 A.  
 (2) Thermal current (Ith): 12 A.  
 (3) When mounting relay RXM2●●●●● on socket RXZE2M●●●●●, the thermal current should not exceed 10 A.  
 (4) Please refer to "Harmony Timer Relays" catalog.  
 (5) Test button becomes inaccessible.



REXL4●●



RXZR315



RXZS2



RSZS02



RXZE2FA



RXZ400



RXZL520

Accessories				
Description	For use with	Sold in lots of	Unit reference	Weight kg/lb
Metal maintaining clamp	All sockets	10	<a href="#">RXZ400</a>	0.001/0.002
Plastic maintaining clamp	All sockets except push-in socket RXZE14P	10	<a href="#">RXZR335</a>	0.005/0.011
	RXZE14P	10	<a href="#">RXZR315</a>	0.004/0.009
2-pole bus jumper (lth: 5 A)	All screw sockets with separate contacts (RXZE2S●●●●)	10	<a href="#">RXZS2</a>	0.005/0.011
Bus jumper (10 x 2-pole jumper)	For input (A2) of RXZE push in sockets (RXZE14P)	10	<a href="#">RSZS02</a>	0.002/0.004
Mounting adapter with panel mounting lugs	RXM2●●●●● RXM3●●●●●	10	<a href="#">RXZE2FA</a>	0.002/0.004
Clip-in legends	All relays (sheet of 108 legends)	10	<a href="#">RXZL520</a>	0.080/0.176
	RXZE14P	10	<a href="#">RXZL300</a>	0.004/0.009
	All sockets except RXZE2M114	10	<a href="#">RXZL420</a>	0.001/0.002

(1) Thermal current (lth): 10 A.  
 (2) Thermal current (lth): 12 A.  
 (3) When mounting relay RXM2●●●●● on socket RXZE2M●●●●●, the thermal current should not exceed 10 A.  
 (4) Please refer to "Harmony Timer Relays" catalog.  
 (5) Test button becomes inaccessible.

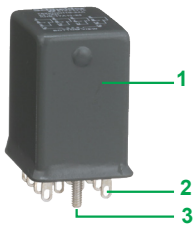

#### Presentation of the range

The hermetically sealed 782H series relays comply with UL Class I Division 2 requirements for use in hazardous locations. They are suitable for installation in harsh, hazardous, and corrosive environments like offshore mining and refineries in the oil and gas, petrochemical, chemical, and mines and minerals sectors.

782H hermetically sealed relays comprise:

- Relays with 3 A/5 A, 2 CO/4 CO contacts
- Sockets with multiple configuration, finger-safe according to IP20, and compatible with DIN rail or panel mounting
- Accessories (protection modules and/or LED indicator)

These relays are available in panel, DIN rail, PCB, and chassis mount versions.

#### Description

##### Relay

- 1 Hermetically sealed enclosure
- 2 Flat (Plug-in type) terminal
- 3 Stub to mount in panel

##### Socket

- 4 There are different types of sockets:
  - DIN rail or panel mount sockets
    - a with screw connector
    - b with screw connector
    - c with screw clamp terminals
  - Other types of terminals
    - d Solder terminals for chassis mount
    - e Printed circuit terminals for PCB mount
- 5 Connection by screw connector
- 6 Location for protection modules
- 7 Solder lug
- 8 PCB pins

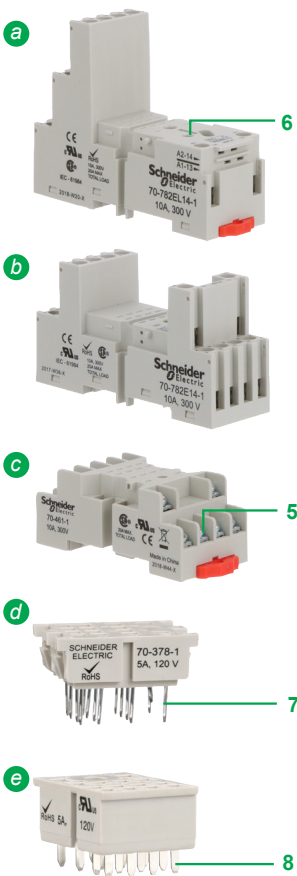



782DXH21-12D

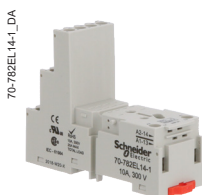

70-782EL14-1



70-782E14-1



70-461-1

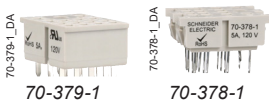

70-379-1

70-378-1

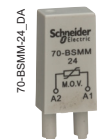

70-BSMM-24

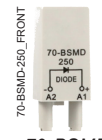

70-BSMD-250



70-BSMLG-24

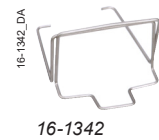

16-1342



RXZS2

#### Plug-in relays

782H hermetically sealed relays (sold in lots of 10)

Coil voltage V	Contact type - Thermal current (Ith)					
	4 CO - 3 A		4 CO - 5 A		2 CO - 5 A	
	Unit reference	Weight kg/lb	Unit reference	Weight kg/lb	Unit reference	Weight kg/lb
6 ~	<a href="#">782DXH10-6A</a>	0.045/0.099	–	–	–	–
24 ~	<a href="#">782DXH10-24A</a>	0.045/0.099	–	–	–	–
120 ~	<a href="#">782DXH10-120A</a>	0.045/0.099	<a href="#">782DXH21-120A</a>	0.045/0.099	–	–
240 ~	<a href="#">782DXH10-240A</a>	0.045/0.099	<a href="#">782DXH21-240A</a>	0.045/0.099	–	–
6 ⋯	<a href="#">782DXH10-6D</a>	0.045/0.099	–	–	–	–
12 ⋯	<a href="#">782DXH10-12D</a>	0.045/0.099	<a href="#">782DXH21-12D</a>	0.045/0.099	–	–
24 ⋯	<a href="#">782DXH10-24D</a>	0.045/0.099	<a href="#">782DXH21-24D</a>	0.045/0.099	<a href="#">782XBXH21-24D</a>	0.045/0.099
48 ⋯	–	–	<a href="#">782DXH21-48D</a>	0.045/0.099	–	–
110 ⋯	<a href="#">782DXH10-110D</a>	0.045/0.099	–	–	–	–

#### Sockets for all 782H relays

Contact terminal arrangement	Connection	Mounting	Unit reference	Sold in lots of	Weight Kg/lb
Mixed	Screw clamp terminals	DIN rail/ Panel	<a href="#">RXZE2M114 (1)</a>	10	0.07/0.154
	Screw connector		<a href="#">RXZE2M114M (1)</a> <a href="#">70-782E14-1</a>		0.06/0.132
	Screw clamp terminals		<a href="#">70-461-1</a>		0.044/0.097
Separate	Screw connector		<a href="#">RXZE2S114M (1)</a> <a href="#">70-782EL14-1</a>		0.06/0.132
	Solder terminals	Chassis	<a href="#">70-378-1</a>		0.007/0.015
	Printed circuit terminals	PCB	<a href="#">70-379-1</a>		0.007/0.015

#### Protection modules

Description	For use with sockets	Coil voltage	Unit reference	Sold in lots of	Weight Kg/lb
Diode	<a href="#">70-782EL14-1</a> , <a href="#">70-782E14-1</a>	6 to 250 ⋯	<a href="#">70-BSMD-250</a>	10	–
MOV suppressor		24 ~	<a href="#">70-BSMM-24</a>		–
		120 ~	<a href="#">70-BSMM-120</a>		–
		240 ~	<a href="#">70-BSMM-240</a>		–
LED indicator		24 ~	<a href="#">70-BSMLG-24</a>		–

#### Accessories

Description	For use with sockets	Unit reference	Sold in lots of	Weight Kg/lb
Metal spring clip	All sockets	<a href="#">16-1342</a>	10	–
Plastic ID tag	<a href="#">70-782E14-1</a> , <a href="#">70-782EL14-1</a>	<a href="#">RXZL420</a>		–
Insulated coil bus jumper system	<a href="#">70-782EL14-1</a>	<a href="#">RXZS2</a>		–

(1) 782H relays are:

- UL Recognized when used with **RXZE** sockets
- UL Listed when used with **70-782** sockets

# Harmony Electromechanical Relays

## Plug-in and DIN rail/Panel mount relays

### 725 power relays

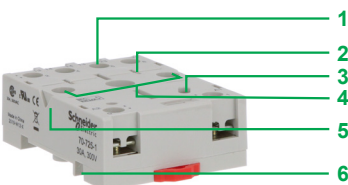
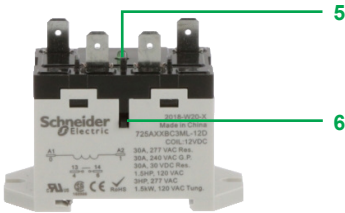
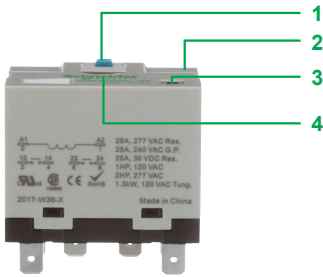
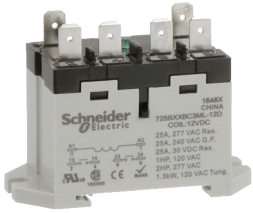

#### Presentation of the range

The 725 series are power relays offering multiple mounting options for ease of use, enhanced reliability, and robust installation. They are used in high-capacity switching applications such as EV charging, CNC machines, and HVAC compressors.

725 power relays comprise:

- 30 A relays with 1 NO contact and 25 A relays with 2 NO contacts
- Socket for plug-in type version with flat (Faston type) terminals
- Protection modules as accessories (diode, separate LED indicator, RC circuit)

Apart from Plug-in relays with flat (Faston type) terminals, these relays are also available in Panel/DIN rail mount versions with screw type and flat (Faston type) terminals.

#### Description

##### Plug-in socket mount power relay

- 1 Spring-return pushbutton for testing the contacts (blue:  $\square$ ; red:  $\sim$ )
- 2 Mechanical "relay status" indicator
- 3 LED indicating the relay status
- 4 Lock-down door enabling forced maintaining of the contacts for testing purposes

##### DIN rail/Panel mount power relay

- 5 LED indicating the relay status
- 6 Side-mounted spring-return pushbutton for testing the contacts
- 7 Touch-proof cover (for screw type terminal)

##### Socket

- 1 Connection by screw connector
- 2 6 female contacts for the relay pins
- 3 Location for protection modules
- 4 Holes for panel mounting
- 5 Spring clip location
- 6 Locating slot for mounting on DIN rail



725AXXBC3ML-12D



725AXXSC3ML-12D



725BXXBM4L-12D



70-725-1



70-ASMD-250

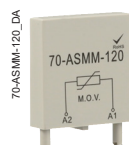

70-ASMM-120

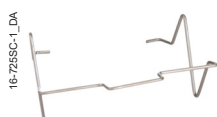

16-725SC-1

### Power relays

#### 725 power relays with DIN rail/Panel mounting (sold in lots of 10)

Coil voltage	Terminal style	Contact type - (Thermal current (Ith))			
		2 NO - 25 A		1 NO - 30 A	
V		Unit reference	Weight kg/lb	Unit reference	Weight kg/lb
24 ~	Flat (Faston type)	<a href="#">725BXXBC3ML-24A</a>	0.120/0.265	<a href="#">725AXXBC3ML-24A</a>	0.120/0.265
	Screw terminals	<a href="#">725BXXSC3ML-24A</a>	0.120/0.265	<a href="#">725AXXSC3ML-24A</a>	0.120/0.265
120 ~	Flat (Faston type)	<a href="#">725BXXBC3ML-120A</a>	0.120/0.265	<a href="#">725AXXBC3ML-120A</a>	0.120/0.265
	Screw terminals	<a href="#">725BXXSC3ML-120A</a>	0.120/0.265	<a href="#">725AXXSC3ML-120A</a>	0.120/0.265
240 ~	Flat (Faston type)	<a href="#">725BXXBC3ML-240A</a>	0.120/0.265	<a href="#">725AXXBC3ML-240A</a>	0.120/0.265
	Screw terminals	<a href="#">725BXXSC3ML-240A</a>	0.120/0.265	<a href="#">725AXXSC3ML-240A</a>	0.120/0.265
12 ∴	Flat (Faston type)	<a href="#">725BXXBC3ML-12D</a>	0.120/0.265	<a href="#">725AXXBC3ML-12D</a>	0.120/0.265
	Screw terminals	<a href="#">725BXXSC3ML-12D</a>	0.120/0.265	<a href="#">725AXXSC3ML-12D</a>	0.120/0.265
24 ∴	Flat (Faston type)	<a href="#">725BXXBC3ML-24D</a>	0.120/0.265	<a href="#">725AXXBC3ML-24D</a>	0.120/0.265
	Screw terminals	<a href="#">725BXXSC3ML-24D</a>	0.120/0.265	<a href="#">725AXXSC3ML-24D</a>	0.120/0.265

#### 725 power relays with Plug-in socket mounting (sold in lots of 10)

24 ~	Flat (Faston type)	<a href="#">725BXXBM4L-24A</a>	0.120/0.265	<a href="#">725AXXBM4L-24A</a>	0.120/0.265
120 ~	Flat (Faston type)	<a href="#">725BXXBM4L-120A</a>	0.120/0.265	<a href="#">725AXXBM4L-120A</a>	0.120/0.265
240 ~	Flat (Faston type)	<a href="#">725BXXBM4L-240A</a>	0.120/0.265	<a href="#">725AXXBM4L-240A</a>	0.120/0.265
12 ∴	Flat (Faston type)	<a href="#">725BXXBM4L-12D</a>	0.120/0.265	<a href="#">725AXXBM4L-12D</a>	0.120/0.265
24 ∴	Flat (Faston type)	<a href="#">725BXXBM4L-24D</a>	0.120/0.265	<a href="#">725AXXBM4L-24D</a>	0.120/0.265

### Socket

Contact terminal arrangement	Connection	Sold in lots of	Relay type	Unit reference	Weight Kg/lb
Separate	Screw connector	10	725 relays with Plug-in socket mount cover	<a href="#">70-725-1</a>	0.055/0.121

### Socket modules

Description	For use with sockets	Sold in lots of	Coil voltage V	Unit reference	Weight Kg/lb
Diode	<a href="#">70-725-1</a>	10	6 to 250 ∴	<a href="#">70-ASMD-250</a>	-

MOV suppressor			24 ~ 120 ~ 240 ~	<a href="#">70-ASMM-24</a> <a href="#">70-ASMM-120</a> <a href="#">70-ASMM-240</a>	-
----------------	--	--	------------------------	--	---

### Socket accessories

Description	For use with sockets	Sold in lots of	Unit reference	Weight Kg/lb
Spring clip	<a href="#">70-725-1</a>	10	<a href="#">16-725SC-1</a>	-

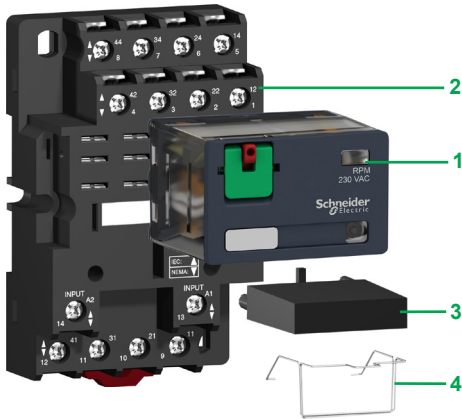

### Presentation of the range

The RPM power relay range comprises:

- 1 15 A relay with 1, 2, 3, and 4 CO contacts
- 2 Sockets with mixed contact terminals
- 3 Protection modules (diode, RC circuit, or varistor) or 1 timer module (these protection modules are common to all sockets except for the timer module, which can be used on 3-pole or 4-pole sockets only)
- 4 Metal maintaining clamp for single-contact relays

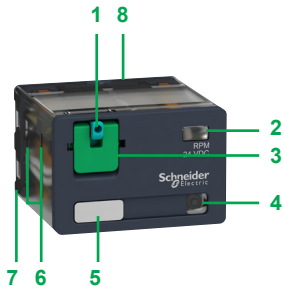

### Relay description

- 1 Spring-return pushbutton for testing the contacts (green: c, red: a)
- 2 Mechanical "relay status" indicator
- 3 Removable lock-down door enabling forced maintaining of the contacts for test sequences or maintenance purposes
- 4 LED (depending on version) indicating the relay status
- 5 Removable legend for relay identification
- 6 4 notches for rail mounting adapter or panel mounting adapter with mounting lugs
- 7 5, 8, 11, or 14 Faston type pins
- 8 Area by which the product can be easily gripped
- 9 Mounting adapter enabling direct mounting of the relay on a panel
- 10 Mounting adapter enabling direct mounting of the relay on a 5 rail

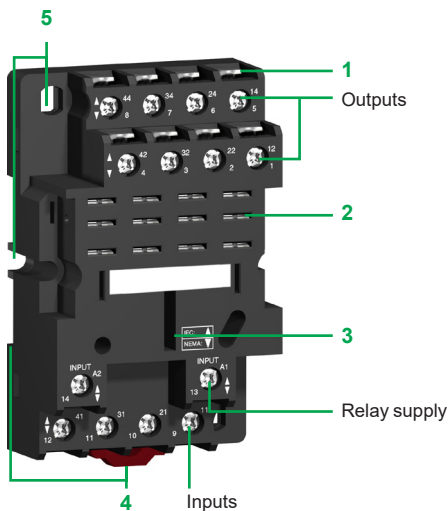
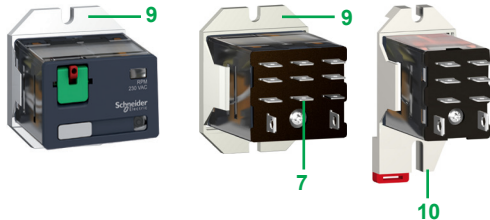

### Socket description

#### Sockets with mixed contact terminals (1)

- 1 Connection by screw clamp terminals
- 2 5, 8, 11, or 14 female contacts for the relay pins
- 3 Location for protection modules or the timer module
- 4 Locating slot for mounting on rail with mounting clip
- 5 2 or 4 holes for panel mounting

(1) The inputs are mixed with the relay supply, with the outputs being located on the opposite side of the socket.



RPM41BD



RPM41P7



RPM42BD



RPM42P7

### Power relays for customer assembly

#### Power relays without LED (sold in lots of 10)

Control circuit voltage V	Number and type of contacts - Thermal current (Ith)				3 CO - 15 A		4 CO - 15 A	
	1 CO - 15 A		2 CO - 15 A		Unit reference	Weight kg/lb	Unit reference	Weight kg/lb
	Unit reference	Weight kg/lb	Unit reference	Weight kg/lb				
12 ---	<a href="#">RPM11JD</a>	0.026/0.057	<a href="#">RPM21JD</a>	0.036/0.079	<a href="#">RPM31JD</a>	0.054/0.119	<a href="#">RPM41JD</a>	0.071/0.157
24 ---	<a href="#">RPM11BD</a>	0.026/0.057	<a href="#">RPM21BD</a>	0.036/0.079	<a href="#">RPM31BD</a>	0.054/0.119	<a href="#">RPM41BD</a>	0.071/0.157
48 ---	<a href="#">RPM11ED</a>	0.026/0.057	<a href="#">RPM21ED</a>	0.036/0.079	<a href="#">RPM31ED</a>	0.054/0.119	<a href="#">RPM41ED</a>	0.071/0.157
110 ---	<a href="#">RPM11FD</a>	0.026/0.057	<a href="#">RPM21FD</a>	0.036/0.079	<a href="#">RPM31FD</a>	0.054/0.119	<a href="#">RPM41FD</a>	0.071/0.157
24 ~	<a href="#">RPM11B7</a>	0.026/0.057	<a href="#">RPM21B7</a>	0.036/0.079	<a href="#">RPM31B7</a>	0.054/0.119	<a href="#">RPM41B7</a>	0.071/0.157
48 ~	<a href="#">RPM11E7</a>	0.026/0.057	<a href="#">RPM21E7</a>	0.036/0.079	<a href="#">RPM31E7</a>	0.054/0.119	<a href="#">RPM41E7</a>	0.071/0.157
120 ~	<a href="#">RPM11F7</a>	0.026/0.057	<a href="#">RPM21F7</a>	0.036/0.079	<a href="#">RPM31F7</a>	0.054/0.119	<a href="#">RPM41F7</a>	0.071/0.157
230 ~	<a href="#">RPM11P7</a>	0.026/0.057	<a href="#">RPM21P7</a>	0.036/0.079	<a href="#">RPM31P7</a>	0.054/0.119	<a href="#">RPM41P7</a>	0.071/0.157

#### Power relays with LED (sold in lots of 10)

12 ---	<a href="#">RPM12JD</a>	0.026/0.057	<a href="#">RPM22JD</a>	0.036/0.079	<a href="#">RPM32JD</a>	0.054/0.119	<a href="#">RPM42JD</a>	0.071/0.157
24 ---	<a href="#">RPM12BD</a>	0.026/0.057	<a href="#">RPM22BD</a>	0.036/0.079	<a href="#">RPM32BD</a>	0.054/0.119	<a href="#">RPM42BD</a>	0.071/0.157
48 ---	<a href="#">RPM12ED</a>	0.026/0.057	<a href="#">RPM22ED</a>	0.036/0.079	<a href="#">RPM32ED</a>	0.054/0.119	<a href="#">RPM42ED</a>	0.071/0.157
110 ---	—	—	<a href="#">RPM22FD</a>	0.036/0.079	—	—	<a href="#">RPM42FD</a>	0.071/0.157
24 ~	<a href="#">RPM12B7</a>	0.026/0.057	<a href="#">RPM22B7</a>	0.036/0.079	<a href="#">RPM32B7</a>	0.054/0.119	<a href="#">RPM42B7</a>	0.071/0.157
48 ~	<a href="#">RPM12E7</a>	0.026/0.057	<a href="#">RPM22E7</a>	0.036/0.079	<a href="#">RPM32E7</a>	0.054/0.119	<a href="#">RPM42E7</a>	0.071/0.157
120 ~	<a href="#">RPM12F7</a>	0.026/0.057	<a href="#">RPM22F7</a>	0.036/0.079	<a href="#">RPM32F7</a>	0.054/0.119	<a href="#">RPM42F7</a>	0.071/0.157
230 ~	<a href="#">RPM12P7</a>	0.026/0.057	<a href="#">RPM22P7</a>	0.036/0.079	<a href="#">RPM32P7</a>	0.054/0.119	<a href="#">RPM42P7</a>	0.071/0.157



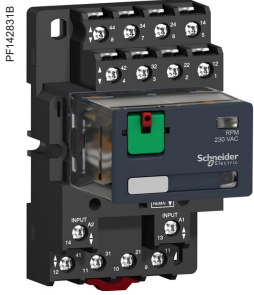

RPZF4 + Relay RPM42P7



RUW24

Sockets					
Contact terminal arrangement	Connection	Relay type	Sold in lots of	Unit reference	Weight kg/lb
Mixed	Screw clamp terminals	RPM1●●●	10	RPZF1	0.042/0.093
		RPM2●●●	10	RPZF2	0.054/0.119
		RPM3●●●	10	RPZF3	0.072/0.159
		RPM4●●●	10	RPZF4	0.094/0.207

Protection modules					
Description	Voltage V	Socket type	Sold in lots of	Unit reference	Weight kg/lb
Diode	6...250 ---	RPZF1 RPZF2	10	RXM040W	0.003/0.007
		RPZF3 RPZF4	10	RUW240BD	0.004/0.009
RC circuit	24...60 ~	RPZF1 RPZF2	10	RXM041BN7	0.010/0.022
		RPZF1 RPZF2	10	RXM041FU7	0.010/0.022
	110...240 ~	RPZF3 RPZF4	10	RUW241P7	0.004/0.009
		RPZF3 RPZF4	10	RXM021RB	0.030/0.066
Varistor	6...24 ~/---	RPZF1 RPZF2	10	RXM021BN	0.030/0.066
	24...60 ~/---	RPZF1 RPZF2	10	RXM021FP	0.030/0.066
	110...240 ~/---	RPZF1 RPZF2	10	RUW242B7	0.004/0.009
	24 ~/---	RPZF3 RPZF4	10	RUW242P7	0.004/0.009
	240 ~/---	RPZF3 RPZF4	10		

Timer module (1)				
Description	Voltage V	Socket type	Reference	Weight kg/lb
Multifunction	24... 240 ~/---	RPZF3 RPZF4	RUW101MW	0.020/0.044

(1) See timer module description (selection of functions and time delays) on [www.se.com/harmonyelectromechanicalrelays](http://www.se.com/harmonyelectromechanicalrelays).

## Accessories

Description	For use with	Sold in lots of	Unit reference	Weight kg/lb
<b>Metal maintaining clamp</b> (for single-pole relays)	RPZF1	10	<a href="#">RPZR235</a>	0.001/0.002
<b>Mounting adapters for <math>\perp</math> rail (1)</b>	RPM4●●●	10	<a href="#">RPZ4DA</a>	0.006/0.013
<b>Mounting adapters with panel mounting lugs</b>	RPM1●●●	10	<a href="#">RPZ1FA</a>	0.002/0.004
	RPM2●●●	10	<a href="#">RXZE2FA</a>	0.002/0.004
	RPM3●●●	10	<a href="#">RPZ3FA</a>	0.003/0.007
<b>Clip-in legends</b> (sheet of 108 legends)	All relays	10	<a href="#">RXZL520</a>	0.080/0.176
<b>Clip-in legends</b> (sheet of 16 legends)	All relays	10	<a href="#">RGZL520</a>	0.080/0.176

(1) Test button becomes inaccessible.

PF 120922



RPZ4DA

PF 120923



RPZ1FA



### Presentation of the range

The RUM universal relay range comprises:

- 1 10 A relays with 2 and 3 CO contacts, and cylindrical or flat (Faston type) pins (all these relays have the same dimensions)
- 2 Sockets with mixed or separate contact terminals
- 3 Protection modules (diode, RC circuit, or varistor) or 1 timer module, common to all RUM sockets
- 4 Metal maintaining clamp for all RUM sockets
- 5 2-pole bus jumper that can be used on sockets with separate contact terminals in order to simplify cabling when creating an equipotential link between the coil terminals
- 6 Clip-in legends for the sockets

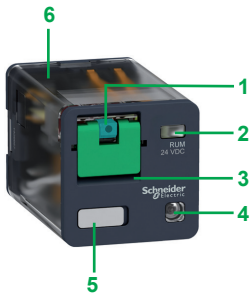

### Relay description

- 1 Spring-return pushbutton for testing the contacts (green: c, red: a)
- 2 Mechanical "relay status" indicator
- 3 Removable lock-down door enabling forced maintaining of the contacts for test sequences or maintenance purposes (1)
- 4 LED (depending on version) indicating the relay status
- 5 Removable legend for relay identification
- 6 Area by which the product can be easily gripped
- 7 8 or 11 cylindrical pins
- 8 8 or 11 flat (Faston type) pins

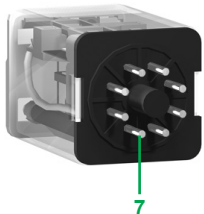

(1) During operation, this lock-down door must always be in the closed position.

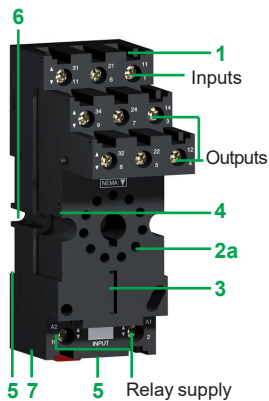

### Socket description

#### Sockets with separate contact terminals (1)

- 1 Connection by screw connector
- 2a 8 or 11 female contacts for the relay cylindrical pins
- 2b 11 female contacts for the relay flat pins
- 3 Location for protection modules or the timer module
- 4 Locking component for metal maintaining clamp
- 5 Locating slot for mounting on DIN rail with mounting clip
- 6 2 holes for panel mounting
- 7 Location for bus jumpers (see dimensions for mounting on sockets on [www.se.com/harmonyelectromechanicalrelays](http://www.se.com/harmonyelectromechanicalrelays))

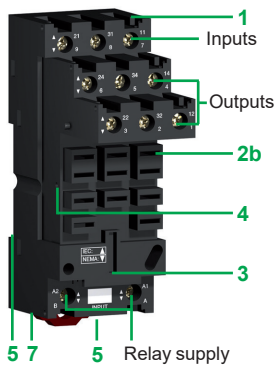

#### Sockets with mixed contact terminals

- 1 Connection by screw connector
- 2 8 or 11 female contacts for the relay cylindrical pins
- 3 Location for protection modules or the timer module
- 4 Locking component for metal maintaining clamp
- 5 A locating slot for mounting on DIN rail
- 6 2 holes for panel mounting

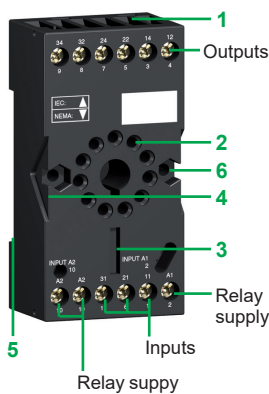

(1) The inputs and outputs are separate from the relay supply.

# Harmony Electromechanical Relays

## Plug-in relays

### RUM universal relays



RUMC21BD



RUMC21F7



RUMC32BD



RUMF32F7

#### Universal relays for customer assembly

Relays for standard applications, with lockable test button and without LED (sold in lots of 10)

Pins	Control circuit voltage V	Number and type of contacts - Thermal current (Ith)			
		2 CO - 10 A		3 CO - 10 A	
		Unit reference	Weight kg/lb	Unit reference	Weight kg/lb
Cylindrical	≡ 12	RUMC21JD	0.086/0.190	RUMC31JD	0.086/0.190
	≡ 24	RUMC21BD	0.086/0.190	RUMC31BD	0.086/0.190
	≡ 48	-	-	RUMC31ED	0.086/0.190
	≡ 60	-	-	RUMC31ND	0.086/0.190
	≡ 110	RUMC21FD	0.086/0.190	RUMC31FD	0.086/0.190
	≡ 125	-	-	RUMC31GD	0.086/0.190
	≡ 220	-	-	RUMC31MD	0.086/0.190
	~ 24	RUMC21B7	0.086/0.190	RUMC31B7	0.086/0.190
	~ 48	-	-	RUMC31E7	0.086/0.190
	~ 120	RUMC21F7	0.086/0.190	RUMC31F7	0.086/0.190
~ 230	RUMC21P7	0.086/0.190	RUMC31P7	0.086/0.190	
Flat (Faston type)	≡ 12	RUMF21JD	0.086/0.190	RUMF31JD	0.086/0.190
	≡ 24	RUMF21BD	0.086/0.190	RUMF31BD	0.086/0.190
	≡ 48	RUMF21ED	0.086/0.190	RUMF31ED	0.086/0.190
	≡ 110	RUMF21FD	0.086/0.190	RUMF31FD	0.086/0.190
	~ 24	RUMF21B7	0.086/0.190	RUMF31B7	0.086/0.190
	~ 48	RUMF21E7	0.086/0.190	RUMF31E7	0.086/0.190
	~ 120	RUMF21F7	0.086/0.190	RUMF31F7	0.086/0.190

#### Relays for standard applications, with lockable test button and LED (sold in lots of 10)

Cylindrical	≡ 12	RUMC22JD	0.086/0.190	RUMC32JD	0.086/0.190
	≡ 24	RUMC22BD	0.086/0.190	RUMC32BD	0.086/0.190
	≡ 48	RUMC22ED	0.086/0.190	RUMC32ED	0.086/0.190
	≡ 110	RUMC22FD	0.086/0.190	RUMC32FD	0.086/0.190
	≡ 125	-	-	RUMC32GD	0.086/0.190
	~ 24	RUMC22B7	0.086/0.190	RUMC32B7	0.086/0.190
	~ 48	RUMC22E7	0.086/0.190	RUMC32E7	0.086/0.190
	~ 120	RUMC22F7	0.086/0.190	RUMC32F7	0.086/0.190
	~ 230	RUMC22P7	0.086/0.190	RUMC32P7	0.086/0.190
	Flat (Faston type)	≡ 12	RUMF22JD	0.086/0.190	RUMF32JD
≡ 24		RUMF22BD	0.086/0.190	RUMF32BD	0.086/0.190
≡ 110		-	0.086/0.190	RUMF32FD	0.086/0.190
~ 24		RUMF22B7	0.086/0.190	RUMF32B7	0.086/0.190
~ 120		RUMF22F7	0.086/0.190	RUMF32F7	0.086/0.190
~ 230		RUMF22P7	0.086/0.190	RUMF32P7	0.086/0.190

(1) The inputs are mixed with the relay supply, with the outputs being located on the opposite side of the socket.

PF140733B

RUZSC3M +  
Relay RUMC3●●●

PF108027



RUW241P7

PF516229



RUW101MW

DF538485



RUZC200

DF535203



RUZS2

Sockets					
Contact terminal arrangement	Connection	Relay type	Sold in lots of	Unit reference	Weight kg/lb
Mixed	Screw connector	RUMC2●●●	10	<a href="#">RUZC2M</a>	0.054/0.119
		RUMC3●●●	10	<a href="#">RUZC3M</a>	0.054/0.119
Separate	Screw connector	RUMC2●●●	10	<a href="#">RUZSC2M</a>	0.095/0.209
		RUMC3●●●	10	<a href="#">RUZSC3M</a>	0.100/0.220
		RUMF2●●●	10	<a href="#">RUZSF3M</a>	0.095/0.209
		RUMF3●●●			
Protection modules					
Description	For use with	Voltage V	Sold in lots of	Unit reference	Weight kg/lb
Diode	All RUM sockets	$\overline{\text{---}}$ 6...250	10	<a href="#">RUW240BD</a>	0.004/0.009
RC circuit	All RUM sockets	$\sim$ 110...240	10	<a href="#">RUW241P7</a>	0.004/0.009
Varistor	All RUM sockets	$\sim/\overline{\text{---}}$ 24	10	<a href="#">RUW242B7</a>	0.004/0.009
		$\sim/\overline{\text{---}}$ 240	10	<a href="#">RUW242P7</a>	0.004/0.009
Timer module					
Description	For use with	Voltage V		Reference	Weight kg/lb
Multifunction	All RUM sockets	$\sim/\overline{\text{---}}$ 24... 240		<a href="#">RUW101MW</a>	0.020/0.044
Timing relays					
Description	For use with			Reference	Weight kg/lb
2 timed CO contacts (single-function or multifunction)	RUZC●M sockets			<a href="#">RE48A●●</a> (1)	–
Accessories					
Description	For use with		Sold in lots of	Unit reference	Weight kg/lb
Metal maintaining clamp	All RUM sockets		10	<a href="#">RUZC200</a>	0.001/0.002
2-pole bus jumper (Ith: 5 A)	All RUM sockets with separate contacts		10	<a href="#">RUZS2</a>	0.005/0.011
Clip-in legends	All relays (sheet of 108 legends)		10	<a href="#">RXZL520</a>	0.086/0.190
	All RUM sockets with separate contacts		10	<a href="#">RUZL420</a>	0.001/0.002

(1) Please refer to "Harmony Timer Relays" catalog.

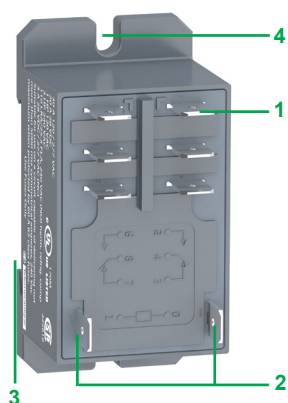

### Presentation of the range

RPF power relays with 2 CO or 2 NO contacts comprise:

- 1 4 or 6 Faston type pins
- 2 2 relay supply pins
- 3 Locating slot for mounting on DIN rail
- 4 2 holes for panel mounting

# Harmony Electromechanical Relays

## Relays with clamp mounting

### RPF power relays

RPF20361C



RPF2A●●

#### Power relays

Control circuit voltage V	Sold in lots	Number and type of contacts - Thermal current (Ith)		Weight kg/lb
		2 NO - 30 A (1) Unit reference	2 CO - 30 A (1) Unit reference	
12 ---	10	RPF2AJD	RPF2BJD	0.082/ 0.181
24 ---	10	RPF2ABD	RPF2BBD	0.082/ 0.181
24 ~	10	RPF2AB7	RPF2BB7	0.082/ 0.181
120 ~	10	RPF2AF7	RPF2BF7	0.082/ 0.181
230 ~	10	RPF2AP7	RPF2BP7	0.082/ 0.181

(1) 30 A when mounted with 13 mm (0.51 in.) gap between two relays and 25 A when mounted side by side without a gap.



# Harmony Electromechanical Relays

## Interface, miniature and power electromechanical relays

Relays			
Contact types			
Symbol	Configuration	EU	USA
	Make contact (Normally Open)	NO	SPST-NO DPST-NO nPST-NO (1)
	Break contact (Normally Closed)	NC	SPST-NC DPST-NC nPST-NC (1)
	Changeover Contact	CO	SPDT DPDT nPDT (1)

Utilization categories		
Category	Type of current	Applications
AC-1	~ 1-phase ~ 3-phase	Resistive or slightly inductive loads
AC-3	~ 3-phase	Starting and braking of squirrel cage motors; reversing direction of rotation only after stopping of motor
AC-4	~ 3-phase	Starting of squirrel cage motors, inching; plugging, reversing direction of rotation
DC-1	---	Resistive or slightly inductive loads (2)
AC-14	~ 1-phase	Control of electromagnetic loads (< 72 VA), auxiliary control relays, power contactors, electromagnetic solenoid valves, and electromagnets
AC-15	~ 1-phase	Control of electromagnetic loads (> 72 VA), auxiliary control relays, power contactors, electromagnetic solenoid valves, and electromagnets
DC-13	---	Control of electromagnetic loads, auxiliary control relays, power contactors, magnetic solenoid valves, and electromagnets

Protection categories		
Category	Explanation	Condition
RT 0	Unenclosed relay	Relay not provided with a protective case
RT I	Dust protected relay	Relay provided with a case that helps to protect its mechanism from dust
RT II	Flux-proof relay	Relay capable of being automatically soldered without allowing the migration of solder fluxes beyond the intended areas
RT III	Wash-tight relay	Relay capable of being automatically soldered and then washed to remove flux residues and minimize the possibility of ingress of flux or washing solvents
RT IV	Sealed relay	Relay provided with a case that has no venting to the outside atmosphere
RT V	Hermetically sealed relay	Sealed relay with an enhanced level of sealing

(1) n = number of contacts.

(2) The switchable voltage can be doubled, for an equal current, by connecting 2 contacts in series.

## Protection modules

Whenever an inductive load is de-energized (coil of a relay or of a contactor), an overvoltage appears at its terminals. This voltage peak can reach several thousand volts and a frequency of several MHz.

It is likely to disturb the operation of automation systems that contain electronic devices.

Protection modules are used to reduce the voltage peak on de-energization and therefore limit the energy of interference signals to a level that will not disturb surrounding coils and electronic devices.

These modules are used to help reduce the risk of:

- electromagnetic compatibility problems
- deterioration of contact materials
- damage to insulation due to overvoltage
- damage to electronic components

## Diode protection module (with or without LED)

### Advantages

- accumulation of energy allowing current to flow in the same direction
- absence of any voltage peaks at the coil terminals
- low cost

### Disadvantages

- increase in relay drop-out time (3 to 4 times the usual time)
- no polarity protection
- de-energization of the relay

## Protection module with varistor

### Advantages

- can be used with  $\sim$  and  $\text{---}$  supply
- voltage peak limited to about  $2 U_n$
- little effect on relay drop-out time

### Disadvantages

- no modification of coil's own oscillating frequency
- limitation of switching frequency

## Protection module with RC circuit

### Advantages

- coil oscillating frequency reduced to about 150 Hz
- voltage peak limited to  $3 U_n$
- little effect on relay drop-out time

### Disadvantages

- no protection for low voltages

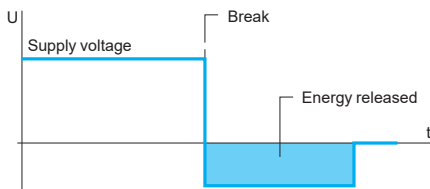

Coil voltage with diode protection module ( $\text{---}$  only)

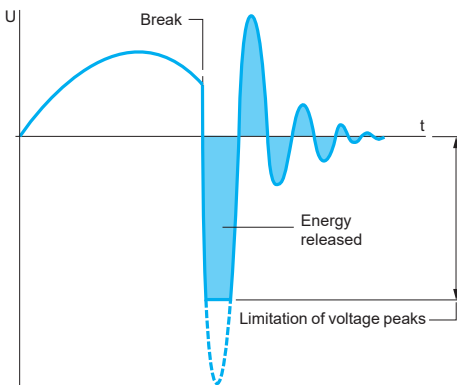

Coil voltage with varistor protection module ( $\sim$  and  $\text{---}$ )

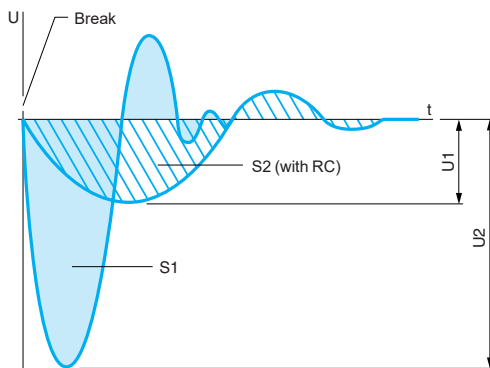

S1 = S2 = Energy released

Coil voltage with RC circuit protection module ( $\sim$  only)

#	R				
16-1342	27	RE48A●●	37	RPM31P7	31
16-725SC-1	29	REXL2●●	24	RPM32B7	31
70-378-1	27	REXL4●●	24	RPM32BD	31
70-379-1	27	RGZE05E	19	RPM32E7	31
70-461-1	27	RGZE05P	19	RPM32ED	31
70-725-1	29	RGZE08E	19	RPM32F7	31
70-782E14-1	27	RGZE08P	19	RPM32JD	31
70-782EL14-1	27	RGZE1S35M	19	RPM32P7	31
70-ASMD-250	29	RGZE1S48M	19	RPM41B7	31
70-ASMM-120	29	RGZL520	19	RPM41BD	31
70-ASMM-24	29		33	RPM41E7	31
70-ASMM-240	29	RGZR215	19	RPM41ED	31
70-BSMD-250	27	RGZS08	15	RPM41F7	31
70-BSMLG-24	27		19	RPM41FD	31
70-BSMM-120	27	RPF2AB7	39	RPM41JD	31
70-BSMM-24	27	RPF2ABD	39	RPM41P7	31
70-BSMM-240	27	RPF2AF7	39	RPM42B7	31
725AXXBC3ML-120A	29	RPF2AJD	39	RPM42BD	31
725AXXBC3ML-12D	29	RPF2AP7	39	RPM42E7	31
725AXXBC3ML-240A	29	RPF2BB7	39	RPM42ED	31
725AXXBC3ML-24A	29	RPF2BBD	39	RPM42F7	31
725AXXBC3ML-24D	29	RPF2BF7	39	RPM42FD	31
725AXXB4ML-120A	29	RPF2BJD	39	RPM42JD	31
725AXXB4ML-12D	29	RPF2BP7	39	RPM42P7	31
725AXXB4ML-240A	29	RPM11B7	31	RPZ1FA	33
725AXXB4ML-24A	29	RPM11BD	31	RPZ3FA	33
725AXXB4ML-24D	29	RPM11E7	31	RPZ4DA	33
725AXXSC3ML-120A	29	RPM11ED	31	RPZF1	32
725AXXSC3ML-12D	29	RPM11F7	31	RPZF2	32
725AXXSC3ML-240A	29	RPM11FD	31	RPZF3	32
725AXXSC3ML-24A	29	RPM11JD	31	RPZF4	32
725AXXSC3ML-24D	29	RPM11P7	31	RPZR235	33
725BXXBC3ML-120A	29	RPM12B7	31	RSB1A120B7	14
725BXXBC3ML-12D	29	RPM12BD	31	RSB1A120B7PV	13
725BXXBC3ML-240A	29	RPM12E7	31	RSB1A120BD	14
725BXXBC3ML-24A	29	RPM12ED	31	RSB1A120BDPV	13
725BXXBC3ML-24D	29	RPM12F7	31	RSB1A120E7	14
725BXXBM4L-120A	29	RPM12JD	31	RSB1A120ED	14
725BXXBM4L-12D	29	RPM12P7	31	RSB1A120F7	14
725BXXBM4L-240A	29	RPM21B7	31	RSB1A120F7PV	13
725BXXBM4L-24A	29	RPM21BD	31	RSB1A120FD	14
725BXXBM4L-24D	29	RPM21E7	31	RSB1A120JD	14
725BXXSC3ML-120A	29	RPM21ED	31	RSB1A120JDPV	13
725BXXSC3ML-12D	29	RPM21F7	31	RSB1A120M7	14
725BXXSC3ML-240A	29	RPM21FD	31	RSB1A120P7	14
725BXXSC3ML-24A	29	RPM21JD	31	RSB1A120P7PV	13
725BXXSC3ML-24D	29	RPM21P7	31	RSB1A120U7	14
782XBXH21-24D	27	RPM22B7	31	RSB1A160B7	14
782XDXH10-110D	27	RPM22BD	31	RSB1A160BD	14
782XDXH10-120A	27	RPM22E7	31	RSB1A160BDPV	13
782XDXH10-12D	27	RPM22ED	31	RSB1A160E7	14
782XDXH10-240A	27	RPM22F7	31	RSB1A160ED	14
782XDXH10-24A	27	RPM22FD	31	RSB1A160F7	14
782XDXH10-24D	27	RPM22JD	31	RSB1A160FD	14
782XDXH10-6A	27	RPM22P7	31	RSB1A160JD	14
782XDXH10-6D	27	RPM31B7	31	RSB1A160M7	14
782XDXH21-120A	27	RPM31BD	31	RSB1A160ND	14
782XDXH21-12D	27	RPM31E7	31	RSB1A160P7	14
782XDXH21-240A	27	RPM31ED	31	RSB1A160P7PV	13
782XDXH21-24D	27	RPM31F7	31	RSB1A160RD	14
782XDXH21-48D	27	RPM31FD	31	RSB1A160U7	14
		RPM31JD	31	RSB2A080B7	14
				RSB2A080B7PV	13
				RSB2A080BD	14
				RSB2A080BDPV	13
				RSB2A080E7	14
				RSB2A080ED	14
				RSB2A080F7	14
				RSB2A080F7PV	13
				RSB2A080FD	14
				RSB2A080JD	14
				RSB2A080JDPV	13
				RSB2A080M7	14
				RSB2A080M7PV	13
				RSB2A080P7	14
				RSB2A080P7PV	13
				RSB2A080U7	14
				RSL1AB4BD	11
				RSL1AB4ED	11
				RSL1AB4JD	11
				RSL1AB4ND	11
				RSL1GB4BD	11
				RSL1GB4ED	11
				RSL1GB4JD	11
				RSL1GB4ND	11
				RSL1PRBU	11
				RSL1PREU	11
				RSL1PRFU	11
				RSL1PRJU	11
				RSL1PRPU	11
				RSL1PVBU	11
				RSL1PVEU	11
				RSL1PVFU	11
				RSL1PVJU	11
				RSL1PVPU	11
				RSLZ2	11
				RSLZ3	11
				RSLZ5	11
				RSLZRA1	11
				RSLZRA2	11
				RSLZRA3	11
				RSLZRA4	11
				RSLZVA1	11
				RSLZVA2	11
				RSLZVA3	11
				RSLZVA4	11
				RSZE05P	14
				RSZE08P	14
				RSZE1S35M	14
				RSZE1S48M	14
				RSZL300	15
					19
				RSZR215	15
				RSZS02	15
					19
					25
				RUMC21B7	36
				RUMC21BD	36
				RUMC21F7	36
				RUMC21FD	36
				RUMC21JD	36
				RUMC21P7	36
				RUMC22B7	36
				RUMC22BD	36
				RUMC22E7	36
				RUMC22ED	36
				RUMC22F7	36
				RUMC22FD	36
				RUMC22JD	36
				RUMC22P7	36
				RUMC31B7	36
				RUMC31BD	36
				RUMC31E7	36
				RUMC31ED	36
				RUMC31F7	36
				RUMC31FD	36
				RUMC31GD	36
				RUMC31JD	36
				RUMC31MD	36
				RUMC31ND	36
				RUMC31P7	36
				RUMC32B7	36
				RUMC32BD	36
				RUMC32E7	36
				RUMC32ED	36
				RUMC32F7	36
				RUMC32FD	36
				RUMC32GD	36
				RUMC32JD	36
				RUMC32P7	36
				RUMF21B7	36
				RUMF21BD	36
				RUMF21E7	36
				RUMF21ED	36
				RUMF21F7	36
				RUMF21FD	36
				RUMF21JD	36
				RUMF21B7	36
				RUMF22BD	36
				RUMF22F7	36
				RUMF22JD	36
				RUMF22P7	36
				RUMF31B7	36
				RUMF31BD	36
				RUMF31E7	36
				RUMF31ED	36
				RUMF31F7	36
				RUMF31FD	36
				RUMF31JD	36
				RUMF32B7	36
				RUMF32BD	36
				RUMF32F7	36
				RUMF32FD	36
				RUMF32JD	36
				RUMF32P7	36
				RUMF32P7	36
				RUW101MW	32
					37
				RUW240BD	32
					37
				RUW241P7	32
					37
				RUW242B7	32
					37
				RUW242P7	32
					37
				RUZC200	37
				RUZC2M	37
				RUZC3M	37

RUZL420	37	RXG26BD	18	RXM4AB1JD	23	RZM021RB	14
RUZS2	37	RXG26P7	18	RXM4AB1MD	23		19
RUZSC2M	37	RXG28BD	18	RXM4AB1P7	23	RZM031BN	14
RUZSC3M	37	RXG28P7	18	RXM4AB1P7PVM	22		19
RUZSF3M	37	RXM021BN	24	RXM4AB1P7PVS	22	RZM031FPD	14
RXG11B7	17		32	RXM4AB1U7	23		19
RXG11BD	17	RXM021FP	24	RXM4AB2B7	23	RZM031RB	14
RXG11F7	17		32	RXM4AB2B7PVM	22		19
RXG11P7	17	RXM021RB	24	RXM4AB2B7PVS	22	RZM040W	14
RXG12B7	18		32	RXM4AB2BD	23		19
RXG12B7PV	17	RXM040W	24	RXM4AB2BDPVM	22	RZM041BN7	14
RXG12BD	18		32	RXM4AB2BDPVS	22		19
RXG12BDPV	17	RXM041BN7	24	RXM4AB2BDPVS	22	RZM041FU7	14
RXG12E7	18	RXM041FU7	24	RXM4AB2E7	23		19
RXG12ED	18		32	RXM4AB2ED	23		
RXG12F7	18	RXM2AB1B7	23	RXM4AB2F7	23		
RXG12FD	18	RXM2AB1BD	23	RXM4AB2FD	23		
RXG12JD	18	RXM2AB1E7	23	RXM4AB2GD	23		
RXG12P7	18	RXM2AB1ED	23	RXM4AB2JD	23		
RXG12P7PV	17	RXM2AB1F7	23	RXM4AB2P7	23		
RXG12RD	18	RXM2AB1FD	23	RXM4AB2P7PVM	22		
RXG13B7	18	RXM2AB1JD	23	RXM4AB2P7PVS	22		
RXG13BD	18	RXM2AB1P7	23	RXM4AB2P7PVS	22		
RXG13BDPV	17	RXM2AB2B7	23	RXM4GB1B7	23		
RXG13F7	18	RXM2AB2B7PVM	22	RXM4GB1BD	23		
RXG13JD	18	RXM2AB2B7PVS	22	RXM4GB1E7	23		
RXG13P7	18	RXM2AB2BD	23	RXM4GB1F7	23		
RXG13P7PV	17	RXM2AB2BDPVM	22	RXM4GB1JD	23		
RXG16BD	18	RXM2AB2BDPVS	22	RXM4GB1P7	23		
RXG16P7	18	RXM2AB2E7	23	RXM4GB2B7	23		
RXG18BD	18	RXM2AB2ED	23	RXM4GB2BD	23		
RXG18P7	18	RXM2AB2F7	23	RXM4GB2E7	23		
RXG21B7	17	RXM2AB2FD	23	RXM4GB2ED	23		
RXG21B7PV	17	RXM2AB2JD	23	RXM4GB2F7	23		
RXG21BD	17	RXM2AB2JD	23	RXM4GB2GD	23		
RXG21BDPV	17	RXM2AB2P7	23	RXM4GB2JD	23		
RXG21E7	17	RXM2AB2P7PVM	22	RXM4GB2MD	23		
RXG21F7	17	RXM2AB2P7PVS	22	RXM4GB2P7	23		
RXG21JD	17	RXM3AB1B7	23	RXM4GB2U7	23		
RXG21P7	17	RXM3AB1BD	23	RXZ400	25		
RXG21P7PV	17	RXM3AB1E7	23	RXZE14P	24		
RXG21RD	17	RXM3AB1ED	23	RXZE2FA	25		
RXG22B7	18	RXM3AB1F7	23	RXZE2FA	33		
RXG22B7PV	17	RXM3AB1FD	23	RXZE2M114	24		
RXG22BD	18	RXM3AB1JD	23		27		
RXG22BDPV	17	RXM3AB1P7	23	RXZE2M114M	24		
RXG22E7	18	RXM3AB2B7	23		27		
RXG22ED	18	RXM3AB2BD	23	RXZE2S108M	24		
RXG22F7	18	RXM3AB2E7	23	RXZE2S111M	24		
RXG22FD	18	RXM3AB2F7	23	RXZE2S114M	24		
RXG22JD	18	RXM3AB2FD	23		27		
RXG22M7	18	RXM3AB2JD	23	RXZL300	25		
RXG22P7	18	RXM3AB2P7	23	RXZL420	25		
RXG22P7PV	17	RXM4AB1B7	23		27		
RXG23B7	18	RXM4AB1B7PVM	22	RXZL520	25		
RXG23BD	18	RXM4AB1B7PVS	22		33		
RXG23BDPV	17	RXM4AB1BD	23		37		
RXG22E7	18	RXM4AB1BDPVM	22	RXZR315	25		
RXG22ED	18	RXM4AB1BDPVS	22	RXZR335	25		
RXG22F7	18	RXM4AB1E7	23	RXZS2	27		
RXG22JD	18	RXM4AB1ED	23	RXZS2	25		
RXG22M7	18	RXM4AB1F7	23	RZM021BN	14		
RXG22P7	18	RXM4AB1FD	23		19		
RXG22P7PV	17			RZM021FP	14		
RXG23B7	18				19		
RXG23BD	18						
RXG23BDPV	17						
RXG23E7	18						
RXG23F7	18						
RXG23M7	18						
RXG23P7	18						
RXG23P7PV	17						

# mySchneider, your personalized digital experience

Access an all-in-one customized online experience and benefit from tailored business services, resources, and tools to efficiently support your business operations.

- **Efficiency:** In just a few clicks, find all the information and support you need to get the job done.
- **Simplicity:** Use a single login to access all business services, in one place, available 24/7. You no longer need to log in to multiple platforms.
- **Personalization:** Benefit from content, tools, and business services tailored to your activity, and customize your landing page based on your preferences.

## Watch the How-to Videos



### Order management

- > [Select Products and Add to Cart](#)
- > [Check for Products' Price and Availability](#)
- > [Order Products with Generic Commercial References](#)



### Product information

- > [Find a Product Data Sheet and Related Documents](#)
- > [Select Products and Add to Cart](#)
- > [Stay Up to Date on the Status of My Products](#)



### Support

- > [Get Quicker Answers Thanks to Online Support](#)

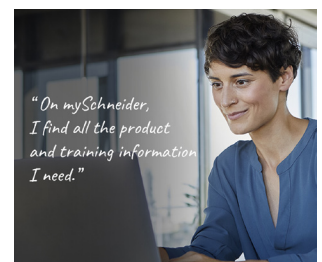

### Training

- > [Access Trainings Dedicated to My Activity](#)

[Create your account](#)

Life Is 

**Schneider**  
Electric

# Legal information

The information provided in this Catalog contains description of Schneider Electric products, solutions and services ("Offer") with technical specifications and technical characteristics of the performance of the corresponding Offer.

The content of this document is subject to revision at any time without notice due to continued progress in methodology, design and manufacturing.

To the extent permitted by applicable law, no responsibility or liability is assumed by Schneider Electric and its subsidiaries for any type of damages arising out of or in connection with (i) informational content of this Catalog not conforming with or exceeding the technical specifications, or (ii) any error contained in this Catalog, or (iii) any use, decision, act or omission made or taken on basis of or in reliance on any information contained or referred to in this Catalog.

SCHNEIDER ELECTRIC MAKES NO WARRANTY OR REPRESENTATION OF ANY KIND, WHETHER EXPRESS OR IMPLIED, AS TO WHETHER THIS CATALOG OR ANY INFORMATION CONTAINED THEREIN SUCH AS PRODUCTS AND SERVICES WILL MEET REQUIREMENTS, EXPECTATIONS OR PURPOSE OF ANY PERSON MAKING USE THEREOF.

Schneider Electric brand and any trademarks of Schneider Electric and its subsidiaries referred to in this Catalog are property of Schneider Electric or its subsidiaries. All other brands are trademarks of their respective owners.

This Catalog and its content are protected under applicable copyright laws and provided for informative use only. No part of this Catalog may be reproduced or transmitted in any form or by any means (electronic, mechanical, photocopying, recording, or otherwise), for any purpose, without the prior written permission of Schneider Electric.

Copyright, intellectual, and all other proprietary rights in the content of this Catalog (including but not limited to software, audio, video, text, and photographs) rests with Schneider Electric or its licensors. All rights in such content not expressly granted herein are reserved. No rights of any kind are licensed or assigned or shall otherwise pass to persons accessing this information.

Life Is On



Learn more about our products at  
[www.se.com/automationrelays](http://www.se.com/automationrelays)

Design: Schneider Electric  
Photos: Schneider Electric

**Schneider Electric Industries SAS**

Head Office  
35, rue Joseph Monier - CS 30323  
F-92500 Rueil-Malmaison Cedex  
France

DIA5ED2130303EN  
July 2024 - V7.0