

Section 15

Medical Products

Line Isolation Monitor (LIM)	15-2
Line Isolation Monitor—Remote Indicators	15-7
Remote Indicator	15-8
IG2000CBM	15-8
Accessories	15-9
Hospital Ground Cords and Jacks	15-10
Receptacle Modules for Controlled Panels	15-11



Isolated Power System



Iso-Gard Series 6 LIM



X-Ray/Power Receptacle Module

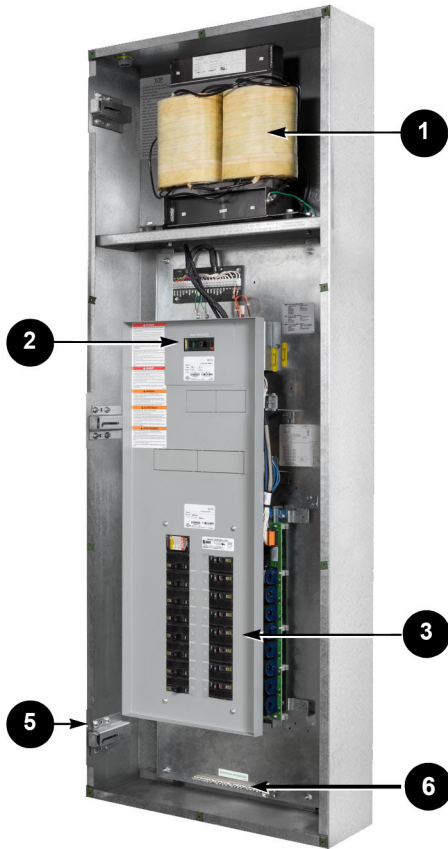

Overview of Isolated Power System

Schneider Electric has been involved in the design and manufacture of isolated power systems since 1944. Our isolated power systems have evolved over the years and will continue to do so to meet the ever-changing needs of the health care industry.

An isolated power system offers an invaluable advantage in medical settings. It serves as a predictive system, rather than a reactive one, to supply early detection of potential total hazardous current. Early detection gives hospital personnel:

- Visual indication of potential leakage current via a line isolation monitor (LIM)
- Alarming via audible and visual indications when the power system exceeds a pre-set threshold level

With this information, hospital workers can then take appropriate measures to help ensure critical systems remain active.

An isolated, ungrounded, electrical distribution system from Schneider Electric contains the following components:

1	Isolation Transformer —specifically designed with low leakage current per UL 1047. Includes electrostatic shielding for noise attenuation in the ungrounded system.
2	PowerPact™ Circuit Breaker —used for main equipment disconnect; can be coordinated with QOB branch circuit breakers
3	NQ Interior —provides space for up to 16 branch circuit breakers
4	Iso-Gard™ Line Isolation Monitor (LIM) —shipped with interior (not shown below)
5	Hinged Back Box/Trim System —this system houses all other components
6	Ground Bus—ALCU

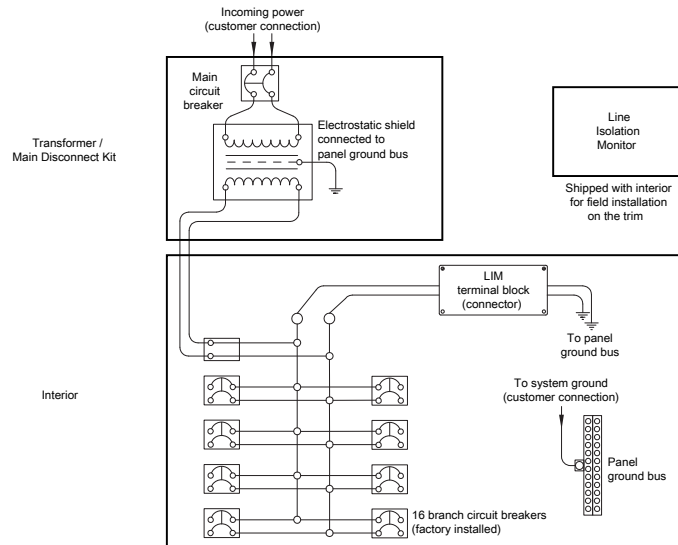

Multiple Configurations of the Isolation Power System

Standard Isolation System

Standard System offer the most compact solution for a single isolated power system feeding one operating room.

- Designed to support either 120 or 208 V power requirements in the operating room
- 120 V Systems are available in 3, 5, 7.5, and 10 kVA designs
 - Space for 16 branch circuits
- 208 V Systems are available in 7.5, 10, 15, and 25 kVA designs
 - Space for 16 branch circuits

Duplex Isolation Systems

Duplex Systems allow for two standard systems to be mounted in a common backbox and use a common trim. Backbox is barrier to keep the two-system separate. Requires two unique feeds. Solution also offers one side to be design for future space.

- Designed to support either 120 or 208 V power requirements in the operating room
- 120 V Systems are available in 3, 5, 7.5, and 10 kVA designs
 - Space for 16 branch circuits
- 208 V Systems are available in 7.5 and 10 kVA designs
 - Space for 16 branch circuits

Dual Voltage Isolation System

Dual Voltage System are designed to feed both 120 and 208 V power via one Isolation System. Incorporate a transformer with one primary winding and two secondary windings. Supply via One Feed.

- Designed to support both 120 and 208 V power requirements in the operating room
- 120 V Systems are available in 5, 7.5 and 10 kVA
 - Space for 16 branch circuits
- 208 V Systems are available in 7.5 and 15 kVA
 - Space for four branch circuits

Controlled Isolation System

Controlled Systems are designed to provide 208 V of isolated power to multiple areas from one central location. A programmable logic controller (PLC) lets the system be designed to feed multiple load location, but only provide power to specific power modules. This helps prevent overloading of the system, and compliance with 200,000 resistance requirements of NEC, since the PLC limits number of circuits. (Default is one circuit energized)

- Designed to support 208 V power requirements for multiple locations
 - Options for 4, 8, or 12 branch circuits – preconfigured at the factory
- Modular Design provides maximum flexibility and easy for upgrading and changing the system



Standard



Duplex

Table 15.1: Interiors Standard and Duplex Systems Interiors: Line Isolation Monitor, Line Isolation connector terminal, 125 Amp 250 V NQ Panel Board with copper bus, Dead front, Space for Main Breaker (field installed), allocated space for field installed accessory.

Catalog Number	Branch Breakers Factory Installed	Spaces	Line Isolation Monitor	LIM Connector terminals	Ground Bus	Fit into BackBox
SMIPB	(16) QOB220	(0)	IG6M	4800IG6C	PK23GTA/Q1100AN	SB662408F SB662408S
SMIPBA212	(12) QOB220	(4)	IG6M	4800IG6C	PK23GTA/Q1100AN	SB803608F
SMIPAN	None	(16)	IG6M	4800IG6C	PK23GTA/Q1100AN	SB803608S
SMIE	None	(16)	IG6M	4800IG6C	PK23GTA/Q1100AN	SB723014F SB723014S

Allocated space for field installed power modules require TRIM with removal blank plate, example: **ST8238R**

Table 15.2: Interiors Dual Voltage Systems Interiors: Line Isolation Monitor, Line Isolation connector terminal, 120 V Side: 125 Amp 250 V NQ Panel Board with copper bus, 208 V Side: terminal block and allocated space for FOUR QOU branch breakers, Dead front, Space for Main Breaker (field installed), Space for Secondary Main Breakers.

Catalog Number	120 V Side		208 V Side		Line Isolation Monitor	LIM Connector terminals	Ground Bus
	Branch Breakers Factory Installed	Space	Branch Breakers Factory Installed	Space			
SMIDBA216A31A51	(16) QOB220	(0)	(1) QOU230 (1) QOU250	(2)	IG6M	4800IG6C	PK23GTA/Q1100AN
SMIDBA216A32	(16) QOB220	(0)	(2) QOU230	(2)	IG6M	4800IG6C	PK23GTA/Q1100AN
SMIDBA216A52	(16) QOB220	(0)	(2) QOU250	(2)	IG6M	4800IG6C	PK23GTA/Q1100AN
SMIDBA216AN	(16) QOB220	(0)	none	(4)	IG6M	4800IG6C	PK23GTA/Q1100AN
SMIDBA212A31A51	(12) QOB220	(4)	(1) QOU230 (1) QOU250	(2)	IG6M	4800IG6C	PK23GTA/Q1100AN
SMIDBA212A32	(12) QOB220	(4)	(2) QOU230	(2)	IG6M	4800IG6C	PK23GTA/Q1100AN
SMIDBA212A52	(12) QOB220	(4)	(2) QOU250	(2)	IG6M	4800IG6C	PK23GTA/Q1100AN
SMIDBA212AN	(12) QOB220	(4)	none	(4)	IG6M	4800IG6C	PK23GTA/Q1100AN
SMIDANA31A51	none	(16)	(1) QOU230 (1) QOU250	(2)	IG6M	4800IG6C	PK23GTA/Q1100AN
SMIDANA32	none	(16)	(2) QOU230	(2)	IG6M	4800IG6C	PK23GTA/Q1100AN
SMIDANA52	none	(16)	(2) QOU250	(2)	IG6M	4800IG6C	PK23GTA/Q1100AN
SMIDANAN	none	(16)	none	(4)	IG6M	4800IG6C	PK23GTA/Q1100AN

All dual voltage interiors go into Backbox SB723014F or SB723014S.

Table 15.3: Interiors Controlled System Interiors: Line Isolation Monitor, Line Isolation connector terminal, 125 Amp 250 V NQ Panel Board with copper bus, Dead front, Space for Main Breaker (field installed), Programmable Controller (PLC), N/C Relays for each circuit, terminal board for remotes, terminal board for "IN USE LIGHT".

Catalog Number	Branch Breakers Factory Installed	N/C Relays Factory Installed	PLC Programmed to allow energized circuits	Line Isolation Monitor	LIM Connector terminals	Ground Bus
SMICBPUA24H1	(4) QOB220	(4) 30 A	(1)	IG6M	4800IG6C	PK23GTA/Q1100AN
SMICBPUA34H1	(4) QOB230	(4) 30 A	(1)	IG6M	4800IG6C	PK23GTA/Q1100AN
SMICBPUA54H1	(4) QOB250	(4) 60 A	(1)	IG6M	4800IG6C	PK23GTA/Q1100AN
SMICBPUA64H1	(4) QOB260	(4) 60 A	(1)	IG6M	4800IG6C	PK23GTA/Q1100AN
SMICBPUA32A52H1	(2) QOB230 (2) QOB250	(2) 30 A (2) 60 A	(1)	IG6M	4800IG6C	PK23GTA/Q1100AN
SMICBPUA28H1	(8) QOB220	(8) 30 A	(1)	IG6M	4800IG6C	PK23GTA/Q1100AN
SMICBPUA38H1	(8) QOB230	(8) 30 A	(1)	IG6M	4800IG6C	PK23GTA/Q1100AN
SMICBPUA58H1	(8) QOB250	(8) 60 A	(1)	IG6M	4800IG6C	PK23GTA/Q1100AN
SMICBPUA68H1	(8) QOB260	(8) 60 A	(1)	IG6M	4800IG6C	PK23GTA/Q1100AN
SMICBPUA34A54H1	(4) QOB230 (4) QOB250	(4) 30 A (4) 60 A	(1)	IG6M	4800IG6C	PK23GTA/Q1100AN
SMICBPUA36A52H1	(6) QOB230 (2) QOB250	(6) 30 A (2) 60 A	(1)	IG6M	4800IG6C	PK23GTA/Q1100AN
SMICBPUA212H1	(12) QOB220	(12) 30 A	(1)	IG6M	4800IG6C	PK23GTA/Q1100AN
SMICBPUA312H1	(12) QOB230	(12) 30 A	(1)	IG6M	4800IG6C	PK23GTA/Q1100AN
SMICBPUA512H1	(12) QOB250	(12) 60 A	(1)	IG6M	4800IG6C	PK23GTA/Q1100AN
SMICBPUA612H1	(12) QOB260	(12) 60 A	(1)	IG6M	4800IG6C	PK23GTA/Q1100AN
SMICBPUA36A56H1	(6) QOB230 (6) QOB250	(6) 30 A (6) 60 A	(1)	IG6M	4800IG6C	PK23GTA/Q1100AN
SMICBPUA38A54H1	(8) QOB230 (4) QOB250	(8) 30 A (4) 60 A	(1)	IG6M	4800IG6C	PK23GTA/Q1100AN

All dual voltage interiors go into Backbox SB723014F or SB723014S.

In use Light terminal: PLC will turn on all terminals that are not energized causing optional light on Power Module to be energized, that informs the hospital staff that POWER IS NOT AVAILABLE at this time. communicates: POWER IS IN USE AT OTHER LOCATION.

Transformer Disconnect Kits

The transformer type is determined by the source voltage and the load capacity requirements. The main disconnect type is determined by the transformer choice. Schneider Electric packages these two components together for field installation into the isolated power system. The advantages of this installation method are:

- Flexibility in the job schedule—the interior can be shipped without fixed voltage and kVA capacity
- Job changes can be made without impacting the interior
- Future expansion since the capacity of the system can be upgraded without changing the interior
- NEC requires Isolation Power Systems to UL Listed Equipment - Labeling comes on Dead Front as part of Transformer Disconnect Kit.

Main disconnect sizing per UL 1047 to allow for full capacity of the isolated power system, PowerPacT H circuit breakers, coordinated with the branch circuit breakers for 0.1 seconds.

Table 15.4: Standard/Duplex/Control Transformer Disconnect Kit: One Transformer, Terminal (Lead wire) to connect to breaker and NQ panel board, Main Disconnect, mounting bracket, Dead Front with System characteristics and UL Label.

Kit Catalog Number	KVA	Primary Voltage	Main Disconnect (breaker)	Amp Rating Breaker	Sec Voltage	Transformer Part Number	Isolation Power System
SXMK03DASC	3	277	HDL26015	15	120	SXM03DA	Standard / Duplex
SXMK03CASC	3	240	HDL36060U31X	20	120	SXM03CA	Standard / Duplex
SXMK03BASC	3	208	HDL36060U31X	20	120	SXM03BA	Standard / Duplex
SXMK03AASC	3	120	HDL36100U31X	35	120	SXM03AA	Standard / Duplex
SXMK05EASC	5	480	HDL26015	15	120	SXM05EA	Standard / Duplex
SXMK05DASC	5	277	HDL26025	25	120	SXM05DA	Standard / Duplex
SXMK05CASC	5	240	HDL36060U31X	30	120	SXM05CA	Standard / Duplex
SXMK05BASC	5	208	HDL36060U31X	30	120	SXM05BA	Standard / Duplex
SXMK05AASC	5	120	HDL26060	60	120	SXM05AA	Standard / Duplex
SXMK07EASC	7.5	480	HDL26020	20	120	SXM07EA	Standard / Duplex
SXMK07DASC	7.5	277	HDL26035	35	120	SXM07DA	Standard / Duplex
SXMK07CASC	7.5	240	HDL26040	40	120	SXM07CA	Standard / Duplex
SXMK07BASC	7.5	208	HDL36060U31X	45	120	SXM07BA	Standard / Duplex
SXMK07AASC	7.5	120	HDL26080	80	120	SXM07AA	Standard / Duplex
SXMK10EASC	10	480	HDL26030	30	120	SXM10EA	Standard / Duplex
SXMK10DASC	10	277	HDL26045	45	120	SXM10DA	Standard / Duplex
SXMK10CA	10	240	QOU260	60	120	SXM10CA	Standard / Duplex
SXMK10BASC	10	208	HDL26060	60	120	SXM10BA	Standard / Duplex
SXMK10AASC	10	120	HDL26100	100	120	SXM10AA	Standard / Duplex
SXMK05EB	5	480	HDL26015	15	208	SXM05EB	Standard / Duplex/Control
SXMK05DB	5	277	HDL26025	25	208	SXM05DB	Standard / Duplex/Control
SXMK05CB	5	240	QOU230	30	208	SXM05CB	Standard / Duplex/Control
SXMK05BB	5	208	QOU230	30	208	SXM05BB	Standard / Duplex/Control
SXMK07EBSC	7.5	480	HDL36060U31X	20	208	SXM07EB	Standard / Duplex/Control
SXMK07DBSC	7.5	277	HDL36100U31X	35	208	SXM07DB	Standard / Duplex/Control
SXMK07CBSC	7.5	240	HDL36100U31X	40	208	SXM07CB	Standard / Duplex/Control
SXMK07BBSC	7.5	208	HDL36100U31X	45	208	SXM07BB	Standard / Duplex/Control
SXMK10EBSC	10	480	HDL36060U31X	30	208	SXM10EB	Standard / Duplex/Control
SXMK10DBSC	10	277	HDL36100U31X	45	208	SXM10DB	Standard / Duplex/Control
SXMK10CBSC	10	240	HDL36100U31X	60	208	SXM10CB	Standard / Duplex/Control
SXMK10BBSC	10	208	HDL36100U31X	60	208	SXM10BB	Standard / Duplex/Control
SXMK15EBSC	15	480	HDL36060U31X	40	208	SXM15EB	Standard/Control
SXMK15DBSC	15	277	HDL36100U31X	70	208	SXM15DB	Standard/Control
SXMK15CBSC	15	240	HDL36100U31X	80	208	SXM15CB	Standard/Control
SXMK15BBSC	15	208	HDL36100U31X	90	208	SXM15BB	Standard/Control
SXMK25EBSC	25	480	HDL26070	70	208	SXM25EB	Standard/Control
SXMK25DBSC	25	277	HDL26125	125	208	SXM25DB	Standard/Control
SXMK25CBSC	25	240	QOU2150	150	208	SXM25CB	Standard/Control
SXMK25BBSC	25	208	QOU2150	150	208	SXM25BB	Standard/Control

Table 15.5: Dual Voltage Transformer Disconnect Kit: One Transformer, Terminal (Lead wire) to connect to breaker and NQ panel board, Main Breaker, 120 V Secondary Main Breaker, 208 V Secondary Main Breaker, mounting brackets, Dead Front with System characteristics and UL Label, Dead Front for Secondary Breakers.

Kit Catalog Number	System kVA	Pri V	Main Disconnect (Breaker)	Amp Rating Breaker	Sec V	Sec kVA	Sec Main Breaker	Sec Amp Rating	Transformer Part Number
SXMK15EB07	15	480	HDL26040	40	120	7.5	HDL26070	70	SXMK15EB07
					208	7.5	QOU240	40	
SXMK15DB07	15	277	HDL26070	70	120	7.5	HDL26070	70	SXMK15DB07
					208	7.5	QOU240	40	
SXMK15CB07	15	240	QOU280	80	120	7.5	HDL26070	70	SXMK15CB07
					208	7.5	QOU240	40	
SXMK15BB07	15	208	QOU290	90	120	7.5	HDL26070	70	SXMK15BB07
					208	7.5	QOU240	40	
SXMK22EB07	22.5	480	HDL26060	60	120	7.5	HDL26070	70	SXMK25EB10
					208	15	QOU280	80	
SXMK22DB07	22.5	277	HDL26100	100	120	7.5	HDL26070	70	SXMK25DB10
					208	15	QOU280	80	
SXMK22CB07	22.5	240	HDL26125	125	120	7.5	HDL26070	70	SXMK25CB10
					208	15	QOU280	80	
SXMK22BB07	22.5	208	HDL26150	150	120	7.5	HDL26070	70	SXMK25BB10
					208	15	QOU280	80	
SXMK25EB10SC	25	480	HDL26070	70	120	10	QOU2100	100	SXMK25EB10
					208	15	QOU280	80	
SXMK25DB10SC	25	277	HDL26125	125	120	10	QOU2100	100	SXMK25DB10
					208	15	QOU280	80	
SXMK25CB10SC	25	240	HDL36150U31X	150	120	10	QOU2100	100	SXMK25CB10
					208	15	QOU280	80	
SXMK25BB10SC	25	480	HDL36150U31X	150	120	10	QOU2100	100	SXMK25BB10
					208	15	QOU280	80	

Dual Voltage Transformer kits only work on Dual Voltage system.

Hinged Backbox Trim System

The trim/back box system incorporates a new barrel hinge design that hides the hinge when the trim piece is closed and fastened to the back box. This design helps facilitate ease of cleaning by keeping debris from accumulating in the hinge system. The hinge pins are factory-mounted on the trim piece. The sliding support mechanisms are factory-mounted on the inside of the back box.

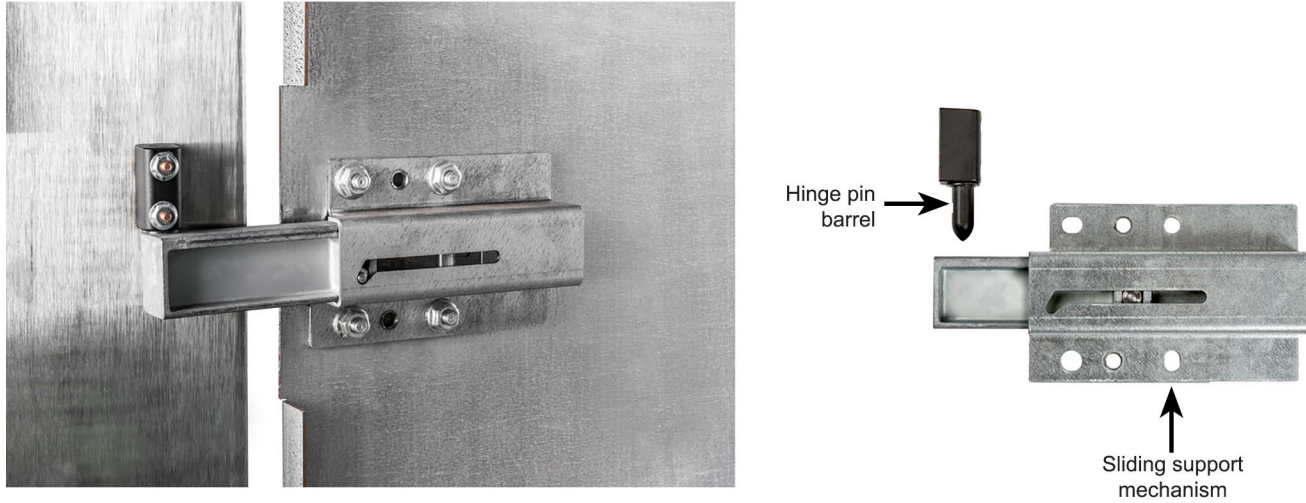

Table 15.6: Back box is constructed of 14-gauge (minimum), galvanized steel. Flush mounting is standard. Surface-mounted back boxes are finished with a coat of hospital-ivory colored baked enamel.

System	Catalog Number	H	W	D	Mounting	kVA
Standard	SB662408F	66	24	8	Flush	3, 5, 7.5, or 10
Standard	SB662408S	66	24	8	Surface	3, 5, 7.5, or 10
Standard	SB723014F	72	30	14	Flush	15 or 25
Standard	SB723014S	72	30	14	Surface	15 or 25
Controlled	SB723014F	72	30	14	Flush	5, 7.5, 10, 15 or 25
Controlled	SB723014S	72	30	14	Surface	5, 7.5, 10, 15 or 25
Dual	SB723014F	72	30	14	Flush	15 or 25
Dual	SB723014S	72	30	14	Surface	15 or 25
Duplex	SB803608F	80	36	8	Flush	3, 5, 7.5, or 10
Duples	SB803608F	80	36	8	Surface	3, 5, 7.5, or 10

Table 15.7: Table Trim is constructed of 14-gauge (minimum) 304 Stainless steel, brush finished, door with hidden hinge, flush-mounted key lock, allocated hole for Line Isolation Mounting.

Catalog Number	Used with	H	W	
ST6826	SB662408F	68	26	
ST6826R	SB662408F	68	26	Removal blank plate for field accessories {1}
ST6624	SB662408S	66	24	
ST6624R	SB662408S	66	24	Removal blank plate for field accessories {1}
ST8238	SB803608F	82	38	
ST8238R	SB803608F	82	38	Removal blank plates for field accessories {2}
ST8036	SB803608S	80	36	
ST8036R	SB803608S	80	36	Removal blank plates for field accessories {2}
ST7432	SB723014F	74	32	
ST7230	SB723014S	72	30	
ST7432D	SB723014F	74	32	
ST7432DR	SB723014F	74	32	Removal blank plate for field accessories {1}
ST7230D	SB723014S	72	30	
ST7230DR	SB723014S	72	30	Removal blank plate for field accessories {1}
ST7432C	SB723014F	74	32	
ST7230C	SB723014S	72	30	



Iso-Gard Series 6 LIM

Line Isolation Monitor—Remote Indicators

Iso-Gard™ Series 6

Iso-Gard Series 6, microprocessor-controlled, line isolation monitor (LIM) is included as standard equipment in all Schneider Electric hospital isolation panels. The Iso-Gard Series 6 LIM incorporates automatic and manual self-test and self-calibration to reduce the frequency of required periodic testing. Microprocessor controlled circuitry for highest accuracy and stability. UL Component Recognized and CSA Classified.

Catalog Number		
IG6M	Series 6 Line Isolation Monitor	Included with each interior, mounted on TRIM
4800IG6C	Connector terminal	Included with each interior, factory mounted
4800IG6CBKTVM	Connector terminal	required when installing IG6M into older Square D Isolation Power Systems
	Mounting Bracket	



New!

NEC® Requirement

NEC® Requirement The National Electrical Code® (NEC®) requires audible and visual alarm indication where isolation power is used (NEC 517-160). Schneider Electric offers the IG2000CBM remote alarm indicators for this purpose when LIM is located outside the area.

IG2000CBM

The Iso-Gard™ IG2000CBM remote indicator from Schneider Electric provides remote indication of the visible and audible alarms and digital mA reading from an Iso-Gard Series 6 (IG6) line isolation monitor (LIM).

- Green LED—stays illuminated while the system is in normal condition
- Red LED—illuminates when the Total Hazard Current (THC) exceeds the preset alarm level
- Audible hazard alarm—sounds when the THC exceeds the preset alarm level
- Mute button with yellow LED—silences the audible alarm on the remote indicator (local muting), or silences all audible alarms in the system (system muting)
- Test button—remotely performs a functional test of the LIM

IG2000CBM remote indicator is available in different mounting configurations .

Catalog Number	QTY	Description	Box Requirements
IG2000CBMG2	1	Mounted on two gang plate	Customer supplied two gang box
IG2000CBMG4	1	Mounted on four gang plate	Customer supplied four gang box
IG2000CBM2G4	2	Mounted on four gang plate	Customer supplied four gang box
SRAS2EF	2	Mounted on Trim 14 x 10	Back box SB120804
IG2000CBMST0614	1	Mounted on Trim 14 x 6	Existing backbox 53008BB
IG2000CBMPM	1	Mounted on Bracket	Existing Square D Isolation Power System

Schneider Electric offers 208 V or 240 V modules designed to complete the control circuit of a controlled power panel.

Power and Ground Modules

Power Modules: When both ground jacks and power receptacles are required, these UL Listed modules offer convenience and save labor in field wiring. The units include four power receptacles, four twist-to-lock ground jacks, and a ground bus with a generous number of lugs for external ground connections. The main ground connection in the module accommodates up to a #1/0 cable. The units are completely factory wired; only field power connections and ground connections are necessary. They are furnished with Type 304, brushed stainless steel face plates.

Multiple Mounting options for the product:

- (1) backbox 12 x 8 x 4
- (2) Bottom of Standard or Duplex Isolation Power System
- (3) Standard Gang Box supplied by customer

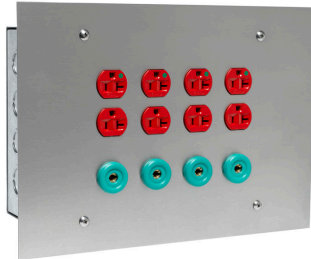

4 Red Duplex Receptacles and 4 Ground Jacks



4 Red Duplex Receptacles and 4 Ground Jacks

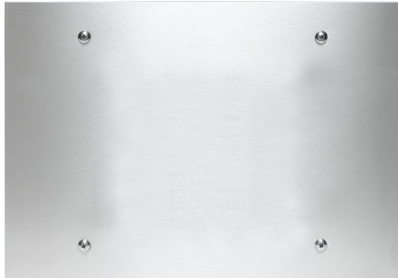

Table 15.8: Power Modules

Catalog Number	Hospital Grade Ground Jacks	Power Receptacles	Mounting	
SGPMF4DR4	(4) 30 A, 250 V, Green	(4) 20 A, Duplex Red	Backbox SB120804	
SGPMF4DI4		(4) 20 A, Duplex Ivory		
SGPMF4TB4		(4) 20 A, Single Twist Lock		
SGPMF4SR4		(4) 20 A, Single Red		
SGPMF4SI4		(4) 20 A, Single Ivory		
SGPMP4DR4		(4) 20 A, Duplex Red		
SGPMP4DI4		(4) 20 A, Duplex Ivory	Duplex or Standard Isolation Power System ^[1]	
SGPMP4TB4		(4) 20 A, Single Twist Lock		
SGPMP4SR4		(4) 20 A, Single Red		
SGPMP4SI4		(4) 20 A, Single Ivory		
SGPMG4DR4		(4) 20 A, Duplex Red		Customer supplied eight gang box
SGPMG4DI4		(4) 20 A, Duplex Ivory		
SGPMG4TB4		(4) 20 A, Single Twist Lock		
SGPMG4SR4		(4) 20 A, Single Red		
SGPMG4SI4		(4) 20 A, Single Ivory		

Master Ground Station: These modules can be used as a collection point for grounds in a large area, such as a coronary care unit or intensive care ward. The primary application is where the equipment ground bus in the isolated power panel is not conveniently located or cannot accept the large number of connections required for the area. This unit can be connected to the ground point by a single conductor and located in a more convenient area. The module contains a bus bar with 18 lugs for field connections and has a Type #304 brushed stainless steel cover plate. It is designed for installation into a 12 in. x 8 in. x 4 in. back box.

[1] Must have TRIM with Removal blank plate for field accessories example: ST8238R.



4 Ground Jacks

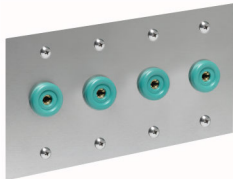

4 Ground Jacks



Ground Jack



Ground Cord with Lug End



Ground Cord with Clip End

Table 15.9: Master Ground Station – Ground Modules

Catalog Number	Description	Mounting
SGPMF0NN0	Master ground station, *****	
SGPMF2NN0	(2) 30 A, 250 V, Green Hospital Grade ground jacks	Backbox SB120804
SGPMF4NN0	(4) 30 A, 250 V, Green Hospital Grade ground jacks	
SGPMP2NN0	(2) 30 A, 250 V, Green Hospital Grade ground jacks	Duplex or Standard Isolation Power System
SGPMP4NN0	(4) 30 A, 250 V, Green Hospital Grade ground jacks	
SGPMG0NN0	Master ground station, *****	
SGPMG2NN0	(2) 30 A, 250 V, Green Hospital Grade ground jacks	Customer supplied two Gang Box
SGPMG4NN0	(4) 30 A, 250 V, Green Hospital Grade ground jacks	Customer supplied four Gang Box

Hospital Ground Cords and Jacks

- Highly flexible wire with a heavy-duty lug or clip end
- Ground cord with lug end is UL Listed (UL 467)
- Various lengths available

Catalog Number	Description
SHGC15L	15 foot, with plug and lug for #10 stud
SHGC15C	15 foot, with plug and heavy duty clip
SHGC12L	12 foot, with plug and lug for #10 stud
SHGC12C	12 foot, with plug and heavy duty clip
SHGC10L	10 foot, with plug and lug for #10 stud
SHGC10C	10 foot, with plug and heavy duty clip
SHGJ1R	Hospital grade ground jack, 30 A, 250 V green







Receptacle Modules for Controlled Panels

X-ray/laser power receptacle modules provide a convenient source of power for portable X-ray and laser equipment. The receptacle provided in each module is matched to the NEMA plug configuration of the equipment with which it will be used and is mounted behind the door on the stainless steel face plate. The door features a concealed hinge and a touch latch.

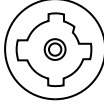
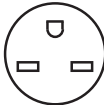
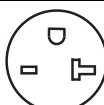
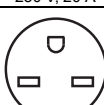
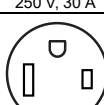
Optional "IN USE LIGHT" – used with Control Panel to inform customer that power is not available at this Laser Module – it is IN USE AT ANOTHER LOCATION.

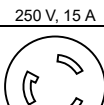
Table 15.10: Laser Power Modules

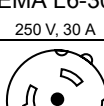
Catalog Number	Factory Installed remote	Outlet Configuration	"In Use Light"	Required backbox
SXRM1A1F	IG2000P	 IN16494 250 V, 60 A	NO	SB120804
SXRM1E1F	IG2000CBM		NO	SB120804
SXRM1A2F	IG2000P		YES	SB120804
SXRM1E2F	IG2000CBM		YES	SB120804
SXRM2A1F	IG2000P	 NEMA 6-15R 250 V, 15 A	NO	SB120804
SXRM2E1F	IG2000CBM		NO	SB120804
SXRM2A2F	IG2000P		YES	SB120804
SXRM2E2F	IG2000CBM		YES	SB120804
SXRM3A1F	IG2000P	 NEMA 6-20R 250 V, 20 A	NO	SB120804
SXRM3E1F	IG2000CBM		NO	SB120804
SXRM3A2F	IG2000P		YES	SB120804
SXRM3E2F	IG2000CBM		YES	SB120804
SXRM4A1F	IG2000P	 NEMA 6-30R 250 V, 30 A	NO	SB120804
SXRM4E1F	IG2000CBM		NO	SB120804
SXRM4A2F	IG2000P		YES	SB120804
SXRM4E2F	IG2000CBM		YES	SB120804
SXRM5A1F	IG2000P	 NEMA 6-50R 250 V, 50 A	NO	SB120804
SXRM5E1F	IG2000CBM		NO	SB120804
SXRM5A2F	IG2000P		YES	SB120804
SXRM5E2F	IG2000CBM		YES	SB120804
SXRM6A1F	IG2000P	 NEMA L6-15R 250 V, 15 A	NO	SB120804
SXRM6E1F	IG2000CBM		NO	SB120804
SXRM6A2F	IG2000P		YES	SB120804
SXRM6E2F	IG2000CBM		YES	SB120804
SXRM7A1F	IG2000P	 NEMA L6-20R 250 V, 20 A	NO	SB120804
SXRM7E1F	IG2000CBM		NO	SB120804
SXRM7A2F	IG2000P		YES	SB120804
SXRM7E2F	IG2000CBM		YES	SB120804
SXRM8A1F	IG2000P	 NEMA L6-30R 250 V, 30 A	NO	SB120804
SXRM8E1F	IG2000CBM		NO	SB120804
SXRM8A2F	IG2000P		YES	SB120804
SXRM8E2F	IG2000CBM		YES	SB120804
SXRM9A1F	IG2000P	 CS8269 250 V, 50 A	NO	SB120804
SXRM9E1F	IG2000CBM		NO	SB120804
SXRM9A2F	IG2000P		YES	SB120804
SXRM9E2F	IG2000CBM		YES	SB120804

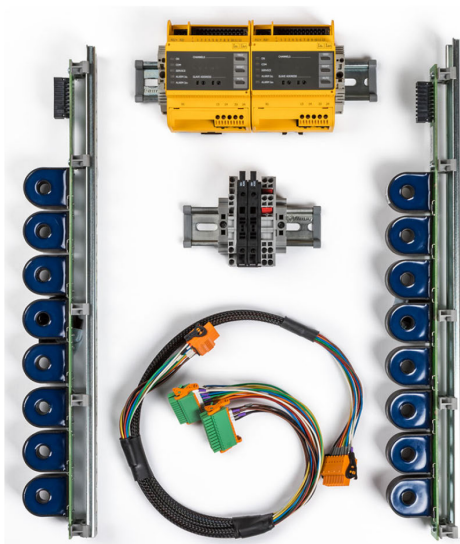

Fault Locator System

The fault locator system works with the Line Isolation Monitor to identify the branch circuit with high leakage current.

The fault locator system kit is designed to be mounted in pre-punched holes on the interior. The kit includes:

- Overcurrent protection
- One fault locator module
- Jumper wire with quick connects
- Two control transformer (CT) strips.

A locator module monitors 12 circuits:

- One module—monitors circuit 1–12 and aligns with panel numbers

The jumper wire includes quick connects to allow modules to be programmed from the factory to align CT strips with the LEDs on the face of the unit.

Part Number	Description	Interiors
EDS441LNAKIT1	Insulation fault locator kit to monitor 12 branch circuits	All standard / duplex interiors LV side of dual voltage interiors
EDS441LNAKIT2	Insulation fault locator kit to monitor 16 branch circuits	All standard / duplex interiors LV side of dual voltage interiors

Annunciator Panel (Nurse Station—Remotes)

IG2000P remote indicators are available in an annunciator panel for monitoring from a single central location. Available in combinations of 1–16 devices as standard. Special quantity requests can be obtained from the factory.



Back box SB120804		Back box SB121204		Back Box SB121604	
Catalog Number	QTY IG2000P	Catalog Number	QTY IG2000P	Catalog Number	QTY IG2000P
SRAS2F	2	SRAS9F	9	SRAS13F	13
SRAS3F	3	SRAS10F	10	SRAS14F	14
SRAS4F	4	SRAS11F	11	SRAS15F	15
SRAS5F	5	SRAS12F	12	SRAS16F	16
SRAS6F	6				
SRAS7F	7				
SRAS8F	8				

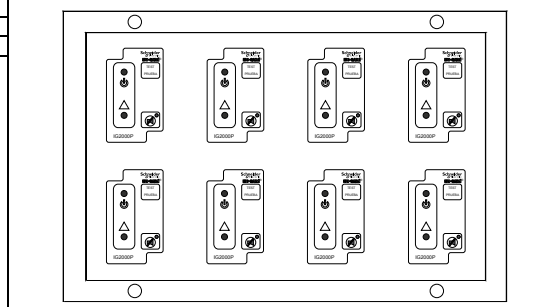

Kits

Seismic Kit

The Schneider Electric Medical Panels, Standard Isolation Panels, Dual Isolation Panels, have been qualified to the seismic limits with the installation of special hardware for trim installation and use of bolt on breakers

Catalog Number	Description
4800S10200015	Trim hardware to replace hardware shipped with device. OSP label for where required

Table 15.11: Replacement Parts / Kits

Catalog Number	Description
4800S10200000	Transformer Mounting hardware and isolation pads
4800S10200002	Mounting hardware, Power and Ground Modules
4800S10200004	Mounting hardware, Power and Ground Modules
4800S10200009	Mounting hardware Fault locator system
4800S10200306	Mounting hardware Isolation Power System Trim
4800S10200705	Line Isolation Monitor – rear mounted hardware
4800KEY	Replacement KEY for Isolation Power System
4800IG6BKTVM	Mounting bracket to mount IG6M in Square D branded Isolation Power Systems
4800IG6C	Line Isolation Monitor connector cord and terminal block
4800IG6CBKTVM	4800IG6C and 4800IG6BKTVM shipped together

Table 15.12: Ground Kit options

Description	Catalog Number
Installed in every Isolation Panel System Accepting AL/CU wire	PK23GTA
	Q1100AN
Field installable Copper Ground Kit	PK27GTACU
Field installable Chicago Code Ground Bus Copper	4800B521301722