

# Retail Products Catalog

Life Is 

**SQUARE** ™

by Schneider Electric



[www.schneider-electric.us](http://www.schneider-electric.us)



# Table of Contents

## ► Overview

About Us ..... 4

## ► Product Definitions

Types of Circuit Breakers,  
Residential Load Centers &  
other Electrical Devices ..... 6

## ► QO® Product Information

Introduction to QO Circuit Breakers ..... 8

- Full Size 3/4" Circuit Breakers ..... 9
- Tandem Breakers ..... 10
- GFCI Breakers ..... 10
- CAFCI Breakers ..... 11
- Plug-on Neutral ..... 11
- Dual Function (CAFCI + GFCI) Breakers ..... 12
- TIME SAVER Diagnostics ..... 32
- Accessories: Load Center  
and Circuit Breaker ..... 13

Introduction to QO Load Centers ..... 16

- Catalog Number Guide ..... 17
- Plug-on Neutral Main Breaker/Lugs ..... 18
- Main Lugs Load Centers ..... 19
- Main Circuit Breaker Load Centers ..... 20
- Field Installable QOM Main Breakers ..... 21
- Knockouts and Dimensions ..... 22-23
- Bolt-on Hubs ..... 23
- Load Center Main Wire Size ..... 24
- Load Center Wiring Diagrams ..... 25-26

## ▶ Homeline® Product Information

Introduction to Homeline Circuit Breakers.....	28
• Full Size 1" Circuit Breakers.....	29
• Tandem Breakers.....	30
• CAFCI Breakers.....	30
• GFCI Breakers.....	31
• Dual Function (CAFCI + GFCI) Breakers.....	31
• Plug-on Neutral.....	32
• TIME SAVER Diagnostics.....	32
Introduction to Homeline Load Centers.....	34
• Catalog Number Guide.....	17
• Main Circuit Breaker Load Centers.....	35
• Main Lugs Load Centers.....	36
• Load Center Accessories.....	13-14
• Knockouts and Dimensions.....	22-23
• Load Center Main Wire Size.....	37
• Load Center Wiring Diagrams.....	38-39
Choosing The Right Load Center: QO vs. Homeline.....	40-41

## ▶ Meter Mains, Metering Devices and All-In-Ones Product Information

Introduction to CSED Meter Mains.....	42
• Catalog Number Guide.....	43
• Meter Mains.....	44-45
• All-In-Ones.....	46-47
• Solar Ready Plug-on Neutral.....	48
• Breakers and Accessories.....	49
• Knockout Dimensions.....	50
• Meter Sockets.....	51-53
• Wire Size.....	54-55

## ▶ Value Packs Product Information

Introduction to Value Packs.....	56
• Homeline.....	57-59
• QO.....	59-60
• CSED.....	60

## ▶ Control Switches

Introduction to Control Switches.....	62
• Float Switches.....	63-64
– Sump or Open Tank.....	63
– Closed Tank.....	64
• Pressure Switches.....	65-66
– Water Pump.....	65
– Air Compressor.....	66

## ▶ Safety Switches, Surge Protection & Other Residential Products

Introduction.....	68
• AC Disconnects.....	69
• Light Duty Safety Switches.....	69
• General Duty Safety Switches.....	70
• Circuit Breaker Enclosures.....	71
• Surge Protection.....	72
• Generator Panels.....	73

## ▶ Advanced Products

Introduction.....	74
• Wiser Air Thermostat.....	75-76
• EV Link Charging Stations.....	78
– Indoor Charging Stations.....	78
– Outdoor Charging Stations.....	79
– Vehicle Charging Station Dimensions.....	80

## ▶ Important Information

Warranty Information.....	82
---------------------------	----

# About Us

## Who we are

Schneider Electric is the global specialist in energy management and automation. Our 170,000 employees serve customers in over 100 countries, helping them to manage their energy and process in ways that are safe, reliable, efficient and sustainable. From the simplest of switches to complex operational systems, our technology, software and services improve the way our customers manage and automate their operations. Our connected technologies will reshape industries, transform cities and enrich lives.

At Schneider Electric, we call this Life Is On.

## A history of circuit protection, reliability and innovation

- **1902** As Detroit Fuse and Manufacturing, the company built enclosed fuses and fuse switches to enhance safety in the growing auto plants of Detroit
- **1917** The company changed the name to Square D to capitalize on the high recognition of the trademark on its switches. (a capital D in a square)
- **1926** The company built its first power distribution panel
- **1929** Square D began producing circuit breakers under license from Westinghouse
- **1930** Launched its own range of circuit breakers and the first circuit breaker for residential use
- **1955** Introduced Qwik-Open™ circuit breakers and load centers, known as QO™

- **1968** Added Visi-Trip™ positive trip indicator feature for QO breaker range
- **1971** Introduced Qwik-Gard™ ground fault circuit interrupting (GFI) devices
- **1991** Introduced Homeline™ circuit breakers and load centers
- **1999** Introduced Arc-D-Tect™ arc fault circuit interrupting (CAFI) devices
- **2011** Introduced TIME SAVER Diagnostics in CAFI devices
- **2012** Introduced QO Plug-on Neutral Breakers
- **2014** Introduced 2-Pole CAFI devices
- **2014** Introduced Dual Function circuit breakers, GFI and CAFI in one device
- **2014** Introduced Homeline Plug-on Neutral breakers and load centers

## A new business perspective

Innovation is nothing new to Schneider Electric. Our quality, innovation and reliability make us the most preferred brand among electrical contractors and home builders. We attribute much of our success to our customers and work every day to ensure our bright futures together.



BOTTOM  
↓  
This side of the wall is the  
interior. The other side is  
the exterior. Do not  
remove the insulation.

# Types of Circuit Breakers, Residential Load Centers & other Electrical Devices

**Circuit Breakers:** A circuit breaker is designed to protect the wiring in a home. It automatically interrupts a circuit (shutting off the flow of electricity) whenever a circuit is overloaded or a short circuit occurs. Circuit breakers carry three primary ratings:

1. **Ampere Rating:** the specific continuous current on which the breaker is designed to operate
2. **Maximum Voltage Rating:** either 120 Vac for single-pole (one space) breakers or 240 Vac for double-pole (two space) breakers
3. **Interrupting Rating:** the maximum fault current a breaker is designed to interrupt

## Single-Pole Circuit Breaker

Available in various ampere ratings, these circuit breakers occupy one space in the load center and are used for single 120 Vac circuits. A typical residential service contains electrical branch circuits supplying wall receptacles, lighting fixtures and appliances such as dishwashers and disposals.

## Double-Pole Circuit Breaker

Also available in various ampere ratings. Appliances which require larger amounts of power (clothes dryers, ranges, furnaces, air conditioners, etc.) will use separate 30A, 40A, or 50A 240 Vac branch circuits.

## Tandem Circuit Breaker

These low amperage breakers provide two isolated single-pole circuits utilizing only one single-pole space in the load center. Only designated Square D load centers will accept tandem breakers.

## Quad Circuit Breaker (Homeline only)

This circuit breaker provides three isolated circuits (two single-pole and one double-pole) utilizing two spaces in the load center. Only designated Homeline load centers will accept quad breakers.

Circuit Breaker Application Guide			
<i>Local codes may vary. Check with your electrical inspector for applicable codes.</i>			
Circuit Breaker Application	Circuit Breaker		Copper Wire Size
	Amps	# Spaces	
<b>Air Conditioner</b>			
120V – up to 11K BTU	20	1	12-2*
240V – up to 23K BTU	20	2	12-2*
240V – up to 36K BTU	30	2	10-2*
<b>Attic Fan</b>			
120V – up to ½ HP	15	1	14-2
<b>Branch Circuit</b>			
120V – 15A	15	1	14-2
120V – 20A	20	1	12-2
<b>Clothes Dryer</b>			
240V	30	2	10-3
<b>Dishwasher</b>			
120V	20	1	12-2
<b>Doorbell Transformer – Class 5</b>			
120V	15	1	14-2
<b>Electric Heater</b>			
120V – up to 1.92KW	20	1	12-2
<b>Electric Range</b>			
240V – up to 5.7KW	30	2	10-3
240V – up to 7.6KW	40	2	6-3
240V – up to 9.6KW	50	2	6-3
240V – up to 11.5KW	60	2	6-3
<b>Garbage Disposal</b>			
120V – up to ½ HP	15	1	14-2
<b>Motors (Single Phase)</b>			
120V – up to ½ HP	20	1	12-2
120V – up to 1 HP	20	1	12-2
240V – up to 1 HP	15	2	14-2
240V – 1½ to 3 HP	30	2	10-2
<b>Outdoor Lighting:</b>			
120V	15	1	14-2
<b>Range Hood</b>			
120V	15	1	14-2
<b>Spa/Hot Tub</b>			
240V	50-60	2	6-2
<b>Sump Pump</b>			
120V	15	1	14-2
<b>Water Heater</b>			
240V – up to 6KW	25 or 30	2	10-3
<b>Well Pump: up to 1 HP</b>			
120V – up to 150'	30	1	8-2
240V – 151' to 200'	15	1	12-2
240V – 201' to 300'	15	1	10-2

\* With ground.

## Main Circuit Breaker (for replacement or conversion)

Available in various amperage ratings, this is the main circuit breaker for the load center. It may be ordered to replace the existing main breaker in a main breaker load center or to convert selected main lugs load centers into main breaker load centers.

## Advanced Function Circuit Breakers:

- **Ground Fault Circuit Interrupters (GFCI's):**  
GFCI's are designed to protect people from the dangers of electrical shock. These circuit breakers are typically installed on circuits where water sources may be present. The National Electrical Code (NEC) requires ground fault circuit protection in the garage, outdoor areas, bathrooms, and in spa areas within the home. The QO™ and Homeline™ Ground Fault Circuit Breakers provide Class A protection, sensing and responding to very low levels of ground faults by tripping and shutting off power, preventing serious electrical shock to people.
- **Combination Arc Fault Circuit Interrupters (CAFCI's):** CAFCI's provide protection against series and parallel arcs. Arcing is a precursor to many electrical fires. Square D QO and Homeline CAFCI's help protect people and property from fires caused by electrical arcing. These devices continuously monitor the branch circuit and trip when a potentially dangerous condition is detected.
- **Dual Function (CAFCI + GFCI) Two critical, state-of-the-art technologies in one device:** The innovative Square D QO and Homeline Dual Function Circuit Breakers combine two critical, state-of-the-art technologies: Combination Arc Fault and Ground Fault (Class A) Protection in one circuit breaker. Dual Function Circuit Interrupters provide a higher level of protection than any other residential circuit breaker. These devices protect the entire circuit on which they are installed, not just a part of the circuit like electronic receptacles do.

## Main Breaker Load Centers

This is the service entrance panel which is connected to the electrical meter and distributes electricity throughout the home. Each is equipped with a factory installed main circuit breaker, which serves as the main disconnect to turn off power to the entire home, as well as to protect the load center from an overload or short circuit.

## Main Lugs Load Centers

This is typically used as an add-on or "sub panel" load center and is connected to the main breaker load center when spaces for more circuits are needed or when a main disconnect is located elsewhere. It does not contain a main breaker. Convertible main lug panels can be converted to main breaker panels with a replacement main breaker.

## Safety Switches

These are designed for residential and light commercial applications where operation and handling are moderate. Typical applications include residential, farm and small business service entrances and light-duty branch circuit disconnects.

## Pressure Switches

These devices are designed for the control of water pumps and air compressors. They are available in a variety of pressure settings and cutoff levels.

## Enclosed Circuit Breakers

These devices include provisions for a double-pole circuit breaker to be installed in an enclosure. Typical applications include a main service entrance disconnect for mobile homes and residences, as well as equipment or outbuilding disconnects.

## Meter Sockets

These individual meter sockets are designed for single family residential applications. They are the point of placement for the utility company's detachable watt hour meter and are used in conjunction with a load center located inside the home. The enclosures are of rainproof construction and accept "A" type bolt-on hubs for conduit entry.

- **Ring Type**  
A ring type meter socket uses a sealing ring to retain the meter in position. In order to remove the meter, the sealing ring is removed without removing the cover.
- **Ringless Type**  
A ringless type meter socket uses the cover itself as a retaining means to hold the meter in position. To remove the meter, the cover must first be removed.

## Combination Service Entrance Devices (CSED)

CSEDs primarily serve the West Coast residential market. "All-in-one" devices combine the meter socket, main disconnect and load center into one enclosure. "Meter mains" combine the meter socket and main breaker disconnect in the same enclosure.

# QO Circuit Breakers

## QO Visi-Trip Indicator

All QO circuit breakers are equipped with the Visi-Trip™ indicator. When a Visi-Trip circuit breaker trips, the handle snaps to a midpoint position between “OFF” and “ON” and a highly visible, red indicator easily identifies the tripped breaker. This enables you to easily distinguish which breaker has tripped in a load center that may contain up to 60 different circuit breakers.

QO circuit breakers have features no other manufacturer can offer. They come in many different sizes and can meet the needs of virtually every function in your home or business. These types of quality, industry exclusive products keep the Square D brand ahead of the competition and are builders’ and electrical contractors’ first choice in electrical protection.

## QO Circuit Breaker Features:

- Qwik-Open™ circuit breaker protection (trips within 1/60th of a second) on 15A and 20A single-pole breakers at currents as low as 150A to 200A
- Trips thermally (in an overload situation) or magnetically (under a short circuit situation)
- SWD (switching duty) rating on 15A and 20A single-pole breakers
- Plug-on Neutral design available, saving you money with quicker installation times\*
- Limited lifetime warranty (see page 82 for details)

### \* The Plug-on Neutral Advantage:

- *Faster installation – Fewer connections*
- *Saves wire – Fully distributed split neutral bar*
- *Frees gutter space – No pigtails*
- *Easier troubleshooting – TIME SAVER Diagnostics provide additional circuit information at the touch of a button*
- *Faster and easier wiring – All spaces accept tandems*



For over half a century, QO products have been the choice of professionals – chosen two to one over any other brand. The quality and protection standards of the QO line lead the industry by providing unsurpassed protection and reliability.

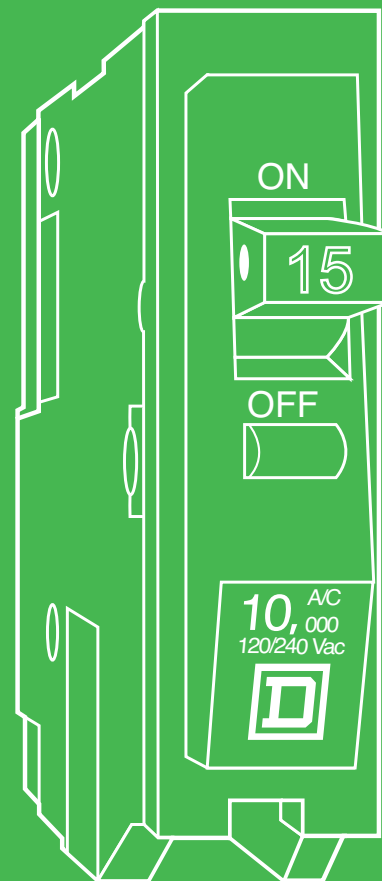



# QO Circuit Breakers

3/4" Breaker Catalog Number Description			
QO	1	15	C
Brand	# of Poles	Amps	Clam Shell Packaging

"C" denotes clam shell packaging.  
 "CP" denotes bulk bar coded breakers.

3/4" Breaker*				
Amps▼	1-Pole Catalog #	UPC Code	2-Pole Catalog #	UPC Code
15	QO115CP▲	0-47569-83798-2	QO215CP	0-47569-00894-8
	QO115C▲	0-47569-52237-6	QO215C	0-47569-52216-1
20	QO120CP▲	0-47569-83799-9	QO220CP	0-47569-83802-6
	QO120C▲	0-47569-52238-3	QO220C	0-47569-52217-8
25	—	—	QO225CP	0-47569-02382-8
30	QO130CP	0-47569-83800-2	QO230CP	0-47569-83803-3
	QO130C	0-47569-52239-0	QO230C	0-47569-52218-5
40	QO140CP	0-47569-83801-9	QO240CP	0-47569-83804-0
	QO140C	0-47569-17791-0	QO240C	0-47569-52219-2
50	QO150CP	0-47569-00893-1	QO250CP	0-47569-83805-7
	—	—	QO250C	0-47569-52220-8
60	—	—	QO260CP	0-47569-83806-4
	—	—	QO260C	0-47569-52221-5
70	—	—	QO270CP	0-47569-00895-5
80	—	—	QO280CP	0-47569-52227-7
90	—	—	QO290CP	0-47569-52228-4
100	—	—	QO2100CP	0-47569-52229-1
	—	—	QO2100C	7-85901-69123-5
125	—	—	QO2125CP	0-47569-04400-7

High Magnetic 3/4" Breakers*		
Amps▼	1-Pole Catalog #	UPC Code
15	QO115HM	7-85901-40007-3
20	QO120HM	7-85901-40011-0

\* All 15A to 60A circuit breakers listed on this page are UL listed as HACR type for use with air conditioning, heating and refrigeration equipment having motor group combinations and marked for use with HACR type circuit breakers.

▼ 10A to 30A circuit breakers are suitable for use with 60°C or 75°C conductors. 35A to 125A circuit breakers are suitable for use with 75°C conductors.

▲ UL listed as SWD (switching duty) rated. Suitable for switching 120 Vac fluorescent lighting loads.

## Plug-On Circuit Breakers

- UL Listed, CSA Approved
- 120/240 Vac
- 10k AIR
- Visi-Trip Indicator



QO120



QO2100

## QO Circuit Breakers – Tandem

Tandem Catalog Number Description			
QO	T	15	15
Brand	Tandem Breakers	1st Pole Amps	2nd Pole Amps

"C" denotes clam shell packaging.

"CP" denotes bulk bar coded breakers.

Amps▼		1-Pole Catalog #	UPC Code	2-Pole Tandem
1-Pole	2-Pole			
<b>Tandem Breakers 1-Pole (120/240 Vac) and 2-Pole</b>				
15	15	QOT1515CP	0-47569-06269-8	Order two QOT1515 or QOT2020 circuit breakers and handle tie, catalog #QOTHT, for common switching of center double-poles.
20	20	QOT2020CP QOT2020C	0-47569-00896-2 0-47569-07198-0	

Replacement Tandem Breakers				
For use in Old Style Non-Class CTL QO Load Centers (built prior to 1967)				
15	15	QO1515CP QO1515C	0-47569-08277-1 0-47569-07195-9	Order two QO1515 or QO2020 circuit breakers and handle tie, catalog #QOTHT, for common switching of center double-poles.
20	20	QO2020CP QO2020C	0-47569-00898-6 0-47569-07196-6	

▼ 10A to 30A circuit breakers are suitable for use with 60°C or 75°C conductors. 35A-125A circuit breakers are suitable for use with 75°C conductors.

### Plug-On Circuit Breakers

- UL Listed, CSA Approved
- 120/240 Vac
- 10k AIR
- Visi-Trip Indicator

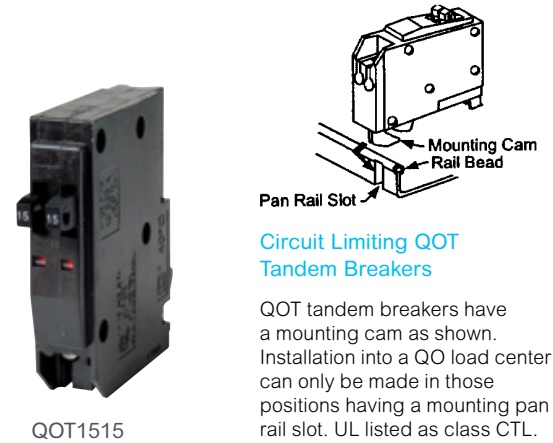

Circuit Limiting QOT Tandem Breakers

QOT tandem breakers have a mounting cam as shown. Installation into a QO load center can only be made in those positions having a mounting pan rail slot. UL listed as class CTL.

## QO Circuit Breakers – GFCI

GFCI Catalog Number Description			
QO	1	15	GFI
Brand	# of Poles	Amps	Ground Fault Circuit Interrupter

GFCI Breakers: 1-Pole (120 Vac) and 2-Pole (120/240 Vac)				
Amps▼	1-Pole Catalog #	UPC Code	2-Pole Catalog #	UPC Code
15	QO115GFICP●	0-47569-52231-4	QO215GFI*+	7-85901-56298-6
20	QO120GFICP●	0-47569-52232-1	QO220GFICP	0-47569-83831-6
30	QO130GFI*	7-85901-25509-3	QO230GFICP	0-47569-03467-1
40	—	—	QO240GFICP	0-47569-03468-8
50	—	—	QO250GFICP●	0-47569-04392-5
60	—	—	QO250GFICP	0-47569-04392-5
60	—	—	QO260GFICP▶	0-47569-04393-2

Circuit Breaker Wire Sizes			
Breaker Type	Amp Rating▼	Wire Size (AWG)	
		Aluminum	Copper
QO	10-30	#14 - 8	(1) #14 - 8 or (2) #14 - 10
	35-70	#8 - 2	#8 - 2
	80-125	#12 - 2/0	#12 - 2/0
QOT	15-20	#12 - 8	#14 - 8
QO-GFI	15-30	#12 - 8	#14 - 8
	40, 50, 60	#12 - 4	#14 - 6

### GFCI Breakers & Application Info

- UL Listed, CSA Approved
- QOE250GFINM Value Pack (see Page 59)
- 120/240 Vac
- 10k AIR
- GFI: Yellow Reset Button



- ▶ Suitable only for feeding 240 Vac and 208 Vac 2 wire loads. Does not contain load neutral connection.
- Only available in clam shell packaging.
- ▼ 10A to 30A circuit breakers are suitable for use with 60°C or 75°C conductors. 35A-125A circuit breakers are suitable for use with 75°C conductors.
- Do not connect to more than 250 feet of load conductor for the total one-way run to prevent nuisance tripping.
- ✦ Item may require additional lead time.

# QO Circuit Breakers – CAFCI

Combination Arc Fault Circuit Interrupters could prevent more than 50 percent of the electrical fires that occur every year (U.S. Consumer Product Safety Commission estimate). Square D Combination Arc Fault Circuit Interrupters (AFCIs) are the first commercially available circuit breaker designed to meet the National Electrical Code® (NEC) requirements for Combination AFCI protection.

Combination AFCI's, also known as Combination Arc Fault (CAFI) Circuit Breakers sense and respond to a broader range of arcing incidents than the standard AFCI circuit breakers, providing superior protection against electrical fires for homes and families. Series arcing is often associated with damaged devices or cord sets. A series arc is an arcing incident across a break in a conductor.

A common example is a cut across one of the two wires in a lamp cord, with a dangerous arc forming in the gap. The CAFI Circuit Breaker detects the arcing condition and turns off or trips the circuit, thus providing the enhanced electrical safety and protection. Square D Combination Arc Fault Circuit Breakers are UL® listed, available in QO and Homeline 1-Pole and 2-Pole circuit breakers with 15 and 20 ampere ratings.

## CAFCI Circuit Breakers

- UL Listed, CSA Approved
- 120/240 Vac
- 10k AIR
- CAFI: White Reset Button
- Protects against series and parallel arcs

Amps	1-Pole Catalog #	UPC Code	2-Pole Catalog #	UPC Code
<b>Combination Arc-fault Interrupter (Pigtail Neutral)</b>				
15	QO115CAFIC	7-85901-61044-1	QO215CAFIC	7-85901-38947-7
20	QO120CAFIC	7-85901-69818-0	QO220CAFIC	7-85901-39098-5
<b>Combination Arc-fault Interrupter (Plug-on Neutral)</b>				
15	QO115PCAFIC	7-85901-96528-2	—	—
20	QO120PCAFIC	7-85901-97843-5	—	—



QO215CAFI



QO120PCAFI Plug-on Neutral

# QO Circuit Breakers – Plug-on Neutral (PoN)

## Engineered for a quick Plug-on Neutral connection on every circuit.

QO Plug-on Neutral (QO PoN) Load Centers are designed to reduce installation time of CAFI and Dual Function Circuit Breakers. Installing QO Plug-on Neutral Circuit Breakers eliminates the pigtail connection, clearing the wire gutter and speeding up the job. The mounting rail of plug-on neutral load center is engineered with a plated neutral bar that accepts all QO Circuit Breakers and is similar to the thermoplastic rail of standard QO load centers, but allows for the Plug-on Neutral Circuit Breakers to be connected on any circuit. A comprehensive selection of QO Plug-on Neutral Load Centers are available to meet your specific needs.

### Single phase only

- 100 and 200 amps Main breaker 125, 200 and 225A main lug devices available
- 24, 30, 42, 54 and 60 full-size spaces/circuits
- Option for surface or flush covers that ship separately, or a combo cover (in carton) shipped with load center
- Accepts both QO PoN and pigtail Advanced Function Circuit Breakers, and all standard QO Circuit Breakers and QO accessories
- The QO Plug-on Neutral Load Center offers are additions to the standard QO offer\*

\* Standard QO load centers will not accept Plug-on Neutral circuit breakers.

## The QO Plug-on Neutral Advantage

- The QO Plug-on Neutral Load Center interior is engineered for a quick Plug-on Neutral connection on every circuit.
- Features an innovative connector jaw that is integral to the Plug-on Neutral Circuit Breaker, eliminating the pigtail connection providing cleaner gutter space
- Straight-in wiring and uniform termination lugs help minimize cable bends, reducing waste and minimizing installation time
- Standard 22kA/10kA series short circuit current rating on main breaker load centers provides increased application capabilities
- Backed Out Neutral Screws save labor and installation time
- Features all of the QO Load Center benefits, now available with a quick Plug-on Neutral connection.

## QO Circuit Breakers – Dual Function

**Save time and money with combined Combination Arc Fault Protection and Ground Fault Protection in one device.**

The innovative Square D QO Dual Function Circuit Breaker saves space and installation time while meeting prevailing National Electric Code® requirements. Available in both standard Pigtail and time-saving Plug-on Neutral configurations, these circuit breakers combine two state-of-the-art technologies; Combination Arc Fault and Ground Fault protection, in a single, easy-to-install device. The Dual Function Circuit Breaker offers superior electrical safety for homeowners.

The 2014 National Electric Code now requires both Combination Arc Fault and Ground Fault protection on all 1-Pole, 15A, and 20A kitchen and laundry circuits. Prior to the release of the Dual function Circuit Breaker, a contractor or homeowner's only choice was to use a Combination Arc Fault circuit breaker in conjunction with an expensive, bulky Ground Fault receptacle. The new Dual Function circuit breakers help reduce cost and eliminate the hassle of using two separate devices to provide essential protection. It's a win for contractors and homeowners alike. Like all Square D CAFI Circuit Breakers, it is integrated with TIME SAVER Diagnostics (Page 32), a unique feature that provides additional circuit information and minimizes troubleshooting at the touch of a button.

### Dual Function Breakers

- UL Listed, CSA Approved
- 120 VAC
- 15-20 A current rating
- Interrupt Ratings:
  - HOM, QO, and QOB – 10 kA
  - QOVH and QOB VH – 22 kA
- DF: Purple Reset Button



QO120DFC

QO115PDFC

Dual Function Circuit Breakers				
	Pigtail Neutral		Plug-On Neutral	
Amps	1-Pole Catalog #	UPC Code	1-Pole Catalog #	UPC Code
15	QO115DFC	7-85901-40166-7	QO115PDFC	7-85901-98385-9
20	QO120DFC	7-85901-40168-1	QO120PDFC	7-85901-98347-7

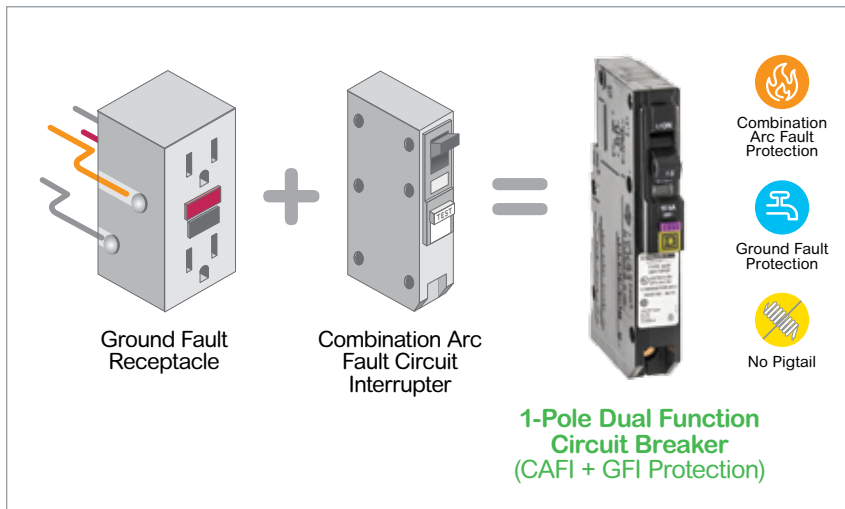

# QO & Homeline – Accessories

Accessory	Description	Catalog #	UPC Code**
<b>Handle Attachments</b>			
Retaining Kit	Secured as back-fed main for HOM612L100F/S, RB, HOM48L125C,GRB load centers	HOM1RKCP	0-47569-07145-4
Handle Tie	Converts any two adjacent 120/240 Vac 1-pole Homeline circuit breakers to independent trip 2-pole	HOM1HTCP	0-47569-07147-8
	Converts any two adjacent 120/240 Vac 1-pole QO circuit breakers to independent trip 2-pole	QO1HTCP	0-47569-57040-7
	Converts any two adjacent 120/240 Vac 1-pole side-by-side Homeline tandem breakers to independent trip 2-pole	HOMTHTCP	0-47569-07148-5
	Converts any two adjacent 120/240 Vac 1-pole side-by-side QOT circuit breakers to independent trip 2-pole	QOTHTCP	0-47569-17831-3
Handle Lock-Off	Clip for fixing QO 1-pole handle in "ON" or "OFF" position	QO1LOCP	0-47569-49462-8
	Clip for fixing QO or Q1 either 1-, 2- or 3-pole breaker handles in "ON" or "OFF" position	HLO1CP	0-47569-51772-3
Handle Padlock Attachment	For padlocking 1-pole Homeline breakers in "ON" or "OFF" position	HOM1PACP	0-47569-79871-9
	For padlocking 2-pole Homeline breakers in "ON" or "OFF" position		
	<ul style="list-style-type: none"> <li>- For high amperage</li> <li>- For low amperage</li> </ul>	HOM2PAHACP HOM2PALACP	7-85901-33158-2 7-85901-33159-9
	For padlocking the center of a 2-pole Homeline quad breaker in the "OFF" position	HOMQPA+	7-85901-86581-0
	For padlocking 1-pole QO circuit breakers in "ON" or "OFF" position		
	<ul style="list-style-type: none"> <li>- Fixed attachment</li> <li>- Loose attachment</li> </ul>	QO1PACP QOHP+	0-47569-49743-8 7-85901-76347-5
	For padlocking 1-pole side-by-side QOT circuit breakers in "ON" or "OFF" position.	QOTHPA+	7-85901-00255-0
	For 2- and 3-pole QO and Q1 circuit breakers which require padlocking in either "ON" or "OFF" position		
<ul style="list-style-type: none"> <li>- Fixed attachment</li> <li>- Loose attachment</li> </ul>	QO1PL+ QO1HPLCP	7-85901-51907-2 0-47569-79864-1	
	For padlocking 1-pole CAFI, DF, GFI, and EPD HOM breakers in "ON" or "OFF" position.	HOMELEC1PA	7-85901-70872-8
	For padlocking 2-pole CAFCI, GFI, and EPD HOM breakers in "ON" or "OFF" position.	HOMELEC2PALA	7-85901-72572-5
Mechanical Interlock Attachment with Retaining Kit	QO2DTI mechanical interlock attachment with retaining kit for securing two adjacent back-fed circuit breakers in dual power supply applications. Can be used with (2) 2-poles or (1) 2-pole and (1) 1-pole QO circuit breakers in QO816L100 load centers.	QO2DTIM+	7-85901-78471-5
<b>Bolt-On Hubs</b>	Meter socket Bolt-On "A" hub	A100	7-85901-02948-9
		A125	7-85901-02949-6
		A150	7-85901-02950-2
		A200	7-85901-02951-9
		A200L	7-85901-13009-3
		A250	7-85901-02952-6
		A250L	7-85901-10798-9
		A300L	7-85901-10797-2
		Outdoor Bolt-On "B" hub	B075
	B100		7-85901-45942-2
	B125		7-85901-45944-6
	B150		7-85901-45945-3
	B200		7-85901-45947-7
	B250		7-85901-45948-4
	B300		7-85901-61583-5



Accessory	Description	Catalog #	UPC Code**
Sub-Feed Lugs	2-pole plug-on – 2 spaces required		
	– 125A	HOML2125+	7-85901-06592-0
	– 60A (#6 - 2 Al/Cu) – 125A (#4 - 2/0 Al/Cu)	QO60SL QO2125SL+	Special Order 7-85901-03115-4
Filler Plates	Fills opening in covers if twistout is removed in error	HOMFPCP	7-85901-07149-2
		QOFPCP	0-47569-07224-6
Closing Plates	To be installed on TOP endwall	ACPACP	0-47569-73540-0
		ACPCP	0-47569-73539-4
Lock Kits	Use with convertible load center covers (Indoor)	PK6FL+	7-85901-74631-7
Neutral Lugs/ Ground Lugs	Field installed for #12 - 2 Al or #14 - 4 Cu wire	LK70ANCP▲	7-85901-48311-3
		HOM70ANCP	0-47569-73532-5
		QO70ANCP	0-47569-91173-6
	Field installed for #6 - 2/0 Al/Cu wire	LK100ANCP▲	7-85901-43664-2
		HOM100ANCP	0-47569-73534-9
	Field installed for #2 - 3/0 Al/Cu wire	LK150AN▲+	7-85901-73835-0
Ground Bar Kits	Standard PK15GTA with a #1 - 4/0 Al/Cu Lug	PK15GTAL+	7-85901-44087-1
	Standard PK18GTA with a #1 - 4/0 Al/Cu Lug	PK18GTAL+	7-85901-44088-8
	Standard PK23GTA with a #1 - 4/0 Al/Cu Lug	PK23GTAL+	7-85901-44089-5
Ground Bars  Number of terminals listed at right.  All suitable for: (1) #14 - 4 or (2) #14 or #12 Cu or (1) #12 - 4 or (2) #12 or #10 Al	Two terminals suitable for (1) #10 - 2/0 Cu or (1) #6 - 2/0 Al	PK0GTA2	7-85901-43267-8
	Three terminals	PK3GTA1CP	0-47569-51730-3
	Four terminals	PK4GTACP	0-47569-51731-0
	Seven terminals	PK7GTACP	0-47569-51732-7
	Nine terminals	PK9GTACP	0-47569-51733-4
	Twelve terminals	PK12GTACP	0-47569-51735-8
	Fifteen terminals	PK15GTACP	0-47569-57033-9
	Eighteen terminals	PK18GTACP	0-47569-51738-9
	Twenty-three terminals	PK23GTACP	0-47569-51739-6
	<b>Miscellaneous</b>		
Retaining Kit	Secures circuit breaker to interior when used as a back-fed main. For QO612L100F/S,RB, QO612L100DF/S, QO816L100F/S,RB and QO816L100DF/S load centers.	PK2MBCP	0-47569-51734-1
	Secures ONE circuit breaker, with or without electrical accessories, to right side of interior when used as a back-fed main. For 100 to 125A convertible main load centers. Series S01 and S02.	PK4MB2LA+	7-85901-30718-1
	Secures ONE circuit breaker, with or without electrical accessories, to right side of interior when used as a back-fed main. For 150 to 225A convertible main load centers. Series S01 and S02.	PK4MB2HA+	7-85901-30717-4
Manual Transfer Equipment Transfer	Secures TWO circuit breakers to right side of interior when used as back-fed mains, a QO2DTI Kit included for back-up power supply applications. For 100A to 125A convertible main load centers. Series S01 and S02.	PK4DTIM4LA+	7-85901-40027-1
	Secures TWO circuit breakers to right side of interior when used as back-fed mains, a QO2DTI Kit included for back-up power supply applications. For 150A to 225A convertible main load centers. Series S01 and S02.	PK4DTIM4HA+	7-85901-30716-7
	Secures TWO circuit breakers to left side of interior when used as back-fed mains, a QO2DTI Kit included for back-up power supply applications. For 100A to 125A convertible main load centers. Series S01 and S02.	PK4DTIM4LAL+	7-85901-30721-1
Cover Screws	Clamshell package of six load center cover screws. Fits all QO and Homeline load centers.	S106	0-47569-44073-1
Surge Protector Mounting Kit	UL listed for mounting hardwired SDSA1175 surge arrester into ground bar mounting holes on convertible load centers.	QOSAMK	7-85901-00298-7

Accessories

- UL Listed
- QO accessories can only be used with QO load centers



PK7GTACP



ACPCP



LK100ANCP



S106

\* For use in QO load centers prior to series S1.

\*\* Where UPC code is not shown, contact Square D sales representative for ordering information.

▲ For use in QO and Homeline load centers.

+ Item may require additional lead time.



# QO Load Centers

## The Leading Choice

Our Square D brand load centers are the leading choice of electrical contractors and electricians. Every feature of the QO load centers was designed to provide clear advantages. Quality features designed to simplify installation, improve reliability and enhance safety.

### QO Load Center Features:

- Shielded copper bus bar insulates and secures the interior
- Ground bar is included with all main lugs load centers with three mounting locations
- Convertible mains allow you to meet changing job site requirements by field converting main breaker load centers to main lugs and vice versa
- Straight-in mains design minimized cable bends, cutting waste and saving time
- Available Plug-on Neutral option\*
- 22,000/10,000 AIR standard series connected rating
- Lifetime limited warranty (see page 82)

#### \* The Plug-on Neutral Advantage:

- *Faster installation – Fewer connections*
- *Saves wire – Fully distributed split neutral bar*
- *Frees gutter space – No pigtails*
- *Faster and easier wiring – All spaces accept tandems*

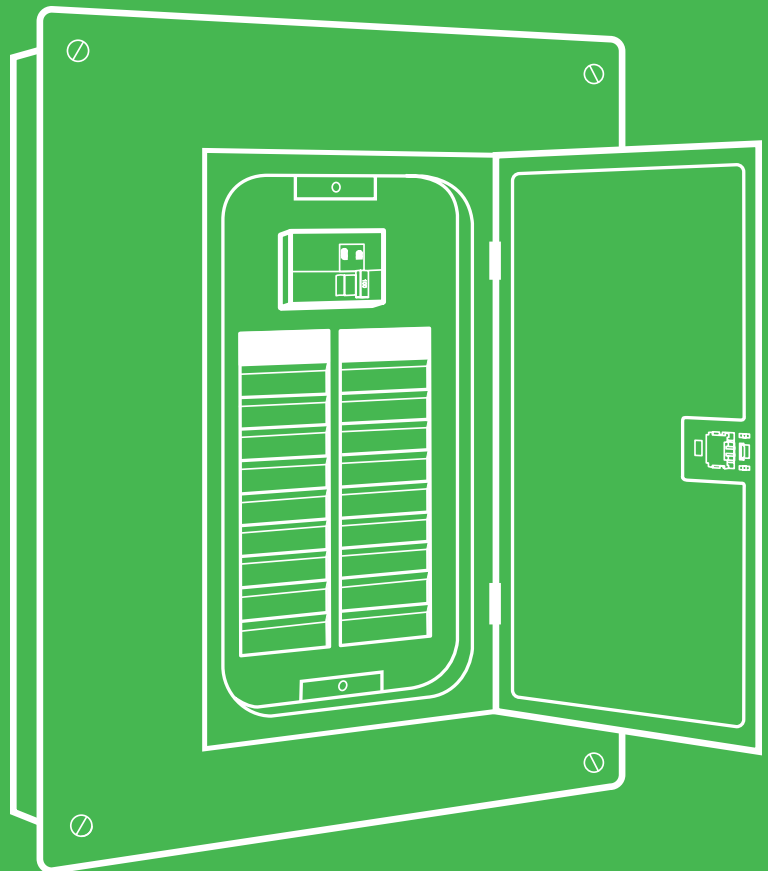

For nearly half a century, QO products have been the choice of professionals – chosen two to one over any other brand. The quality and protection standards of the QO line lead the industry by providing unsurpassed protection and reliability.



# QO and Homeline Load Centers – Catalog Number Guide

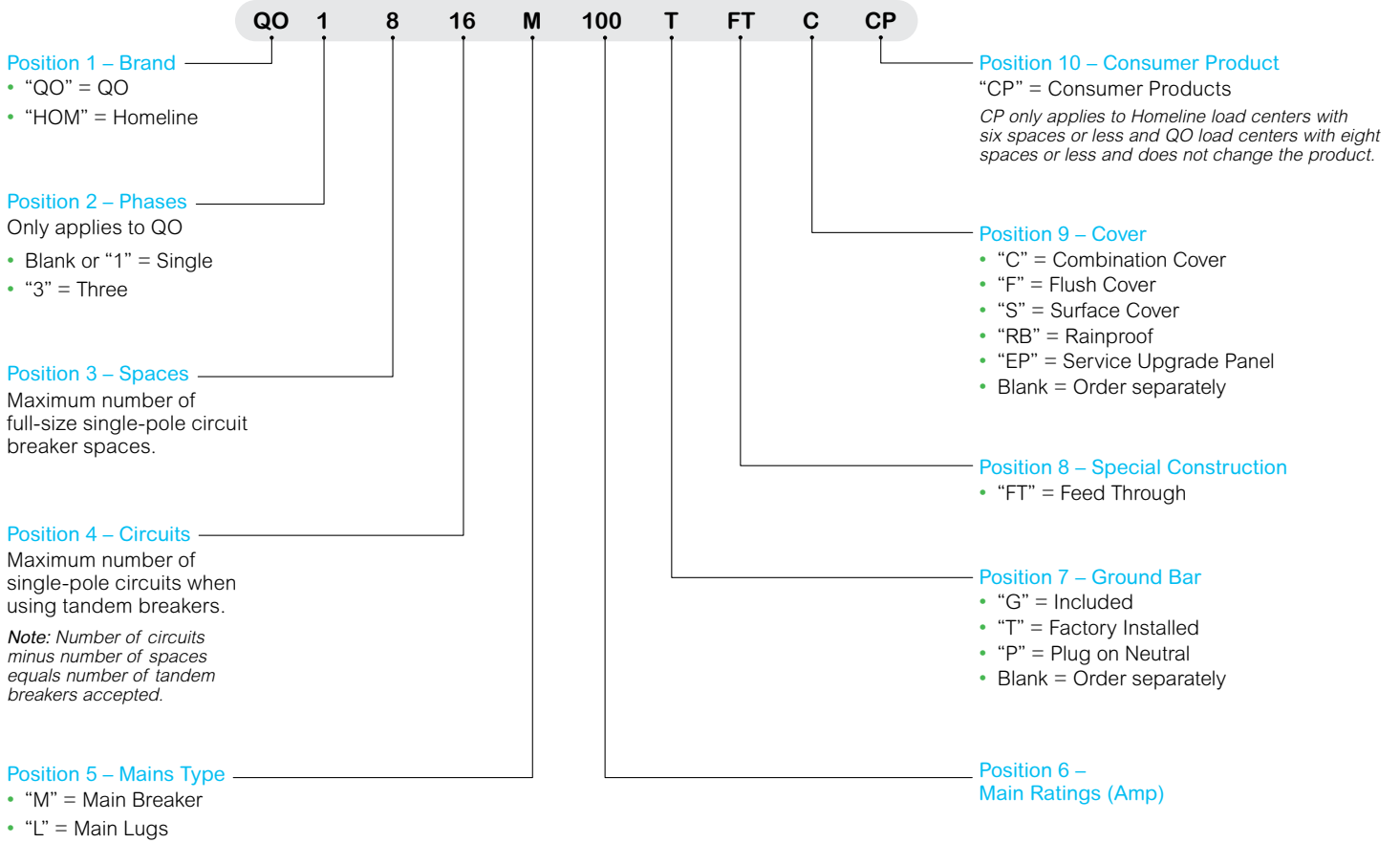

## QO Plug-on Neutral Load Centers – Main Breaker

Amps	Spaces	Max. Circuits	Cover	Catalog #	Ground Bar	UPC Code	Box Size
<b>Indoor – QOM1 Main Breaker Frame Size</b>							<i>(see pg.22)</i>
100	24	24	Combination	QO124M100PC	PK15GTA	7-85901-97848-0	7
<b>Indoor – QOM2 Main Breaker Frame Size</b>							<i>(see pg.22)</i>
200	30	30	Combination	QO130M200PC	PK18GTA	7-85901-96018-8	9
	42	42	Combination	QO142M200PC	PK23GTA	7-85901-98689-8	11
	54	54	Combination	QO154M200PC	PK23GTA	7-85901-99713-9	12
	60	60	Combination	QO160M200PC	PK23GTA	7-85901-44752-8	24
<b>Outdoor – QOM1 Main Breaker Frame Size</b>							<i>(see pg.23)</i>
100	24	24	Rainproof	QO124M100PRB	PK15GTA	7-85901-13756-6	4R
<b>Outdoor – QOM2 Main Breaker Frame Size</b>							<i>(see pg.23)</i>
150	30	30	Rainproof	QO130M150PRB	PK18GTA	7-85901-96022-5	6R
	30	30	Rainproof	QO130M200PRB	PK18GTA	7-85901-22900-1	6R
	200	42	42	Rainproof	QO142M200PRB	PK23GTA	7-85901-28508-3

## QO Plug-on Neutral Load Centers – Main Lugs

Amps	Spaces	Max. Circuits	Cover	Catalog #	Ground Bar	UPC Code	Box Size
<b>Indoor – QOM1 Main Lug Frame Size</b>							<i>(see pg.22)</i>
125	24	24	Combination	QO124L125PGC	PK15GTA	7-85901-97837-4	7
<b>Indoor – QOM2 Main Lug Frame Size</b>							<i>(see pg.22)</i>
200	30	30	Combination	QO130L200PGC	PK23GTA, LK100AN	7-85901-97644-8	9
225	42	42	Combination	QO142L225PGC	(2) PK15GTA	7-85901-98116-9	11
	54	54	Combination	QO154L225PGC	PK23GTA, LK100AN	7-85901-99718-4	12
<b>Outdoor – QOM1 Main Lug Frame Size</b>							<i>(see pg.23)</i>
125	24	24	Rainproof	QO124L125PGRB	PK15GTA	7-85901-10138-3	4R
<b>Outdoor – QOM2 Main Lug Frame Size</b>							<i>(see pg.23)</i>
200	30	30	Rainproof	QO130L200PGRB	PK23GTA, LK100AN	7-85901-10391-2	6R
225	42	42	Rainproof	QO142L225PGRB	(2) PK15GTA	7-85901-23365-7	8R



QO124M100PC



QO142M200PC



QO130M200PRB



QO130L200PGC



QO142L225PGRB

# QO Load Centers – Main Lugs

## Main Lugs

- UL Listed
- Single-Phase, 3-Wire
- 120/240 Vac
- 12 Spaces and Higher Panels  
Convertible to Main Breaker
- Factory Installed Main Lugs
- Copper Bus Bar  
Only on 12 Spaces and Higher

Amps	Spaces	Max. Circuits	Cover	Catalog #	Ground Bar	UPC Code	Box Size
<b>Indoor – 10,000 AIR</b>							(see pg.22)
30	2	2	Surface	QO2L30SCP●❑	PK3GTA1	0-47569-80432-8	1
70	2	4	Flush	QO24L70FCP●■	PK4GTA	0-47569-80435-9	2
	2	4	Surface	QO24L70SCP●■	PK4GTA	0-47569-80436-6	2
100	6	12	Flush	QO612L100FCP●	PK7GTA	0-47569-80508-0	4
	6	12	Surface	QO612L100SCP●	PK7GTA	0-47569-80507-3	4
	6	12	Flush	QO612L100DF●	PK7GTA	7-85901-78564-4	4
	6	12	Surface	QO612L100DS●	PK7GTA	7-85901-78562-0	4
	8	16	Flush	QO816L100FCP●	PK7GTA	0-47569-80475-5	4
	8	16	Surface	QO816L100SCP●	PK7GTA	0-47569-80476-2	4
	8	16	Flush	QO816L100DF●	PK7GTA	7-85901-78569-9	4
	8	16	Surface	QO816L100DS●	PK7GTA	7-85901-78574-3	4
125	4	8	Flush	QO148L125GF+	Included	7-85901-48438-7	21
	4	8	Surface	QO148L125GS+	Included	7-85901-48440-0	21
<b>Indoor – QOM1 Main Frame Size: Convertible to 22,000 AIR Main Breaker</b>							(see pg.22)
125	12	12	Combination	QO112L125GC	Included	7-85901-86845-3	6
	12	24	Combination	QO11224L125GC	Included	7-85901-84120-3	6
	16	16	Order Separately*	QO116L125G	Included	7-85901-84773-1	7
	16	24	Order Separately*	QO11624L125G+	Included	7-85901-84130-2	7
	20	20	Combination	QO120L125GC	Included	7-85901-84786-1	7
	20	24	Order Separately*	QO12024L125G+	Included	7-85901-84777-9	7
	24	24	Order Separately*	QO124L125G+	Included	7-85901-84790-8	7
<b>Indoor – QOM2 Main Frame Size: Convertible to 22,000 AIR Main Breaker</b>							(see pg.22)
150	20	30	Order Separately*	QO12030L150G+	Included	7-85901-84779-3	9
	24	24	Order Separately*	QO124L150G+	Included	7-85901-84791-5	9
	30	30	Order Separately*	QO130L150G+	Included	7-85901-84801-1	9
200	12	12	Order Separately*	QO112L200G+	Included	7-85901-84124-1	9
	30	30	Order Separately*	QO130L200G+	Included	7-85901-84802-8	9
	30	40	Combination	QO13040L200GC	Included	7-85901-84798-4	9
225	42	42	Order Separately*	QO142L225G+	Included	7-85901-86775-3	11
<b>Outdoor – Non-metallic Enclosure</b>							(see pg.23)
60	2	4	Rainproof	QO24L60NRNM	Included	7-85901-32802-5	1NM
<b>Outdoor – 10,000 AIR</b>							(see pg.23)
40	2	2	Rainproof	QO2L40RBCP●■	PK3GTA1	0-47569-80437-3	1R
70	2	4	Rainproof	QO24L70RBCP●■	PK4GTA	0-47569-80438-0	1R
100	6	12	Rainproof	QO612L100RBCP●	PK7GTA	0-47569-80509-7	2R
	8	16	Rainproof	QO816L100RBCP●	PK7GTA	0-47569-80477-9	2R
125	4	8	Rainproof	QO148L125GRB+	Included	7-85901-48439-4	15R
<b>Outdoor – QOM1 Main Frame Size: Convertible to 22,000 AIR Main Breaker</b>							(see pg.23)
125	12	12	Rainproof	QO112L125GRB+	Included	7-85901-86785-2	3R
	12	24	Rainproof	QO11224L125GRB	Included	7-85901-86784-5	3R
	16	24	Rainproof	QO11624L125GRB	Included	7-85901-86788-3	4R
	24	24	Rainproof	QO124L125GRB	Included	7-85901-86799-9	4R
<b>Outdoor – QOM2 Main Frame Size: Convertible to 22,000 AIR Main Breaker</b>							(see pg.23)
150	30	30	Rainproof	QO130L150GRB	Included	7-85901-86808-8	6R
200	12	12	Rainproof	QO112L200GRB	Included	7-85901-86786-9	5R
	30	30	Rainproof	QO130L200GRB	Included	7-85901-86809-5	6R
	30	40	Rainproof	QO13040L200GRB	Included	7-85901-86806-4	6R
225	42	42	Rainproof	QO142L225GRB+	Included	7-85901-86815-6	8R



QO13040L200GC



QO11624L125GRB

Listings thru 200A mains meet Federal Specification W-P-115c as Type 1, Class 2.

- Not supplied with copper bus bar.
- \* Will not accept Qwik-Gard QO GFI circuit breakers.
- ❑ Mains rated 25A when aluminum wire is used.
- Use #10 maximum size wire for GFI circuit breaker.
- \* Contact Square D sales representative for ordering information.
- + Item may require additional lead time.

# QO Load Centers – Main Breaker

Amps	Spaces	Max. Circuits	Cover	Catalog #	Ground Bar	UPC Code	Box Size
<b>Indoor – QOM1 Main Breaker Frame Size</b>							<i>(see pg.22)</i>
100	12	12	Combination	QO112M100C	PK9GTA	7-85901-84127-2	5
	12	20	Combination	QO11220M100C	PK15GTA	7-85901-84118-0	5
	16	16	Combination	QO116M100C	PK15GTA	7-85901-84775-5	6
	20	20	Combination	QO120M100C	PK15GTA	7-85901-84788-5	6
	24	24	Order Separately*	QO124M100+	PK15GTA	7-85901-84792-2	7
	32	32	Order Separately*	QO132M100	PK18GTA	7-85901-19337-1	8
125	24	24	Order Separately*	QO124M125+	PK15GTA	7-85901-84793-9	7
	32	32	Order Separately*	QO132M125	PK18GTA	7-85901-19338-8	8
<b>Indoor – QOM2 Main Breaker Frame Size</b>							<i>(see pg.22)</i>
150	24	24	Order Separately*	QO124M150+	PK15GTA	7-85901-84794-6	9
	30	30	Combination	QO130M150C	PK18GTA	7-85901-86743-2	9
	32	32	Order Separately*	QO132M150+	PK23GTA	7-85901-39489-1	10
200	20	40	Combination	QO12040M200C	PK23GTA	7-85901-84783-0	9
	24	24	Order Separately*	QO124M200+	PK15GTA	7-85901-84795-3	9
	30	30	Combination	QO130M200C	PK18GTA	7-85901-86754-8	9
	30	40	Combination	QO13040M200C	PK23GTA	7-85901-84800-4	9
	40	40	Combination	QO140M200C	PK23GTA	7-85901-86766-1	10
	42	42	Order Separately*	QO142M200+	PK23GTA	7-85901-39490-7	11
225	40	40	Order Separately*	QO140M225+	PK23GTA	7-85901-86767-8	11
<b>Outdoor – QOM1 Main Breaker Frame Size</b>							<i>(see pg.23)</i>
100	12	12	Rainproof	QO112M100RB+	PK9GTA	7-85901-86787-6	3R
	16	16	Rainproof	QO116M100RB+	PK12GTA	7-85901-86794-4	4R
	20	20	Rainproof	QO120M100RB	PK15GTA	7-85901-86798-2	4R
125	24	24	Rainproof	QO124M125RB+	PK15GTA	7-85901-86804-0	4R
<b>Outdoor – QOM2 Main Breaker Frame Size</b>							<i>(see pg.23)</i>
150	20	30	Rainproof	QO12030M150RB	PK18GTA	7-85901-86796-8	5R
	30	30	Rainproof	QO130M150RB+	PK18GTA	7-85901-86810-1	6R
200	20	40	Rainproof	QO12040M200RB	PK23GTA	7-85901-86797-5	5R
	30	30	Rainproof	QO130M200RB	PK18GTA	7-85901-86811-8	6R
	40	40	Rainproof	QO140M200RB	PK23GTA	7-85901-86813-2	7R
<b>Outdoor – Feed Thru: 22,000 AIR (mobile home applications)</b>							<i>(see pg.23)</i>
125	6	12	Rainproof	QO1612M125FTRB+▲	PK12GTA	7-85901-86816-3	3R
150	8	16	Rainproof	QO1816M150FTRB	PK15GTA-L	7-85901-86817-0	6R
200	8	16	Rainproof	QO1816M200FTRB	PK15GTA-L	7-85901-86818-7	6R

## Main Circuit Breakers

- UL Listed, NOM Certified
- Single-Phase, 3-Wire
- 120/240 Vac – UL Listed
- 22k AIR♦
- Convertible to Main Lugs or Lower Amperage Main Breaker
- Factory Installed Main Breaker
- Copper Bus

*Listings thru 200A mains meet Federal Specification W-P-115c as Type 1, Class 2.*

♦ 22k AIR main circuit breaker UL listed for use ahead of QO and QOT 10k AIR branch breakers to permit their application systems with up to 22kA available fault current.

\* Contact Square D sales representative for ordering information.

♦ Item may require additional lead time.

▲ QO1612M125FTRB provided with QOM1 frame main circuit breaker.



QO120M100C



QO120M100RB



QO140M200C



QO140M200RB

## QO – Field Installable

Amps▲	Use With Main Lug Load Center Mains Rating	Main Circuit Breaker Catalog #	Main Wire Size AWG/ kcmil (Al or Cu)	UPC Code
<b>Field Installable Main Breaker (convertible load centers only): QOM1 Frame Size</b>				
50	100-125	QOM50VH+	—	7-85901-87959-6
60	100-125	QOM60VH+	—	7-85901-87960-2
70	100-125	QOM70VH+	—	7-85901-05471-9
80	100-125	QOM80VH+	—	7-85901-05472-6
90	100-125	QOM90VH+	#12 - 2/0	7-85901-05473-3
100	100-125	QOM100VHCP	—	0-47569-82259-9
110	125	QOM110VH	—	Special Order
125	125	QOM125VHCP	—	0-47569-03461-9
<b>Field Installable Main Breaker (convertible load centers only): QOM2 Frame Size</b>				
100	150-225	QOM2100VH+	—	7-85901-02195-7
125	150-225	QOM2125VH+	—	7-85901-02197-1
150	150-225	QOM2150VH	#4 - 300	7-85901-00405-9
175	200-225	QOM2175VH+	—	7-85901-84858-5
200	200-225	QOM2200VH	—	7-85901-00406-6
225	225	QOM2225VH	—	7-85901-00407-3
<b>Field Installable Main Lugs (convertible load centers only)</b>				
125	100-125	QOL125+	#6 - 2/0	7-85901-74796-3
200	150-225	QOL225+	#6 - 300	7-85901-74797-0



QOM2E2200NRB

Product	Catalog #	UPC Code
<b>High Amperage Breaker Enclosures</b>		
Outdoor Enclosure with Factory Installed 200A Main Breaker (Replaces Q2E2200NRBCP)	QOM2E2200NRB	7-85901-37530-2
Outdoor Enclosure Only (100A to 225A QOM2 Main Breaker order separately)	QOM22225NRB	7-85901-32887-2
Indoor Surface Mount Enclosure Only (100A to 225A QOM2 Main Breaker order separately)	QOM22225NS+	7-85901-32886-5

- + Item may require additional lead time.
- ▲ Do not exceed the load center mains rating.

# Indoor Knockout Information and Enclosure Dimensions

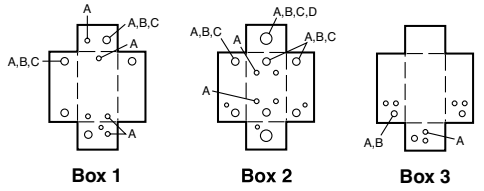

Table 1.49: Enclosure Dimensions

Box No.	Dimensions					
	W		H		D	
	in.	mm	in.	mm	in.	mm
1	3.81	97	6.72	171	3.00	76
2	4.81	122	9.30	236	3.19	81
3	4.81	122	9.30	236	3.19	81
4	8.88	226	12.57	319	3.80	97
5	14.25	362	14.92	379	3.75	95
6	14.25	362	17.92	455	3.75	95
7	14.25	362	20.92	531	3.75	95
8	14.25	362	26.04	661	3.75	95
9	14.25	362	29.86	758	3.75	95
10	14.25	362	33.78	858	3.75	95
11	14.25	362	37.98	965	3.75	95
12	14.25	362	93.37	1000	3.75	95
13	5.88	149	13.12	333	3.38	86

Box No.	Dimensions					
	W		H		D	
	in.	mm	in.	mm	in.	mm
14	14.25	362	20.92	531	3.75	95
15	20.00	508	50.00	1270	5.75	146
16	20.00	508	62.00	1727	5.75	146
17	20.00	508	53.00	1346	5.75	146
18	5.88	149	16.12	409	3.38	86
19	7.56	192	23.12	587	4.25	108
20	9.62	244	26.12	663	4.75	121
21	8.88	226	14.80	376	3.80	97
22	8.55	217	23.92	608	3.95	100
23	14.25	362	29.86	758	3.75	95
24	14.25	362	43.15	1096	3.75	95
25	14.25	362	48.50	1235	3.75	95

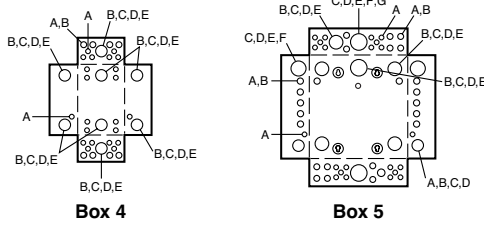
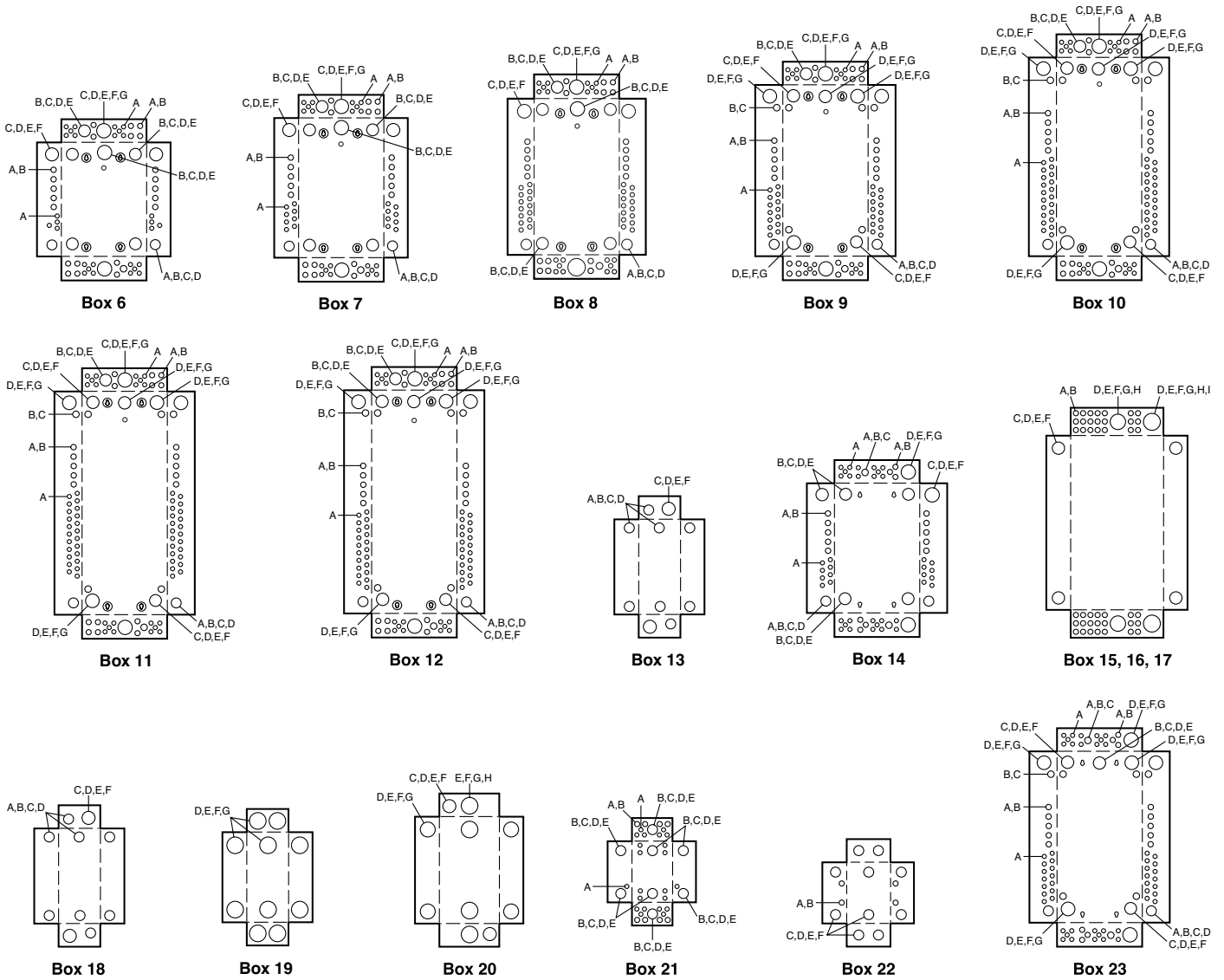

Table 1.50: Knockout Information

Symbol	Knockouts								
	A	B	C	D	E	F	G	H	I
Conduit Size	½	¾	1	1¼	1½	2	2½	3	3½



# Rainproof Knockouts, Dimensions, Bolt-On Hubs Information

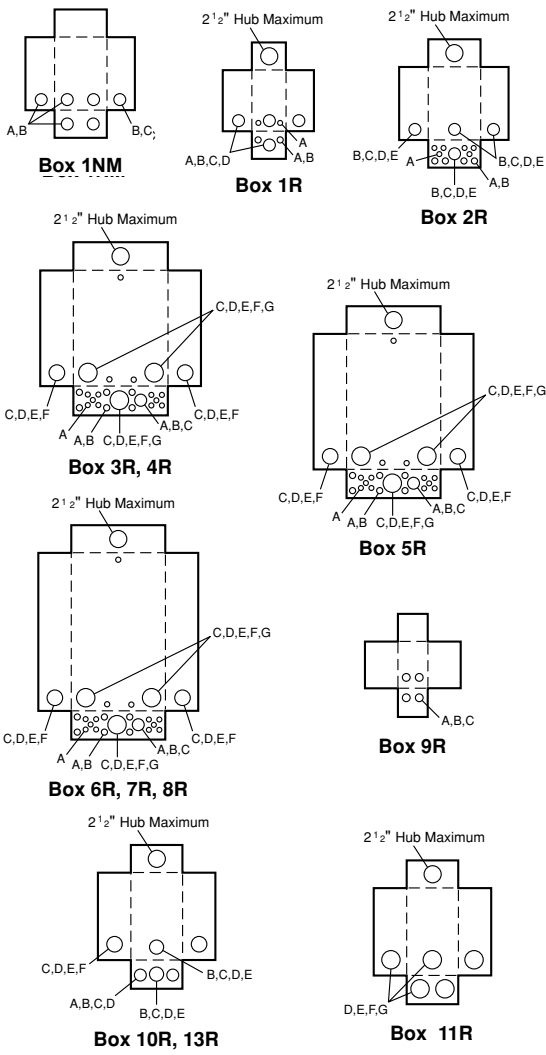

Table 1.48: Enclosure Dimensions

Box No.	Dimensions					
	W		H		D	
	in.	mm	in.	mm	in.	mm
1NM	6.52	166	8.79	223	3.90	99
1R*	4.88	124	9.38	238	4.00	102
2R	8.88	226	12.65	321	4.27	108
3R	14.75	375	18.92	481	4.52	115
4R	14.75	375	22.06	560	4.52	115
5R	14.75	375	26.04	661	4.52	115
6R	14.75	375	29.86	758	4.52	115
7R	14.75	375	33.78	858	4.52	115
8R	14.75	375	37.98	965	4.52	115

Box No.	Dimensions					
	W		H		D	
	in.	mm	in.	mm	in.	mm
9R	4.56	116	6.50	165	3.88	99
10R	6.92	176	13.18	335	4.12	105
11R	7.56	192	23.24	590	4.75	121
12R	9.62	244	26.24	666	5.50	140
13R	6.92	176	16.18	411	4.12	105
14R	14.75	375	39.37	1000	4.52	115
15R	8.88	226	14.80	376	4.27	108
16R	8.55	217	24.75	629	4.16	106

\*HOME250SPA and QO260NATR top endwall has no hub opening.

Table 1.49: Knockout Information

Symbol	Knockouts							
	A	B	C	D	E	F	G	H
Conduit Size	½ in.	¾ in.	1 in.	1¼ in.	1½ in.	2 in.	2½ in.	3 in.



## Bolt-On Hubs

Square D equipment with "R" or "RB" suffix, designated NEMA 3R rainproof construction, utilizes bolts-on hubs listed below. "RB" devices will accept ¾" through 2½" bolt-on hubs without the use of reducers. Off-center conduit thread openings and elongated mounting holes provide quick and easy adjustment to eliminate costly conduit offsets and bends. Catalog suffix "R" devices require 3" through 4" field cut opening. Hubs are suitable for use with conduit having ANSI standard taper pipe thread.

Table 1.50: Bolt-On Hubs UL Listed for "RB" Devices\*

Conduit Size	¾ in.	1 in.	1¼ in.	1½ in.	2 in.	2½ in.
Hub Cat. No.	B075	B100	B125	B150	B200	B250

\*Closing cap (Cat. No. BCAP) is provided factory-installed on each device having "RB" suffix

Table 1.51: Bolt-On Hubs UL Listed for Mounting in Field-Cut Opening

Conduit Size	3 in.	3½ in.	4 in.	
Hub Cat. No.	B300	B350	B400	Designed for mounting in field cut opening. Includes gasket and four mounting bolts and nuts.

# QO Load Centers – Main Wire Sizes

## 1-Phase 3-Wire Main Breakers

Main Breaker Load Centers	
Catalog Number	Main Wire Size AWG/kcmil (Al or Cu)
<b>Indoor</b>	
QO112M100C	#6 - 1
QO11220M100C	#6 - 2/0
QO116M100C	#6 - 1
QO120M100C	#6 - 1
QO124M100	#6 - 2/0
QO124M125	#6 - 2/0
QO12030M150C	#4 - 250
QO124M150	#4 - 250
QO130M150C	#4 - 250
QO12040M200C	#4 - 250
QO124M200	#4 - 250
QO130M200C	#4 - 250
QO13040M200C	#4 - 250
QO132M125C	#6 - 2/0
QO132M150	#4 - 250
QO140M200C	#4 - 250
QO140M225	#4 - 300
QO142M200	#4 - 300
QO124M100PC	#6 - 2/0
QO130M200PC	#4 - 250
QO142M200PC	#4 - 250
QO154M200PC	#4 - 250
QO160M200PC	#4 - 250
<b>Outdoor</b>	
QO112M100RB	#6 - 2/0
QO116M100RB	#6 - 2/0
QO120M100RB	#6 - 2/0
QO124M125RB	#6 - 2/0
QO12030M150RB	#4 - 250
QO130M150RB	#4 - 250
QO12040M200RB	#4 - 250
QO130M200RB	#4 - 250
QO140M200RB	#4 - 250
QO124M100PRB	#6 - 2/0
QO130M150PRB	#4 - 250
QO130M200PRB	#4 - 250
QO142M200PRB	#4 - 250
<b>Feed Thru</b>	
QO1612M125FTRB	#6 - 2/0
QO1816M150FTRB	#4 - 250
QO1816M200FTRB	#4 - 250

Main Lugs Load Centers	
Catalog Number	Main Wire Size AWG/kcmil (Al or Cu)
<b>Indoor</b>	
QO2L30SCP	#12 - 10 (Al) or #14 - 10 (Cu)
QO24L70FCP	#12 - 3 (Al) or #14 - 4 (Cu)
QO24L70SCP	#12 - 3 (Al) or #14 - 4 (Cu)
QO612L100FCP	#8 - #1
QO612L100DF	#8 - #1
QO612L100DS	#8 - #1
QO612L100SCP	#8 - #1
QO816L100FCP	#8 - #1
QO816L100DF	#8 - #1
QO816L100DS	#8 - #1
QO816L100SCP	#8 - #1
QO148L125GF	#14 - 2/0
QO148L125GS	#14 - 2/0
QO112L125GC	#6 - 2/0
QO11224L125GC	#6 - 2/0
QO116L125G	#6 - 2/0
QO11624L125G	#6 - 2/0
QO120L125GC	#6 - 2/0
QO12024L125G	#6 - 2/0
QO124L125G	#6 - 2/0
QO12030L150G	#6 - 250
QO124L150G	#6 - 250
QO130L150G	#6 - 250
QO112L200G	#6 - 250
QO130L200G	#6 - 250
QO13040L200GC	#6 - 250
QO142L225G	#6 - 300
QO124L125PGC	#6 - 2/0
QO130L200PGC	#6 - 250
QO142L225PGC	#6 - 300
QO154L225PGC	#6 - 300
<b>Outdoor</b>	
QO24L60NRNM	#14 - 4
QO2L40RBCP	#12 - 6 (Al) or #14 - 6 (Cu)
QO24L70RBCP	#12 - 3 (Al) or #14 - 4 (Cu)
QO612L100RBCP	#8 - 1
QO816L100RBCP	#8 - 1
QO148L125GRB	#14 - 2/0
QO112L125GRB	#6 - 2/0
QO11224L125GRB	#6 - 2/0
QO11624L125GRB	#6 - 2/0
QO124L125GRB	#6 - 2/0
QO130L150GRB	#4 - 250
QO112L200GRB	#4 - 250
QO130L200GRB	#4 - 250
QO13040L200GRB	#4 - 250
QO142L225GRB	#4 - 300
QO124L125PGRB	#6 - 2/0
QO130L200PGRB	#6 - 250
QO142L225PGRB	#6 - 300



# QO Load Centers – Wiring Diagrams

## 1-Phase 3-Wire Main Breakers

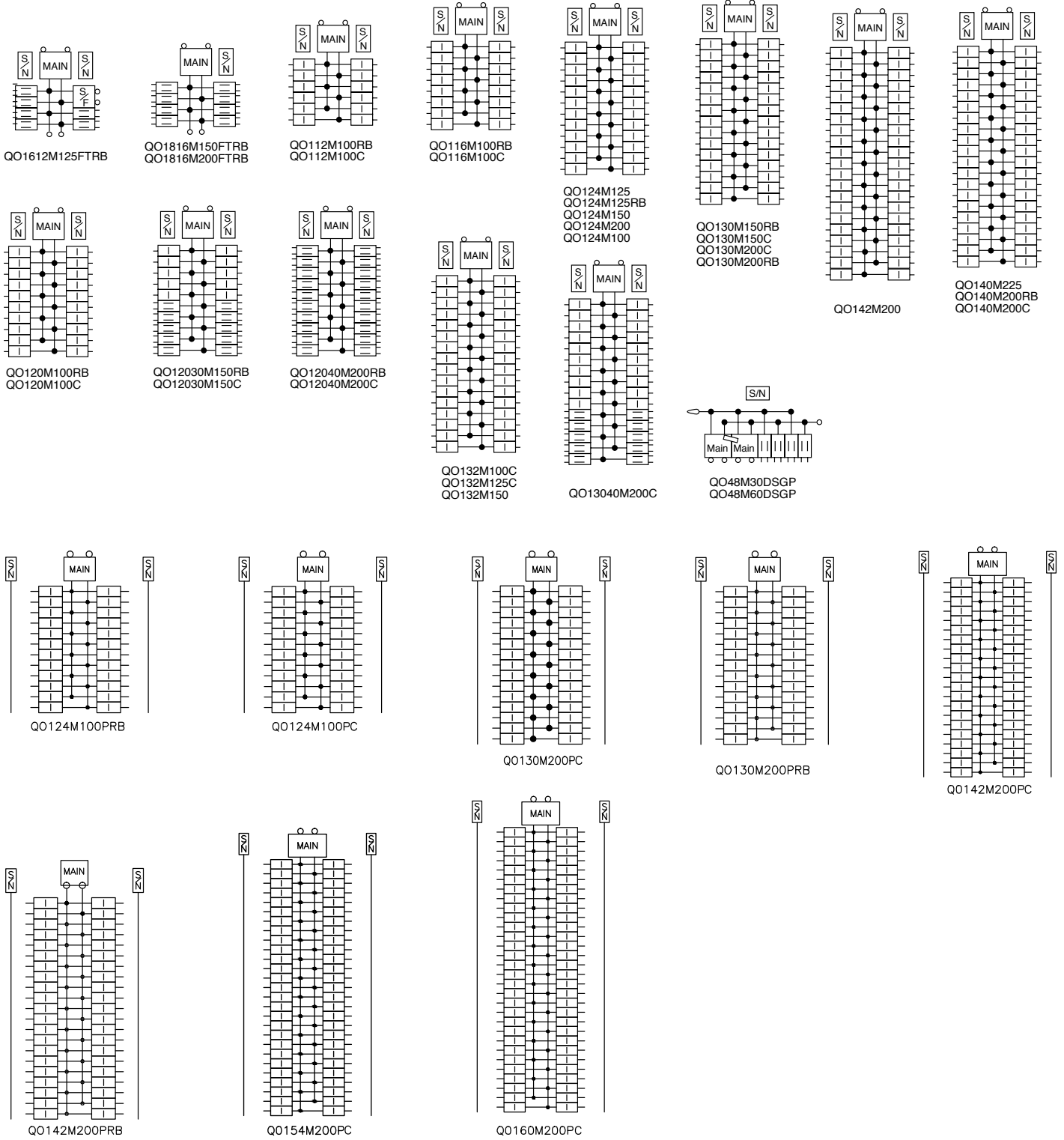

## 1-Phase 3-Wire Main Lugs

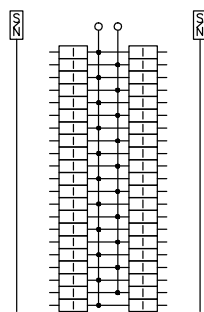
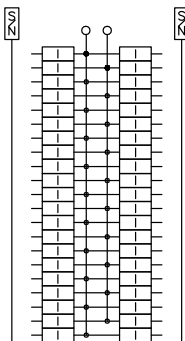
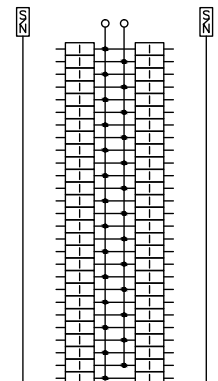
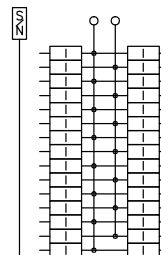
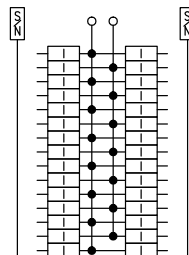
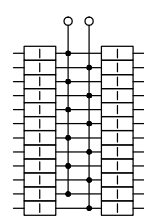
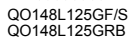
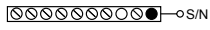
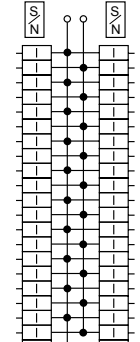
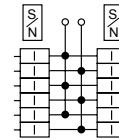
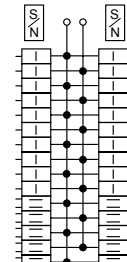
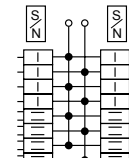
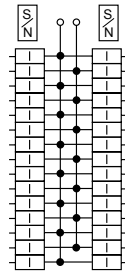
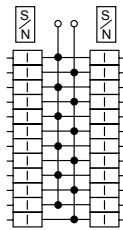
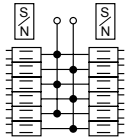
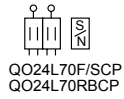
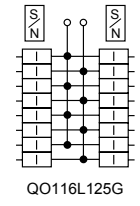
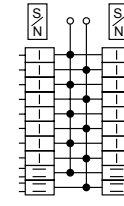
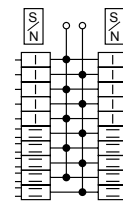
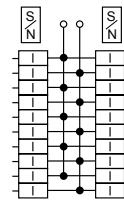
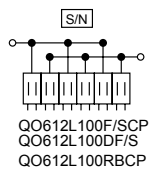
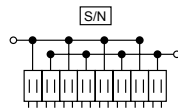
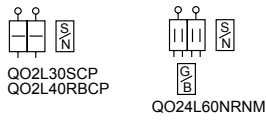



# Homeline Circuit Breakers

## The Best In Class

Homeline Circuit Breakers are built with the same Square D brand quality you have come to expect at a price that makes them the best value in their class.

### Homeline Circuit Breaker Features:

- Standard 1" format
- Trip thermally (in an overload situation) or magnetically (under a short circuit situation)
- Switching duty rating (SWD) on 15A and 20A single-pole breakers
- Quick make – quick break mechanism
- Plug-on Neutral design available, saving you money with quicker installation times\*
- Limited lifetime warranty (see page 82 for details)

#### \* The Plug-on Neutral Advantage:

- *Faster installation – Fewer connections*
- *Saves wire – Fully distributed split neutral bar*
- *Frees gutter space – No pigtails*
- *Easier troubleshooting – TIME SAVER Diagnostics provide additional circuit information at the touch of a button*
- *Faster and easier wiring – All spaces accept tandems*

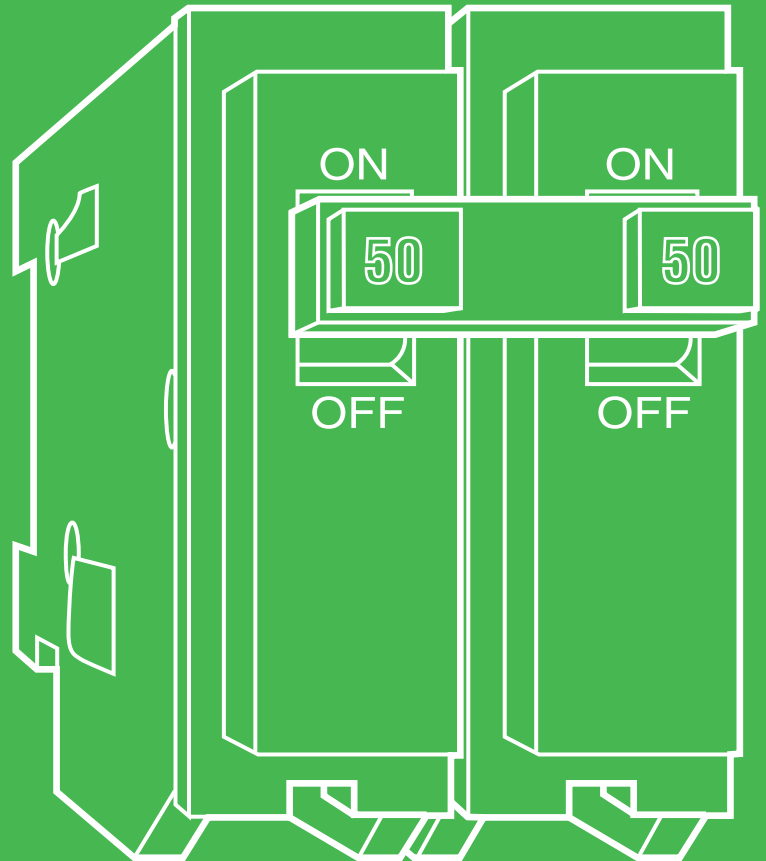

Homeline circuit breakers are the best in class. Designed exclusively for the residential market, Homeline products offer everything you need to distribute electricity throughout your home. Homeline offers the same quality as the QO line with only slight modifications that are tailored to the residential market.

# Homeline Circuit Breakers

1" Breaker Catalog Number Description			
HOM	1	15	C
Brand	# of Poles	Amps	Clam Shell Packaging

"C" denotes clam shell packaging.  
 "CP" denotes bulk bar coded breakers.

Full Size 1" Breakers*				
Amps	1-Pole Catalog #	UPC Code	2-Pole Catalog #	UPC Code
15	HOM115CP▲	0-47569-06270-4	HOM215CP	0-47569-06275-9
	HOM115C▲	0-47569-06287-2	HOM215C	0-47569-06292-6
20	HOM120CP▲	0-47569-06271-1	HOM220CP	0-47569-06276-6
	HOM120C▲	0-47569-06288-9	HOM220C	0-47569-07099-0
25	—	—	HOM225CP	0-47569-07160-7
30	HOM130CP	0-47569-06272-8	HOM230CP	0-47569-06277-3
	HOM130C	0-47569-06289-6	HOM230C	0-47569-07100-3
40	HOM140CP	0-47569-06273-5	HOM240CP	0-47569-06278-0
	HOM140C	0-47569-06290-2	HOM240C	0-47569-07101-0
50	HOM150CP	0-47569-06274-2	HOM250CP	0-47569-06279-7
	—	—	HOM250C	0-47569-07102-7
60	—	—	HOM260CP	0-47569-06280-3
	—	—	HOM260C	0-47569-07103-4
70	—	—	HOM270CP	0-47569-06281-0
80	—	—	HOM280CP	0-47569-06282-7
90	—	—	HOM290CP	0-47569-06283-4
100	—	—	HOM2100CP	0-47569-06285-8
	—	—	HOM2100C	7-85901-48242-0
125	—	—	HOM2125CP	0-47569-06286-5

\* UL listed as HACR type for use with air conditioning, heating and refrigeration equipment having motor group combinations and marked for use with HACR type circuit breakers.

▲ 15A to 20A tandem or quad tandem breakers are suitable for use with 60°C or 75°C conductors. 25A to 50A tandem or quad tandem are suitable for use with 75°C conductor only.

## Plug-On Circuit Breakers

- UL Listed
- 120/240 Vac
- 10k AIR



HOM120



HOM230

## Homeline Circuit Breakers – Tandem

Tandem Catalog Number Description			
HOM	T	15	15
Brand	Tandem Breakers	1st Pole Amps	2nd Pole Amps

"C" denotes clam shell packaging. "CP" denotes bulk bar coded breakers.

Tandem Breakers* 1-Pole (120/240 Vac)			
Amps		1-Pole Catalog #	UPC Code
1st Pole	2nd Pole		
15	15	HOMT1515CP	0-47569-07105-8
		HOMT1515C	0-47569-07107-2
15	20	HOMT1520CP	0-47569-40375-0
		HOMT2020CP	0-47569-07106-5
20	20	HOMT2020C	0-47569-07108-9
		HOMT3020CP	7-85901-40385-2

Quad Tandem Breakers* 2-Pole (120/240 Vac) 2 Spaces Required			
Amps		2-Pole Catalog #	UPC Code
1st Pole	2nd Pole		
(2) 15	15	HOMT1515215	7-85901-06935-5
	20	HOMT1515220CP	0-47569-07220-8
	30	HOMT1515230CP	0-47569-07221-5
	40	HOMT1515240CP	7-85901-39582-9
	50	HOMT1515250CP	7-85901-39583-6
(2) 20	20	HOMT2020220CP	0-47569-07222-2
	30	HOMT2020230CP	0-47569-07223-9
	40	HOMT2020240CP	7-85901-39584-3
	50	HOMT2020250CP	7-85901-39400-6

### Plug-On Circuit Breakers

- UL Listed
- 120/240 Vac
- 10k AIR



HOMT1520CP



HOMT2020240CP

**NOTE:** Homeline load center's accept tandem and Quad breakers.

\* UL listed as HACR type for use with air conditioning, heating and refrigeration equipment having motor group combinations and marked for use with HACR type circuit breakers.

▲ 15A to 20A tandem or quad tandem breakers are suitable for use with 60°C or 75°C conductors. 25A to 50A tandem or quad tandem are suitable for use with 75°C conductor only.

## Homeline Circuit Breakers – CAFCI

### HomeLine Combination Arc Fault Circuit Interrupters

Combination Arc Fault Circuit Interrupters could prevent more than 50 percent of the electrical fires that occur every year (U.S. Consumer Product Safety Commission estimate). Square D Combination Arc Fault Circuit Interrupters (AFCIs) are the first commercially available circuit breaker designed to meet the National Electrical Code® (NEC) requirements for Combination AFCI protection. Combination AFCI's, also known as Combination Arc Fault (CAFI) Circuit Breakers sense and respond to a broader range of arcing incidents than the standard AFCI circuit breakers, providing superior protection against electrical fires for homes and families.

Circuit Breaker Type	Ampere Rating	Pole 120 Vac	Catalog Number	UPC Code
<b>1-Pole</b>				
Combination Arc-Fault circuit Interrupter with Pigtail Neutral	15 A	1	HOM115CAFIC	7-85901-63098-2
	20 A	1	HOM120CAFIC	7-85901-47715-0
Plug-On Neutral Combination Arc-Fault Interrupter	15 A	1	HOM115PCAFIC	7-85901-97878-7
	20 A	1	HOM120PCAFIC	7-85901-97668-4
<b>2-Pole</b>				
Combination Arc-Fault Circuit Interrupter with Pigtail Neutral	15 A	2	HOM215CAFIC	7-85901-40073-8
	20 A	2	HOM220CAFIC	7-85901-40078-3

### CAFI Breakers

- UL Listed, CSA Approved
- 120/240 Vac
- 10k AIR
- CAFI: White Reset Button

The CAFI Circuit Breaker detects the arcing condition and turns off or trips the circuit, thus providing the enhanced electrical safety and protection.



HOM115CAFIC



HOM215CAFIC

# Homeline Circuit Breakers – GFCI

GFCI Catalog Number Description			
HOM	1	15	GFI
Brand	# of Poles	Amps	Ground Fault Circuit Interrupter

GFCI Breakers: 1-Pole (120 Vac) and 2-Pole (120/240 Vac)				
Amps	1-Pole Catalog #	UPC Code	2-Pole Catalog #	UPC Code
15	HOM115GFICP	0-47569-07109-6	HOM215GFI*	7-85901-30319-0
20	HOM120GFICP	0-47569-07110-2	HOM220GFI*	7-85901-16370-1
30	—	—	HOM230GFI*	7-85901-15287-3
40	—	—	HOM240GFI*	7-85901-21929-3
50	—	—	HOM250GFI	7-85901-78357-2
—	—	—	HOM250GFICP	7-85901-87589-5

Circuit Breaker Wire Sizes			
Breaker Type	Amp Rating	Wire Size (AWG)*	
		Aluminum	Copper
HOM – 1-Pole	15-30*	#14 - 8	(2) #14 - 10
	45-50*	#8 - 2	#8 - 2
HOM – 2-Pole	15-30*	#14 - 8	#14 - 8 or (2) #14 - 10
	35-70*	#8 - 2	#8 - 2
	80-125*	#4 - 2/0	#4 - 2/0
HOMT and QUAD	15-30▲	#14 - 8	#14 - 8
HOM-GFI – 1-Pole	15-20*	#14 - 10	#14 - 10
HOM-GFI – 2-Pole	15-50*	#12 - 4	#14 - 6

## GFCI Breakers and Application Info

- UL Listed
- 10k AIR
- HOME250SPA Value Pack (see page 57)



HOM120GFI

HOM240GFI

- \* 15A to 30A circuit breakers are suitable for use with 60°C or 75°C conductors. 40A to 125A circuit breakers are suitable for use with 75°C conductors.
- ▲ 15A to 20A tandem or quad tandem circuit breakers are suitable for use with 60°C or 75°C conductors. 25A to 50A tandem or quad tandem circuit breakers are suitable for use with 75°C conductor only.
- † Item may require additional lead time.

# Homeline Circuit Breakers – Dual Function

Save time and money with combined Combination Arc Fault Protection and Ground Fault Protection in one device.

The innovative Square D Homeline Dual Function Circuit Breaker saves space and installation time while meeting prevailing National Electric Code® requirements. Available in both standard Pigtail and time-saving Plug-on Neutral configurations, these circuit breakers combine two state-of-the-art technologies; Combination Arc Fault and Ground Fault protection, in a single, easy-to-install device. The Dual Function Circuit Breaker offers superior electrical safety for homeowners.

Dual Function Circuit Breakers				
	Pigtail Neutral		Plug-On Neutral	
Amps	1-Pole Catalog #	UPC Code	1-Pole Catalog #	UPC Code
15	HOM115DFC	7-85901-98601-0	HOM115PDFC	7-85901-97869-5
20	HOM120DFC	7-85901-98341-5	HOM120PDFC	7-85901-98702-4

## Dual Function Breakers

- UL Listed, CSA Approved
- 120 VAC
- 15-20 A current rating
- Interrupt Ratings: HOM – 10 kA
- DF: Purple Reset Button



HOM120DF

HOM120PDF

# Homeline Circuit Breakers – Plug-on Neutral (PoN)

## Engineered for a quick Plug-on Neutral connection on every circuit.

Homeline Plug-on Neutral (PoN) Load Centers are designed to reduce installation time of CAFI and Dual Function Circuit Breakers. Installing Plug-on Neutral Circuit Breakers eliminates the pigtail connection, clearing the wire gutter and speeding up the job. The mounting rail of plug-on neutral load center is engineered with a plated neutral bar that accepts all Homeline Circuit Breakers and is similar to the thermoplastic rail of standard Homeline load centers, but allows for the Plug-on Neutral Circuit Breakers to be connected on any circuit. A comprehensive selection of Plug-on Neutral Load Centers are available to meet your specific needs.

### Single phase only

- 100 and 200 amps Main breaker 125, 200 and 225A main lug devices available
- 24, 30, 42, 54 and 60 full-size spaces/circuits
- Use standard Homeline flush or surface mount covers
- Accepts both Homeline PoN and pigtail CAFI Circuit Breakers, and all Homeline Circuit Breakers and accessories
- The Homeline Plug-on Neutral Load Center offers are additions to the standard Homeline offer

## The Homeline Plug-on Neutral Advantage

- The Homeline Plug-on Neutral Load Center interior is engineered for a quick Plug-on Neutral connection on every circuit.
- Features an innovative connector jaw that is integral to the Plug-on Neutral Circuit Breaker, eliminating the neutral wire, pigtail connection providing cleaner gutter space
- Straight-in wiring and uniform termination lugs help minimize cable bends, reducing waste and minimizing installation time
- Standard 22kA/10kA series short circuit current rating on main breaker load centers provides increased application capabilities
- Backed Out Neutral Screws save labor and installation time
- Features all of the Homeline Load Center benefits, now available with a quick Plug-on Neutral connection.

## TIME SAVER Diagnostics

### Troubleshoot Circuit Issues

Eliminate the guesswork with TIME SAVER Diagnostics to identify the type of fault that last occurred.

The TIME SAVER Diagnostics sequence is simple and easy to use and requires no tools or special training.

**Step 1:** Simply turn off the circuit breaker

**Step 2:** Hold down the Push-To-Test button.

**Step 3:** Turn the circuit breaker back on.

- If** the circuit breaker trips immediately, it is detecting a Fault to Ground.
- If** the circuit breaker trips after a 2 second delay, it is detecting an Arc Fault.
- If** the circuit breaker trips after a 5 second delay, it is a thermal overload or short circuit.

In any of these instances, it is an indication that there is an issue ON the circuit and NOT with the circuit breaker itself. (If there is no issue on the circuit to be diagnosed, tripping after a five second delay would also be a normal breaker testing operation.)





# Homeline Load Centers

## Engineered for value

Homeline Plug-on Neutral Load Centers are designed for fast installation, reliability, and superior circuit protection. With industry leading innovations and exclusive features, Square D Homeline Load Centers are the smart, safe, reliable choice.

Engineered for value, Homeline Plug-on Neutral Load Centers offer time-savings for Plug-on Neutral Combination Arc Fault (CAFI) and Dual Function Circuit Breaker installation. Our innovative, split neutrals are designed to save you time and wire, allowing Plug-on Neutral Circuit Breakers to connect directly to the neutral bar without the pigtail. Coupled with the state-of-the-art design, our neutral bars are now fully-distributed, accepting Plug-on Neutral Circuit Breakers on any space.

### The Homeline Plug-on Neutral Advantage:

- Faster installation – Fewer connections
- Saves wire – Fully distributed split neutral bar\*
- Plug-on Neutral design available, saving you money with quicker installation times\*\*
- Easier troubleshooting – TIME SAVER Diagnostics provide additional circuit information at the touch of a button
- Faster and easier wiring – All spaces accept tandems

\* Patent applied

#### \*\* The Plug-on Neutral Advantage:

- Faster installation – Fewer connections
- Saves wire – Fully distributed split neutral bar
- Frees gutter space – No pigtails
- Faster and easier wiring – All spaces accept tandems



Homeline load centers are the best in class. Designed exclusively for the residential market, Homeline products offer everything you need to distribute electricity throughout your home. Homeline offers the same quality as the QO line with only slight modifications that are tailored to the residential market.

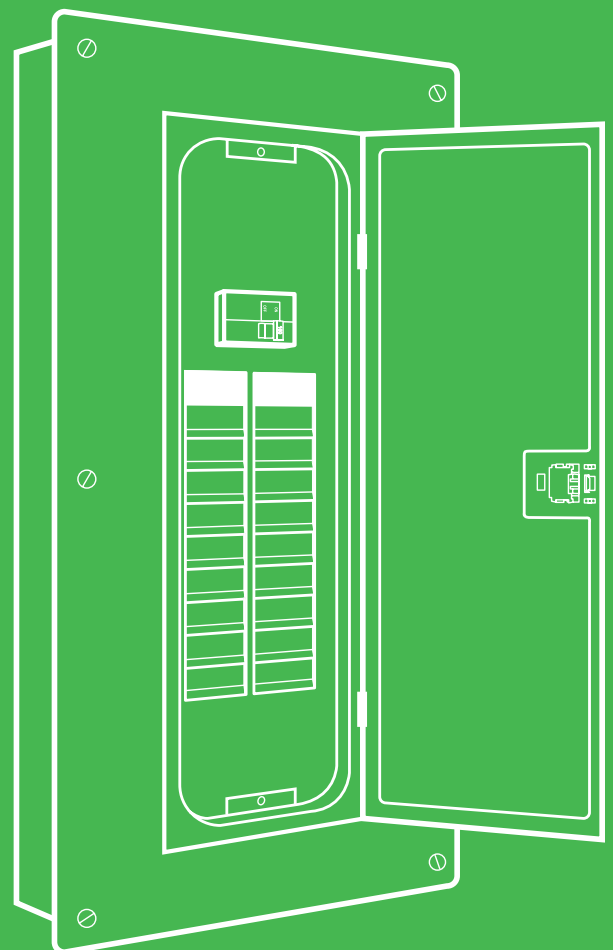

# Homeline Load Centers – Main Breaker

Amps	Spaces	Max. Circuits	Cover	Catalog #	Ground Bar	UPC Code	Box Size
<b>Indoor – QOM1 Main Breaker Frame Size</b>							
100	8	16	Combination	HOM816M100PC	PK9GTA	7-85901-97401-7	5
	12	24	Combination	HOM1224M100PC	PK15GTA	7-85901-86354-0	6
	20	40	Combination	HOM2040M100PC	PK18GTA	7-85901-97737-7	7
	24	48	Combination	HOM2448M100PC	PK23GTA	7-85901-97713-1	8
	30	60	Combination	HOM3060M100PC	PK23GTA	7-85901-97714-8	10
125	24	48	Combination	HOM2448M125PC	PK23GTA	7-85901-97715-5	8
	30	60	Combination	HOM3060M125PC	PK23GTA	7-85901-97746-9	10
<b>Indoor – QOM2 Main Breaker Frame Size</b>							
150	30	60	Combination	HOM3060M150PC	PK23GTA	7-85901-97769-8	10
200	20	40	Combination	HOM2040M200PC	PK18GTA	7-85901-97728-5	9
	30	60	Combination	HOM3060M200PC	PK23GTA	7-85901-97775-9	10
	40	80	Combination	HOM4080M200PC	PK27GTA	7-85901-97757-5	12
	42	84	Combination	HOM4284M200PC	PK27GTA	7-85901-97438-3	12
	60	120	Combination	HOM60120M200PC	PK27GTA	7-85901-97405-5	25
225	42	84	Combination	HOM4284M225PC	PK27GTA	7-85901-97627-1	12
<b>Outdoor – QOM1 Main Breaker Frame Size</b>							
100	8	16	Rainproof	HOM816M100PRB	PK9GTA	7-85901-97402-4	3R
	12	24	Rainproof	HOM1224M100PRB	PK15GTA	7-85901-86119-5	3R
	20	40	Rainproof	HOM2040M100PRB	PK18GTA	7-85901-97732-2	4R
125	8	16	Rainproof	HOM816M125PRB	PK9GTA	7-85901-97425-3	3R
	24	48	Rainproof	HOM2448M125PRB	PK23GTA	7-85901-97726-1	6R
<b>Outdoor – QOM2 Main Breaker Frame Size</b>							
150	30	60	Rainproof	HOM3060M150PRB	PK23GTA	7-85901-97773-5	7R
200	12	12	Rainproof	HOM12M200PRB	PK9GTA	7-85901-86106-5	5R
	20	40	Rainproof	HOM2040M200PRB	PK18GTA	7-85901-97718-6	6R
	30	60	Rainproof	HOM3060M200PRB	PK23GTA	7-85901-97807-7	7R
	40	80	Rainproof	HOM4080M200PRB	PK27GTA	7-85901-97752-0	14R
<b>Outdoor – Feed Thru (ideal for mobile homes and farm applications)</b>							
150	8	16	Rainproof	HOM816M150PFTRB	PK15GTA	7-85901-97404-8	6R
200	8	16	Rainproof	HOM816M200PFTRB	PK15GTA	7-85901-97395-9	6R

## Main Circuit Breakers

- UL Listed
- Single-Phase, 3-Wire
- 120/240 Vac
- 22k AIR♦
- Cover Included
- Factory Installed Main Breaker

♦ 22k AIR main circuit breaker UL Listed for use ahead of HOM and HOMET 10,000 AIR branch breakers to permit their application systems with up to 22,000A available fault current.



HOM816M150PFTRB



HOM1224M100PC



HOM2040M100PRB



HOM4080M200PC

# Homeline Load Centers – Main Lugs

Amps	Spaces	Max. Circuits	Cover	Catalog #	Ground Bar	UPC Code	Box Size
<b>Indoor- Factory Installed Fixed Main Lugs</b>							
70	2	4	Flush	HOM24L70FCP	PK3GTA1	0-47569-07121-8	2
70	2	4	Surface	HOM24L70SCP	PK3GTA1	0-47569-07120-1	2
100	6	12	Flush	HOM612L100FCP	PK7GTA	0-47569-07124-9	4
100	6	12	Surface	HOM612L100SCP	PK7GTA	0-47569-07123-2	4
125	4	8	Combination	HOM48L125GC	PK7GTA Factory-included	7-85901-48436-3	21
<b>Indoor- QOM1 Main Frame Size – Plug-on Neutral</b>							
125	8	16	Combination	HOM816L125PC	PK9GTA	7-85901-97345-4	6
	12	24	Combination	HOM1224L125PC	PK15GTA	7-85901-87612-0	6
	16	32	Combination	HOM1632L125PC	PK15GTA	7-85901-85002-1	8
	20	40	Combination	HOM2040L125PC	PK18GTA	7-85901-86069-3	8
	30	60	Combination	HOM3060L125PC	PK23GTA	7-85901-97719-3	10
	8	16	Combination	HOM816L125PGC	PK15GTAL – Included	7-85901-97345-4	6
	12	24	Combination	HOM1224L125PGC	PK15GTAL – Included	7-85901-87612-0	6
	20	40	Combination	HOM2040L125PGC	PK15GTAL – Included	7-85901-84852-3	8
	24	48	Combination	HOM2448L125PGC	PK15GTAL – Included	7-85901-97710-0	8
<b>Indoor- QOM2 Main Frame Size – Plug-on Neutral</b>							
225	30	60	Combination	HOM3060L225PC	PK23GTA	7-85901-97720-9	10
	40	80	Combination	HOM4080L225PC	PK27GTA	7-85901-97814-5	12
	42	84	Combination	HOM4284L225PC	PK27GTA	7-85901-97435-2	12
	60	120	Combination	HOM60120L225PC	PK27GTA	7-85901-97431-4	25
	30	60	Combination	HOM3060L225PGC	PK15GTAL & PK15GTA – Included	7-85901-97722-3	10
	16	32	Combination	HOM1632L225PGC	PK15GTAL – Included	7-85901-86097-6	9
	20	40	Combination	HOM2040L225PGC	PK15GTAL – Included	7-85901-86112-6	9
	40	80	Combination	HOM4080L225PGC	PK15GTAL & PK15GTA – Included	7-85901-97817-6	12
	42	84	Combination	HOM4284L225PGC	PK15GTAL & PK15GTA – Included	7-85901-97436-9	12
<b>Outdoor- Factory Installed Fixed Main Lugs</b>							
70	2	4	Rainproof	HOM24L70RBCP	PK4GTA	0-47569-07122-5	1R
100	6	12	Rainproof	HOM612L100RBCP	PK7GTA	0-47569-07125-6	2R
125	4	8	Rainproof	HOM48L125GRB	PK7GTA Factory-included	7-85901-48437-0	15R
<b>Outdoor- QOM1 Main Frame Size – Plug-on Neutral</b>							
125	8	16	Rainproof	HOM816L125PRB	PK9GTA	7-85901-97399-7	3R
	12	24	Rainproof	HOM1224L125PRB	PK15GTA	7-85901-86367-0	3R
	20	40	Rainproof	HOM2040L125PRB	PK18GTA	7-85901-84755-7	4R
	24	48	Rainproof	HOM2448L125PRB	PK23GTA	7-85901-97711-7	6R
<b>Outdoor- QOM2 Main Frame Size – Plug-on Neutral</b>							
225	12	12	Rainproof	HOM12L225PRB	PK9GTA	7-85901-86110-2	5R
	16	32	Rainproof	HOM1632L225PRB	PK15GTA	7-85901-86087-7	6R
	20	40	Rainproof	HOM2040L225PRB	PK18GTA	7-85901-97738-4	6R
	30	60	Rainproof	HOM3060L225PRB	PK23GTA	7-85901-97749-0	7R
	40	80	Rainproof	HOM4080L225PRB	PK27GTA	7-85901-97777-3	14R
	42	84	Rainproof	HOM4284L225PRB	PK27GTA	7-85901-97437-6	14R



HOM1224L125PC

### Main Lugs

- UL Listed
- Single-Phase, 3-Wire
- 120/240 Vac
- 10k AIR
- Factory Installed Main Lugs
- Cover Included

# Homeline Load Centers – Main Wire Sizes

Main Breaker Load Centers	
Catalog Number	Main Wire Size
<b>Indoor</b>	
HOM816M100PC	#6 - 1
HOM1224M100PC	#6 - 2/0
HOM2040M100PC	#6 - 1
HOM2448M100PC	#6 - 2/0
HOM3060M100PC	#6 - 2/0
HOM2448M125PC	#6 - 2/0
HOM3060M125PC	#6 - 2/0
HOM3060M150PC	#4 - 250
HOM2040M200PC	#4 - 250
HOM3060M200PC	#4 - 250
HOM4080M200PC	#4 - 250
HOM4284M200PC	#4 - 250
HOM60120M200C	#4 - 250
HOM4284M225PC	#4 - 300
<b>Outdoor</b>	
HOM816M100PRB	#6 - 2/0
HOM1224M100PRB	#6 - 2/0
HOM2040M100PRB	#6 - 2/0
HOM816M125PRB	#6 - 2/0
HOM2448M125PRB	#6 - 2/0
HOM3060M150PRB	#4 - 250
HOM12M200PRB	#4 - 250
HOM2040M200PRB	#4 - 250
HOM3060M200PRB	#4 - 250
HOM4080M200PRB	#4 - 250
<b>Feed Thru</b>	
HOM816M150PFTRB	#4 - 250
HOM816M200PFTRB	#4 - 250

Main Lugs Load Centers	
Catalog Number	Main Wire Sizes
<b>Indoor</b>	
HOM24L70F/S	#12 - 3
HOM612L100F/S	#8 - 1
HOM48L125GC	#12 - 2/0
HOM816L125PC	#6 - 2/0
HOM1224L125PC	#6 - 2/0
HOM1632L125PC	#6 - 2/0
HOM2040L125PC	#6 - 2/0
HOM3060L125PC	#6 - 2/0
HOM816L125PGC	#4 - 300
HOM1224L125PGC	#4 - 300
HOM2040L125PGC	#4 - 300
HOM2448L125PGC	#4 - 300
HOM3060L225PC	#6 - 2/0
HOM4080L225PC	#6 - 2/0
HOM4284L225PC	#6 - 2/0
HOM60120L225PC	#6 - 2/0
HOM3060L225PGC	#4 - 300
HOM1632L225PGC	#4 - 300
HOM2040L225PGC	#4 - 300
HOM4080L225PGC	#4 - 300
HOM4284L225PGC	#4 - 300
<b>Outdoor</b>	
HOM24L70RB	#12 - 3
HOM612L100RB	#8 - 1
HOM48L125GRB	#12 - 2/0
HOM816L125PRB	#6 - 2/0
HOM1224L125PRB	#6 - 2/0
HOM2040L125PRB	#6 - 2/0
HOM2448L125PRB	#6 - 2/0
HOM12L225PRB	#4 - 300
HOM1632L225PRB	#4 - 300
HOM2040L225PRB	#4 - 300
HOM3060L225PRB	#4 - 300
HOM4080L225PRB	#4 - 300
HOM4284L225PRB	#4 - 300

# Homeline Load Centers – Wiring Diagrams

## 1-Phase, 3-Wire Main Breakers

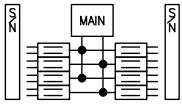

HOM816M100PRB  
HOM816M125PRB

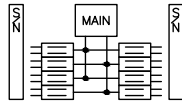

HOM816M100PC

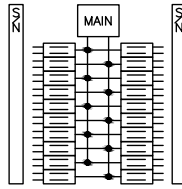

HOM2040M100PC

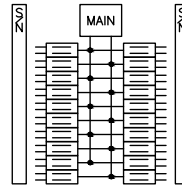

HOM2040M100PRB

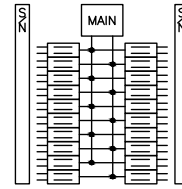

HOM2040M200PC

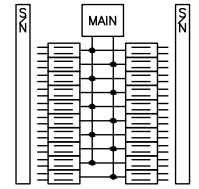

HOM2040M200PRB

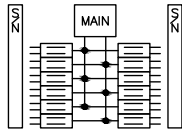

HOM1224M100PC

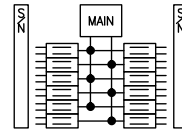

HOM1224M100PRB

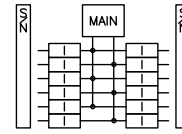

HOM12M200PRB

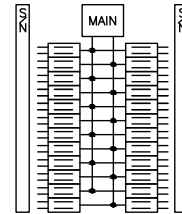

HOM2448M125PRB

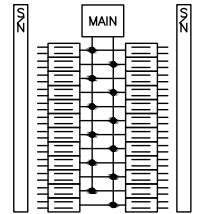

HOM2448M100PC  
HOM2448M125PC

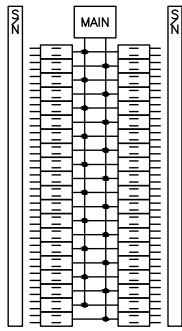

HOM4080M200PC

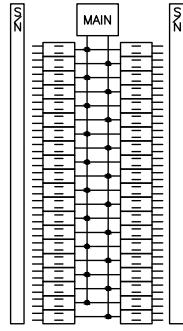

HOM4080M200PRB

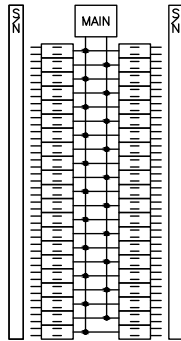

HOM4284M200PC  
HOM4284M225PC

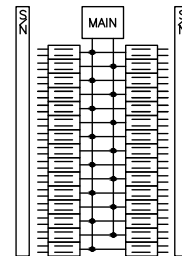

HOM3060M150PRB  
HOM3060M200PRB

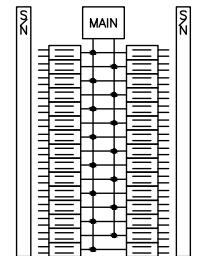

HOM3060M100PC  
HOM3060M125PC  
HOM3060M150PC  
HOM3060M200PC

## 1-Phase, 3-Wire Main Lugs

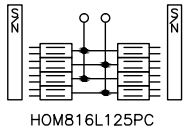

HOM816L125PC

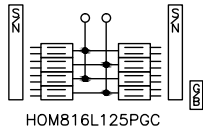

HOM816L125PGC

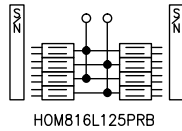

HOM816L125PRB

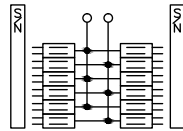

HOM1224L125PC

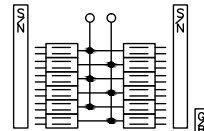

HOM1224L125PGC

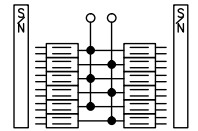

HOM1224L125PRB

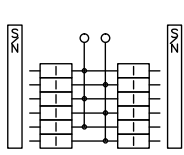

HOM12L225PRB

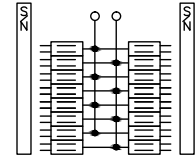

HOM1632L125PC

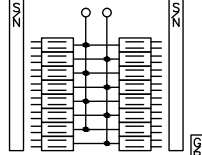

HOM1632L225PGC

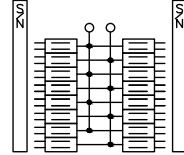

HOM1632L225PRB

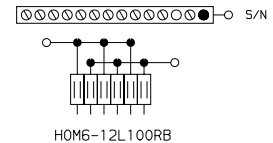

HOM6-12L100RB

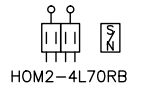

HOM2-4L70RB

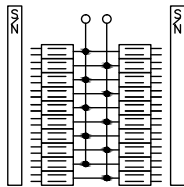

HOM2040L125PC

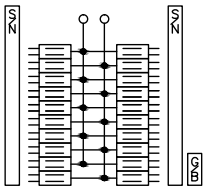

HOM2040L125PGC

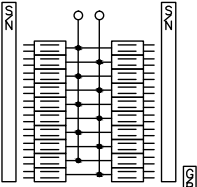

HOM2040L225PGC

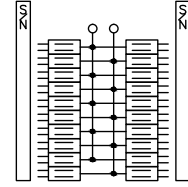

HOM2040L225PRB

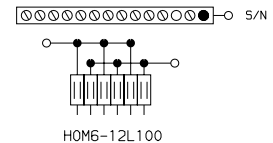

HOM6-12L100

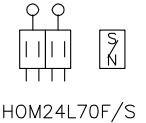

HOM24L70F/S

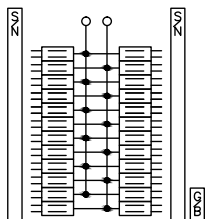

HOM2448L125PGC

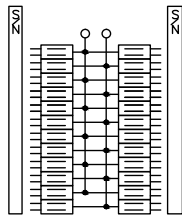

HOM2448L125PRB

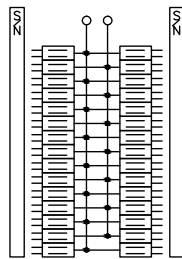

HOM3060L125PC  
HOM3060L225PC

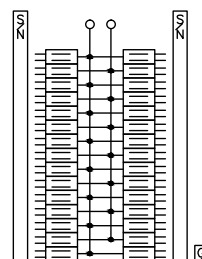

HOM3060L225PGC

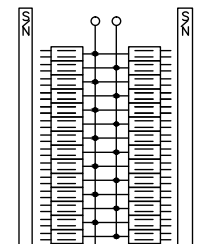

HOM3060L225PRB

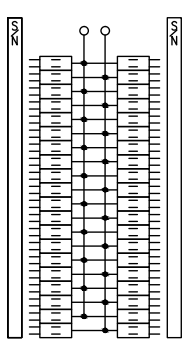

HOM4080L225PC

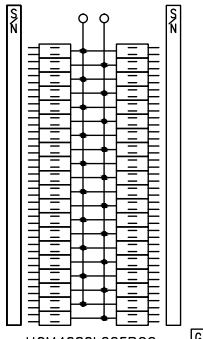

HOM4080L225PGC

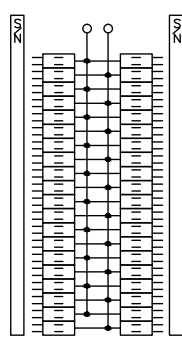

HOM4080L225PRB

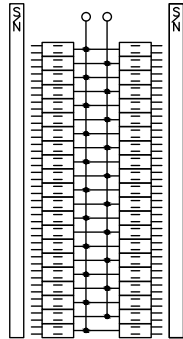

HOM4284L225PC

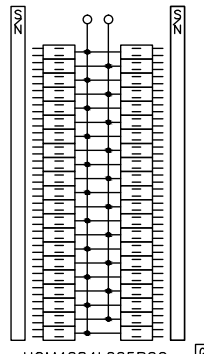

HOM4284L225PGC

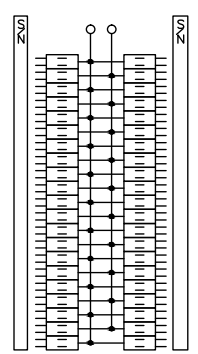

HOM4284L225PRB

# Understanding the Square D Offer

## Two configurations of load centers:

- **Main Breaker Type** – includes a factory installed main breaker, which manually disconnects all electrical service to the load center and automatically protects the load center main bus bar from short circuits and overloads.
- **Main Lugs Type** – does not include a factory installed main breaker. This type is used when the load center is protected by a separate and upstream overcurrent device such as a circuit breaker or fusible safety switch.

## The Interior of the Load Centers consists of:

- **Main Breaker (or Main Lugs)** – connects and distributes incoming electrical power to the bus bars
- **Main Bus Bar** – conducts electrical current to the attached branch circuit breakers
- **Ground Bar** – provides connections for the equipment grounding wires
- **Branch Circuit Breakers** – attach to bus bars and provide the necessary protection for downstream electrical loads
- **Neutral** – provides connections for branch neutral wires

## More Features: (Both QO and Homeline Products)

- **Fully Convertible** – Load centers can convert from main breaker to main lug and main lug to main breaker which provides on-site flexibility for changing job-site requirements.
- **Main Lug** – Factory-included ground bar in all 12 circuit and higher QO load centers. Homeline main lug load centers are available with factory-installed ground bars on select catalog numbers. Three locations to install to meet customer requirements in the field.
- **Branch Wiring** – Now included on QO as standard, three neutral terminations suitable for up to 1/0 wire. Provides economical, convenient and fast branch wiring for high current circuits with no extra lugs to purchase. Available on QO load centers 12 circuits and higher.
- **Top or Bottom Feed** – Top or bottom feed without modification simplifies installation and meets all job-site applications.
- **Cover** – It is identified according to surface or flush mounting. The cover and the box together are known as the enclosure.

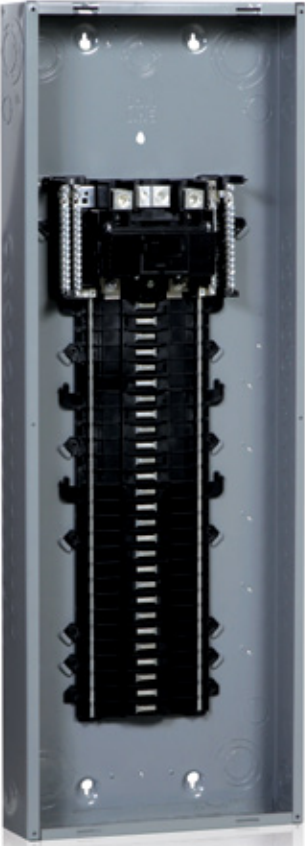

# QO vs. Homeline

QO Load center		Homeline Load center
 <p>QO ¾" breakers feature Visi-Trip trip to center position</p>	<p><b>UL Listed Only for Square D Breakers</b></p>	<p>Homeline 1" breakers trip to center position</p>
<p>PON breakers installed on any space in select LCs</p>	<p><b>Accepts Plug-on Neutral CAFIs</b></p>	<p>PON breakers installed on any space</p>
<p>Top and split neutral plus (3) #1 AWG terminals</p>	<p><b>Backed-out Neutral Terminal Screws</b></p>	<p>Fully distributed split neutral</p>
<p>Tin-plated copper</p>	<p><b>Bus Bars</b></p>	<p>Tin &amp; copper plated aluminum</p>
<p>Shielded</p>	<p><b>Bus Bars</b></p>	<p>Not shielded</p>
<p>¾ inch per 1 Pole space 40 spaces/circuit = 33¼ in. tall</p>	<p><b>Breaker Format</b></p>	<p>1 inch per 1 Pole space 40 spaces/circuit = 39½ in. tall</p>
<p>Option for surface or flush covers that ship separately, or a combo cover (in carton) shipped with load center</p>	<p><b>Cover Options</b></p>	<p>Option for surface or flush covers that ship separately, or a combo cover (in carton) shipped with load center</p>
<p>Lifetime Limited</p>	<p><b>Warranty</b></p>	<p>10 year</p>

# CSED – Meter Mains, All-In-Ones & Meter Sockets

## Combination Service Entrance Devices (CSED)

### The Best Electrical Service Starts at the Meter Socket

Square D products offer the broadest, most complete line of combination service entrance devices (CSED) because electrical service for the home starts right at the meter socket.

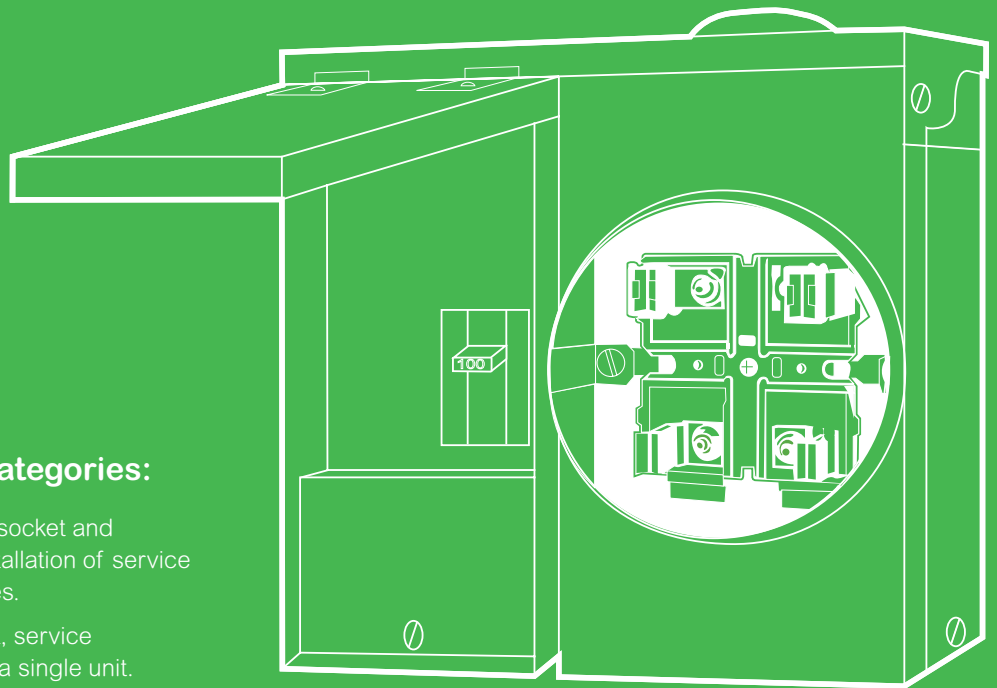

### CSED products fall into two categories:

- Meter mains that include the utility meter socket and factory installed or provisions for field installation of service disconnect(s) to feed downstream devices.
- All-in-ones include the utility meter socket, service disconnect(s) and integral load center in a single unit.



Our CSED line provides unsurpassed electrical protection, time and money-saving installation features and world-class quality that made Square D products famous.

# CSED – Catalog Number Guide

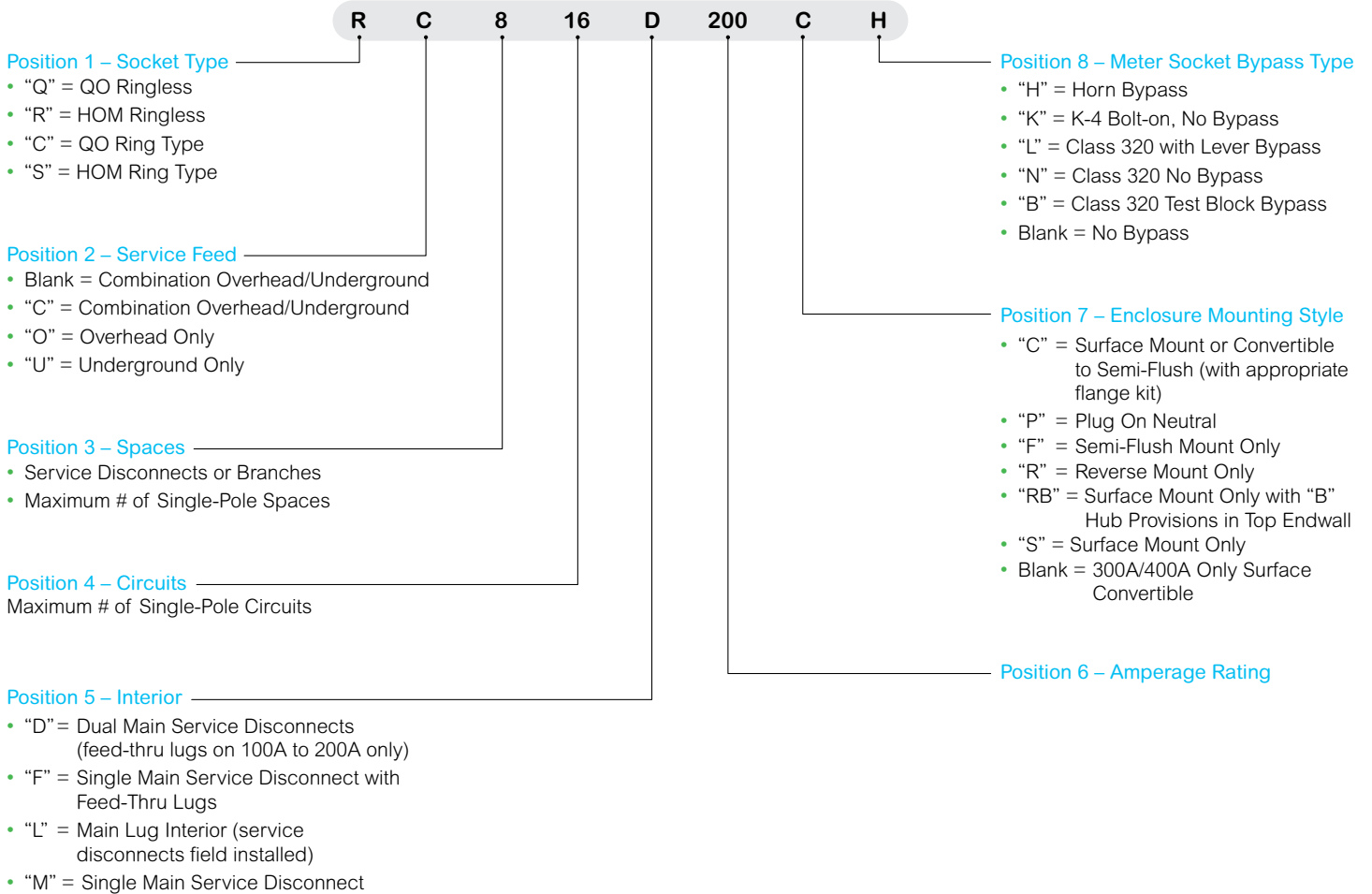

# CSED – Meter Mains

Ring Type Meter Mains – Surface Mount (except as noted)								
Amp Rating	Service Feed	Hub Style <sup>o</sup>	Service Disconnect		Branch Breaker		Catalog #	UPC-A
			Type	Max Amps	Spaces	Circuits		
100	OH/UG	B	QOM100▲■	125	0	0	CQRB100CP▶	0-47569-04402-1
125	OH/UG	B	QOM1-VH	125	0	0	C125RB▶	Special Order
	OH/UG	A	(4) HOM (2-Pole only)	(1) 125● (3) 100	0	0	SC8L125S▶	7-85901-30880-5
	OH/UG	A or B300	(4) HOM (2-Pole only)	110	0	0	SC8L125F▶	7-85901-11148-1
150	OH/UG	A or A-L	(1) HOM2150■	150	(8) HOM	(16) HOM	SC816D150C◆◊▶▶	7-85901-85915-4
			(1) HOM (2-Pole only)	50				
200	OH/UG	A	QOM2200VH■	200	0	0	CQRA200◆▶▶	0-47569-29180-7
			QOM2-VH	200	0	0	CM200S	7-85901-29176-3
	A-L	(6) HOM (2-Pole only)	200	0	0	SC12L200S▶▶	7-85901-37730-6	
	OH/UG	A-L	(6) HOM (2-Pole only)	200	0	0	SC12L200F▶▶	Special Order
	OH/UG	A or A-L	(1) HOM2200■ (1) HOM (2-Pole only)	200 50	(8) HOM	(16) HOM	SC816D200C◆◊▶	7-85901-85916-1
400	UG	A-L	(1)QDL22200■	200	0	0	CU12L400CN	Special Order
			(1) QDL, QGL, QJL	200				
			(4) QOH	125				
			(1) QDL22200■	200	0	0	CU12L400CB★▼▶▶	7-85901-48666-4
			(1) QDL, QGL, QJL	200				
(4) QOH	125							



CQRB100



SC816D200C

### Combination Service Entrance Devices (CSED)

- UL Listed
- Single-Phase, 3-Wire
- 120/240 Vac
- NEMA Type 3R Enclosure
- Suitable Only for Use as Service Equipment

- ▲ Order Type QOM1-VH replacement circuit breaker (10k).
- Order Type QOM2-VH replacement circuit breaker.
- Service Disconnect Supplied Factory Installed.
- ◆ Consumer product only (same as C200RB).
- \* For use only on 120/240 Vac, Single-Phase, 3-Wire system.
- ▼ Knockout provided in cover for use with Barrel Lock Kit, order catalog number SCBRLOCK (see Accessories page).
- 125A Homeline double-pole circuit breaker can be installed in top position only. All other positions are limited to 100A max.
- ◻ Suitable for OH service with addition of Tunnel Kit (SCTKP20). Order separately.
- ◊ Supplied with load side feed thru lugs for #6 AWG-250 kc mil (Al/Cu) conductors.
- ☆ Convertible to semi-flush with SC200F flange kit (order separately).
- ▶ 10k short circuit current rating.
- ▶▶ 22k short circuit current rating or UL short circuit current rating is equal to the lowest interrupting rating of any circuit breaker installed.
- ★ Item may require additional lead time.

# CSED – Meter Mains

Ringless Type Meter Mains – Surface Mount (except as noted)								
Amp Rating	Service Feed	Hub Style	Service Disconnect		Branch Breaker		Catalog #	UPC-A
			Type	Max Amps	Spaces	Circuits		
100	OH/UG	A	QOM2100VH	100	(8) QO	(16) QO	QC816F100CH	Special Order
			QOM2100VH	100	(8) HOM	(16) HOM	RC816F100CH	7-85901-40182-7
125	OH/UG	A	QOM2125VH	125	(8) QO	(16) QO	QC816F125C	7-85901-39097-8
			QOM2125VH	125	(8) QO	(16) QO	QC816F125CH	7-85901-40181-0
			QOM2125VH	125	(8) HOM	(16) HOM	RC816F125CH	7-85901-40183-4
			(4) HOM (2-Pole only)	125 <sup>Δ</sup>	0	0	RC8L125S	7-85901-30883-6
150	OH/UG	A	QOM2150VH	150	(8) HOM	(16) HOM	RC816F150C	7-85901-85919-2
			QOM2150VH	150	(8) HOM	(16) HOM	RC816F150CH	7-85901-86394-6
			QOM2150VH	150	(8) QO	(16) QO	QC816F150C	7-85901-00105-8
			QOM2150VH	150	(8) HOM	(16) HOM	RC816F150S	7-85901-94650-2
			(6) HOM (2-Pole only)	200	0	0	RC12L200C	7-85901-86398-4
200	OH/UG	A	QOM2200VH	200	(8) HOM	(16) HOM	RC816F200C	7-85901-86392-2
			QOM2200VH	200	(8) HOM	(16) HOM	RC816F200CH	7-85901-86396-0
			(1) HOM2200	200	(8) HOM	(16) HOM	RC816D200CH	7-85901-86397-7
		A or B300	(1) HOM (2-Pole only)	50	0	0		
			QOM2-VH	200	0	0	RC200S	7-85901-39318-4
			QOM2-VH	200	0	0	RC2M200S	7-85901-39669-7
			QO-VH	50	0	0		
			(6) QO-VH (2-Pole only)	200	0	0	QC12L200C	7-85901-00112-6
			QOM2200VH	200	(8) QO	(16) QO	QC816F200C	7-85901-00106-5
			QOM2200VH	200	(8) QO	(16) QO	QC816F200CH	7-85901-00108-9
QOM2200VH	200	(8) HOM	(16) HOM	RC816F200S	7-85901-94654-0			



QC816F150C

## Combination Service Entrance Devices (CSED)

- UL Listed
- Single-Phase, 3-Wire
- 120/240 Vac
- NEMA Type 3R Enclosure
- Suitable Only for Use as Service Equipment

- ▲ Order Type QOM1-VH replacement circuit breaker (10k).
- Service disconnect supplied factory installed.
- ▼ Knockout provided in cover for use with Barrel Lock Kit, order catalog number SCBRLLOCK (see accessories page).
- ▲ 125A Homeline double-pole circuit breaker can be installed in top position only. All other positions are limited to 100A max.
- ◇ Supplied with load side feed thru lugs for #6 AWG-250 kc mil (Al/Cu) conductors.
- ☆ Convertible to semi-flush with SC200F flange kit (order separately).
- ▶ Device supplied with barrel lock provisions factory installed.
- Supplied with horn bypass and fifth jaw factory installed.
- 10k short circuit current rating.
- ★ 22k short circuit current rating.
- + Item may require additional lead time.

# CSED – All-In-Ones

Ring Type All-In-Ones – Surface Mount (except as noted)								
Amp Rating	Service Feed	Hub Style	Service Disconnect		Branch Breaker		Catalog #	UPC-A
			Type	Max Amps	Spaces	Circuits		
100	OH/UG	A	HOM2100	100	(16) HOM	(24) HOM	SC1624M100S <sup>1</sup>	7-85901-30881-2
	OH/UG	A or B300	HOM2100	100	(16) HOM	(24) HOM	SC1624M100F <sup>1</sup>	7-85901-10779-8
	OH <sup>♦</sup>	A	HOM2100	100	(10) HOM	(20) HOM	SO1020M100S <sup>1</sup>	7-85901-32804-9
125	OH/UG	A	HOM2125	125	(16) HOM	(24) HOM	SC1624M125S <sup>1</sup>	7-85901-30882-9
	OH/UG	A or B300	HOM2125	125	(16) HOM	(24) HOM	SC1624M125F <sup>1</sup>	7-85901-10780-4
200	OH/UG	A or A-L	HOM2200	200	(20) HOM	(40) HOM	SC2040M200C <sup>1*</sup>	7-85901-85909-3
	OH <sup>♦</sup>	A	QOM2200VH	200	(20) HOM	(40) HOM	SO2040M200S <sup>1*</sup>	7-85901-32803-2
	UG	A or B300	QOM2200VH	200	(30) HOM	(40) HOM	SU3040M200R <sup>1</sup>	7-85901-29190-9
225	UG	A or B300	QOM2225VH	225	(30) HOM	(40) HOM	SU3040M225R <sup>1</sup>	7-85901-75121-2
400	UG	A-L	QDL22200	200	(30) HOM	(40) HOM	SU3040D400CN <sup>1□</sup>	7-85901-49140-8
			QDL, QGL, QJL <sup>1○</sup>	200	0	0		
	UG	A-L	QDL22200	200	(30) HOM	(40) HOM	SU3040D400CB <sup>1□</sup>	7-85901-52179-2
			QDL, QGL, QJL <sup>1○</sup>	200	0	0		



SC1624M100F

### Combination Service Entrance Devices (CSED) – All-In-Ones

- UL Listed
- Single-Phase, 3-Wire
- 120/240 Vac
- Service Disconnect(s) Supplied Factory Installed
- Suitable Only for Use as Service Equipment

- ▲ Suitable for OH service with addition of tunnel kit (SCTKP20). Check with local utility for approval and order separately.
- \* Suitable for OH service with addition of tunnel kit (SCTKP30). Check with local utility for approval and order separately.
- Knockout provided in cover for use with barrel lock kit, order catalog number SCBRLLOCK (see accessories page).
- For use only on 120/240 Vac, Single-Phase, 3-Wire system (4-jaw meter socket).
- ! 10k short circuit current rating.
- ! 22k short circuit current rating.
- ✦ Convertible to semi-flush with SC200F flange kit (order separately).
- ✦ Item may require additional lead time.
- ♦ Device not EUSERC approved.
- UL short circuit current rating is equal to the lowest interrupting rating of any circuit breaker installed.
- Additional service disconnect for field-installation, order prefix QBL at 10kA, QDL at 25kA, QGL at 65kA or QJL at 100kA. Order separately.
- Supplied with load side feed-thru lugs, for 4AWG-250 kcmil Al/Cu conductors.
- <sup>[4]</sup> Accepts Solar Ready Kit Part Number SR69064A. Check with local utility for approval and order separately.

# CSED – All-In-Ones

Ringless Type All-In-Ones – Surface Mount (except as noted)								
Amp Rating	Service Feed	Hub Style	Service Disconnect		Branch Breaker		Catalog #	UPC-A
			Type	Max Amps	Spaces	Circuits		
100	OH/UG	A	HOM2100	100	16 (HOM)	24 (HOM)	RC1624M100S	7-85901-30884-3
125	OH/UG	A	HOM2125	125	16 (HOM)	24 (HOM)	RC1624M125S	7-85901-30885-0
	OH/UG	A	QO2125VH	125	20 (HOM)	40 (HOM)	RC2040M125CH	7-85901-00284-0
150	OH/UG	A	QO2150VH	150	20 (HOM)	40 (HOM)	RC2040M150CH	7-85901-87831-5
200	OH/UG	A	QOM2200VH	200	20 (HOM)	40 (HOM)	RC2040M200C	7-85901-19336-4
	OH/UG	A	QOM2200VH	200	20 (HOM)	40 (HOM)	RC2040M200CH	7-85901-84116-6
	OH/UG	A	QOM2200VH	200	24 (QO)	42 (QO)	QC2442M200C	7-85901-39668-0
	OH/UG	A	QOM2200VH	200	24 (QO)	42 (QO)	QC2442M200CH	7-85901-39678-9
400	UG	A-L	QDL22200	200	30 (HOM)	40 (HOM)	RU3040D400CL	7-85901-44543-2
			QDL, QGL, QJL	200	0	0		



RC2040M200C

## Combination Service Entrance Devices (CSED) All-In-Ones

- UL Listed
- Single-Phase, 3-Wire, 120/240 Vac
- NEMA Type 3R Enclosure
- Catalog Number Guide Below
- Service Disconnect(s) Supplied Factory Installed
- Suitable Only for Use as Service Equipment

- ▼ Additional service disconnect for field-installation, order prefix QBL at 10kA, QDL at 25kA, QGL at 65kA or QJL at 100kA. Order separately.
- ▶ Knockout provided in cover for use with barrel lock kit, order catalog number SCBRLOCK (see accessories page).
- ◇ Device not EUSERC approved.
- ☆ Device supplied with barrel lock provisions factory installed.
- Supplied with horn bypass and fifth jaw factory installed.
- ┆ 10k short circuit current rating.
- \* 22k short circuit current rating.
- + Item may require additional lead time.
- Service disconnect supplied factory-installed.
- Circuit breaker prefix QBL at 10k AIR may be used. For complete circuit breaker catalog number, see below.
- ▲ UL short circuit current rating is equal to the lowest interrupting rating of any circuit breaker installed.

# CSED – Solar Ready Plug-on Neutral

Main Breaker Ampere Rating	Bus Bar Ampere Rating	Bypass Type	Service (Type of Feed)	Short Circuit Current Rating	Cat. No. <sup>(4)</sup>	Service Disconnect(s)		Load Center and Branch Circuit Breakers (Order separately)				Hub Type (Order separately)	Line Side Main Lugs AWG/kcmil (Al/Cu)	Service Ground Lug AWG/kcmil (Al/Cu)
						Max. 2P Circuits	Type (Factory Installed)	Max. Quantity			Max. Ampere Rating			
								Spaces	Circuits	Tandems				
<b>All-In-One Combination Service Entrance Devices – Semiflush Mount Only</b>														
200 A	225 A	None	OH▲/UG	22 kA	SC816F200PF■	1	QOM2200VH	8	16	8	200 A	A-L	4-250	8-2/0
125 A		None	OH▲/UG	22 kA	SC2040M125PF	1	QOM2125VH	20	40	20	110 A			
200 A		None	OH▲/UG	22 kA	SC2040M200PF	1	QOM2200VH	20	40	20	200 A			
		None	OH★/UG	22 kA	SC3042M200PF	1	QOM2200VH	30	42	12	200 A			
225 A		None	OH★/UG	22 kA	SC3042M225PF	1	QOM2225VH	30	42	12	200 A			
<b>All-In-One Combination Service Entrance Devices – Surface Mount Only</b>														
150 A	200 A	None	OH/UG	22 kA	SC816F150PS■	1	QOM2150VH	8	16	8	150 A	A-L	4-250	8-2/0
200 A		None	OH/UG	22 kA	SC816F200PS■	1	QOM2200VH	8	16	8	200 A			
		None	OH/UG	22 kA	SC2040M200PS	1	QOM2200VH	20	40	20	200 A			
		None	OH/UG	22 kA	SC3042M200PS	1	QOM2200VH	30	42	12	200 A			
		None	OH/UG	22 kA	SC42M200PS	1	QOM2200VH	42	42	0	200 A			

▲ Suitable for OH service with addition of tunnel kit (SCTKP20). Check with local utility for approval and order separately.

★ Suitable for OH service with addition of tunnel kit (SCTKP30). Check with local utility for approval and order separately.

■ Supplied with load side feed-thru lugs, for 4AWG-250 kcmil Al/Cu conductors.

<sup>(4)</sup> Accepts Solar Ready Kit Part Number SR69064A. Check with local utility for approval and order separately.

## SC Solar Ready Combination

- Ring-type meter sockets
- UL Listed, suitable only for use as service equipment
- Service disconnect(s) are supplied factory-installed, except where noted
- Interiors accept plug-on neutral and pigtail style branch circuit breakers
- Supplied with a fully distributed neutral bar, all unused terminals may be used for equipment grounding wires
- Meets Federal Specification W-P-115c as Type 1, Class 2
- Solar Ready kit SR69064A, order from table 1.55
- All devices have a 3" KO in the bottom endwall
- Provisions for field installed CTs on All devices
- Meets EUSERC requirements



# CSED – Application Info

## Circuit Breakers & Accessories

Circuit Breakers for use with Meter Mains and All-In-One devices

Ampere Rating*	Type: HOM, 1P Cat. No.	Type: HOM, 2P Cat. No.	Type: QO, 1P Cat. No.	Type: QO, 2P Cat. No.	Type: QO-VH, 1P Cat. No.	Type: QO-VH, 2P Cat. No.	Type: QOM1-VH, 2P Cat. No.	Type: QOM2-VH, 2P Cat. No.	Type: QDL, 2P* Cat. No.
10	—	—	QO110	—	—	—	—	—	—
15	HOM115	—	QO115	—	QO155VH	—	—	—	—
20	HOM120	—	QO120	—	QO120VH	—	—	—	—
25	HOM125	—	QO125	—	QO125VH	—	—	—	—
30	HOM130	HOM230	QO130	QO230	QO130VH	QO230VH	—	—	—
35	—	HOM235	QO135	QO235	—	—	—	—	—
40	HOM140	HOM240	QO140	QO240	—	QO240VH	—	—	—
45	—	HOM245	QO145	QO245	—	—	—	—	—
50	HOM150	HOM250	QO150	QO250	—	QO250VH	QOM50VH <sup>o</sup>	—	—
60	—	HOM260	QO160	QO260	—	QO260VH	QOM60VH	—	—
70	—	HOM270	QO170	QO270	—	QO270VH	QOM70VH	—	QDL22070
80	—	HOM280	—	QO280	—	QO280VH	QOM80VH	—	QDL22080
90	—	HOM290	—	QO290	—	QO290VH	QOM90VH	—	QDL22090
100	—	HOM2100	—	QO2100	—	QO2100VH	QOM100VH	QOM2100VH	QDL22100
110	—	HOM2110	—	QO2110	—	QO2110VH	QOM110VH	—	QDL22110
125	—	HOM2125	—	QO2125	—	QO2125VH	QOM125VH	QOM2125VH	QDL22125
150	—	HOM2150BB	—	QO2150	—	QO2150VH	—	QOM2150VH	QDL22150
175	—	HOM2175BB	—	QO2175	—	QO2175VH	—	QOM2175VH	QDL22175
200	—	HOM2200BB	—	QO2200	—	QO2200VH	—	QOM2200VH	QDL22200
225	—	—	—	—	—	—	—	QOM2225VH	—

\* Do not exceed mains rating of device

<sup>o</sup> Reference National Electrical Code Article 230-79.

\* For additional interrupting rating circuit breakers, order circuit breaker prefix QBL at 10 kA, QGL at 65 kA or QJL at 100 kA.

## Accessories, Hubs and Closing Plates

Accessories	Cat. No.
Generator Kit: Interlocks main service disconnect and generator circuit breaker (order separately). For: • Homeline CSED Devices RC816F-, RC2040M-, SO2040M- • QO CSED Devices QC816F-, QC2442M-	RCGK2 QCGK3
Fifth Jaw kit for: Meter Main Types: C, RC, SC, QC/All-In-One Types: SC, SU (100-225 A), QC, RC, SO Bypass (Horn Type) for Ringless Type Meter Mains and All-In-One (100-200 A) (except for RC200S and RC2M200S)	5J
Lexan Meter Socket Cover Plate for: • Ring and Ringless Type Meter Mains • Ring and Ringless Type All-In-Ones	RCHB2
Meter Socket Sealing Rings for Ring Type Meter Mains and All-In-Ones : • Snap Type Aluminum (Std.) • Screw Type Aluminum • Snap Type Stainless Steel	29007
Anti-Inversion Kit . For use ONLY on 400 A Meter Mains and All-In-Ones with lever bypass.	2920910001
Trim Kit for 2 in. X 6 in. stud wall, used with Reverse All-In-Ones, SU3040M200R, and SU3040M225R	29008W
Barrel Lock Kit (Barrel Lock not included), supplied with bracket and mounting screw, refer to listings for where used.	ARP00026 MMLRK
Semiflush Flange Kit for: Meter Mains: SC816D150/200C and RC816D200CH/All-In-Ones: SC2040M200C	SU2X6TRIM
Semiflush Flange Kit for ring- and ringless-type Meter Mains and All-In-Ones (400 A Only)	SCBRLOCK
Ringless Type Utility Cover for RU3040D400CL/FL, QU12L400CL/FL, and QU816D400CL/FL. Includes one piece meter socket and pull box cover with handles and closing plate.	SC200F
Lug Kit includes (4) lugs, for use with 2 AWG–600 kcmil Al/Cu conductors. Lugs are for standard 2-Hole mounting. Meter Main and All-In-One units supplied with (2) studs per phase and neutral will accept one lug per phase and neutral. Not for use on 400 A devices with "K" suffix.	FK400
Overhead Feed Trough for 400 A ring- and ringless-type Meter Mains and All-In-Ones. • 3 in. Conduit Adapter Kit for 400 A ring- and ringless-type Meter Mains and All-In-Ones. • Touch-Up Paint (ASA49 Gray)	R400L
Filler Plate for: Meter Main Types: QC, CU/All-In-One Types: QC	CMELK4
Filler Plate for: Meter Main Types: RC, SC/All-In-One Types: SC, RC, SU	OCK400
Neutral Lug (6-2/0 AWG) for: Meter Main Types: RC, SC, QC/All-In-One Types: SC, SU, QC, RC	SU400PVCHA3
Solar Ready Lug Kit	PK49SP
OH tunnel kit for SC12L200F, SC816F200PF, SC2040M125PF and SC2040M200PF	PK15FTA
OH tunnel kit for SC3042M200PF and SC3042M225PF	QOFP
Overhead Barrier Tunnel Kit for ringless and horn bypass in RC/QC devices	HOMFP
Overhead Barrier Tunnel Kit for lever bypass RC/QC devices	LK100AN
	SR69064A
	SCTPK20
	SCTKP30
	OHBS
	OHBL

Hubs and Closing Plates		
Hub Series	Conduit Size (inches)	Cat. No.
A	Closing Plate for "A" Hub opening	
	1.00	ACP
	1.25	A100
	1.50	A125
	2.00	A150
A-L	2.50	A200
	Adapter plate to allow use of "A" Hubs on "A-L" size hub openings	
	Closing Plate for "A-L" Hub opening	
	2.00	A250
	2.50	AAP
B	3.00	ACPL
	3.50	A200L*
	4.00	A250L
	Closing Plate for "B" Hub opening	
	0.75	A300L
B300	1.00	A350L
	1.25	A400L
	1.50	BCAP
	2.00	B075
	2.50	B100
	3.00	B125
		B150
		B200
		B250
		B300

\* Supplied with AAP adapter plate and "A" hub.

# CSED – Application Info

## Knockouts, Dimensions

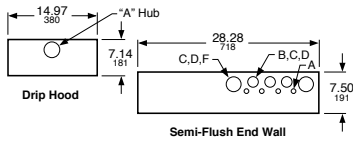

### Knockouts

Symbol	A	B	C	D	E	F	G	H	I	J
Conduit Size (in.)	½	¾	1	1¼	1½	2	2½	3	3½	4

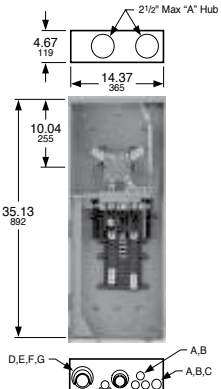
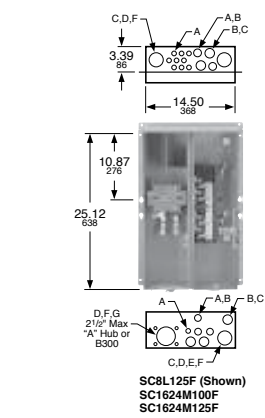
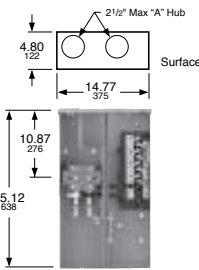
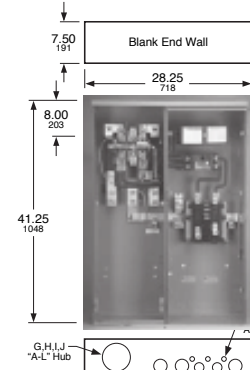
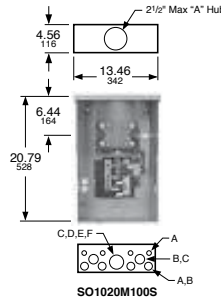
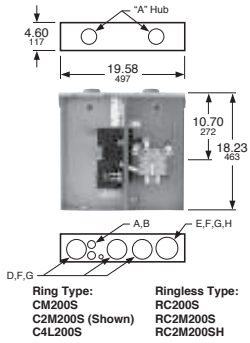
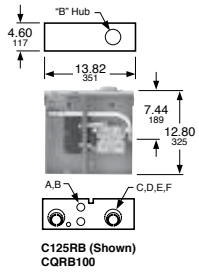

- CU12L400FN\* CU12L400FB\* CU816D400FN\* CU816D400FB\* CU816D400CK
- CU12L400CN\* CU12L400CB\* CU816D400CN\* CU816D400CB\* CU816D400CL\* CU816D400SL\* CU816D400FL\*
- CU12L400FL\* CU816D400FL\*

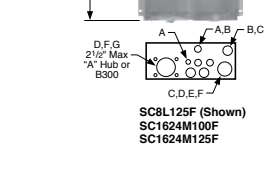
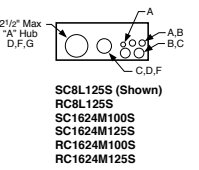

- RC816F100CH, RC816F125CH, RC816F150C/CH, RC816F150S, RC816F200C/CH, RC816F200S, RC2040M125CH, RC2040M150CH, RC2040M200C/CH
- QC816F100CH, QC816F125C/CH, QC816F150C/CH (Shown), QC816F200C/CH, QC2442M150CH, QC2442M200C/CH, SO2040M200S

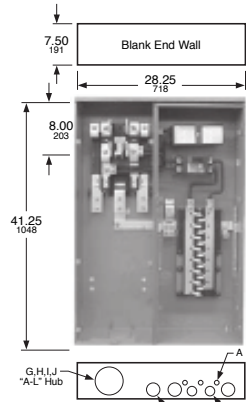
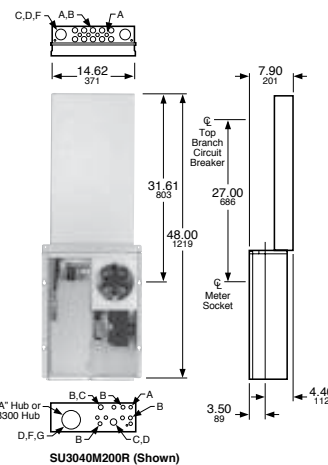
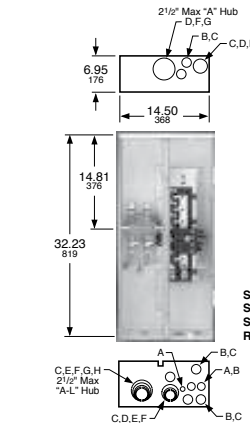

- SU3040D400CB\* (Shown), SU3040D300CB\*, SU3040D400CL\*, SU3040D400CK\*, SU3040D400CN\*, SU3040D400FL\*, SU3040D300FB\*, SU3040D400FB\*, SU3040D400FK\*

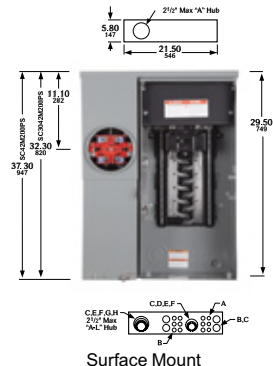
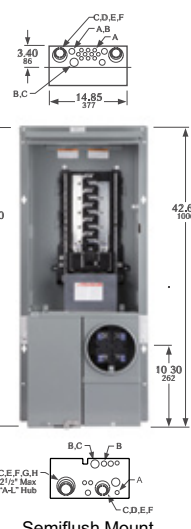

- ▲ Driphood supplied factory-installed and is required for surface mount installation. For semi-flush installation, remove driphood and install flange kit SC200F (order separately).
- Unit supplied with blank top endwall (factory-installed) for surface mount installation. For semi-flush installation, install flange kit FK400 (order separately). Kit includes replacement top endwall (with knockouts) and flanges.
- ◆ Unit supplied with semi-flush top endwall factory-installed and semi-flush flanges factory included.

# Meter Sockets

## Individual and Horizontal Ganged Meter Sockets

Individual sockets available in ring or ringless type, single- or three-phase, 600 Vac maximum with and without horn or lever bypass, overhead and underground service feeds.

Horizontal ganged meter sockets available in ring or ringless type, single-phase, 600 Vac maximum, main lugs only, two to six meter positions, with and without horn or lever bypass, end or center feed, overhead and underground service feeds.

This metering is generally utility specific. Always check with local utility company before installing. Contact local Square D representative for additional catalog numbers.

## Horizontal Ganged Meter Sockets

- 1Ø, 600 Vac max., main lugs only, 2 through 6 meter positions, with and without horn or lever bypass, end or center feed, overhead and underground service feeds.
- 10 kA short circuit current rating (or higher with utility approval).
- UL Listed, NEMA 3R enclosure.
- Supplied with ground lugs.
- Supplied with hub opening in top endwall, requires the use of a bolt-on hub, or closing plate.

This metering is generally utility specific. Always check with local utility company before installing. Contact your nearest Field Sales Office for additional catalog numbers, if required by utility.

## Ring Type

- 10k RMS Symmetrical Amps Short Circuit Current Rating
- UL Listed, NEMA Type 3R Enclosure
- Units Supplied with Bonded Neutral
- Units Supplied with Hub Opening in TOP Endwall Require the Use of a Bolt-On Hub or Closing Plate

## Ringless Type

- 10k RMS Symmetrical Amps Short Circuit Current Rating
- UL Listed, NEMA Type 3R Enclosure
- Units Supplied with Bonded Neutral
- Units Supplied with Hub Opening in TOP Endwall Require the Use of a Bolt-On Hub or Closing Plate
- Units Supplied with Solid TOP are for Underground Feed Only

## Ringless Type, 1Ø3W, 600 Vac Max., Without Bypass or Jaw Release

Amperes <sup>[3]</sup>	Branch Ratings			Mains Rating (A)	Cat. No.	Main Lugs Phase and Neutral Al/Cu (AWG/kcmil)	Branch Lugs Phase and Neutral Al/Cu (AWG)	Top Endwall <sup>[1]</sup>		Box No. <sup>[2]</sup>
	No. of Positions	Socket Jaw Qty. <sup>[4]</sup>	Service Type					Hub Type (Order Separately)	Closing Plate (Order Separately)	
100 A	2	4	OH/UG	200	UT2R1121B	6-250	8-2/0	Series A	ACP	13R
	3			205	UT3R1121B	6-250				13R1
	4			205	UT4R1131B	6-350				14R
	5			250	UT5R1131B	6-350				15R
	6			300	UT6R1131B	6-350				16R
200 A	2	4	OH/UG	205	UT2R2122B	6-250	8-250	Series A	ACP	17R
	4			360	UT4R2352T	1/0-500		Series A-L	ACPL	18R
	5			500	UT5R2392TU	1/0-500 or (2)1/0-350		Series A-L	ACPL	19R
	6			620	UT6R2392TU	1/0-500 or (2)1/0-350		Series A-L	ACPL	20R

<sup>[1]</sup> For hubs and closing plates.

<sup>[2]</sup> For box dimensions.

<sup>[3]</sup> Rating is continuous.

<sup>[4]</sup> Fifth jaw kit available to convert 4-jaw socket to a 5-jaw socket.

# Meter Sockets (cont.)

## Individual Meter Sockets

Ampere Rating <sup>[1]</sup>	Jaw Qty.	Service Type	Cat. No. <sup>[2]</sup>	Lug Wire Range (Al/Cu)			Enclosure Information			Box No. <sup>[3]</sup>
				Line, Load, and Neutral (AWG/kcmil)	Wire Binding	Gnd. (AWG)	Material	Top Endwall Conf.		
								Hub Opening <sup>[4]</sup>	Closing Plate <sup>[4]</sup>	
<b>Ringless Type, 1Ø3W 600 Vac Max., Without Bypass or Jaw Release</b>										
125	4	UG	UTZRS101A <sup>[5]</sup>	8–2/0	½ in. Hex	14–2	Steel	Solid Top <sup>[5]</sup>	—	1R
125	4	OH	UTRS101B	8–2/0	Slotted	14–2	Steel	Series A	ACP	1R
125	4	OH	UATRS101B	8–2/0	Slotted	14–2	Aluminum	Series A	ACPA	1R
125	4	OH	URS101BCPL	8–2/0	Slotted	14–2	Steel	Series A	ACP	1R
125	5	OH/UG	1003880A <sup>[6]</sup>	8–2/0	Slotted	14–2	Steel	Series A	ACP	1R
200	4	OH	UTRS202B	8–250	½ in. Hex	14–2	Steel	Series A	ACP	3R
200	4	OH	UATRS202B	8–250	½ in. Hex	14–2	Aluminum	Series A	ACPA	3R
200	4	UG	UTRS213A <sup>[5]</sup>	1/0–350	½ in. Hex	14–2	Steel	Solid Top <sup>[5]</sup>	—	5R
200	4	OH/UG	UTRS213B <sup>[6]</sup>	1/0–350	½ in. Hex	14–2	Steel	Series A	ACP	5R
200	4	OH/UG	UATRS213B <sup>[6]</sup>	1/0–350	½ in. Hex	14–2	Aluminum	Series A	ACPA	5R
200	4	OH/UG	U92197CCCPL <sup>[7]</sup>	1/0–350	½ in. Hex	14–2	Steel	(2) Series A	(2) ACP <sup>[7]</sup>	7R
<b>Ringless Type, 1Ø3W 600 Vac Max., With Horn Bypass, Without Jaw Release</b>										
125	4	OH/UG	UHTRS101B	8–2/0	Slotted	14–2	Steel	Series A	ACP	1R
125	5	OH	UGHTRS101L <sup>[8]</sup>	8–2/0	Slotted	14–2	Steel	A125 <sup>[8]</sup>	—	1R
125	4	OH	URS101BDQ <sup>[9]</sup>	8–2/0	½ in. Hex	None	Steel	Series A	ACP	1R
125	5	OH/UG	UGHTRS111C <sup>[10]</sup>	8–2/0	Slotted	14–2	Steel	Series A	ACP <sup>[10]</sup>	4R
200	4	OH/UG	UBHMRS212B <sup>[6]</sup>	8–250	½ in. Hex	None	Steel	Series A	ACP	4R
200	4	OH	UHTRS202B	8–250	½ in. Hex	14–2	Steel	Series A	ACP	3R
200	4	OH/UG	UHTRS212B <sup>[6]</sup>	8–250	½ in. Hex	14–2	Steel	Series A	ACP	4R
200	4	OH/UG	UHTRS213B <sup>[6]</sup>	1/0–350	½ in. Hex	14–2	Steel	Series A	ACP	5R
200	4	UG	UHTRS223A <sup>[5]</sup>	1/0–350	½ in. Hex	14–2	Steel	Solid Top <sup>[5]</sup>	—	2R
200	4	UG	URS212ADQ <sup>[9]</sup>	8–250	½ in. Hex	None	Steel	Solid Top <sup>[5]</sup>	—	4R
<b>Ringless Type, 1Ø3W 600 Vac Max., With Lever Bypass and Jaw Release</b>										
200	4	OH	UTH4203T	6–350	½ in. Hex	14–2	Steel	Series A-L	ACPL	8R
200	4	OH/UG	UTH4213T <sup>[6]</sup>	6–350	½ in. Hex	14–2	Steel	Series A-L	ACPL	9R
200	5	OH	UTH5203T	6–350	½ in. Hex	14–2	Steel	Series A-L	ACPL	8R
200	5	OH/UG	UTH5213T <sup>[6]</sup>	6–350	½ in. Hex	14–2	Steel	Series A-L	ACPL	9R
320	4	OH/UG	UTH4330T <sup>[11]</sup>	Studs Only	¾ in. dia. studs	14–1/0	Steel	Series A-L	ACPL	11R
<b>Ringless Type, 3Ø4W 600 Vac Max., With Lever Bypass and Jaw Release</b>										
200	7	OH/UG	UTH7213T <sup>[6]</sup>	6–350	½ in. Hex	14–2	Steel	Series A-L	ACPL	9R
320	7	OH	UTH7300T <sup>[11]</sup>	Studs Only	¾ in. dia. studs	14–1/0	Steel	Series A-L	ACPL	10R
<b>Ringless Type, 3Ø4W 600 Vac Max., Bolt-On Socket Without Bypass</b>										
400	7	OH/UG	UK7T <sup>[11]</sup>	Studs Only	½ in.–20 dia. studs	½ in.–20 dia. studs	Steel	Series A-L	ACPL	12R
400	7	OH/UG	UAK7T <sup>[11]</sup>	Studs Only	½ in.–20 dia. studs	½ in.–20 dia. studs	Aluminum	Series A-L	ACPLA	12R
<b>Ring Type, 1Ø3W 600 Vac Max., Without Bypass or Jaw Release</b>										
125	4	OH/UG	URTRS101B <sup>[6]</sup>	8–2/0	Slotted	14–2	Steel	Series A	ACP	1R
200	4	OH/UG	URTRS213B <sup>[6]</sup>	1/0–350	½ in. Hex	14–2	Steel	Series A	ACP	5R

<sup>[1]</sup> Rating is continuous.

<sup>[2]</sup> Device requires approval from the serving utility, consult your nearest Schneider Electric sales office.

<sup>[3]</sup> For box dimensions, see page 2-4

<sup>[4]</sup> Order appropriate bolt-on hub or closing plate separately and install on TOP endwall.

<sup>[5]</sup> Device supplied with solid top endwall (without hub opening).

<sup>[6]</sup> When unit is installed for underground feed, the appropriate closing plate must be ordered separately and installed over hub opening in TOP endwall of device.

<sup>[7]</sup> Device supplied with two closing plates ACP mounted in TOP endwall.

<sup>[8]</sup> Device supplied with 1-1/4 in. bolt-on hub (Cat. No. A125) mounted on TOP endwall.

<sup>[9]</sup> Contains "Duquesne Light Co." approved label.

<sup>[10]</sup> Device supplied with closing plate ACP mounted on TOP endwall.

<sup>[11]</sup> Order lugs separately

## Adapter Plate, Lug Kits, and Sealing Rings

Accessory	Description	Cat. No.
Adapter Plate	To allow the use of a Series A Hub on a device that is setup for a series A-L Hub.	AAP
Lug Kits	For use on meter sockets supplied with Line, Load, and Neutral Studs only. Be sure to order enough lugs for each device (a typical 1Ø device requires 6 lugs).	
	Includes one, two-barrel lug (6-250 kcmil)	ARP00118
	Includes one, single barrel lug (4-600 kcmil)	ARP00129
	Includes three, two-barrel lugs (6-350 kcmil)	ARP00427
Sealing Ring	Snap-on Aluminum (Standard)	2920910001
	Snap-on Stainless Steel (Non-standard)	ARP00026
	Screw Type Aluminum (Non-standard)	29008W

## Meter Socket Accessories: Fifth-Jaw Kit, Closing Plates, and Hubs

Accessory	Description	Cat. No.	
Fifth-Jaw Kit	Converts a 4-jaw meter socket to a 5-jaw meter socket. For use on meter sockets supplied without lever bypass or jaw release only.	A5J	
Closing Plates (to seal hub openings)	For Series A (steel)	ACP	
	For Series A (aluminum)	ACPA	
	For Series A-L (steel)	ACPL	
	For Series A-L (aluminum)	ACPLA	
Hubs (listed by conduit size)	Series A	1.00 inch	A100
		1.25 inch	A125
		1.50 inch	A150
		2.00 inch	A200
		2.50 inch	A250
	Series A-L	2.00 inch	A200L
		2.50 inch	A250L
		3.00 inch	A300L
		3.50 inch	A350L
		4.00 inch	A400L
	Series B	3.00 inch	B300



UHTRS101B



URTRS101B



UTRS213B

## CSED – Wire Size

Meter Mains				
Catalog #	Line Side Phase and Neutral Lugs AWG/kcmil (Al/Cu)	Service Ground Lug AW/kcmil (Al/Cu)	Feed Through Lugs AWG/kcmil (Al/Cu)	Bypass Type
C125RB	(1) #4 - 1/0	(1) #8 - 1/0	—	—
CM200S	(1) #4 - 250	(2) #8 - 2/0	—	—
C2M200S	(1) #4 - 250	(2) #8 - 2/0	—	—
C4L200S	(1) #4 - 250	(2) #8 - 2/0	—	—
CU12L400CN	(2) Studs	#4 - 250	—	—
CU12L400CB	(2) Studs	#4 - 250	—	Class 320 Manual
CU816D400CN	(2) Studs	#4 - 250	—	—
CU816D400CB	(2) Studs	#4 - 250	—	Class 320 Manual
SC8L125S	(1) #6 - 2/0	(1) #12 - 4	—	—
SC12L200S	(1) #4 - 250	(1) #12 - 2/0	—	—
SC8L125F	(1) #6 - 2/0	(1) #12 - 2/0	—	—
SC12L200F	(1) #4 - 250	(1) #12 - 2/0	—	—
SC816D150C	(1) #6 - 300	(1) #12 - 1/0	#6 - 250	—
SC816D200C	(1) #6 - 300	(1) #12 - 1/0	#6 - 250	—
RC200S	(1) #6 - 350	(2) #8 - 2/0	—	—
RC2M200S	(1) #6 - 350	(2) #8 - 2/0	—	—
RC2M200SH	(1) #6 - 350	(2) #8 - 2/0	—	Horn
QC12L200C	(1) #6 - 350	(1) #12 - 2/0	—	—
QC816F100CH	(1) #6 - 350	(1) #12 - 2/0	#6 - 250	Horn
QC816F125C	(1) #6 - 350	(1) #12 - 2/0	#6 - 250	—
QC816F125CH	(1) #6 - 350	(1) #12 - 2/0	#6 - 250	Horn
QC816F150C	(1) #6 - 350	(1) #12 - 2/0	#6 - 250	—
QC816F150CH	(1) #6 - 350	(1) #12 - 2/0	#6 - 250	Horn
QC816F200C	(1) #6 - 350	(1) #12 - 2/0	#6 - 250	—
QC816F200CH	(1) #6 - 350	(1) #12 - 2/0	#6 - 250	Horn
QU12L400CL	(2) Studs	#4 - 250	—	Class 320 Lever
QU12L400SL	(2) Studs	#4 - 250	—	Class 320 Lever
QU816D400CL	(2) Studs	#4 - 250	#6 - 250	Class 320 Lever
QU816D400SL	(2) Studs	#4 - 250	#6 - 250	Class 320 Lever
RC8L125S	(1) #6 - 2/0	(1) #12 - 4	—	—
RC12L200C	(1) #6 - 350	(1) #12 - 2/0	—	—
RC816F100CH	(1) #6 - 350	(1) #12 - 2/0	#6 - 250	Horn
RC816F125CH	(1) #6 - 350	(1) #12 - 2/0	#6 - 250	Horn
RC816F150C	(1) #6 - 350	(1) #12 - 2/0	#6 - 250	—
RC816F150CH	(1) #6 - 350	(1) #12 - 2/0	#6 - 250	Horn
RC816F200C	(1) #6 - 350	(1) #12 - 2/0	#6 - 250	—
RC816F200CH	(1) #6 - 350	(1) #12 - 2/0	#6 - 250	Horn
RC816D200CH	(1) #6 - 300	(1) #6 - 1/0	#6 - 250	Horn
SC1624M100S	(1) #6 - 2/0	(1) #12 - 4	—	—
SC1624M125S	(1) #6 - 2/0	(1) #12 - 4	—	—
SC2040M200C	(1) #6 - 300	(1) #12 - 1/0	—	—

## All-In-Ones

Catalog #	Line Side Phase and Neutral Lugs AWG/kcmil (Al/Cu)	Service Ground Lug AW/kcmil (Al/Cu)	Feed Through Lugs AWG/kcmil (Al/Cu)	Bypass Type
SC1624M100F	(1) #6 - 2/0	(1) #12 - 2/0	—	—
SC1624M125F	(1) #6 - 2/0	(1) #12 - 2/0	—	—
SO1020M100S	(1) #6 - 1	(1) #14 - 4	—	—
SO2040M200S	(1) #6 - 350	(1) #8 - 2/0	—	—
SU3040M200R	(1) #6 - 300	(1) #12 - 1/0	—	—
SU3040M225R	(1) #6 - 300	(1) #12 - 1/0	—	—
SU3040D300CB	(2) Studs	(1) #4 - 250	—	Class 320 Manual
SU3040D400CN	(2) Studs	(1) #4 - 250	—	—
SU3040D400CB	(2) Studs	(1) #4 - 250	—	Class 320 Manual
RC1624M100S	(1) #6 - 2/0	(1) #12 - 4	—	—
RC1624M125S	(1) #6 - 2/0	(1) #12 - 4	—	—
RC2040M125CH	(1) #6 - 350	(1) #12 - 2/0	—	Horn
RC2040M150CH	(1) #6 - 350	(1) #12 - 2/0	—	Horn
RC2040M200C	(1) #6 - 350	(1) #12 - 2/0	—	—
RC2040M200CH	(1) #6 - 350	(1) #12 - 2/0	—	Horn
RU3040D400CL	(2) Studs	#4 - 250	—	Class 320 Lever
RU3040D400CK	(2) Studs	#4 - 250	—	K-4 Bolt-On
QC2442M150CH	(1) #6 - 350	(1) #12 - 1/0	—	Horn
QC2442M200C	(1) #6 - 350	(1) #12 - 1/0	—	—
QC2442M200CH	(1) #6 - 350	(1) #12 - 1/0	—	Horn

# Value Packs

Different value pack combinations offer an affordable mix of products for load center customers. Value packs are ideal for new construction, upgrades and remodels. Designed to meet various needs, special packs are combined for QO, Homeline and Combination Service Entrance Device (CSED) products.

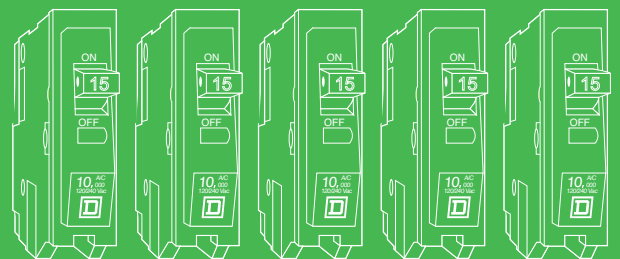
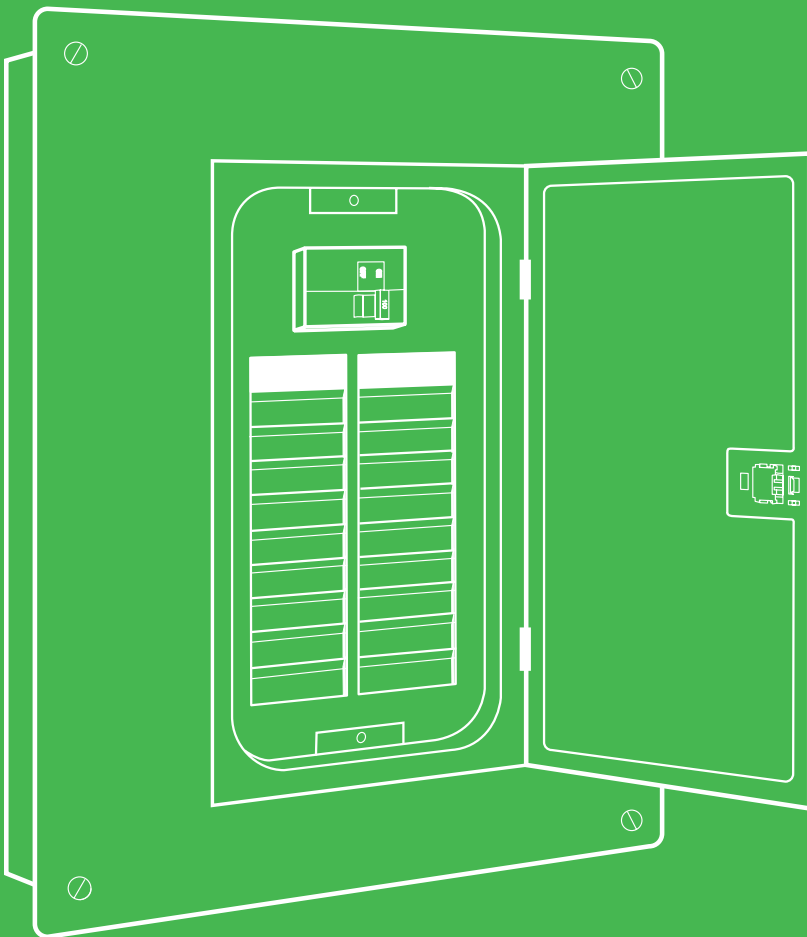



# Value Packs

Catalog #	Description	UPC Code	Image
HOME250SPA	<ul style="list-style-type: none"> <li>1 – HOM24L50R Homeline 50A 2 Space/4 Circuit Max. Main Lug Load Center</li> <li>1 – HOM250GFI Homeline 50A Double-Pole Ground Fault Circuit Interrupter</li> </ul>	7-85901-23054-0	
HOM2040M100PCVP	<ul style="list-style-type: none"> <li>1 – HOM2040M100PC Homeline 100A 20 Space/40 Circuit Max. Main Breaker Load Center with Combination Cover</li> <li>2 – HOM120 Homeline 20A 1-Pole Circuit Breaker</li> <li>1 – HOM230 Homeline 30A 2-Pole Circuit Breaker</li> </ul>	7-85901-97733-9	
HOM1224L125PGCVP	<ul style="list-style-type: none"> <li>1 – HOM1224L125PGC Homeline 125A 12 Space/24 Circuit Max. Main Lug Load Center with Combination Cover</li> <li>2 – HOM120 Homeline 20A 1-Pole Circuit Breaker</li> </ul>	7-85901-86428-8	
HOM1224M125PRBVP	<ul style="list-style-type: none"> <li>1 – HOM1224M125PRB Homeline 125A 12 Space/24 Circuit Max. Main Breaker Outdoor Load Center</li> <li>3 – HOM120 Homeline 30A 2-Pole Circuit Breaker</li> <li>2 – HOM230 Homeline 30A 2-Pole Circuit Breaker</li> </ul>	7-85901-86113-3	
HOM3060M150PCVP	<ul style="list-style-type: none"> <li>1 – HOM3060M150PC Homeline 150A 30 Space/60 Circuit Max. Main Breaker Load Center with Combination Cover</li> <li>3 – HOM120 Homeline 20A 1-Pole Circuit Breaker</li> <li>2 – HOM230 Homeline 30A 2-Pole Circuit Breaker</li> </ul>	7-85901-97770-4	
HOM2040M200PCVP	<ul style="list-style-type: none"> <li>1 – HOM2040M200PC Homeline 200A 20 Space/40 Circuit Max. Main Breaker Load Center with Combination Cover</li> <li>3 – HOM120 Homeline 20A 1-Pole Circuit Breaker</li> <li>2 – HOM230 Homeline 30A 2-Pole Circuit Breaker</li> </ul>	7-85901-97706-3	
HOM3060L225PGCVP	<ul style="list-style-type: none"> <li>1 – HOM3060L225PGC Homeline 225A 30 Space/60 Circuit Max. Main Lug Load Center with Combination Cover</li> <li>3 – HOM120 Homeline 20A 1-Pole Circuit Breaker</li> <li>2 – HOM230 Homeline 30A 2-Pole Circuit Breaker</li> </ul>	7-85901-97723-0	

# Value Packs

Catalog #	Description	UPC Code	Image
HOM3060M200PCVP	<ul style="list-style-type: none"> <li>1 – HOM3060M200PC Homeline 200A 30 Space/ 60 Circuit Max. Main Breaker Load Center with Combination Cover</li> <li>3 – HOM120 Homeline 20A 1-Pole Circuit Breaker</li> <li>2 – HOM230 Homeline 30A 2-Pole Circuit Breaker</li> </ul>	7-85901-97782-7	
HOM3060M200PRBVP	<ul style="list-style-type: none"> <li>1 – HOM3060M200PRB Homeline 200A 30 Space/ 60 Circuit Max. Main Breaker Outdoor Load Center</li> <li>3 – HOM120 Homeline 20A 1-Pole Circuit Breaker</li> <li>2 – HOM230 Homeline 30A 2-Pole Circuit Breaker</li> </ul>	7-85901-97807-7	
HOM4080M200PCVP	<ul style="list-style-type: none"> <li>1 – HOM4080M200PC Homeline 200A 40 Space/ 80 Circuit Max. Main Breaker Load Center with Combination Cover</li> <li>3 – HOM120 Homeline 20A 1-Pole Circuit Breaker</li> <li>2 – HOM230 Homeline 30A 2-Pole Circuit Breaker</li> </ul>	7-85901-97751-3	
HOM2040M100PC1AVP	<ul style="list-style-type: none"> <li>1 – HOM2040M100PC Homeline 100A 20 Space/ 40 Circuit Max. Main Breaker Load Center with Combination Cover</li> <li>2 – HOM120 Homeline 20A 1-Pole Circuit Breaker</li> <li>1 – HOM115PCAFI Homeline 15A 1-Pole Plug-on Neutral Combination Arc Fault Circuit Breaker</li> <li>1 – HOM230 Homeline 30A 2-pole Breaker</li> </ul>	7-85901-97735-3	
HOM2448M100PCVP	<ul style="list-style-type: none"> <li>1 – HOM2448M100PC Homeline 100A 24 Space/ 48 Circuit Max. Main Breaker Load Center with Combination Cover</li> <li>3 – HOM120 Homeline 20A 1-Pole Circuit Breaker</li> <li>2 – HOM230 Homeline 30A 2-Pole Circuit Breaker</li> </ul>	7-85901-97727-8	
HOM3060M200PC1AVP	<ul style="list-style-type: none"> <li>1 – HOM3060M200PC Homeline 200A 30 Space/ 60 Circuit Max. Main Breaker Load Center with Combination Cover</li> <li>3 – HOM120 Homeline 20A 1-Pole Circuit Breaker</li> <li>2 – HOM230 Homeline 30A 2-Pole Circuit Breaker</li> <li>1 – HOM115PCAFI Homeline 15A 1-Pole Plug-on Neutral Combination Arc Fault Circuit Breaker</li> </ul>	7-85901-97767-4	
HOM3060M200PCAFVP	<ul style="list-style-type: none"> <li>1 – HOM3060M200PC Homeline 200A 30 Space/ 60 Circuit Max. Main Breaker Load Center with Combination Cover</li> <li>3 – HOM120 Homeline 20A 1-Pole Circuit Breaker</li> <li>2 – HOM230 Homeline 30A 2-Pole Circuit Breaker</li> <li>3 – HOM115PCAFI Homeline 15A 1-Pole Plug-on Neutral Combination Arc Fault Circuit Breaker</li> </ul>	7-85901-97778-0	

Catalog #	Description	UPC Code	Image
HOM4080M200PC1AVP	<ul style="list-style-type: none"> <li>1 – HOM4080M200PC Homeline 200A 40 Space/80 Circuit Max. Main Breaker Load Center with Combination Cover</li> <li>3 – HOM120 Homeline 20A 1-Pole Circuit Breaker</li> <li>2 – HOM230 Homeline 30A 2-Pole Circuit Breaker</li> <li>1 – HOM115PCAFI Homeline 15A 1-Pole Plug-on Neutral Combination Arc Fault Circuit Breaker</li> </ul>	7-85901-97704-9	
HOM4080M200PCAFVP	<ul style="list-style-type: none"> <li>1 – HOM4080M200PC Homeline 200A 40 Space/80 Circuit Max. Main Breaker Load Center with Combination Cover</li> <li>3 – HOM120 Homeline 20A 1-Pole Circuit Breaker</li> <li>2 – HOM230 Homeline 30A 2-Pole Circuit Breaker</li> <li>3 – HOM115PCAFI Homeline 15A 1-Pole Plug-on Neutral Combination Arc Fault Circuit Breaker</li> </ul>	7-85901-97750-6	
QOE250GFINM	<ul style="list-style-type: none"> <li>1 – QO24L60NRNM QO 60A 2 Space/4 Circuit Max. Non-Metallic Main Lug Load Center</li> <li>1 – QO250GFI QO 50A Double-Pole Ground Fault Circuit Interrupter</li> </ul>	7-85901-38950-7	
QO32M100VP <i>(replaces QOVP2)</i>	<ul style="list-style-type: none"> <li>1 – QO132M100C QO 100A 32 Space/32 Circuit Max. Main Breaker Load Center with Combination Cover</li> <li>3 – QO120 QO 20A 1-Pole Circuit Breaker</li> <li>2 – QO230 QO 30A 2-Pole Circuit Breaker</li> </ul>	7-85901-87965-7	
QO3040M200VP <i>(replaces QOVP1 and QOVP10)</i>	<ul style="list-style-type: none"> <li>1 – QO13040M200C QO 200A 30 Space/40 Circuit Max. Main Breaker Load Center with Combination Cover</li> <li>3 – QO120 QO 20A 1-Pole Circuit Breaker</li> <li>2 – QO230 QO 30A 2-Pole Circuit Breaker</li> </ul>	7-85901-69267-6	
QO124L125PGCVP	<ul style="list-style-type: none"> <li>1 – QO124L125PGC QO 125A 24 Space/24 Circuit Max. Main Lug Load Center with Combination Cover</li> <li>3 – QO120 QO 20A 1-Pole Circuit Breaker</li> <li>2 – QO230 QO 30A 2-Pole Circuit Breaker</li> </ul>	7-85901-97822-0	
QO142L225PGCVP	<ul style="list-style-type: none"> <li>1 – QO142L225PGC QO 225A 42 Space/42 Circuit Max. Main Lug Load Center with Combination Cover</li> <li>3 – QO120 QO 20A 1-Pole Circuit Breaker</li> <li>2 – QO230 QO 30A 2-Pole Circuit Breaker</li> </ul>	7-85901-98618-8	

# Value Packs

Catalog #	Description	UPC Code	Image
QO124M100PCVP	<ul style="list-style-type: none"> <li>1 – QO124M100PC QO 100A 24 Space/24 Circuit Max. Main Breaker Load Center with Combination Cover</li> <li>3 – QO120 QO 20A 1-Pole Circuit Breaker</li> <li>2 – QO230 QO 30A 2-Pole Circuit Breaker</li> </ul>	7-85901-97893-0	
QO142M200PCVP	<ul style="list-style-type: none"> <li>1 – QO142M200PC QO 200A 42 Space/42 Circuit Max. Main Breaker Load Center with Combination Cover</li> <li>3 – QO120 QO 20A 1-Pole Circuit Breaker</li> <li>2 – QO230 QO 30A 2-Pole Circuit Breaker</li> </ul>	7-85901-99710-8	
QO142M200PCAFVP	<ul style="list-style-type: none"> <li>1 – QO142M200PC QO 200A 42 Space/42 Circuit Max. Main Breaker Load Center with Combination Cover</li> <li>3 – QO120 QO 20A 1-Pole Circuit Breaker</li> <li>2 – QO230 QO 30A 2-Pole Circuit Breaker</li> <li>3 – QO115PCAFI QO 15A 1-Pole Plug-on Neutral Combination Arc Fault Circuit Breaker</li> </ul>	7-85901-80936-4	
SO1020VP	<ul style="list-style-type: none"> <li>1 – SO1020M100S 100A 10 Space/20 Circuit Max. All-In-One Overhead Service Feed and Integral Ring-Type Meter Socket</li> <li>3 – HOM120 Homeline 20A Single-Pole Circuit Breakers</li> <li>1 – HOMET2020 Homeline 20A Single-Pole Tandem Circuit Breaker</li> </ul>	7-85901-39642-0	
SO2040VP	<ul style="list-style-type: none"> <li>1 – SO2040M200S 200A 20 Space/40 Circuit Max. All-In-One Overhead Service Feed and Integral Ring-Type Meter Socket</li> <li>4 – HOM120 Homeline 20A Single-Pole Circuit Breakers</li> <li>1 – HOMET2020 Homeline 20A Single-Pole Tandem Circuit Breaker</li> <li>1 – HOM230 Homeline 30A Double-Pole Circuit Breaker</li> <li>1 – HOM250 Homeline 50A Double-Pole Circuit Breaker</li> </ul>	7-85901-39643-7	
RC2040M200CGP Generator Panel	<ul style="list-style-type: none"> <li>1 – RC2040M200C 200A 20 Space/40 Circuit Max. All-In-One Overhead/Underground Service Feed and Integral Ringless-Type Meter Socket</li> <li>1 – HOM230 Homeline 30A Double-Pole Circuit Breaker</li> <li>1 – HOMCGK2C Homeline Indoor Generator Interlock Kit</li> </ul>	7-85901-48190-4	



# Control Switches

## Float and Pressure Switches

For over 65 years, our Square D brand Pumptrol™ FSG Pressure Switches have been used to monitor and control electrically driven water pumps. A long-time industry standard, you can trust that Square D brand switches will do the necessary job every time.

---

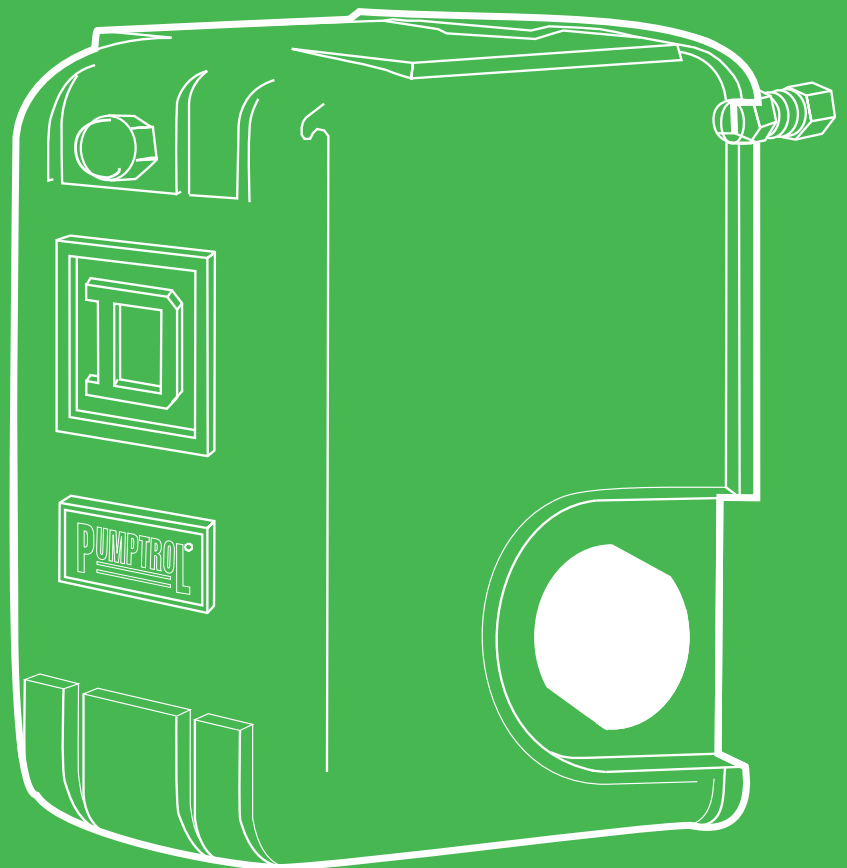

Square D introduced the FSG water pump switch in 1947. Today many more Square D brand switches are installed on pumps than any other switch available on the market.

# Switches – Float

## Pumptrol Float Switches Class 9036

Sump or Open Tank Style – Type FG			
Catalog #	UPC Code	Type	Description
9036FG	Special Order	—	Universal kit which includes switch, plastic center hole float, rod and attaching hardware
9036FG30	Special Order	Switch only	Contacts open or close on liquid rise 2-pole NEMA 1
9049A60	Special Order	Float	Plastic center hole float
9049A61	Special Order	Rod	33.75 inch aluminum rod, 2 float stop assemblies and attaching hardware

Sump or Open Tank Style – Type DG, GG						
Catalog #	UPC Code	Type	Description	Force up to trip	Force down to Trip	Level Position
9036DG2*	Special Order	Switch only	Contacts close on liquid rise	9 oz.	8 oz.	n/a
9036DG2R	7-85901-57643-3	Switch only	Contacts open on liquid rise	9 oz.	8 oz.	n/a
9036GG2*	Special Order	Switch only	Contacts close on liquid rise (Requires a 9049 float and rod kit)	33 (21) oz.	39 (27) oz.	short, (long)
9036GG2R*	7-85901-57543-6	Switch only	Contacts open on liquid rise (Requires a 9049 float & rod kit)	34 (21) oz.	40 (27) oz.	short, (long)
9049A6*	7-85901-59704-9	Tapped-at-Top float and rod kit	#304 SS float. 7" diameter 5' brass tubing and two stops	—	—	—
9049A6S	7-85901-59704-9	Float and rod kit	#304 SS float. 7" diameter 5' SS tubing and two stops	—	—	—
9049A6C	7-85901-59706-3	Center-Hole float and rod kit	#304 SS float. 7" diameter 5' brass tubing and four stops	—	—	—
9049A6CS	7-85901-59735-3	Float and rod kit	#304 SS float. 7" diameter 5' SS tubing and four stops	—	—	—
9049T1	7-85901-34988-4	Additional Tubing	2½' brass tubing with connector	—	—	—
9049T1S	7-85901-34990-7	Additional Tubing	2½' SS tubing with connector	—	—	—

\* Item may require additional lead time.

- Pedestal Style Type FG30
  - Designed for liquid level control with electric motor operated pumps either directly or through a magnetic starter
  - Can also be used to activate alarms in liquid level control systems
  - Upward or downward movement of the lever arm of the Class 9036 Type FG30 float switch controls the ON and OFF positions corresponding to the water level changes required to turn the pump or alarm on and off
- Sump or Open Tank Type DG, GG
  - Double-pole rated, 3 phase
  - 2 HP @ 115 Vac and 3 HP @ 230 Vac
  - Designed for automatic control of liquid level in open sumps or tanks handling small motor loads directly or through a starter
  - NEMA Type 1 Indoor Enclosure
  - Type GG – heavier duty for light commercial and industrial applications.
- Double Pole Rated
  - 3HP @ 115V – 3 Phase
  - 5HP – 240V – 3 Phase

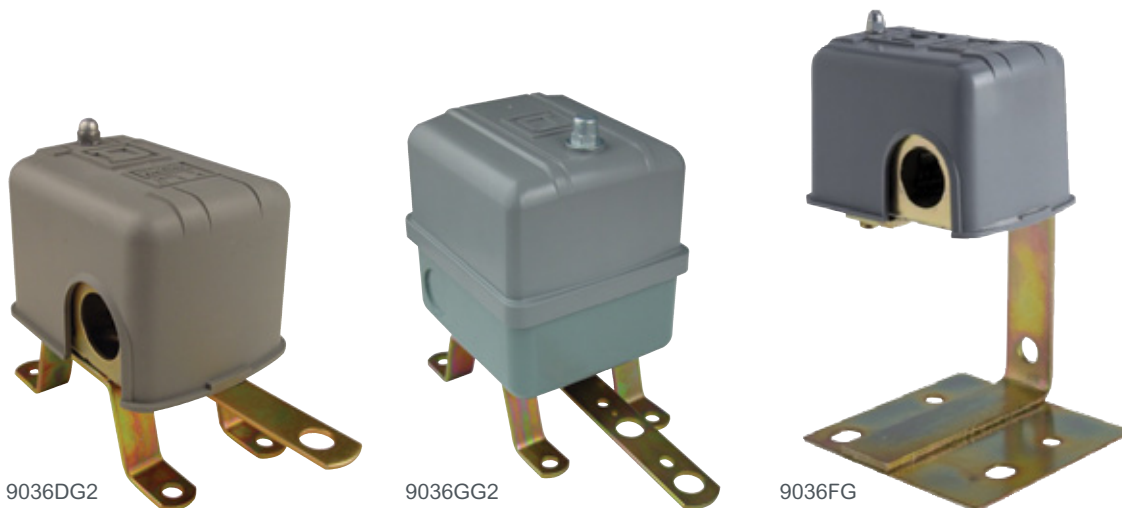

# Switches – Float

## Pumptrol Float Switches Class 9037

### Closed Tank – Screw-in Style – Type HG

Catalog #	UPC Code	Description	Float Position <sup>▲</sup>	Float Rod Angle	Approx. Water Level Change (Field Adjustable)	
					Minimum	Maximum
9037HG33*	Special Order	Contacts close on liquid rise	Right	45° offset	2"	5"
9037HG32	7-85901-07551-6	—	Left	90° offset	2"	11½"
9037HG31	Special Order	Contacts close on liquid rise	Right	90° offset	2"	11½"
9037HG30	Special Order	—	Left	90° offset	2"	8¼"

### Closed Tank – Flange Mount Style – Type EG

Catalog #	UPC Code	Description	Post Length
9037EG8	Special Order	For minimum water level change	2½"
9037EG9	Special Order	For maximum water level change	2½"

\* Item may require additional lead time.

▲ Viewed from front of switch facing indicator scale.

QUAD-RING<sup>®</sup> is a registered trademark of Minnesota Rubber Co.

VITON<sup>®</sup> is a registered trademark of DuPont Co.



9037EG

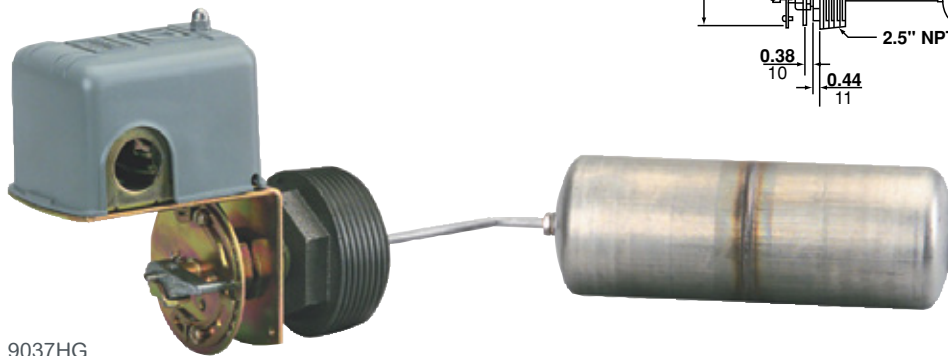

9037HG

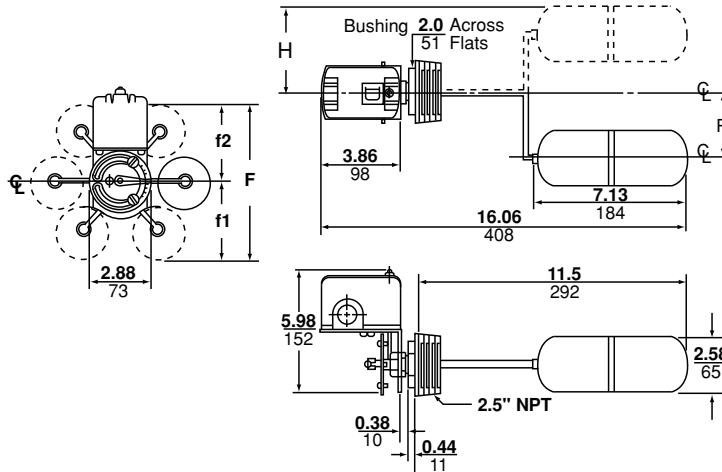
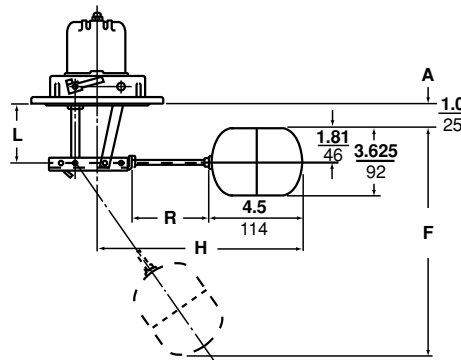

- Closed Tank-Type HG
  - NEMA Type 1 Indoor Enclosure
  - Double-pole rated
  - 2 HP @ 115 Vac and 3 HP @ 230 Vac
  - Type HG switch is attached to tank by means of 2½" threaded bushing
  - Switches come complete with stainless steel float and rod
  - Buna N Quad-Ring<sup>®</sup> seal is used between the float rod and sealing connector
  - Can withstand tank pressures up to 50 PSIG at temperatures up to 220°F
- Closed Tank-Type EG
  - NEMA Type 1 Indoor Enclosure
  - Double-pole rated, 3 phase
  - 2 HP @ 115 Vac 3 HP @ 230Vac
  - Switches are flange mounted and float movement is transmitted through a stuffing box – uses a quad ring seal
  - Can be built up to meet exact requirements from the basic switch, float rod and float groups
  - Switch may be assembled in the field to give contacts that open on liquid rise or close on liquid rise



# Switches – Pressure

## Pressure Switches

Catalog #	UPC Code	Cut-In Setting (PSIG)	Cut-Out Setting (PSIG)	Pressure Connection (NPSF Internal)	Additional Features*
<b>Water Pump Pressure Switches – Type FSG*</b>					
<b>Standard Action: Contacts Open On Rising Pressure; 2-Pole, NEMA 1</b>					
FSG2J20BP	0-47569-11533-2	20	40	1/4"	—
FSG2J20CP	0-47569-00632-6	20	40	1/4"	—
FSG2J20PBP	0-47569-11534-9	20	40	1/4"	Pulsation plug
FSG2J20PCP	0-47569-52171-3	20	40	1/4"	Pulsation plug
FSG2J20M1BP	0-47569-11535-6	20	40	1/4"	Manual cut-in lever
FSG2J20M1CP	0-47569-80786-2	20	40	1/4"	Manual cut-in lever
FSG2J20M4BP	0-47569-11536-3	20	40	1/4"	Low pressure cut-off
FSG2J20M4CP	0-47569-80787-9	20	40	1/4"	Low pressure cut-off
FSG2J18CP	Special Order	20	50	1/4"	—
FSG2J21BP	0-47569-11538-7	30	50	1/4"	—
FSG2J21CP	0-47569-80785-5	30	50	1/4"	—
FSG2J21M1BP	0-47569-11539-4	30	50	1/4"	Manual cut-in lever
FSG2J21M1CP	0-47569-04397-0	30	50	1/4"	Manual cut-in lever
FSG2J21M4BP	0-47569-11540-0	30	50	1/4"	Low pressure cut-off
FSG2J21M4CP	0-47569-03466-4	30	50	1/4"	Low pressure cut-off
FSG2J24BP	0-47569-11541-7	40	60	1/4"	—
FSG2J24CP	0-47569-07217-8	40	60	1/4"	—
FSG2J24M4BP	0-47569-11542-4	40	60	1/4"	Low pressure cut-off
FSG2J24M4CP	0-47569-17782-8	40	60	1/4"	Low pressure cut-off
<b>Water Pump Pressure Switches – Type FRG**</b>					
<b>Reverse Action: Contacts Open On Falling Pressure; 2-Pole, NEMA 1</b>					
9013FRG22J36	Special Order	10	5	1/4"	—
9013FRG22J19	Special Order	22	16	1/4"	—
9013FRG2J23	Special Order	40	20	1/4"	—
9013FRG2J23M3	Special Order	40	20	1/4"	Momentary manual cut-in lever (AUTO-START)
9013FRG2J23M5	Special Order	40	20	1/4"	Maintained manual cut-in lever (AUTO-ON)
9013FRG2J35	Special Order	50	30	1/4"	—
<b>Water Pump Pressure Switches – Type FYG***</b>					
<b>Standard Action: Contacts Open On Rising Pressure; 2-Pole, NEMA 1 with higher HP</b>					
9013FYG2J20	Special Order	20	40	1/4"	—
9013FYG2J21	Special Order	30	50	1/4"	—
9013FYG2J24	Special Order	40	60	1/4"	—
9013FYG2J33	Special Order	50	70	1/4"	—
9013FYG2J25	Special Order	60	80	1/4"	—

\* FSG2 – 20-65 PSIG Cut-in Range, 10-45 PSIG Cut-out Range, 15-30 PSIG Approx. Adjustable Differential▲

\*\* FRG2 – 23-65 PSIG Cut-in Range, 8-45 PSIG Cut-out Range, 15-30 PSIG Approx. Adjustable Differential▲

\*\*\* FRG22 – 10-45 PSIG Cut-in Range, 6-20 PSIG Cut-out Range, 4-25 PSIG Approx. Adjustable Differential▲

\*\*\* 9013FYG2 – 25-80 PSIG Cut-in Range, 5-60 PSIG Cut-out Range, 20-30 PSIG Approx. Adjustable Differential▲

▲ Differential – the difference between cut-in and cut-out pressure.



Class 9013 Type FSG

- Single-phase electrical ratings
  - FSG:
    - 1.5 HP @ 115 Vac
    - 2 HP @ 230 Vac
  - FRG:
    - 1 HP @ 115 Vac
    - 1 HP @ 230 Vac
  - FYG:
    - 2 HP @ 115 Vac
    - 3 HP @ 230 Vac
  - FHG:
    - 1.5 HP @ 115 Vac
    - 2 HP @ 230 Vac
  - GSG, GHG
    - 2 HP @ 115 Vac
    - 3 HP @ 230 Vac
    - 5 HP @ 460/575 Vac
- Additional features defined
  - Maintained manual cut-out lever has two positions: AUTO-switch operates on rising and falling pressure; and OFF – contacts are held in the open or off position.
  - Low pressure cut-off operates at approximately 10 PSIG below the cut-in setting to stop the pump in the event it runs dry or a line breaks.
  - Pulsation plug enables the switch to operate on reciprocating pump without responding to the pressure spikes at the end of each piston stroke.
  - 2-way pressure relief valve releases head pressure on the compressor upon cut-off of the switch.
  - CP: clamshell package, BP: box packaging.

Catalog #	UPC Code	Cut-Out Setting (PSIG)	Pressure Connection (NPSF Internal)	Additional Features*
<b>Air Compressor Pressure Switches – Type FHG*</b>				
<b>Standard Action: Contacts Open On Rising Pressure; 2-Pole, NEMA 1</b>				
FHG2J27BP	0-47569-11543-1	100	1/4"	—
FHG2J27CP	0-47569-17822-1	100	1/4"	—
FHG2J27XCP	0-47569-17823-8	100	1/4"	2-way pressure relief
FHG12J52XBP	0-47569-11545-5	125	1/4"	2-way pressure relief
FHG12J52XCP	0-47569-17824-5	125	1/4"	2-way pressure relief
FHG12J55BP	Special Order	150	1/4"	—
FHG12J55CP	0-47569-17825-2	150	1/4"	—
FHG12J55XBP	0-47569-11547-9	150	1/4"	2-way pressure relief
FHG12J55XCP	0-47569-17826-9	150	1/4"	2-way pressure relief
9013FHG42J59	Special Order	175	1/4"	—
9013FHG42J59X	Special Order	175	1/4"	—
9013FHG49J59	Special Order	175	1/4" NPT External	—
9013FHG49J59X	Special Order	175	1/4" NPT External	2-way pressure relief
<b>Air Compressor Water Pump Pressure Switches – Type GHG, GSG**</b>				
<b>Standard Action: Contacts Open On Rising Pressure; 2-Pole, NEMA 1</b>				
9013GSG2J20	Special Order	40	1/4"	—
9013GSG2J21	Special Order	50	1/4"	—
9013GSG2J24	Special Order	60	1/4"	—
9013GSG2J25	Special Order	80	1/4"	—
9013GHG2J25	Special Order	80	1/4"	—
9013GHG2J29	Special Order	100	1/4"	—
9013GHG2J30	Special Order	100	1/4"	—
9013GHG2J53	Special Order	125	1/4"	—
9013GHG2J63	Special Order	175	1/4"	—
9013GHG2J30X	Special Order	100	1/4"	2-way pressure relief
9013GHG2J53X	Special Order	125	1/4"	2-way pressure relief
9013GHG2J63X	Special Order	175	1/4"	2-way pressure relief

\* FHG2 – 40-100 PSIG Cut-out Range, 20 PSIG Approx. Adjustable Differential▲

\* FHG12 – 70-150 PSIG Cut-out Range, 30 PSIG Approx. Adjustable Differential▲

\* FHG49 – 100-200 PSIG Cut-out Range, 40 PSIG Approx. Adjustable Differential▲

\*\* 9013GSG2 – 5-60 PSIG Cut-out Setting, 20-80 PSIG Cut-out Range, 15-30 PSIG Approx. Adjustable Differential▲

\*\* 9013GHG2 – 40-170 PSIG Cut-out Setting, 65-200 PSIG Cut-out Range, 20-40 PSIG Approx. Adjustable Differential▲

▲ Differential – the difference between cut-in and cut-out pressure.



Class 9013 Type GHG



Class 9013 Type FHG

**Pressure Switches**

Pumptrol Water Pump and Air Compressor Pressure Switches Class 9013

Schneider Electric Square D brand of pressure switches have set the standard for reliability, efficiency and durability. As the most trusted brand in residential, commercial and industrial pumping applications, Square D pressure switches continue to meet the daily needs of the water systems industry.

**High reliability**

- Rugged, robust construction provides a long life and provides years of uninterrupted, worry-free service
- Feature drift proof cut-in and cut-out settings
- Has visible vertical contacts, easy to inspect without removal
- Extra wide diaphragm orifice reduces clogging
- An extra strong frame that resists distortion when mounting the switch to a pipe or compressor
- Designed for the direct control of motors in pump and compressor applications. Water pump switches suitable for all types of pumps: jets, submersible, reciprocating, etc.
- Diaphragm actuated

**Models**

- Type FSG is the standard water pump switch
- Type FYG is designed to meet higher horsepower and pressure requirements
- Type FRG is reverse acting
- Type FHG for air compressors
- Type G for higher electrical ratings (water pumps and air compressors)



# Safety Switches, Surge Protection & Other Residential Products

## From the Beginning, the Safety Switch Leader

For more than 100 years, we've been the unchallenged leader in safety switches. Our Square D brand safety switches are preferred two to one over our closest competitor. We've continued our tradition of innovation, developing new features that provide an unsurpassed level of performance, reliability, safety and ease of installation.

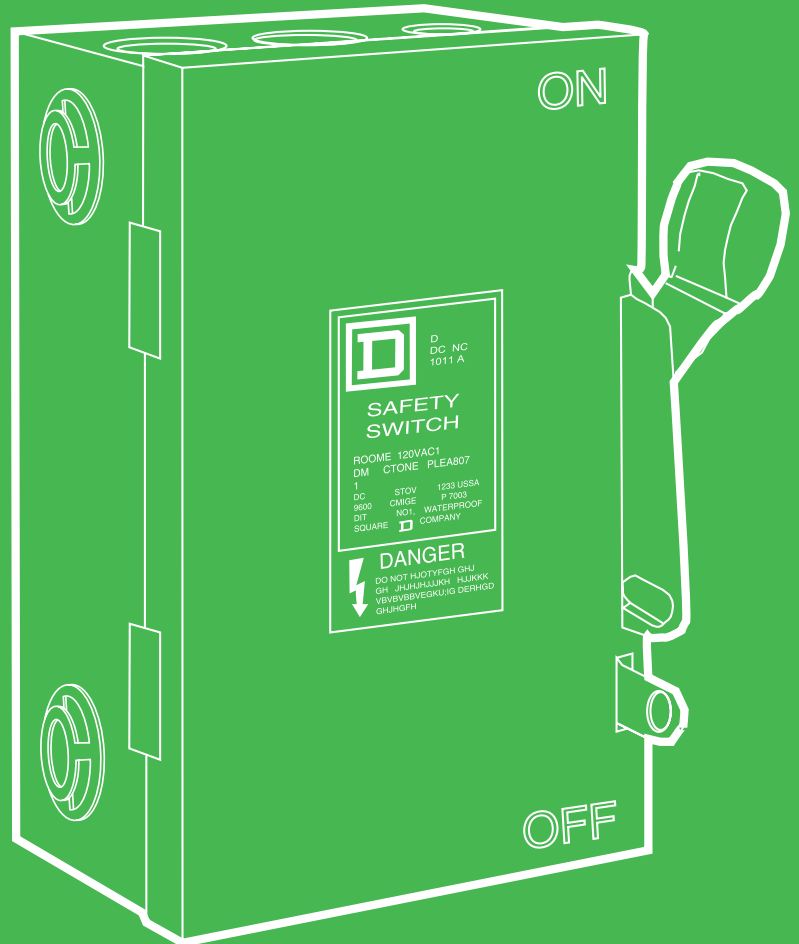

Square D introduced the enclosed safety switch back in 1909 and for more than 90 years we've been the unchallenged leader in safety switches.

# AC Disconnects & Switches – Light Duty

## Light and General Duty Switches Catalog Number Description

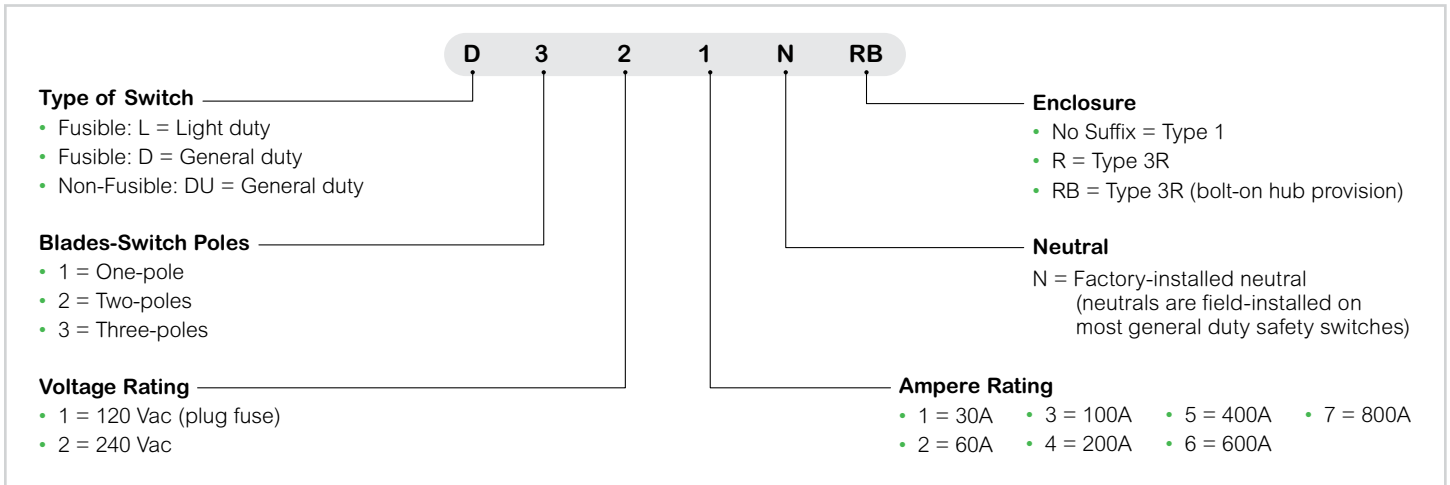

## AC Disconnects

Amps	Catalog #	UPC Code	Maximum Horsepower	Add'l Access	UPC Code
<b>Not Fusible AC Disconnects – Enclosed Molded Case Switch</b>					
60	QO200TRCP	0-47569-51769-3	10	PKHB	7-85901-11935-7
<b>Non-Metallic</b>			<b>UPC Code</b>		
QO200TRNM			7-85901-32801-8		

## AC Disconnects and Switches

### AC Disconnects

- UL Listed
- 2 Wire
- 240 Vac
- Rainproof

### Light Duty Enclosed Switches

- UL Listed
- 10kA Short Circuit Current Rating
- 120/240 Vac

## Light Duty Switches

Amps	Fuse Type▼	System	Catalog #	UPC Code	Horsepower Rating
<b>Fusible AC Disconnects – Pullout and Fuseholder▼</b>					
30	Plug	2-Wire	L111N*	7-85901-11548-9	—
	Plug	3-Wire	L211N*	7-85901-09052-6	3 HP @ 240 Vac
	Cartridge	3-Wire	L221N▲	7-85901-49902-2	3 HP @ 240 Vac

- Suitable for use on systems with up to 10k RMS symmetrical amps with available fault current at 240 Vac max. when protected by a fuse or circuit breaker rated 60A or less.

- Bracket for QO200TR used for stucco, aluminum and vinyl siding available (Catalog No. PKHB/UPC Code 0-47569-11935-7).

- Does not contain overcurrent protection.

- Fuses not included.

- \* 10kA short circuit rating with plug fuses.

- ▲ 10kA short circuit rating with Class H fuses.



L211N



QO200TRNM



QO200TR

## Switches – General Duty

Amps	Fuse Type	Indoor Unit Catalog #	UPC Code	Rainproof Unit Catalog #*	UPC Code
<b>Fusible Safety Switches – 2-Pole, 3-Wire (2 Blades and Fuseholders, 1 Solid Neutral) 120/240 Vac (Plug), 240 Vac (Cartridge) Maximum</b>					
30	Plug	D211NCP <sup>●▼</sup>	0-47569-52154-6	D211NRBCP <sup>●▼</sup>	0-47569-52160-7
	Cartridge	D221NCP <sup>●</sup>	0-47569-52155-3	D221NRBCP <sup>●</sup>	0-47569-52161-4
60	Cartridge	D222NCP <sup>★</sup>	0-47569-52156-0	D222NRBCP <sup>★</sup>	0-47569-52162-1
100	Cartridge	D223N <sup>†</sup>	7-85901-46068-8	D223NRB <sup>†</sup>	7-85901-46070-1
<b>Fusible Safety Switches – 3-Pole, 4-Wire (3 Blades and Fuseholders, 1 Solid Neutral) 240 Vac Maximum</b>					
30	Cartridge	D321NCP <sup>●</sup>	7-85901-07189-1	D321NRBCP <sup>●</sup>	7-85901-07190-7
60	Cartridge	D322N <sup>★</sup>	7-85901-46123-4	D322NRB <sup>★</sup>	7-85901-46128-9
100	Cartridge	D323N <sup>†</sup>	7-85901-46135-7	D323NRB <sup>†</sup>	7-85901-46140-1
<b>Not Fusible Safety Switches – 2-Pole, 2-Wire (2 Blades) 240 Vac Maximum</b>					
30	—	—	—	DU221RBUP <sup>●</sup>	7-85901-66562-5
60	—	—	—	QO260NATR <sup>★●▼</sup>	7-85901-62887-3
	—	QO260NATS <sup>★●▼</sup>	7-85901-62886-6	DU222RBUP <sup>●</sup>	7-85901-59167-2
100	—	QO2000NS <sup>●▼</sup>	7-85901-53952-0	QO2000NRB <sup>●▼</sup>	7-85901-53953-7
<b>Not Fusible Safety Switches – 3-Pole, 3-Wire (3 Blades) 240 Vac Maximum</b>					
30	—	DU321 <sup>●</sup>	7-85901-49160-6	DU321RB <sup>●</sup>	7-85901-49162-0
60	—	DU322 <sup>●</sup>	7-85901-49174-3	DU322RB <sup>●</sup>	7-85901-49176-7
100	—	DU323 <sup>†</sup>	7-85901-49180-4	DU323RB <sup>▼</sup>	7-85901-49182-8

### General Duty Safety Switches

- UL Listed
- 10kA Short Circuit Withstand Rating with Proper Fuses Installed
- NEMA TYPE 1 Indoor
- NEMA Type 3RB Rainproof With Bolt On Hub Provision

● Enclosed molded case switch, not suitable for service equipment.

□ Includes ground bar kit, factory installed.

■ Includes solid neutral, factory installed.

\* For bolt-on hubs, refer to Page 23.

● For field installable service ground bar kit order PK3GTA-1.

† For field installable service ground bar kit order GTK0610.

★ For field installable service ground bar kit order GTK03.

▼ 10kA short circuit current rating.



D223N



D322N



DU222RBUP

# Switches – Circuit Breaker Enclosures

Amps	Service Vac	General Purpose Catalog #	UPC Code	Rainproof Catalog #	UPC Code	Box #	Circuit Breakers (order separately)	
							Amps	Catalog #
<b>Enclosed Circuit Breakers (Includes factory installed circuit breakers)</b>							<i>(see pg. 22-23)</i>	
100	120/240	—	—	QO2100NRBCP	0-47569-51762-4	12R	—	—
200	120/240	—	—	QOM2E2200NRB	7-85901-37530-2	13R	—	—
<b>Circuit Breaker Enclosures (circuit breakers not included: order QO and QO-GFCI breakers)</b>								
100	120/240	QO2100BNS+	7-85901-05172-5	QO2100BNRB	7-85901-05174-9	17, 12R	—	—
	120/240	QO2100BNF+	7-85901-05173-2	—	—	17	—	—
	240	QO3100BNF+	7-85901-05175-6	QO3100BNRB+	7-85901-05177-0	17, 12R	—	—
	240	QO3100BNS+	7-85901-05176-3	—	—	17	—	—
125	120/240	QO2125BNF+	7-85901-05178-7	QO2125BNRB	7-85901-05180-0	22, 15R	—	—
	120/240	QO2125BNS+	7-85901-05179-4	—	—	22	—	—
<b>Q-Frame Enclosures &amp; Circuit Breakers (circuit breakers not included: enclosure only)</b>								
—	—	—	—	—	—	—	100	QBL22100
—	—	—	—	—	—	—	110	QBL22110
—	—	—	—	—	—	—	125	QBL22125
—	240 – 2-Pole	Q2-2200NS	7-85901-78544-0	Q2-2200NRB	7-85901-78545-3	24, 13R	150	QBL22150
—	—	—	—	—	—	—	175	QBL22175
—	—	—	—	—	—	—	200	QBL22200
—	240 – 3-Pole	Q2-3225NF	7-85901-47060-1	Q2-3225NRB	7-85901-47062-5	25, 14R	100	QBL32100
—	240 – 3-Pole	Q2-3225NS	7-85901-47061-8	—	—	25	110	QBL32110
—	—	—	—	—	—	—	125	QBL32125
—	—	—	—	—	—	—	150	QBL32150
—	—	—	—	—	—	—	175	QBL32175
—	—	—	—	—	—	—	200	QBL32200
—	—	—	—	—	—	—	225	QBL32225



QO2100NRB



QOM2E2200NRB

## Circuit Breaker Enclosures

- UL Listed

- All breakers rated at 10k AIC.
- For ground bar kit order PKOGTA-2.
- Accepts 200A max. 2-pole Q-Frame breakers.
- ▲ Factory-installed groundable neutral assembly included (2) ground lugs and (2) neutral lugs. Equipment ground kit PKOGTA-2 also included.
- ✦ Item may require additional lead time.

## Whole House Surge Protection

Type	Catalog #	UPC Code	Surge Current (Per Phase)	Surgeologic Warranty/Down Stream Equipment Protection
<b>Hardwire Secondary Surge Arrester</b>				
Indoor/Outdoor	SDSA1175	7-85901-21087-0	36kA	Standard equipment warranty
<b>Surgebreaker® Surge Protective Device</b>				
QO	QO2175SB	7-85901-21089-4	22.5kA	\$10,000/3 year warranty
Homeline	HOM2175SB	7-85901-21090-0	22.5kA	\$10,000/3 year warranty
<b>Home Electronics Protective Device</b>				
Indoor/Outdoor	HEPD50*	7-85901-00662-6	50kA	\$50,000/3 year down stream warranty
Indoor/Outdoor	HEPD80	7-85901-00872-9	80kA	\$75,000/5 year down stream warranty
Indoor/Outdoor	HEPD80 (Clamshell)	7-85901-11283-9	80kA	\$75,000/5 year down stream warranty
<b>Surgebreaker Plus</b>				
Indoor	SDSB80111	7-85901-98058-2	80kA	\$100,000/5 year warranty and tel/cable protection

\*Available 2017

### Hard-Wire Whole House Surge Protective Device (SDSA1175)

- Suitable for Indoor and Outdoor Applications
- Suitable for Use in Service Entrance Locations: Meets Requirements of NEC Article 280
- Protects from Electrical Surges up to 36kA
- 150Vac Phase-to-Ground Maximum
- Equal Protection to all Circuits and Receptacles throughout the Home
- UL Listed 1449, 3rd Edition and CSA Certified



### Surgebreaker for QO (QO2175SB) and Homeline (HOM2175SB)

- QO2175SB for QO load centers, combination devices and and NQ panelboards
- HOM2175SB for Homeline load centers and combination devices
- Plug-on design requires two pole spaces
- LED indicates operational status
- 22.5 kA per phase
- UL Listed 1449, 3rd Edition and CSA Certified
- 3 Year/\$10,000 Connected Equipment Limited Warranty



### Home Electronics Protective Device (HEPD50, HEPD80)

- Small, affordable whole house surge suppression that can easily be mounted to Square D and competitors load centers
- Suitable for installing indoors or outdoors: NEMA 4X Rated
- Easy-to-install, optional flush mount kit for a professional look when installed in a finished wall (HEPD50MKF, HEPD80MKF)
- Longer service life and suppression of high-energy surges: 50 kA (HEPD50) and 80 kA (HEPD80) per phase maximum surge current
- LED Status Indicator
- 3 Year/\$50,000 (HEPD50) or 5 Year/\$75,000 (HEPD80) Connected Equipment Limited Warranty
- HEPD50: Type 2 Surge Protective Device. HEPD80: Type 1 Surge Protective Device
- UL Listed 1449, 3rd Edition and CSA Certified



### Surgebreaker Plus Whole House Surge Protector (SDSB80111)

- Compact design requires minimal space
- Includes HEPD80 for long lasting protection against more powerful surges, up to 80 kA and offers 120/240V AC voltage protection
- Whole house protection including appliances, HVAC, lighting, cable, Ethernet, and telephone
- 5 Year/\$100,000 Connected Equipment Limited Warranty
- Removable modules (cable, Ethernet, and telephone) allow quick and easy installation customization
- UL Listed 1449, 3rd edition





# Generator Panels

Indoor Generator Panel			
Amps	Catalog #	Ground Bar	UPC Code
30	QO48M30DSGP	PK7GTA	7-85901-86820-0
60	QO48M60DSGP	PK7GTA	7-85901-82434-3

Outdoor Generator Transfer Switch Panel				
Load Center Amps	Generator Main Amps	Catalog #	Power Inlet Type (included)	UPC Code
100	20	QO1DM10020TRBR	NEMA L14-20	7-85901-62331-1
	30	QO1DM10030TRBR	NEMA L14-30P	7-85901-88322-7
	50	QO1DM10050TRBR	Hubbell CS6375	7-85901-46880-6

Generator Interlock Kit				
Brand	Amp Rating	Catalog #	Indoor/Outdoor	UPC Code
QO	100-125A	QOCRBGK1C	Indoor - Outdoor	7-85901-61092-2
QO	150-225A	QOCGK2C*	Indoor	7-85901-48900-9
QO	150-225A	QORBGK2C	Outdoor	7-85901-61679-5
Homeline	100-125A	HOMCRBGK1C	Indoor-Outdoor	7-85901-59843-5
Homeline	150-225A	HOMCGK2C*	Indoor	7-85901-94050-0
Homeline	150-225A	HOMRBGK2C	Outdoor	7-85901-23316-9

\* Exceptions: Older Series S1 Outdoor

## Generator Panel

- Allows connection of up to eight circuits to a standby power source
- Safely switch from utility power to a standby power source with the flip of a switch on two QO main circuit breakers
- Mechanical interlock ensures that only one main circuit breaker is in the "ON" position at any time
- Uses eight genuine QO circuit breakers from Square D – "The World's Finest"
- 4 spaces/ 8 circuits max

## Generator Interlock Kit

- Direct generator power to any circuit within the home
- Interlocks the QOM1 and QOM2 main breaker with a 2-pole breaker back-fed from a generator
- No need for separate generator panel



QO48M30DSGP



Generator Interlock Kit (In use)

# Advanced Products

Today's consumers are seeking ways to simplify and enhance their quality of life with products and services that suit their individual needs. For the first time, digital technology enables them to make their homes smarter, more energy efficient and controllable through products, software and services from Schneider Electric. Finding an easy plug and play solution that empowers them to monitor and adjust energy, fuel their electric vehicles, and much more.



Life Is On



# Wiser Air – The smart thermostat, made Wiser.

## Make the Wiser choice

Wiser Air™ is a home energy management solution that gives homeowners peace of mind through effortless control of comfort and savings.



### My Wiser

Designed to seamlessly fit your life with Simple Schedules and Ready Modes.

### Sleek, Intuitive Design

The familiar, and informative, touch screen display makes interaction simple while Wiser Pulse emits a soft glow that indicates how the system is running.

### Innovative Features

Wiser Air is packed with technology that drives friendly and unique features such as Comfort Boost to bring maximum comfort through just the touch of a button.

### Eco IQ

Enable EcoIQ to let Wiser maximize the efficiency of the system based on the specific home and lifestyle; without sacrificing comfort.

*\* Features available in select areas.*

### Built in #1 Ranked Weather Service

With Wiser Forecast, Wiser Air adapts to what's happening outside using the #1 ranked weather service from Schneider Electric.

### Auto Updates

Peace of mind, all the time. Wiser Air stays up-to-date through automatic updates that provide additional features and enhancements.



## Make the Wiser choice.

Wiser Air is a home energy management solution that gives homeowners peace of mind through effortless control of comfort and savings.

## Residential energy management

Wiser Air provides streamlined remote access across all major platforms. Be in control from anywhere at anytime.



### Works with most common systems

- Forced air, radiant, heat pump (including geothermal), oil, gas and electric
- Up to 3 stages of heating
- Up to 2 stages of cooling

### Ordering Information

• WISERAIR10BLKUS – Black

• WISERAIR10WHTUS – White

### Wiser Air Specifications

<b>Unit Dimensions</b>	<ul style="list-style-type: none"> <li>• 4in (10.2cm) H</li> <li>• 4in (10.2cm) W</li> <li>• 1.2in (3cm) D</li> </ul>	<b>Wire Gauge</b>	18 to 22 AWG (0.33 to 0.82mm <sup>2</sup> )
<b>Trim Plate Dimensions</b>	<ul style="list-style-type: none"> <li>• 4.8in (12.2cm) H</li> <li>• 6.3in (16cm) W</li> <li>• 0.1in (0.3cm) D</li> </ul>	<b>Temperature</b>	<ul style="list-style-type: none"> <li>• Resolution: 1°F (0.5°C)</li> <li>• Control Accuracy: 1°F (0.5°C)</li> <li>• Cooling Setpoint Range: 48°F to 95°F (9°C to 35°C)</li> <li>• Heating Setpoint Range: 45.5°F to 92°F (7.5°C to 33°C)</li> <li>• Display Range: 40°F to 95°F (5°C to 35°C)</li> <li>• Remote Sensor Compatibility: 10k NTC, Type 2</li> </ul>
<b>Shipping Weight</b>	1.32lb (599g)	<b>Humidity Sensor</b>	<ul style="list-style-type: none"> <li>• Manufacturer Calibrated: not required</li> <li>• Precision: RH +/-3%</li> <li>• Dehumidification range: N/A</li> </ul>
<b>Screen</b>	<ul style="list-style-type: none"> <li>• 5.4cm (2.1in) H</li> <li>• 7.2cm (2.8in) W</li> <li>• 640 x 480 RGB</li> </ul>	<b>Light Sensor</b>	Application: LCD — Auto dim
<b>Power Requirements</b>	<ul style="list-style-type: none"> <li>• Input: 24Vac (+/-15%), 50/60Hz</li> <li>• Consumption: 6VA</li> <li>• Maximum rating: 100VA, 4.17A</li> <li>• Class 2 circuits only</li> </ul>	<b>Occupancy Sensor</b>	<ul style="list-style-type: none"> <li>• Application: LCD wake-up</li> <li>• Wiser Pulse intensity</li> </ul>
<b>Output Ratings</b>	<ul style="list-style-type: none"> <li>• Maximum output: 94VA</li> <li>• Relay rating: ~24Vac, 50/60Hz, 1A</li> <li>• In-rush = 3A</li> <li>• Connections: G, W, W2, Y, Y2, U, O/B</li> <li>• Class 2 circuits only</li> </ul>	<b>Safety Standards</b>	<ul style="list-style-type: none"> <li>• UL 873</li> <li>• CSA C22.2 No. 24-93</li> </ul>
<b>Operating Conditions</b>	<ul style="list-style-type: none"> <li>• Temperature: 32°F to 104°F (0°C to 40°C)</li> <li>• Humidity: 0% to 75% R.H. non-condensing</li> </ul>	<b>EMC and Radio Standards</b>	<ul style="list-style-type: none"> <li>• EMC: FCC 15 Subpart B</li> <li>• ICES-003</li> <li>• Radio: FCC 15 Subpart C</li> <li>• RSS 210</li> </ul>
<b>Storage Conditions</b>	<ul style="list-style-type: none"> <li>• Temperature: -22°F to 122°F (-30°C to 50°C)</li> <li>• Humidity: 0% to 75% R.H. non-condensing Indoor, Dry, Pollution Degree 2</li> </ul>	<b>Network</b>	<ul style="list-style-type: none"> <li>• ZigBee (on-board)</li> <li>• Wi-Fi (802.11 b/g/n, 2.4GHz)</li> <li>• Open ADR ready</li> </ul>



# EVlink Charging Solutions

## EVlink Electric Vehicle Charging Stations

EVlink™ Electric Vehicle Supply Equipment (EVSE) provides power to recharge the on-board vehicle batteries in Electric Vehicles (EV) and Plug-in Hybrid Electric Vehicles (PHEV).

The EVSE units are Level 2 type which can charge the vehicle batteries in as little as 3–6 hours, depending on the vehicle type and level of battery charge. The EVSE will typically be fed from a 208 or 240 V source, two-pole 40A circuit breaker or disconnect and will be able to provide 30A of current to the vehicle's on-board charger. All units meet or exceed SAE J1772<sup>[1]</sup> and UL standards for electric vehicle supply equipment.

### Schneider Electric EVSE features include:

- Integral Ground Fault Protection at 20 mA
- User friendly interface to indicate power on/off, charging, system detected faults etc.
- Heavy duty cord and connector which meet SAE J1772 standards
- Automatic reset and restart after ground fault or main power loss

### EVlink charging Station

- Charging Station with advanced communications and networking
- DC fast charging station which can charge 80% of EV in less than 30 minutes

Please stay tuned at [www.schneider-electric.us/go/evlink](http://www.schneider-electric.us/go/evlink)

<sup>[1]</sup> SAE J1772—standard for Electric Vehicles that defines common connectors and interfaces at various power levels for PHEV and EV established by Society of Automotive Engineers for North America.

## Indoor Charging Station

Input Voltage System	Application	Output Current	Mounting	Number of Charging Units	Catalog Number
208–240 Vac	Indoor	30 A <sup>[1]</sup>	Wall	Single	EV230WS

# Indoor Charging Stations

The diagram illustrates the components of an indoor EV charging station. On the left is a close-up of the user interface, which includes a segmented progress indicator, a stop button, power status indicators, and a delay button. The main unit is a white, wall-mounted enclosure with a green accent. A black cable is held in a separate white cable holder, and the charging cable ends in a white SAE J1772 connector.

**Enclosure:**

- Non-metallic
- Indoor wall-mount (stud, drywall, or masonry wall)

**Cable Holder:**

- Supports and helps organize the cable
- Mounted independently from the enclosure

**Connector and Cord:**

- Complies with SAE J1772
- Cable length: 18 ft. (5.5 m)

**Interface:**

- Segmented charge and delay charge progress indicator
- Stop button and indicator
- Power status and system detected fault indicator
- Delay button and indicator

**Protection:**

- Integral Ground Fault Protection at 20 mA
- Ground fault function tested before each charge cycle begins
- Auto restart after ground fault or main power loss

# Outdoor Charging Stations

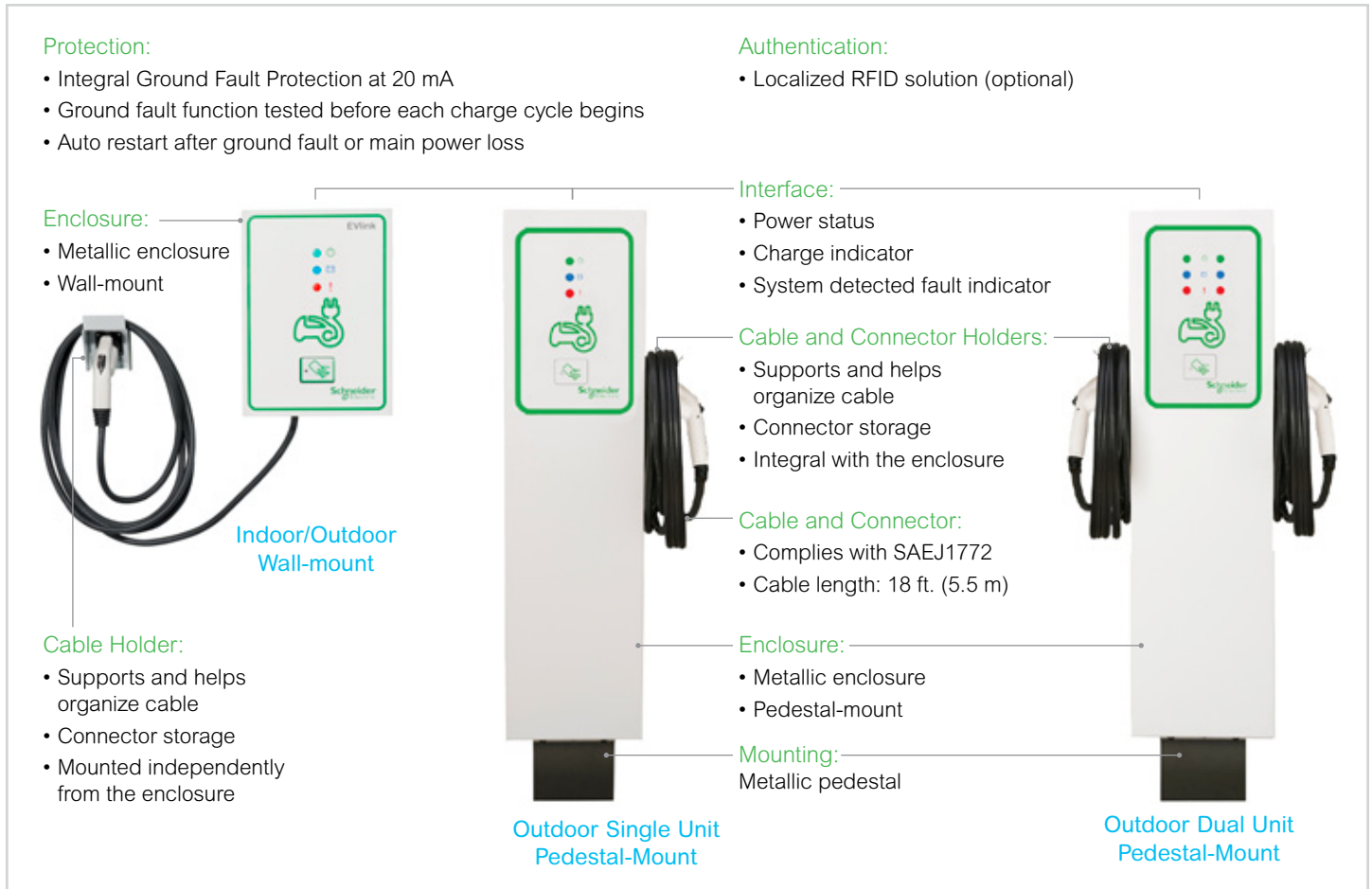

## Outdoor Charging Stations

Output Voltage System	Application	Output Current	Mounting	Enclosure Type	Number of Charging Units	Catalog Number
208–240 Vac	Indoor/Outdoor	30 A <sup>[3]</sup>	Wall	3R	Single	EV230WSR
208–240 Vac	Outdoor	30 A <sup>[3]</sup>	Pedestal	3R	Single	EV230PSR
208–240 Vac	Outdoor	30 A <sup>[3]</sup>	Pedestal	3R	Dual <sup>[4]</sup>	EV230PDR

## Outdoor Charging Stations with RFID Accessories

Output Voltage System	Application	Output Current	Mounting	Enclosure Type	Number of Charging Units	Catalog Number
208–240 Vac	Indoor/Outdoor	30 A <sup>[3]</sup>	Wall	3R	Single	EV230WSRR
208–240 Vac	Outdoor	30 A <sup>[3]</sup>	Pedestal	3R	Single	EV230PSRR
208–240 Vac	Outdoor	30 A <sup>[3]</sup>	Pedestal	3R	Dual <sup>[5]</sup>	EV230PDRR



EVRFIDHP

## RFID Authentication Cards (for Applicable Level 2 Charging Stations only)<sup>[6]</sup>

Description	Catalog Number
RFID Handheld Programmer	EVRFIDHP
RFID Authentication Cards (Quantity of 10)	EVRFIDKF10



EVRFIDKF10

<sup>[3]</sup> Feeder circuit breaker size = 40 A

<sup>[4]</sup> Output current per charge unit.

<sup>[5]</sup> Output current per charge unit.

<sup>[6]</sup> Required for charging stations with RFID Accessories.

# EVlink Electric Vehicle Charging Stations Dimensions

Dimension: in. (mm)

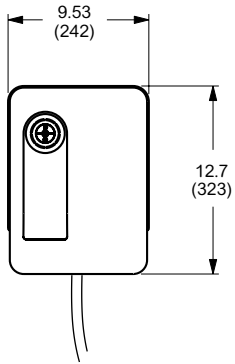
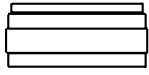

Indoor Wall-mount

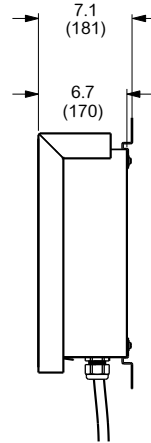
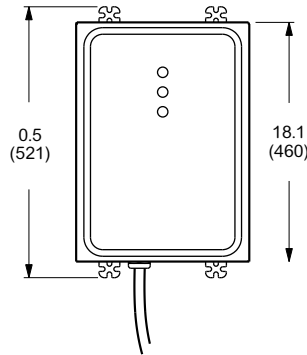
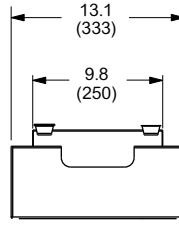

Indoor/Outdoor Wall-mount

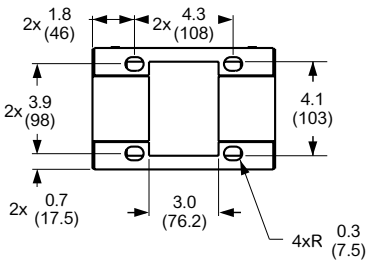
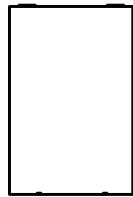
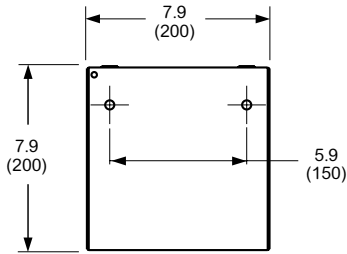

Bottom View

Pedestal Base

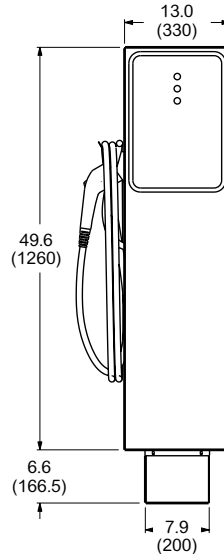
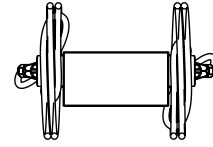
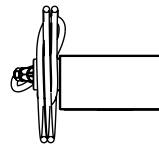

Single Unit

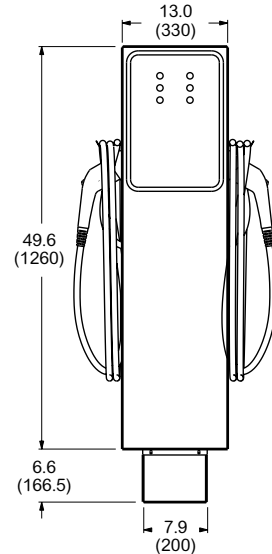

Dual Unit

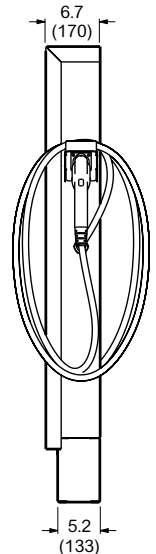

Pedestal-Mounted Charging Stations





Control panel of the Schneider Electric charging station, featuring a green border, a green logo, and the text "Schneider Electric".

# Important Information

# Product Warranty

## Square D/Schneider Electric Residential Products Limited Warranty

Schneider Electric warrants equipment manufactured by it and sold through authorized sales channels to be free from defects in materials and workmanship. The duration of the warranty is specified in Seller's technical library. The warranty starts from the date of invoice of the products. If the invoice date of the relevant products cannot be determined for any reason whatsoever, the warranty starts as of the manufacturing date code that is specified on each product, in which case the duration of the warranty as specified in Seller's technical library will be extended by 6 months. If within such period any such equipment shall be proved to Schneider Electric's satisfaction to be non-conforming, such equipment shall be repaired or replaced at Schneider Electric's option. This warranty shall not apply (a) to equipment not manufactured by Schneider Electric, (b) to equipment that has been repaired or altered by other than Schneider Electric so as, in its judgment, to affect the same adversely, or (c) to equipment that has been subjected to negligence, accident, or damage by circumstances beyond Schneider Electric's control, or improper operation, maintenance or storage, or to other than normal use or service. With respect to equipment not manufactured by Schneider Electric, the warranty obligations of Schneider Electric shall in all respects conform and be limited to the warranty actually extended to Schneider Electric by its supplier.

Nonconforming products must be returned at Schneider Electric's expense for evaluation unless this is waived in writing. Replacement products may be new or reconditioned. The foregoing warranties do not cover reimbursement for labor, transportation, removal, installation, temporary power, or any other expenses that may be incurred in connection with repair or replacement. The repairing of, changes to, or replacement of the product or part of it during the warranty period shall in no case cause the product-warranty period to be extended. Warranty is voided on genuine Schneider Electric products if they are reconditioned. There is no warranty on counterfeit products.



## Questions?

Call Our Customer Care Center at: 1-888-SQUARED (888-778-2733)



Life Is On



by Schneider Electric

**Schneider Electric USA, Inc.**

800 Federal Street  
Andover, MA 01810  
888 SQUARED (888 778 2733)

[www.schneider-electric.com/us](http://www.schneider-electric.com/us)

