

# PowerPacT™ H-, J-, and L-Frame Circuit Breakers

0611CT1001

Catalog

09/2024



# Legal Information

The information provided in this document contains general descriptions, technical characteristics and/or recommendations related to products/solutions.

This document is not intended as a substitute for a detailed study or operational and site-specific development or schematic plan. It is not to be used for determining suitability or reliability of the products/solutions for specific user applications. It is the duty of any such user to perform or have any professional expert of its choice (integrator, specifier or the like) perform the appropriate and comprehensive risk analysis, evaluation and testing of the products/solutions with respect to the relevant specific application or use thereof.

The Schneider Electric brand and any trademarks of Schneider Electric SE and its subsidiaries referred to in this document are the property of Schneider Electric SE or its subsidiaries. All other brands may be trademarks of their respective owner.

This document and its content are protected under applicable copyright laws and provided for informative use only. No part of this document may be reproduced or transmitted in any form or by any means (electronic, mechanical, photocopying, recording, or otherwise), for any purpose, without the prior written permission of Schneider Electric.

Schneider Electric does not grant any right or license for commercial use of the document or its content, except for a non-exclusive and personal license to consult it on an "as is" basis.

Schneider Electric reserves the right to make changes or updates with respect to or in the content of this document or the format thereof, at any time without notice.

**To the extent permitted by applicable law, no responsibility or liability is assumed by Schneider Electric and its subsidiaries for any errors or omissions in the informational content of this document, as well as any non-intended use or misuse of the content thereof.**

Schneider Electric, EverLink, Green Premium, I-Line, MicroLogic, PowerPacT and Square D are trademarks and the property of Schneider Electric SE, its subsidiaries and affiliated companies. All other trademarks are the property of their respective owners.



# Table of Contents

- Catalog Numbering ..... 9
  - PowerPacT with MicroLogic™ Trip Units ..... 9
  - Direct Access to Energy Management ..... 9
  - Catalog Numbering ..... 10
    - Circuit Breaker Catalog Numbers..... 10
    - Interrupting Rating ..... 11
    - Trip Unit Numbering..... 12
    - Accessory Suffix Codes ..... 13
- General Information ..... 16
  - Applications ..... 16
  - Mission Critical Circuit Breakers ..... 18
    - Theory of Operation..... 18
    - Trip Units and Trip Curves ..... 19
  - Flexible Configurations ..... 20
    - Field Installable Accessories and Trip Units ..... 20
  - General Characteristics ..... 21
    - Faceplate Label..... 21
    - Codes and Standards ..... 21
    - Vibration ..... 22
    - Electromagnetic Disturbances ..... 22
    - Tropicalization ..... 23
    - Special Ratings ..... 23
    - Marine Ratings ..... 23
    - UL 489 SC Listed 500 Vdc Circuit Breakers ..... 24
    - PowerPacT H-, J-, and L-frame Circuit Breaker Trip Units ..... 31
- Circuit Breakers ..... 33
  - Dual-Break Rotating Contacts ..... 33
  - High Ampere Interrupting Ratings (AIR) ..... 34
  - Internal Operating Mechanism ..... 34
  - Handle Position Indication..... 34
  - Visi-Trip Breaker Locator ..... 35
  - Circuit Breaker Ratings..... 35
    - Reverse Feeding of Circuit Breakers ..... 35
    - Current-Limiting ..... 36
      - 100% Rated ..... 36
      - Corner-Grounded Delta Ratings (1Ø-3Ø) ..... 37
  - Special Applications ..... 38
    - Protection of Industrial Control Panels..... 38
    - 400 Hz Applications ..... 38
  - H- and J-Frame Catalog Numbers ..... 41
    - Unit-Mount Circuit Breaker Catalog Numbers ..... 41
    - I-Line Circuit Breaker Catalog Numbers ..... 45
    - Circuit Breakers with Field-Interchangeable Trip Units ..... 49
  - L-Frame Circuit Breaker Catalog Numbers ..... 52

Unit-Mount Circuit Breaker Catalog Numbers .....	52
I-Line Circuit Breaker Catalog Numbers .....	54
Circuit Breakers with Field-Interchangeable Trip Units Catalog Numbers.....	56
<b>Automatic Switches .....</b>	<b>58</b>
Automatic Switch Functions .....	58
Motor Operator .....	58
Ground Fault Protection (H- and J-Frame Circuit Breakers Only).....	58
Automatic Switch Protection .....	58
Specifications .....	59
Catalog Numbers .....	62
<b>Motor Circuit Protection .....</b>	<b>64</b>
General Information.....	64
Motor Branch Circuit Protection Function .....	64
Switching .....	64
Basic Protection .....	64
Additional Electronic Protection .....	65
Trip Class of an Overload Relay Device .....	65
Asynchronous-Motor Starting Parameters.....	65
Motor-Feeder Solutions .....	65
PowerPacT H-, J-, and L-Frame with MicroLogic Trip Units Motor- Protection Range.....	66
Electronic Motor Circuit Protectors (AC Only) .....	67
Full Load Ampere Settings .....	67
Automatic Protection Settings.....	68
Manual Protection Settings.....	68
MicroLogic 1.3 M Electronic Trip Units for Instantaneous Protection Only (L- Frame Circuit Breakers Only).....	71
Protection Version .....	71
Indications .....	71
MicroLogic 2.2 M and 2.3 M Electronic Trip Units.....	73
Overloads (or Thermal Protection) .....	73
Trip Class .....	73
Short Circuits .....	73
Phase Unbalance or Phase Loss ( $I_{unbal}$ ).....	74
Indications .....	74
MicroLogic 2.2 M and 2.3 M Electronic Trip Unit.....	75
Additional Technical Characteristics .....	76
<b>Energy Management.....</b>	<b>78</b>
Energy Management Using the Smart System.....	78
Measure .....	78
Connect.....	79
Save.....	79
Smart System Communication Components .....	80
PowerPacT Circuit Breakers with MicroLogic Trip Units .....	80
Displays.....	80
Communication .....	81

Power Meter Functions .....	81
Display Functions .....	81
MicroLogic Trip Unit LCD .....	81
FDM121 Display Unit (One to One) .....	82
FDM128 Display Unit (One to Eight) .....	82
Measurement Functions .....	83
Instantaneous RMS Measurements .....	83
Maximum / Minimum Ammeter .....	83
Energy Metering .....	83
Demand and Maximum Demand Values .....	83
Power Quality .....	83
Additional Technical Characteristics .....	85
Operating-Assistance Functions Characteristics .....	86
Motor Circuit Protectors (AC Only) .....	90
FDM121 Display .....	91
Display of MicroLogic Trip Unit Measurements and Alarms .....	91
Status Indications and Remote Control .....	92
Main Characteristics .....	92
Mounting .....	92
Connection .....	93
Navigation .....	93
Screens .....	94
Communication Components and FDM121 Connections .....	95
FDM128 Display .....	96
Display of MicroLogic Trip Unit Measurements and Trips .....	96
Status Indications .....	96
Remote Control .....	96
Main Characteristics .....	97
Mounting .....	97
Connection .....	97
Navigation .....	97
Screens .....	98
Communication Components and FDM128 Connections .....	98
Trip Units .....	102
Available Trip Units .....	102
Protection of Distribution Systems .....	105
Thermal-Magnetic Trip Units .....	105
MicroLogic 3 Trip Units .....	106
MicroLogic 5/6 A or E Trip Units .....	109
Smart System Communication Wiring System .....	117
Wiring System ULP .....	117
Smart System Communication Wiring System Modbus Direct .....	118
Four Functional Levels .....	119
Modbus Principle .....	120
Ethernet Principle .....	120
IFE Ethernet Interface .....	121
IFE Interface, IFE Interface + Gateway Description .....	121

Mounting .....	121
24 Vdc Power Supply.....	122
Required Circuit Breaker Communication Modules .....	122
IFM Modbus Communication Interface.....	125
Function .....	125
Characteristics .....	126
Technical Characteristics .....	127
Simplified IFM Installation .....	128
I/O Application Module.....	129
Description.....	129
I/O (Input/Output) Application Module for Low-Voltage Circuit Breaker.....	129
Pre-Defined Application .....	129
User-Defined Applications.....	130
Mounting .....	130
Application Rotary Switch.....	130
Setting Locking Pad.....	130
I/O Module Characteristics .....	131
EcoStruxure™ Power Commission Software.....	133
Introduction.....	133
Compatible Devices (Configuration and Device Management) .....	133
Features .....	133
<b>Accessories for MicroLogic Trip Units .....</b>	<b>135</b>
NSX Cord .....	135
Breaker Status and Control Module (BSCM) Modbus SL or ULP.....	135
Modbus Serial Hub.....	136
24 Vdc Power Supply Terminal Block.....	137
External 24 Vdc Power Supply Module .....	137
Battery Module.....	138
Pocket Tester.....	138
Isolated Modbus Repeater Module .....	139
Service Interface (SI).....	139
Universal Logic Plug.....	140
External Neutral Current Transformer (ENCT) .....	141
External Neutral Voltage Tap (ENVT) .....	141
Zone Selective Interlock (ZSI) Module .....	141
Wiring Harness .....	142
<b>Accessories and Auxiliaries .....</b>	<b>144</b>
Communication Network .....	145
Accessory Connections .....	150
Auxiliary and Alarm Indication Contacts .....	150
SDX and SDTAM Modules for MicroLogic Trip Units .....	152
SDx Module .....	152
SDTAM Module .....	153
Shunt Trip (MX) and Undervoltage Trip (MN) .....	154
Motor Operator .....	156
Add-On Ground-Fault Module (GFM) (H- and J-Frame Only).....	158

Earth Leakage Module (ELM) (H- and J-Frame Only).....	159
Factory-Installed ELMs .....	159
Rotary Operating Handles.....	160
Directly Mounted Rotary Operating Handles .....	160
Door-Mounted (Extended) Rotary Operating Handle .....	161
Class 9421 NEMA Door Mounted Rotary Operating Handles .....	162
H- and J-Frame Class 9421 Door-Mounted Operating Mechanism .....	162
Class 9422 Cable Operating Handle .....	163
Class 9422 Flange-Mounted Variable-Depth Operating Mechanism .....	164
Locking Systems .....	165
Manual Mechanical Interlocking System .....	166
Interlocking of Circuit Breakers with Toggle Control .....	166
Interlocking of Two Devices with Rotary Handles .....	168
Interlocking Devices using Keylocks (Captive Keys) .....	169
Sealing Accessory.....	170
Front-Panel Escutcheons.....	170
Toggle Collars (For Drawout Mounting).....	171
Toggle Boot .....	171
Handle Extension.....	172
Circuit Breaker Enclosures and Enclosure Accessories.....	172
Circuit Breaker Mounting and Connections .....	175
Mounting Configurations .....	175
Unit-Mount Circuit Breakers .....	176
I-Line Circuit Breakers .....	177
Plug-In Circuit Breaker Mounting .....	177
Connection .....	182
<b>Installation Recommendations .....</b>	<b>191</b>
Operation Conditions.....	191
Temperature Derating .....	191
Altitude Derating.....	193
Frequency Derating .....	193
Installation in Equipment.....	194
Power from the Top or Bottom .....	194
Weight.....	194
Safety Clearances and Minimum Distances.....	195
General Rules .....	195
Power Connections .....	195
Safety Clearance .....	195
Control Wiring.....	196
Remote Tripping by Undervoltage Trip (MN) or Shunt Trip (MX) .....	196
External Neutral Voltage Tap (ENVT) .....	196
External Neutral Current Transformer (ENCT) .....	197
24 Vdc Power Supply Module.....	198
<b>Wiring Diagrams .....</b>	<b>199</b>
Unit-Mount Circuit Breakers .....	199
Plug-In and Drawout Circuit Breakers .....	201
Motor Operator .....	203

---

PowerPacT H & J DC Wiring Diagrams .....	205
SDx Module with MicroLogic Trip Unit .....	206
SDTAM Module with MicroLogic M Trip Unit .....	207
<b>Circuit Breaker Dimensions .....</b>	<b>208</b>
Enclosures .....	208
PowerPacT H-Frame Circuit Breakers .....	209
PowerPacT J-Frame Circuit Breakers .....	213
PowerPacT H- and J-Frame Plug-In Circuit Breakers .....	216
PowerPacT H- and J-Frame Drawout Circuit Breakers .....	217
PowerPacT H- and J-Frame Circuit Breaker Mounting .....	218
PowerPacT H- and J-Frame Circuit Breaker Door Cutouts .....	219
PowerPacT L-Frame Circuit Breakers .....	222
PowerPacT L-Frame Plug-In and Drawout Mounting .....	224
PowerPacT L-Frame Circuit Breaker Handles and Handle Operators .....	226
PowerPacT L-Frame Circuit Breaker Front Accessories .....	229
PowerPacT L-Frame Circuit Breaker Interlocking Systems .....	230
PowerPacT L-Frame Circuit Breaker Connectors .....	231
<b>Accessory Dimensions .....</b>	<b>233</b>
<b>Trip Curves .....</b>	<b>237</b>
PowerPacT H- and J-Frame Thermal-Magnetic Trip Circuit Breakers .....	237
PowerPacT H- and J-Frame Thermal-Magnetic Trip MCP Instantaneous Trip Points .....	267
PowerPacT H-Frame Electronic Trip Circuit Breakers— 60/100/150 A Frame .....	270
PowerPacT J-Frame Electronic Trip Circuit Breakers—250 A Frame .....	278
PowerPacT L-Frame Electronic Trip Circuit Breakers— 250/400/600 A Frame .....	285

# Catalog Numbering

## PowerPacT with MicroLogic™ Trip Units

The PowerPacT H-, J-, and L-frame circuit breakers are designed to protect electrical systems from damage caused by overloads and short circuits. H- and J-frame circuit breakers are available with either thermal-magnetic or MicroLogic electronic trip units. L-frame circuit breakers are available with basic electronic or MicroLogic electronic trip units only.



## Direct Access to Energy Management

The new generation PowerPacT with MicroLogic circuit breakers set the standard with direct access to energy management. Integrated metering enhances their protective functions. For the first time, Schneider Electric users can monitor energy from 15 to 3000 A, offering new performance in a remarkably compact device.

- Smart – A meter in every breaker
- Safe – Combines safety and performance in one compact device
- Simple – To select, install, and use

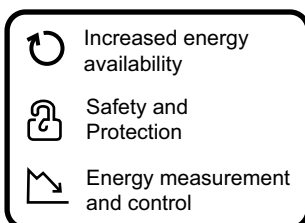

# Catalog Numbering

## Circuit Breaker Catalog Numbers

Segment	Character	Description	—	J	L	L	3	6	250	W	T	—	— — — —
Brand	—	Square D™											
	N	Schneider Electric											
Frame	H	H-Frame											
	J	J-Frame											
	L	L-Frame											
Performance Level (kA) See Interrupting Rating, page 11.													
Terminations	L	Lugs Line/Load Side											
	M	Lugs Line Side											
	P	Lugs Load Side											
	F	Bus Bar											
	A	A-Line											
	S	Rear Connected											
	N	Plug-in											
	D	Drawout											
Poles	K	Reverse I-Line											
	2	Two-pole											
	3	Three-pole											
Voltage	4	Four-pole											
	6	600 V											
Amperage	4	480 V											
	060	60 A											
	100	100 A											
	150	150 A											
	250	250 A											
	400	400 A											
	600	600 A											
Mission Critical	000	Switch											
Mission Critical	W	J- and L-Frame with D, G, J and L interrupting ratings											
Trip Unit	See Trip Unit Numbering, page 12.												
I-Line Phasing													
Accessory Suffix Code	See Accessory Suffix Codes, page 13.												



## Interrupting Rating

UL® / CSA® / NOM®						IEC 647-2 Icu/Ics					
	240 Vac	480 Vac	600 Vac	250 Vdc <sup>1</sup>	500 Vdc <sup>2</sup>	220/240 Vac	380/440/415 Vac	500/525 Vac	690 Vac	250 Vdc <sup>1</sup>	500 Vdc <sup>3</sup>
<b>D</b> <sub>4</sub>	25 kA	18 kA	14 kA	20 kA	—	25/25 kA	18/18 kA	14/14 kA	—	20 kA	20 kA
<b>G</b>	65 kA	35 kA	18 kA	20 kA	20 kA	65/65 kA	35/35 kA	18/18 kA	—	20 kA	20 kA
<b>J</b>	100 kA	65 kA	25 kA	20 kA	—	100/100 kA	65/65 kA	25/25 kA	—	20 kA	20 kA
<b>L</b>	125 kA	100 kA	50 kA	20 kA	50 kA	125/125 kA	100/100 kA	50/50 kA	—	20 kA	20 kA
<b>R</b>	200 kA	200 kA	100 kA	—	—	150 kA	125 kA	75 kA	20 kA	—	—

1. 250 Vdc ratings only available with PowerPacT H and J circuit breakers with thermal-magnetic trip units (not including MCP).
2. UL 500 Vdc ratings only available with PowerPacT H-, J-, and L-frame circuit breakers with thermal-magnetic trip units (not including MCP).
3. IEC 500 Vdc rating only available on PowerPacT J-frame circuit breakers.
4. Interrupting rating is available on PowerPacT H and J circuit breakers.

## Trip Unit Numbering

Trip Unit Type	Character	Description
MicroLogic Trip Units	U31 X	LI Standard Protection
	U33X	LSI Standard Protection
	U43X	LSI plus Ammeter
	U44X	LSIG plus Ammeter
	U53X	LSI plus Energy Management
	U54X	LSIG plus Energy Management
	M37X	Magnetic Only (L-Frame Only)
	M38X	Motor Protector Circuit Breaker
	S40X	400 A Molded Case Switch (L-Frame Automatic Switch)
	S60X	600 A Molded Case Switch (L-Frame Automatic Switch)
Thermal-Magnetic Trip Units	—	Standard Fixed Trip Unit (Suitable for reverse connection)
	F06	60 A H-Frame Only (No trip unit)
	T	Complete Circuit Breaker (Frame + removable trip unit)
	S15	150 A Molded Case Switch (H-Frame automatic switch)
	S17	175 A Molded Case Switch (J-Frame automatic switch)
	S25	250 A Molded Case Switch (J-Frame automatic switch)
	C	100% Rated Continuous Current Rating <sup>56</sup>
	M71	30 A H-Frame Motor Circuit Protector (MCP)
	M72	50 A H-Frame Motor Circuit Protector (MCP)
	M73	100 A H-Frame Motor Circuit Protector (MCP)
	M74	150 A H-Frame Motor Circuit Protector (MCP)
	M75	250 A J-Frame Motor Circuit Protector (MCP)
	D81	500 Vdc 150–175 A J-Frame Molded Case Circuit Breaker
	D82	500 Vdc 200–250 A J-Frame Molded Case Circuit Breaker
	D87	500 Vdc 30–70 A H-Frame Molded Case Circuit Breaker
	Dxx	500 Vdc 300 A–1200 A L-Frame Molded Case Circuit Breaker (Refer to for details.)
	R	100% Rated Continuous Current Rating Complete Circuit Breaker (frame + removable trip unit)

5. 100% ratings valid for:  
 Three-pole H and J frame unit mount and busbar connection  
 Three-pole or four-pole L-frame 250 A and 400 A unit mount  
 Three-pole L-frame 250 A and 400 A I-Line
6. 100% rated is not available on PowerPacT L basic electronic trip units.

## Accessory Suffix Codes

The following tables provide suffix codes for factory installed accessories (building sequence as listed) and the numbers of field installable kits.

### Communication Networks<sup>7</sup>

Suffix	Description	Kit No.
EA	NSX ULP Cord 1.3 m, V ≤ 480 V	S434201
EB	NSX ULP Cord 3 m, V ≤ 480 V	S434202
ED	NSX ULP Cord 1.3 m, V > 480 V	S434204
EE	NSX ULP Cord 3 m, V > 480 V	S434303
EG <sup>8</sup>	BSCM with NSX ULP Cord 1.3m V ≤ 480 Vac	S434201BX
EH <sup>8</sup>	BSCM with NSX ULP Cord 3.0m V ≤ 480 Vac	S434202BX
EK <sup>8</sup>	BSCM with NSX ULP Cord 1.3m V > 480 Vac	S434204BX
EL <sup>8</sup>	BSCM with NSX ULP Cord 3.0m V > 480 Vac	S434303BX
EN	24 Vdc Power Supply Terminal Block	S434210
EP	BSCM with MB SL Cord 3.0m for V ≤ 480 Vac <sup>9</sup>	S434223BX
ER	BSCM with MB SL Cord 1.3m for V ≤ 480 Vac <sup>9</sup>	S434222BX
ES	BSCM with MB SL Cord 0.35m for V ≤ 480 Vac <sup>9</sup>	S434221BX

### Indication Contacts

Suffix	Description	Kit No.
V	SDX	S429532
	SDTAM (motor only trip units)	S429424

### Auxiliary Switch

Suffix	Contacts	Kit No.	Kit Qty.
AA	1A/1B Standard	S29450	1
AB	2A/2B Standard	S29450	2
AC	3A/3B Standard (L-frame only)	S29450	3
AE	1A/1B Low-Level	S29452	1
AF	2A/2B Low-Level	S29452	2
AG	3A/3B Low Level (L-frame only)	S29452	3

7. Except for suffix EN, EP, ER, and ES, installation requires IFM (STRV00210) for Modbus communication and/or FDM (STRV00121) for external display.
8. Use with a motor operator requires Communicating Motor Operator (suffix NC).
9. Modbus serial only ≤ 480 Vac. Use only with matching Modbus serial components.

**Alarm/Overcurrent Trip Switch**

Suffix	Switch	Kit No.	Kit Qty.
PowerPacT L-Frame and PowerPacT H/J-Frame with MicroLogic 5/6 trip units			
BC	Alarm Switch	S29450	1
BH	Alarm Switch Low-Level	S29452	1
BD	Overcurrent Trip Switch, Standard SDE Actuator	S29450	1
		S29451	1
BJ	Overcurrent Trip Switch, Low-Level SDE Actuator	S29452	11
		S29451	
BE	Alarm Switch and Overcurrent Trip Switch, Standard	S29450	2
BK	Alarm Switch and Overcurrent Trip Switch, Low-Level	S29452	2
PowerPacT H/J-Frame with Thermal-Magnetic or MicroLogic 1/2/3 trip units			
BC	Alarm Switch	S29450	1
BH	Alarm Switch Low-Level	S29452	1
BD	Overcurrent Trip Switch, Standard SDE Actuator	S29452	11
		S29451	
BJ	Overcurrent Trip Switch, Low-Level SDE Actuator	S29452	11
		S29451	
BE	Alarm Switch and Overcurrent Trip Switch, Standard SDE Actuator	S29450	2
		S29451	1
BK	Alarm Switch and Overcurrent Trip Switch, Low-Level SDE Actuator	S29452	2
		S29451	1

**Shunt Trip and Undervoltage Release UVR**

(5) Shunt Trip			(6) Undervoltage Release UVR			Voltage
Suffix	Kit No.	Kit No. 10	Suffix Description	Kit No.	Kit No. 10	
SK	P29384	—	UK	P29404	—	24 Vac
SL	P29385	—	UL	P29405	—	48 Vac
SA	P29386	S29386	UA	P29406	—	120 Vac
SD	P29387	S29387	UD	P29407	S29407	208/277 Vac
SH	P29388	S29388	UH	P29408	S29408	380/480 Vac
SJ	P29389	—	UJ	P29409	—	525/600 Vac
SN	P29382	S29382	UN	P29402	—	12 Vdc
SO	P29390	S29390	UO	P29410	S29410	24 Vdc
SU	P29391	—	UU	P29411	—	30 Vdc
SP	P29392	S29392	UP	P29412	S29412	48 Vdc
SV	P29383	—	UV	P29403	—	60 Vdc
SR	P29393	—	UR	P29413	—	125 Vdc
SS	P29394	S29394	US	P29414	S29414	250 Vdc

**Communicating Motor Operator<sup>11</sup>**

Suffix	Voltage	H-Frame	J-Frame	L-Frame
NC	220/240 Vac	S429441	S431549	S432652

10. MN / MX — Screw Version — as Kit only

11. Requires MicroLogic trip unit U43, U44, U53, or U54 and communication accessories EG, EH, EK, or EL.

**Rotary Handle**

Suffix	Handle Type (color)	H/J-Frame	L-Frame
RD10	Direct Mount (black)	S29337	S32597
RD20	Direct Mount (red)	S29339	S32599
RE10	Extended Door Mount (black)	S29338	S32598
RT10	Telescoping (black)	S29343	S32603
RE20	Extended Door Mount (red)	S29340	S32600

**Wire Harnesses<sup>12</sup>**

Suffix	Harness <sup>13</sup>	Kit No.	Kit No. <sup>14</sup>
YH3	ZSI Wire Harness, H/J Frame	S434300	—
YH3	ZSI Wire Harness, L-Frame	S434301	—
YH2	ENCT Wire Harness	S434302	—
YH1	OF Wire Harness	S434500	—
YH1	SD/SDE Wire Harness	S434501	—
YH1	SDx/SDTAM Wire Harness	S434502	—
YH1	MN Wire Harness	P434503	S434503 <sup>15</sup>
YH1	MX Wire Harness	P434504	S434504 <sup>15</sup>
YH1	Motor Operator Wire Harness	S434506	—
YH1	Communicating Motor Operator Wire Harness	S434507	—
YH1 <sup>16</sup>	NSX Wire Harness	S434508	—
YH4	ENCT and ZSI Wire Harnesses	—	—
YH1 <sup>16</sup>	24 Vdc Power Supply Wire Harness	S434505	—

**Handle Padlocks**

Suffix	Padlock Type	H/J-Frame	L-Frame
YP	Handle Padlock, ON or OFF	HJPA	S32631
YQ	Handle Padlock, OFF Only	HJPAF	NJPAF
YQ	Handle Padlock, OFF Only 2P	H2PHLA	—

12. YH1 = all installed accessories but ZSI and ENCT. YH2 = ENCT and all installed accessories. YH3 = ZSI and all installed accessories. YH4 = ZSI, ENCT and all installed accessories.

13. YH1 = all installed accessories by ZSI and ENCT.  
YH2 = ENCT and all installed accessories.  
YH3 = ZSI and all installed accessories.  
YH4 = ZSI, ENCT and all installed accessories.

14. MN / MX — Screw Version — as Kit only

15. Kit only

16. I-Line wire harness included for communication network accessories.  
Optional wire harness for unit mount requires YH1 suffix.

## General Information

The PowerPacT H-, J-, and L-frame circuit breakers are designed to protect electrical systems from damage caused by overloads and short circuits. H- and J-frame circuit breakers are available with either thermal-magnetic or MicroLogic electronic trip units. L-frame circuit breakers are available with MicroLogic electronic trip units only.

H- and J-frame circuit breakers with thermal-magnetic trip units contain individual thermal (overload) and instantaneous (short circuit) sensing elements in each pole. The amperage ratings of the thermal trip elements are calibrated at 104°F (40°C) free air ambient temperature. Per the National Electric Code® (NEC®) and the Canadian Electrical Code, standard circuit breakers may only be applied continuously at up to 80% of their rating. Circuit breakers rated for 100% operation are available but require specially-designed enclosures and 194°F (90°C) rated wire.

Devices with the MicroLogic electronic trip unit provide adjustable protection settings for greater system flexibility. In addition to electronic protection, MicroLogic trip units allow users to monitor both energy and power. Through direct access to in-depth information and networking using open protocols, PowerPacT circuit breakers with MicroLogic trip units let operators optimize the management of their electrical installations. Far more than just a circuit breaker, these devices are a measurement and communication tool ready to meet energy-efficiency needs through optimized power requirements, increased energy availability, and improved installation management.

PowerPacT™ H-, J-, and L-frame will include the industries only LED locator in an MCCB called Visi-Trip. Visi-Trip is designed to provide a visual light alert when a breaker needs to be inspected, increasing safety and saving customers time finding the concern and allowing them to being the troubleshooting process faster.

## Applications

PowerPacT H-, J- and L-frame circuit breakers offer high performance and a wide range of interchangeable trip units to protect most applications.

Electronic trip units provide highly accurate protection with wide setting ranges and can integrate measurement, metering and communication functions. They can be combined with the front display module (FDM121) to provide functions similar to a power meter.

	Power Meter	PowerPacT H-, J-, and L-frame circuit breakers equipped with MicroLogic 5/6 trip units offer type A (ammeter) or E (energy) metering functions as well as communication capability. Using MicroLogic trip unit sensors and intelligence, PowerPacT H-, J-, and L-frame circuit breakers provide access to measurements of all the main electrical parameters on the built-in screen, on a dedicated front display module (FDM121) or through the communication network.
	Operating assistance	Integration of measurement functions provides operators with operating assistance functions including alarms tripped by user-selected measurement values, time-stamped event tables and histories, and maintenance indicators.
	Front display module	The main measurements can be read on the built-in screen of MicroLogic 5/6 trip units. They can also be displayed on the equipment FDM121 along with pop-up windows signalling the main alarms.
	Communication network	PowerPacT H-, J-, and L-frame circuit breakers equipped with MicroLogic 5/6 trip units provide communication capabilities. Simple RJ45 cables connect to a Modbus communication interface module.

**Applications**

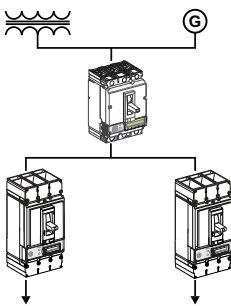
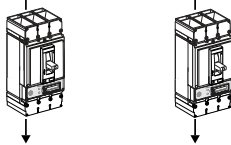
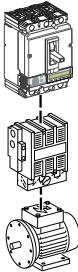
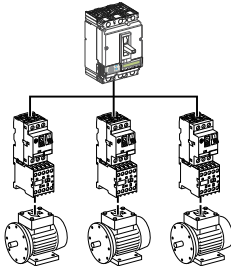
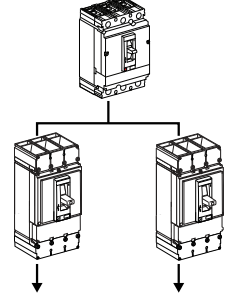
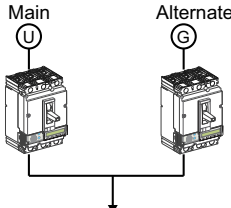
	<p>Protection of distribution systems</p>	<p>The PowerPacT H-, J-, and L-frame circuit breakers provide protection against short circuits and overloads for:</p> <ul style="list-style-type: none"> <li>• distribution systems supplied by transformers</li> <li>• distribution systems supplied by engine generator sets</li> </ul> <p>They are easily installed at all levels in distribution systems, from the main LV switchboard to the subdistribution boards and enclosures. All PowerPacT circuit breakers can protect against insulation faults by adding an external Vigirex relay.</p>
	<p>Mission critical applications</p>	<p>The PowerPacT H-, J-, and L-frame mission critical circuit breakers provide high levels of selective coordination with QO and ED/EG/EJ circuit breakers.</p>
	<p>Protection of motors</p>	<p>The PowerPacT H-, J-, and L-frame circuit breakers include a number of versions to protect motor applications:</p> <ul style="list-style-type: none"> <li>• basic short-circuit protection with electronic instantaneous only MCP or the electronic MicroLogic 1.3 M trip units, combined with a special overload relay to provide thermal protection</li> <li>• protection against overloads, short circuit and phase unbalance or loss with MicroLogic 2 M trip units</li> </ul> <p>The exceptional limiting capacity of the PowerPacT circuit breakers automatically provides coordination with the motor starter.</p>
	<p>Protection of special applications</p>	<p>The PowerPacT H-, J-, and L-frame circuit breakers offer a number of versions for special protection applications:</p> <ul style="list-style-type: none"> <li>• industrial control panels with:             <ul style="list-style-type: none"> <li>— compliance with international standards IEC 60947-2 and UL 508/CSA 22.2 N°14</li> <li>— compliance with UL 489</li> <li>— installation in universal and functional enclosures</li> </ul> </li> <li>• 400 Hz systems</li> </ul>
	<p>Control using automatic switches</p>	<p>An automatic switch version of PowerPacT H-, J-, and L-frame circuit breakers is available for circuit control. All add-on functions for the circuit breakers may be combined with the basic automatic switch function, including motor operators.</p> <p>For information on other automatic switches, contact Schneider Electric.</p>
	<p>Manual transfer systems</p>	<p>To ensure a continuous supply of power, some electrical installations are connected to two power systems:</p> <ul style="list-style-type: none"> <li>• the normal source, usually the utility (U)</li> <li>• a replacement source to supply the installation when the normal source is not available, generally from a generator (G)</li> </ul> <p>A mechanical and/or electrical interlocking system between two circuit breakers or automatic switches helps minimize risk of parallel connection of the sources during switching.</p> <p>A system can be manual transfer mechanical device interlocking.</p>

## Mission Critical Circuit Breakers

The PowerPacT J- and L-Frame Mission Critical circuit breakers deliver high levels of selective coordination in a flexible design that can be easily configured for a variety of applications. Tested to be selectively coordinated with the QO family of miniature circuit breakers and the ED, EG, and EJ circuit breakers, this solution provides peace of mind when power availability is critical.

An electronic trip unit provides adjustable long-time settings in three sensor sizes, allowing coverage from 70 through 600 A on 120–240, 208Y/120, 240, and 480Y/277 V systems.

Ratings	Available Configurations
UL 489 Listed CSA Certified Voltage: 480Y/277 V	<ul style="list-style-type: none"> <li>I-Line mounting</li> <li>Main circuit breaker in NQ and NF panelboards</li> <li>Unit mount for OEM users</li> <li>Plug-in base for OEM users</li> <li>Drawout base for OEM users</li> </ul>

In addition to unique design attributes, the PowerPacT Mission Critical circuit breakers have also undergone rigorous testing procedures to certify the coordination with downstream circuit breakers— combining innovative engineering with validated test results.

Apply Schneider Electric Mission Critical circuit breakers in emergency power distribution systems, data centers, hospitals, or anywhere continuity of service is desired

## Theory of Operation

There are several dynamic forces between the PowerPacT Mission Critical circuit breakers and downstream circuit breakers when a fault occurs downstream of the branch circuit breaker. Many of these events cannot be shown on the trip curve.

The PowerPacT Mission Critical circuit breakers analyze the fault current to make decisions which maximize selectivity with downstream circuit breakers. The trip units deploy a special selectivity delay to allow downstream circuit breakers to clear. However, on very high faults or if the downstream circuit breaker does not trip, the circuit breaker trips the mechanism instantaneously.

The combination of the PowerPacT Mission Critical circuit breaker and downstream circuit breakers shown in the selectivity charts in the instruction bulletin are selective due to the fact that the series impedance and the let-through from the downstream circuit breaker does not produce enough energy to trip the PowerPacT Mission Circuit breaker.

This system maximizes the interaction of the circuit breakers in series to allow selectivity.



## Trip Units and Trip Curves

The PowerPacT J- and L-Frame Mission Critical circuit breakers deliver high levels of selective coordination with the QO family of miniature circuit breakers and the ED, EG, and EJ circuit breakers in a flexible design that can be easily configured for a variety of applications. These circuit breaker can be equipped with 3.2-W, 3.2S-W, 5.2A-W, 5.2E-W, 6.2A-W, 3.3S-W, 5.3A-W, 6.3A-2, and 6.3E-2 MicroLogic trip units. See the catalog numbers and references beginning in J-Frame 250 A Mission Critical Electronic Trip UL Rated Circuit Breakers (Three-Pole, 480Y/277 Vac, 50/60 Hz) With Factory-Sealed Trip Unit Suitable for Reverse Connection, page 45.

The mission critical trip units have the same settings and trip curves as the standard trip units described in this document.

For more information see the trip unit user guides 48940-310-01 and 48940-312-01 on the Schneider Electric website.

J-frame mission critical circuit breakers are selective with QO or E-frame circuit breakers per the table below when the amperage of the main circuit breaker is at least two times the amperage of the branch circuit breaker.

### J-Frame Selectivity with QO and E-Frame Circuit Breakers

Circuit Breaker <sup>17</sup>		Voltage		Current	One-Line Diagram	
Main	Branch					
J-W, 250 A	QO(B) QO(B)-H QO(B)-VH QH	1P, 2P	10-30 A	240/120 V 120 V	18 kA	
			35-60 A		15 kA	
			70-125 A		12 kA	
		3P	10-30 A	240 V 208 V	15 kA	
			35-60 A		13 kA	
			70-125 A		10 kA	
J-W, 250 A	E-Frame	1P, 2P, 3P	15-125 A	240 V	18 kA	
			15-60 A		480Y/277 V	
			70-125 A	7 kA		

L-frame mission critical circuit breakers are selective with QO-style and E-frame circuit breakers per the table below when the amperage of the main circuit breaker is at least two times greater than the amperage of the branch circuit breaker.

### L-Frame Selectivity with QO and E-Frame Circuit Breakers

Circuit Breaker <sup>17</sup>		Voltage		Current	One-Line Diagram
Main	Branch				
L-W, 250 A	QO(B) QO(B)-H QO(B)-VH QH	10-60 A	240 V	18 kA	
		70-125 A		10 kA	
L-W, 400 A L-W, 600 A	QO(B) QO(B)-H QO(B)-VH QH	15-150 A	240 V	30 kA	
		15-125 A	240 V	30 kA	
L-W, 250 A L-W, 400 A L-W, 600 A	E-Frame		480Y/277	30 kA	

17. Including AFI, CAFI, EPD and GFI circuit breakers.

## Flexible Configurations

The PowerPacT H-, J- and L-frame circuit breakers may be configured with lugs, bus bar connections, rear connections, I-Line, drawout cradle, or plug-in base.

## Field Installable Accessories and Trip Units

### Field Installable Accessories and Trip Units

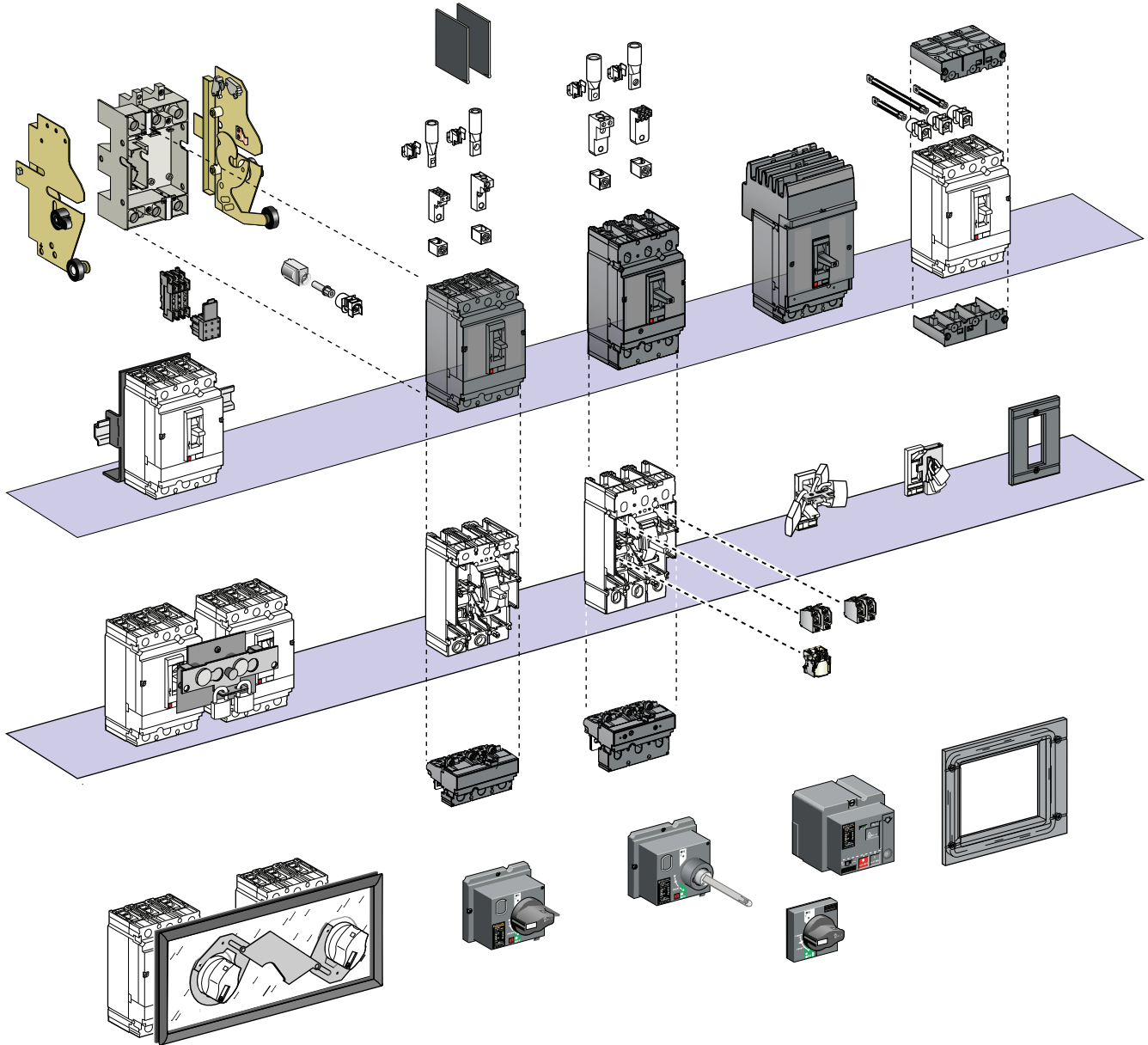

# General Characteristics

## Faceplate Label

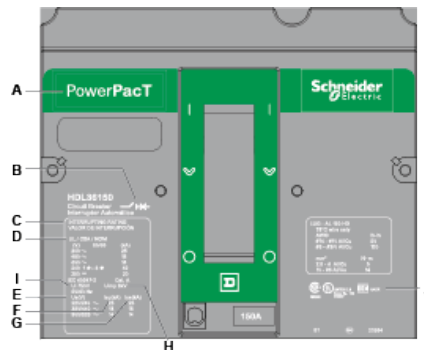

Characteristics indicated on the faceplate label:

- A. Circuit breaker type
- B. Circuit breaker disconnect symbol
- C. Performance levels
- D. Standards
- E. Ue: Operating voltage per IEC
- F. Icu: Ultimate breaking capacity per IEC
- G. Ics: Service breaking capacity per IEC
- H. Uimp: Rated impulse withstand voltage per IEC
- I. Ui: Insulation voltage per IEC
- J. Certification marks

**NOTE:** When the circuit breaker is equipped with an extended rotary handle, the door must be opened to view the faceplate.

## Codes and Standards

PowerPacT H-, J-, and L-frame circuit breakers, automatic switches and electronic motor circuit protectors are manufactured and tested in accordance with the following standards.

**NOTE:** Apply circuit breakers according to guidelines detailed in the National Electric Code (NEC) and other local wiring codes.

### Codes and Standards

PowerPacT H-, J-, and L-Frame Circuit Breakers	H-, J-, and L-Frame Switches	Motor Circuit Protectors
UL 489 <sup>18</sup> IEC 60947-2 CSA C22.2 No. 5 <sup>19</sup> Federal Specification W-C-375B/GEN NEMA AB1 NMX J-266 CCC CE and UKCA Marking	UL 489 <sup>20</sup> IEC 60947-3 CSA C22.2 No. 5 <sup>21</sup> Federal Specification W-C-375B/GEN NEMA AB1 NMX J-266 CE and UKCA Marking	UL 508 IEC 60947-2 CSA C22.2 No. 14 NEMA AB1 CCC CE and UKCA Marking

18. PowerPacT H-, J-, and L-frame circuit breakers are in UL File E10027.  
 19. PowerPacT H- and J-frame circuit breakers are in CSA File 153555-1534832. PowerPacT L-frame circuit breakers are in CSA File 177007-2457072.  
 20. PowerPacT H- and J-frame switches are in UL File E33117.  
 21. PowerPacT H- and J-frame switches are in CSA File 153555-1544371.  
 22. PowerPacT L-frame switches are in CSA File 177007-70012744.

## Vibration

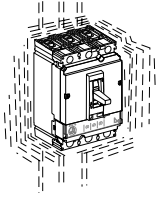

PowerPacT H-, J-, and L-frame devices resist mechanical vibration.

Tests are carried out in compliance with standard UL 489 SA and SB for the levels required by merchant-marine inspection organizations (Veritas®, Lloyd's®, etc.):

PowerPacT H-, J-, and L-frame circuit breaker meet IEC 60068-2-6 for vibration:

- 2.0 to 25.0 Hz and amplitude +/- 1.6 mm
- 25.0 to 100 Hz acceleration +/- 4.0 g

Excessive vibration may cause tripping, breaks in connections or damage to mechanical parts.

## Electromagnetic Disturbances

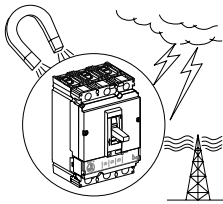

PowerPacT H-, J-, and L-frame devices are protected against:

- overvoltages caused by circuit switching
- overvoltages caused by an atmospheric disturbances or by a distribution-system outage (such as from failure due to lightning)
- devices emitting radio waves (radios, walkie-talkies, radar, etc.)
- electrostatic discharges produced directly by users

PowerPacT H-, J-, and L-frame devices have successfully passed the electromagnetic-compatibility

tests (EMC) defined by the following international standards:

- IEC/EN 60947-2: Low-voltage switchgear and controlgear, part 2: Circuit breakers:
  - Annex F: Immunity tests for circuit breakers with electronic protection
  - Annex B: Immunity tests for residual current protection
- IEC/EN 61000-4-2: Electrostatic-discharge immunity tests
- IEC/EN 61000-4-3: Radiated, radio-frequency, electromagnetic-field immunity tests
- IEC/EN 61000-4-4: Electrical fast transient/burst immunity tests
- IEC/EN 61000-4-5: Surge immunity tests
- IEC/EN 61000-4-6: Immunity tests for conducted disturbances induced by radio frequency fields
- CISPR 11: Limits and methods of measurement of electromagnetic disturbance characteristics of industrial, scientific and medical (ISM) radio-frequency equipment.

These tests ensure that:

- no nuisance tripping occurs due to electromagnetic disturbances
- tripping times are respected

## Tropicalization

The materials used in PowerPacT circuit breakers will not support the growth of fungus and mold.

PowerPacT circuit breakers have passed the test defined below for extreme atmospheric conditions.

Dry cold and dry heat:

- IEC 60068-2-1 — Test A: Cold at +55°C
- IEC 60068-2-2 — Dry Heat at +85°C

Damp heat (tropicalization)

- IEC 60068-2-30 — damp heat (temperature 55°C and 95% relative humidity)
- IEC 60068-2-52 — salt mist

## Special Ratings

The H-frame and J-frame circuit breakers also comply with the following special ratings:

- HACR rating
- SWD switch duty rating (applies only to 15 and 20 A / 277 Vac or less, two- and three-pole)
- HID high intensity discharge lighting rating (15–50 A)

The L-frame circuit breakers complies with the following special rating:

- HACR rating

## Marine Ratings

### UL Marine Listed/CSA Certified Circuit Breakers (UL 489 Supplement SA)

The PowerPacT H- and J-frame circuit breakers with thermal-magnetic trip units with D, G, J and L interruption levels meet the UL 489 Supplement SA requirements for use on vessels of any length under or over 65 ft. (19.8 m). The PowerPacT H-, J-, and L-frame circuit breakers with MicroLogic electronic trip units meet the UL 489 Supplement SA for use on vessels over 65 ft. (19.8 m) in length. Marine circuit breakers must not use aluminum or aluminum alloys for terminal connections and must be calibrated at an ambient temperature of 104°F (40°C). Standard circuit breakers should not be specified or used in the place of marine rated circuit breakers. Circuit breakers can be ordered with the Marine SA listing by adding the suffix “YA” (marine) to the catalog number.

### UL Naval Listed/CSA Certified Circuit Breakers (UL 489 Supplement SB)

The PowerPacT H-, J-, and L-frame circuit breakers with MicroLogic trip units with D, G, J and L interruption levels meet the UL 489 Supplement SB requirements for use on naval vessels. These circuit breakers are subject to various vibration tests as described in UL 489 Supplement SB. Naval circuit breakers must not use aluminum or aluminum alloys for terminal connections and must be calibrated at an ambient temperature of 122°F (50°C). Standard circuit breakers should not be specified or used in the place of navel rated circuit breakers. Circuit breakers can be ordered with the Naval SB listing by adding the suffix “YA1” (naval) to the catalog number.

### American Bureau of Shipping (ABS)

The PowerPacT H-, J-, and L-Frame circuit breakers are certified to ABS-NVR (American Bureau of Shipping - Naval Vessel Rules), for use on Naval vessels.

# UL 489 SC Listed 500 Vdc Circuit Breakers

The UL Listed / CSA Certified thermal-magnetic H-, J-, and L-frame molded case circuit breakers are specifically designed for use on ungrounded dc systems having a maximum short-circuit voltage of 500 Vdc or a maximum floating (unloaded) voltage of 600 Vdc. The circuit breakers are suitable for use only with UPS (uninterruptable power supplies) and ungrounded systems. This two-level voltage rating allows these circuit breakers to be applied to battery sources having a short-circuit availability of 20,000 or 50,000 amperes at 500 Vdc.

These circuit breakers are UL Listed/CSA Certified for the interrupting ratings shown only if applied with three poles connected in series (series connection is external to circuit breaker). See diagram below.

**NOTE:** Due to external series connection, I-Line circuit breakers are not available for this application.

## DC Circuit Breaker Caution Labels

### H- and J-Frame Circuit Breakers

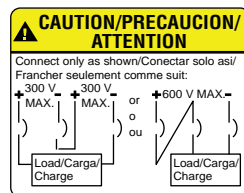

Source = 600 Vdc max. (floating)  
500 Vdc max. (loaded)

### L-Frame Three-Pole Circuit Breakers

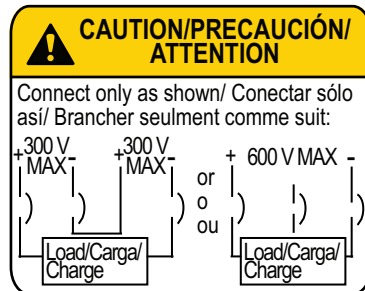

### L-Frame Three-Pole Circuit Breakers

### L-Frame Four-Pole Circuit Breakers

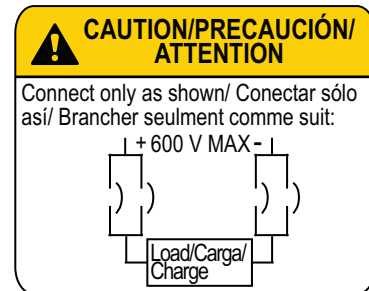

### L-Frame Four-Pole Circuit Breakers

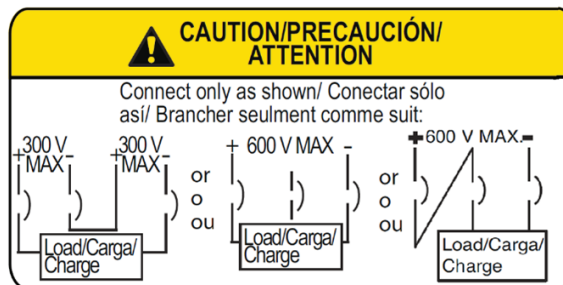

### L-Frame Three-Pole Circuit Breakers

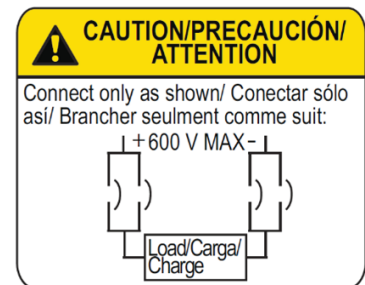

### L-Frame Four-Pole Circuit Breakers

**DC Molded Case Circuit Breakers—Adjustable Magnetic Trip**

Ampere Rating	Circuit Breaker Cat. No.	Adjustable Magnetic Trip Range—DC Amperes		Performance Level @ 500 Vdc
		Low	High	
100 A	JGL37100D81	400	600	20 k AIR
125 A	JGL37125D81	400	600	
150 A	JGL37150D81	400	600	
175 A	JGL37175D81	400	600	
200 A	JGL37200D82	500	850	
225 A	JGL37225D82	500	850	
250 A	JGL37250D82	500	850	20 k AIR
300 A	LGL37030D27	750	1500	20 k AIR
350 A	LGL37035D29	875	1750	
400 A	LGL37040D30	1000	2000	
450 A	LGL37045D31	1125	2250	
500 A	LGL37050D32	1250	2500	
600 A	LGL37060D33	1500	3000	
700 A	LGL47070D35	1750	3500	
800 A	LGL47080D36	2000	4000	
900 A	LGL47090D86	2250	4500	
1000 A	LGL47100D40	2500	5000	
1200 A	LGL47120D42	3000	6000	
100 A	JLL37100D81	400	600	
125 A	JLL37125D81	400	600	
150 A	JLL37150D81	400	600	
175 A	JLL37175D81	400	600	
200 A	JLL37200D82	500	850	
225 A	JLL37225D82	500	850	
250 A	JLL37250D82	500	850	
300 A	LLL37030D27	750	1500	50 k AIR
350 A	LLL37035D29	875	1750	
400 A	LLL37040D30	1000	200	
450 A	LLL37045D31	1125	2250	
500 A	LLL37050D32	1250	2500	
600 A	LLL37060D33	1500	3000	
700 A	LLL47070D35	1750	3500	
800 A	LLL47080D36	2000	4000	
900 A	LLL47090D86	2250	4500	
1000 A	LLL47100D40	2500	5000	
1200 A	LLL47120D42	3000	6000	

**DC Molded Case Circuit Breakers—Fixed Magnetic Trip**

Ampere Rating	Circuit Breaker Cat. No.	Fixed Magnetic Trip Range—DC Amperes		Performance Level @ 500 Vdc
		Low	High	
30 A	HGL37030D87	300	600	20 k AIR
50 A	HGL37050D87	300	600	
70 A	HGL37070D87	300	600	
30 A	HLL37030D87	300	600	50 k AIR
50 A	HLL37050D87	300	600	
70 A	HLL37070D87	300	600	



## PowerPact H- and J-Frame Ratings

### PowerPact H- and J-Frame Circuit Breaker Ratings

Circuit Breaker		150 A H-Frame					250 A J-Frame				
Circuit Breaker Type		HD	HG	HJ	HL	HR	JD	JG	JJ	JL	JR
Number of poles <sup>23</sup>		2, 3			3		2, 3			3	
Amperage Range (A)		15–150					70–250				
UL 489 Circuit Breaker Ratings											
Breaking Capacity (AIR) UL/CSA/NOM (kA rms)	240 Vac	25	65	100	125	200	25	65	100	125	200
	480 Vac	18	35	65	100	200	18	35	65	100	200
	600 Vac	14	18	25	50	100	14	18	25	50	100
	250 Vdc <sup>24</sup>	20	20	20	20	—	20	20	20	20	—
	500 Vdc <sup>24, 25</sup>	—	20	—	50	—	—	20	—	—	50
IEC 947-2 Circuit Breaker Ratings											
Ultimate Breaking Capacity (Icu) (kA rms)	220/240 Vac	25	65	100	125	150	25	65	100	125	150
	380/415 Vac	18	35	65	100	125	18	35	65	100	125
	440/480 Vac	18	35	65	100	125	18	35	65	100	125
	500/525 Vac	14	18	25	50	75	14	18	25	50	75
	690 Vac	—	—	—	—	20	—	—	—	—	20
	250 Vdc <sup>24</sup>	—	—	—	—	—	20	20	20	20	—
	500 Vdc <sup>24, 25</sup>	—	—	—	—	—	20	20	20	20	—
Service Breaking Capacity (Ics)	% Icu	100%					100%				
Insulation Voltage	Ui	750 V					750 Vac				
Impulse Withstand Voltage	Uimp	8 kVac					8 kVac				
Operational Voltage	Ue	690 Vac					690 Vac				
Sensor Rating	In	150 A					250 A				
Utilization Category	—	A					A				
Operations (Open-Close Cycles)											
Without Current		4000					5000				
With Current		4000					1000				

### PowerPact H- and J-Frame Protection and Measurements

Circuit Breaker		150 A H-Frame					250 A J-Frame				
Circuit Breaker Type		HD	HG	HJ	HL	HR	JD	JG	JJ	JL	JR
Number of poles <sup>26</sup>		2, 3			3		2, 3			3	
Protection and Measurements											
Short-circuit Protection	Magnetic only	X	X	X	X	X	X	X	X	X	X
Overload/Short-circuit Protection	Thermal-magnetic	X	X	X	X	X	X	X	X	X	X
	Electronic	X	X	X	X	X	X	X	X	X	X
	with neutral protection (Off-0.5-1-OSN) <sup>27</sup>	X	X	X	X	X	X	X	X	X	X
	with ground fault protection	X	X	X	X	X	X	X	X	X	X

23. H and J-frame breakers with MicroLogic trip units available only with three poles. The HJ, HL and the J-Frame two pole circuit breakers are three-pole modules.

24. DC not available with PowerPact H, J or L-frame circuit breakers with MicroLogic trip units.

25. 500 Vdc specific catalog numbers, ungrounded UPS systems only.

26. H and J-frame breakers with MicroLogic trip units available only with three poles. The HJ, HL and the J-Frame two pole circuit breakers are three pole modules.

27. OSN: Over Sized Neutral protection for neutrals carrying high currents (e.g. 3rd harmonics).

**PowerPacT H- and J-Frame Protection and Measurements (Continued)**

Circuit Breaker		150 A H-Frame					250 A J-Frame				
Circuit Breaker Type		HD	HG	HJ	HL	HR	JD	JG	JJ	JL	JR
	with zone selective interlocking (ZSI) <sup>28</sup>	X	X	X	X	X	X	X	X	X	X
Display / I, V, f, P, E, THD measurements / interrupted-current measurement		X	X	X	X	X	X	X	X	X	X
Options	Front display module (FDM121)	X	X	X	X	X	X	X	X	X	X
	Operating assistance	X	X	X	X	X	X	X	X	X	X
	Counters	X	X	X	X	X	X	X	X	X	X
	Histories and alarms	X	X	X	X	X	X	X	X	X	X
	Metering Com	X	X	X	X	X	X	X	X	X	X
	Device status/control com	X	X	X	X	X	X	X	X	X	X
	Visi-Trip	X	X	X	X	X	X	X	X	X	X

**PowerPacT H- and J-Frame Dimensions / Weight / Connections**

Circuit Breaker		150 A H-Frame					250 A J-Frame				
Circuit Breaker Type		HD	HG	HJ	HL	HR	JD	JG	JJ	JL	JR
Number of poles <sup>29</sup>		2, 3			3	2, 3			3		
Dimensions (Three-Pole Unit Mount) in. (mm)	Height	6.4 (163)					7.5 (191)				
	Width	4.1 (104)					4.1 (104)				
	Depth	3.4 (86)					3.4 (86)				
Weight - lb. (Kg)		4.8 (2.2)					5.3 (2.4)				
Connections / Terminations	Unit Mount	X					X				
	I-Line	X					X				
	Rear Connection	X					X				
	Plug-In	X					X				
	Drawout	X					X				
	Optional Lugs	X					X				

28. ZSI using restraint wires

29. H and J-frame breakers with MicroLogic trip units available only with three poles. The HJ, HL and the J-Frame two pole circuit breakers are three pole modules.

## PowerPacT L-Frame Ratings

### PowerPacT L-Frame Circuit Breaker Ratings

Circuit Breaker		400 A L-Frame				600 A L-Frame				600 A DC L-Frame <sup>30</sup>		1200 A DC L-Frame <sup>30</sup>	
Circuit Breaker Type		LG	LJ	LL	LR	LG	LJ	LL	LR	LG	LL	LG	LL
Number of Poles		3, 4				3, 4				3	3	4	
Amperage Range (A)		70–400				200–600				300–600		700–1200	
UL 489 Circuit Breaker Ratings													
Breaking Capacity (AIR) UL/CSA/NOM (kA rms)	240 Vac	65	100	125	200	65	100	125	200	—	—	—	—
	480 Vac	35	65	100	200	35	65	100	200	—	—	—	—
	600 Vac	18	25	50	100	18	25	50	100	—	—	—	—
	250 Vdc <sup>31</sup>	—	—	—	—	—	—	—	—	—	—	—	—
	500 Vdc <sup>31, 32</sup>	—	—	—	—	—	—	—	—	—	20	50	20
IEC 947-2 Circuit Breaker Ratings													
Ultimate Breaking Capacity (Icu) (kA rms)	220/240 Vac	65	100	125	150	65	100	125	150	—	—	—	—
	380/415 Vac	35	65	100	125	35	65	100	125	—	—	—	—
	440/480 Vac	35	65	100	125	35	65	100	125	—	—	—	—
	500/525 Vac	18	25	50	75	18	25	50	75 <sup>33</sup>	—	—	—	—
	690 Vac	—	—	—	20	—	—	—	20	—	—	—	—
	250 Vdc <sup>31</sup>	—	—	—	—	—	—	—	—	—	—	—	—
	500 Vdc <sup>31, 32</sup>	—	—	—	—	—	—	—	—	—	—	—	—
Service Breaking Capacity (Ics)	% Icu	100%				100%				—	—	—	—
Insulation Voltage	Ui	800 Vac				800 Vac				—	—	—	—
Impulse Withstand Voltage	Uimp	8 kVac				8 kVac				—	—	—	—
Operational Voltage	Ue	690 Vac				690 Vac				—	—	—	—
Sensor Rating	In	400 A				600 A				—	—	—	—
Utilization Category		A				A				—	—	—	—
Operations (Open-Close Cycles)													
Without Current		5000				5000				—	—	—	
With Current		1000				1000				—	—	—	

### PowerPacT L-Frame Protection and Measurements

Circuit Breaker		400 A L-Frame				600 A L-Frame				1200 A L-Frame	
Circuit Breaker Type		LG	LJ	LL	LR	LG	LJ	LL	LR	LG	LL
Number of Poles		3, 4				3, 4				4	
Protection and Measurements											
Short-circuit Protection	Magnetic only	X	X	X	X	X	X	X	X	—	—
Overload/Short-circuit Protection	Thermal-magnetic	—	—	—	—	—	—	—	—	X	X
	Electronic	X	X	X	X	X	X	X	X	—	—
	with neutral protection (Off-0.5-1-OSN) <sup>34</sup>	X	X	X	X	X	X	X	X	—	—
	with ground fault protection	X	X	X	X	X	X	X	X	—	—

30. LED handle is not available on PPL DC 300 A — 1200 A

31. DC not available with PowerPacT H, J or L-frame circuit breakers with MicroLogic trip units.

32. 500 Vdc specific catalog numbers, ungrounded UPS systems only.

33. Ics for 600 A L-frame circuit breaker at 525 V is 19 kA.

34. OSN: Over Sized Neutral protection for neutrals carrying high currents (e.g. 3rd harmonics).

## PowerPacT L-Frame Protection and Measurements (Continued)

Circuit Breaker		400 A L-Frame				600 A L-Frame				1200 A L-Frame	
Circuit Breaker Type		LG	LJ	LL	LR	LG	LJ	LL	LR	LG	LL
	with zone selective interlocking (ZSI) <sup>35</sup>	X	X	X	X	X	X	X	X	—	—
Display / I, V, f, P, E, THD Measurements / Interrupted-Current Measurement		X	X	X	X	X	X	X	X	—	—
Options	Front display module (FDM121)	X	X	X	X	X	X	X	X	—	—
	Operating assistance	X	X	X	X	X	X	X	X	—	—
	Counters	X	X	X	X	X	X	X	X	—	—
	Histories and alarms	X	X	X	X	X	X	X	X	—	—
	Metering Com	X	X	X	X	X	X	X	X	—	—
Device status/control com	X	X	X	X	X	X	X	X	—	—	
Visi-Trip	Visi-Trip	X	X	X	X	X	X	X	X	—	—

## PowerPacT L-Frame Circuit Breaker Dimensions / Weight / Connections

Circuit Breaker		400 A L-Frame				600 A L-Frame				1200 A L-Frame	
Circuit Breaker Type		LG	LJ	LL	LR	LG	LJ	LL	LR	LG	LL
<b>Number of Poles</b>		<b>3, 4</b>				<b>3, 4</b>				<b>4</b>	
Dimensions (Three-Pole Unit Mount) in. (mm)	Height	13.38 (340)				13.38 (340)				13.38 (340)	
	Width	5.51 (140)				5.51 (140)				5.51 (140)	
	Depth	4.33 (110)				4.33 (110)				4.33 (110)	
Weight - lb. (Kg)		13.2 (6.0)				13.7 (6.2)				13.7 (6.2)	
Connections / Terminations	Unit Mount	X				X				X	
	I-Line	X				X				—	
	Rear Connection	X				X				X <sup>36</sup>	
	Plug-In	X				X				—	
	Drawout	X				X				—	
	Optional Lugs	X				X				—	

35. ZSI using restraint wires

36. Rear connection is not available for 700–1200 A four pole L-frame circuit breakers.

## PowerPacT H-, J-, and L-frame Circuit Breaker Trip Units

### MicroLogic Trip Unit Features

Features	MicroLogic Trip Unit (X = Standard Feature, O = Available Option)					
	Standard		Ammeter		Energy	
	3.2/3.3	3.2S/3.3S	5.2A/5.3A	6.2A/6.3A	5.2E/5.3E	6.2E/6.3E
LI	X					
LSI <sup>37</sup>		X	X		X	
LSIG/Ground Fault Trip <sup>38</sup>				X		X
Ground-Fault Alarm Trip				X		X
Current Settings Directly in Amperes	X	X	X	X	X	X
True RMS Sensing	X	X	X	X	X	X
UL Listed	X	X	X	X	X	X
Thermal Imaging	X	X	X	X	X	X
LED for Long-Time Pickup	X	X	X	X	X	X
LED for Long-Time Alarm	X	X	X	X	X	X
LED Green "Ready" Indicator	X	X	X	X	X	X
Up to 12 Alarms Used Together			X	X	X	X
Digital Ammeter			X	X	X	X
Zone-Selective Interlocking <sup>39</sup>			X	X	X	X
Communications	O	O	O	O	O	O
LCD Display			X	X	X	X
Front Display Module FDM121			O	O	O	O
Advanced User Interface			X	X	X	X
Neutral Protection			X	X	X	X
Contact Wear Indication <sup>40</sup>			X	X	X	X
Incremental Fine Tuning of Settings			X	X	X	X
Load Profile <sup>40, 41</sup>			X	X	X	X
Power Measurement					X	X
Power Quality Measurements					X	X

37. The LSI with 3.2S/3.3S trip units have fixed short time and long time delays.

38. Requires neutral current transformer on three-phase four-wire loads.

39. ZSI for H/J-frame devices is only OUT. ZSI for L-frame devices is IN and OUT.

40. Indication available using the communication system only.

41. % of hours in 4 current ranges: 0–49%, 50–79%, 80–89%, and >90% In.

## Thermal-Magnetic or Electronic Trip Unit

Thermal-magnetic trip units (available on H- and J-frame circuit breakers only) protect against overcurrents and short-circuits using tried and true techniques. For applications requiring installation optimization and energy efficiency, electronic trip units offer more advanced protection functions combined with measurements.

Trip units using digital electronics are faster as well as more accurate. Wide setting ranges make installation upgrades easier. Designed with processing capabilities, MicroLogic trip units can provide measurement information and device operating assistance. With this information, users can avoid or deal more effectively with disturbances and can play a more active role in system operation. They can manage the installation, anticipate events and plan any necessary servicing.

## Accurate Measurements for Complete Protection

PowerPacT H-, J-, and L-frame circuit breakers offer excellent measurement accuracy from 15 amperes on up to the short-circuit currents. This is made possible by a new generation of current transformers combining “iron-core” sensors for self-powered electronics and “air core” sensors (Rogowski coils) for measurements. The protection functions are managed by an ASIC (Application Specific Integrated Circuit) component that is independent of the measurement functions. This independence ensures immunity to conducted and radiated disturbances and increases reliability.

## Numerous Security Functions

Torque-limiting screws	The screws secure the trip unit to the circuit breaker. When the correct tightening torque is reached, the screw heads break off. Optimum tightening avoids any risk of temperature rise. A torque wrench is no longer required.
Easy and sure changing of trip units	All trip units are interchangeable, without wiring. A mechanical mismatch-protection system minimizes the possibility of mounting a trip unit on a circuit breaker with a lower rating. <sup>42</sup>
“Ready” LED for a continuous self-test	The LED on the front of the electronic trip units indicates the result of the self-test running continuously on the measurement system and the tripping release. As long as the green LED is flashing, the links between the CTs, the processing electronics and the tripping mechanism are operational. The circuit breaker is ready to protect. A minimum current of 15 to 50 A, depending on the device, is required for this indication function.
A patented dual adjustment system for protection functions	Available on MicroLogic 5/6 trip units, the system consists of: <ul style="list-style-type: none"> <li>• an adjustment using rotary switches sets the maximum value</li> <li>• an adjustment using the keypad or made remotely fine-tunes the setting. This setting may not exceed the first one. It can be read directly on the MicroLogic trip unit screen, to within one ampere and a fraction of a second.</li> </ul>

42. Breaker must be ordered with removable trip unit. Refer to page 9 for additional detail.

# Circuit Breakers

## Dual-Break Rotating Contacts

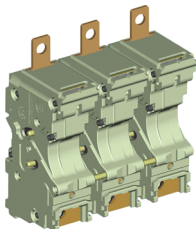

### Reduced Let-Through Currents

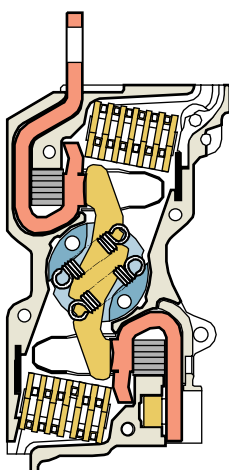

All PowerPacT H-, J-, and L-frame circuit breakers are equipped with dual-break rotating contacts that reduce the amount of peak current during a short-circuit fault. This reduces the let-through currents and enhances equipment protection.

The moving contact has the shape of an elongated “S” and rotates around a floating axis. The shape of the fixed and moving contacts are such that the repelling forces appear as soon as the circuit reaches approximately 15 times  $I_n$ . Due to the rotating movement, repulsion is rapid and the device greatly limits short-circuit currents, whatever the interrupting level of the unit (D, G, J or L). The fault current is extinguished before it can fully develop. Lower let-through currents provide less peak energy, reducing the required busbar bracing, lowering enclosure pressure, and delivering improved series or combination ratings. See [Current-Limiting](#), page 36.

## High Ampere Interrupting Ratings (AIR)

Circuit breakers are available with interrupting ratings up to:

- 200 kA at 240 Vac delta
- 200 kA at 480 Vac delta
- 100 kA at 600 Vac delta.

See Interrupting Rating, page 11 for additional performance levels.

## Internal Operating Mechanism

PowerPacT H-, J-, and L-frame circuit breakers have an over-center toggle mechanism providing quick-make, quick-break operation. The operating mechanism is also trip-free, which allows tripping even when the circuit breaker handle is held in the “ON” position. Internal cross-bars provide common opening and closing of all poles with a single operating handle.

All PowerPacT circuit breakers have an integral push-to-trip button in the cover to manually trip the circuit breaker. This should be used as part of a regular preventive maintenance program.

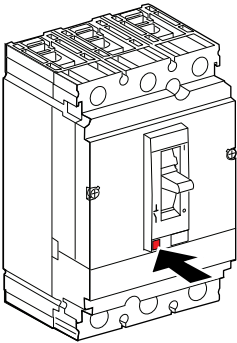

Push-to-Trip

## Handle Position Indication

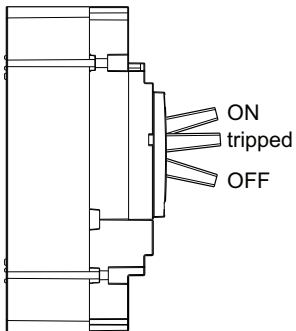

The circuit breaker handle can assume any of three positions, ON, tripped or OFF as shown. The center tripped position provides positive visual indication that the circuit breaker has tripped.

The circuit breaker can be reset by first pushing the handle to the extreme “OFF” position. Power can then be restored to the load by pushing the handle to the “ON” position.



## Visi-Trip Breaker Locator

Provides a visual light alert when a breaker may require attention.

The Visi-Trip LED handle aids in quickly locating a circuit breaker that requires attention. Inspect the handle position for circuit breaker trip indication. The VisiTrip handle will flash an LED light as described in the table below.

Wait five seconds between handle operation and push-to-trip button operation to ensure that the Visi-Trip handle is in standby. Tripping the circuit breaker too soon after toggling may result in the Visi-Trip handle not operating as intended. If a nuisance LED flashing occurs, it can be reset by toggling the circuit breaker. If toggling the circuit breaker is not desired, LED flashing will reset after six hours. When performing annual maintenance in accordance with MCCB Field Testing and Maintenance Guide (0600IB1201), operate the push to trip button (if equipped) to verify the Visi-Trip functionality. Cycle the circuit breaker from tripped to OFF, and then from OFF to ON and take note of the battery health.

Light Pattern	Indicator
Fast flash for two seconds.	Battery low (20% remaining) <sup>43</sup>
Long duration slow flash (continuous flash up to for six hours).	The circuit breaker required inspection.

## Circuit Breaker Ratings

The interrupting rating is the highest current at rated voltage the circuit breaker is designed to safely interrupt under standard test conditions. Circuit breakers must be selected with interrupting ratings equal to or greater than the available short-circuit current at the point where the circuit breaker is applied to the system (unless it is a branch device in a series rated combination). Interrupting ratings are shown on Interrupting Rating, page 11 and on the faceplate label on the front of the circuit breaker.

## Reverse Feeding of Circuit Breakers

The standard unit-mount H-, J-, and L-frame circuit breakers have sealed trip units and may be reverse fed. For catalog numbers, refer to the following tables:

- PowerPacT H-Frame Standard (80%) Rated 150 A Unit-Mount Thermal-Magnetic Circuit Breakers (600 Vac, 250 Vdc) with Factory-Sealed Trip Unit (Suitable for Reverse Connection), page 41
- PowerPacT H-Frame 100% Rated 150 A Unit-Mount Thermal-Magnetic Circuit Breakers (600 Vac, 250 Vdc) with Factory-Sealed Trip Unit (Suitable for Reverse Connection), page 42
- **L-Frame 600 A Electronic Trip UL Rated Three-Pole Circuit Breakers (600 Vac, 50/60 Hz) With Factory-Sealed Trip Unit Suitable for Reverse Connection**, page 52
- L-Frame 600 A Mission Critical Standard (100 %) Rated Electronic Trip UL Rated Three-Pole Circuit Breakers (480Y/277 Vac, 50/60 Hz) With Factory-Sealed Trip Unit Suitable for Reverse Connection , page 52
- L-Frame 600 A Electronic Trip UL Rated Four-Pole Circuit Breakers (600 Vac, 50/60 Hz) With Factory-Sealed Trip Unit Suitable for Reverse Connection , page 53

43. Contact Schneider Electric services for replacement detail.

- **L-Frame 600 A Mission Critical Standard (80%) Rated Electronic Trip UL Rated Four-Pole Circuit Breakers (480Y/277 Vac, 50/60 Hz) With Factory-Sealed Trip Unit Suitable for Reverse Connection** , page 54
- L-Frame 600 A I-Line Standard (80%) Rated Electronic Trip UL Rated Circuit Breakers (600 Vac, 50/60 Hz) With Factory-Sealed Trip Unit Suitable for Reverse Connection , page 54
- L-Frame 600 A Mission Critical I-Line Standard (80%) Rated Electronic Trip UL Rated Circuit Breakers (480/277 Vac, 50/60 Hz) With Factory Sealed Trip Units Suitable for Reverse Connection, page 55
- L-Frame 250 A and 400 A I-Line 100% Rated Electronic Trip UL Rated Circuit Breakers (600 Vac, 50/60 Hz) With Factory Sealed Trip Unit Suitable for Reverse Connection , page 55
- L-Frame 3-Pole, 600 A Circuit Breakers with Lugs and Field-Interchangeable Electronic Trip Units (600 Vac, 50/60 Hz), page 56
- 

Circuit breakers with field-interchangeable trip units (designated by the suffix T or R and labeled “LINE” and “LOAD”) cannot be reverse fed. Neither can circuit breaker frames without terminations or trip units.

## Current-Limiting

The current-limiting attributes of PowerPacT H-, J-, and L-frame circuit breakers provide greater protection for downstream devices by limiting the let-through current in the event of a fault. The current-limiting capabilities of HJ/HL/HR, JJ/JL/JR, and LJ/LL/LR frame circuit breakers are documented with Underwriters Laboratories and Canadian Standards Association. These current-limiting circuit breakers ship with a label that identifies them as UL/CSA Current-Limiting Circuit Breakers. (The HD/HG, JD/JG, and LD/LG circuit breakers do not carry the UL Current-Limiting label).

The trip curves with let-through data are available in the trip curve section in this catalog, see [Trip Curves](#), page 237.

Please note that as let-through curves for UL Listed / CSA Certified Current-Limiting Circuit Breakers, these curves are maximum let-through values.

## 100% Rated

Some models of the H-, J-, and L-frame circuit breakers are UL Listed / CSA Certified to be applied at up to 100% of their current rating. Because of the additional heat generated, the use of specially-designed enclosures on H- and J-frame circuit breakers and 194°F (90°C) rated wire is required when applying circuit breakers at 100% of continuous current rating. (H-, J-, and L-frame circuit breakers can use aluminum or copper lugs.) Markings on the circuit breaker indicate the minimum enclosure size and ventilation required. The 194°F (90°C) wire must be sized according to the ampacities of the 167°F (75°C) wire column in the NEC. Circuit breakers with 100% rating can also be used in applications requiring only standard (80%) continuous loading.

100% ratings are valid for:

- Three-pole H/J-frame unit mount and busbar connection
- Three- pole/four-pole L-frame 250 A and 400 A unit mount
- Three-pole L-frame 250 A and 400 A I-Line
- Rear connection and switches

## Corner-Grounded Delta Ratings (1Ø-3Ø)

Circuit breakers suitable for corner-grounded circuits are marked 1Ø-3Ø. For additional information, refer to data bulletin 2700DB0202, *Corner-Grounded Delta (Grounded B Phase) Systems*.

### Corner-Grounded Delta Ratings (1Ø-3Ø)

	Two-Pole H-Frame					Two-Pole J-Frame				
	HD	HG	HJ <sup>44</sup>	HL <sup>44</sup>	HR <sup>44</sup>	JD <sup>44</sup>	JG <sup>44</sup>	JJ <sup>44</sup>	JL <sup>44</sup>	JR <sup>44</sup>
Ampere Rating (A)	15–150					150–250				
Voltage Rating (Vac)	240					240				
UL Interrupting Rating (kA)	42	42	65	100	–	42	42	65	100	–

### Three-Phase 240 Vac Corner-Grounded Delta System

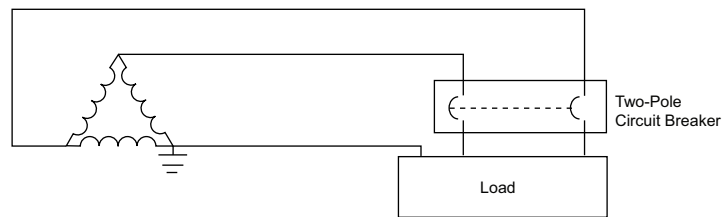

44. Built using three-pole module.

## Special Applications

### Protection of Industrial Control Panels

PowerPacT H-, J-, and L-frame circuit breakers are also used in industrial control panels. They serve as incoming devices or can be combined with contactors to protect motor feeders:

- compliance with worldwide standards including IEC 60947-2 and UL 508 / CSA C22.2 N°14
- overload and short-circuit protection
- installation in universal and functional type

PowerPacT H-, J-, and L-frame circuit breakers equipped for motor protection functions as described in the following pages can be used in industrial control panels. The accessories for the PowerPacT H-, J-, and L-frame circuit breakers are suitable for the special needs of these applications

### 400 Hz Applications

#### Impact on Protective Devices

The current in 400 Hz systems has higher losses caused by eddy currents and an increase in the skin effect (reduction in the useful cross-sectional area of conductors). The higher losses cause additional temperature rise in circuit breakers subjected to the higher frequency current. To remain within the rated temperature-rise limits of devices, current derating is required. For circuit breakers equipped with MicroLogic electronic trip units, only the current rating ( $I_r$ ) must be derated. See “Current Derating Maximum  $I_r$  Setting” below. On circuit breakers equipped with thermal-magnetic trip units, the current rating ( $I_n$ ) must be derated and the magnetic trip setting  $I_m$  must be increased. See “Current Rating ( $I_n$ ) and Magnetic Trip Setting ( $I_m$ ) Rerating” below.

#### Breaking Capacity in 400 Hz, 480 V Systems

The power levels of 400 Hz applications rarely exceed a few hundred kW with relatively low short-circuit currents, generally not exceeding four times the rated current

Circuit Breaker	Max. Breaking Capacity AIR at 400 Hz
H-frame	10 kA
J-frame	10 kA
L-frame	10 kA

### MicroLogic Electronic Trip Units

MicroLogic 3.2/3, 5.2/3 A or E and 6.2/3 with A or E measurement functions are suitable for 400 Hz. The use of electronics offers the advantage of greater operating stability when the frequency varies. However the units are still subject to temperature rise caused by the frequency.

The practical consequences are:

- limit settings: see the  $I_r$  derating table below
- the long-time, short-time and instantaneous pick-ups are not modified (see MicroLogic 3 Trip Units, page 106 or MicroLogic 5/6 A or E Trip Units, page 109)
- the accuracy of the displayed measurements is 2% (Class II)

### Current Derating Maximum $I_r$ Setting

Circuit Breaker	Maximum Setting Coefficient	Max $I_r$ Setting at 400 Hz
H-frame, 150 A	0.9	135
J-frame, 250 A	0.9	225
L-frame, 400 A	0.8	320
L-frame, 600 A	0.65	390

### Thermal-Magnetic Trip Units

Thermal-magnetic trip units require the current rating ( $I_n$ ) to be derated and the magnetic trip setting ( $I_m$ ) to be increased.

### Current Rating ( $I_n$ ) and Magnetic Trip Setting ( $I_m$ ) Derating

Circuit Breaker	Maximum Setting Coefficient	Max $I_r$ Setting at 400 Hz	Magnetic $I_m$ Coefficient at 400 Hz
H-frame, 150 A	0.9	135	1.6
J-frame, 250 A	0.9	225	1.6
L-frame, 400 A	0.8	320	1.6
L-frame, 600 A	0.65	390	1.6

### Auxiliary Switch (OF) in 400 Hz Networks

#### Electrical Characteristics of Auxiliary Switches

Contact		Standard		Low Level	
Utilization cat. (IEC 60947-5-1)		AC12	AC15	AC12	AC15
Operational current	24 V	6 A	6 A	5 A	3 A
	40 V	6 A	6 A	5 A	3 A
	110 V	6 A	5 A	5 A	2.5 A
	200/240 V	6 A	4 A	5 A	2 A
	380/415 V	6 A	2 A	5 A	1.5 A

### Shunt Trip (MX) or Undervoltage Trip (MN) Voltage Release at 400 Hz and 440 V

For circuit breakers on 400 Hz systems, only 125 Vdc undervoltage trip (MN) or shunt trip (MX) releases may be used. The release must be supplied by the 400 Hz system through a rectifier bridge (to be selected from the table below) and an additional resistor with characteristics depending on the system voltage.

#### Rectifier Bridges for MN or MX Releases

Voltage	Rectifier	Additional Resistor
220/240 V	Thomson 110 BHz or General Instrument W06 or Semikron SKB at 1.2/1.3	4.2 k -5 W
380/240 V	Semikron SKB at 1.2/1.3	10.7 k -10 W

# H- and J-Frame Catalog Numbers

## Unit-Mount Circuit Breaker Catalog Numbers

**PowerPacT H-Frame Standard (80%) Rated 150 A Unit-Mount Thermal-Magnetic Circuit Breakers (600 Vac, 250 Vdc) with Factory-Sealed Trip Unit (Suitable for Reverse Connection)**

Current Rating at 104°F (40°C) <sup>45</sup>	Fixed AC Magnetic Trip		Interrupting Rating			
	Hold	Trip	D	G	J <sup>46</sup>	L <sup>46</sup>
<b>H-Frame, 150 A, Two-Pole, 600 Vac 50/60 Hz, 250 Vdc<sup>47</sup></b>						
15 A	350 A	750 A	HDL26015	HGL26015	HJL26015	HLL26015
20 A	350 A	750 A	HDL26020	HGL26020	HJL26020	HLL26020
25 A	350 A	750 A	HDL26025	HGL26025	HJL26025	HLL26025
30 A	350 A	750 A	HDL26030	HGL26030	HJL26030	HLL26030
35 A	400 A	850 A	HDL26035	HGL26035	HJL26035	HLL26035
40 A	400 A	850 A	HDL26040	HGL26040	HJL26040	HLL26040
45 A	400 A	850 A	HDL26045	HGL26045	HJL26045	HLL26045
50 A	400 A	850 A	HDL26050	HGL26050	HJL26050	HLL26050
60 A	800 A	1450 A	HDL26060	HGL26060	HJL26060	HLL26060
70 A	800 A	1450 A	HDL26070	HGL26070	HJL26070	HLL26070
80 A	800 A	1450 A	HDL26080	HGL26080	HJL26080	HLL26080
90 A	800 A	1450 A	HDL26090	HGL26090	HJL26090	HLL26090
100 A	900 A	1700 A	HDL26100	HGL26100	HJL26100	HLL26100
110 A	900 A	1700 A	HDL26110	HGL26110	HJL26110	HLL26110
125 A	900 A	1700 A	HDL26125	HGL26125	HJL26125	HLL26125
150 A	900 A	1700 A	HDL26150	HGL26150	HJL26150	HLL26150
<b>H-Frame, 150 A, Three-Pole, 600 Vac 50/60 Hz, 250 Vdc</b>						
15 A	350 A	750 A	HDL36015	HGL36015	HJL36015	HLL36015
20 A	350 A	750 A	HDL36020	HGL36020	HJL36020	HLL36020
25 A	350 A	750 A	HDL36025	HGL36025	HJL36025	HLL36025
30 A	350 A	750 A	HDL36030	HGL36030	HJL36030	HLL36030
35 A	400 A	850 A	HDL36035	HGL36035	HJL36035	HLL36035
40 A	400 A	850 A	HDL36040	HGL36040	HJL36040	HLL36040
45 A	400 A	850 A	HDL36045	HGL36045	HJL36045	HLL36045
50 A	400 A	850 A	HDL36050	HGL36050	HJL36050	HLL36050
60 A	800 A	1450 A	HDL36060	HGL36060	HJL36060	HLL36060
70 A	800 A	1450 A	HDL36070	HGL36070	HJL36070	HLL36070
80 A	800 A	1450 A	HDL36080	HGL36080	HJL36080	HLL36080
90 A	800 A	1450 A	HDL36090	HGL36090	HJL36090	HLL36090
100 A	900 A	1700 A	HDL36100	HGL36100	HJL36100	HLL36100
110 A	900 A	1700 A	HDL36110	HGL36110	HJL36110	HLL36110

45. Standard lug kit: AL150HD, Terminal wire range: 14–3/0 AWG Al or Cu.

46. UL Listed/CSA Certified as current-limiting circuit breakers.

47. HD and HG circuit breakers are true two-pole construction.

**PowerPacT H-Frame Standard (80%) Rated 150 A Unit-Mount Thermal-Magnetic Circuit Breakers (600 Vac, 250 Vdc) with Factory-Sealed Trip Unit (Suitable for Reverse Connection) (Continued)**

Current Rating at 104°F (40°C) <sup>48</sup>	Fixed AC Magnetic Trip		Interrupting Rating			
	Hold	Trip	D	G	J <sup>49</sup>	L <sup>49</sup>
125 A	900 A	1700 A	HDL36125	HGL36125	HJL36125	HLL36125
150 A	900 A	1700 A	HDL36150	HGL36150	HJL36150	HLL36150

**PowerPacT H-Frame 100% Rated 150 A Unit-Mount Thermal-Magnetic Circuit Breakers (600 Vac, 250 Vdc) with Factory-Sealed Trip Unit (Suitable for Reverse Connection)**

Current Rating at 104°F (40°C) <sup>48</sup>	Fixed AC Magnetic Trip		Interrupting Rating			
	Hold	Trip	D	G	J <sup>49</sup>	L <sup>49</sup>
<b>H-Frame, 150 A, Two-Pole, 600 Vac 50/60 Hz, 250 Vdc<sup>50</sup></b>						
15 A	350 A	750 A	HDL26015C	HGL26015C	HJL26015C	HLL26015C
20 A	350 A	750 A	HDL26020C	HGL26020C	HJL26020C	HLL26020C
25 A	350 A	750 A	HDL26025C	HGL26025C	HJL26025C	HLL26025C
30 A	350 A	750 A	HDL26030C	HGL26030C	HJL26030C	HLL26030C
35 A	400 A	850 A	HDL26035C	HGL26035C	HJL26035C	HLL26035C
40 A	400 A	850 A	HDL26040C	HGL26040C	HJL26040C	HLL26040C
45 A	400 A	850 A	HDL26045C	HGL26045C	HJL26045C	HLL26045C
50 A	400 A	850 A	HDL26050C	HGL26050C	HJL26050C	HLL26050C
60 A	800 A	1450 A	HDL26060C	HGL26060C	HJL26060C	HLL26060C
70 A	800 A	1450 A	HDL26070C	HGL26070C	HJL26070C	HLL26070C
80 A	800 A	1450 A	HDL26080C	HGL26080C	HJL26080C	HLL26080C
90 A	800 A	1450 A	HDL26090C	HGL26090C	HJL26090C	HLL26090C
100 A	900 A	1700 A	HDL26100C	HGL26100C	HJL26100C	HLL26100C
110 A	900 A	1700 A	HDL26110C	HGL26110C	HJL26110C	HLL26110C
125 A	900 A	1700 A	HDL26125C	HGL26125C	HJL26125C	HLL26125C
150 A	900 A	1700 A	HDL26150C	HGL26150C	HJL26150C	HLL26150C
<b>H-Frame, 150 A, Three-Pole, 600 Vac 50/60 Hz, 250 Vdc</b>						
15 A	350 A	750 A	HDL36015C	HGL36015C	HJL36015C	HLL36015C
20 A	350 A	750 A	HDL36020C	HGL36020C	HJL36020C	HLL36020C
25 A	350 A	750 A	HDL36025C	HGL36025C	HJL36025C	HLL36025C
30 A	350 A	750 A	HDL36030C	HGL36030C	HJL36030C	HLL36030C
35 A	400 A	850 A	HDL36035C	HGL36035C	HJL36035C	HLL36035C
40 A	400 A	850 A	HDL36040C	HGL36040C	HJL36040C	HLL36040C
45 A	400 A	850 A	HDL36045C	HGL36045C	HJL36045C	HLL36045C
50 A	400 A	850 A	HDL36050C	HGL36050C	HJL36050C	HLL36050C
60 A	800 A	1450 A	HDL36060C	HGL36060C	HJL36060C	HLL36060C
70 A	800 A	1450 A	HDL36070C	HGL36070C	HJL36070C	HLL36070C
80 A	800 A	1450 A	HDL36080C	HGL36080C	HJL36080C	HLL36080C
90 A	800 A	1450 A	HDL36090C	HGL36090C	HJL36090C	HLL36090C
100 A	900 A	1700 A	HDL36100C	HGL36100C	HJL36100C	HLL36100C

48. Standard lug kit: AL150HD, Terminal wire range: 14–3/0 AWG Al or Cu.

49. UL Listed/CSA Certified as current-limiting circuit breakers.

50. HD and HG circuit breakers are true two-pole construction.



**PowerPacT H-Frame 100% Rated 150 A Unit-Mount Thermal-Magnetic Circuit Breakers (600 Vac, 250 Vdc) with Factory-Sealed Trip Unit (Suitable for Reverse Connection) (Continued)**

Current Rating at 104°F (40°C) <sup>51</sup>	Fixed AC Magnetic Trip		Interrupting Rating			
	Hold	Trip	D	G	J <sup>52</sup>	L <sup>52</sup>
110 A	900 A	1700 A	HDL36110C	HGL36110C	HJL36110C	HLL36110C
125 A	900 A	1700 A	HDL36125C	HGL36125C	HJL36125C	HLL36125C
150 A	900 A	1700 A	HDL36150C	HGL36150C	HJL36150C	HLL36150C

**PowerPacT J-Frame Standard (80%) Rated 250 A Unit-Mount Thermal-Magnetic Circuit Breakers with Factory-Sealed Trip Unit (Suitable for Reverse Connection)**

Current Rating at 104°F (40°C)	Adjustable AC Magnetic Trip		Interrupting Rating				
	Hold	Trip	D	G	J <sup>52</sup>	L <sup>52</sup>	R <sup>52</sup>
<b>J-Frame, 250 A, Two-Pole, 600 Vac 50/60 Hz, 250 Vdc</b>							
150 A <sup>53</sup>	750 A	1500 A	JDL26150	JGL26150	JJL26150	JLL26150	—
175 A <sup>53</sup>	875 A	1750 A	JDL26175	JGL26175	JJL26175	JLL26175	—
200 A <sup>54</sup>	1000 A	2000 A	JDL26200	JGL26200	JJL26200	JLL26200	—
225 A <sup>54</sup>	1125 A	2250 A	JDL26225	JGL26225	JJL26225	JLL26225	—
250 A <sup>54</sup>	1250 A	2500 A	JDL26250	JGL26250	JJL26250	JLL26250	—
<b>J-Frame, 250 A, Three-Pole, 600 Vac 50/60 Hz, 250 Vdc</b>							
150 A <sup>53</sup>	750 A	1500 A	JDL36150	JGL36150	JJL36150	JLL36150	JRL36150
175 A <sup>53</sup>	875 A	1750 A	JDL36175	JGL36175	JJL36175	JLL36175	JRL36175
200 A <sup>54</sup>	1000 A	2000 A	JDL36200	JGL36200	JJL36200	JLL36200	JRL36200
225 A <sup>54</sup>	1125 A	2250 A	JDL36225	JGL36225	JJL36225	JLL36225	JRL36225
250 A <sup>54</sup>	1250 A	2500 A	JDL36250	JGL36250	JJL36250	JLL36250	JRL36250

**PowerPacT J-Frame 100% Rated 250 A Unit-Mount Thermal-Magnetic Circuit Breakers with Factory-Sealed Trip Unit (Suitable for Reverse Connection)**

Current Rating at 104°F (40°C)	Adjustable AC Magnetic Trip		Interrupting Rating				
	Hold	Trip	D	G	J <sup>52</sup>	L <sup>52</sup>	R <sup>52</sup>
<b>J-Frame, 250 A, Two-Pole, 600 Vac 50/60 Hz, 250 Vdc</b>							
150 A <sup>53</sup>	750 A	1500 A	JDL26150C	JGL26150C	JJL26150C	JLL26150C	—
175 A <sup>53</sup>	875 A	1750 A	JDL26175C	JGL26175C	JJL26175C	JLL26175C	—
200 A <sup>54</sup>	1000 A	2000 A	JDL26200C	JGL26200C	JJL26200C	JLL26200C	—
225 A <sup>54</sup>	1125 A	2250 A	JDL26225C	JGL26225C	JJL26225C	JLL26225C	—
250 A <sup>54</sup>	1250 A	2500 A	JDL26250C	JGL26250C	JJL26250C	JLL26250C	—
<b>J-Frame, 250 A, Three-Pole, 600 Vac 50/60 Hz, 250 Vdc</b>							
150 A <sup>53</sup>	750 A	1500 A	JDL36150C	JGL36150C	JJL36150C	JLL36150C	JRL36150C
175 A <sup>53</sup>	875 A	1750 A	JDL36175C	JGL36175C	JJL36175C	JLL36175C	JRL36175C
200 A <sup>54</sup>	1000 A	2000 A	JDL36200C	JGL36200C	JJL36200C	JLL36200C	JRL36200C
225 A <sup>54</sup>	1125 A	2250 A	JDL36225C	JGL36225C	JJL36225C	JLL36225C	JRL36225C
250 A <sup>54</sup>	1250 A	2500 A	JDL36250C	JGL36250C	JJL36250C	JLL36250C	JRL36250C

51. Standard lug kit: AL150HD, Terminal wire range: 14–3/0 AWG Al or Cu.

52. UL Listed/CSA Certified as current-limiting circuit breakers.

53. Standard lug kit: AL175JD, Terminal wire range: 4–4/0 AWG Al or Cu.

54. Standard lug kit: AL250JD, Terminal wire range: 3/0 AWG–350 kcmil Al or Cu.

**H-Frame 150 A and J-Frame 250 A Electronic Trip UL Rated Circuit Breakers (600 Vac, 50/60 Hz) With Factory-Sealed Trip Unit Suitable for Reverse Connection**

Electronic Trip Unit			Sensor Rating	Interrupting Rating				
Type	Function	Trip Unit		D	G	J <sup>55</sup>	L <sup>56</sup>	R <sup>56</sup>
<b>Standard (80%) Rated Circuit Breakers, Three-Pole</b>								
Standard	LI	3.2 <sup>56</sup>	60 A <sup>57</sup>	HDL36060U31X	HGL36060U31X	HJL36060U31X	HLL36060U31X	HRL36060U31X
			100 A <sup>57</sup>	HDL36100U31X	HGL36100U31X	HJL36100U31X	HLL36100U31X	HRL36100U31X
			150 A <sup>57</sup>	HDL36150U31X	HGL36150U31X	HJL36150U31X	HLL36150U31X	HRL36150U31X
			250 A <sup>58</sup>	JDL36250U31X	JGL36250U31X	JJL36250U31X	JLL36250U31X	JRL36250U31X
Standard	LSI	3.2S <sup>56</sup>	60 A <sup>57</sup>	HDL36060U33X	HGL36060U33X	HJL36060U33X	HLL36060U33X	HRL36060U33X
			100 A <sup>57</sup>	HDL36100U33X	HGL36100U33X	HJL36100U33X	HLL36100U33X	HRL36100U33X
			150 A <sup>57</sup>	HDL36150U33X	HGL36150U33X	HJL36150U33X	HLL36150U33X	HRL36150U33X
			250 A <sup>58</sup>	JDL36250U33X	JGL36250U33X	JJL36250U33X	JLL36250U33X	JRL36250U33X
Ammeter	LSI	5.2A	60 A <sup>57</sup>	HDL36060U43X	HGL36060U43X	HJL36060U43X	HLL36060U43X	HRL36060U43X
			100 A <sup>57</sup>	HDL36100U43X	HGL36100U43X	HJL36100U43X	HLL36100U43X	HRL36100U43X
			150 A <sup>57</sup>	HDL36150U43X	HGL36150U43X	HJL36150U43X	HLL36150U43X	HRL36150U43X
			250 A <sup>58</sup>	JDL36250U43X	JGL36250U43X	JJL36250U43X	JLL36250U43X	JRL36250U43X
Energy	LSI	5.2E	60 A <sup>57</sup>	HDL36060U53X	HGL36060U53X	HJL36060U53X	HLL36060U53X	HRL36060U53X
			100 A <sup>57</sup>	HDL36100U53X	HGL36100U53X	HJL36100U53X	HLL36100U53X	HRL36100U53X
			150 A <sup>57</sup>	HDL36150U53X	HGL36150U53X	HJL36150U53X	HLL36150U53X	HRL36150U53X
			250 A <sup>58</sup>	JDL36250U53X	JGL36250U53X	JJL36250U53X	JLL36250U53X	JRL36250U53X
Ammeter	LSIG	6.2A	60 A <sup>57</sup>	HDL36060U44X	HGL36060U44X	HJL36060U44X	HLL36060U44X	HRL36060U44X
			100 A <sup>57</sup>	HDL36100U44X	HGL36100U44X	HJL36100U44X	HLL36100U44X	HRL36100U44X
			150 A <sup>57</sup>	HDL36150U44X	HGL36150U44X	HJL36150U44X	HLL36150U44X	HRL36150U44X
			250 A <sup>58</sup>	JDL36250U44X	JGL36250U44X	JJL36250U44X	JLL36250U44X	JRL36250U44X
Energy	LSIG	6.2E	60 A <sup>57</sup>	HDL36060U54X	HGL36060U54X	HJL36060U54X	HLL36060U54X	HRL36060U54X
			100 A <sup>57</sup>	HDL36100U54X	HGL36100U54X	HJL36100U54X	HLL36100U54X	HRL36100U54X
			150 A <sup>57</sup>	HDL36150U54X	HGL36150U54X	HJL36150U54X	HLL36150U54X	HRL36150U54X
			250 A <sup>58</sup>	JDL36250U54X	JGL36250U54X	JJL36250U54X	JLL36250U54X	JRL36250U54X
<b>100% Rated Circuit Breakers, Three-Pole</b>								
Standard	LI	3.2 <sup>56</sup>	60 A <sup>57</sup>	HDL36060CU31X	HGL36060CU31X	HJL36060CU31X	HLL36060CU31X	HRL36060CU31X
			100 A <sup>57</sup>	HDL36100CU31X	HGL36100CU31X	HJL36100CU31X	HLL36100CU31X	HRL36100CU31X
			150 A <sup>57</sup>	HDL36150CU31X	HGL36150CU31X	HJL36150CU31X	HLL36150CU31X	HRL36150CU31X
			250 A <sup>58</sup>	JDL36250CU31X	JGL36250CU31X	JJL36250CU31X	JLL36250CU31X	JRL36250CU31X
Standard	LSI	3.2S <sup>56</sup>	60 A <sup>57</sup>	HDL36060CU33X	HGL36060CU33X	HJL36060CU33X	HLL36060CU33X	HRL36060CU33X
			100 A <sup>57</sup>	HDL36100CU33X	HGL36100CU33X	HJL36100CU33X	HLL36100CU33X	HRL36100CU33X
			150 A <sup>57</sup>	HDL36150CU33X	HGL36150CU33X	HJL36150CU33X	HLL36150CU33X	HRL36150CU33X
			250 A <sup>58</sup>	JDL36250CU33X	JGL36250CU33X	JJL36250CU33X	JLL36250CU33X	JRL36250CU33X
Ammeter	LSI	5.2A	60 A <sup>57</sup>	HDL36060CU43X	HGL36060CU43X	HJL36060CU43X	HLL36060CU43X	HRL36060CU43X
			100 A <sup>57</sup>	HDL36100CU43X	HGL36100CU43X	HJL36100CU43X	HLL36100CU43X	HRL36100CU43X
			150 A <sup>57</sup>	HDL36150CU43X	HGL36150CU43X	HJL36150CU43X	HLL36150CU43X	HRL36150CU43X

55. UL Listed/CSA Certified as current-limiting circuit breakers.

56. Three-pole circuit breakers with this trip unit can be used for two-pole applications.

57. Standard lug kit: AL150HD. Terminal wire range: 14–3/0 AWG Al or Cu.

58. Standard lug kit: AL250JD. Terminal wire range: 3/0 AWG–350 kcmil Al or Cu.

For smaller wire range (4–4/0 AWG Al or Cu), replace the lug's wire binding screws with the larger binding screws provided.

### H-Frame 150 A and J-Frame 250 A Electronic Trip UL Rated Circuit Breakers (600 Vac, 50/60 Hz) With Factory-Sealed Trip Unit Suitable for Reverse Connection (Continued)

Electronic Trip Unit			Sensor Rating	Interrupting Rating				
Type	Function	Trip Unit		D	G	J <sup>59</sup>	L <sup>60</sup>	R <sup>60</sup>
			250 A <sup>59</sup>	JDL36250CU43X	JGL36250CU43X	JJL36250CU43X	JLL36250CU43X	JRL36250CU43X
Energy	LSI	5.2E	60 A <sup>60</sup>	HDL36060CU53X	HGL36060CU53X	HJL36060CU53X	HLL36060CU53X	HRL36060CU53X
			100 A <sup>60</sup>	HDL36100CU53X	HGL36100CU53X	HJL36100CU53X	HLL36100CU53X	HRL36100CU53X
			150 A <sup>60</sup>	HDL36150CU53X	HGL36150CU53X	HJL36150CU53X	HLL36150CU53X	HRL36150CU53X
			250 A <sup>59</sup>	JDL36250CU53X	JGL36250CU53X	JJL36250CU53X	JLL36250CU53X	JRL36250CU53X

### J-Frame 250 A Mission Critical Electronic Trip UL Rated Circuit Breakers (Three-Pole, 480Y/277 Vac, 50/60 Hz) With Factory-Sealed Trip Unit Suitable for Reverse Connection

Electronic Trip Unit			Sensor Rating	Interrupting Rating <sup>59</sup>			
Type	Function	Trip Unit		D	G	J	L
<b>Standard (80%) Rated Circuit Breakers, Three-Pole</b>							
Standard	LI	3.2-W	250 A	JDL34250WU31X	JGL34250WU31X	JJL34250WU31X	JLL34250WU31X
Standard	LSI	3.2S-W	250 A	JDL34250WU33X	JGL34250WU33X	JJL34250WU33X	JLL34250WU33X
Ammeter	LSI	5.2A-W	250 A	JDL34250WU43X	JGL34250WU43X	JJL34250WU43X	JLL34250WU43X
Energy	LSI	5.2E-W	250 A	JDL34250WU53X	JGL34250WU53X	JJL34250WU53X	JLL34250WU53X
Ammeter	LSIG	6.2A-W	250 A	JDL34250WU44X	JGL34250WU44X	JJL34250WU44X	JLL34250WU44X
Energy	LSIG	6.2E-W	250 A	JDL34250WU54X	JGL34250WU54X	JJL34250WU54X	JLL34250WU54X

## I-Line Circuit Breaker Catalog Numbers

### PowerPacT H-Frame 150 A I-Line Thermal-Magnetic Circuit Breakers with Factory-Sealed Trip Unit (Suitable for Reverse Connection)

Current Rating at 104°F (40°C) 60	Fixed AC Magnetic Trip		Interrupting Rating <sup>61</sup> Standard (80%) Rated <sup>62</sup>			
	Hold	Trip	D	G	J <sup>59</sup>	L <sup>59</sup>
<b>H-Frame, 150 A, Two-Pole, 600 Vac 50/60 Hz, 250 Vdc</b>						
15 A	350 A	750 A	HDA26015()	HGA26015()	HJA26015()	HLA26015()
20 A	350 A	750 A	HDA26020()	HGA26020()	HJA26020()	HLA26020()
25 A	350 A	750 A	HDA26025()	HGA26025()	HJA26025()	HLA26025()
30 A	350 A	750 A	HDA26030()	HGA26030()	HJA26030()	HLA26030()
35 A	400 A	850 A	HDA26035()	HGA26035()	HJA26035()	HLA26035()
40 A	400 A	850 A	HDA26040()	HGA26040()	HJA26040()	HLA26040()
45 A	400 A	850 A	HDA26045()	HGA26045()	HJA26045()	HLA26045()

59. UL Listed/CSA Certified as current-limiting circuit breakers.

60. Three-pole circuit breakers with this trip unit can be used for two-pole applications.

59. Standard lug kit: AL250JD. Terminal wire range: 3/0 AWG–350 kcmil Al or Cu.

For smaller wire range (4–4/0 AWG Al or Cu), replace the lug's wire binding screws with the larger binding screws provided.

60. Standard lug kit: AL150HD. Terminal wire range: 14–3/0 AWG Al or Cu.

61. () Indicates phasing. See Catalog Numbering, page 10.

62. No 100% I-Line available.

**PowerPacT H-Frame 150 A I-Line Thermal-Magnetic Circuit Breakers with Factory-Sealed Trip Unit (Suitable for Reverse Connection) (Continued)**

Current Rating at 104°F (40°C) <sup>63</sup>	Fixed AC Magnetic Trip		Interrupting Rating <sup>64</sup> Standard (80%) Rated <sup>65</sup>			
	Hold	Trip	D	G	J <sup>66</sup>	L <sup>66</sup>
50 A	400 A	850 A	HDA26050( )	HGA26050( )	HJA26050( )	HLA26050( )
60 A	800 A	1450 A	HDA26060( )	HGA26060( )	HJA26060( )	HLA26060( )
70 A	800 A	1450 A	HDA26070( )	HGA26070( )	HJA26070( )	HLA26070( )
80 A	800 A	1450 A	HDA26080( )	HGA26080( )	HJA26080( )	HLA26080( )
90 A	800 A	1450 A	HDA26090( )	HGA26090( )	HJA26090( )	HLA26090( )
100 A	900 A	1700 A	HDA26100( )	HGA26100( )	HJA26100( )	HLA26100( )
110 A	900 A	1700 A	HDA26110( )	HGA26110( )	HJA26110( )	HLA26110( )
125 A	900 A	1700 A	HDA26125( )	HGA26125( )	HJA26125( )	HLA26125( )
150 A	900 A	1700 A	HDA26150( )	HGA26150( )	HJA26150( )	HLA26150( )
<b>H-Frame, 150 A, Three-Pole, 600 Vac 50/60 Hz, 250 Vdc</b>						
15 A	350 A	750 A	HDA36015	HGA36015	HJA36015	HLA36015
20 A	350 A	750 A	HDA36020	HGA36020	HJA36020	HLA36020
25 A	350 A	750 A	HDA36025	HGA36025	HJA36025	HLA36025
30 A	350 A	750 A	HDA36030	HGA36030	HJA36030	HLA36030
35 A	400 A	850 A	HDA36035	HGA36035	HJA36035	HLA36035
40 A	400 A	850 A	HDA36040	HGA36040	HJA36040	HLA36040
45 A	400 A	850 A	HDA36045	HGA36045	HJA36045	HLA36045
50 A	400 A	850 A	HDA36050	HGA36050	HJA36050	HLA36050
60 A	800 A	1450 A	HDA36060	HGA36060	HJA36060	HLA36060
70 A	800 A	1450 A	HDA36070	HGA36070	HJA36070	HLA36070
80 A	800 A	1450 A	HDA36080	HGA36080	HJA36080	HLA36080
90 A	800 A	1450 A	HDA36090	HGA36090	HJA36090	HLA36090
100 A	900 A	1700 A	HDA36100	HGA36100	HJA36100	HLA36100
110 A	900 A	1700 A	HDA36110	HGA36110	HJA36110	HLA36110
125 A	900 A	1700 A	HDA36125	HGA36125	HJA36125	HLA36125
150 A	900 A	1700 A	HDA36150	HGA36150	HJA36150	HLA36150

**PowerPacT J-Frame 250 A I-Line Thermal-Magnetic Circuit Breakers with Factory-Sealed Trip Unit (Suitable for Reverse Connection)**

Current Rating at 104°F (40°C)	Adjustable AC Magnetic Trip		Interrupting Rating <sup>64</sup> Standard <sup>66</sup> (80%) Rated <sup>65</sup>				
	Hold	Trip	D	G	J <sup>67</sup>	L <sup>67</sup>	R3 <sup>67</sup>
<b>J-Frame, 250 A, Two-Pole, 600 Vac 50/60 Hz, 250 Vdc</b>							
150 A <sup>68</sup>	750 A	1500 A	JDA26150( )	JGA26150( )	JJA26150( )	—	—
175 A <sup>68</sup>	875 A	1750 A	JDA26175( )	JGA26175( )	JJA26175( )	—	—

63. Standard lug kit: AL150HD. Terminal wire range: 14–3/0 AWG Al or Cu.

64. ( ) Indicates phasing. See Catalog Numbering, page 10.

65. No 100% I-Line available.

66. UL Listed/CSA Certified as current-limiting circuit breakers.

67. UL Listed/CSA Certified as current-limiting.

68. Standard lug kit: AL175JD. Terminal wire range: 4–4/0 AWG Al or Cu.

### PowerPacT J-Frame 250 A I-Line Thermal-Magnetic Circuit Breakers with Factory-Sealed Trip Unit (Suitable for Reverse Connection) (Continued)

Current Rating at 104°F (40°C)	Adjustable AC Magnetic Trip		Interrupting Rating <sup>69</sup> Standard <sup>70</sup> (80%) Rated <sup>71</sup>				
	Hold	Trip	D	G	J <sup>72</sup>	L <sup>372</sup>	R <sup>372</sup>
200 A <sup>73</sup>	1000 A	2000 A	JDA26200( )	JGA26200( )	JJA26200( )	—	—
225 A <sup>73</sup>	1125 A	2250 A	JDA26225( )	JGA26225( )	JJA26225( )	—	—
250 A <sup>73</sup>	1250 A	2500 A	JDA26250( )	JGA26250( )	JJA26250( )	—	—
J-Frame, 250 A, Three-Pole, 600 Vac 50/60 Hz, 250 Vdc							
150 A <sup>74</sup>	750 A	1500 A	JDA36150	JGA36150	JJA36150	JLA36150	JRA36150
175 A <sup>74</sup>	875 A	1750 A	JDA36175	JGA36175	JJA36175	JLA36175	JRA36175
200 A <sup>73</sup>	1000 A	2000 A	JDA36200	JGA36200	JJA36200	JLA36200	JRA36200
225 A <sup>73</sup>	1125 A	2250 A	JDA36225	JGA36225	JJA36225	JLA36225	JRA36225
250 A <sup>73</sup>	1250 A	2500 A	JDA36250	JGA36250	JJA36250	JLA36250	JRA36250

### H-Frame 150 A and J-Frame 250 A I-Line Standard (80%) Rated Electronic Trip UL Rated Circuit Breakers (Three-Pole, 600 Vac, 50/60 Hz) With Factory-Sealed Trip Unit Suitable for Reverse Connection

Electronic Trip Unit			Sensor Rating	Interrupting Rating				
Type <sup>71</sup>	Function	Trip Unit		D	G	J <sup>70</sup>	L <sup>70</sup>	R <sup>70</sup>
Standard	LI	3.2 <sup>75</sup>	60 A <sup>76</sup>	HDA36060U31X	HGA36060U31X	HJA36060U31X	HLA36060U31-X	HRA36060U31X
			100 A <sup>76</sup>	HDA36100U31X	HGA36100U31X	HJA36100U31X	HLA36100U31-X	HRA36100U31X
			150 A <sup>76</sup>	HDA36150U31X	HGA36150U31X	HJA36150U31X	HLA36150U31-X	HRA36150U31X
			250 A <sup>75 77</sup>	JDA36250U31X	JGA36250U31X	JJA36250U31X	JLA36250U31X	JRA36250U31X
Standard	LSI	3.2S <sup>75</sup>	60 A <sup>76</sup>	HDA36060U33X	HGA36060U33X	HJA36060U33X	HLA36060U33-X	HRA36060U33X
			100 A <sup>76</sup>	HDA36100U33X	HGA36100U33X	HJA36100U33X	HLA36100U33-X	HRA36100U33X
			150 A <sup>76</sup>	HDA36150U33X	HGA36150U33X	HJA36150U33X	HLA36150U33-X	HRA36150U33X
			250 A <sup>75 77</sup>	JDA36250U33X	JGA36250U33X	JJA36250U33X	JLA36250U33X	JRA36250U33X
Ammeter	LSI	5.2A	60 A <sup>76</sup>	HDA36060U43X	HGA36060U43X	HJA36060U43X	HLA36060U43-X	HRA36060U43X
			100 A <sup>76</sup>	HDA36100U43X	HGA36100U43X	HJA36100U43X	HLA36100U43-X	HRA36100U43X
			150 A <sup>76</sup>	HDA36150U43X	HGA36150U43X	HJA36150U43X	HLA36150U43-X	HRA36150U43X
			250 A <sup>75 77</sup>	JDA36250U43X	JGA36250U43X	JJA36250U43X	JLA36250U43X	JRA36250U43X

69. ( ) Indicates phasing. See Catalog Numbering, page 10.

70. UL Listed/CSA Certified as current-limiting circuit breakers.

71. No 100% I-Line available.

72. UL Listed/CSA Certified as current-limiting.

73. Standard lug kit: AL250JD. Terminal wire range: 3/0 AWG–350 kcmil Al or Cu.

74. Standard lug kit: AL175JD. Terminal wire range: 4–4/0 AWG Al or Cu.

75. Three-pole circuit breakers with this trip unit can be used for two-pole applications.

76. Standard lug kit: AL150HD. Terminal wire range: 14–3/0 AWG Al or Cu.

77. Standard lug kit: AL250JD. Terminal wire range: 3/0 AWG–350 kcmil Al or Cu.

For smaller wire range (4–4/0 AWG Al or Cu), replace the lug's wire binding screws with the larger binding screws provided.

**H-Frame 150 A and J-Frame 250 A I-Line Standard (80%) Rated Electronic Trip UL Rated Circuit Breakers (Three-Pole, 600 Vac, 50/60 Hz) With Factory-Sealed Trip Unit Suitable for Reverse Connection (Continued)**

Electronic Trip Unit			Sensor Rating	Interrupting Rating				
Type <sup>78</sup>	Function	Trip Unit		D	G	J <sup>79</sup>	L <sup>79</sup>	R <sup>79</sup>
Energy	LSI	5.2E	60 A <sup>80</sup>	HDA36060U53X	HGA36060U53X	HJA36060U53X	HLA36060U53-X	HRA36060U53X
			100 A <sup>80</sup>	HDA36100U53X	HGA36100U53X	HJA36100U53X	HLA36100U53-X	HRA36100U53X
			150 A <sup>80</sup>	HDA36150U53X	HGA36150U53X	HJA36150U53X	HLA36150U53-X	HRA36150U53X
			250 A <sup>81</sup> <sub>82</sub>	JDA36250U53X	JGA36250U53X	JJA36250U53X	JLA36250U53X	JRA36250U53X
Ammeter	LSIG	6.2A <sup>83</sup>	60 A <sup>80</sup>	HDA36060U44X	HGA36060U44X	HJA36060U44X	HLA36060U44-X	HRA36060U44X
			100 A <sup>80</sup>	HDA36100U44X	HGA36100U44X	HJA36100U44X	HLA36100U44-X	HRA36100U44X
			150 A <sup>80</sup>	HDA36150U44X	HGA36150U44X	HJA36150U44X	HLA36150U44-X	HRA36150U44X
			250 A <sup>81</sup> <sub>82</sub>	JDA36250U44X	JGA36250U44X	JJA36250U44X	JLA36250U44X	JRA36250U44X
Energy	LSIG	6.2E	60 A <sup>80</sup>	HDA36060U54X	HGA36060U54X	HJA36060U54X	HLA36060U54-X	HRA36060U54X
			100 A <sup>80</sup>	HDA36100U54X	HGA36100U54X	HJA36100U54X	HLA36100U54-X	HRA36100U54X
			150 A <sup>80</sup>	HDA36150U54X	HGA36150U54X	HJA36150U54X	HLA36150U54-X	HRA36150U54X
			250 A <sup>81</sup> <sub>82</sub>	JDA36250U54X	JGA36250U54X	JJA36250U54X	JLA36250U54X	JRA36250U54X

**J-Frame 250 A Mission Critical I-Line Standard (80%) Rated Electronic Trip UL Rated Circuit Breakers (Three-Pole, 480Y/277 Vac, 50/60 Hz) With Factory-Sealed Trip Unit Suitable for Reverse Connection**

Electronic Trip Unit			Sensor Rating	Interrupting Rating <sup>82</sup>			
Type	Function	Trip Unit		D	G	J	L
Standard	LI	3.2-W	250 A	JDA34250WU31X	JGA34250WU31X	JJA34250WU31X	JLA34250WU31X
Standard	LSI	3.2S-W	250 A	JDA34250WU33X	JGA34250WU33X	JJA34250WU33X	JLA34250WU33X
Ammeter	LSI	5.2A-W	250 A	JDA34250WU43X	JGA34250WU43X	JJA34250WU43X	JLA34250WU43X
Energy	LSI	5.2E-W	250 A	JDA34250WU53X	JGA34250WU53X	JJA34250WU53X	JLA34250WU53X
Ammeter	LSIG	6.2A-W	250 A	JDA34250WU44X	JGA34250WU44X	JJA34250WU44X	JLA34250WU44X
Energy	LSIG	6.2E-W	250 A	JDA34250WU54X	JGA34250WU54X	JJA34250WU54X	JLA34250WU54X

78. No 100% I-Line available.

79. UL Listed/CSA Certified as current-limiting circuit breakers.

80. Standard lug kit: AL150HD. Terminal wire range: 14–3/0 AWG Al or Cu.

81. Three-pole circuit breakers with this trip unit can be used for two-pole applications.

82. Standard lug kit: AL250JD. Terminal wire range: 3/0 AWG–350 kcmil Al or Cu.

For smaller wire range (4–4/0 AWG Al or Cu), replace the lug's wire binding screws with the larger binding screws provided.

83. Three-pole circuit breakers with this trip unit can be used for two-pole applications in order to have ground fault protection. Additional metering capabilities will not work properly on the unconnected phase.

## Circuit Breakers with Field-Interchangeable Trip Units

### H-Frame 150 A Circuit Breaker Frame with Field-Interchangeable Thermal-Magnetic Trip Units (Three-Pole, 600 Vac, 250 Vdc)

Ampere Rating <sup>84</sup>	Fixed AC Magnetic Trip <sup>85</sup>		Interrupting Rating			
			D	G	J <sup>86</sup>	L <sup>86</sup>
	Hold	Trip	Cat. No.	Cat. No.	Cat. No.	Cat. No.
15 A	350 A	750 A	HDL36015T <sup>87</sup>	HGL36015T	HJL36015T	HLL36015T
20 A	350 A	750 A	HDL36020T	HGL36020T	HJL36020T	HLL36020T
25 A	350 A	750 A	HDL36025T	HGL36025T	HJL36025T	HLL36025T
30 A	350 A	750 A	HDL36030T	HGL36030T	HJL36030T	HLL36030T
35 A	400 A	850 A	HDL36035T	HGL36035T	HJL36035T	HLL36035T
40 A	400 A	850 A	HDL36040T	HGL36040T	HJL36040T	HLL36040T
45 A	400 A	850 A	HDL36045T	HGL36045T	HJL36045T	HLL36045T
50 A	400 A	850 A	HDL36050T	HGL36050T	HJL36050T	HLL36050T
60 A	800 A	1450 A	HDL36060T	HGL36060T	HJL36060T	HLL36060T
70 A	800 A	1450 A	HDL36070T	HGL36070T	HJL36070T	HLL36070T
80 A	800 A	1450 A	HDL36080T	HGL36080T	HJL36080T	HLL36080T
90 A	800 A	1450 A	HDL36090T	HGL36090T	HJL36090T	HLL36090T
100 A	900 A	1700 A	HDL36100T	HGL36100T	HJL36100T	HLL36100T
110 A	900 A	1700 A	HDL36110T	HGL36110T	HJL36110T	HLL36110T
125 A	900 A	1700 A	HDL36125T	HGL36125T	HJL36125T	HLL36125T
150 A	900 A	1700 A	HDL36150T	HGL36150T	HJL36150T	HLL36150T

### J-Frame 250 A Circuit Breaker Frame with Field-Interchangeable Thermal-Magnetic Trip Units (Three-Pole, 600 Vac, 250 Vdc)

Ampere Rating <sup>84</sup>	Adjustable AC Magnetic Trip		Interrupting Rating			
			D	G	J <sup>86</sup>	L <sup>88</sup>
	Low	High	Cat. No.	Cat. No.	Cat. No.	Cat. No.
150 A <sup>88</sup>	750 A	1500 A	JDL36150T <sup>87</sup>	JGL36150T	JJL36150T	JLL36150T
175 A <sup>88</sup>	875 A	1750 A	JDL36175T	JGL36175T	JJL36175T	JLL36175T
200 A <sup>89</sup>	1000 A	2000 A	JDL36200T	JGL36200T	JJL36200T	JLL36200T
225 A <sup>89</sup>	1125 A	2250 A	JDL36225T	JGL36225T	JJL36225T	JLL36225T
250 A <sup>89</sup>	1250 A	2500 A	JDL36250T	JGL36250T	JJL36250T	JLL36250T

84. Circuit breakers will be labeled with Line and Load markings and are not suitable for reverse connections.

Available on three-pole circuit breakers. Not allowed in I-Line, plug-in, or drawout devices. Not available in R interrupting rating.

85. Standard lug kit: AL150HD. Terminal wire range: 14–3/0 AWG Al or Cu.

86. UL Listed/CSA Certified as current-limiting circuit breakers.

87. For 100% rated circuit breakers replace the “T” suffix with “R.” Not available in I-Line, plug-in, or drawout constructions. Not available in R interrupting rating.

88. Standard lug kit: AL175JD. Terminal wire range: 4–4/0 AWG Al or Cu.

89. Standard lug kit: AL250JD. Terminal wire range: 3/0 AWG–350 kcmil Al or Cu.



## H-Frame 150 A and J-Frame 250 A Three-Pole Circuit Breakers with Lugs and Field-Interchangeable Electronic Trip Units (Standard (80%) Rated, 600 Vac, 50/60 Hz)

Electronic Trip Unit <sup>90 91</sup>			Sensor Size	Interrupting Rating			
Type	Function	Trip Unit		D	G	J <sup>92</sup>	L <sup>92</sup>
Standard	LI	3.2	60 A <sup>93</sup>	HDL36060TU31X <sup>94</sup>	HGL36060TU31X	HJL36060TU31X	HLL36060TU31X
			100 A <sup>93</sup>	HDL36100TU31X	HGL36100TU31X	HJL36100TU31X	HLL36100TU31X
			150 A <sup>93</sup>	HDL36150TU31X	HGL36150TU31X	HJL36150TU31X	HLL36150TU31X
			250 A <sup>95</sup>	JDL36250TU31X	JGL36250TU31X	JJL36250TU31X	JLL36250TU31X
Standard	LSI	3.2S	60 A <sup>93</sup>	HDL36060TU33X	HGL36060TU33X	HJL36060TU33X	HLL36060TU33X
			100 A <sup>93</sup>	HDL36100TU33X	HGL36100TU33X	HJL36100TU33X	HLL36100TU33X
			150 A <sup>93</sup>	HDL36150TU33X	HGL36150TU33X	HJL36150TU33X	HLL36150TU33X
			250 A <sup>95</sup>	JDL36250TU33X	JGL36250TU33X	JJL36250TU33X	JLL36250TU33X
Ammeter	LSI	5.2A	60 A <sup>93</sup>	HDL36060TU43X	HGL36060TU43X	HJL36060TU43X	HLL36060TU43X
			100 A <sup>93</sup>	HDL36100TU43X	HGL36100TU43X	HJL36100TU43X	HLL36100TU43X
			150 A <sup>93</sup>	HDL36150TU43X	HGL36150TU43X	HJL36150TU43X	HLL36150TU43X
			250 A <sup>95</sup>	JDL36250TU43X	JGL36250TU43X	JJL36250TU43X	JLL36250TU43X
Energy	LSI	5.2E	60 A <sup>93</sup>	HDL36060TU53X	HGL36060TU53X	HJL36060TU53X	HLL36060TU53X
			100 A <sup>93</sup>	HDL36100TU53X	HGL36100TU53X	HJL36100TU53X	HLL36100TU53X
			150 A <sup>93</sup>	HDL36150TU53X	HGL36150TU53X	HJL36150TU53X	HLL36150TU53X
			250 A <sup>95</sup>	JDL36250TU53X	JGL36250TU53X	JJL36250TU53X	JLL36250TU53X
Ammeter	LSIG	6.2A	60 A <sup>93</sup>	HDL36060TU44X	HGL36060TU44X	HJL36060TU44X	HLL36060TU44X
			100 A <sup>93</sup>	HDL36100TU44X	HGL36100TU44X	HJL36100TU44X	HLL36100TU44X
			150 A <sup>93</sup>	HDL36150TU44X	HGL36150TU44X	HJL36150TU44X	HLL36150TU44X
			250 A <sup>95</sup>	JDL36250TU44X	JGL36250TU44X	JJL36250TU44X	JLL36250TU44X
Energy	LSIG	6.2E	60 A <sup>93</sup>	HDL36060TU54X	HGL36060TU54X	HJL36060TU54X	HLL36060TU54X
			100 A <sup>93</sup>	HDL36100TU54X	HGL36100TU54X	HJL36100TU54X	HLL36100TU54X
			150 A <sup>93</sup>	HDL36150TU54X	HGL36150TU54X	HJL36150TU54X	HLL36150TU54X
			250 A <sup>95</sup>	JDL36250TU54X	JGL36250TU54X	JJL36250TU54X	JLL36250TU54X

### H-Frame and J-Frame Three-Pole Field-Installable Thermal-Magnetic Trip Units



15–60 A H-Frame		70–150 A H-Frame		150–250 A J-Frame	
Amperage	Cat. No.	Amperage	Cat. No.	Amperage	Cat. No.
15 A	HT3015	70 A	HT3070	150 A	JT3150
20 A	HT3020	80 A	HT3080	175 A	JT3175
25 A	HT3025	90 A	HT3090	200 A	JT3200
30 A	HT3030	100 A	HT3100	225 A	JT3225
35 A	HT3035	110 A	HT3110	250 A	JT3250
40 A	HT3040	125 A	HT3125	—	—

90. Circuit breakers will be labeled with Line and Load markings and are not suitable for reverse connections.

91. Available on three-pole circuit breakers. Not allowed in I-Line devices. Not available in R interrupting ratings.

92. UL Listed/CSA Certified as current-limiting circuit breakers.

93. Standard lug kit: AL150HD. Terminal wire range: 14–3/0 AWG Al or Cu.

94. For 100% rated circuit breakers replace the “T” suffix with “R.” Not available in I-Line, plug-in, or drawout constructions. Not available in R interrupting rating.

95. Standard lug kit: AL250JD. Terminal wire range: 3/0 AWG–350 kcmil Al or Cu.

For smaller wire range (4–4/0 AWG Al or Cu), replace the lug's wire binding screws with the larger binding screws provided



**H-Frame and J-Frame Three-Pole Field-Installable Thermal-Magnetic Trip Units (Continued)**

15–60 A H-Frame		70–150 A H-Frame		150–250 A J-Frame	
Amperage	Cat. No.	Amperage	Cat. No.	Amperage	Cat. No.
45 A	HT3045	150 A	HT3150	—	—
50 A	HT3050	—	—	—	—
60 A	HT3060	—	—	—	—

**H-Frame and J-Frame Three-Pole Field-Installable MicroLogic Electronic Trip Units**

Electronic Trip Unit <sup>96</sup>			Ampere Settings	Trip Unit Cat. No.
Type	Function	Trip Unit		
Standard	LI	3.2	15-20-25-30-35-40-45-50-60	HE3060U31X
			35-40-45-50-60-70-80-90-100	HE3100U31X
			50-60-70-80-90-100-110-125-150	HE3150U31X
			70-80-100-125-150-175-200-225-250	JE3250U31X
	LSI	3.2S	15-20-25-30-35-40-45-50-60	HE3060U33X
			35-40-45-50-60-70-80-90-100	HE3100U33X
			50-60-70-80-90-100-110-125-150	HE3150U33X
			70-80-100-125-150-175-200-225-250	JE3250U33X
Ammeter	LSI	5.2A	15–60	HE3060U43X
			35–100	HE3100U43X
			50–150	HE3150U43X
			70–250	JE3250U43X
	LSIG	6.2A	15–60	HE3060U44X
			35–100	HE3100U44X
			50–150	HE3150U44X
			70–250	JE3250U44X
Energy	LSI	5.2E	15–60	HE3060U53X
			35–100	HE3100U53X
			50–150	HE3150U53X
			70–250	JE3250U53X
	LSIG	6.2E	15–60	HE3060U54X
			35–100	HE3100U54X
			50–150	HE3150U54X
			70–250	JE3250U54X

96. Electronic trip units cannot be used for DC applications.

# L-Frame Circuit Breaker Catalog Numbers

## Unit-Mount Circuit Breaker Catalog Numbers

### L-Frame 600 A Electronic Trip UL Rated Three-Pole Circuit Breakers (600 Vac, 50/60 Hz) With Factory-Sealed Trip Unit Suitable for Reverse Connection

Electronic Trip Unit			Sensor Rating	Interrupting Rating (2nd Letter of Catalog Number)				
Type	Function	Trip Unit		D	G	J <sup>97</sup>	L <sup>97</sup>	R <sup>97</sup>
Standard (80%) Rated, 600 Vac, 50/60 Hz								
Standard	LI	3.3 <sup>98</sup>	250 A <sup>99</sup>	LDL36250U31X	LGL36250U31X	LJL36250U31X	LLL36250U31X	LRL36250U31X
			400 A <sup>100</sup>	LDL36400U31X	LGL36400U31X	LJL36400U31X	LLL36400U31X	LRL36400U31X
			600 A <sup>100</sup>	LDL36600U31X	LGL36600U31X	LJL36600U31X	LLL36600U31X	LRL36600U31X
Standard	LSI	3.3S <sup>98</sup>	250 A <sup>99</sup>	LDL36250U33X	LGL36250U33X	LJL36250U33X	LLL36250U33X	LRL36250U33X
			400 A <sup>100</sup>	LDL36400U33X	LGL36400U33X	LJL36400U33X	LLL36400U33X	LRL36400U33X
			600 A <sup>100</sup>	LDL36600U33X	LGL36600U33X	LJL36600U33X	LLL36600U33X	LRL36600U33X
Ammeter	LSI	5.3A	400 A <sup>100</sup>	LDL36400U43X	LGL36400U43X	LJL36400U43X	LLL36400U43X	LRL36400U43X
			600 A <sup>100</sup>	LDL36600U43X	LGL36600U43X	LJL36600U43X	LLL36600U43X	LRL36600U43X
Energy	LSI	5.3E	400 A <sup>100</sup>	LDL36400U53X	LGL36400U53X	LJL36400U53X	LLL36400U53X	LRL36400U53X
			600 A <sup>100</sup>	LDL36600U53X	LGL36600U53X	LJL36600U53X	LLL36600U53X	LRL36600U53X
Ammeter	LSIG	6.3A <sup>101</sup>	400 A <sup>100</sup>	LDL36400U44X	LGL36400U44X	LJL36400U44X	LLL36400U44X	LRL36400U44X
			600 A <sup>100</sup>	LDL36600U44X	LGL36600U44X	LJL36600U44X	LLL36600U44X	LRL36600U44X
Energy	LSIG	6.3E	400 A <sup>100</sup>	LDL36400U54X	LGL36400U54X	LJL36400U54X	LLL36400U54X	LRL36400U54X
			600 A <sup>100</sup>	LDL36600U54X	LGL36600U54X	LJL36600U54X	LLL36600U54X	LRL36600U54X
100% Rated, 600 Vac, 50/60 Hz								
Standard	LI	3.3 <sup>98</sup>	250 A <sup>99</sup>	LDL36250CU31X	LGL36250CU31X	LJL36250CU31X	LLL36250CU31X	LRL36250CU31X
			400 A <sup>100</sup>	LDL36400CU31X	LGL36400CU31X	LJL36400CU31X	LLL36400CU31X	LRL36400CU31X
Standard	LSI	3.3S <sup>98</sup>	250 A <sup>99</sup>	LDL36250CU33X	LGL36250CU33X	LJL36250CU33X	LLL36250CU33X	LRL36250CU33X
			400 A <sup>100</sup>	LDL36400CU33X	LGL36400CU33X	LJL36400CU33X	LLL36400CU33X	LRL36400CU33X
Ammeter	LSI	5.3A	400 A <sup>100</sup>	LDL36400CU43X	LGL36400CU43X	LJL36400CU43X	LLL36400CU43X	LRL36400CU43X
Energy	LSI	5.3E	400 A <sup>100</sup>	LDL36400CU53X	LGL36400CU53X	LJL36400CU53X	LLL36400CU53X	LRL36400CU53X
Ammeter	LSIG	6.3A <sup>101</sup>	400 A <sup>100</sup>	LDL36400CU44X	LGL36400CU44X	LJL36400CU44X	LLL36400CU44X	LRL36400CU44X
Energy	LSIG	6.3E	400 A <sup>100</sup>	LDL36400CU54X	LGL36400CU54X	LJL36400CU54X	LLL36400CU54X	LRL36400CU54X

### L-Frame 600 A Mission Critical Standard (100 %) Rated Electronic Trip UL Rated Three-Pole Circuit Breakers (480Y/277 Vac, 50/60 Hz) With Factory-Sealed Trip Unit Suitable for Reverse Connection

Electronic Trip Unit <sup>102</sup>			Sensor Rating	Interrupting Rating (2nd Letter of Catalog Number)			
Type	Function	Trip Unit		D	G	J	L
Standard	LI	3.3-W	250 A <sup>99</sup>	LDL34250WU31X	LGL34250WU31X	LJL34250WU31X	LLL34250WU31X
			400 A <sup>100</sup>	LDL34400WU31X	LGL34400WU31X	LJL34400WU31X	LLL34400WU31X
			600 A <sup>100</sup>	LDL34600WU31X	LGL34600WU31X	LJL34600WU31X	LLL34600WU31X

97. UL Listed/CSA Certified as current-limiting circuit breakers.

98. Three-pole circuit breakers with this trip unit can be used for two-pole applications.

99. Standard lug kit: AL400L61K3. Terminal wire range: (1) 2 AWG–600 kcmil Cu or (1) 2 AWG–500 kcmil Al. Type of terminal shield: short.

100. Standard lug kit: AL600LS52K3. Terminal wire range: (2) 2/0 AWG–500 kcmil Al/Cu. Type of terminal shield: medium.

101. Three-pole circuit breakers with this trip unit can be used for two-pole applications in order to have ground fault protection. Additional metering capabilities will not work properly on the unconnected phase.

102. Standard rating is 100% for 250 and 400 A only. Standard rating is 80% for 600 A.

**L-Frame 600 A Mission Critical Standard (100 %) Rated Electronic Trip UL Rated Three-Pole Circuit Breakers (480Y/277 Vac, 50/60 Hz) With Factory-Sealed Trip Unit Suitable for Reverse Connection (Continued)**

Electronic Trip Unit <sup>103</sup>			Sensor Rating	Interrupting Rating (2nd Letter of Catalog Number)			
Type	Function	Trip Unit		D	G	J	L
Standard	LSI	3.3S-W	250 A <sup>104</sup>	LDL34250WU33X	LGL34250WU33X	LJL34250WU33X	LLL34250WU33X
			400 A <sup>105</sup>	LDL34400WU33X	LGL34400WU33X	LJL34400WU33X	LLL34400WU33X
			600 A <sup>105</sup>	LDL34600WU33X	LGL34600WU33X	LJL34600WU33X	LLL34600WU33X
Ammeter	LSI	5.3A-W	400 A <sup>105</sup>	LDL34400WU43X	LGL34400WU43X	LJL34400WU43X	LLL34400WU43X
			600 A <sup>105</sup>	LDL34600WU43X	LGL34600WU43X	LJL34600WU43X	LLL34600WU43X
Energy	LSI	5.3E-W	400 A <sup>105</sup>	LDL34400WU53X	LGL34400WU53X	LJL34400WU53X	LLL34400WU53X
			600 A <sup>105</sup>	LDL34600WU53X	LGL34600WU53X	LJL34600WU53X	LLL34600WU53X
Ammeter	LSIG	6.3A-W	400 A <sup>105</sup>	LDL34400WU44X	LGL34400WU44X	LJL34400WU44X	LLL34400WU44X
			600 A <sup>105</sup>	LDL34600WU44X	LGL34600WU44X	LJL34600WU44X	LLL34600WU44X
Energy	LSIG	6.3E-W	400 A <sup>105</sup>	LDL34400WU54X	LGL34400WU54X	LJL34400WU54X	LLL34400WU54X
			600 A <sup>105</sup>	LDL34600WU54X	LGL34600WU54X	LJL34600WU54X	LLL34600WU54X

**L-Frame 600 A Electronic Trip UL Rated Four-Pole Circuit Breakers (600 Vac, 50/60 Hz) With Factory-Sealed Trip Unit Suitable for Reverse Connection**

Electronic Trip Unit			Sensor Rating	Interrupting Rating (2nd Letter of Catalog Number)				
Type	Function	Trip Unit		D	G	J <sup>106</sup>	L <sup>106</sup>	R <sup>106</sup>
Standard (80%) Rated, 600 Vac, 50/60 Hz								
Standard	LI	3.3	250 A <sup>107</sup>	LDL46250U31X	LGL46250U31X	LJL46250U31X	LLL46250U31X	LRL46250U31X
			400 A <sup>108</sup>	LDL46400U31X	LGL46400U31X	LJL46400U31X	LLL46400U31X	LRL46400U31X
			600 A <sup>108</sup>	LDL46600U31X	LGL46600U31X	LJL46600U31X	LLL46600U31X	LRL46600U31X
Standard	LSI	3.3S	250 A <sup>107</sup>	LDL46250U33X	LGL46250U33X	LJL46250U33X	LLL46250U33X	LRL46250U33X
			400 A <sup>108</sup>	LDL46400U33X	LGL46400U33X	LJL46400U33X	LLL46400U33X	LRL46400U33X
			600 A <sup>108</sup>	LDL46600U33X	LGL46600U33X	LJL46600U33X	LLL46600U33X	LRL46600U33X
Ammeter	LSI	5.3A	400 A <sup>108</sup>	LDL46400U43X	LGL46400U43X	LJL46400U43X	LLL46400U43X	LRL46400U43X
			600 A <sup>108</sup>	LDL46600U43X	LGL46600U43X	LJL46600U43X	LLL46600U43X	LRL46600U43X
Energy	LSI	5.3E	400 A <sup>108</sup>	LDL46400U53X	LGL46400U53X	LJL46400U53X	LLL46400U53X	LRL46400U53X
			600 A <sup>108</sup>	LDL46600U53X	LGL46600U53X	LJL46600U53X	LLL46600U53X	LRL46600U53X
Ammeter	LSIG	6.3A	400 A <sup>108</sup>	LDL46400U44X	LGL46400U44X	LJL46400U44X	LLL46400U44X	LRL46400U44X
			600 A <sup>108</sup>	LDL46600U44X	LGL46600U44X	LJL46600U44X	LLL46600U44X	LRL46600U44X
Energy	LSIG	6.3E	400 A <sup>108</sup>	LDL46400U54X	LGL46400U54X	LJL46400U54X	LLL46400U54X	LRL46400U54X
			600 A <sup>108</sup>	LDL46600U54X	LGL46600U54X	LJL46600U54X	LLL46600U54X	LRL46600U54X
100% Rated, 600 Vac, 50/60 Hz								
Standard	LI	3.3	250 A <sup>107</sup>	LDL46250CU31X	LGL46250CU31X	LJL46250CU31X	LLL46250CU31X	LRL46250CU31X
			400 A <sup>108</sup>	LDL46400CU31X	LGL46400CU31X	LJL46400CU31X	LLL46400CU31X	LRL46400CU31X
Standard	LSI	3.3S	250 A <sup>107</sup>	LDL46250CU33X	LGL46250CU33X	LJL46250CU33X	LLL46250CU33X	LRL46250CU33X
			400 A <sup>108</sup>	LDL46400CU33X	LGL46400CU33X	LJL46400CU33X	LLL46400CU33X	LRL46400CU33X

103. Standard rating is 100% for 250 and 400 A only. Standard rating is 80% for 600 A.

104. Standard lug kit: AL400L61K3. Terminal wire range: (1) 2 AWG–600 kcmil Cu or (1) 2 AWG–500 kcmil Al. Type of terminal shield: short.

105. Standard lug kit: AL600LS52K3. Terminal wire range: (2) 2/0 AWG–500 kcmil Al/Cu. Type of terminal shield: medium.

106. UL Listed/CSA Certified as current-limiting circuit breakers.

107. Standard lug kit: AL400L61K4. Terminal wire range: (1) 2 AWG–600 kcmil Cu or (1) 2 AWG–500 kcmil Al. Type of terminal shield: short.

108. Standard lug kit: AL600LS52K4. Terminal wire range: (2) 2/0 AWG–500 kcmil Al/Cu. Type of terminal shield: medium.

### L-Frame 600 A Electronic Trip UL Rated Four-Pole Circuit Breakers (600 Vac, 50/60 Hz) With Factory-Sealed Trip Unit Suitable for Reverse Connection (Continued)

Electronic Trip Unit			Sensor Rating	Interrupting Rating (2nd Letter of Catalog Number)				
Type	Function	Trip Unit		D	G	J <sup>109</sup>	L <sup>109</sup>	R <sup>109</sup>
Ammeter	LSI	5.3A	400 A <sup>110</sup>	LDL46400CU43X	LGL46400CU43X	LJL46400CU43X	LLL46400CU43X	LRL46400CU43X
Energy	LSI	5.3E	400 A <sup>110</sup>	LDL46400CU53X	LGL46400CU53X	LJL46400CU53X	LLL46400CU53X	LRL46400CU53X
Ammeter	LSIG	6.3A	400 A <sup>110</sup>	LDL46400CU44X	LGL46400CU44X	LJL46400CU44X	LLL46400CU44X	LRL46400CU44X
Energy	LSIG	6.3E	400 A <sup>110</sup>	LDL46400CU54X	LGL46400CU54X	LJL46400CU54X	LLL46400CU54X	LRL46400CU54X

### L-Frame 600 A Mission Critical Standard (80%) Rated Electronic Trip UL Rated Four-Pole Circuit Breakers (480Y/277 Vac, 50/60 Hz) With Factory-Sealed Trip Unit Suitable for Reverse Connection

Electronic Trip Unit			Sensor Rating	Interrupting Rating (2nd Letter of Catalog Number)			
Type	Function	Trip Unit		D	G	J	L
Standard	LI	3.3-W	250 A <sup>111</sup>	LDL44250WU31X	LGL44250WU31X	LJL44250WU31X	LLL44250WU31X
			400 A <sup>110</sup>	LDL44400WU31X	LGL44400WU31X	LJL44400WU31X	LLL44400WU31X
			600 A <sup>110</sup>	LDL44600WU31X	LGL44600WU31X	LJL44600WU31X	LLL44600WU31X
Standard	LSI	3.3S-W	250 A <sup>111</sup>	LDL44250WU33X	LGL44250WU33X	LJL44250WU33X	LLL44250WU33X
			400 A <sup>110</sup>	LDL44400WU33X	LGL44400WU33X	LJL44400WU33X	LLL44400WU33X
			600 A <sup>110</sup>	LDL44600WU33X	LGL44600WU33X	LJL44600WU33X	LLL44600WU33X
Ammeter	LSI	5.3A-W	400 A <sup>110</sup>	LDL44400WU43X	LGL44400WU43X	LJL44400WU43X	LLL44400WU43X
			600 A <sup>110</sup>	LDL44600WU43X	LGL44600WU43X	LJL44600WU43X	LLL44600WU43X
Energy	LSI	5.3E-W	400 A <sup>110</sup>	LDL44400WU53X	LGL44400WU53X	LJL44400WU53X	LLL44400WU53X
			600 A <sup>110</sup>	LDL44600WU53X	LGL44600WU53X	LJL44600WU53X	LLL44600WU53X
Ammeter	LSIG	6.3A-W	400 A <sup>110</sup>	LDL44400WU44X	LGL44400WU44X	LJL44400WU44X	LLL44400WU44X
			600 A <sup>110</sup>	LDL44600WU44X	LGL44600WU44X	LJL44600WU44X	LLL44600WU44X
Energy	LSIG	6.3E-W	400 A <sup>110</sup>	LDL44400WU54X	LGL44400WU54X	LJL44400WU54X	LLL44400WU54X
			600 A <sup>110</sup>	LDL44600WU54X	LGL44600WU54X	LJL44600WU54X	LLL44600WU54X

## I-Line Circuit Breaker Catalog Numbers

### L-Frame 600 A I-Line Standard (80%) Rated Electronic Trip UL Rated Circuit Breakers (600 Vac, 50/60 Hz) With Factory-Sealed Trip Unit Suitable for Reverse Connection

Electronic Trip Unit			Sensor Rating	Interrupting Rating				
Type	Function	Trip Unit		D	G	J <sup>109</sup>	L <sup>3 109</sup>	R <sup>3 109</sup>
Standard	LI	3.3 <sup>112</sup>	250 A <sup>113</sup>	LDA36250U31X	LGA36250U31X	LJA36250U31X	LLA36250U31X	LRA36250U31X
			400 A <sup>114</sup>	LDA36400U31X	LGA36400U31X	LJA36400U31X	LLA36400U31X	LRA36400U31X
			600 A <sup>114</sup>	LDA36600U31X	LGA36600U31X	LJA36600U31X	LLA36600U31X	LRA36600U31X
Standard	LSI	3.3S <sup>112</sup>	250 A <sup>113</sup>	LDA36250U33X	LGA36250U33X	LJA36250U33X	LLA36250U33X	LRA36250U33X
			400 A <sup>114</sup>	LDA36400U33X	LGA36400U33X	LJA36400U33X	LLA36400U33X	LRA36400U33X

109. UL Listed/CSA Certified as current-limiting circuit breakers.

110. Standard lug kit: AL600LS52K4. Terminal wire range: (2) 2/0 AWG–500 kcmil Al/Cu. Type of terminal shield: medium.

111. Standard lug kit: AL400L61K4. Terminal wire range: (1) 2 AWG–600 kcmil Cu or (1) 2 AWG–500 kcmil Al. Type of terminal shield: short.

112. Three-pole circuit breakers with this trip unit can be used for two-pole applications.

113. Standard lug kit: AL400L61K3. Terminal wire range: (1) 2 AWG–600 kcmil Cu or (1) 2 AWG–500 kcmil Al. Type of terminal shield: short.

114. Standard lug kit: AL600LF52K3. Terminal wire range: (2) 3/0 AWG–500 kcmil Al/Cu. Type of terminal shield: short.

### L-Frame 600 A I-Line Standard (80%) Rated Electronic Trip UL Rated Circuit Breakers (600 Vac, 50/60 Hz) With Factory-Sealed Trip Unit Suitable for Reverse Connection (Continued)

Electronic Trip Unit			Sensor Rating	Interrupting Rating				
Type	Function	Trip Unit		D	G	J <sup>115</sup>	L3 <sup>115</sup>	R3 <sup>115</sup>
Ammeter	LSI	5.3A	600 A <sup>115</sup>	LDA36600U33X	LGA36600U33X	LJA36600U33X	LLA36600U33X	LRA36600U33X
			400 A <sup>115</sup>	LDA36400U43X	LGA36400U43X	LJA36400U43X	LLA36400U43X	LRA36400U43X
			600 A <sup>115</sup>	LDA36600U43X	LGA36600U43X	LJA36600U43X	LLA36600U43X	LRA36600U43X
Energy	LSI	5.3E	400 A <sup>115</sup>	LDA36400U53X	LGA36400U53X	LJA36400U53X	LLA36400U53X	LRA36400U53X
			600 A <sup>115</sup>	LDA36600U53X	LGA36600U53X	LJA36600U53X	LLA36600U53X	LRA36600U53X
Ammeter	LSIG	6.3A <sup>116</sup>	400 A <sup>115</sup>	LDA36400U44X	LGA36400U44X	LJA36400U44X	LLA36400U44X	LRA36400U44X
			600 A <sup>115</sup>	LDA36600U44X	LGA36600U44X	LJA36600U44X	LLA36600U44X	LRA36600U44X
Energy	LSIG	6.3E	400 A <sup>115</sup>	LDA36400U54X	LGA36400U54X	LJA36400U54X	LLA36400U54X	LRA36400U54X
			600 A <sup>115</sup>	LDA36600U54X	LGA36600U54X	LJA36600U54X	LLA36600U54X	LRA36600U54X

### L-Frame 600 A Mission Critical I-Line Standard (80%) Rated Electronic Trip UL Rated Circuit Breakers (480/277 Vac, 50/60 Hz) With Factory Sealed Trip Units Suitable for Reverse Connection

Electronic Trip Unit			Sensor Rating	Interrupting Rating			
Type	Function	Trip Unit		D	G	J	L
Standard	LI	3.3 W	250 A <sup>117</sup>	LDA34250WU31X	LGA34250WU31X	LJA34250WU31X	LLA34250WU31X
			400 A <sup>118</sup>	LDA34400WU31X	LGA34400WU31X	LJA34400WU31X	LLA34400WU31X
			600 A <sup>118</sup>	LDA34600WU31X	LGA34600WU31X	LJA34600WU31X	LLA34600WU31X
Standard	LSI	3.3S-W	250 A <sup>117</sup>	LDA34250WU33X	LGA34250WU33X	LJA34250WU33X	LLA34250WU33X
			400 A <sup>118</sup>	LDA34400WU33X	LGA34400WU33X	LJA34400WU33X	LLA34400WU33X
			600 A <sup>118</sup>	LDA34600WU33X	LGA34600WU33X	LJA34600WU33X	LLA34600WU33X
Ammeter	LSI	5.3A-W	400 A <sup>118</sup>	LDA34400WU43X	LGA34400WU43X	LJA34400WU43X	LLA34400WU43X
			600 A <sup>118</sup>	LDA34600WU43X	LGA34600WU43X	LJA34600WU43X	LLA34600WU43X
Energy	LSI	5.3E-W	400 A <sup>118</sup>	LDA34400WU53X	LGA34400WU53X	LJA34400WU53X	LLA34400WU53X
			600 A <sup>118</sup>	LDA34600WU53X	LGA34600WU53X	LJA34600WU53X	LLA34600WU53X
Ammeter	LSIG	6.3A-W	400 A <sup>118</sup>	LDA34400WU44X	LGA34400WU44X	LJA34400WU44X	LLA34400WU44X
			600 A <sup>118</sup>	LDA34600WU44X	LGA34600WU44X	LJA34600WU44X	LLA34600WU44X
Energy	LSIG	6.3E-W	400 A <sup>118</sup>	LDA34400WU54X	LGA34400WU54X	LJA34400WU54X	LLA34400WU54X
			600 A <sup>118</sup>	LDA34600WU54X	LGA34600WU54X	LJA34600WU54X	LLA34600WU54X

### L-Frame 250 A and 400 A I-Line 100% Rated Electronic Trip UL Rated Circuit Breakers (600 Vac, 50/60 Hz) With Factory Sealed Trip Unit Suitable for Reverse Connection

Electronic Trip Unit			Sensor Rating	Interrupting Rating				
Type	Function	Trip Unit		D	G	J <sup>115</sup>	L <sup>117</sup>	R <sup>117</sup>
Standard	LI	3.3 <sup>119</sup>	250 A <sup>117</sup>	LDA36250CU31X	LGA36250CU31X	LJA36250CU31X	LLA36250CU31X	LRA36250CU31X
			400 A	LDA36400CU31X	LGA36400CU31X	LJA36400CU31X	LLA36400CU31X	LRA36400CU31X
Standard	LSI	3.3S <sup>119</sup>	250 A <sup>117</sup>	LDA36250CU33X	LGA36250CU33X	LJA36250CU33X	LLA36250CU33X	LRA36250CU33X
			400 A <sup>118</sup>	LDA36400CU33X	LGA36400CU33X	LJA36400CU33X	LLA36400CU33X	LRA36400CU33X

115. UL Listed/CSA Certified as current-limiting circuit breakers.

115. Standard lug kit: AL600LF52K3. Terminal wire range: (2) 3/0 AWG–500 kcmil Al/Cu. Type of terminal shield: short.

116. Three-pole circuit breakers with this trip unit can be used for two-pole applications in order to have ground fault protection. Additional metering capabilities will not work properly on the unconnected phase.

117. Standard lug kit: AL400L61K3. Terminal wire range: (1) 2 AWG–600 kcmil Cu or (1) 2 AWG–500 kcmil Al. Type of terminal shield: short.

118. Standard lug kit: AL600LS52K3. Terminal wire range: (2) 2/0 AWG–500 kcmil Al/Cu. Type of terminal shield: medium.

119. Three-pole circuit breakers with this trip unit can be used for two-pole applications.

**L-Frame 250 A and 400 A I-Line 100% Rated Electronic Trip UL Rated Circuit Breakers (600 Vac, 50/60 Hz) With Factory Sealed Trip Unit Suitable for Reverse Connection (Continued)**

Electronic Trip Unit			Sensor Rating	Interrupting Rating				
Type	Function	Trip Unit		D	G	J <sup>120</sup>	L <sup>121</sup>	R <sup>121</sup>
Ammeter	LSI	5.3A	400 A <sup>122</sup>	LDA36400CU43X	LGA36400CU43X	LJA36400CU43X	LLA36400CU43X	LRA36400CU43X
Energy	LSI	5.3E	400 A <sup>122</sup>	LDA36400CU53X	LGA36400CU53X	LJA36400CU53X	LLA36400CU53X	LRA36400CU53X
Ammeter	LSIG	6.3A <sup>123</sup>	400 A <sup>122</sup>	LDA36400CU44X	LGA36400CU44X	LJA36400CU44X	LLA36400CU44X	LRA36400CU44X
Energy	LSIG	6.3E	400 A <sup>122</sup>	LDA36400CU54X	LGA36400CU54X	LJA36400CU54X	LLA36400CU54X	LRA36400CU54X

## Circuit Breakers with Field-Interchangeable Trip Units Catalog Numbers

**L-Frame 3-Pole, 600 A Circuit Breakers with Lugs and Field-Interchangeable Electronic Trip Units (600 Vac, 50/60 Hz)**

Electronic Trip Unit			Sensor Rating	Interrupting Rating			
Type	Function	Trip Unit		D	G	J <sup>120</sup>	L <sup>120</sup>
Standard (80% Rated), 600 Vac, 50/60 Hz <sup>124 125</sup>							
Standard	LI	3.3	250 A <sup>121</sup>	LDL36250TU31X	LGL36250TU31X	LJL36250TU31X	LLL36250TU31X
			400 A <sup>122</sup>	LDL36600TU31X	LGL36600TU31X	LJL36600TU31X	LLL36600TU31X
			600 A <sup>122</sup>	LDL36400TU31X	LGL36400TU31X	LJL36400TU31X	LLL36400TU31X
Standard	LSI	3.3S	250 A <sup>121</sup>	LDL36250TU33X	LGL36250TU33X	LJL36250TU33X	LLL36250TU33X
			400 A <sup>122</sup>	LDL36400TU33X	LGL36400TU33X	LJL36400TU33X	LLL36400TU33X
			600 A <sup>122</sup>	LDL36600TU33X	LGL36600TU33X	LJL36600TU33X	LLL36600TU33X
Ammeter	LSI	5.3A	400 A <sup>122</sup>	LDL36400TU43X	LGL36400TU43X	LJL36400TU43X	LLL36400TU43X
			600 A <sup>122</sup>	LDL36600TU43X	LGL36600TU43X	LJL36600TU43X	LLL36600TU43X
Energy	LSI	5.3E	400 A <sup>122</sup>	LDL36400TU53X	LGL36400TU53X	LJL36400TU53X	LLL36400TU53X
			600 A <sup>122</sup>	LDL36600TU53X	LGL36600TU53X	LJL36600TU53X	LLL36600TU53X
Ammeter	LSIG	6.3A	400 A <sup>122</sup>	LDL36400TU44X	LGL36400TU44X	LJL36400TU44X	LLL36400TU44X
			600 A <sup>122</sup>	LDL36600TU44X	LGL36600TU44X	LJL36600TU44X	LLL36600TU44X
Energy	LSIG	6.3E	400 A <sup>122</sup>	LDL36400TU54X	LGL36400TU54X	LJL36400TU54X	LLL36400TU54X
			600 A <sup>122</sup>	LDL36600TU54X	LGL36600TU54X	LJL36600TU54X	LLL36600TU54X
100% Rated, 600 Vac, 50/60 Hz <sup>124 125 126</sup>							
Standard	LI	3.3	250 A <sup>121</sup>	LDL36250RU31X	LGL36250RU31X	LJL36250RU31X	LLL36250RU31X
			400 A <sup>122</sup>	LDL36400RU31X	LGL36400RU31X	LJL36400RU31X	LLL36400RU31X
Standard	LSI	3.3S	250 A <sup>121</sup>	LDL36250RU33X	LGL36250RU33X	LJL36250RU33X	LLL36250RU33X
			400 A <sup>122</sup>	LDL36400RU33X	LGL36400RU33X	LJL36400RU33X	LLL36400RU33X
Ammeter	LSI	5.3A	400 A <sup>122</sup>	LDL36400RU43X	LGL36400RU43X	LJL36400RU43X	LLL36400RU43X

120. UL Listed/CSA Certified as current-limiting circuit breakers.

121. Standard lug kit: AL400L61K3. Terminal wire range: (1) 2 AWG–600 kcmil Cu or (1) 2 AWG–500 kcmil Al. Type of terminal shield: short.

122. Standard lug kit: AL600LS52K3. Terminal wire range: (2) 2/0 AWG–500 kcmil Al/Cu. Type of terminal shield: medium.

123. Three-pole circuit breakers with this trip unit can be used for two-pole applications in order to have ground fault protection. Additional metering capabilities will not work properly on the unconnected phase.

124. Circuit breakers will be labeled with Line and Load markings and are not suitable for reverse connections.

125. Only available on three-pole unit-mount circuit breakers. Not available in R interrupting rating. Not available with I-Line.

126. Not available in I-Line, plug-in, or drawout constructions. Not available in R interrupting rating.

### L-Frame 3-Pole, 600 A Circuit Breakers with Lugs and Field-Interchangeable Electronic Trip Units (600 Vac, 50/60 Hz) (Continued)

Electronic Trip Unit			Sensor Rating	Interrupting Rating			
Type	Function	Trip Unit		D	G	J <sup>127</sup>	L <sup>127</sup>
Energy	LSI	5.3E	400 A <sup>128</sup>	LDL36400RU53X	LGL36400RU53X	LJL36400RU53X	LLL36400RU53X
Ammeter	LSIG	6.3A	400 A <sup>128</sup>	LDL36400RU44X	LGL36400RU44X	LJL36400RU44X	LLL36400RU44X
Energy	LSIG	6.3E	400 A <sup>128</sup>	LDL36400RU54X	LGL36400RU54X	LJL36400RU54X	LLL36400RU54X

### L-Frame Three-Pole Field-Installable Micrologic Electronic Trip Units

Electronic Trip Unit			Ampere Setting	Trip Unit Cat. No.
Type	Function	Trip Unit		
Standard	LI	3.3	70-80-100-125-150-175-200-225-250	LE3250U31X
			125-150-175-200-225-250-300-350-400	LE3400U31X
			200-225-250-300-350-400-450-500-600	LE3600U31X
	LSI	3.3S	70-80-100-125-150-175-200-225-250	LE3250U33X
			125-150-175-200-225-250-300-350-400	LE3400U33X
			200-225-250-300-350-400-450-500-600	LE3600U33X
Ammeter	LSI	5.3A	125-400	LE3400U43X
			200-600	LE3600U43X
	LSIG	6.3A	125-400	LE3400U44X
			200-600	LE3600U44X
Energy	LSI	5.3E	125-400	LE3400U53X
			200-600	LE3600U53X
	LSIG	6.3E	125-400	LE3400U54X
			200-600	LE3600U54X

127. UL Listed/CSA Certified as current-limiting circuit breakers.

128. Standard lug kit: AL600LS52K3. Terminal wire range: (2) 2/0 AWG–500 kcmil Al/Cu. Type of terminal shield: medium.

# Automatic Switches

## Automatic Switch Functions

An automatic switch can be used to open and close a circuit under normal operating conditions. They are similar in construction to circuit breakers, except that the switches open instantaneously at a factory-set, non-adjustable trip point calibrated to protect only the molded case switch.

Molded case switches are intended for use as disconnect devices only. UL489 requires molded case switches to be protected by a circuit breaker or fuse of equivalent rating. Molded case switches are labeled with their appropriate withstand ratings. The withstand rating of a switch is defined as the maximum current at rated voltage that the molded case switch will withstand without damage when protected by a circuit breaker with an equal continuous current rating.

PowerPacT H-, J-, and L-frame automatic switches are available in unit mount, I-Line, plug-in and drawout versions. They use the same accessories and offer the same connection possibilities as the circuit-breaker versions. They may be interlocked with another switch or circuit breaker to form a source-changeover system.

Switches are Listed under UL file E103740 and Certified under CSA file LR88980.

## Motor Operator

PowerPacT H-, J-, and L-frame switches equipped with a motor operator module allow remote closing and opening.

## Ground Fault Protection (H- and J-Frame Circuit Breakers Only)

An ELM or GFM module may be added to an automatic switch to monitor all leakage currents in the outgoing circuits of the equipment on which the automatic switch is installed. When the ELM or GFM module detects an earth-leakage current, the automatic switch interrupts the load current.

## Automatic Switch Protection

The automatic switch can make and break its rated current. For an overload or a short-circuit, it must be protected by an upstream device, in compliance with installation standards. Due to their high-set instantaneous release PowerPacT H-, J- and L-frame automatic switches are self-protected.



# Specifications

## H-Frame Automatic Molded Case Switch Specifications

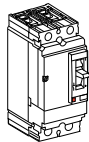
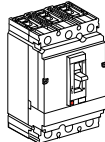
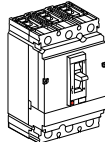
Frame		H-Frame					
Withstand Rating		“G”		“L”			
							
Poles		Two-Pole	Three-Pole	Two-Pole <sup>129</sup>	Three-Pole		
Catalog Number		150 A	HGL26000S15	HGL36000S15	HLL26000S15	HLL36000S15	
UL 489	Withstand Ratings	240 Vac	65 kA	65 kA	125 kA	125 kA	
		480 Vac	35 kA	35 kA	100 kA	100 kA	
		600 Vac	18 kA	18 kA	50 kA	50 kA	
		250 Vdc	20 kA	20 kA	20 kA	20 kA	
AC Trip Point		2250 A	2250 A	2250 A	2250 A		
IEC / EN 60947-3	Conventional Thermal Current	lth 50°C	150 A	150 A	150 A	150 A	
	Rated Insulation Voltage (Ui)		750V	750V	750V	750V	
	Rated Impulse Withstand Voltage (Uimp)		8 kV	8 kV	8 kV	8 kV	
	Rated Operational Voltage	ac	690 Vac	690 Vac	690 Vac	690 Vac	
		dc	—	—	—	—	
	Utilization Category		AC 22A	AC 22A	AC 22A	AC 22A	
Pollution Degree		IEC 60664-1	3	3	3	3	

## J-Frame Automatic Molded Case Switch Specifications

Frame		J-Frame						
Withstand Rating		“G”		“L”		“R”		
		175 A	250 A	175 A	250 A	175 A	250 A	
Catalog Number	Two-Pole <sup>130</sup>	JGL26000S17	JGL26000-S25	JLL26000-S17	JLL26000S25	—	—	
	Three-Pole	JGL36000S17	JGL36000-S25	JLL36000-S17	JLL36000S25	JRL26000-S17	JRL26000-S25	
UL 489	Withstand Ratings	240 Vac	65 kA	65 kA	125 kA	125 kA	200 kA	200 kA
		480 Vac	35 kA	35 kA	100 kA	100 kA	200 kA	200 kA
		600 Vac	18 kA	18 kA	50 kA	50 kA	100 kA	100 kA
		250 Vdc	20 kA	20 kA	20 kA	20 kA	20 kA	20 kA
AC Trip Point		3125 A	3125 A	3125 A	3125 A	3125 A	3125 A	

129. Two-pole devices use a three-pole switch frame with the center pole inoperative.

130. Two-pole devices use a three-pole switch frame with the center pole inoperative.

## J-Frame Automatic Molded Case Switch Specifications (Continued)

Frame			J-Frame					
Withstand Rating			"G"		"L"		"R"	
IEC/EN 60947-3	Conventional Thermal Current	lth 50° C	175 A	250 A	175 A	250 A	250 A	250 A
	Rated Insulation Voltage (Ui)		800 Vac	800 Vac	800 Vac	800 Vac	800 Vac	800 Vac
	Rated Impulse Withstand Voltage (Uimp)		8 kV	8 kV	8 kV	8 kV	8 kV	8 kV
	Rated Operational Voltage (Ue)	ac	690 Vac	690 Vac	690 Vac	690 Vac	690 Vac	690 Vac
		dc	500 Vdc	500 Vdc	500 Vdc	500 Vdc	500 Vdc	500 Vdc
	Utilization Category		AC 22 A	AC 22 A	AC 22 A	AC 22 A	AC 22 A	AC 22 A
Pollution Degree	IEC 6066-4-1	3	3	3	3	3	3	

## PowerPact L-Frame 600 A Unit-Mount Automatic Molded Case Switches, 600 Vac

Ampere Rating	Poles <sup>131</sup>	Cat. No.	Withstand Rating <sup>132</sup>			Trip Point	Standard Lug Terminal Wire Range
			240 Vac	480 Vac	600 Vac		
<b>Unit-Mount Automatic Molded Case Switches</b>							
G Withstand							
400 A	3	LGL36000S40X	65 kA	35 kA	18 kA	4800 A	AL600LS52K3 (2) 2 AWG–500 kcmil Al/Cu
600 A		LGL36000S60X	65 kA	35 kA	18 kA	6600 A	
400 A	4	LGL46000S40X	65 kA	35 kA	18 kA	4800 A	AL600LS52K4 (2) 2 AWG–500 kcmil Al/Cu
600 A		LGL46000S60X	65 kA	35 kA	18 kA	6600 A	
L Withstand							
400 A	3	LLL36000S40X	125 kA	100 kA	50 kA	4800 A	AL600LS52K3 (2) 2 AWG–500 kcmil Al/Cu
600 A		LLL36000S60X	125 kA	100 kA	50 kA	6600 A	
400 A	4	LLL46000S40X	125 kA	100 kA	50 kA	4800 A	AL600LS52K4 (2) 2 AWG–500 kcmil Al/Cu
600 A		LLL46000S60X	125 kA	100 kA	50 kA	6600 A	
R Withstand							
400 A	3	LRL36000S40X	200 kA	200 kA	100 kA	4800 A	AL600LS52K3 (2) 2 AWG–500 kcmil Al/Cu
600 A		LRL36000S60X	200 kA	200 kA	100 kA	6600 A	
400 A	4	LRL46000S40X	200 kA	200 kA	100 kA	4800 A	AL600LS52K4 (2) 2 AWG–500 kcmil Al/Cu
600 A		LRL46000S60X	200 kA	200 kA	100 kA	6600 A	
<b>I-Line Circuit Breakers Automatic Molded Case Switches</b>							
G Withstand							
400 A	3	LGA36000S40X	65 kA	35 kA	18 kA	4800 A	AL600LF52K3 (2) 3/0 AWG–500 kcmil Al/Cu
600 A		LGA36000S60X	65 kA	35 kA	18 kA	6600 A	
L Withstand							
400 A	3	LLA36000S40X	125 kA	100 kA	50 kA	4800 A	AL600LF52K3 (2) 3/0 AWG–500 kcmil Al/Cu
600 A		LLA36000S60X	125 kA	100 kA	50 kA	6600 A	

131. Four-pole circuit breaker available as bus connected, with lug configurations, and in plug-in, draw-out and rear-connected configurations.  
 132. The withstand rating is the fault current, at rated voltage, that the molded case switch will withstand without damage when protected by a circuit breaker or fuse with an equal continuous current rating.

**PowerPacT L-Frame 600 A Unit-Mount Automatic Molded Case Switches, 600 Vac (Continued)**

Ampere Rating	Poles <sup>133</sup>	Cat. No.	Withstand Rating <sup>134</sup>			Trip Point	Standard Lug Terminal Wire Range
			240 Vac	480 Vac	600 Vac		
R Withstand							
400 A	3	LRA36000S40X	200 kA	200 kA	100 kA	4800 A	AL600LF52K3 (2) 3/0 AWG–500 kcmil Al/Cu
600 A		LRA36000S60X	200 kA	200 kA	100 kA	6600 A	

133. Four-pole circuit breaker available as bus connected, with lug configurations, and in plug-in, draw-out and rear-connected configurations.  
 134. The withstand rating is the fault current, at rated voltage, that the molded case switch will withstand without damage when protected by a circuit breaker or fuse with an equal continuous current rating.

## Catalog Numbers

### PowerPacT H-Frame and J-Frame 250 A Unit-Mount Automatic Molded Case Switches, 600 Vac with Factory Sealed Trip Unit (Suitable for Reverse Connection)

Ampere Rating	2-pole	3-pole	Withstand Rating <sup>135</sup>			Trip Point	Standard Lug Kit Terminal Wire Range
	Cat. No.	Cat. No.	240 Vac	480 Vac	600 Vac		
<b>G Withstand</b>							
150 A	HGL26000S15 <sup>136</sup>	HGL36000S15	65	35	18	2250 A	AL150HD #14-#3/0 AWG Al or Cu
175 A	JGL26000S17	JGL36000S17	65	35	18	3125 A	AL175JD #4-#4/0 AWG Al or Cu
250 A	JGL26000S25	JGL36000S25	65	35	18	3125 A	AL250JD #3/0-350 kcmil Al or Cu
<b>L Withstand</b>							
150 A	HLL26000S15	HLL36000S15	125	100	50	2250 A	AL150HD #14-#3/0 AWG Al or Cu
175 A	JLL26000S17	JLL36000S17	125	100	50	3125 A	AL175JD #4-#4/0 AWG Al or Cu
250 A	JLL26000S25	JLL36000S25	125	100	50	3125 A	AL250JD #3/0-350 kcmil Al or Cu
<b>R Withstand</b>							
175 A	—	JRL36000S17	200	200	100	3125 A	AL175JD #4-#4/0 AWG Al or Cu
250 A	—	JRL36000S25	200	200	100	3125 A	AL250JD #3/0-350 kcmil Al or Cu

### PowerPacT H-Frame and J-Frame I-Line Automatic Molded Case Switches, 600 Vac with Factory Sealed Trip Unit (Suitable for Reverse Connection)

Ampere Rating	2-pole	3-pole	Withstand Rating <sup>135</sup>			Trip Point	Standard Lug Kit Terminal Wire Range
	Cat. No.	Cat. No.	240 Vac	480 Vac	600 Vac		
<b>I-Line Circuit Breakers Automatic Molded Case Switches</b>							
<b>G Withstand</b>							
150 A	HGA26000S15( ) <sup>136</sup>	HGA36000S15	65	35	18	2250A	AL150HD #14-#3/0 AWG Al or Cu
175 A	JGA26000S17( )	JGA36000S17	65	35	18	3125 A	AL175JD #4-#4/0 AWG Al or Cu
250 A	JGA26000S25( )	JGA36000S25	65	35	18	3125 A	AL250JD #3/0-350 kcmil Al or Cu
<b>L Withstand</b>							
150 A	HLA26000S15( )	HLA36000S15	125	100	50	2250 A	AL150HD #14-#3/0 AWG Al or Cu
175 A	JLA26000S17( )	JLA36000S17	125	100	50	3125 A	AL175JD #4-#4/0 AWG Al or Cu
250 A	JLA26000S25( )	JLA36000S25	125	100	50	3125 A	AL250JD #3/0-350 kcmil Al or Cu
<b>R Withstand</b>							

135. The withstand rating is the fault current, at rated voltage, that the molded case switch will withstand without damage when protected by a circuit breaker or fuse with an equal continuous current rating.

136. Two-pole device with 3 in. (76 mm) mounting height, all other two-pole circuit breakers use three-pole switch 4.5 in. (114 mm) mounting height.

**PowerPacT H-Frame and J-Frame I-Line Automatic Molded Case Switches, 600 Vac with Factory Sealed Trip Unit (Suitable for Reverse Connection) (Continued)**

175 A	JRA26000S17( )	JRA36000S17	200	200	100	3125A	AL175JD #4-#4/0 AWG Al or Cu
250 A	JRA26000S25( )	JRA36000S25	200	200	100	3125A	AL250JD #3/0-350 kcmil Al or Cu

**L-Frame Ratings and Withstand Ratings**

Frame		L-Frame						
Withstand Rating		G		L		R		
Poles		400 A	600 A	400 A	600 A	400 A	600 A	
Catalog Number	Three-Pole	LGL36000-S40X	LGL36000-S60X	LLL36000-S40X	LLL36000-S60X	LRL36000-S40X	LRL36000-S60X	
	Four-Pole	LGL46000-S40X	LGL46000-S60X	LLL46000-S40X	LLL46000-S60X	LRL46000-S40X	LRL46000-S60X	
UL 489	Withstand Ratings	240 Vac	65 kA	65 kA	125 kA	125 kA	200 kA	200 kA
		480 Vac	35 kA	35 kA	100 kA	100 kA	200 kA	200 kA
		600 Vac	18 kA	18 kA	50 kA	50 kA	100 kA	100 kA
	AC Trip Point		4800 A	6600 A	4800 A	6600 A	4800 A	6600 A
	Conventional Thermal Current	lth 50°C	400 A	600 A	400 A	600 A	400 A	600 A
	Rated Insulation Voltage (Ui)		800 Vac	800 Vac	800 Vac	800 Vac	800 Vac	800 Vac
	Rated Impulse Withstand Voltage (Uimp)		8 kV	8 kV	8 kV	8 kV	8 kV	8 kV
	Rated Operational Voltage	AC 50/60 Hz	690 Vac	690 Vac	690 Vac	690 Vac	690 Vac	690 Vac
	Rated Operational Current (Ie)	AC 525 V	400 A	600 A	400 A	600 A	400 A	600 A
	Making Capacity (kA peak)		7.1	8.5	7.1	8.5	7.1	8.5
	Short-Time Withstand Current	Icw (kA rms)	5	6	5	6	5	6
		Duration (s)	1	1	1	1	1	1
	Utilization Category		AC 22 A	AC 22 A	AC 22 A	AC 22 A	AC 22 A	AC 22 A
	Pollution Degree	IEC 60664-1	3	3	3	3	3	3

# Motor Circuit Protection

## General Information

The parameters to be considered for motor-feeder protection depend on:

- the application (type of machine driven, operating safety, frequency of operation, etc.)
- the level of continuity of service required by the load or the application
- the applicable standards for the protection of equipment.

The required electrical functions are:

- isolation
- switching, generally at high endurance levels
- protection against overloads and short-circuits, adapted to the motor
- additional special protection.

A motor branch circuit must comply with the requirements of standard UL 508 concerning contactors and their protection:

- coordination of feeder components
- overload relay trip classes.

## Motor Branch Circuit Protection Function

A motor branch circuit comprises a set of devices for motor protection and control, as well as for protection of the branch circuit itself.

## Switching

The purpose is to control the motor (ON / OFF), either manually, automatically or remotely, taking into account overloads upon start-up and the long service life required. This function is provided by a contactor. When the coil of the contactor's electromagnet is energized, the contactor closes and establishes, through the poles, the circuit between the upstream supply and the motor, through the circuit breaker.

## Basic Protection

- Short-circuit protection  
Detection and breaking, as quickly as possible, of high short-circuit currents to avoid damage to the installation. This function is provided by a circuit breaker.
- Overload protection  
Detection of overload currents and motor shutdown before temperature rise in the motor and conductors damages insulation. This function is provided by a circuit breaker or a separate motor overload relay.
- Phase unbalance or phase loss protection  
Phase unbalance or phase loss can cause temperature rise and braking torques that can lead to premature aging of the motor. These effects are even greater during starting, therefore protection must be virtually immediate.

## Additional Electronic Protection

- Locked rotor
- Under-load
- Long starts and stalled rotor
- Insulation faults

## Trip Class of an Overload Relay Device

The motor branch circuit includes thermal protection that may be built into the circuit breaker. The protection must have a trip class suited to motor starting. Depending on the application, the motor starting time varies from a few seconds (no-load start) to a few dozen seconds (high-inertia load).

### Trip Class of Overload Relays as a Function of Their FLA Setting

Class	1.05 FLA <sup>137</sup>	1.2 FLA <sup>137</sup>	1.5 FLA <sup>138</sup>	6.0 FL <sup>137</sup>
5	$t > 2 \text{ h}$	$t < 2 \text{ h}$	$t < 2 \text{ mn}$	$2 \text{ s} < t \leq 5 \text{ s}$
10	$t > 2 \text{ h}$	$t < 2 \text{ h}$	$t < 4 \text{ mn}$	$4 \text{ s} < t \leq 10 \text{ s}$
20	$t > 2 \text{ h}$	$t < 2 \text{ h}$	$t < 8 \text{ mn}$	$6 \text{ s} < t \leq 20 \text{ s}$

Example: In class 20, the motor must have finished starting within 20 seconds (6 to 20 s) for a starting current of 6 x FLA.

## Asynchronous-Motor Starting Parameters

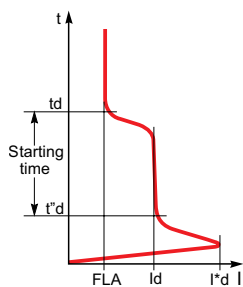

Typical motor-starting curve

The main parameters of direct on-line starting of three-phase asynchronous motors (90% of all applications) are listed below.

- FLA: full load amperes  
This is the current drawn by the motor at full rated load.
- $I_d$ : locked rotor current  
This is the current drawn by the motor during starting, on average  $6.0 \times I_n$  for a duration of 5 to 30 seconds depending on the application. These values determine the trip class and any additional “long-start” protection devices that may be needed.
- $I'_d$ : peak starting current  
This is the sub-transient current during the first two half-waves when the system is energized, on the average  $14 I_n$  for 10 to 15 ms (e.g. 1840 A peak).

The protection settings must effectively protect the motor, notably through a suitable overload relay trip class, but let the peak starting current through.

## Motor-Feeder Solutions

PowerPacT H-, J-, and L-frame circuit breakers motor circuit breakers are designed for motor-feeder solutions using:

- three devices, including an electronic MCP or 1.3 M instantaneous-only trip unit

137. Time for a cold start (motor off and cold).

138. Time for warm start (motor running under normal conditions).

- two devices including a 2 M electronic trip unit.

## PowerPacT H-, J-, and L-Frame with MicroLogic Trip Units Motor-Protection Range

PowerPacT H-, J-, and L-frame circuit breakers with MicroLogic trip units can be used to create motor-feeder solutions comprising two or three devices. The protection devices are designed for continuous duty at 104°F (40°C).



### Three-device solutions

- 1 PowerPacT circuit breaker with MicroLogic 1.3 M trip unit
- 1 contactor
- overload relay

### Two-device solutions

- 1 PowerPacT circuit breaker with a MicroLogic 2 M electronic trip unit.
- 1 contactor

### Motor Protection Specifications

Type of Motor Protection		3 Devices (Circuit Breaker + Contactor + Overload Relay)	2 Devices (Circuit Breaker + Contactor)
PowerPacT H-, J-, or L-Frame Circuit Breaker		PowerPacT L-Frame 400/600 A	PowerPacT H-, J-, and L-Frame 100–600 A
Type 2 Coordination with:		Contactor + Overload Relay	Contactor
Trip Unit	Type	MicroLogic 1.3 M Electronic Trip Unit 	MicroLogic 2 M Electronic Trip Unit 
	Overload Relay		
	Separate	X	
	Built-in, Class:		X
		5	
		10	
		20	X
Protection Functions of PowerPacT H-, J-, and L-Frame Circuit Breaker			
Short Circuits		X	X
Overloads			X
Special Motor Functions	Phase Unbalance		X



## Electronic Motor Circuit Protectors (AC Only)



PowerPacT H- and J-frame Electronic Motor Circuit Protectors (MCP) are instantaneous-trip circuit breakers. They are designed to offer short-circuit protection and are National Electrical Code® (NEC®) compliant when installed as part of a combination controller having motor overload protection. MCP circuit breakers accept the same accessories and terminals as the equivalent thermal-magnetic circuit breakers. (See Accessories and Auxiliaries, page 144 for Accessories.)

The unique design of the PowerPacT MCPs includes two rotary switches to allow quick setting adjustments based on the characteristics of the motor.

The first rotary switch allows for Full Load Amperes (FLA) adjustment across the range of the frame size.

The second rotary switch selects the type of motor protection based on Automatic 1 for Standard Efficiency or Automatic 2 for High Energy Efficient. When using the automatic settings the MCP microprocessor automatically adjusts the trip settings for both current and time to align with the start-up characteristic for the motor type, whether it is a standard or energy-efficient motor. This includes a dampening means to accommodate a transient motor in-rush current without nuisance tripping of the circuit breaker. Rotary switch 2 also allows for traditional motor protection from 8 to 13 times the selected FLA.

The MCP rotary switches allow the device to be set to specific trip values within a typical accuracy range of +/-5%.

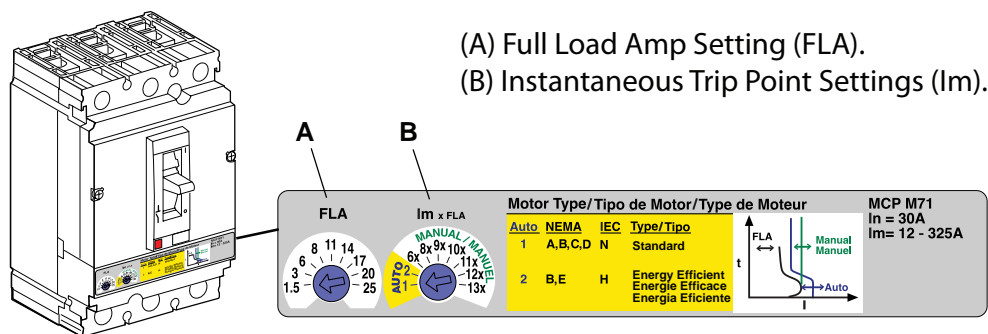

### Full Load Ampere Settings

1. Determine the motor's full-load current by referring to the nameplate on the motor.
2. Set the trip range by turning the FLA rotary switch to the setting closest to the motor's full load current.

## Automatic Protection Settings

The MCP microprocessor automatically adjusts the trip settings for both current and time to align with the start-up characteristics for the motor type selected. This includes a dampening means to accommodate a transient motor in-rush current without nuisance tripping of the circuit breaker.

### Automatic Protection Settings

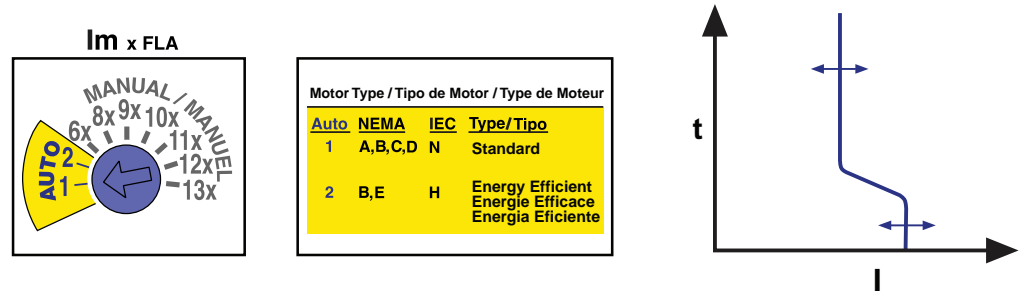

## Manual Protection Settings

The manual settings may be adjusted to multiples of current based on the rotary switch setting for motor Full Load Amperes (FLA).

$$\text{Instantaneous Trip Point} = (\text{FLA}) \times (I_m)$$

For example, if FLA rotary switch is set to 20 and  $I_m$  rotary switch is set to 9x, then the instantaneous trip point will be 180 A.

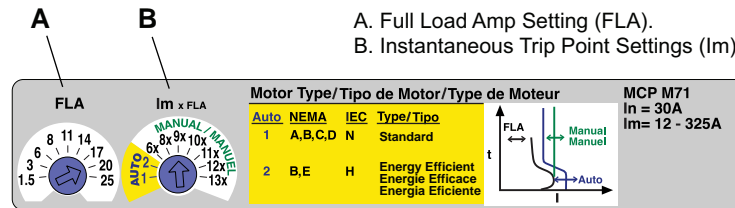

See Additional Technical Characteristics , page 76 for more information.

### H- and J-Frame Electronic Motor Circuit Protectors (MCP)

Frame	Current	Full Load Amperes Range	Adjustable Instantaneous Trip Range	Suffix	J Interrupting	L Interrupting <sup>139</sup>	R Interrupting <sup>139</sup>
					Cat. No.	Cat. No.	Cat. No.
H-Frame	30 A	1.5–25 A	9–325 A	M71	HJL36030M71	HLL36030M71	HRL36030M71
	50 A	14–42 A	84–546 A	M72	HJL36050M72	HLL36050M72	HRL36050M72
	100 A	30–80 A	180–1040 A	M73	HJL36100M73	HLL36100M73	HRL36100M73
	150 A	58–130 A	348–1690 A	M74	HJL36150M74	HLL36150M74	HRL36150M74
J-Frame	250 A	114–217 A	684–2500 A	M75	JJL36250M75	JLL36250M75	JRL36250M75

139. See Short-Circuit Current Ratings (SCCR), page 69.

- High Short-Circuit Current Ratings (SCCR)  
The PowerPacT MCP helps achieve the high UL508A Short-Circuit Current Rating (SCCR) needed to meet NEC Article 409 requirements for industrial control panels. They deliver up to 100 kA at 480 Vac SCCR when used in combination with approved Square D NEMA or Schneider Electric IEC motor starters.

**Short-Circuit Current Ratings (SCCR)**

Contactor/Starter	J Interrupting			L Interrupting			R Interrupting		
	200–240 Vac	480 Vac	600 Vac	200–240 Vac	480 Vac	600 Vac	200–240 Vac	480 Vac	600 Vac
TeSys D-line and F-line	100 kA	65 kA	25 kA	100 kA	100 kA	50 kA	200 kA	200 kA	100 kA
NEMA Type S	100 kA	65 kA	25 kA	100 kA	100 kA	50 kA	200 kA	200 kA	100 kA

**MCP Selection by HP Ratings of Induction-Type Squirrel-Cage and Wound-Rotor Motors**

Horsepower Rating of Induction-Type Squirrel-Cage and Wound-Rotor Motors 3Ø 60 Hz					NEC Full Load Amperes	PowerPacT H-Frame and J-Frame Electronics MCP	
Starter Size	200 Vac	230 Vac	480 Vac	575 Vac			
00	1/2	1/2	1/2	1/2	0.9 A	HJL36030M71 and HLL36030M71 1/2 — 10 hp	
				3/4	1.1 A		
				1	1.3 A		
				1	1.7 A		
				1	2.1 A		
				1	2.2 A		
				1-1/2	2.4 A		
				1-1/2	2.5 A		
				2	2.7 A		
	3/4	3/4	3/4	1-1/2	3 A		
				2	3.2 A		
				2	3.4 A		
				2	3.7 A		
				3	3.9 A		
				3	4.2 A		
				3	4.8 A		
				3	4.8 A		
				5	6 A		
1	1	1-1/2	3	5	6.1 A		
				5	6.8 A		
				5	6.9 A		
				5	7.6 A		
				5	7.8 A		
				5	9 A		
0	2	3	7-1/2	7-1/2	9.6 A		
				10	11 A		
				10			
				10			

**MCP Selection by HP Ratings of Induction-Type Squirrel-Cage and Wound-Rotor Motors (Continued)**

1	5	5	10	15	14 A	HJL36050M72 and HLL36050M72 10–25 hp	
			15		15.2 A		
		17 A					
		17.5 A					
		7-1/2	20		21 A		
	25		22 A				
	2	10	10	20	25		25.3 A
				20	27 A		
				25	28 A		
				30	32 A		
30				32.2 A			
3	15	15	25	40	34 A	HJL36100M73 and HLL36100M73 15–50 hp	
			30		40 A		
			30		41 A		
			40		42 A		
			40		48.3 A		
	20	20	20	40	50		52 A
				50	54 A		
				50	60		62 A
				60	65 A		
				60	68 A		
25	25	25	60	75	77 A		
			75		78.2 A		
			75		80 A		
			100		92 A		
			100		96 A		
4	30	30	75	100	99 A	HJL36150M74 and HLL36150M74 30–100 hp	
			100		104 A		
			100		120 A		
			125		124 A		
			125		125 A		
5	50	50	100	125	130 A	JL36250M75 and JLL36250M75 50–150 hp	
			150		144 A		
			150		150 A		
			150		154 A		
			150		156 A		
	60	60	60	125	150		177.1 A
				150			180 A
				150			180 A
				200			192 A
				200			192 A
75	75	75	200	200	221 A		
			200		240 A		
			200		248 A		
100	100	100	200	200	240 A		
			200		248 A		

Shaded area is not covered by J-Frame electronic motor circuit protector.

# MicroLogic 1.3 M Electronic Trip Units for Instantaneous Protection Only (L-Frame Circuit Breakers Only)

MicroLogic 1.3 M trip units are used in 3-device motor-feeder solutions on PowerPacT L-frame circuit breakers with performance levels G/J/L. They provide short-circuit protection for motors up to 250 kW at 400 V.



MicroLogic 1.3 M trip units provide instantaneous protection only, using electronic technology. They are dedicated to 600 A three-pole (3P 3D) circuit breakers or four-pole circuit breakers with detection on three poles (4P, 3D). They are especially used in three-pole versions for motor protection.

Circuit breakers equipped with MicroLogic 1.3 M trip units, without thermal protection, are used in certain applications to replace automatic switches. MicroLogic 1.3 M trip units are available on PowerPacT L-frame circuit breakers only.

**NOTE:** All MicroLogic trip units have a transparent, sealable cover that protects access to the adjustment rotary switches.

They also provide the benefits of electronic technology:

- accurate settings
- tests
- “Ready” LED.

Circuit breakers with a MicroLogic 1.3 M trip unit are combined with a overload relay and a contactor.

Protection settings are made using a rotary switch.

## Protection Version

Three pole (3P): three-pole frame circuit breakers equipped with detection on all three poles.

## Indications

The green “Ready” LED blinks slowly when the electronic trip unit is ready to provide protection. It indicates the trip unit is operating correctly.

**NOTE:** All the trip units have a transparent sealable cover that protects access to the adjustment rotary switches.

### MicroLogic 1.3 M Electronic Trip Unit

Rating: In at 104°F (40°C) <sup>140</sup>		400 A	600 A
Circuit Breaker	PowerPacT L-frame	X	X
Short-time protection			

140. Motor standards require operation at 104°F (40°C). Circuit breaker ratings are derated to take this requirement into account.

**MicroLogic 1.3 M Electronic Trip Unit (Continued)**

Rating: In at 104°F (40°C) <sup>141</sup>		400 A	600 A
Pick-up (A) accuracy ±15%	Isd There is a very short delay to let through motor starting currents.	Adjustable directly in amperes	
		9 settings: 2000-2400-2800- 3200-3600-4000-4800 A	9 settings: 3000-3600-4200- 4800-5400-6000-6600-7200 A
Time delay (ms)	tsd	Non-adjustable	
	Non-tripping time Maximum break time	20 60	
Instantaneous protection			
Pick-up (A) accuracy ±15%	li non-adjustable	4800	7200
	Non-tripping time Maximum break time	0 30 ms	

141. Motor standards require operation at 104°F (40°C). Circuit breaker ratings are derated to take this requirement into account.

## MicroLogic 2.2 M and 2.3 M Electronic Trip Units

MicroLogic 2.2 M and 2.3 M trip units provide built-in thermal and instantaneous protection. They are used in two-device motor-feeder solutions on PowerPacT H-, J-, and L-frame circuit breakers with performance levels J/L. They provide protection for motors up to 315 kW at 400 V against:

- short-circuits
- overloads with selection of a trip class (5, 10 or 20)
- phase unbalance.

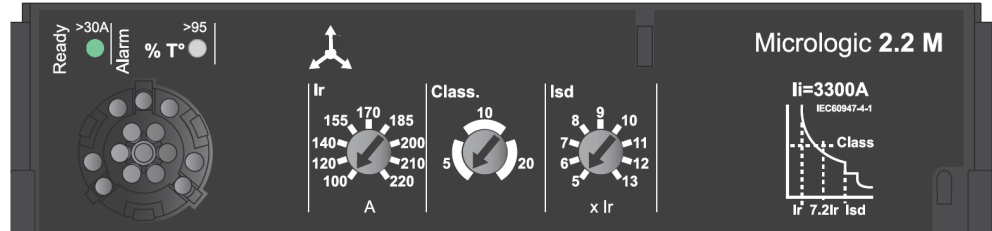

Circuit breakers with a MicroLogic 2.2 M / 2.3 M trip unit include protection similar to an inverse-time overload relay. They are combined with a contactor.

Protection settings are made using a rotary switch.

## Overloads (or Thermal Protection)

Long-time protection and trip class (FLA)

- Inverse-time thermal protection against overloads with adjustable pick-up FLA.
- Settings are made in amperes. The tripping curve for long-time protection, which indicates time delay  $t_r$  before tripping, is defined by the selected trip class.

## Trip Class

The class is selected as a function of the normal motor starting time.

- Class 5: starting time less than 5 s
- Class 10: starting time less than 10 s
- Class 20: starting time less than 20 s

For a given class, all motor-feeder components must be sized to carry the 6 x FLA starting current without excessive temperature rise during the time corresponding to the class.

## Short Circuits

Short-time protection ( $I_{sd}$ )

- Provides protection with an adjustable pick-up  $I_{sd}$ .
- There is a very short delay to let through motor starting currents.

Non-adjustable instantaneous protection ( $I_i$ )

- Instantaneous protection with non-adjustable pick-up  $I_i$ .

## Phase Unbalance or Phase Loss ( $I_{unbal}$ )

This function opens the circuit breaker if a phase unbalance occurs that is greater than the 30% fixed pick-up  $I_{unbal}$  following the non-adjustable time delay  $t_{unbal}$  equal to:

- 0.7 s
- 4 s during normal operation

Phase loss is an extreme case of phase unbalance and leads to tripping under the same conditions.

## Indications

### Front indications

- The green “Ready” LED blinks slowly when the electronic trip unit is ready to provide protection. It indicates the trip unit is operating correctly.
- Red alarm LED for motor operation goes ON when the thermal image of the rotor and stator is greater than 95% of the permissible temperature rise.

### Remote indications using SDTAM module

- PowerPacT H-, J-, and L-frame devices with a MicroLogic 2 M trip unit can be equipped with an SDTAM module dedicated to motor applications for:
  - A contact to indicate circuit-breaker overload.
  - A contact to open the contactor. In the event of a phase unbalance or overload, this output is activated 400 ms before circuit-breaker tripping to open the contactor and avoid circuit breaker tripping
- This module takes the place of the shunt trip (MN)/undervoltage trip (MX) coils and an auxiliary switch (OF) contact

SDTAM remote indication relay module with its terminal block.

**NOTE:** All the trip units have a transparent sealable cover that protects access to the adjustment rotary switches.



## MicroLogic 2.2 M and 2.3 M Electronic Trip Unit

### MicroLogic 2.2 M and 2.3 M Electronic Trip Unit

Rating: In at 104°F (40°C) <sup>142</sup>		30 A	50 A	100 A	150 A	250 A	400 A	600 A			
Circuit Breaker	PowerPacT H-frame	X	X	X	X	—	—	—			
	PowerPacT J-frame	—	—	—	—	X	—	—			
	PowerPacT L-frame	—	—	—	—	—	X	X			
<b>Overloads (or Thermal Protection): Long-Time Protection and Trip Class</b>											
Pick-Up (A) Tripping between 1.05 and 1.20 FLA	FLA		Value depending on trip unit rating (In) and setting on rotary switch								
	In = 30 A	FLA =	14	16	18	20	21	22	23	24	25
	In = 50 A	FLA =	14	17	21	24	27	29	32	36	42
	In = 100 A	FLA =	30	35	41	45	51	56	63	71	80
	In = 150 A	FLA =	58	71	78	86	91	97	110	119	130
	In = 250 A	FLA =	114	137	145	155	163	172	181	210	217
	In = 400 A	FLA =	190	210	230	250	270	290	310	330	348
	In = 600 A	FLA =	312	338	364	390	416	442	468	484	520
<b>Time Delay</b>											
Trip Class			5	10	20						
Time Delay (s) Depending on selected trip class	tr	1.5 x FLA	120	240	480	For warm start					
		6 x FLA	6.5	13.5	26	For cold start					
		7.2 x FLA	5	10	20	For cold start					
<b>S Short Circuits: Short-time protection with fixed time delay</b>											
Pick-up (A) accuracy ±15%	Isd = FLA x	5	6	7	8	9	10	11	12	13	
Time delay (ms)	tsd	Non-adjustable									
	Non-tripping time	20									
	Maximum break time	60									
<b>I Short Circuit: Non-adjustable instantaneous protection</b>											
Pick-up (A) accuracy ±15%	Ii non-adjustable	450	750	1500	2250	3750	4800	7200			
Time delay (ms)	Non-tripping time	0									
	Maximum break time	30 ms									
<b>Phase unbalance or phase loss</b>											
Pick-up (A) accuracy ±20%	I <sub>unbal</sub> in % average current <sup>143</sup>	30%									
Time delay (ms)	Non-adjustable	0.7 s during starting 4 s during normal operation									

142. Motor standards require operation at 104°F (40°C). Circuit-breaker ratings are derated to take this requirement into account.

143. The unbalance measurement takes into account the most unbalanced phase with respect to the average current.

## Additional Technical Characteristics

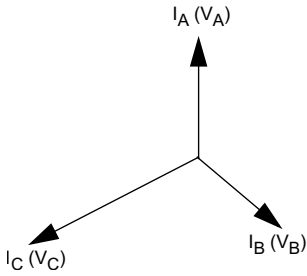
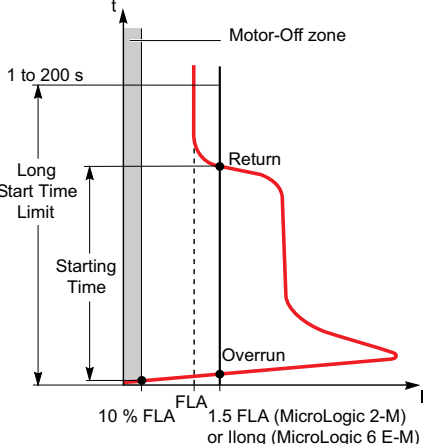
<p><b>Unbalance of Phase Currents and Voltages</b></p>  <p><b>Motor Starting and Long Starts</b></p> 	<p>Phase unbalance</p> <p>An unbalance in three-phase systems occurs when the three voltages are not equal in amplitude and/or not displaced 120° with respect to each other. It is generally due to single-phase loads that are incorrectly distributed throughout the system and unbalance the voltages between the phases. These unbalances create negative current components that cause braking torques and temperature rise in asynchronous machines, thus leading to premature aging.</p>
	<p>Phase loss</p> <p>Phase loss is a special case of phase unbalance.</p> <ul style="list-style-type: none"> <li>• During normal operation, it produces the effects mentioned above and tripping must occur after four seconds.</li> <li>• During starting, the absence of a phase may cause motor reversing, i.e. it is the load that determines the direction of rotation. This requires virtually immediate tripping (0.7 seconds).</li> </ul> <p>Starting time in compliance with the class (MicroLogic 2 M)</p> <p>For normal motor starting, MicroLogic 2 M checks the conditions below with respect to the thermal-protection (long-time) pick-up FLA:</p> <ul style="list-style-type: none"> <li>• current &gt; 10% x FLA (motor-off limit)</li> <li>• overrun of 1.5 x FLA threshold, then return below this threshold before the end of a 10 s time delay.</li> </ul> <p>If either of these conditions is not met, the thermal protection trips the device after a maximum time equal to that of the selected class. Pick-up FLA must have been set to the current indicated on the motor rating plate.</p>
	<p>Starting time in compliance with the class (MicroLogic 2 M)</p> <p>For normal motor starting, MicroLogic 2 M checks the conditions below with respect to the thermal-protection (long-time) pick-up FLA:</p> <ul style="list-style-type: none"> <li>• current &gt; 10% x FLA (motor-off limit)</li> <li>• overrun of 1.5 x FLA threshold, then return below this threshold before the end of a 10 s time delay</li> </ul> <p>If either of these conditions is not met, the thermal protection trips the device after a maximum time equal to that of the selected class.</p> <p>Pick-up FLA must have been set to the current indicated on the motor rating plate.</p>

### L-Frame Electronic Trip Unit Magnetic Only Three-Pole, 600 Vac, 50/60 Hz—Three Device Solutions

Sensor Rating		Trip Unit	Adjustable Trip Range (A) <sup>144</sup>	G Interrupting Cat. No.	J Interrupting Cat. No.	L Interrupting Cat. No.	R Interrupting Cat. No.
PowerPacT L-Frame <sup>145</sup>	400	1.3 M	500–1200%	LGL36400M37X	LJL36400M37X	LLL36400M37X	LRL36400M37X
	600		500–1200%	LGL36600M37X	LJL36600M37X	LLL36600M37X	LRL36600M37X

### H-Frame (150 A), J-Frame (250 A) and L-Frame (600 A) Electronic Motor Protector Circuit Breakers (UL Ratings)—Two Device Solutions

Electronic Trip Unit Type <sup>146</sup>	Frame	Sensor Rating	Trip Unit	FLA Range	Isd (x FLA)	G Interrupting Rating Cat. No.	J Interrupting Rating Cat. No.	L Interrupting Rating Cat. No.	R Interrupting Rating Cat. No.
Standard <sup>147</sup>	H	30	2.2 M	14–25	5-13 x FLA	HGL36030M38X	HJL36030M38X	HLL36030M38X	HRL36030M38X
		50		14–42	5-13 x FLA	HGL36050M38X	HJL36050M38X	HLL36050M38X	HRL36050M38X
		100		30–80	5-13 x FLA	HGL36100M38X	HJL36100M38X	HLL36100M38X	HRL36100M38X
		150		58–130	5-13 x FLA	HGL36150M38X	HJL36150M38X	HLL36150M38X	HRL36150M38X

144. UL magnetic trip tolerances are -20%/+30% from the nominal values shown.

145. Three-device solutions are the traditional solutions: motor circuit protector plus motor starter plus overload relay.

146. Two-device solutions (these electronic motor protector circuit breakers include short circuit and overload protection)  
 —1 electronic motor circuit protector with a MicroLogic 2.2 M electronic trip unit, plus  
 —1 contactor

147. The standard trip unit offers Class 5, 10 and 20 and phase unbalance or phase loss protection.

### H-Frame (150 A), J-Frame (250 A) and L-Frame (600 A) Electronic Motor Protector Circuit Breakers (UL Ratings)—Two Device Solutions (Continued)

Electronic Trip Unit Type <sup>148</sup>	Frame	Sensor Rating	Trip Unit	FLA Range	I <sub>sd</sub> (x FLA)	G Interrupting Rating Cat. No.	J Interrupting Rating Cat. No.	L Interrupting Rating Cat. No.	R Interrupting Rating Cat. No.
	J	250		114–217	5-13 x FLA	JGL36250M38X	JJL36250M38X	JLL36250M38X	JRL36250M38X
	L	400	2.3 M	190–348	5-13 x FLA	LGL36400M38X	LJL36400M38X	LLL36400M38X	LRL36400M38X
		600		312–520	5-13 x FLA	LGL36600M38X	LJL36600M38X	LLL36600M38X	LRL36600M38X

148. Two-device solutions (these electronic motor protector circuit breakers include short circuit and overload protection)  
 —1 electronic motor circuit protector with a MicroLogic 2.2 M electronic trip unit, plus  
 —1 contactor

# Energy Management

## Energy Management Using the Smart System

Use the Smart System to connect your building to real savings in three steps:

1. Measure  
Embedded and stand-alone metering and control
2. Connect
  - Integrated communication interfaces
  - Ready to connect to energy management platforms
3. Save
  - Data-driven energy efficiency actions
  - Real-time monitoring and control
  - Access to energy and site information through on-line services



### Measure

Smart System communications mean visible information.

Grouping most of the electrical protection, command and metering components, the switchboards are now significant sources of data locally displayed and sent via communication networks.

## Connect

Smart Systems use reliable, simple-to-install-and-use displays, and Ethernet and Modbus interfaces.

Information is safely transmitted through the most efficient networks:

- Modbus SL inside switchboards, between components
- Ethernet, on cable or WiFi, inside the building and connecting switchboards and computers
- Ethernet or GPRS, for access to on-line services by Schneider Electric
- Energy experts, no matter where they are located, can now provide advice based on the updated data of the building.

## Save

### On-Site Real-Time Monitoring



The FDM128 touch screen display connected to the Ethernet:

- shows essential electrical information and alarms concerning the electrical network
- allows control (open, close, reset) of various equipment

The FDM128 touch screen provides real-time value checking and control, directly on the front panel of the main switchboard. On a PC display with common browser:

- shows monitoring web pages hosted into the local Ethernet interface
- alarm events generate automatic email notifications
- allows control (open, close, reset) of various equipment

The data is displayed graphically or recorded into files for optimizing the use of energy in the building. As an example, the data can help validate the change of temperature settings, time scheduling in a Building Management System or other automated devices.

### On-Line Energy Management Services

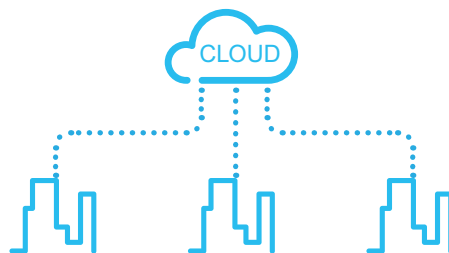

StruXureWare Energy Operation automates data collection using an open, scalable, and secure energy management information system.

With the help of the Schneider Electric energy management services team, data is turned into information to enable customers to understand their facilities' performance on an ongoing basis.

Energy Operation leverages companies' current investments in their existing systems, and can be used to communicate advanced results and performance to a broad audience for a shared understanding throughout an organization.

## Smart System Communication Components

### PowerPacT Circuit Breakers with MicroLogic Trip Units

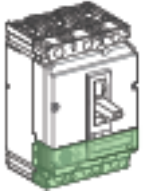

Trip Unit

#### Ammeter A

- MicroLogic 5 A selective protection
- MicroLogic 6 A selective + ground-fault protection

#### Energy E

- MicroLogic 5 E selective protection
- MicroLogic 6 E selective + ground-fault protection

## Displays



Power Meter

#### FDM121

- One-to-one front display module
- See Display Functions, page 81 for more information.

#### FDM128

- One-to-eight front display module
- See Display Functions, page 81 for more information.



Operating Assistance Functions

## Communication



- PowerPacT and ComPacT circuit breakers in a communication network
- I/O application module
- IFE: Ethernet interface module
- IFM: Modbus interface module
- EcoStruxure Panel Server

For more information, see Smart System Communication Wiring System, page 117.



I/O Module



IFE Module



IFM Module



Panel Server

## Power Meter Functions

In addition to protection functions, MicroLogic A/E trip units offer all the functions of Power Meter products as well as operating assistance for the circuit breaker.

MicroLogic A/E trip unit measurement functions are made possible by the MicroLogic trip unit's intelligence and the accuracy of the sensors. They are handled by a microprocessor that operates independent of protection functions.

## Display Functions

### MicroLogic Trip Unit LCD

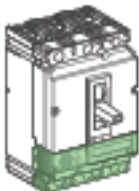

Trip Unit LCD

The user can display all the protection settings and the main measurements on the LCD screen of the trip unit.

- MicroLogic A trip unit: instantaneous rms current measurements
- MicroLogic E trip unit: voltage, frequency and power measurements and energy metering, in addition to the measurements offered by MicroLogic A

To make the display available under all conditions and increase operating comfort, an external power supply is recommended for MicroLogic A trip unit. It is required to:

- display faults and interrupted current measurements
- use all the functions of MicroLogic E trip unit (such as metering of low power and energy values)
- ensure operation of the communication network

The external power supply can be shared by several devices. For description, see 24 Vdc Power Supply, page 122.

## FDM121 Display Unit (One to One)



Display Function

The FDM121 switchboard display unit can be connected to a communication (COM) option (Breaker Communication Module [BSCM]) using a circuit breaker ULP cord to display all measurements on a screen. The LCD screen is 3.78 x 3.78 in. (96 x 96 mm). The FMD121 display unit requires a 24 Vdc power supply. The COM option (BSCM) unit is supplied by the same power supply via the circuit breaker ULP cord connecting it to the FDM121. See FDM121 Display, page 91 for more information.



FDM121 Display Navigation

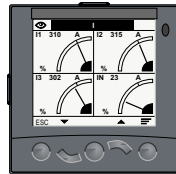

FDM121 Display Current

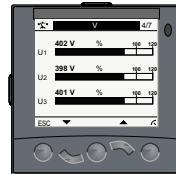

FDM121 Display: Voltage

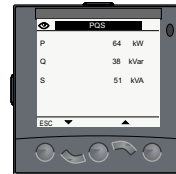

FDM121 Display: Power

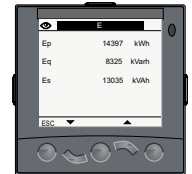

FDM121 Display: Consumption

## FDM128 Display Unit (One to Eight)

The FDM128 display unit uses an IFE Ethernet interface for low-voltage circuit breakers.



FDM128 Display Navigation

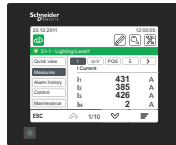

FDM128 Display Current



FDM128 Display: Voltage



FDM128 Display: Power

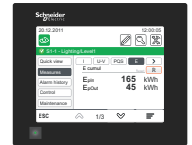

FDM128 Display: Consumption

For all FDM, in addition to the information displayed on the MicroLogic trip unit LCD, the FDM screen shows demand, power quality, and maximum/minimum ammeter values along with histories and maintenance indicators.



## Measurement Functions

### Instantaneous RMS Measurements



Measurement Function

The MicroLogic trip unit continuously displays the RMS value of the highest current of the three phases and neutral ( $I_{max}$ ). The navigation buttons can be used to scroll through the main measurements.

In the event of a fault trip, the trip cause is displayed.

The MicroLogic A trip unit measures phase, neutral, and ground fault currents.

MicroLogic E trip units offer voltage, power, frequency, and energy metering in addition to the measurements provided by MicroLogic A trip units.

### Maximum / Minimum Ammeter

Every instantaneous measurement provided by MicroLogic A/E trip units can be associated with a maximum/minimum ammeter. The maximum for the highest current of the three phases, neutral, and demand current can be reset using the MicroLogic trip unit keypad, FDM display unit, or the communication system.

### Energy Metering

The MicroLogic E trip units also measures the energy consumed since the last reset of the meter. The active energy meter can be reset using the MicroLogic trip unit keypad, the FDM display unit, or the communication system.

### Demand and Maximum Demand Values

MicroLogic E trip units also calculate demand current and power values. These calculations can be made using a block or sliding interval that can be set from five to sixty minutes in steps of one minute. The window can be synchronised with a signal sent through the communication system. Whatever the calculation method, the calculated values can be recovered on a PC through the communication network.

Ordinary spreadsheet software can be used to provide trend curves and forecasts based on this data. They provide a basis for load shedding and reconnection operations used to adjust consumption to the subscribed power.

### Power Quality

The MicroLogic E trip unit calculates power quality indicators taking into account the presence of harmonics up to the fifteenth harmonic, including the total harmonic distortion (THD) of current and voltage.



**MicroLogic 5/6 Trip Units Integrated Power Meter Functions**

			Type		Display		
			A	E	Trip Unit LCD	Front Display Module	
<b>Display of Protection Settings</b>							
Pick-ups (A) and delays	All settings can be displayed	$I_r, t_r, I_{sd}, t_{sd}, I_i, I_g, t_g$	X	X	X	—	
<b>Instantaneous rms measurements</b>							
Currents	Phase and neutral	$I_A, I_B, I_C, I_N$	X	X	X	X	
	Average of phases	$I_{avg} = (I_A + I_B + I_C) / 3$	X	X	—	X	
	Highest current of the 3 phases and neutral	$I_{max}$ of $I_A, I_B, I_C, I_N$	X	X	X	X	
	Ground fault (MicroLogic 6 trip unit)	% $I_g$ (pick-up setting)	X	X	X	X	
	Current unbalance between phases	% $I_{avg}$	—	X	—	X	
Voltage	Phase-to-phase	$V_{AB}, V_{BC}, V_{CA}$	—	X	X	X	
	Phase-to-neutral	$U_{AN}, U_{BN}, U_{CN}$	—	X	X	X	
	Average of phase-to-phase voltages	$V_{avg} = (V_{AB} + V_{AC} + V_{BC}) / 3$	—	X	—	X	
	Average of phase-to-neutral voltages	$U_{avg} = (U_{AN} + U_{BN} + U_{CN}) / 3$	—	X	—	X	
	Ph-Ph and Ph-N voltage unbalance	% $V_{avg}$ and % $U_{avg}$	—	X	—	X	
	Phase sequence	1-2-3, 1-3-2	—	X	X	X	
Frequency (Hz)	Power Systems	$f$	—	X	X	X	
Power	Active (kW)	$P$ , total/per phase	—	X	X	X	
	Reactive (kVAR)	$Q$ , total/per phase	—	X	X	X	
	Apparent (kVA)	$S$ , total/per phase	—	X	X	X	
	Power factor and $\cos \phi$ (fundamental)	PF and $\cos \phi$ , total and per phase	—	X	—	X	
<b>Maximum, minimum (MAX/MIN)</b>							
	Associated with instantaneous rms measurements	Reset with MicroLogic trip unit or front display module	X	X	—	X	
<b>Energy metering</b>							

## MicroLogic 5/6 Trip Units Integrated Power Meter Functions (Continued)

			Type		Display	
			A	E	Trip Unit LCD	Front Display Module
Energy	Active (kWh), reactive (kVAR), apparent (kVA)	Total since last reset	—	X	X	X
		Absolute or signed mode <sup>148</sup>	—	X	X	X
<b>Demand and maximum demand values</b>						
Demand current (A)	Phases and neutral	Present value on the selected window	—	X	—	X
		Maximum demand since last reset	—	X	—	X
Demand power	Active (kWh), reactive (kVAR), apparent (kVA)	Present value on the selected window	—	X	—	X
		Maximum demand since last reset	—	X	—	X
Calculation window		Adjustable from 5 to 60 minutes in 1 minute steps	—	X	—	149
<b>Power quality</b>						
Total harmonic distortion THD (%)	Of voltage with respect to rms value	THDU, THDV of the Ph-Ph and Ph-N voltage	—	X	—	X
	Of current with respect to rms value	THDI of the phase current	—	X	—	X

## Additional Technical Characteristics

Measurement accuracy of the entire measurement system, including the sensors:

- Current: +/- 1%
- Voltage: +/- 0.5%
- Power and energy: +/- 2%
- Frequency: +/- 0.1%

148. Absolute mode: E absolute = E out + E in; Signed mode: E signed = E out - E in.

149. Available through the communication network only.

# Operating-Assistance Functions Characteristics

## MicroLogic Trip Unit Alarms with Time-Stamping

### Alarm Types

The user can assign an alarm to all MicroLogic A or E trip unit measurements or events:

- up to 12 alarms can be used together:
- two alarms are predefined and activated automatically:  
MicroLogic 5 trip unit: overload ( $I_r$ )  
MicroLogic 6 trip unit: overload ( $I_r$ ) and ground fault ( $I_g$ )
- thresholds, priorities and time delays can be set for ten other alarms.
- the same measurement can be used for different alarms to precisely monitor certain values, e.g. the frequency or the voltage
- alarms can also be assigned to various states: phase lead/lag, four quadrants, phase sequence selection of display priorities, with screen displaying a window showing high priority alarm
- alarm time-stamping.

### Alarm Settings

Alarms cannot be set using the keypad or the front display module. They are set through the communication network with the PC. Set-up includes the threshold, priority, activation delay before display and deactivation delay. It is also possible to reprogram the standard assignment for the two SDx relay outputs to user-selected alarms.

### Alarm Reading

Remote alarm indicators:

- reading on the front display module or on a PC through the communication network
- system remote indicators using SDx relay with two output contacts for alarms
- MicroLogic trip unit built-in LCD display

## Histories and Event Tables

MicroLogic A and E trip unit have histories and event tables that are always active.

### Three types of time-stamped histories

- Tripping due to overruns of  $I_r$ ,  $I_{sd}$ ,  $I_i$ ,  $I_g$ : last 17 trips
- Alarms: last 10 alarms
- Operating events: last 10 events

Each history record is stored with:

- indicators in clear text in a number of user-selectable languages
- time-stamping: date and time of event
- status: pick-up / drop-out

### Two types of time-stamped event tables

- Protection settings
- Minimums / maximums

### Display of alarms and tables

The time-stamped history and event tables may be displayed on a PC through the communication network.

**Embedded memory**

MicroLogic A and E trip units have a non-volatile memory that saves all data on alarms, histories, event tables, counters and maintenance indicators even if power is lost.

**Maintenance Indicators**

MicroLogic A and E trip units have indicators for, among others, the number of operating cycles, contact wear and operating times (operating hours counter) of the PowerPacT H-, J-, and L-frame circuit breakers.

It is possible to assign an alarm to the operating cycle counter to plan maintenance. The various indicators can be used together with the trip histories to analyze the level of stresses the device has been subjected to. The information provided by the indicators cannot be displayed on the MicroLogic trip unit LCD. It is displayed on the PC through the communication network.

## Management of Installed Devices

Each circuit breaker equipped with a MicroLogic 5 or 6 trip unit can be identified using the communication network:

- serial number
- firmware version
- hardware version
- device name assigned by the user

This information together with that previously described provides a clear view of the state of the installed devices.

**NOTE:** Please refer to Display Functions, page 81 for more details on display formats.

**MicroLogic 5/6 Trip Units Operating Assistance Functions**

		Type		Display		150						
		A	E	Trip Unit LCD	Front Display Module							
<b>Personalized Alarms</b>												
Settings	Up to 10 alarms assigned to all A and E measurements	X	X	—		150						
	Phase lead/lag, four quadrants, phase sequence, display priority selection	—	X	—		150						
Display	Alarms and tripping	X	X	—		150						
Remote Indicators	Activation of two dedicated contacts on SDx module	X	X	—		150						
<b>Time-Stamped Histories</b>												
Trips (last 17)	Cause of tripping (time-stamping with ms)	Ir, Isd, li (MicroLogic 5, 6 Trip Unit)	X	X	—	150						
		Ig (MicroLogic 6 Trip Unit)	X	X	—	150						
<b>Alarms (last 10)</b>			X	X	—	150						
Operating events (last 10)	Event types	Modification of protection setting by rotary switch	—	X	—	150						
		Opening of keypad lock	—	X	—	150						
		Test using keypad	—	X	—	150						
		Test using external tool	—	X	—	150						
		Time setting (date and time)	—	X	—	150						
		Reset for maximum, minimum and energy meter	X	X	X	X						
Time Stamping	Presentation	Date and time, text, status	X	X	—	150						
<b>Time-Stamped Event Tables</b>												
Protection settings	Setting modified (value displayed)	Ir	tr	Isd	tsd	li	Ig	tg	X	X	—	150
	Time-stamping Previous value	Date and time of modification Value before modification							X	X	—	150
Min/Max	Values monitored	IA	IB	IC	IN	li			X	X	—	150
	Time-stamping Previous value	Date and time of min/max record Min/max value							X	X	—	150
<b>Maintenance Indicators</b>												
Counter	Mechanical cycles <sup>151</sup> Electrical cycles <sup>151</sup> Trips Alarms Hours	Assignable to an alarm Assignable to an alarm One per type of trip One for each type of alarm Total operating time (hours)						X	X	—	150	
Indicator	Contact wear	%						X	X	—	150	
Load profile	Hours at different load levels	% of hours in four current ranges: 0–49% In, 50–79% In, 80–89% In and ≥ 90% In						X	X	—	150	

**Additional Technical Characteristics:**

- **Contact wear**  
Each time a PowerPacT H-, J-, or L-frame circuit breaker opens, the MicroLogic 5/6 trip unit measures the interrupted current and increments the contact-wear indicator as a function of the interrupted current, according to test results stored in memory. Breaking under normal load conditions results in a very slight increment. The indicator value may be read on the front display module. It provides an estimation of contact wear calculated on the basis of the cumulative forces affecting the circuit breaker. When the indicator reaches 80%, it is advised to replace the circuit breaker to ensure the availability of the protected equipment.

150. Available through the communication network only.

151. The Breaker Status and Control Module (Breaker Status and Control Module (BSCM) Modbus SL or ULP, page 135) is required for these functions.

- Circuit breaker load profile  
MicroLogic 5/6 trip units calculate the load profile of the circuit breaker protecting a load circuit. The profile indicates the percentage of the total operating time at four current levels (% of  $I_n$ ):
  - 0 to 49%  $I_n$
  - 50 to 79%  $I_n$
  - 80 to 89%  $I_n$
  - $\geq 90\%$   $I_n$
- This information can be used to optimize use of the protected devices or to plan ahead for expansion.

## Motor Circuit Protectors (AC Only)



See Motor Circuit Protection, page 64 for information about PowerPacT H-, J- and L-frame electronic motor circuit protectors (MCP) with trip units:

MicroLogic 1.3 M

MicroLogic 2 M



## FDM121 Display

MicroLogic trip unit measurement capabilities come into full play with the FDM121 display. It connects with a circuit breaker ULP cord and displays the MicroLogic trip unit information. The result is a true integrated unit combining a circuit breaker and a power meter. Additional operating assistance functions can also be displayed.

An FDM121 display unit can be connected to ULP communication devices using a prefabricated cord to display all measurements, alarms, histories and event tables, maintenance indicators, and management of installed devices on a screen.

The FMD121 display unit requires a 24 Vdc power supply.

The FDM121 is a display that can be integrated with the PowerPacT H/J/L/P/R or MasterPacT NW/NT circuit breaker systems. It uses the sensors and processing capacity of the MicroLogic trip unit. It is easy to use and requires no special software or settings. It is immediately operational when connected to the circuit breaker by a ULP cord.

It also provides monitoring and control with the use of the I/O application module, the motor mechanism module, or the circuit breaker communication module.

The FDM121 has a large display, but requires very little depth. The anti-glare graphic screen is backlit for very easy reading even under poor ambient lighting and at sharp angles.

## Display of MicroLogic Trip Unit Measurements and Alarms

The FDM121 is intended to display MicroLogic trip unit measurements, alarms and operating information. It cannot be used to modify the protection settings.

Measurements can be easily accessed using a menu. All user-defined alarms are automatically displayed. The display mode depends on the priority level selected during alarm set-up:

- high priority: a pop-up window displays the time-stamped description of the alarm and the orange Alarm LED flashes;
- medium priority: the orange Alarm LED goes continuously on;
- low priority: no display on the screen.

All detected faults resulting in a trip automatically produce a high-priority alarm, without any special settings required. In all cases, the alarm history is updated. The MicroLogic trip unit saves the information in its non-volatile memory in the event of an FDM121 power loss.

## Status Indications and Remote Control



FDM121 Display

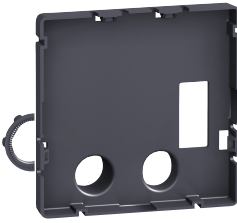

Surface Mount Accessory

When the circuit breaker is equipped with the Breaker Communications Module (BSCM), the FDM121 display can also be used to view circuit breaker status conditions:

- O/F: ON/OFF
- SD: trip indication
- SDE: fault-trip indication (overload, short-circuit, or ground fault).

When the circuit breaker system is equipped with the I/O application module, the FDM121 can monitor and control:

- cradle management
- circuit breaker operation
- light and load control
- custom applications.

When the circuit breaker is equipped with the communication motor operator etc., the FDM121 display can also be used to control (open/close) the circuit breaker.

Two operating mode are available:

- local mode: open/close commands are enabled from the FDM121 while disabled from the communication network;
- remote mode: open/close commands are disabled from the FDM121 while enabled from the communication network.

## Main Characteristics



Connection with FDM121 Display Unit

- A 3.78 x 3.78 x 1.18 in. (96 x 96 x 30 mm) screen requiring 0.39 in. (10 mm) behind the door (or 0.79 in. [20 mm] when the 24 V power supply connector is used)
- White backlighting
- Wide viewing angle: vertical  $\pm 60^\circ$ , horizontal  $\pm 30^\circ$
- High resolution: excellent reading of graphic symbols
- Alarm LED: flashing orange for alarm pick-up, steady orange after operator reset if the alarm condition persists
- Operating temperature range:  $+14^\circ\text{F}$  ( $-10^\circ\text{C}$ ) to  $+131^\circ\text{F}$  ( $+55^\circ\text{C}$ )
- CE / UL / CSA marking
- 24 Vdc power supply, with tolerances: 24 V -20% (19.2 V) to 24 V +10% (26.4 V)

When the FDM121 is connected to the communication network, the 24 Vdc can be supplied by the communication system wiring system. Consumption is 40 mA.

## Mounting

The FDM121 is easily installed in a switchboard.

- Standard door cut-out is 3.6 x 3.6 in. (92 x 92 mm).
- Attached using clips.

To avoid a cut-out in the door, an accessory is available for surface mounting by drilling only two 0.87 in. (22 mm) diameter holes.

## Connection

The FDM121 is equipped with a 24 Vdc terminal block:

- A plug-in type terminal block with two wire inputs per point for easy daisy-chaining.
- A power supply range of 24 Vdc -20% (19.2 V) to 24 Vdc +10% (26.4 V).  
A 24 Vdc type auxiliary power supply must be connected to a single point on the ULP system. The FDM121 display has a two-point screw connector on the rear panel of the module for this purpose. The ULP module to which the auxiliary power supply is connected distributes the supply via the ULP cable to all the ULP modules connected to the system and therefore also to MicroLogic trip unit. See wiring diagram later in this section.
- Two RJ45 jacks.

The MicroLogic trip unit connects to the internal communication terminal block on the PowerPacT or ComPacT circuit breaker with the circuit breaker ULP cord. Connection to one of the RJ45 connectors on the FDM121 automatically establishes communication between the MicroLogic trip unit and the FDM121 and supplies power to the MicroLogic trip unit measurement functions. When the second connector is not used, it must be fitted with a line terminator.

## Navigation

Five buttons are used for intuitive and fast navigation. The “Context” button may be used to select the type of display (digital, bar graph, analog). The user can select the display language (Chinese, English, French, German, Italian, Portuguese, Spanish, etc.).

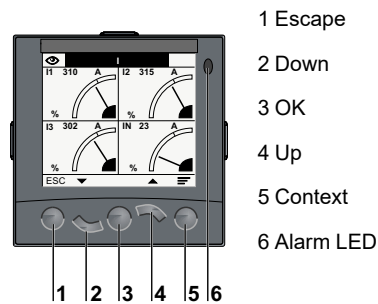

Product Identification

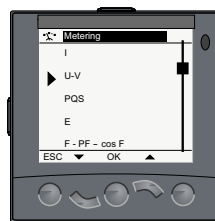

Metering: Submenu

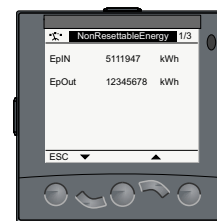

Metering: Meter

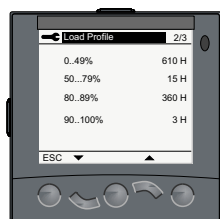

Services

## Screens

### Main Menu

When powered up, the FDM121 screen automatically displays the ON/OFF status of the device.



Quick View



Metering



Control



Alarms



Services

When not in use, the screen is not backlit. Backlighting can be activated by pressing one of the buttons. It goes off after three minutes.

### Access to Essential Information

- “Quick view” provides access to five screens that display a summary of essential operating information (I, U-V, f, P, E, THD, circuit breaker ON/OFF).

### Access to Detailed Information

- “Metering” can be used to display the measurement data (I, U-V, f, P, Q, S, E, THD, PF) with the corresponding min/max values.
- “Alarms” displays active alarms and the alarm history.
- “Services” provides access to the operation counters, energy and maximum ammeter reset function, maintenance indicators, identification of modules connected to the internal bus, and FDM121 internal settings (language, contrast, etc.).

# Communication Components and FDM121 Connections

The FDM121 degree of protection is IP54 in front. IP54 is maintained after switchboard mounting by using the supplied gasket during installation.

## FDM121 Connections

### Connections

PowerPacT circuit breaker is connected to the I/O module or FDM121 display unit via the internal terminal block for the NSX cord equipped with an RJ45 connector:

- Cord is available in three lengths: 0.98 ft. (0.35 m), 4.3 ft. (1.3 m) and 9.8 ft. (3 m).
- Lengths up to 32.9 ft. (10 m) are possible using extensions.

The FDM121 display unit and the I/O module are connected to:

- the IFM Modbus interface by a communication cable with RJ45 connectors on both ends or
- the IFE Ethernet interface module by a communication cable with RJ45 connectors on both ends.

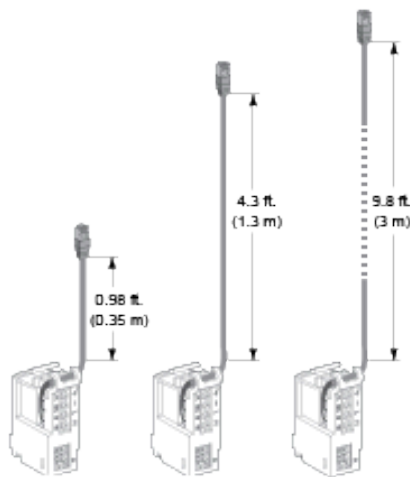

### Communication Components and Connections, IFM

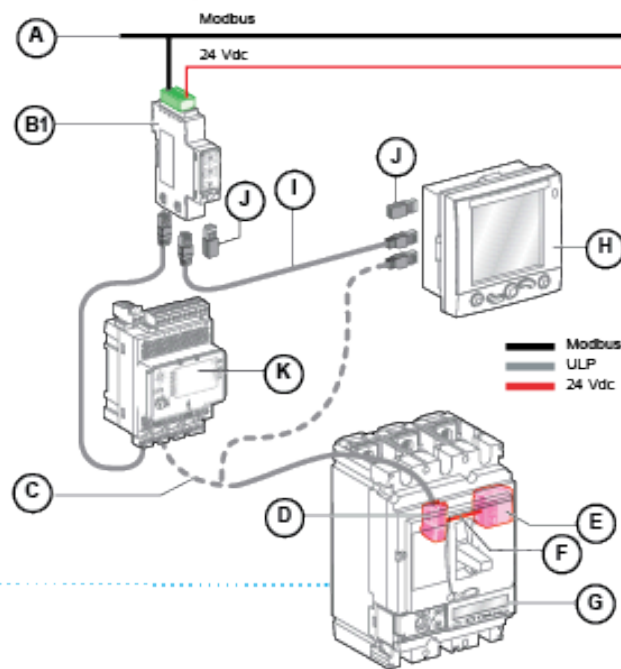

### Communication Components and Connections, IFE

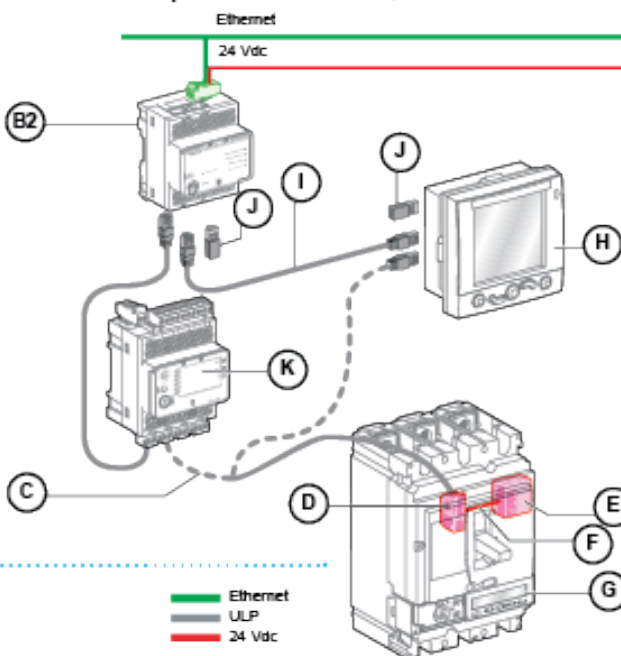

- A. Modbus Network
- B. Modbus Interface
- B1: IFM Modbus Interface
- B2: IFE Modbus Interface
- C. NSX Cord
- D. Internal Terminal Block for Communication via NSX Cord
- E. BSCM Module
- F. Prefabricated wiring
- G. MicroLogic Trip Unit
- H. FDM121 Display
- I. RJ45 Cable
- J. Line Terminator (on unused connector if applicable)
- K. I/O Module

## FDM128 Display

The MicroLogic trip unit measurement capabilities are fully utilized with the FDM128 display. The FDM128 display connects to Ethernet communication using the RJ45 port and displays MicroLogic trip unit information. The result is an integrated unit combining a circuit breaker with a power meter. Additional operating assistance functions can also be displayed.

The FDM128 display unit can be connected to a MicroLogic COM option (BSCM). It uses the sensors and processing capacity of the MicroLogic trip unit and requires no special software or settings. The FDM128 is a large display, but requires very little depth. The anti-glare graphic screen is backlit for easy reading even under poor ambient lighting and at sharp angles.

The FDM128 display is designed to manage up to eight devices (PowerPacT H/J/L/P/R or MasterPacT NW/NT circuit breakers).

## Display of MicroLogic Trip Unit Measurements and Trips

The FDM128 is intended to display MicroLogic 5/6 trip unit measurements, trips, and operating information. It cannot be used to modify the protection settings.

- Measurements may be easily accessed using a menu.
- Trips are automatically displayed.
- A pop-up window displays the time-stamped description of the trip.

## Status Indications

When the circuit breaker is equipped with the COM option (BSCM) (including its set of sensors) the FDM128 display can also be used to view circuit breaker status conditions:

- O/F: ON/OFF
- SDE: Fault-trip indication (overload, short-circuit, ground fault)
- CE, CD, CT cradle management with I/O application module.

## Remote Control

When the circuit breaker is equipped with the COM option (BSCM) (including connection to a communicating motor operator), the FDM128 display can also be used to operate (open/close) the circuit breaker.

Two operating mode are available:

- Local mode: open/close commands are enabled from the FDM128 while disabled from the communication network.
- Remote mode: open/close commands are disabled from the FDM128 while enabled from the communication network.

## Main Characteristics



FDM128 Display

- 4.54 x 3.40 in. (115.2 x 86.4 mm) with 5.7 in. (145 mm) QVGA display 320 x 240 pixels.
- Color TFT LCD, with LED backlight.
- Wide viewing angle: vertical  $\pm 80^\circ$ , horizontal  $\pm 70^\circ$ .
- High resolution: excellent reading of graphic symbols.
- Operating temperature range: +14°F (-10°C) to +131°F (+55°C).
- CE / UL / CSA marking.
- 24 Vdc power supply, -10%/+20% (limit 20.4 - 28.8 Vdc).
- Consumption 6.8 W.

## Mounting

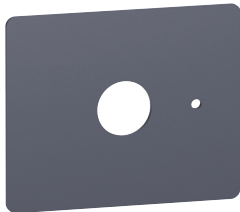

Surface Mount Accessory

The FDM128 is easily installed in a switchboard.

- Standard door hole  $\varnothing$  0.87 in. (22 mm).
- The FDM128 degree of protection is IP65 at the touch screen cover. IP54 is maintained after installation by using the supplied gasket.

## Connection



Connection with Display Unit

The FDM128 is equipped with:

- a 24 Vdc terminal block:
  - with a power supply range of 24 Vdc (limit 20.4 - 28.8 Vdc).
  - secures to the FDM128 display unit using a 2-point screw connector on the rear panel of the module.
- one RJ45 Ethernet jack.

The MicroLogic trip unit connects to the internal communication terminal block on the PowerPacT circuit breakers through the circuit breaker ULP cord and Ethernet connection through the IFE.

## Navigation

- A touch screen is used for intuitive and fast navigation.
- The user can select the display language (Chinese, English, French, German, Italian, Portuguese, Spanish, etc.).



Product Identification



Metering: Meter



Services

## Screens

### Main Menu



Quick View



Metering



Control



Alarms



Services

When not in use, the screen is automatically shifted to low back-lighting.

### Fast Access to Essential Information

- “Quick view” provides access to five screens that display a summary of essential operating information (I, U-V, f, P, E, THD, circuit breaker On / Off).

### Access to Detailed Information

- “Metering” can be used to display the measurement data (I, U-V, f, P, Q, S, E, THD, PF) with the corresponding min/max values.
- “Alarms” displays the trip history.
- “Services” provides access to the operation counters, energy and maximum ammeter reset function, maintenance indicators, identification of modules connected to the internal bus and FDM128 internal settings (language, contrast, etc.).

## Communication Components and FDM128 Connections

The FDM128 degree of protection is IP65 at the touch screen cover. IP54 is maintained after installation by using the supplied gasket.



## FDM128 Connections

### Communication Components and Connections

#### Connections

PowerPacT circuit breaker is connected to the I/O module or FDM121 display unit via the internal terminal block for the NSX cord equipped with an RJ45 connector:

- Cord is available in three lengths: 0.98 ft. (0.35 m), 4.3 ft. (1.3 m) and 9.8 ft. (3 m).
- Lengths up to 32.9 ft. (10 m) are possible using extensions.

The FDM121 display unit and the I/O module are connected to:

- the IFM Modbus interface by a communication cable with RJ45 connectors on both ends or
- the IFE Ethernet interface module by a communication cable with RJ45 connectors on both ends.

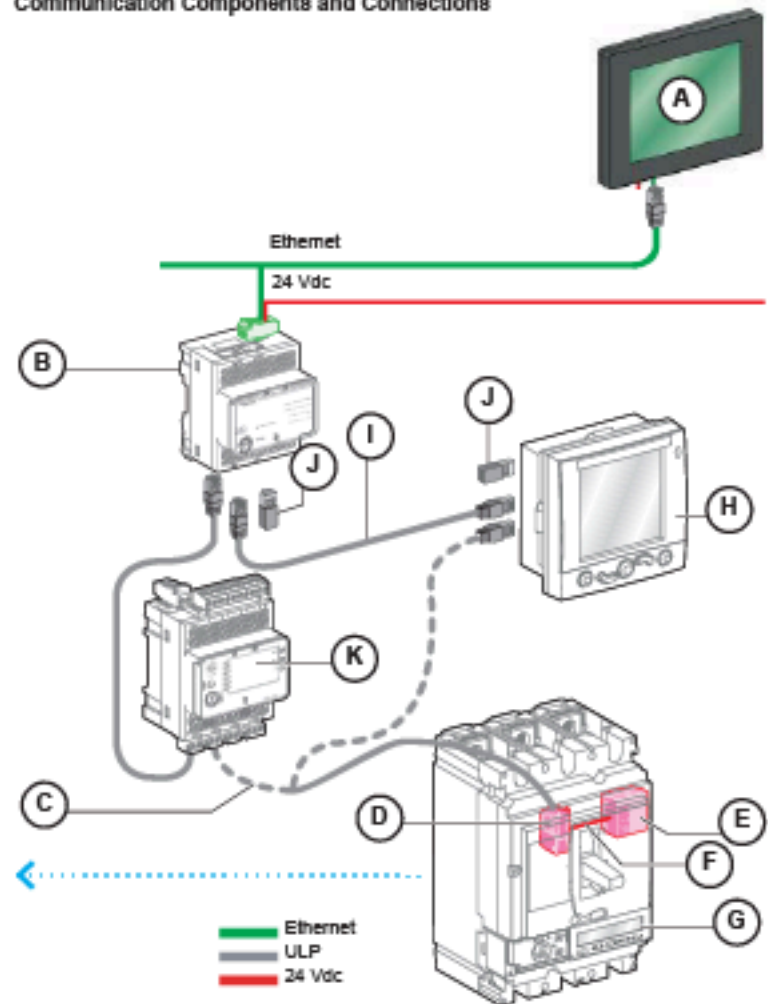
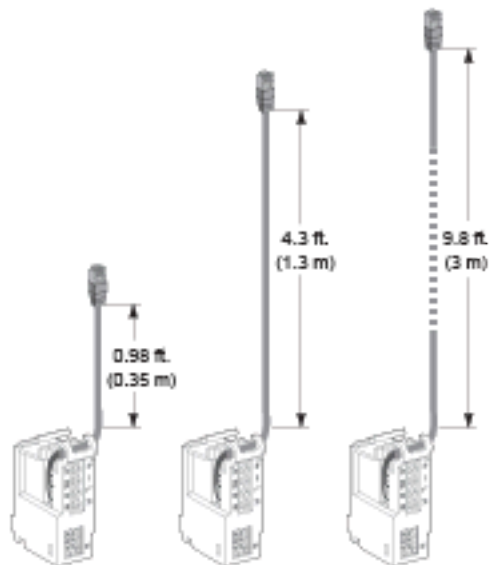



- A. FDM128
- B. IFE Modbus Interface
- C. NSX Cord
- D. Internal Terminal Block for Communication via NSX Cord
- E. BSCM Module
- F. Prefabricated wiring
- G. MicroLogic Trip Unit
- H. FDM121 Display
- I. RJ45 Cable
- J. Line Terminator (on unused connector if applicable)
- K. I/O Module

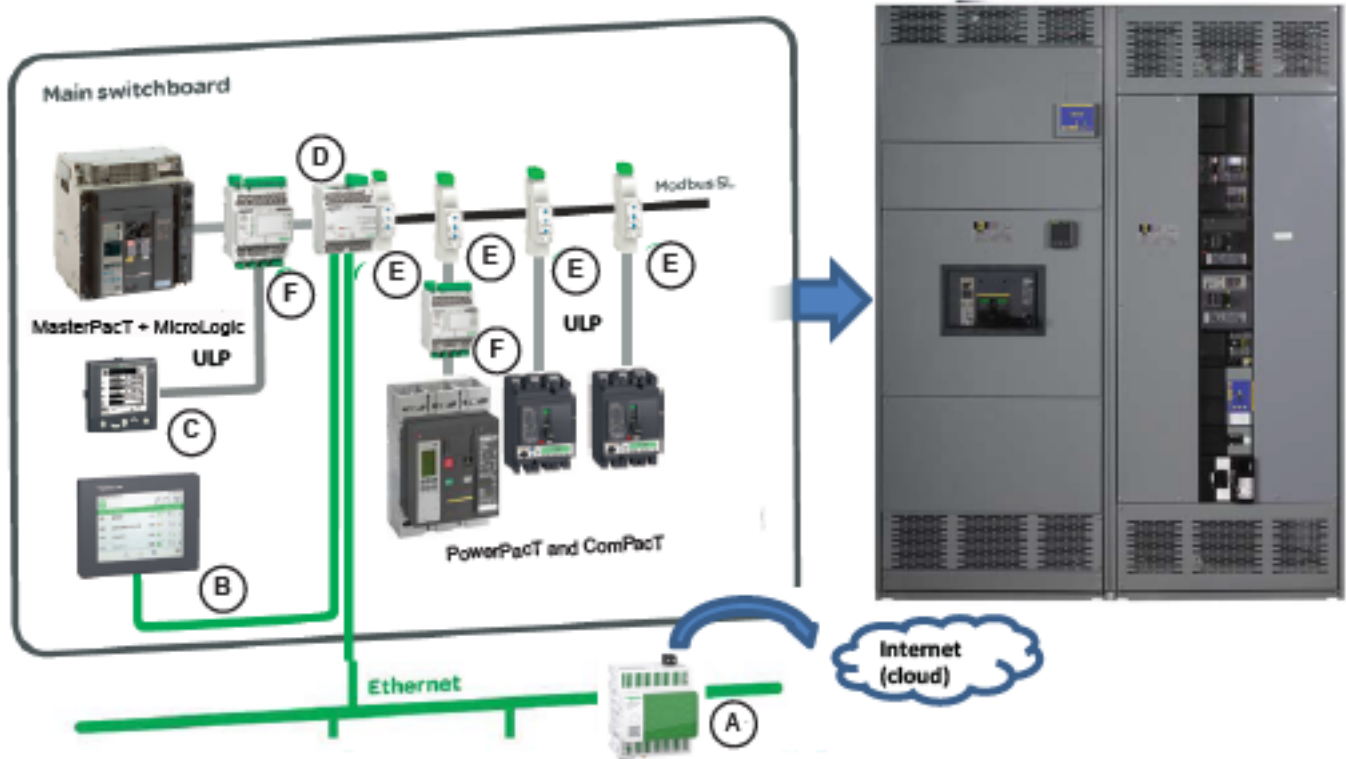

**Panelboard and Switchboard Connections**



**Smart System Communication Devices and Displays**

	Name	Function	Port		Bin. Input	Analog Input	Bin. Output
			To Device	To Server			
A	 Panel Server	All-in-one gateway to retrieve data, connect edge software, or cloud applications.	Modbus Client	Ethernet Cable + WiFi	2	—	—
B	 FDM128	Ethernet LCD Color Touch Screen	—	Ethernet	—	—	—
C	 FDM121	LCD Display for Circuit Breaker	ULP	—	—	—	—

**Smart System Communication Devices and Displays (Continued)**

	Image	Name	Function	Port		Bin. Input	Analog Input	Bin. Output
				To Device	To Server			
D		IFE Interface + Gateway	Ethernet Interface & Gateway	Modbus Client & ULP	Ethernet	—	—	—
		IFE Interface	Ethernet Interface for Circuit Breakers	ULP	Ethernet	—	—	—
E		IFM	Modbus Interface for Circuit Breakers	ULP	Modbus Server	—	—	—
F		I/O	Input/Output Application Module for Circuit Breakers	ULP	ULP	6	1	1

# Trip Units

## Available Trip Units

PowerPacT H-, J-, and L-frame circuit breakers offer a range of thermal-magnetic and MicroLogic electronic trip units in interchangeable cases. Thermal-magnetic trip units are designed to open automatically under overload or short circuit. H-frame and J-frame thermal-magnetic circuit breakers contain individual thermal (overload) and instantaneous (short circuit) sensing elements in each pole.

MicroLogic electronic trip units provide intelligent operation, with wide setting ranges make installation upgrades easier. Designed with processing capabilities, MicroLogic trip units can provide measurement information and device operating assistance to supply all of the information required to manage the electrical installation and optimize energy use.

MicroLogic trip units offer excellent measurement accuracy, using a new generation of current transformers combining “iron-core” sensors for self-powered electronics and “air-core” sensors (Rogowski coils) for measurements. The protection functions are managed by an ASIC component that is independent of the measurement functions. This independence ensures immunity to conducted and radiated disturbances and a high level of reliability.

An LED on the front of the electronic trip unit indicates the result of the self-test running continuously on the measurement system and the tripping release. When the green LED is flashing, the links between the CTs, the processing electronics and the Mitop release are operational. The circuit breaker is ready to protect. A minimum current of 15 to 50 A, depending on the device, is required for this function.

The dual adjustment for protection functions on MicroLogic 5/6 consists of:  
 — an adjustment using rotary switches to set the maximum value  
 — an adjustment using the keypad or remote controls to fine-tune the setting. This setting may not exceed the first one. It can be read directly on the MicroLogic screen, to within one ampere and a fraction of a second.

**NOTE:** All the trip units have a transparent sealable cover that protects access to the adjustment rotary switches.

For MicroLogic trip unit features, see PowerPacT H-, J-, and L-frame Circuit Breaker Trip Units, page 31.

### Understanding the Names of MicroLogic Electronic Trip Units

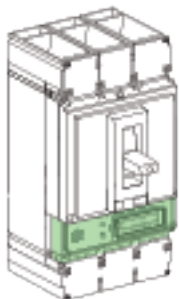
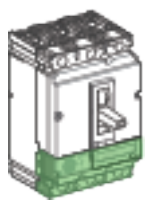











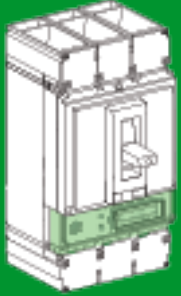

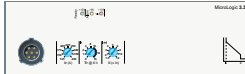
Protection	Frame	Measurements	Applications
1: I 3: LI or LSI 5: LSI 6: LSIG	H- and J-frame	A: Ammeter 	Distribution or M: Motors
L: Long time S: Short time I: Instantaneous G: Ground fault	L-frame	E: Energy 	

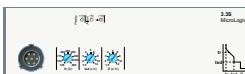
**Example Trip Unit Names**

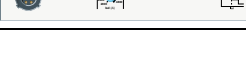

MicroLogic 1.3 M Trip Unit	Instantaneous only	400 or 600 A	Motor
MicroLogic 3.3 Trip Unit	LI	250, 400, or 600 A	Distribution
MicroLogic 3.2S Trip Unit	LSI	60, 100, 150, or 250 A	Distribution
MicroLogic 5.2A Trip Unit	LSI—Ammeter	60, 100, 150, or 250 A	Distribution

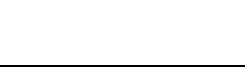
- Ir = long-time pickup                      The current level at which the circuit breaker long-time delay function begins timing.
- tr = long-time delay                      The length of time the circuit breaker will carry a sustained overcurrent (greater than the long-time pickup) before initiating a trip signal.
- Isd = short-time pickup                      The current level at which the circuit breaker short-time delay function begins timing.
- tsd = short-time delay                      The length of time the circuit breaker will carry a short circuit (current greater than the short-time pickup) before initiating a trip signal.
- Ii = instantaneous pickup                      The current level at which the circuit breaker will trip with no intentional time delay.
- Ig = ground-fault pickup                      The level of ground-fault current at which the trip system begins timing.

**Trip Unit Availability**

Trip Unit Type	Trip Unit	H-, J-Frame 	Trip Unit	L-Frame 
Distribution Protection Thermal-Magnetic	T-M		N/A	
Distribution Protection LI	MicroLogic 3.2 and 3.2-W		MicroLogic 3.3 and 3.3-W	
Distribution Protection LSI Fixed ST and LT delays	MicroLogic 3.2S and 3.2-SW		MicroLogic 3.3S and 3.3-SW	
Distribution Protection LSI + Ammeter	MicroLogic 5.2 A and 5.2 A-W		MicroLogic 5.3 A and 5.3 A-W	
Distribution Protection LSI + Energy Monitoring	MicroLogic 5.2 E and 5.2 E-W		MicroLogic 5.3 E and 5.3 E-W	
Distribution Protection LSIG + Ammeter	MicroLogic 6.2 A and 6.2 A-W		MicroLogic 6.3 A and 6.3 A-W	
Distribution Protection LSIG + Energy Monitoring	MicroLogic 6.2 E and 6.2 E-W		MicroLogic 6.3 E and 6.3 E-W	
Motor Circuit Protection Magnetic Only	M		N/A	
Motor Protection MicroLogic 1 M	N/A		MicroLogic 1.3M	

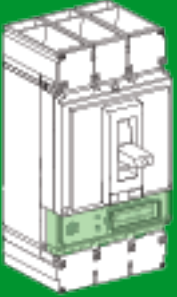
**Trip Unit Availability (Continued)**

Trip Unit Type	Trip Unit	<p>H-, J-Frame</p> 	Trip Unit	<p>L-Frame</p> 
Motor Protection MicroLogic 2 M	MicroLogic 2.2 M		MicroLogic 2.3 M	

W = mission critical trip unit.

# Protection of Distribution Systems

## Thermal-Magnetic Trip Units

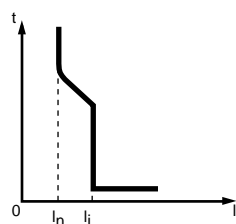

H-Frame Trip Curve  
 ( $I_n$ ) Fixed threshold thermal protection against overload  
 ( $I_i$ ) Fixed threshold instantaneous protection against short circuits

TM thermal-magnetic trip units can be used on PowerPacT H and J-frame circuit breakers with interrupting levels D/G/J/L. Thermal-magnetic trip units are available in factory sealed or field-interchangeable constructions.

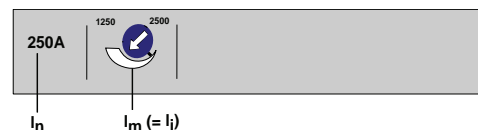

### H-Frame and J-Frame Three-Pole Field-Installable Thermal-Magnetic Trip Unit

15–60 A H-Frame		70–150 A H-Frame		150–250 A J-Frame	
H-Frame Trip Unit	Cat. No.	Amperage	Cat. No.	Amperage	Cat. No.
J-Frame Trip Unit Amperage					
15 A	HT3015	70 A	HT3070	150 A	JT3150
20 A	HT3020	80 A	HT3080	175 A	JT3175
25 A	HT3025	90 A	HT3090	200 A	JT3200
30 A	HT3030	100 A	HT3100	225 A	JT3225
35 A	HT3035	110 A	HT3110	250 A	JT3250
40 A	HT3040	125 A	HT3125	—	—
45 A	HT3045	150 A	HT3150	—	—
50 A	HT3050	—	—	—	—
60 A	HT3060	—	—	—	—

## MicroLogic 3 Trip Units

MicroLogic 3 trip units can be used on PowerPacT H-, J-, and L-Frame circuit breakers with performance levels D/G/J/L.

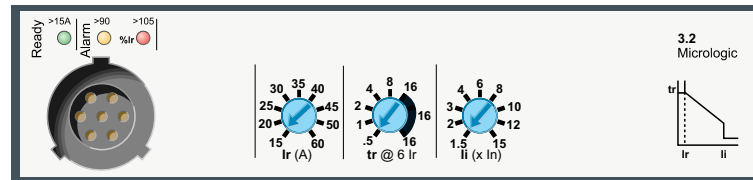

They provide:

- standard protection of distribution cables
- indication of:
  - overloads (using LEDs)
  - overload tripping (using the SDx relay module)

Circuit breakers equipped with MicroLogic 3 trip units can be used to protect distribution systems supplied by transformers.

### Protection

Settings are made using the adjustment rotary switches.

Overloads: Long time protection ( $I_r$ )

Inverse time protection against overloads with an adjustable current pick-up  $I_r$  set using a rotary switch and an adjustable time delay  $t_r$ .

### Neutral protection

- On three-pole L-frame circuit breakers, neutral protection is not possible.
- On four-pole L-frame circuit breakers, neutral protection may be set using a three-position switch:
  - switch position 4P 3D: neutral unprotected
  - switch position 4P 3D + N/2: neutral protection at half the value of the phase pick-up, ( $0.5 \times I_r$ )
  - switch position 4P 4D: neutral fully protected at  $I_r$



### Front indicators

- The green “Ready” LED blinks slowly when the electronic trip unit is ready to provide protection. It indicates the trip unit is operating correctly.
- Overload pre-alarm LED: steady on when  $I > 90\% I_r$
- Overload LED: steady on when  $I > 105\% I_r$

### Remote indicators

An overload trip signal can be remotely checked by installing an SDx relay module inside the circuit breaker. This module receives the signal from the MicroLogic electronic trip unit through an optical link and makes it available on the terminal block. The signal is cleared when the circuit breaker is reclosed. See SDx Module, page 152.

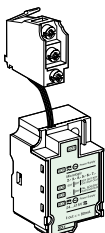

SDx Module



### MicroLogic 3 Trip Units

Ratings	In at 104°F (40°C) <sup>152</sup>	60 A	100 A	150 A	250 A	400 A	600 A					
Circuit Breaker	H-frame	X	X	X								
	J-frame				X							
	L-frame				X	X	X					
<b>MicroLogic 3.2 / 3.3 trip units<sup>153</sup></b>												
<b>L Long-time protection</b>												
Pick-Up (A) Tripping between 1.05 and 1.20 Ir	Ir	Value depending on sensor rating (In) and setting on rotary switch										
	In = 60 A	Ir =	15	20	25	30	35	40	45	50	60	
	In = 100 A	Ir =	35	40	45	50	60	70	80	90	100	
	In = 150 A	Ir =	50	60	70	80	90	100	110	125	150	
	In = 250 A	Ir =	70	80	100	125	150	175	200	225	250	
	In = 400 A	Ir =	125	150	175	200	225	250	300	350	400	
	In = 600 A	Ir =	200	225	250	300	350	400	450	500	600	
Time Delay (s) Accuracy 0 to -20%	tr	0.5, 1, 2, 4, 8, 16										
		1.5 x Ir	15	25	50	100	200	400				
		6 x Ir	0.5	1	2	4	8	16				
		7.2 x Ir	0.35	0.7	1.4	2.8	5.5	11				
Thermal memory	20 minutes before and after tripping											
<b>I Instantaneous</b>												
Pick-up (A) accuracy ± 15%	li x	60 A, 100 A	1.5	2	3	4	6	8	10	12	15	
		150 A	1.5	2	3	4	6	8	10	12	15	
		250 A	1.5	2	3	4	5	6	8	10	12	
		400 A	1.5	2	3	4	5	6	8	10	12	
		600 A	1.5	2	3	4	5	6	8	10	11	
		Non-tripping time Maximum break time	10 ms 50 ms for I > 1.5 li									
<b>MicroLogic 3.2S / 3.3S trip units<sup>153</sup></b>												
<b>L Long-time protection</b>												
Pick-Up (A) Tripping between 1.05 and 1.20 Ir	Ir	Value depending on sensor rating (In) and setting on rotary switch										
	In = 60 A	Ir =	15	20	25	30	35	40	45	50	60	
	In = 100 A	Ir =	35	40	45	50	60	70	80	90	100	
	In = 150 A	Ir =	50	60	70	80	90	100	110	125	150	
	In = 250 A	Ir =	70	80	100	125	150	175	200	225	250	
	In = 400 A	Ir =	125	150	175	200	225	250	300	350	400	
	In = 600 A	Ir =	200	225	250	300	350	400	450	500	600	
Time Delay (s) Accuracy 0 to -20%	tr	non-adjustable										
		1.5 x Ir	400									
		6 x Ir	16									
		7.2 x Ir	11									
Thermal memory	20 minutes before and after tripping											
<b>S Short-time protection</b>												

152. If the trip units are used in high-temperature environments, the MicroLogic trip unit setting must take into account the thermal limitations of the circuit breaker. See the temperature derating information [Temperature Derating](#), page 191.

153. Mission Critical trip units have a “-W” at the end of the number (for example 3.2-W). All other protections are the same and have the same trip curves.

**MicroLogic 3 Trip Units (Continued)**

Ratings	In at 104°F (40°C) <sup>154</sup>	60 A	100 A	150 A	250 A	400 A	600 A				
Pick-up (A) accuracy ± 10%	I <sub>sd</sub> - I <sub>r</sub> x...	1.5	2	3	4	5	6	7	8	10	
Time delay (ms)	tsd	non-adjustable									
	Non-tripping time Maximum break time	20 80									
I Instantaneous											
Pick-up (A) accuracy ± 15%	I <sub>i</sub> x	60 A, 100 A	1.5	2	3	4	6	8	10	12	15
		150 A	1.5	2	3	4	6	8	10	12	15
		250 A	1.5	2	3	4	5	6	8	10	12
		400 A	1.5	2	3	4	5	6	8	10	12
		600 A	1.5	2	3	4	5	6	8	10	11
		Non-tripping time Maximum break time	10 ms 50 ms for I > 1.5 I <sub>i</sub>								

154. If the trip units are used in high-temperature environments, the MicroLogic trip unit setting must take into account the thermal limitations of the circuit breaker. See the temperature derating information Temperature Derating, page 191.

## MicroLogic 5/6 A or E Trip Units

MicroLogic 5/6 A (Ammeter) or E (Energy) trip units can be used on PowerPacT H-, J-, and L-frame circuit breakers with performance levels D, G, J, or L. They all have a front display module. They offer basic LSI protection (MicroLogic 5 trip unit) or LSI and ground-fault protection G (MicroLogic 6 trip unit). They also offer measurement, alarm and energy values.

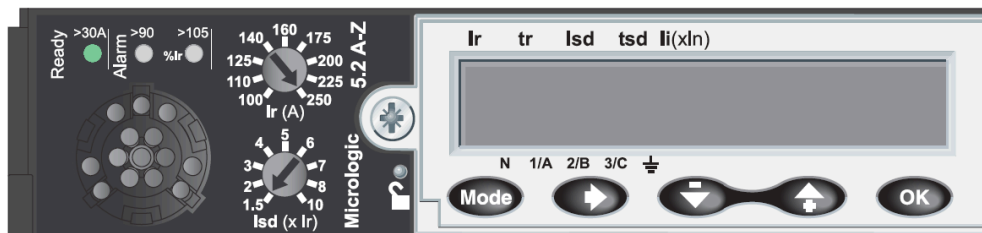

The capabilities of MicroLogic 5/6 A and E trip units come into full play with the front display module. When the two are connected using a simple cable with RJ45 connectors, the combination offers full Power Meter capabilities and all the measurements required to monitor the electrical installation.

### MicroLogic 5/6 A or E Trip Units

Trip Unit	Measurements	Operating and Maintenance Assistance	Communication Network
Ammeter (MicroLogic A Trip Unit)	<p>Current measurements</p> <ul style="list-style-type: none"> <li>Phase and neutral currents IA, IB, IC, IN</li> <li>Average current of the 3 phases Iavg</li> <li>Highest current of the three phases Imax</li> <li>Ground-fault current Ig (MicroLogic 6.2 / 6.3 A) trip units</li> <li>Maximum and minimum current measured</li> </ul>	<p>Indicators, alarms and histories</p> <ul style="list-style-type: none"> <li>Fault types</li> <li>Alarms for high/low alarm thresholds linked to I measurements</li> <li>Trip, alarm and operating histories</li> <li>Time-stamped tables for settings and maximum current</li> </ul> <p>Maintenance indicators</p> <ul style="list-style-type: none"> <li>Operation, trip and alarm counters</li> <li>Operating hours counter</li> <li>Contact wear</li> <li>Load profile and thermal image</li> </ul>	Modbus with add-on module
Energy (MicroLogic E Trip Unit)	<p>Current measurements</p> <ul style="list-style-type: none"> <li>Phase and neutral currents IA, IB, IC, IN</li> <li>Average current of the 3 phases Iavg</li> <li>Highest current of the three phases Imax</li> <li>Ground-fault current Ig (MicroLogic 6.2 / 6.3 A trip units)</li> <li>Maximum and minimum current measured</li> <li>Current unbalance between phases</li> </ul> <p>Voltage measurements</p> <ul style="list-style-type: none"> <li>Phase-to-phase (V) and phase-to-neutral (U) voltages</li> <li>Average voltages Vavg, Uavg</li> <li>Ph-Ph (V) and Ph-N (U) voltage unbalance</li> </ul> <p>Frequency measurements</p> <ul style="list-style-type: none"> <li>Frequency (f)</li> </ul> <p>Power-quality indicators</p> <ul style="list-style-type: none"> <li>Total harmonic distortion (THD) for current and voltage</li> </ul> <p>Power measurements</p> <ul style="list-style-type: none"> <li>Active, reactive and apparent power, total and per phase</li> <li>Power factor and cos φ</li> </ul> <p>Maximum and minimum</p> <ul style="list-style-type: none"> <li>For all I, V, f, P, E measurements</li> </ul> <p>Demand current and power measurements</p> <ul style="list-style-type: none"> <li>Demand values, total and per phase</li> <li>Maximum demand</li> </ul> <p>Energy metering</p> <ul style="list-style-type: none"> <li>Active, reactive and apparent energy, total and per phase</li> </ul>	<p>Indicators, alarms and histories</p> <ul style="list-style-type: none"> <li>Fault types</li> <li>Alarms for high/low thresholds linked to I, V, f, P, E measurements</li> <li>Trip, alarm and operating histories</li> <li>Time-stamped tables for settings and I, V, f, P, E maximum values</li> </ul> <p>Maintenance indicators</p> <ul style="list-style-type: none"> <li>Operation, trip and alarm counters</li> <li>Operating hours counter</li> <li>Contact wear</li> <li>Load profile and thermal image</li> </ul>	Modbus with add-on module

## Power Requirements

The amount of current needed to power the trip unit is printed in the upper left hand corner of the trip unit by the Ready LED.

### Trip Unit Power Requirements

Frame		Power-Up Requirement
H-Frame, 60 A	60 A	>15 A
	100 A	>15 A
	150 A	>30 A
J-Frame, 250 A	250 A	>30 A
L-Frame, 600 A	400 A	>50 A
	600 A	>50 A

## Protection

Settings can be adjusted in two ways, using the rotary switches and/or the keypad.

- The keypad can be used to make fine adjustments in 1 A steps below the maximum value defined by the setting on the rotary switch.
- Access to setting modifications using the keypad is protected by a locking function displayed on the screen and controlled by a microswitch.
- The lock is activated automatically if the keypad is not used for 5 minutes.
- Access to the microswitch is protected by a transparent, sealable cover.
- With the cover closed, it is still possible to display the various settings and measurements using the keypad.

### Overloads: Long-Time Protection ( $I_r$ )

Inverse time protection against overloads with an adjustable current pick-up  $I_r$  is set using a rotary switch or the keypad for fine adjustments. The time delay  $t_r$  is set using the keypad.

### Short-Circuits: Short-Time Protection ( $I_{sd}$ )

Short-circuit protection with an adjustable pick-up  $I_{sd}$  and adjustable time delay  $t_{sd}$ , with the possibility of including a portion of an inverse time curve ( $I^2t$  On).

### Short-Circuits: Instantaneous Protection ( $I_i$ )

Instantaneous protection with adjustable pick-up  $I_i$ .

### Additional Ground Fault Protection ( $I_g$ ) on MicroLogic 6 Trip Units

Residual type ground-fault protection with an adjustable pick-up  $I_g$  and adjustable time delay  $t_g$ . Possibility of including a portion of an inverse time curve ( $I^2t$  On).

### Neutral Protection

- On four-pole circuit breakers, this protection can be set using the keypad:
  - Off: neutral unprotected
  - 0.5: neutral protection at half the value of the phase pick-up ( $0.5 \times I_r$ )
  - 1.0: neutral fully protected at  $I_r$
  - OSN: Oversized neutral protection at 1.6 times the value of the phase pick-up. Used when there is a high level of 3rd order harmonics (or orders that are multiples of 3) that accumulate in the neutral and create a high current. In this case, the device must be limited to  $I_r = 0.63 \times I_n$  for the maximum neutral protection setting of  $1.6 \times I_r$ .

- With three-pole circuit breakers, the neutral can be protected by installing an external neutral sensor with the output (T1, T2) connected to the trip unit.

## Zone Selective Interlocking (ZSI)

A ZSI terminal block may be used to interconnect a number of MicroLogic trip units to provide zone selective interlocking for short-time ( $I_{sd}$ ) and ground-fault ( $I_g$ ) protection, without a time delay. For PowerPacT H- and J-frame circuit breakers, the ZSI function is available only in relation to the upstream circuit breaker (ZSI out). For PowerPacT L-frame circuit breakers, the ZSI function is available in relation to the upstream circuit breaker (ZSI out) and downstream circuit breakers (ZSI in).

## Display of Type of Fault

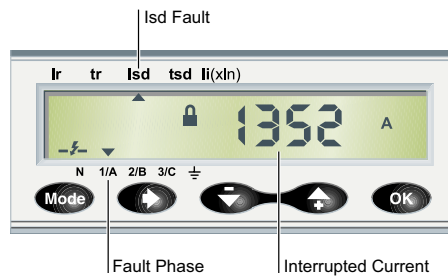

On a fault trip, the type of fault ( $I_r$ ,  $I_{sd}$ ,  $I_i$ ,  $I_g$ ), the phase concerned and the interrupted current are displayed. An external power supply is required.

Display of Interrupted Current

## Indicators

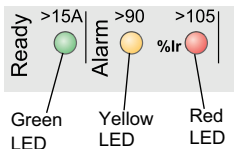

### Front Indicators

- The green “Ready” LED blinks slowly when the electronic trip unit is ready to provide protection. It indicates the trip unit is operating correctly.
- Orange overload pre-alarm LED stays on when  $I > 90\% I_r$
- Red overload LED stays on when  $I > 105\% I_r$

### Remote Indicators

An SDx relay module installed inside the circuit breaker can be used to remote the following information:

- overload trip
- overload prealarm (MicroLogic 5 trip units) or ground fault trip (MicroLogic 6 trip units)

This module receives the signal from the MicroLogic electronic trip unit through an optical link and makes it available on the terminal block. The signal is cleared when the circuit breaker is closed.

Note: all the trip units have a transparent sealable cover.

These outputs can be reprogrammed to be assigned to other types of tripping or that protects access to the adjustment rotary switch. The module is described in detail in the section dealing with accessories.

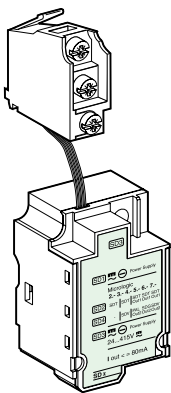

SDx Module

## MicroLogic 5/6 Trip Unit Ratings

### MicroLogic 5/6 Trip Unit—L Long-Time Protection

Ratings		In at 104°F (40°C) <sup>155</sup>	60 A	100 A	150 A	250 A	400 A	600 A				
Circuit Breaker <sup>156</sup>	H-frame		X	X	X							
	J-frame					X						
	L-frame						X	X				
Pick-up (A) tripping between 1.05 and 1.20 I <sub>r</sub>	I <sub>r</sub>	Rotary switch	Value depending on the trip unit rating (I <sub>n</sub> ) and setting on rotary switch									
	I <sub>n</sub> = 60 A	I <sub>r</sub> =	15	20	25	30	35	40	45	50	60	
	I <sub>n</sub> = 100 A	I <sub>r</sub> =	35	40	45	50	60	70	80	90	100	
	I <sub>n</sub> = 150 A	I <sub>r</sub> =	50	60	70	80	90	100	110	125	150	
	I <sub>n</sub> = 250 A	I <sub>r</sub> =	70	80	100	125	150	175	200	225	250	
	I <sub>n</sub> = 400 A	I <sub>r</sub> =	125	150	175	200	225	250	300	350	400	
	I <sub>n</sub> = 600 A	I <sub>r</sub> =	200	225	250	300	350	400	450	500	600	
		Keypad setting	Fine adjustment in 1 A steps below maximum value set on rotary switch									
Time Delay (s) Accuracy 0 to -20%	tr =	Keypad setting	0.5	1	2	4	8	16				
		1.5 x I <sub>r</sub>	15	25	50	100	200	400				
		6 x I <sub>r</sub>	0.5	1	2	4	8	16				
		7.2 x I <sub>r</sub>	0.35	0.7	1.4	2.8	5.5	11				
Thermal memory		20 minutes before and after tripping										

### MicroLogic 5/6 Trip Unit—S Short-Time Protection

Ratings		In at 104°F (40°C) <sup>155</sup>	60 A	100 A	150 A	250 A	400 A	600 A												
Circuit Breaker <sup>156</sup>	H-frame		X	X	X															
	J-frame					X														
	L-frame						X	X												
Pick-up (A) accuracy ± 10%	I <sub>sd</sub>	Keypad setting	1.5	2	2.5	3	3.5	4	4.5	5	5.5	6	6.5	7	7.5	8	8.5	9	9.5	10
			Fine adjustment in 0.5 x I <sub>r</sub> steps using the keypad																	
Time delay	I <sub>sd</sub> =	Key-pad setting	I <sub>2t</sub> Off	0	0.1 s	0.2 s	0.3 s	0.4 s												
			I <sub>2t</sub> On	—	0.1 s	0.2 s	0.3 s	0.4 s												
	Non-tripping time (ms)		20	80	140	200	320	500												
Maximum break time (ms)		80	140	200	320	500														

### MicroLogic 5/6 Trip Unit— Instantaneous

Ratings		In at 104°F (40°C) <sup>155</sup>	60 A	100 A	150 A	250 A	400 A	600 A				
Circuit Breaker <sup>156</sup>	H-frame		X	X	X							
	J-frame					X						
	L-frame						X	X				
Pick-up (A) accuracy ± 15%	I <sub>i</sub> = I <sub>n</sub> x	Rotary Switch	60 A	1.5	2	0.3	4	6	8	10	12	15
			100 A	1.5	2	0.3	4	6	8	10	12	15
			150 A	1.5	2	0.3	4	6	8	10	12	15
			250 A	1.5	2	0.3	4	5	6	8	10	12

155. If the trip units are used in high-temperature environments, the MicroLogic trip unit setting must take into account the thermal limitations of the circuit breaker. See *Temperature Derating*, page 191.

156. Mission Critical trip units have a “-W” at the end of the number (for example 3.2-W). All other protections are the same and have the same trip curves.

**MicroLogic 5/6 Trip Unit— Instantaneous (Continued)**

Ratings		In at 104°F (40°C) <sup>157</sup>		60 A	100 A	150 A	250 A	400 A	600 A			
		400 A		1.5	2	0.3	4	5	6	8	10	12
		600 A		1.5	2	0.3	4	5	6	8	10	11
Non-tripping time Maximum break time				10 ms 50 ms for I > Ii								

**MicroLogic 5/6 Trip Unit—G Ground Fault Protection for MicroLogic 6 A or E Trip Units**

Ratings		In at 104°F (40°C) <sup>157</sup>		60 A	100 A	150 A	250 A	400 A	600 A											
Circuit Breaker <sup>157</sup>	H-frame			X	X	X														
	J-frame						X													
	L-frame								X	X										
Pick-up (A) accuracy ± 10%	Ig	Keypad Setting																		
	In= 60 A	Ig =	0.3	0.35	0.4	0.45	0.5	0.55	0.6	0.65	0.7	0.75	0.8	0.85	0.9	0.95	1			
	In= 100–600 A	Ig =	0.2	2.5	0.3	0.35	0.4	0.45	0.5	0.55	0.6	0.65	0.7	0.75	0.8	0.85	0.9	0.95	1	
Time delay (s)	tg =	Keypad setting	I <sub>2t</sub> Off	0		0.1		0.2		0.3		0.4								
			I <sub>2t</sub> On	—		0.1		0.2		0.3		0.4								
	Non-tripping time Maximum break time			20 80		80 140		140 200		230 320		350 500								
Test	Ig function		Built in																	

157. If the trip units are used in high-temperature environments, the MicroLogic trip unit setting must take into account the thermal limitations of the circuit breaker. See *Temperature Derating*, page 191.

157. Mission Critical trip units have a “-W” at the end of the number (for example 3.2-W). All other protections are the same and have the same trip curves.

## Field-Installable Trip Units

### MicroLogic 3 Field-Installable Trip Units

Circuit Breaker <sup>158</sup>				Trip Unit Type	Catalog No.
Frame	Standard	Poles	Rating		
H-Frame	UL/CSA/NOM	3	60 A	MicroLogic 3.2	HE3060U31X
				MicroLogic 3.2S	HE3060U33X
			100 A	MicroLogic 3.2	HE3100U31X
				MicroLogic 3.2S	HE3100U33X
			150 A	MicroLogic 3.2	HE3150U31X
				MicroLogic 3.2S	HE3150U33X
J-Frame	UL/CSA/NOM	3	250 A	MicroLogic 3.2	JE3250U31X
				MicroLogic 3.2S	JE3250U33X
L-Frame	UL/CSA/NOM	3	250 A	MicroLogic 3.3	LE3250U31X
				MicroLogic 3.3S	LE3250U33X
			400 A	MicroLogic 3.3	LE3400U31X
				MicroLogic 3.3S	LE3400U33X
			600 A	MicroLogic 3.3	LE3600U31X
				MicroLogic 3.3S	LE3600U33X
		4	250 A	MicroLogic 3.3	LE4250U31X
				MicroLogic 3.3S	LE4250U33X
			400 A	MicroLogic 3.3	LE4400U31X
				MicroLogic 3.3S	LE4400U33X
			600 A	MicroLogic 3.3	LE4600U31X
				MicroLogic 3.3S	LE4600U33X

### MicroLogic 5 and 6 Field-Installable Trip Units

Circuit Breaker <sup>158</sup>				Trip Unit Type	Catalog No.
Frame	Standard	Poles	Rating		
H-Frame	UL/CSA/NOM	3	60 A	MicroLogic 5.2 A	HE3060U43X
				MicroLogic 6.2 A	HE3060U44X
				MicroLogic 5.2 E	HE3060U53X
				MicroLogic 6.2 E	HE3060U54X
			100 A	MicroLogic 5.2 A	HE3060U43X
				MicroLogic 6.2 A	HE3100U44X
				MicroLogic 5.2 E	HE3100U53X
				MicroLogic 6.2 E	HE3100U54X
			150 A	MicroLogic 5.2 A	HE3150U43X
				MicroLogic 6.2 A	HE3150U44X
				MicroLogic 5.2 E	HE3150U53X
				MicroLogic 6.2 E	HE3150U54X
J-Frame	UL/CSA/NOM	3	250 A	MicroLogic 5.2 A	JE3250U43X

158. Mission Critical trip units that end in "W" are factory sealed and are not available as field installable units.



**MicroLogic 5 and 6 Field-Installable Trip Units (Continued)**

Circuit Breaker <sup>159</sup>				Trip Unit Type	Catalog No.
Frame	Standard	Poles	Rating		
L-Frame				MicroLogic 6.2 A	JE3250U44X
				MicroLogic 5.2 E	JE3250U53X
				MicroLogic 6.2 E	JE3250U54X
	UL/CSA/NOM	3	400 A	MicroLogic 5.3 A	LE3400U43X
				MicroLogic 6.3 A	LE3400U44X
				MicroLogic 5.3 E	LE3400U53X
				MicroLogic 6.3 E	LE3400U54X
			600 A	MicroLogic 5.3 A	LE3600U43X
				MicroLogic 6.3 A	LE3600U44X
				MicroLogic 5.3 E	LE3600U53X
				MicroLogic 6.3 E	LE3600U54X
	UL/CSA/NOM	4	400 A	MicroLogic 5.3 A	LE4400U43X
				MicroLogic 6.3 A	LE4400U44X
				MicroLogic 5.3 E	LE4400U53X
				MicroLogic 6.3 E	LE4400U54X
			600 A	MicroLogic 5.3 A	LE4600U43X
MicroLogic 6.3 A				LE4600U44X	
MicroLogic 5.3 E				LE4600U53X	
MicroLogic 6.3 E				LE4600U54X	

159. Mission Critical trip units that end in "W" are factory sealed and are not available as field installable units.

## MicroLogic Trip Unit Spare Parts

### Spare Parts

Description	Frame	Trip Unit	Catalog No.
LCD Display	H/J/L	MicroLogic 5	S429483
		MicroLogic 6	S429484
Trip Unit Cover-Transparent	H/J	MicroLogic 3	S429481
	L		S432461
	H/J	MicroLogic 5/6	S429478
	L		S432459
Trip Unit Wire Seal	H	MicroLogic 3/5/6	MICROTUSEAL

# Smart System Communication Wiring System

## Wiring System ULP

The wiring system is designed for low-voltage power switchboards. Installation does not require special tools or training. The prefabricated wiring ensures both data transmission (Modbus protocol) and 24 Vdc power distribution for the communications modules on the MicroLogic trip units.

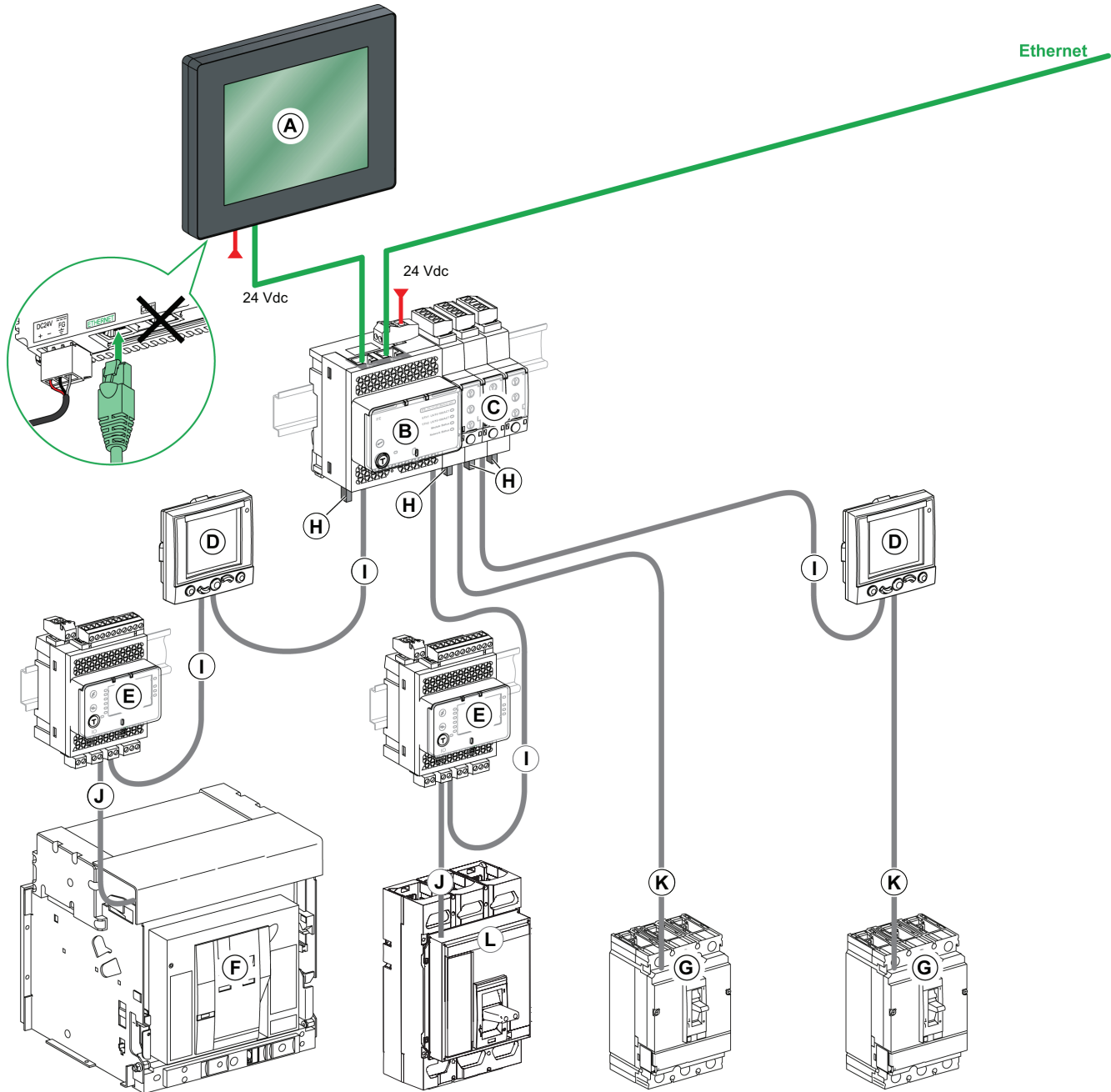

- A. FDM128 display for 8 LV devices
- B. IFE Ethernet interface for LV circuit breaker and gateway
- C. IFM Modbus-SL interface for LV circuit breaker
- D. FDM121 display for LV circuit breaker
- E. IO input/output interface module for LV circuit breaker
- F. MasterPact NT/NW circuit breaker

- G. PowerPact H-, J-, or L-frame circuit breaker
- H. ULP line terminator
- I. ULP cable
- J. Breaker ULP cord
- K. NSX cord
- L. PowerPact P/R or ComPact NS



F ComPacT NSX/PowerPacT H-, J-, L-Frame

## Four Functional Levels

All PowerPacT H-, J-, and L-frame circuit breakers devices can be equipped with the communication function using a pre-wired connection system and a Modbus communication interface module. The interface module can be connected directly or through the front display module (FDM121).

The PowerPacT H-, J-, and L-frame circuit breakers can be integrated in a Modbus communication network. Four functional levels can be used separately or combined to adapt to all supervision requirements.

Level	Function
Communication of status indications	Compatible with PowerPacT H-, J- and L-frame circuit breakers and automatic switches. Use the BSCM module to access the following information: <ul style="list-style-type: none"> <li>• ON/OFF position</li> <li>• trip indication</li> <li>• fault-trip indication</li> </ul>
Communication of commands	Available on all circuit breakers and automatic switches with communicating motor operators, the remote control can be used to: <ul style="list-style-type: none"> <li>• open</li> <li>• closed</li> <li>• reset</li> </ul>
Communication of measurements with MicroLogic 5/6 A or E trip unit	This level provides access to: <ul style="list-style-type: none"> <li>• instantaneous and demand values</li> <li>• maximums/minimums</li> <li>• energy metering</li> <li>• demand current and power</li> <li>• power quality</li> </ul>
Communication of operating assistance with MicroLogic 5/6 A or E trip unit	This level also provides access to: <ul style="list-style-type: none"> <li>• protection and alarm settings</li> <li>• time-stamped histories and event tables</li> <li>• maintenance indicators</li> </ul>

## Modbus Principle

The Modbus RS 485 (RTU protocol) system is an open bus on which communicating Modbus devices (PowerPacT and MasterPacT circuit breakers, Power Meter PM700, PM800, etc.) are installed. All types of PLCs and microcomputers may be connected to the bus.

## Number of Devices

The maximum number of devices that may be connected to the Modbus bus depends on the type of device (PowerPacT circuit breaker with Modbus COM, PM700, PM800, MasterPacT circuit breaker, etc.), the baud rate (19200 is recommended), the volume of data exchanged and the desired response time. The RS 485 physical layer offers up to thirty-two connection points on the bus (one client, thirty-one servers).

## Length of Bus

The maximum recommended length for the Modbus bus is 3940 feet (1200 meters).

## Bus Power Source

A 24 Vdc power supply is required (less than 20% ripple, insulation class II).

## Ethernet Principle

Ethernet is a data link and physical layer protocol defined by IEEE 802.10 and 100 Mbps specifications that connects computer or other Ethernet devices. Ethernet is an asynchronous Carrier Sense Multiple Access with Collision detection (referred as CSMA/CD) protocol. Carrier Sense means that the hosts can detect whether the medium (coaxial cable) is idle or busy.

Multiple Access means that multiple hosts can be connected to the common medium. Collision Detection means a host detects whether its transmission has collided with the transmission of another host (or hosts).

IFE Ethernet interface can be connected to a PC or a laptop over Ethernet. The maximum length of Ethernet cable is 325 feet (100 meters). IFE Ethernet interface + gateway provides a Modbus TCP/IP gateway over Ethernet to enable Modbus TCP communication from a Modbus TCP client to any Modbus server devices connected to it. The maximum number of active TCP client connections is twelve.

IFE Ethernet interface has an embedded web server (web page).

# IFE Ethernet Interface

## IFE Interface, IFE Interface + Gateway Description

IFE Interface



IFE Interface + Gateway



### Introduction

The IFE interface and IFE interface + gateway enable low-voltage circuit breakers such as MasterPacT and PowerPacT to be connected to an Ethernet network.

### IFE Interface

Provides Ethernet access to a single low-voltage circuit breaker.

Function: Interface - one circuit breaker is connected to the IFE interface using its ULP port.

### IFE Interface + Gateway

Provides Ethernet access to one or several low-voltage circuit breakers.

Functions:

- Interface - one circuit breaker is connected to the IFE interface using its ULP port.
- Gateway: several circuit breakers on a Modbus network are connected using the IFE interface + gateway client Modbus port.

### IFE Interface, IFE Interface + Gateway Features

- Dual 10/100 Mbps Ethernet port for simple daisy chain connection.
- Device profile web service for discovery of the IFE interface, IFE interface + gateway on the LAN.
- Ethernet interface for MasterPacT and PowerPacT circuit breakers.
- Gateway for Modbus-SL connected devices (IFE interface + gateway only).
- Embedded set-up web pages.
- Embedded monitoring web pages.
- Embedded control web pages.
- Built-in e-mail alarm notification.

### IFE Interface, IFE Interface + Gateway Screen

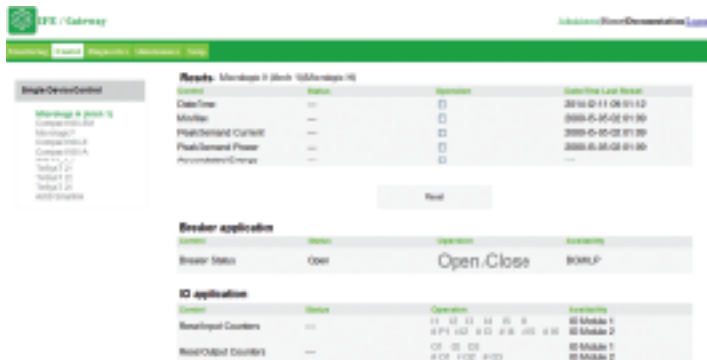

## Mounting

The IFE interface and IFE interface + gateway are DIN rail mounting devices. A stacking accessory enables the user to connect several IFMs (ULP to Modbus interfaces) to an IFE interface + gateway without additional wiring.

## 24 Vdc Power Supply

The IFE interface and the IFE interface + gateway must always be supplied with 24 Vdc.

The IFMs stacked to an IFE interface + gateway have power supplied by the IFE interface + gateway, thus it is not necessary to supply them separately. It is recommended to use a UL listed and recognized limited voltage/limited current or a class 2 power supply with a 24 Vdc, 3 A maximum.

## Required Circuit Breaker Communication Modules

The connection to an IFE interface or IFE interface + gateway requires a communication module embedded into the circuit breaker:

- PowerPacT and ComPacT (fixed or drawout) circuit breakers: BSCM communication module
- Drawout PowerPacT and ComPacT circuit breakers: BSCM and its respective I/O (Input/Output) application module.

All connection configurations for PowerPacT and ComPacT circuit breakers require the circuit breaker ULP cord. The insulated NSX cord is mandatory for system voltages greater than 480 Vac. When the second ULP RJ45 connector is not used, it must be closed with a ULP terminator (TRV00880).

### Network Communication Interface

Characteristic		Value
Type of interface module		Modbus RTU, RS485 serial connection Modbus TCP/IP Ethernet
Transmission	Modbus RS485	<ul style="list-style-type: none"> <li>• Transfer rate: 9,600–19,200 Baud</li> <li>• Medium Double shielded twisted pair</li> <li>• Impedance 120 Ω</li> </ul>
	Ethernet	Transfer rate: 10/100 Mbps Medium STP, Cat5e, straight cable
Structure	Type	Modbus, Ethernet
	Method	Client/Server
Device type	Modbus	Client
	Ethernet	Server
Turnaround time	Modbus	10 ms
	Ethernet	1 ms
Maximum length of cable	Modbus	1000 m
	Ethernet	100 m
Type of bus connector	Modbus	4-pin connector
	Ethernet	RJ45 (Shielded)

### IFE Ethernet Interface Characteristics—Web Page Description

Monitoring Web Page	
Real time data	X
Device logging	X
Control Web Page	
Single device control	X
Diagnostics Web Page	



**IFE Ethernet Interface Characteristics—Web Page Description (Continued)**

Statistics	X
Device information	X
IMU (circuit breaker) information	X
Read device registers	X
Communication check	X
<b>Maintenance Web Page</b>	
Maintenance log	X
Maintenance counters	X
<b>Setup Web Page</b>	
Device localization/name	X
Ethernet configuration (dual port)	X
IP configuration	X
Modbus TCP/IP filtering	X
Serial port	X
Date and time	X
E-mail server configuration	X
Alarms to be e-mailed	X
Device list	X
Device logging	X
Device log export	X
SNMP parameters	X
Documentation links	X
Preferences	X
Advanced services control	X
User accounts	X

**IFE Ethernet Interface—General Characteristics**

<b>Environmental Characteristics</b>	
Conforming to standards	UL 508, UL 60950, IEC 60950, 60947-6-2
Certification	cUIUs, FCC, CE
Ambient temperature	Storage: -40 to +185°F (-40 to +85°C) Operation: -13 to +158°F (-25 to +70°C)
Protective treatment	ULVO, conforming to IEC 60068-2-30
Pollution	Level 3
<b>Mechanical Characteristics</b>	
Shock resistance	Conforming to IEC 60068-2-27 15g/11ms, 1/2 sinusoidal
Resistance to sinusoidal vibrations	Conforming to IEC 60068-2-6
<b>Electrical Characteristics</b>	
Power supply	24 Vdc, -20%/+10% (19.2 to 26.4 Vdc)
Consumption	Typical: 4 Vdc, 120 mA at 68°F (20°C) Maximum with gateway: 26.4 Vdc, 3 A at 140°F (60°C)
<b>Physical Characteristics</b>	
Dimensions	2.83 x 4.13 x 2.79 in. (72 x 105 x 71 mm)
Mounting	Mounting DIN rail

### IFE Ethernet Interface—General Characteristics (Continued)

Weight	182.5 g (0.41 lb)
Degree of protection of the installed module	On the front panel (wall mounted enclosure): IP4x Connectors: IP2x Other parts: IP3x
Connections	Screw type terminal blocks
Technical Characteristics - 24 Vdc Power Supply	
Power supply type	Regulated switch type
Rated power	72 W
Input voltage	100–120 Vac for single phase 200–500 Vac phase-to-phase
PFC filter	With IEC 61000-3-2
Output voltage	24 Vdc
Power supply out current	3:00 AM

### IFE Ethernet Interface Characteristics

**NOTE:** Use a UL Listed/UL Recognized limited voltage/limited current or a Class 2 power supply with a 24 Vdc, 3 A maximum.

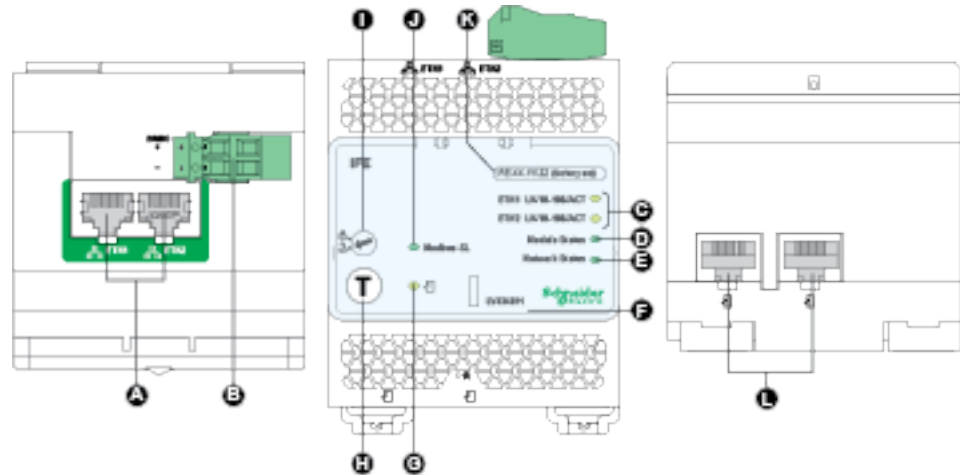

A. Ethernet 1 and Ethernet 2 communication port

B. 24 Vdc power supply terminal block

C. Ethernet communication LEDs:

- yellow: 10 Mb
- green: 100 Mb

D. Module status LED:

- steady off: no power
- steady green: device operational
- steady red: major fault
- flashing green: standby
- flashing red: minor fault
- flashing green/red: self-test

E. Network status LED:

- steady power off: no power/no valid IP address
- steady green: connected, valid IP address
- steady orange: default IP address Z
- steady red: duplicated IP address
- flashing green/red: self-test

F. Sealable transparent cover

G. ULP status LED

H. Test button (accessible closed cover)

I. Locking pad

J. Modbus traffic status LED (IFE Interface + Gateway only)

K. Device name label

L. ULP ports

# IFM Modbus Communication Interface

## Function



IFM Modbus  
Communication Interface.  
Ref.: TRV00210

An IFM Modbus communication interface is required for connection of a MasterPacT or PowerPacT circuit breaker to a Modbus network as long as this circuit breaker is provided with a ULP (Universal Logic Plug) port. The port is available on the BSCM.

Once connected, the circuit breaker is considered as a server by the Modbus client. Its electrical values, alarm status, open/close signals can be monitored or controlled by a Programmable Logic Controller or any other system.

## Characteristics

### ULP Port

Two RJ45 sockets, internal parallel wiring.

- Connection of a single circuit breaker.
- A ULP line terminator or an FDM121 display unit must be connected to the second RJ45 ULP socket.
- The RJ45 sockets deliver a 24 Vdc supply fed from the Modbus socket.
- Built-in test function, for checking the correct connection to the circuit breaker and FDM121 display unit.

### Modbus Server Port

- Top socket for screw-clamp connector, providing terminals for:
  - 24 Vdc input supply (0 V, +24 V)
  - Modbus line (D1, D2, Gnd) 2-wire Modbus system.
- Lateral socket, for DIN-rail stackable connector. Both top and lateral sockets are internally parallel wired.
- Multiple IFMs can be stacked, thus sharing a common power supply and Modbus line without individual wiring.
- On the front face:
  - Modbus address setting (1 to 99): 2 coded rotary switches
  - Modbus locking pad: enables or disable the circuit breaker remote control and modification of IFM parameters.
- Self-adjusting communication format (Baud rate, parity).

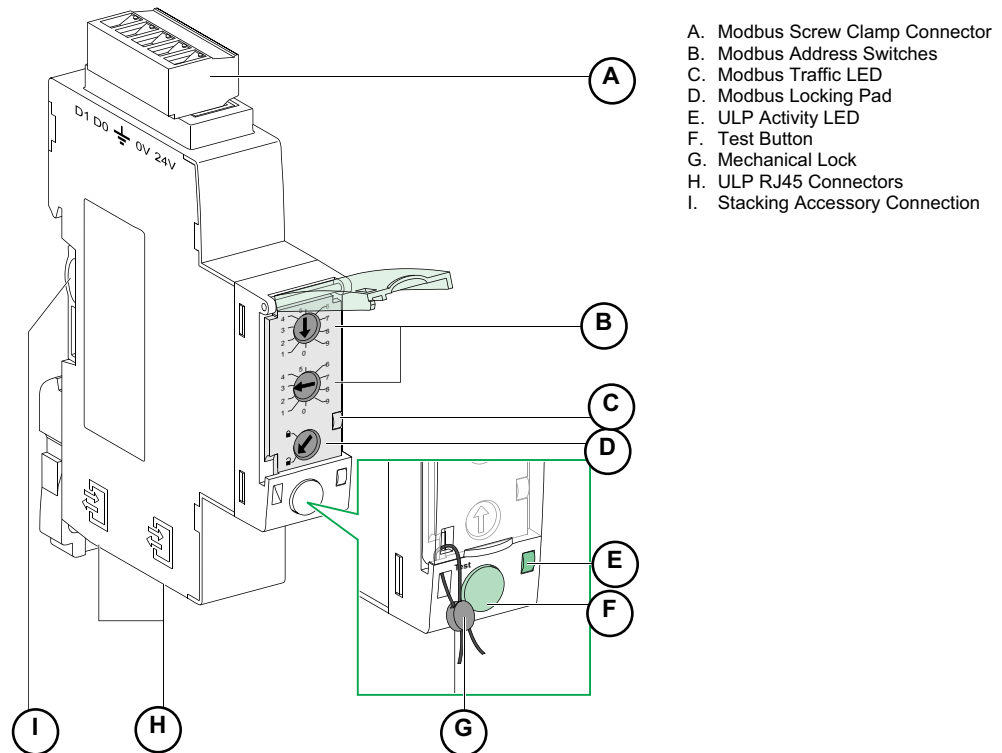

## Technical Characteristics

### IFM Modbus Communication Interface

Dimensions		0.71 x 2.83 x 3.78 in. (18 x 72 x 96 mm)
Maximum number of stacked IFM		12
Degree of protection of the installed module	Part projecting beyond the escutcheon	IP4x
	Other module parts	IP3x
	Connectors	IP2x
Operating temperature		-13 to 158°F (-25 to +70°C)
Power supply voltage		24 Vdc -20%/+10% (19.2–26.4 Vdc)
Consumption	Typical	21 mA/24 Vdc at 68°F (20°C)
	Maximum	30 mA/19.2 Vdc at 140°F (60°C)
Certification	CE	IEC/EN 60947-1
	UL	UL 508 - Industrial Control Equipment
	CSA	No. 142-M1987 - Process Control Equipment <ul style="list-style-type: none"> <li>CAN/CSA C22.2 No. 0-M91 - General requirements - Canadian Electrical Code Part</li> <li>CAN/CSA C22.2 No. 14-05 - Industrial Control Equipment</li> </ul>

# Simplified IFM Installation

## Stacking an IFM

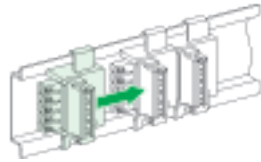

Stacking Accessories

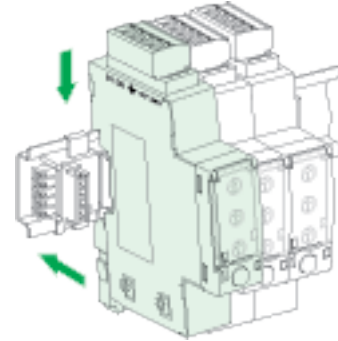

Up to Twelve Stacked IFMs

## Stacking an IFE Interface + Gateway with IFMs

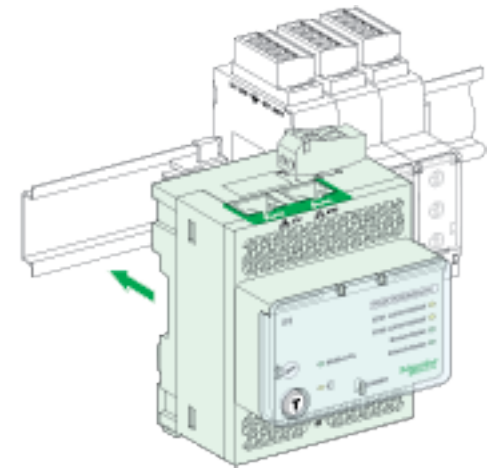
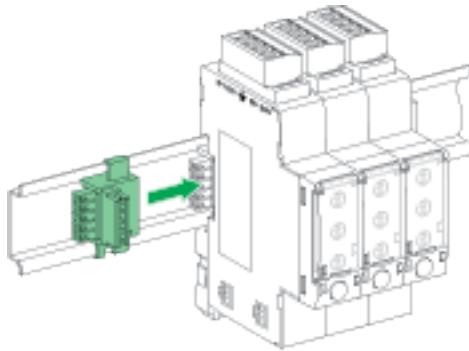

# I/O Application Module

## Description



I/O Application Module

The I/O (Input/Output) application module for a low-voltage circuit breaker is part of an ULP system with built-in functions and applications to enhance the application needs. The ULP system architecture can be built without any restrictions using the wide range of circuit breakers.

The I/O application module is compliant with the ULP system specifications.

Two I/O application modules can be connected in the same ULP network.

The ranges of low-voltage circuit breakers enhanced by the I/O application module are:

- MasterPacT NW
- MasterPacT NT
- PowerPacT R-Frame
- PowerPacT P-Frame
- PowerPacT H-Frame
- PowerPacT J-Frame
- PowerPacT L-Frame

## I/O (Input/Output) Application Module for Low-Voltage Circuit Breaker

The I/O application module resources are:

- Six digital inputs that are self powered for either NO and NC dry contact or pulse counter.
- Three digital outputs that are a bistable relay (5 A maximum).
- One analog input for PT100 temperature sensor.

## Pre-Defined Application

The pre-defined application adds new functions to the I/O application module by:

- Selection by the application rotary switch on the I/O application module, defining the application with pre-defined input/output assignment and wiring diagram.
- No additional setting with the customer engineering tool required.

The resources not assigned to the pre-defined application are free for additional user-defined applications:

- cradle management
- circuit breaker operation
- cradle management + ERMS (Energy Reduction Maintenance Setting)

**NOTE:** Use only MicroLogic P or H trip units with the blue ERMS label for energy reduction maintenance setting systems. Review the I/O module user guide 0613IB1317 and ERMS installation instructions NHA37346 for details on installation, testing, and operation of the ERMS system.

- light and load control

- custom

## User-Defined Applications

User-defined applications are processed by the I/O application module in addition to the pre-defined application selected.

The user-defined applications are available depending on:

- the pre-defined application selected
- the I/O application module resources (inputs and outputs) not used by the application.

The resources required by user-defined applications are assigned using the customer engineering tool:

- protection
- control
- energy management
- monitoring.

## Mounting

The I/O application module is a DIN rail mounted device. Install on a steel DIN rail that is properly grounded near the device.

## Application Rotary Switch

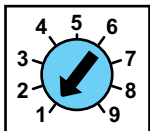

The application rotary switch enables the selection of the pre-defined application. It has nine positions and each position is assigned to a pre-defined application. The factory set position of the switch is pre-defined application one.

## Setting Locking Pad

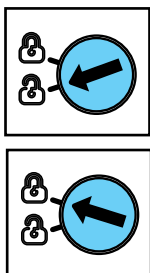

The setting locking pad on the front panel of the I/O application module enables the setting of the I/O application module by the customer engineering tool.



# I/O Module Characteristics

## I/O Module Characteristics

	<b>General Characteristics</b>		
	Environmental Characteristics	Conforming to standards	UL 508, UL 60950, IED 60950, 60947-6-2
		Certification	cULus, EAC, FCC, CE
		Ambient temperature	Storage: -40 to +185°F (-40 to +85°C) Operation: -13 to +158°F (-25 to +70°C)
		Protective Treatment	ULVO, conforming to IEC 60068-2-30
		Pollution	Level 3
	Mechanical Characteristics	Shock resistance	Conforming to IEC 60068-2-27 15g/11ms, 1/2 sinusoidal
		Resistance to sinusoidal vibrations	Conforming to IEC 60068-2-6
	Electrical Characteristics	Power Supply	24 Vdc, -20%/+10% (19.2 to 26.4 Vdc)
		Consumption	Typical: 24 Vdc, 165 mA at 20°C Maximum with gateway: 26.4 Vdc, 420 mA at 60°C
Physical Characteristics	Dimensions	2.83 x 4.52 X 2.79 in. (72 x 115 x 71 mm)	
	Mounting	DIN rail	
	Weight	0.51 lb. (229.5 g)	
	Degree of protection of the installed I/O application module	On the front panel (wall mounted enclosure): IP4x I/O parts: IP3x Connectors: IP2x	
	Connections	Screw type terminal blocks	
Technical Characteristics 24 Vdc power supply (A)	Power supply type	Regulated switch type	
	Rated power	72 W	
	Input voltage	100–120 Vac for single phase 200–500 Vac phase-to-phase maximum	
	PFC filter	With IEC 61000-3-2	
	Output voltage	24 Vdc	
	Power supply out current	3 A	
	<b>NOTE:</b> It is recommended to use a UL Listed / UL Recognized limited voltage / limited current or a class 2 power supply with a 24 Vdc, 3 A maximum.		
<p>A. 24 Vdc power supply terminal block</p> <p>B. Digital input terminal block:</p> <ul style="list-style-type: none"> <li>• 6 inputs, 3 commons and 1 shield</li> </ul> <p>C. 6 input status LEDs</p> <p>D. Analog input status LED</p> <p>E. 3 output status LEDs</p> <p>F. I/O application module identification labels</p> <p>G. Sealable transparent cover</p> <p>H. Analog input terminal block</p> <p>I. Digital output terminal blocks</p> <p>J. ULP status LED</p> <p>K. Test/reset button (accessible with cover closed)</p> <p>L. Setting locking pad.</p> <p>M. Application rotary switch: 1 to 9</p>	Digital Inputs (B) 6 inputs, 3 commons and 1 shield.	Digital input type	Self powered digital input with current limitations as per IEC 61131-2 type 2 standards (7 mA)
		Input limit values at state 1 (close)	19.8–25.2 Vdc, 6.1–8.8 mA
		Input limit values at state 0 (open)	0–19.8 Vdc, 0 mA
		Maximum cable length	33 ft (10 m)
	<b>NOTE:</b> For a length greater than 10 m (33 ft) and up to 300 m (1,000 ft), it is mandatory to use a shielded twisted cable. The shield cable is connected to the I/O functional ground of the I/O application module.		
Digital Outputs	Digital output type	Bistable relay	
	Rated load	5 A at 250 Vac	

**I/O Module Characteristics (Continued)**

N. Switch for I/O addressing (IO 1 or IO 2) O. ULP connectors		Rated carry current	5 A
		Maximum switching voltage	380 Vac, 125 Vdc
		Maximum switch current	5 A
		Maximum switching power	1250 VA, 150 W
		Minimum permissible load	10 mA at 5 Vdc
		Contact resistance	30 mΩ
		Maximum operating frequency	1800 operations/hr (Mechanical) 1800 operations/hr (Electrical)
		Digital output relay protection by an external fuse	External fuse of 5 A or less
		Maximum cable length	10 m (33 ft)
	Analog Inputs	The I/O application module analog input can be connected to a Pt100 temperature sensor	
		Range	-22 to 392°F (-30 to 200°C)
		Accuracy	-22 to 68°F (-30 to 20°C): ±3.6°F (2°C) 68 to 284°F (20 to 140°C): ±1.8°F (1°C) 284 to 392°F (140 to 200°C): ±3.6°F (2°C)
		Refresh interval	5 s

# EcoStruxure™ Power Commission Software

## Introduction

EcoStruxure Power Commission is an intuitive, feature-rich tool that can help electrical professionals more effectively and efficiently setup, test and report, commission, and maintain MV/LV circuit breakers and digital switchboards. EcoStruxure Power Commission helps you avoid errors and rework while simplifying your workload. Intuitive, browser-based, you can become proficient with it quickly.

## Compatible Devices (Configuration and Device Management)

The software is compatible with a wide range of devices including:

### Low Voltage Circuit Breakers:

- ComPacT NSX/NSXm
- MasterPacT NT/NW
- MasterPacT MTZ (IEC and UL)
- PowerPacT
- TeSys GV4PB
- TeSys GV4PEM

### Medium Voltage Circuit Breakers

- BM100
- PTM100
- EvoPacT

Download the software from our website: [EcoStruxure Power Commission](https://www.se.com/us/en/product-range/62980-ecostruxure-power-commission/#overview)

<https://www.se.com/us/en/product-range/62980-ecostruxure-power-commission/#overview>

## Features

Most of EPC's features are free to use. The tool provides even more value with the Circuit Breaker Advanced Testing or Switchboard Advanced Commissioning Efficiency modules, which are both accessible through a paid subscription.

With EcoStruxure Power Commission, users can:

- Discover all connected devices in the electrical panel.
- Confirm electrical settings and upgrade firmware for power meters and gateways.
- Test the communication wiring, troubleshoot issues, and generate reports as part of the Factory Acceptance Tests (FAT) or Site Acceptance Tests (SAT).
- Use batch operations feature to speed up settings configuration for several devices at the same time (in-app purchase).
- Discover all circuit breakers in the electrical panel.
- Confirm electrical settings and upgrade firmware for all LV circuit breakers.
- Test and report on low-voltage circuit breakers and their trip curve behavior during installation and maintenance and generate a report (in-app purchase).
- Routine checks.
- Secondary injection testing.

- Preparation for primary injection testing.
- Zone selective interlocking testing.
- Create unique QR codes that identify each switchboard and its installed assets, which enables traceability for product upgrades, recalls, inventory audits, etc.
- Provide digitized project documentation for your customers retrievable via the switchboard QR code for fast, efficient, and paperless project handover and reference.

# Accessories for MicroLogic Trip Units

## NSX Cord

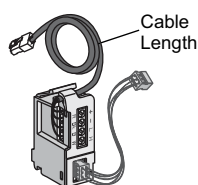

NSX Cord,  
V ≤ 480 V

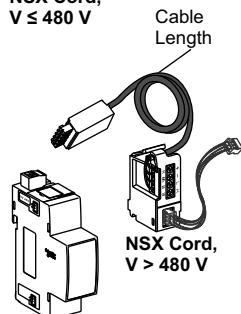

NSX Cord,  
V > 480 V

Isolation Module  
for NSX Cord  
with V > 480 V

MicroLogic trip units are connected to the Modbus communication interface module (IFM) or front display module through the internal terminal block for the NSX cord equipped with an RJ45 connector.

The NSX cord is available in two cable lengths:

- 4.27 ft. (1.3 m)
- 9.84 ft. (3 m)

Lengths up to 32.8 ft. (10 m) are possible using extensions.

- For voltage  $V \leq 480$  V, available in 3 prefabricated lengths: 0.35 m, 1.3 m and 3 m.
- For voltages  $V > 480$  V, a special 1.3 m cable with an insulation accessory is required.
- A set of cables with RJ45 connectors is available to adapt to different distances between devices.

### NSX Cord Catalog Numbers

Description	Catalog No.
NSX Cord 4.27 ft. (1.3 m), $V \leq 480$ V	S434201
NSX Cord 9.84 ft. (3 m), $V \leq 480$ V	S434202
NSX Cord 4.27 ft. (1.3 m), $V > 480$ V	S434204
NSX Cord 9.84 ft. (3 m), $V > 480$ V	S434303

### Modbus Serial Cord Catalog Numbers

Description	Catalog No.
Modbus SL Cord 3.0m for $V \leq 480$ Vac <sup>159</sup>	S434223
Modbus SL Cord 1.3m for $V \leq 480$ Vac <sup>159</sup>	S434222
Modbus SL Cord 0.35m for $V \leq 480$ Vac <sup>159</sup>	S434221

## Breaker Status and Control Module (BSCM) Modbus SL or ULP

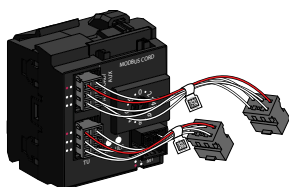

### Functions

The optional BSCM Breaker Status & Control Module is used to acquire device status indications and control the communicating remote-control function. It includes a memory used to manage the maintenance indicators.

### Status indications

Indication of device status:

Auxiliary switch (OF), alarm switch (SD), and overcurrent trip switch (SDE).

### Maintenance indicators

159. Modbus serial only  $\leq 480$  Vac. Use only with matching Modbus serial components.

The BSCM manages the following indicators:

- mechanical operation counter
- electrical operation counter
- history of status indications.

It is possible to assign an alarm to the operation counters.

### Controls

The BSCM can be used to carry out communicating remote control operations using the communicating motor operator (open, close and reset) in different modes (manual, auto).

### Mounting

The BSCM can be installed on all PowerPacT H-, J-, and L-frame circuit breakers and automatic switches with MicroLogic trip units. It simply clips into the auxiliary contact slots. It occupies the slots of one auxiliary switch (OF) and one overcurrent trip switch (SDE). The BSCM is supplied with 24 Vdc power automatically through the NSX or Modbus Serial Cord when the communication network is installed.

### BSCM Catalog Numbers

Description	Catalog No. <sup>160</sup>
Replacement BSCM for Modbus SL or ULP	S434220
BSCM with NSX ULP Cord 1.3m V ≤ 480 Vac	S434201BX
BSCM with NSX ULP Cord 3.0m V ≤ 480 Vac	S434202BX
BSCM with NSX ULP Cord 1.3m V > 480 Vac	S434204BX
BSCM with NSX ULP Cord 3.0m V > 480 Vac	S434303BX
BSCM with MB SL Cord 3.0m for V ≤ 480 Vac <sup>161</sup>	S434223BX
BSCM with MB SL Cord 1.3m for V ≤ 480 Vac <sup>161</sup>	S434222BX
BSCM with MB SL Cord 0.35m for V ≤ 480 Vac <sup>161</sup>	S434221BX

## Modbus Serial Hub

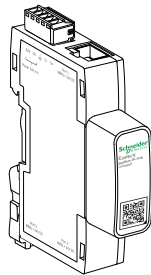

The Modbus Serial Hub is an optional wiring aid for daisy chaining up to four Modbus Serial devices using RJ45 connectors, wired terminal block connection and/or a compatible stacking connector (TRV00217). The Modbus Serial Hub can support direct wiring of up to three breakers using the BSCM (S434220) with MB SL Cords<sup>162</sup>. The Modbus Serial Hub is DIN Rail mountable and stackable with IFMs (LV434000)

160. BSCM legacy CR# S434205 is for ULP architectures using NSX cords only. BSCM Modbus SL/ULP CR# S434220 is compatible with NSX cords or Modbus SL Cords.

161. Modbus serial only ≤ 480 Vac. Use only with matching Modbus serial components.

162. Modbus serial only ≤ 480Vac. Use only with matching Modbus serial components.

and IFEs (LV434001 / LV434002) to use in mixed communication architectures. Multiple Modbus Serial Hubs can be used together to further expand communications with additional stacking connectors or wired through the terminal block.

Description	Catalog No.
Modbus SL Hub <sup>163</sup>	S434224

## 24 Vdc Power Supply Terminal Block

The MicroLogic 5/6 trip unit display is operational when current is flowing through the circuit breaker. To power the MicroLogic 5/6 trip unit when the trip unit is not connected to an FDM121 or to the communication network, a 24 Vdc power-supply terminal block can be installed only on MicroLogic 5/6 trip units. When used, it excludes connection of an NSX cord.

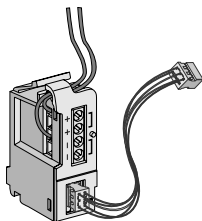

24 Vdc Terminal Block

### 24 Vdc Catalog Number

Description	Catalog No.
24 Vdc Terminal Block Unit Mount	S434210

## External 24 Vdc Power Supply Module

An external 24 Vdc power supply is required for installation in a communication network, whatever the type of trip unit.

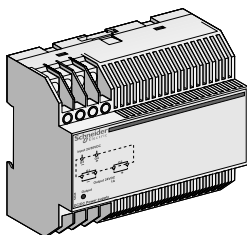

External 24 Vdc Power-Supply Module

On installations without a communication network, the power supply is available as an option for MicroLogic 5/6 trip units in order to:

- modify settings when the circuit breaker is open
- display measurements when the current flowing through the circuit breaker is low (15 to 50 A depending on the rating)
- maintain the display of the cause of tripping and interrupted current.

A single external 24 Vdc supply may be used for the entire network, depending on the number of devices in the communication network. The required characteristics are:

- output voltage: 24 Vdc  $\pm$  5%
- ripple:  $\pm$  1%

### Available External Power-Supply Modules (1 A)

Available External Power-Supply Modules		Input Voltage	Output Power	Catalog No.
Power supply	Vdc ( $\pm$ 5%)	24–30	24 Vdc 1 A	685823
		48–60		685824
		100–125		685825
	Vac (+10%, -15%)	110–130		685826
		200–240		685827
		380–415		685829

163. Modbus serial only  $\leq$  480Vac. Use only with matching Modbus serial components.

To determine the required output current of the 24 Vdc power supply, it is necessary to sum up the currents consumed by the different loads supplied.

### Power Requirements

Module	Typical Consumption 24 Vdc at 68°F (20°C)	Maximum Consumption 19.2 Vdc at 140°F (60°C)
MicroLogic 5/6 trip units	30 mA	55 mA
BSCM Legacy (S434205)	9 mA	15 mA
BSCM Modbus SL/ULP (S434220)	30 mA	45 mA
Modbus Hub	3 mA	5 mA
FDM121	21 mA	30 mA
IFM	21 mA	30 mA
Isolated Modbus Repeater Module	15 mA	19 mA

For installation recommendations, see 24 Vdc Power Supply Terminal Block, page 137.

## Battery Module



Battery Module

The battery module is a back-up supply for the external power-supply module. The input/output voltages are 24 Vdc and it can supply power for approximately three hours (100 mA).

### Battery Module

Description	Catalog No.
Battery Module	685831

## Pocket Tester



Pocket Tester

The pocket tester connects to the MicroLogic trip unit test connector. It powers up the MicroLogic trip unit and the Ready LED. It supplies the screen, allows settings to be made using the keypad, and provides thermal imaging inhibit functions.

The pocket tester runs off of two Alkaline AA batteries.

### Pocket Tester Catalog Number

Description	Catalog No.
Pocket Tester	S434206



## Isolated Modbus Repeater Module

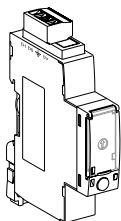

Isolated Modbus Repeater Module

Since Modbus interface modules (part number STRV00210) are not isolated, an isolated Modbus Repeater Module needs to be inserted between the Modbus network inside the equipment and the Modbus network outside the equipment.

### Isolated Modbus Repeater Module

Description	Catalog No.
Isolated Modbus Repeater Module	STRV00211

## Service Interface (SI)

The SI (LV485500) is a portable instrument designed for field testing and configuration of MicroLogic™ trip units mounted in PowerPacT™ H-, J-, and L-frame circuit breakers. The user interface, EcoStruxure™ Power Commission (EPC), is a global software with test functions and features for testing the circuit breakers and communication accessories through the Service Interface.

### Service Interface (SI) Catalog Numbers

Description	Catalog No.
Service Interface Kit	LV485500
Service Interface module	LV485510SP
AC/DC power	LV485511SP
7-pin cable for 630–6300 A ACB MCCB trip units	LV485512SP
7-pin cable for 100–630 A MCCB trip units	LV485513SP
ULP cable	LV485514SP
USB cable with magnet	LV485517SP
24 Vdc power output connector Dinkle	EC350V-2P
Phoenix Contact	1840366

Specific test functions and compatibility, by the circuit breaker, can be found in the SI user guide (DOCA0170EN-04).

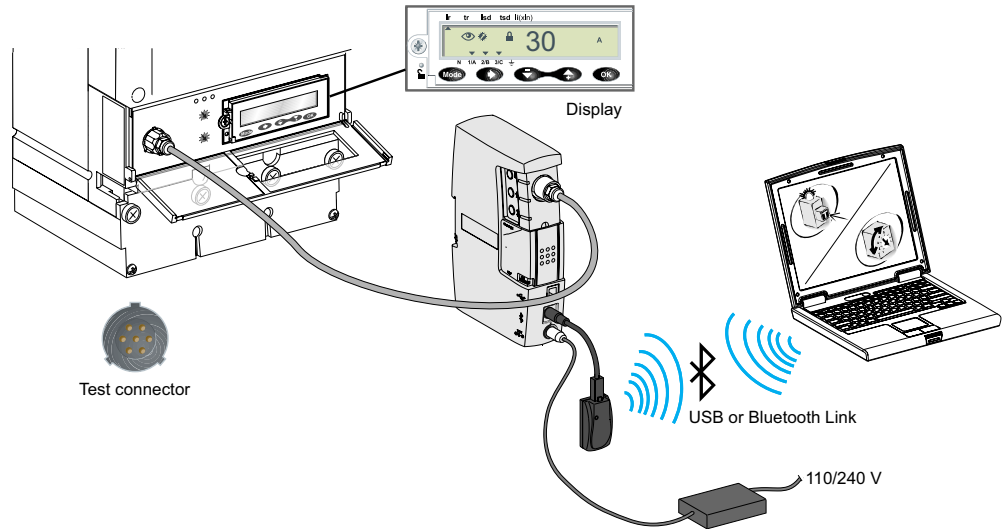

## Universal Logic Plug



ULP Symbol

The Universal Logic Plug (ULP) system allows the PowerPacT H-, J- and L-frame circuit breakers to become metering and supervision tools to assist for energy efficiency. For easy connection of the different modules, the prefabricated cables are identified by a ULP symbol. The connection points on compatible modules are marked in the same manner.

### ULP Accessories Kit Quantities

Description	Qty	Catalog No.
RJ45 connectors, female/female	10	TRV00870
ULP Line termination	10	TRV00880
RJ45/RJ45 male cord L= 0.3 m	10	TRV00803
RJ45/RJ45 male cord L= 0.6 m	10	TRV00806
RJ45/RJ45 male cord L = 1 m	5	TRV00810
RJ45/RJ45 male cord L = 2 m	5	TRV00820
RJ45/RJ45 male cord L = 3 m	5	TRV00830
RJ45/RJ45 male cord L = 5 m	1	TRV00850
Modbus Line Terminations	2	VW3A8306DRC

For more information about the ULP System, see bulletin 48940-329-01, *ULP (Universal Logic Plug) Connection System—User Guide*.

## External Neutral Current Transformer (ENCT)



External Neutral Current Transformer

The external neutral current transformer is a sensor required for a three-pole circuit breaker in a system with a distributed neutral to measure the neutral current in order to:

- protect the neutral conductor
- protect against ground faults.

This current transformer can be connected to MicroLogic 5/6 trip units. The transformer rating must be compatible with that of the circuit breaker.

### ENCT Catalog Numbers

Circuit Breaker	Rating	Catalog No.
H-Frame	60–100 A	S429521
	150 A	S430562
J-Frame	250 A	S430563
L-Frame	400–600 A	S432575

For installation recommendations, see External Neutral Current Transformer (ENCT), page 197.

## External Neutral Voltage Tap (ENVT)



External Neutral Voltage Tap

The external neutral voltage tap is required for MicroLogic E power metering with a three-pole circuit breaker in a system with a distributed neutral. It is used to connect the neutral to the MicroLogic trip unit to measure phase-to-neutral (Ph-N) voltages.

The ENVT is included with the MicroLogic 5/6 electronic trip unit.

## Zone Selective Interlock (ZSI) Module

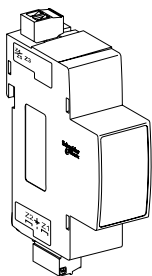

ZSI Module

A ZSI terminal block may be used to interconnect a number of MicroLogic trip units to provide zone selective interlocking for short-time ( $I_{sd}$ ) and ground-fault ( $I_g$ ) protection, without a time delay. For PowerPacT H- and J-frame circuit breakers, the ZSI function is available only in relation to the upstream circuit breaker (ZSI out). For PowerPacT L-frame circuit breakers, the ZSI function is available in relation to the upstream circuit breaker (ZSI out) and downstream circuit breakers (ZSI in)

### ZSI Module Catalog Number

Description	Catalog No.
ZSI Module	S434212

## Wiring Harness

Accessories installed in I-Line circuit breakers require the use of optional wiring harnesses (not provided). The wiring harness allows the accessory wiring to exit the circuit breaker through wiring channels in the side of the circuit breakers. Wire harnesses may also be used for unit-mount applications.

H, J-Frame

L-Frame

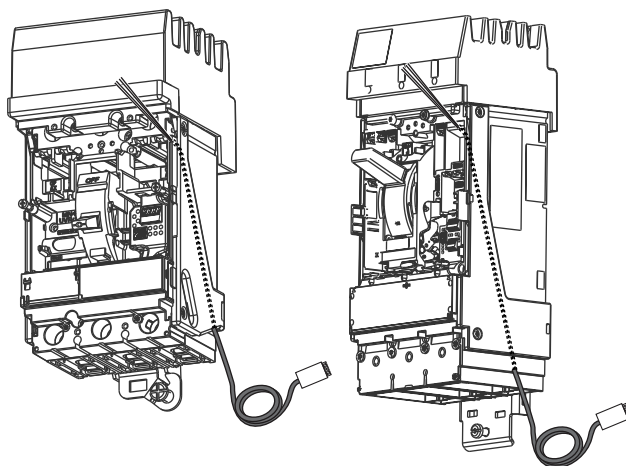

### Wire Harness

Suffix	Harness	Kit No.	Kit No.
YH3	ZSI Wire harness, H/J frame	S434300	
YH3	ZSI Wire harness, L-frame	S434301	
YH2	ENCT Wire harness	S434302	
YH1	OF wire harness	S434500	
YH1	SD/SDE wire harness	S434501	
YH1	SDx/SDTAM wire harness	S434502	
YH1	MX wire harness	P434503	S434503
YH1	MX wire harness	P434504	S434504
YH1	Motor operator wire harness	S434506	
YH13	NSX wire harness	S434508	
YH4	ENCT and ZSI wire harness	—	
YH13	24 Vdc power supply wire harness	S434505	

### Wiring Harness Catalog Numbers

Description	Catalog Numbers
Auxiliary Switch (OF) I-Line Wire Harness	S434500
Alarm Switch (SD)/Overcurrent Trip Switch (SDE) I-Line Wire Harness	S434501
SDx/SDTAM I-Line Wire Harness	S434502
Undervoltage Trip (MN) I-Line Wire Harness	S434503
Shunt Trip (MX) I-Line Wire Harness	S434504
24 Vdc Power Supply Terminal Block I-Line Wire Harness	S434505
Motor Operator (MT) I-Line Wire Harness	S434506

**Wiring Harness Catalog Numbers (Continued)**

Description	Catalog Numbers
Communicating Motor Operator (MTc) I-Line Wire Harness	S434507
NSX Cord I-Line Wire Harness	S434508
ZSI (H/J-Frame, Out Only) I-Line Wire Harness	S434300
ZSI (L-Frame, In and Out) I-Line Wire Harness	S434301
ENCT I-Line Wire Harness	S434302

## Accessories and Auxiliaries

All PowerPacT H-, J-, and L-frame circuit breakers and automatic switches have slots for the electrical auxiliaries.

### H- and J-Frame

- 4 indication contacts
  - 2 ON/OFF (auxiliary switches [OF1 and OF2])
  - 1 trip indication (alarm switch [SD])
  - 1 fault-trip indication (overcurrent trip switch [SDE])
- one remote-tripping release
  - either 1 undervoltage trip (MN)
  - or 1 shunt trip (MX)

### L-Frame

- 5 indication contacts
  - 3 ON/OFF auxiliary switches (OF1, OF2, and OF3)
  - 1 trip indication (alarm switch [SD])
  - 1 fault-trip indication (overcurrent trip switch [SDE])
- one remote-tripping release
  - either 1 undervoltage trip (MN)
  - or 1 shunt trip (MX)

Circuit breakers equipped with MicroLogic trip units may be equipped with a fault-trip indication to identify the type of fault by installing one indication module with two outputs:

- either an SDx module with MicroLogic 3.x / 5.x A or E / 6.x A or E
- or an SDTAM module with MicroLogic 2.x M

See *Auxiliary and Alarm Indication Contacts*, page 150.

This module occupies the slots of one auxiliary switch (OF) contact and an undervoltage trip (MN)/shunt trip (MX).

All these auxiliaries may be installed with a motor operator.

## Communication Network

Communication networks require specific auxiliaries.

Communication of status indications:

- 1 BSCM module
- 1 NSX cord (internal terminal block) for both communication and 24 Vdc supply to the BSCM.

Communication of status conditions is compatible with a standard motor operator.

Communication of status indications and controls requires, in addition to the auxiliaries listed above, the following:

- 1 communicating motor operator connected to the BSCM.

Communication of measurements is available on MicroLogic 5/6. The system consists of:

- 1 NSX cord (internal terminal block) for both communication and 24 Vdc supply to the MicroLogic.

Communication of measurements is compatible with a standard or communicating motor operator.

Communication of status indications, controls and measurements is available on MicroLogic 5/6. The system consists of:

- 1 BSCM module
- 1 NSX cord (internal terminal block) for both communication and 24 Vdc supply to the BSCM and the MicroLogic
- 1 communicating motor operator connected to the BSCM.

Installation of SDx or SDTAM is compatible with communication network.

For Modbus Serial direct connection use:

- 1 BSCM module
- 1 Modbus SL cord for both communication and 24 Vdc supply to BSCM <sup>164</sup>

---

<sup>164</sup>. Modbus serial only <= 480 Vac. Use only with matching Modbus serial components.

**Standard Auxiliary Possibilities Based on Trip Unit**

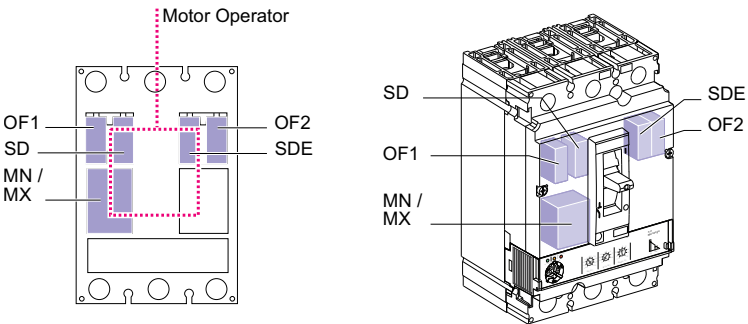
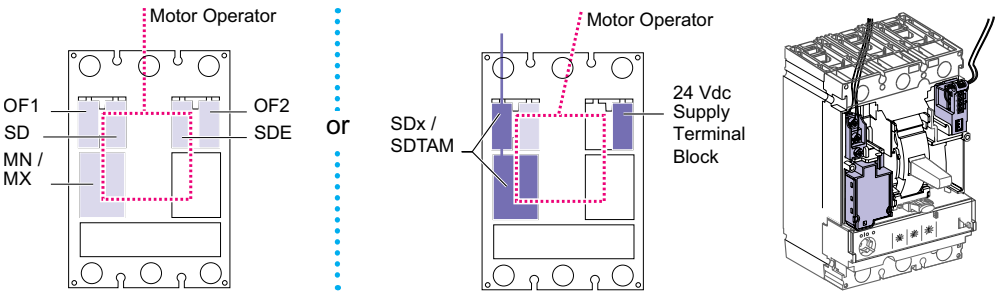
Type	Trip Unit	Auxiliary Possibilities
H-Frame J-Frame	MicroLogic 3	 <p>165</p>
H-Frame J-Frame	MicroLogic 5 MicroLogic 6	 <p><i>The SDx or SDTAM uses the OF1 and MN/MX slots. External connection is made via a terminal block in the OF1 slot. The 24 Vdc supply provides for the MicroLogic 5 / 6 display when the device is OFF or under low-load conditions.</i></p>

165. Modbus serial only <= 480Vac. Use only with matching Modbus serial components



**Standard Auxiliary Possibilities Based on Trip Unit (Continued)**

<p>L-Frame</p>	<p>MicroLogic 1.3 M MicroLogic 3</p>	
<p>L-Frame</p>	<p>MicroLogic 5 MicroLogic 6</p>	<p><b>NOTE:</b> External connection is made using a terminal block in the reserved slot. The 24 V DC supply provides for the MicroLogic 5 / 6 display when the device is OFF or under low-load conditions.</p>

**Communication Network Auxiliary Possibilities Based on Trip Unit**

Type	Trip Unit	Auxiliary Possibilities
<p>J-Frame H-Frame</p>	<p>MicroLogic 3</p>	<p><b>Communication of status indications and controls</b></p>
<p>J-Frame H-Frame</p>	<p>MicroLogic 5 MicroLogic 6</p>	<p><b>Communication of measurements with or without FDM121 display</b></p> <p><b>Communication of status indications, controls and measurements with or without FDM121 display</b></p>

**Communication Network Auxiliary Possibilities Based on Trip Unit (Continued)**

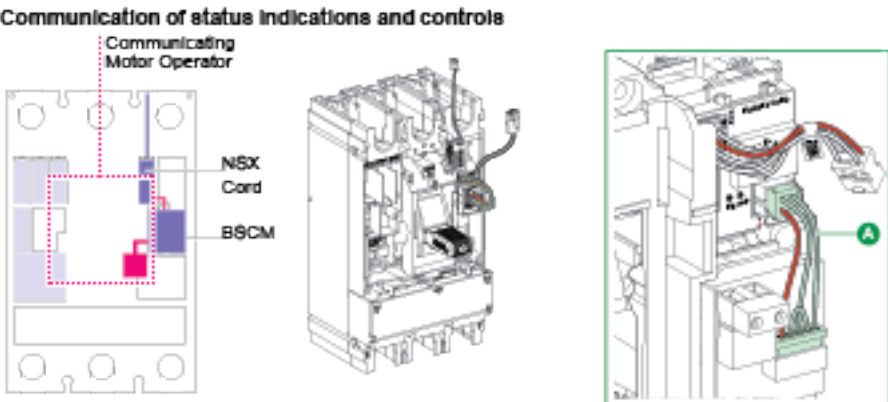
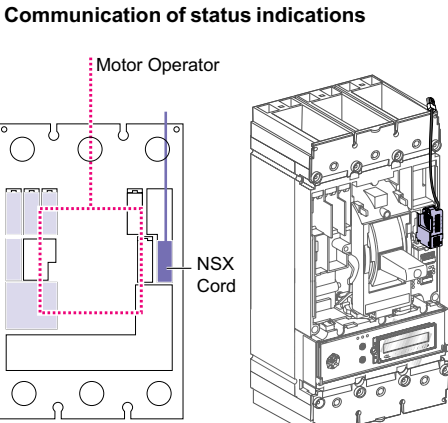
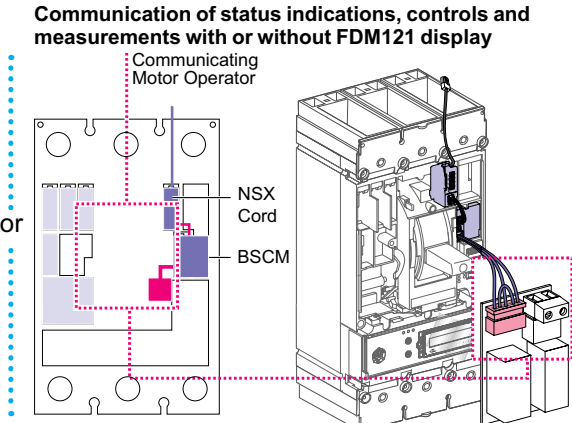
<p>L-Frame</p>	<p>MicroLogic 1.3 M MicroLogic 3</p>	<p><b>Communication of status indications and controls</b></p> <p>Communicating Motor Operator</p>  <p>NSX Cord</p> <p>BSCM</p>
<p>L-Frame</p>	<p>MicroLogic 5 MicroLogic 6</p>	<p><b>Communication of status indications</b></p> <p>Motor Operator</p>  <p>NSX Cord</p> <p>or</p> <p><b>Communication of status indications, controls and measurements with or without FDM121 display</b></p> <p>Communicating Motor Operator</p>  <p>NSX Cord</p> <p>BSCM</p>

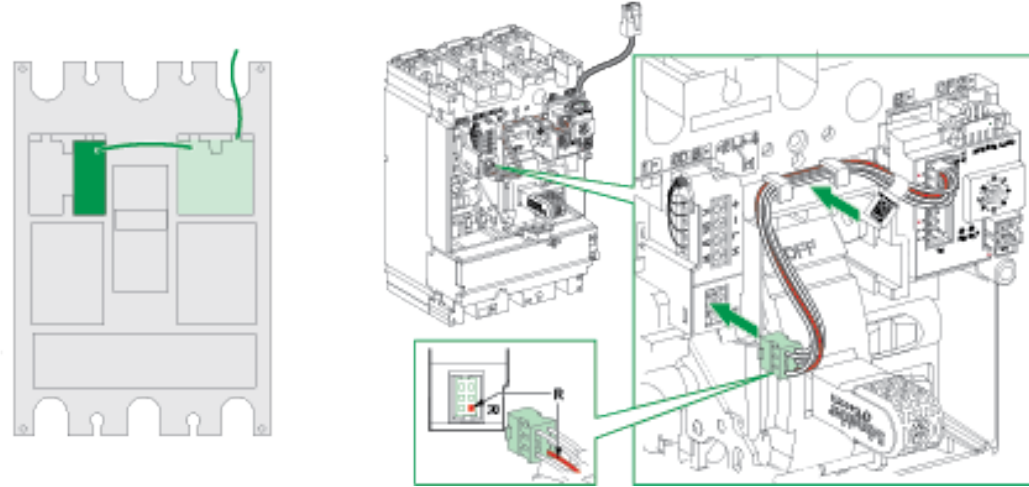
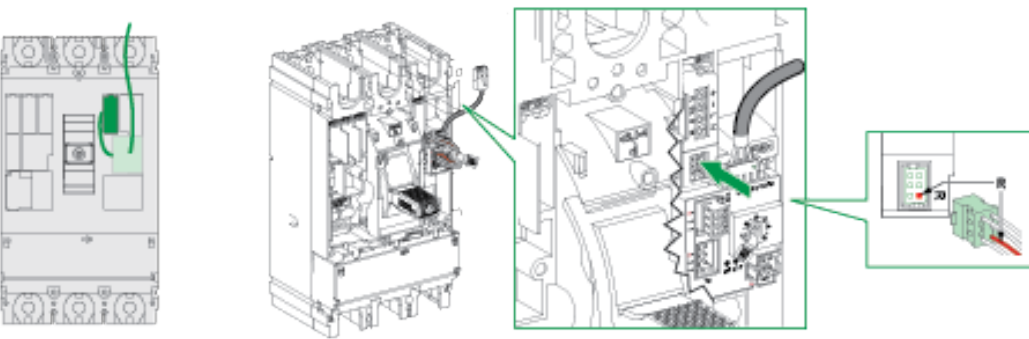
Type	Trip Unit	Auxiliary Possibilities
<p>J-Frame H-Frame</p>	<p>MicroLogic 5 MicroLogic 6</p>	<p><b>Communication of Status Indications, Controls and Measurements</b></p>  <p>The diagrams for the J-Frame/H-Frame show a top-down view of the frame with two green-shaded areas indicating terminal locations. To the right, a cutaway view of the internal assembly shows a terminal block with a red and black cable connected. A detailed inset shows a terminal block with a red wire connected to a terminal labeled 'R' and a black wire connected to a terminal labeled 'N'. Another inset shows a terminal block with a red wire connected to a terminal labeled 'R' and a black wire connected to a terminal labeled 'N'.</p>
<p>L-Frame</p>	<p>MicroLogic 5 MicroLogic 6</p>	<p><b>Communication of Status Indications, Controls and Measurements</b></p>  <p>The diagrams for the L-Frame show a top-down view of the frame with a green-shaded area indicating a terminal location. To the right, a cutaway view of the internal assembly shows a terminal block with a red and black cable connected. A detailed inset shows a terminal block with a red wire connected to a terminal labeled 'R' and a black wire connected to a terminal labeled 'N'.</p>

## Accessory Connections

Electrical accessories are fitted with numbered terminal blocks for wires with the following maximum size:

- 16 AWG (1.5 mm<sup>2</sup>) for auxiliary switches (OF1 or OF2), and shunt trip (MX) or undervoltage trip (MN)
- 14 AWG (2.5 mm<sup>2</sup>) for the motor operator

Auxiliary switch wiring exits fixed mounted devices through a knock-out in the front cover.

**NOTE:** See Plug-In Circuit Breaker Mounting, page 177 for plug-in and Drawout Mounting, page 179 for drawout options.

## Auxiliary and Alarm Indication Contacts

Auxiliary indication contacts provide remote information of the circuit breaker status and can thus be used for indications, electrical locking, relays, etc.



Auxiliary Switch (OF)/  
Alarm Switch (SD)

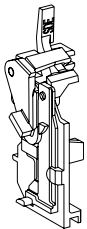

Overcurrent Trip Switch  
Actuator (SDE)

### Auxiliary and Alarm Indication Contacts

<b>Applications</b>	<p><b>Open/Closed—Auxiliary Switches (OF)</b></p> <ul style="list-style-type: none"> <li>• Indicates the position of the circuit breaker contacts</li> </ul> <p><b>Trip Indication—Alarm Switch (SD)</b></p> <ul style="list-style-type: none"> <li>• Indicates that the circuit breaker has tripped due to an overload, short circuit or ground fault, the operation of a shunt trip or undervoltage trip or the “push-to-trip” button</li> <li>• Resets when the circuit breaker is reset</li> </ul> <p><b>Overcurrent Trip Switch (SDE)</b></p> <ul style="list-style-type: none"> <li>• Indicates that the circuit breaker has tripped due to an overload, short circuit or ground fault</li> <li>• Resets when the circuit breaker is reset</li> </ul> <p>The above switches are also available in low-level versions (with gold flash plating) capable of switching very low loads (e.g., for controlling PLCs or electronic circuits)</p> <p><b>Rotary Handle Indicator: CAO (early-break) and CAF (early-make)</b></p> <ul style="list-style-type: none"> <li>• Fitted in the rotary handle module (see Rotary Operating Handles, page 160).</li> </ul>
<b>Installation &amp; Connection</b>	<ul style="list-style-type: none"> <li>• The auxiliary switch (OF), alarm switch (SD), and overcurrent trip switch (SDE) indication contacts snap into cavities behind the front accessory cover of the circuit breaker.</li> <li>• One model serves for all indication functions depending on where it is fitted in the circuit breaker.</li> <li>• The overcurrent trip switch (SDE) in a circuit breaker equipped with a thermal-magnetic or MicroLogic 1/2/3 trip unit requires the SDE actuator.</li> </ul>
<b>Standards</b>	<ul style="list-style-type: none"> <li>• The internal accessories comply with requirements of Underwriters Laboratories® Inc. (UL®).</li> <li>• UL 489 and Canadian Standard Association C22.2 No. 5-02 Standards.</li> <li>• All internal accessories are Listed for field installation per UL file E103955 and Certified under CSA file LR 69561.</li> <li>• Auxiliary indicator contacts comply with UL 489, CSA C22.2 No. 5-02 and IEC 60947-5 Standards. “Low-level” indicator contacts are not UL Recognized.</li> </ul>

### Electrical Characteristics

Characteristic		Standard		Low-Level <sup>166</sup>	
Supplied as Standard (Form C)		4		4	
Maximum Number of Contacts		4		4	
Rated Thermal Current		6 A		5 A	
Minimum Load		100 mA at 24 V		1 mA at 4 V	
Operational Current		AC	DC	AC	DC
	24 V	6 A	6 A	5 A	5 A
	48 V	6 A	2.5 A	5 A	2.5 A
	110 V	6 A	0.6 A	5 A	0.6 A
	220/240 V	6 A	—	5 A	—
	250 V	—	0.6 A	5 A	0.3 A
	380/440 V	6 A	—	5 A	—
	480 V	6 A	—	5 A	—
	660/690 V	6 A	—	—	—

### Auxiliary Switch Catalog Numbers

Contacts	Factory-Installed Suffix	Field-Installable Kit No.	Kit Qty.
1A/1B Standard	AA	S29450	1
2A/2B Standard	AB	S29450	2
1A/1B Low-Level (Gold)	AE	S29452	1
2A/2B Low-Level (Gold)	AF	S29452	2

### Alarm/Overcurrent Trip Switch Catalog Numbers

Suffix	Switch	Kit No.	Kit Qty.
PowerPacT L-Frame PowerPacT H/J-Frame with MicroLogic 5/6 trip units			
BC	Alarm Switch	S29450	1
BH	Alarm Switch Low-Level	S29452	1
BD	Overcurrent Trip Switch Standard	S29450	1
BJ	Overcurrent Trip Switch Low-Level	S29452	1
BE	Alarm Switch and Overcurrent Trip Switch, Standard	S29450	2
BK	Alarm Switch and Overcurrent Trip Switch, Low-Level	S29452	2
PowerPacT H/J-Frame with Thermal-Magnetic or MicroLogic 1/2/3 trip units			
BC	Alarm Switch	S29450	1
BH	Alarm Switch, Low-Level	S29452	1
BD	Overcurrent Trip Switch, Standard SDE Actuator	S29450 S29451	1 1
BJ	Overcurrent Trip Switch, Low-Level SDE Actuator	S29452	1 1

166. If the maximum voltage and current is exceeded, the low-level function of the switch will be lost but the switch will continue to function as a standard switch.

### Alarm/Overcurrent Trip Switch Catalog Numbers (Continued)

Suffix	Switch	Kit No.	Kit Qty.
		S29451	
BE	Alarm Switch and Overcurrent Trip Switch, Standard SDE Actuators	S29450 S29451	2 2
BK	Alarm Switch and Overcurrent Trip Switch, Low-Level SDE Actuators	S29452 S29451	2 2

## SDx and SDTAM Modules for MicroLogic Trip Units

SDx and SDTAM are relay modules with two outputs. They send different signals depending on the type of fault. They may not be used together.

### SDx Module

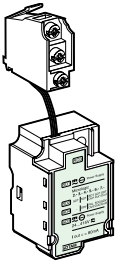

SDx module with terminal block.

The SDx module remotely monitors the trip or alarm conditions of PowerPacT H-, J-, and L-frame circuit breakers equipped with electronic protection.

An SDx relay module installed inside the circuit breaker can be used to remote the overload trip signal.

This module receives the signal from the MicroLogic electronic trip unit through an optical link and makes it available on the terminal block. The signal is cleared when the circuit breaker is closed. These outputs can be reprogrammed to be assigned to other types of tripping or alarm.

The SDx module may be used in 400 Hz systems for voltages from 24 to 440 V.

The SD2 output, available on all MicroLogic trip units, corresponds to the overload-trip indication.

The SD4 output, available on MicroLogic 5/6, is assigned to:

- overload pre-alarm (MicroLogic 5)
- ground-fault trip indication (MicroLogic 6)

These two outputs automatically reset when the device is closed (turned ON).

For MicroLogic 5/6, the SD2 and SD4 outputs can be reprogrammed to be assigned to other types of tripping or alarm.

It is possible to assign a function output characteristics:

- latching with a time delay. Return to the initial state occurs at the end of the time delay
- permanent latching. Return to the initial state takes place through the communication function.

Static outputs: 24–415 Vac / Vdc; 80 mA max.

# SDTAM Module

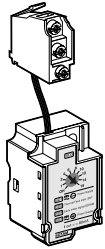

SDTAM module with terminal block

The SDTAM module, linked to the contactor controller, opens the contactor when an overload or other motor fault occurs, thus avoiding opening of the circuit breaker. The SDTAM module is specifically for the motor-protection MicroLogic trip units 2 M (2.2 M and 2.3 M).

### MicroLogic 2 M

The SD4 output opens the contactor 400 ms before normal circuit-breaker opening in the following cases:

- overload (long-time protection for the trip class)
- phase unbalance or phase loss

The SD2 output serves to memorize contactor opening by SDTAM.

### Output characteristics

Output reset can be:

- manual by a pushbutton included in the wiring diagram
- automatic after an adjustable time delay (1 to 15 minutes) to take into account the motor-cooling time

Static outputs: 24–415 Vac / Vdc; 80 mA max. a (+) 24–415 V.

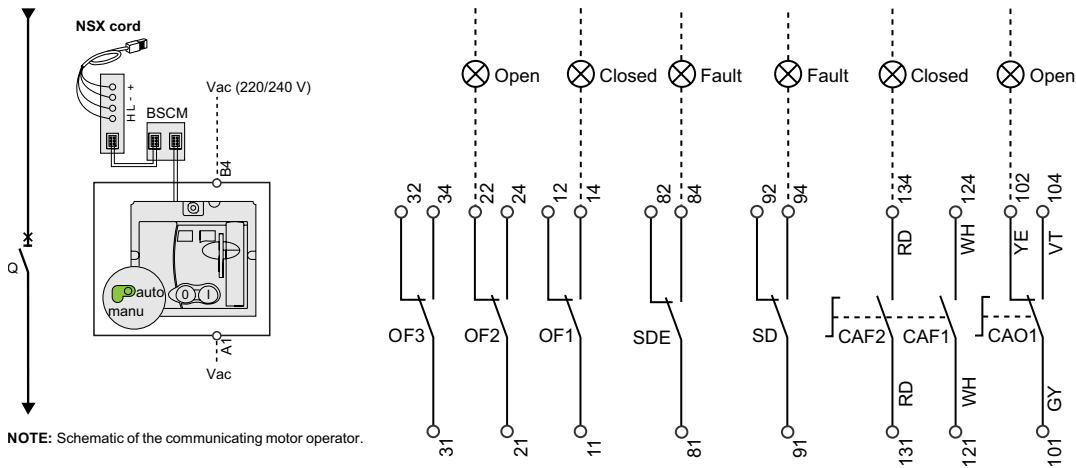

NOTE: Schematic of the communicating motor operator.

### SDx and SDTAM Catalog Numbers

Description	Factory-Installed Suffix	Catalog No.
SDx	V	S429532
SDTAM	V	S429424

## Shunt Trip (MX) and Undervoltage Trip (MN)



A voltage release can be used to trip the circuit breaker using a control signal.

### Shunt Trip and Undervoltage Trip

<b>Applications</b>	<p><b>Shunt Trip (MX)</b></p> <ul style="list-style-type: none"> <li>Trips the circuit breaker when the control voltage rises above 70% of its rated voltage</li> <li>Impulse type <math>\geq 20</math> ms or maintained control signals</li> <li>AC shunt trips are suitable for ground-fault protection when combined with a Class I ground-fault</li> <li>Sensing element</li> <li>Continuous duty rated coil</li> </ul> <p><b>Undervoltage Trip (MN)</b></p> <ul style="list-style-type: none"> <li>Trips the circuit breaker when the control voltage drops below a tripping threshold</li> <li>Drops out between 35% and 70% of the rated voltage</li> <li>Continuous duty rated coil</li> <li>Circuit breaker closing is possible only if the voltage exceeds 85% of the rated voltage. If an undervoltage condition exists, operation of the closing mechanism of the circuit breaker will not permit the main contacts to touch, even momentarily. This is commonly called "Kiss Free."</li> </ul>
<b>Installation and Connection</b>	<ul style="list-style-type: none"> <li>Accessories are common to H-, J-, and L-frame circuit breakers and snap into cavities under the front accessory cover of the circuit breaker.</li> <li>Each terminal may be connected by one 18–14 AWG (1.0–2.5 mm<sup>2</sup>) stranded copper wire.</li> </ul>
<b>Operation</b>	<ul style="list-style-type: none"> <li>The circuit breaker must be reset locally after being tripped by shunt trip (MX) or undervoltage trip (MN).</li> <li>Tripping by the shunt trip or undervoltage trip has priority over manual (or motor operator) closing; in the presence of a standing trip order such an action does not result in any closing, even temporarily, of the main contacts.</li> <li>Endurance: 50% of the rated mechanical endurance of the circuit breaker</li> </ul>

### Electrical Characteristics

		AC	DC
Rated Voltage (V)		24, 48, 120, 208/277, 380/480, 525, 600	12, 24, 30, 48, 60, 125, 250
Power Requirements	Pickup (shunt trip)	< 10 VA	< 5 W
	Seal-in (undervoltage trip)	< 5 VA	< 5 W
Clearing Time (ms)		< 50	< 50

### Shunt Trip and Undervoltage Trip Suffix Codes and Kit Numbers

Voltage	Shunt Trip (MX)			Undervoltage Release (MN)		
	Suffix Description	Kit No.	Kit No. <sup>167</sup>	Suffix Description	Kit No.	Kit No. <sup>167</sup>
24 Vac	SK	P29384	—	UK	P29404	—
48 Vac	SL	P29385	—	UL	P29405	—
120 Vac	SA	P29386	S29386	UA	P29406	—
208/277 Vac	SD	P29387	S29387	UD	P29407	S29407
380/480 Vac	SH	P29388	S29388	UH	P29408	S29408
525/600 Vac	SJ	P29389	—	UJ	P29409	—

167. MN/MX — Spring Clamp Version — as Kit only



**Shunt Trip and Undervoltage Trip Suffix Codes and Kit Numbers (Continued)**

Voltage	Shunt Trip (MX)			Undervoltage Release (MN)		
	Suffix Description	Kit No.	Kit No. <sup>168</sup>	Suffix Description	Kit No.	Kit No. <sup>168</sup>
12 Vdc	SN	P29382	S29382	UN	P29402	—
24 Vdc	SO	P29390	S29390	UO	P29410	S29410
30 Vdc	SU	P29391	—	UU	P29411	—
48 Vdc	SP	P29392	S29392	UP	P29412	S29412
60 Vdc	SV	P29383	—	UV	P29403	—
125 Vdc	SR	P29393	—	UR	P29413	—
250 Vdc	SS	P29394	S29394	US	P29414	S29414

**Adjustable and Fixed Time Delay Units for Undervoltage Trip**

Rated Input Voltage	Field-Installable Kit No.		Use Only with These Undervoltage Releases (MN)
	Adjustable	Fixed	
48 Vac/dc	S33680	S29426	S29412
100/130 Vac/dc	S33681	—	S29413
220/250 Vac/dc	S33682	S29427	S29414

168. MN/MX — Spring Clamp Version — as Kit only

# Motor Operator



The motor operator remotely operates the circuit breaker featuring easy and sure operation:

- All circuit breaker indications and information remain visible and accessible, including trip unit settings and circuit breaker connection.
- Suitability for isolation is maintained and padlocking remains possible.
- Double insulation front face

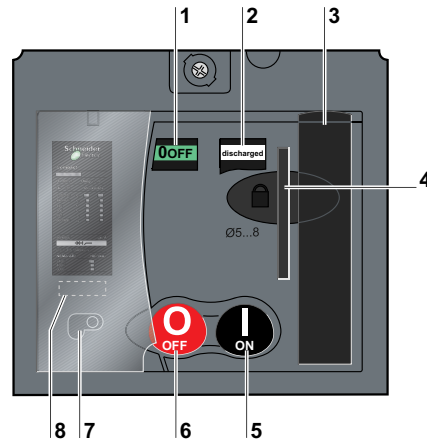

1. Contact position indicator (suitability for isolation)
2. Spring status indicator (charged, discharged)
3. Manual spring-charging handle
4. Keylock device  
Locking device (off position) using one to three padlocks, diameter 0.2–0.32 in. (5–8 mm), not supplied
5. ON push button
6. OFF push button
7. Manual/auto mode selection switch; the position of the switch can be indicated remotely.
8. Operation counter

## Applications:

- Local motor-driven operation, centralized operation, automatic distribution control
- Normal/standby manual transfer or switching to a replacement source to optimize energy costs
- Load shedding and reconnection to optimize energy costs
- Less than five cycle closing time for source synchronization

## Installation and Connection

- All installations are available for H- and J-frame circuit breakers.
- All installations are available for L-frame circuit breakers except I-Line.
- Connections of the motor operator module are to a built-in terminal block behind its front cover.
- Stranded copper wire 14 AWG (2.5 mm<sup>2</sup>)

## Automatic Operation

- The motor operator is connected in series with the overcurrent trip switch (SDE).
- ON and OFF by two impulse type or continuous control signals
- Depending on the wiring, resetting can be done locally, remotely or automatically.
- Mandatory manual reset following tripping due to an electrical fault (with overcurrent trip switch)

## Manual Operation

- Transfer to manual mode with possibility of remote mode indication
- ON and OFF by two push buttons
- Recharging of stored-energy system by pumping the lever
- Padlocking in off position

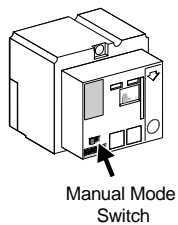

### Motor Operator Characteristics

Response Time (ms)	Opening	< 600	
	Closing	< 80	
Operating Frequency	cycles/minute max.	4	
Power Requirements 169	AC (VA)	Opening	≤500
		Closing	≤500
	DC (W)	Opening	≤500
		Closing	≤500

**NOTE:** Visi-Trip is not compatible with motor operators.

### Motor Operator and Accessory Suffix Codes and Catalog Numbers

Device <sup>170</sup>	Control Voltage	Factory-Installed Suffix	Field-Installable Kit No.		
			H-Frame	J-Frame	L-Frame
Communicating Motor Operator	220/240 Vac 50/60 Hz	NC	S429441	S431549	S432652
Motor Operator	48/60 Vac 50/60 Hz	ML	S29440	S31548	S432639
	110/130 Vac 50/60 Hz	MA	S29433	S31540	S432640
	208/277 Vac 60 Hz	MD	S29434	S31541	S432641
	380/415 Vac 50/60 Hz	MF	—	—	S432642
	440/480 Vac 60 Hz	MH	S29435	S31542	S432647
	24/30 Vdc	MO	S29436	S31543	S432643
	48/60 Vdc	MV	S29437	S31544	S432644
	110/130 Vdc	MR	S29438	S31545	S432645
	250 Vdc	MS	S29439	S31546	S432646
Lock Mounting Hardware	—	—	—	—	S32649
Ronis® Lock	—	—	S41940	S41940	S41940
Profalux® Lock	—	—	S42888	S42888	S42888
Mounting Hardware with Ronis Lock	—	—	S429449	S429449	—
Operations Counter	—	—	—	—	S32648
Adapter for I-Line Circuit Breaker	—	—	S37420	S37420	—

169. For H- and J-frame, the inrush current is 2x operating current for 10 ms.

170. For NSX cord (communication suffixes EA, EB, ED, and EE) any motor operator may be selected. For BSCM + NSX cord (communication suffixes EB, EH, EK, and EL) only the communicating motor operator may be selected.

## Add-On Ground-Fault Module (GFM) (H- and J-Frame Only)

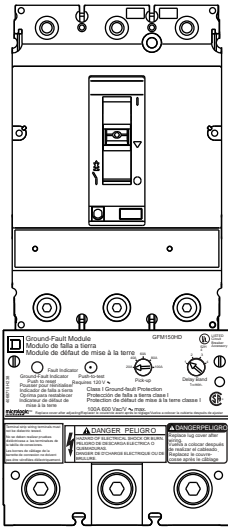

J-Frame Circuit Breaker  
with GFM Installed

The MicroLogic Ground-Fault Module (GFM) is a UL Listed/CSA Certified circuit breaker accessory which protects equipment from damage caused by ground faults. It is an add-on module which, when connected to a PowerPacT H- or J-frame thermal-magnetic circuit breaker only, provides ground-fault sensing and ground-fault relay functions.

HD/JD ground-fault modules feature:

- Adjustable ground-fault pickup levels
- Adjustable ground-fault time delays
- Integral ground-fault push-to-test feature
- Ground-fault indicator (mechanical for local, contacts for remote)
- All GFMs are supplied for I-Line mounting as standard, easily convertible to unit mount by removing the I-Line bracket.
- Fault-powered (through the sensing current transformer) for electronics, shunt trip, and integral test feature. Meets NEC 230.95(C).
- A 12 Vdc shunt trip module (Catalog No. S29382) is required in the circuit breaker. This may be field installed or factory installed when the circuit breaker is ordered with an -SN suffix.
- UL 1053 – Ground-fault Sensing and Relaying Equipment

The GFM system requires the following:

- H-frame (15–150 A) or J-frame (150–250 A) molded case circuit breaker
- Shunt trip for circuit breaker (may be factory-installed or field-installed)
- Bus bar connection (terminal nut inserts) for OFF end of circuit breaker
- Optional neutral current transformer, catalog number GFM25CT (must be ordered for 4-wire applications).

### Ground Fault Modules

Catalog No.	Rating	Sensitivity	Time Delay (Approximate)
GFM150HD	150 A	20, 40, 60, 80, 100 A	0.2, 0.3, 0.4, 0.6 sec
GFM250JD	250 A	40, 80, 120, 160, 200 A	0.2, 0.3, 0.4, 0.6 sec

## Earth Leakage Module (ELM) (H- and J-Frame Only)



J-Frame Circuit Breaker  
with ELM Installed

The Earth Leakage Module (ELM) is an add-on module which, when connected to a PowerPacT H- or J-frame MCCB, provides low-level ground-fault sensing and ground-fault relay functions.

Because these ELMs are highly sensitive (30 mA to 3 A), they provide much greater protection than GFM's (20 to 200 amperes sensitivity). The ELMs provide greater protection of control circuits and other sensitive equipment. The associated circuit breaker must have a 48 Vdc shunt trip, which may be field-installed (kit S29392) or factory-installed (suffix –SP) in the H- or J-frame circuit breaker.

The add-on Earth Leakage Module (ELM) features:

- Adjustable ground-fault pickup levels as low as 30 mA
- Adjustable ground-fault time delays from instantaneous to 500 msec (time delay can be applied to any setting)
- Integral ground fault push-to-test feature
- Ground-fault indicator; pop-up button for local status and contacts for remote indication (to be used only with the tripping option)
- All ELMs are supplied for I-Line mounting and are easily convertible to unit-mount by removing the I-Line mounting feet
- Three poles; 240 to 600 Vac maximum: 3-phase, 3-wire (no neutral) and 1-phase, 2-wire applications
- Line-power obtained through internal bus to provide power for electronics, shunt trip, and integral test feature
- A shunt trip is required in the circuit breaker; it may be field-installed or factory-installed in the PowerPacT H and J circuit breakers.
- UL 1053—Ground-fault Sensing and Relaying Equipment

### ELM Selection Chart

Companion Circuit Breaker		Enclosure Space Required I-Line Equipment	Catalog No.	Pick-Up Adjustments	Ground-Fault Time Delay Adjustments
Prefix	Size				
HD, HG, HJ, HL	15–150 A	LA	ELM150HD	30 mA 100 mA 300 mA 1A 3A	Instantaneous 60 ms 100 ms 500 msec
JD, JG, JJ, JL	150–250 A <sup>171</sup>	LA	ELM250JD		

## Factory-Installed ELMs

The catalog number for circuit breakers with factory-installed ELM should include the special suffixes SP and VL or VM: H D M 3 6 150 SP VL

where

- H = H-frame (or J = J-frame)
- D = D interruption level (or G, J or L)
- M = Lugs on ON end and terminal nuts on OFF end (required)
- SP = Factory-installed 48 Vdc shunt trip (S29392, required)
- VL = Earth Leakage Module (ELM) <150 A (H-frame) or  
VM = Earth Leakage Module (ELM) <250 A (J-frame)

171. At 250 A, the ELM250JD can be used with standard (80%) rated circuit breakers only.

# Rotary Operating Handles

## Directly Mounted Rotary Operating Handles

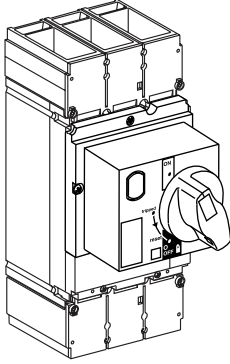

Directly Mounted Rotary Operating Handle

<b>Installation</b> <sup>172</sup>	The directly mounted rotary operating handle replaces the circuit breaker front accessory cover (secured by screws).	
<b>Operation</b>	<p>The direct rotary handle maintains:</p> <ul style="list-style-type: none"> <li>• Suitability for isolation</li> <li>• Indication of three positions: I (ON), Tripped and O (OFF)</li> <li>• Access to the “push-to-trip” button</li> <li>• Visibility of, and access to, trip unit settings</li> <li>• The circuit breaker may be locked in the OFF position by using one to three padlocks (not supplied).</li> </ul>	
<b>Models</b>	<ul style="list-style-type: none"> <li>• Standard with black handle</li> <li>• VDE type with red handle and yellow bezel for machine tool control</li> </ul>	
<b>Variations</b>	<p>Accessories transform the standard direct rotary handle for the following situations:</p> <ul style="list-style-type: none"> <li>• Motor control centers (MCCs): <ul style="list-style-type: none"> <li>◦ Opening of door prevented when circuit breaker is on.</li> <li>◦ Closing of circuit breaker inhibited when door is open.</li> </ul> </li> <li>• Machine tool control: complies with CNOMO E03.81.501N; degree of protection IP54</li> <li>• Early make or early break contacts may be installed into direct mount rotary handle.</li> </ul>	
<b>Standards</b>	The directly-mounted rotary operating handle is UL Listed under file E103955 and CSA Certified under file LR 69561.	

172. Visi-Trip is not compatible with handle accessories.

## Door-Mounted (Extended) Rotary Operating Handle

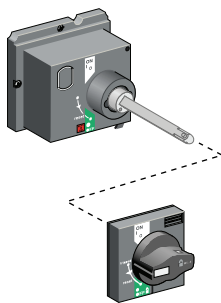

Door Mounted Rotary Operating Handle

<b>Installation</b>	<p>The door-mounted (extended) rotary operating handle is made up of:</p> <ul style="list-style-type: none"> <li>• A unit that replaces the front accessory cover of the circuit breaker (secured by screws)</li> <li>• An assembly (handle and front plate) on the door that is always secured in the same position, whether the circuit breaker is installed vertically or horizontally</li> <li>• An adjustable extension shaft</li> <li>• The handle mechanism can be used in NEMA 3R and 12 enclosure applications.</li> </ul>
<b>Operation</b>	<p>The door mounted operating handle makes it possible to operate a circuit breaker installed in an enclosure with the enclosure door closed. The door mounted operating handle maintains:</p> <ul style="list-style-type: none"> <li>• Suitability for isolation</li> <li>• Indication of the three positions OFF (O), ON (I) and tripped</li> <li>• Visibility of, and access to, trip unit settings when the door is open</li> <li>• Degree of protection: IP40 as per IEC 529</li> </ul> <p>Defeatable interlock prevents opening of door when circuit breaker is on.</p> <p>The circuit breaker may be locked in the off position by using one to three padlocks, padlock shackle diameter 0.19–0.31 in. (5–8 mm); padlocks are not supplied; locking prevents opening of the enclosure door.</p>
<b>Shaft Length</b>	<p>The shaft length is the distance between the back of the circuit breaker and the door:</p> <ul style="list-style-type: none"> <li>• Minimum shaft length is 7.4 in. (185 mm).</li> <li>• Maximum shaft length is 24 in. (600 mm).</li> <li>• Extended shaft length must be adjusted.</li> </ul>
<b>Models</b>	<ul style="list-style-type: none"> <li>• Standard with black handle</li> <li>• VDE type with red handle and yellow bezel for machine tool control</li> </ul>
<b>Variations</b>	<p>For drawout configurations, the extended rotary handle is also available with a telescopic shaft containing two stable positions.</p>
<b>Standards</b>	<p>The door-mounted rotary operating handle is UL Listed under file E103955 and CSA Certified under file LR 69561.</p>

### Rotary Operated Handles

		H- and J-Frame <sup>173</sup>		L-Frame		
Device	Description	Factory Installed Suffix	Field Installable Kit No.	Factory Installed Suffix	Field Installable Kit No.	
Direct Mounted	Standard black handle	Handle only	RD10	S29337	RD10	S32597
	Standard black handle with:	One early-break switch	RD12	S29337 + S29345	RD12	S32597 + S32605
		Two early-make switches	RD13	S29337 + S29339	RD13	S32597 + S29346
	Red handle on yellow bezel	Handle only	RD20	S29339	RD20	S32599
		One early-break switch	RD22	S29339 + S29345	RD22	S32599 + S32605
		Two early-make switches	RD23	S29339 + S29346	RD23	S32599 + S29346
	MCC conversion accessory		—	S429341	—	S32606
CNOMO conversion accessory		—	S29342	—	S32602	
Door Mounted	Standard black handle	Handle only	RE10	S29338	RE10	S32598

173. Not available in H-frame two-pole modules.

## Rotary Operated Handles (Continued)

	Standard black handle with:	Two early make switches	RE13	S29338 + S29345	RE13	S32598 + S32605
	Red handle on yellow bezel	Handle only	RE20	S29340	RE20	S32600
Telescoping			RT10	S29343	RT10	S32603
Accessories	Key lock adapter		—	S429344	—	S32604
	Key locks	Ronis 1351.500	—	S41940	—	S41940
		Profalux KS5 B24 D4Z	—	S42888	—	S42888
		2 Ronis keylocks with 1 key	—	S41950	—	S41950
		2 Profalux keylocks with 1 key	—	S42878	—	S42878
	Indication auxiliary switch	One early-break switch	—	S29345	—	S32605
Two early-make switches		—	S29346	—	S29346	

## Class 9421 NEMA Door Mounted Rotary Operating Handles



<b>Installation</b>	<p>The extended rotary operating handle is made up of:</p> <ul style="list-style-type: none"> <li>• A mounting plate that provides a rotary actuator for a standard toggle circuit breaker</li> <li>• Handle assemblies available for NEMA 3, 3R, 4, and 4X</li> <li>• Available in standard or short (3 in.) handle assemblies</li> </ul>
<b>Operation</b>	<p>The door mounted operating handle makes it possible to operate a circuit breaker installed in an enclosure with the enclosure door closed.</p> <p>Provides ON (I) and OFF (O) indication.</p> <p>The circuit breaker may be locked in the off position.</p>
<b>Shaft Length</b>	<p>The shaft length is the distance between the back of the circuit breaker and the door:</p> <ul style="list-style-type: none"> <li>• Minimum mounting depth is 5.5 in. (138 mm).</li> <li>• Maximum mounting depth is 10.75 in. (273 mm) with standard shaft.</li> <li>• Maximum mounting depth is 21.3 in. (543 mm) with long shaft.</li> </ul>

## H- and J-Frame Class 9421 Door-Mounted Operating Mechanism

### Catalog Numbers

Description	Catalog No.
Standard Shaft Kit	9421LJ1
Long Shaft Kit	9421LJ4

### H- and J-Frame Component Parts

Description	Catalog No.	
Standard Handle Assembly	Type 1, 3R, 12	9421LH6
	NEMA Type 3 and 4, Painted	9421LH46
	NEMA Type 3 and 4, Chrome Plated	9421LC46



**H- and J-Frame Component Parts (Continued)**

Operating Mechanism	Includes Lockout	9421LJ7
Standard Shaft	Support Bracket Not Required	9421LS8
Long Shaft	Support Bracket Included	9421LS13

**L-Frame NEMA Door-Mounted Rotary Operated Handles**

Handle Type	Poles	Operating Mechanism Included in Kit	Mounting Depth Min–Max	Kit Number
Painted 6 in.	3	9421LS8 and 9421LC46	7-1/4 to 12-1/16 in. (184 to 306 mm)	9421LD1
		9421LS13 and 9421LH46	7-1/4 to 22-5/8 in. (184 to 575 mm)	9421LD4

**Class 9422 Cable Operating Handle**

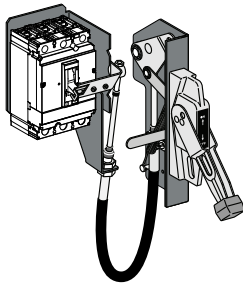

Flange-mounted handle cable operating mechanism is for use with Class 9422 Type A handle operators especially designed for tall, deep enclosures where placement flexibility is required.

<b>Applications</b>	<ul style="list-style-type: none"> <li>The cable operator maintains:                             <ul style="list-style-type: none"> <li>Suitability for isolation</li> <li>Indication of three positions: O (OFF), I (ON) and tripped</li> <li>Access to push-to-test</li> </ul> </li> <li>The circuit breaker may be locked in the off position by one to three padlocks.</li> <li>Door can be locked closed due to interlocking features of the handle operator.</li> </ul>
<b>Installation</b>	<ul style="list-style-type: none"> <li>Handle is mounted on flange of enclosure using specified mounting dimensions while circuit breaker and operating mechanism are mounted to inside of enclosure using two screws.</li> <li>Cable lengths available in 3-, 5- or 10-foot lengths to accommodate a variety of mounting locations. Handles are available in painted NEMA 1, 3, 3R, 4 (sheet steel) and 12 ratings or chrome (NEMA 4, 4X).</li> </ul>

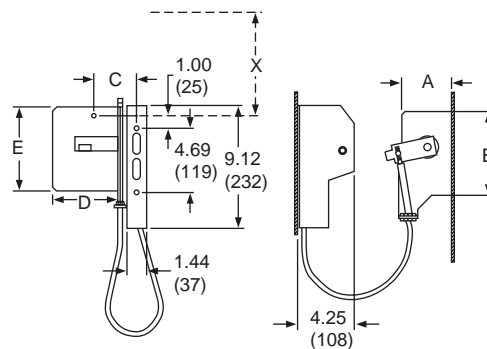

Refer to NEC Article 430-10 for minimum dimension X from circuit breaker top mounting hole to wall or barrier to ensure adequate wire bending space.

**NOTE:** Bend radius in cable must never be less than 6 in. (152 mm). Electrical clearances must be maintained between cable and live electrical parts.

Dimensions: in. (mm)

**Class 9422 Cable Operating Mechanisms and A1 Handles**

Description	H- and J-Frame Kit Number	L-Frame Kit Number
Cable Mechanism Length	9422CSF30	9422CSJ30

**Class 9422 Cable Operating Mechanisms and A1 Handles (Continued)**

	60 in (1524 mm)	9422CSF50	9422CSJ50
	84 in. (2134 m)	9422CSF70	—
	120 in. (3048 mm)	9422CSF10	9422CSJ10
A1 Painted Flange Handle		—	9422A1
Operating Mechanism Only		—	9422RS1

## Class 9422 Flange-Mounted Variable-Depth Operating Mechanism



Threaded-rod flange-mounted variable depth operating mechanism

Designed for installation in custom built control enclosures where main or branch circuit protective devices are required.

- All circuit breaker operating mechanisms are suitable for either right- or left-hand flange mounting, convertible on the job.
- H- and J-frame variable mounting depth range: 5.88–17.75 in. (149–451 mm).
- H- and J-frame operating mechanism 9422RQ1 does not include handle mechanism.

**L-Frame Flange-Mounted Operating Mechanism**

Description	Depth	Kit Number
Variable Depth Mechanism	9.00–17.75 in. (229–451 mm)	9422RSI

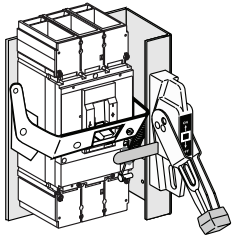

# Locking Systems

Padlocking systems can receive up to three padlocks with diameters of 0.19–0.31 in. (5–8 mm); padlocks not supplied.

H- and J-Frame

L-Frame

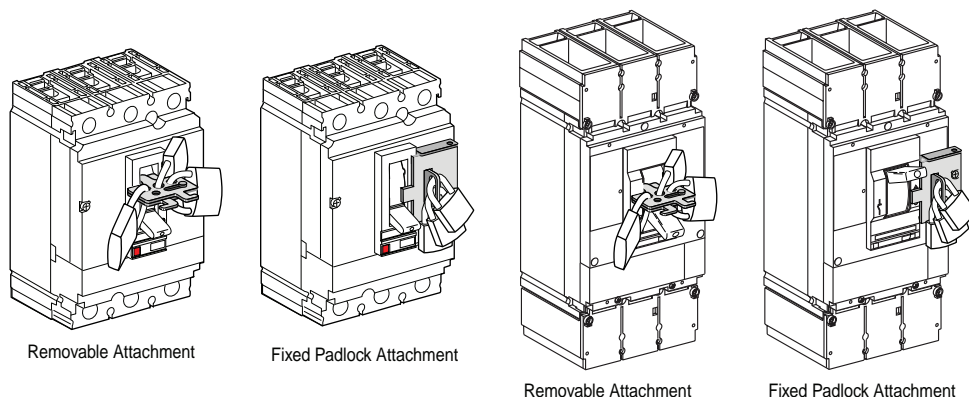

## Device Locking, Interlocking Options

Device	Description	Field-Installed Cat. No.	
		H- and J-Frame	L-Frame
Handle Padlocking Device <sup>174</sup>	Removable (lock OFF only)	S29370	S29370
	Fixed (lock OFF or ON)	HJPA	S32631
	Fixed (lock OFF only) <sup>175</sup>	HJPA	NJPAF
Key Locking	Provision and 2 locks keyed alike	Ronis	S41950
		Profalux	S42878

174. Rotary handles and motor operators have integral padlocking capability.

175. Not available in HD or HG two-pole modules.

## Manual Mechanical Interlocking System

Some installations use two power supply sources to counter any temporary loss in the main supply. A mechanical interlocking system is required to safely switch between the two sources. The replacement source can be a generator set or another network.

Managing multiple power sources can be controlled manually by mechanical interlocks.

The mechanical interlocking system is made up of:

- two H-, J-, or L-frame devices (circuit breakers or switches) controlled manually
- mechanical interlocking, which prevents handle movement from the OFF position while the other device is in the ON position.

Since it is controlled manually by a maintenance technician, switchover time from the normal source to the replacement source can vary.

### H- and J-Frame

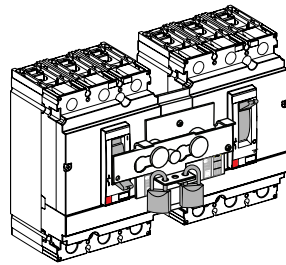

Interlocking with Toggle Control (S29354)

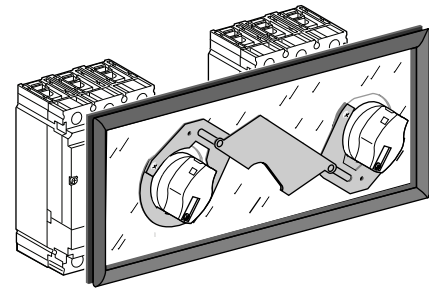

Interlocking with Rotary Handles (S29369)

### L-Frame

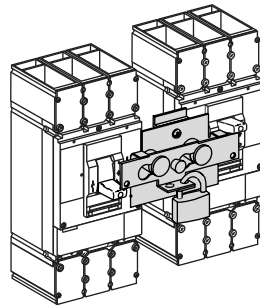

Interlocking with Toggle Control (S32614)

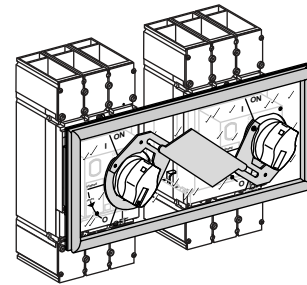

Interlocking with Rotary Handles (S32621)

## Interlocking of Circuit Breakers with Toggle Control

Two devices can be interlocked using this system. Two identical interlocking systems can be used to interlock three devices installed side by side.

Authorized positions:

- one device closed (ON), the others open (OFF)
- all devices open (OFF)

The system is locked using one or two padlocks (shackle diameter 0.19–0.31 in. [5 to 8 mm]). This system can be expanded to more than three devices.

There are two interlocking-system models:

- one for PowerPacT H- and J-frame circuit breakers
- one for PowerPacT L-frame circuit breakers

All toggle-controlled unit-mount or plug-in PowerPacT H-, J-, and L-frame circuit breakers and automatic switches of the same frame size can be interlocked. The devices must be either all unit-mount or all plug-in versions. Interlocking is not available for I-Line constructions.

The toggle interlock system can receive one or two padlocks with diameters of 0.19–0.31 in. (5–8 mm). Both interlocked circuit breakers must be unit-mount or both plug-in. Two sliding interlocking bars can be used to interlock three circuit breakers installed side-by-side, in which case one circuit breaker is in the ON (I) position and the two others in the OFF (O) position. (Kit S29354, not available for two-pole HD and HG devices.)

## Interlocking of Two Devices with Rotary Handles

Interlocking involves padlocking the rotary handles on two devices which may be either circuit breakers or automatic switches.

Authorized positions:

- one device closed (ON), the other open (OFF)
- both devices open (OFF).

The system is locked using up to three padlocks (shackle diameter 0.19–0.31 in. [5 to 8 mm]).

There are two interlocking-system models:

- one for PowerPacT H- and J-frame circuit breakers
- one for PowerPacT L-frame circuit breakers

All rotary-handle unit-mount or plug-in PowerPacT H-, J-, and L-frame circuit breakers and automatic switches of the same frame size can be interlocked. The devices must be either all unit-mount or all plug-in versions. Interlocking is not available for I-Line constructions.

The rotary handles are padlocked with the devices in the OFF (I) position. The interlock mechanism inhibits the two devices from being closed (ON/I) at the same time, but allows for both devices to be open (OFF/O) simultaneously. (Kit S29369. Not available for two-pole HD and HG devices.)

### Interlocking Accessories

Accessory	Means	Kit Number	
		H-, J-Frame	L-Frame
Interlocking (UL Listed)	Mechanical for circuit breakers with rotary handles <sup>176</sup>	S29369	S32621
	Mechanical for circuit breakers with toggles <sup>176</sup>	S29354	S32614

<sup>176</sup>. Not available in HD or HG two-pole modules.

## Interlocking Devices using Keylocks (Captive Keys)

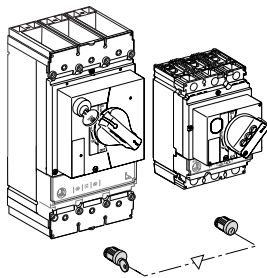

Interlocking with Keys

Interlocking using keylocks makes it possible to interlock two or more devices that are physically distant or that have very different characteristics, for example medium-voltage and low-voltage devices or a PowerPacT H-, J-, and L-frame circuit breaker and automatic switch.

Each device is equipped with an identical keylock and the key is captive on the closed (ON) device. A single key is available for all devices. It is necessary to first open (OFF position) the device with the key before the key can be withdrawn and used to close another device.

All rotary-handle PowerPacT H-, J-, and L-frame circuit breakers and automatic switches can be interlocked between each other or with any other device equipped with the same type of keylock.

For circuit breakers equipped with rotary handles or a motor operator. Interlocking with keys may be easily implemented by equipping each of the circuit breakers, either unit-mount or drawout, with a directly mounted rotary operating handle and a standard keylock, with only one key for the two keylocks. This solution enables interlocking between two circuit breakers that are geographically distant or that have significantly different characteristics.

Use:

- A keylock adapter (one required for each circuit breaker)
- Two identical keylocks with a single key

See *Rotary Operating Handles*, page 160 for more information.

## Sealing Accessory

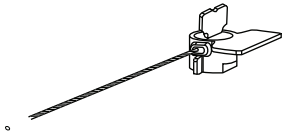

The sealing accessory kits includes the elements required to fit seals to prevent:

- Front accessory cover removal
- Rotary handle removal
- Opening of the motor operator
- Access to accessories
- Access to trip unit settings
- Access to ground-fault protection settings
- Trip unit removal
- Terminal cover removal
- Access to power connections

### Sealing Accessory Kits

Description	Kit Number	Qty.
Trip Unit Sealing Accessory Kit	MICROTUSEAL	6
Front Cover Screws Sealing Accessory Kit	S29375	6

## Front-Panel Escutcheons

- For unit-mount or plug-in installation
- Front-panel escutcheons for toggle handles secure to the panel from the front.
- Front-panel escutcheons for motor-operated or rotary-operating handles secure to the panel by four screws from the front.

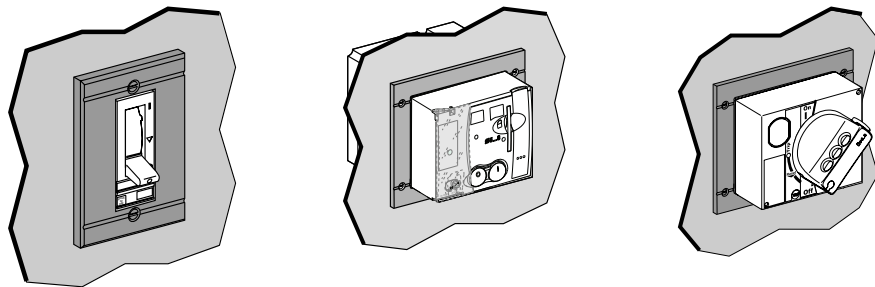

### Front-Panel Escutcheons

Description	Kit Number	
	H-, J-Frame	L-Frame
Front Panel Escutcheon for Toggle Circuit Breakers	S29315	32556
Front Panel Escutcheon for Rotary Handle, Motor Operator or Extended Escutcheon	S29317	S32558



## Toggle Collars (For Drawout Mounting)

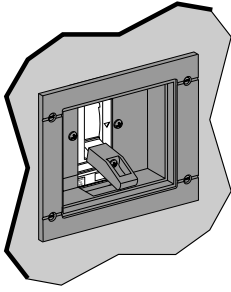

Toggle collars make it possible to maintain degrees of protection regardless of the circuit breaker position (connected, disconnected):

- Front panel escutcheons are required (identical to those for rotary handle and ammeter module).
- Toggle collars are secured by two screws on the circuit breaker.
- Front panel escutcheons are secured on the enclosure.
- Toggle extension is supplied with the toggle collar.

Front panel escutcheons for motor operator and rotary operating handles are the same as for the unit-mount circuit breakers.

### Toggle Collars

Description	Kit Numbers	
	H-, J-Frame	L-Frame
Toggle Collar	S29284	S32534

## Toggle Boot

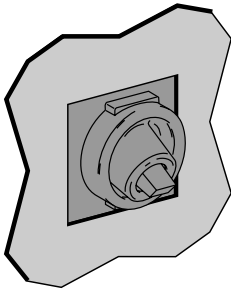

- NEMA 1, 2, 3, 3R protection
- Fits on front of circuit breaker

### Toggle Boot

Description	Kit Numbers	
	H-, J-Frame <sup>177</sup>	L-Frame
Toggle Boot	S29319	S32560

177. Not available for HD and HG two-pole modules.

# Handle Extension

Designed to extend the circuit breaker handle for easier manual circuit breaker operation.

## Handle Extension

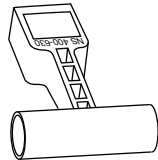

T-Handle Extension

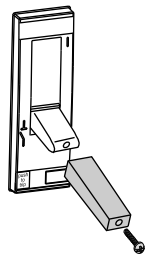

Toggle Extension

Description	Qty.	Kit Numbers	
		H-, J-Frame	L-Frame
T-Handle Extension (Temporary)	1	—	32595
Toggle Extension (Fixed)	5	S29313	S432553

## Visi-Trip Handle



Visi-Trip Handle H/J Frame



Visi-Trip Handle L Frame

Description	Qty.	Kit Number
Visi-Trip Handle H/J Frame	1	VTRIPHJ
Visi-Trip Handle L Frame	1	VTRIPL

# Circuit Breaker Enclosures and Enclosure Accessories

- Square D brand circuit breaker enclosures are UL Listed/CSA Certified and are suitable for use as service entrance equipment, except as footnoted.
- The short-circuit rating of an enclosed circuit breaker is equal to the rating of the circuit breaker installed, except as footnoted.
- Circuit breakers are ordered and shipped separately for field installation.

**Minimum Enclosure Dimensions**

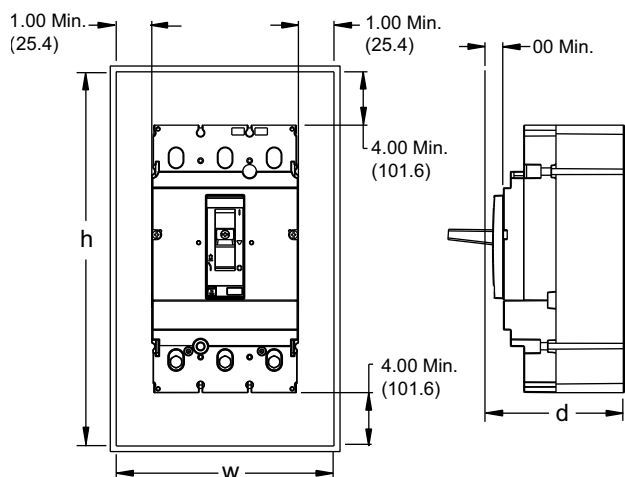

Circuit Breaker	Amperage	Enclosure Dimensions (h x w x d)	
		Standard (80%)	100% Rated
HD/HG/HJ/HL	15–150 A	15.6 x 6.12 x 3.49 in. (396 x 155 x 89 mm)	15.6 x 6.12 x 3.49 in. (396 x 155 x 89 mm)
HR		18.13 x 8.63 x 4.13 in. (461 x 219 x 105 mm)	62 x 22.5 x 14 in. (1575 x 572 x 356 mm)
JD/JG/JJ/JL <sup>178</sup>	150–250 A	18.72 x 6.12 x 3.49 in. (476 x 155 x 89 mm)	18.72 x 6.12 x 3.49 in. (476 x 155 x 89 mm)
JR		28.5 x 12.38 x 5.38 in. (724 x 314 x 137 mm)	62 x 22.5 x 14 in. (1575 x 572 x 356 mm)
LD/LG/LJ/LL	250–600 A	35.48 x 12.00 x 4.45 in. (901 x 305 x 113 mm)	35.48 x 12.00 x 4.45 in. (901 x 305 x 113 mm)
LR		40.5 x 13.75 x 4.33 in. (1030 x 350 x 110 mm)	40.5 x 13.75 x 4.33 in. (1030 x 350 x 110 mm)

**Circuit Breaker Enclosure Catalog Numbers**

Circuit Breaker			Enclosure Cat. No.				
Cat. No. Prefix	Rating	Poles	NEMA 1 Flush	NEMA 1 Surface	NEMA 3R <sup>179</sup>	NEMA 4, 4X, 5, 3, 3R Stainless Steel	NEMA 12/3R, 5 (Without Knockouts) <sup>180</sup>
HDL,HGL,HJL,HLL	15–150 A	2, 3	J250F	J250S	J250R	J250DS	J250AWK
JDL,JGL,JJL,JLL	150–250 A	2, 3					
HDL	15–100 A	3	—	HD100S <sup>181, 182, 183</sup>	—	—	—
JDL	150–250 A	3	—	JD250S <sup>181, 183, 184</sup>	—	—	—

178. Minimum enclosure insulation required if circuit breaker side < 4.13 in. (105 mm) from metal.  
 179. Enclosures with NRB or RB suffix have provisions for 3/4 in. through 2-1/2 in. bolt-on hubs in top endwall. Enclosures with R suffix have blank endwalls and require field cut opening.  
 180. Suitable for rainproof NEMA 3R application by removing drain screw from bottom endwall.  
 181. Copper wire only.  
 182. Maximum short-circuit current rating is 25 kA, 240 Vac  
 183. Order service ground kit PKOGTA2 if required.  
 184. Maximum short-circuit current rating is 18 kA, 480 Vac.

## Dimensions

Cat. No.	Approximate Dimension						
	Series	H		W		D	
HD100S	A01	17.00 in.	431.8 mm	7.90 in.	200.7 mm	4.75 in.	120.7 mm
J250F	A01	32.40 in.	823 mm	15.40 in.	391 mm	6.00 in.	152 mm
J250S	A01	31.36 in.	797 mm	14.36 in.	365 mm	6.00 in.	152 mm
J250R	A01	31.05 in.	789 mm	14.47 in.	368 mm	6.28 in.	160 mm
J250DS	A01	32.26 in.	819 mm	9.72 in.	247 mm	7.94 in.	202 mm
J250AWK	A01	32.26 in.	819 mm	9.72 in.	247 mm	7.94 in.	202 mm

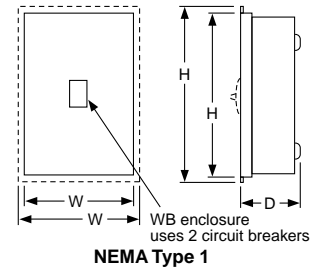

## Insulated Grounded Neutral Assembly

Circuit Breaker		Neutral Assembly For Use With		Terminal Lug Data— Total Available (Line plus Load) AWG/kcmil
Cat. No. Prefix	Ampere Rating	NEMA 1 & 3R Cat. No.	NEMA 4, 4X, 5, 12 & 12K Cat. No.	
HDL, HGL, HJL, HLL	15–100 A	SN100FA	SN100FA	(4) 14–1/0 Cu or (4) 12–1/0 Al
HDL, HGL, HJL, HLL	125–150 A	SN400LA	SN400LA	(2) 1–600 or (4) 1–250 Al/Cu, plus (2) 4–300 Al/Cu
JDL, JGL, JJL, JLL	150–250 A	SN400LA	SN400LA	(2) 1–600 or (4) 1–250 Al/Cu, plus (2) 4–300 Al/Cu

## Service Ground Kits

Circuit Breaker Cat. No. Prefix	Ground Bar Cat. No.	Number of Terminals	Conductors Per Terminal	Wire Range
HDL, HGL, HJL, HLL, JDL, JGL, JJL, JLL	PKOGTJ250	2	1	6 AWG–300 kcmil Al/Cu

# Circuit Breaker Mounting and Connections

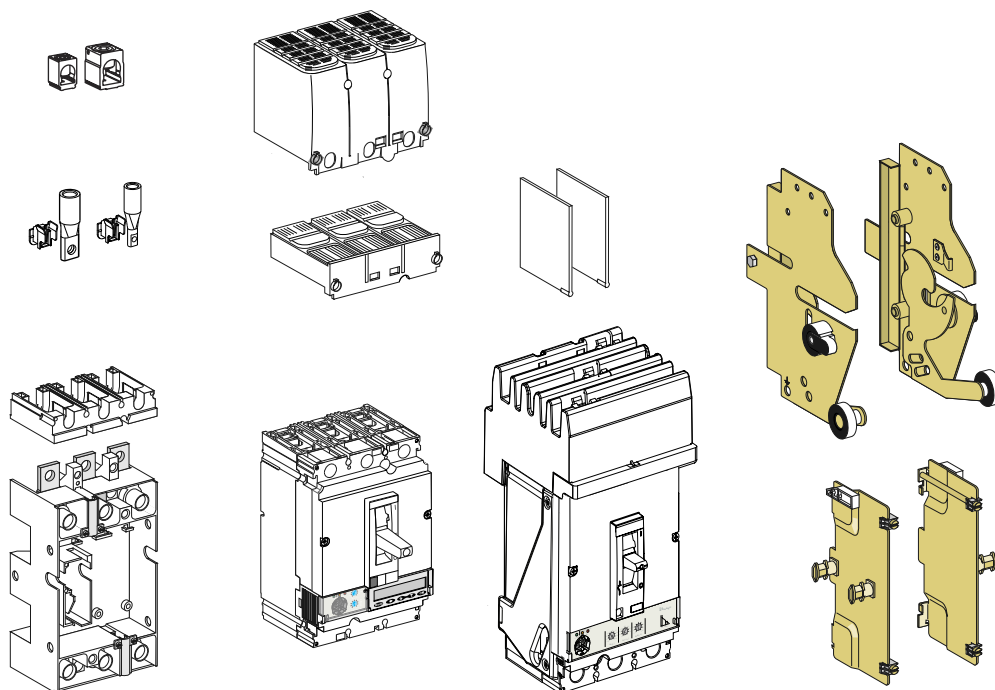

## Mounting Configurations

The PowerPacT H-, J-, and L-frame circuit breakers are available in a variety of configurations.

### Circuit Breaker Catalog Number

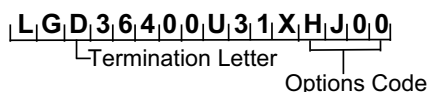

**NOTE:** See the table below for Termination Letter and Options Code.

### Mounting Options

Termination Letter	Poles		Options Code Suffix
	H-, J-Frame	L-Frame	
A = I-Line	3 Pole Only	3 Pole Only	For factory-installed terminations, place the termination letter in the third block of the circuit breaker catalog number. See the figure above for circuit breaker catalog number.  (N and D Terminations Only) H = Plug-In or Drawout J = No Stationary Part 0 = No Switches 0 = No Shutters
F = Bus Bar	3 Pole Only	3 or 4 Pole	
L = Lugs on Both Ends	3 Pole Only	3 or 4 Pole	
M = Lugs ON End	3 Pole Only	3 or 4 Pole	
P = Lugs OFF End	3 Pole Only	3 or 4 Pole	
N = Plug-In	3 Pole Only	3 or 4 Pole	
D = Drawout	3 Pole Only	3 or 4 Pole	
S = Rear Connection	3 Pole Only	3 or 4 Pole	

Refer to circuit breaker installation bulletin before installing circuit breaker, accessories, or wiring.

## Unit-Mount Circuit Breakers

The standard lugs can be removed for the installation of compression-type lugs or bus connections. All lugs are UL Listed/CSA Certified for their proper application and marked for use with aluminum and copper (Al/Cu) or copper only (Cu) conductors. Lugs suitable for copper and aluminum conductors are made of tin-plated aluminum.

## Mounting

H-, J-, and L-frame circuit breakers may be mounted vertically, horizontally or flat on their back without any derating of characteristics.

Unit-mount H- and J-frame circuit breakers are supplied with two mounting screws, unit-mount L-frame circuit breakers are supplied with four mounting screws. These mounting screws are inserted through mounting holes molded into the circuit breaker case and threaded into the mounting enclosure, rails or through the panel door for flush mounting.

A DIN rail mounting bracket (catalog no. S29305) is available for the H- and J-frame circuit breakers.

**NOTE:** DIN rail mounting is not compatible with motor operated applications.

### Unit-Mounting Options

#### H-, J-Frame Circuit Breakers (Two Mounting Screws)

Mounting on Rails

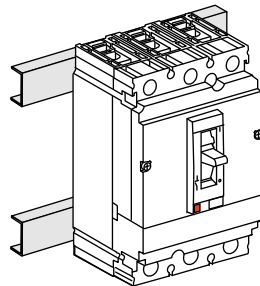

Mounting on Backplate

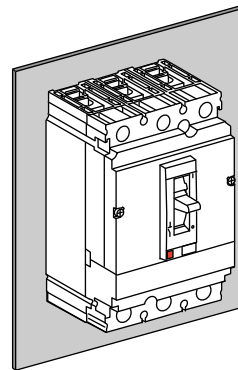

Flush Mounting

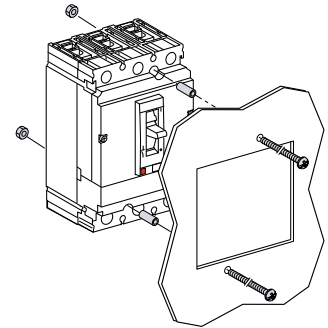

#### L-Frame Circuit Breakers (Four Mounting Screws)

Mounting on Rails

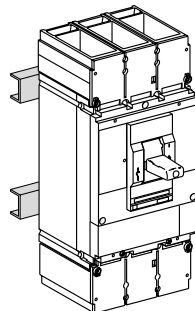

Mounting on Backplate

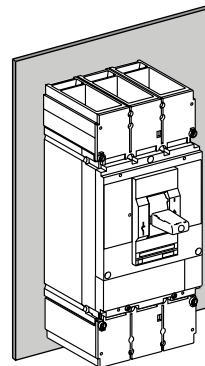

Flush Mounting

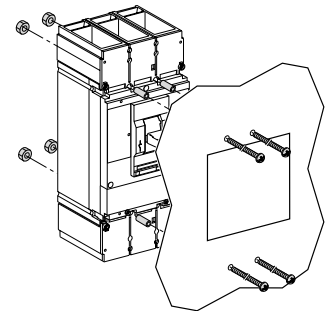

## I-Line Circuit Breakers

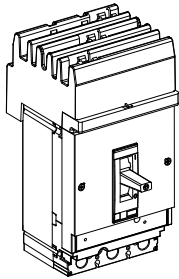

PowerPacT H-, J-, and L-frame circuit breakers are available in I-Line construction for easy installation and removal in I-Line applications.

I-Line circuit breakers use “blow-on” type line side connectors. In case of a short circuit, increased magnetic flux causes the plug-on connectors of the circuit breaker to tighten their grasp on the bus bars. The I-Line connectors and circuit breaker mounting bracket are integral parts of I-Line circuit breakers and cannot be removed or replaced. I-Line circuit breakers come with mechanical load side lugs, or optional terminal nut to connect to bus bars or to compression (crimp) lugs.

### Phase Options—Example HDA36150

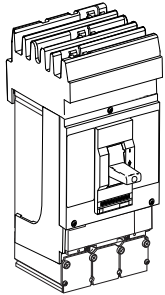

Phase Option Number	Phase Connection	Two-Pole Example	Three-pole Example
1	AB	HDA261501	—
2	AC	HDA261502	—
3	BA	HDA261503	—
4	BC	HDA261504	—
5	CA	HDA261505	—
6	CB	HDA261506	—
Standard	ABC	—	HDA36150
6	CBA	—	HDA361506

## Plug-In Circuit Breaker Mounting

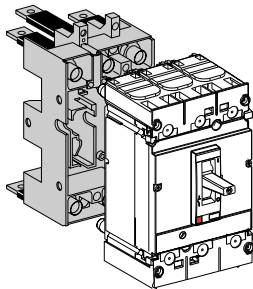

Plug-In Mounting

The plug-in base is mounted through a panel. The plug-in configuration makes it possible to:

- Extract and/or rapidly replace the circuit breaker without having to touch connections
- Allow for addition of future circuits at a later date

When the circuit breaker is in the connected position, the primary voltage is fed through the circuit breaker by means of multiple finger disconnects. Control voltage of internal accessories is provided through secondary disconnects.

## Parts of a Plug-In Configuration

- **Plug-in Base:** The plug-in base provides mounting through a front panel or mounting on rails.
- **Disconnects:** Provides both primary and secondary disconnect to the circuit breaker.
- **Safety Trip Interlock:** The safety trip causes automatic tripping if the circuit breaker is ON before engaging or withdrawing it; the safety trip does not prevent the circuit breaker operation, even when the circuit breaker is disconnected.
- **Mandatory short terminal shields.**

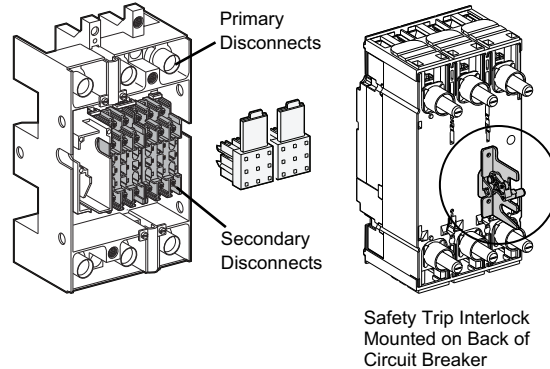

Accessory circuits exit the circuit breaker using one to three secondary disconnecting blocks (nine wires each). Circuit breaker connection wires for the options installed with trip unit STR53UP exit through the automatic secondary disconnecting blocks. These are made up of:

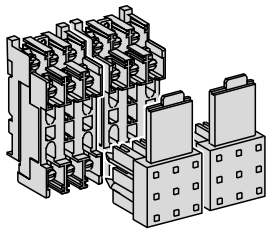

Disconnecting Blocks

- A moving part connected to the circuit breaker through a support (one support per circuit breaker)
- A fixed part mounted on the plug-in base, equipped with connectors for wire up to 14 AWG (2.5 mm<sup>2</sup>)

For test purposes, circuit breakers may be equipped with one to three manual auxiliary connectors, which allow the auxiliaries to remain connected when in the “disconnected” position.

### Plug-In Base (Mounting Options)

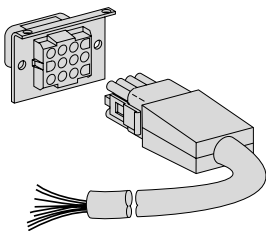

Manual Auxiliary Connector

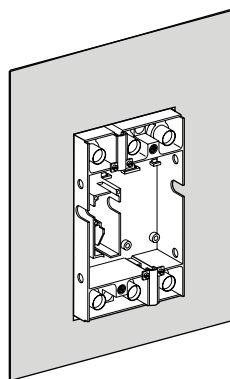

Mounting Through a Panel

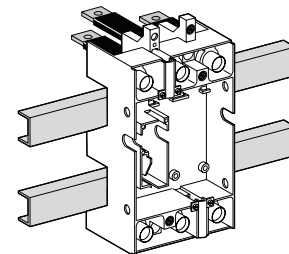

Mounting on Rails

The L-frame plug-in mounting is Listed under UL file E113555 and Certified under CSA file LR 69561.



## Drawout Mounting

The cradle is made up of two side plates installed on the plug-in base and two other plates mounted on the circuit breaker.

The drawout mounting provides all of the functions of the plug-in base, plus:

- Disconnected position—the power circuit is disconnected, the circuit breaker is simply withdrawn and may still be operated (on, off, push-to-trip)
- Circuit breaker may be locked using 1 to 3 padlocks, diameter 0.19 to 0.31 inch (5–8 mm), to prevent connection.
- Auxiliaries can be tested using manual auxiliary connector.

Drawout mounting is on a backplate:

- Through a front panel or on rails
- Horizontally or vertically

Accessories for drawout circuit breakers:

- *Auxiliary contacts indicator* for installation on the fixed part of the cradle, indicating the “connected” and “disconnected” position
- *Toggle collar* for circuit breakers with toggle through front panel, intended to maintain the degree of protections whatever the position of the circuit breakers (supplied with a toggle extension)
- *Keylock* which can be used to
  - Prevent insertion for connection
  - Lock the circuit breaker in the connected or disconnected position
- *Telescopic shaft* for extended rotary handles
- *Control voltage*, which is provided through automatic secondary disconnect in the connected position only. Electrical accessories can be tested in the disconnected position with an external wiring harness.

The drawout-mounted cradle is listed under UL file E113555 and certified under CSA file LR69561.

### Drawout Mounting Positions

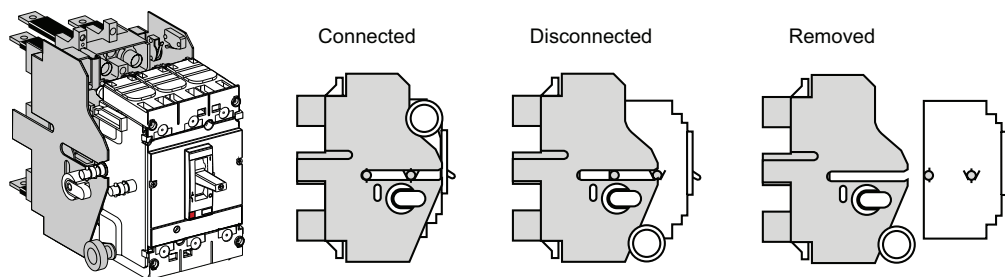

### Plug-In and Drawout Mountings for H- and J-Frame Circuit Breakers (Three-Pole or Two-Pole in a Three-Pole Module)

Description		Factory Installed Suffix	Field Installed Cat. No.		
Complete Factory-Assembled Circuit Breakers	Plug-in base shipped with circuit breaker	N	—		
	Drawout cradle shipped with circuit breaker	D	—		
Special Order Options for Plug-In and Drawout Circuit Breakers	Plug-In Base	Circuit breaker only	HJ00		
		Plug-in base kit	—	S29278	
	Drawout Cradle	Circuit breaker only	HJ00	—	
		Plug-in base kit	—	S29278	
		Cradle side plates (fixed part of chassis)	—	S29282	
		Circuit breaker side plates (moving part of chassis)	—	S29283	
Accessories for Plug-In and Drawout	H-Frame Shutter Kit (set of two)		—	S37442	
	J-Frame Shutter Kit (set of two)		—	S37443	
	Secondary Disconnect Blocks	Fixed part 9-wire connector (mounted on base)		—	S29273
		Moving part 9-wire connector (mounted on circuit breaker)		—	S29274
		Support for 2-moving connectors		—	S29275
	Extended escutcheon with extended toggle collar		—	S29284	
	Two position indicating switches (connected/disconnected)		—	S29287	
	H-Frame Short Terminal Covers (Three-Pole)		—	S37436	
	J-Frame Short Terminal Covers (Three-Pole)		—	S37440	

### Plug-In and Drawout Mountings for L-Frame Circuit Breakers

Description		Poles	Plug-in Mounting			Drawout Mounting		
			Factory-Installed Suffix	Field-Installed		Factory-Installed Suffix	Field Installed	
				Qty.	Kit No.		Qty.	Kit No.
Kit (stationary and moving parts)		3	N		—	D		—
		4	N		—	D		—
Stationary Part	Plug-in base	3	—		S32514	—		S32514
		4	—		S32515	—		S32515
	Fixed part of chassis	—	—		—	—		S32532
Moving Part	Circuit breaker only	—	HJ00		—	HJ00		—
	Moving part of chassis	—	—		—	—		S32533
	Short terminal covers	3	—	2 <sup>185</sup>	S32562	—	2 <sup>185</sup>	S32562
4		—	2 <sup>185</sup>	S32563	—	2 <sup>185</sup>	S32563	

185. Order two kits.

**Plug-In and Drawout Accessories**

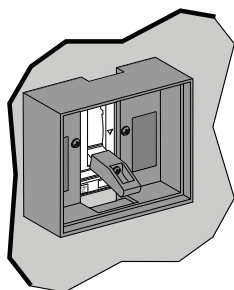

Handle Escutcheon

Plug-In and Drawout Accessories			Factory-Installed Kit No.			
			Qty.	H-, J-Frame	Qty.	L-Frame
Secondary Disconnecting Blocks <sup>186</sup>	Fixed Part	9-Wire Connector		S29273		S29273
	Moving Part	9-Wire Connector		S29274		S32523
		Support for Moving Connectors	2 <sup>187</sup>	S29275	3 <sup>188</sup>	S32525
Manual Auxiliary Connector	9-Wire Connector for Disconnected Operation			—		S29272
Shutter	Two Shutters for Plug-In Base			29271		32521
Classic Accessories	Extended Escutcheon for Toggle Collar			S29284		S32534
	Locking Device (Key Lock is Not Included)			S29286		S29286
	Two Position Indicator Contacts (Connected/Disconnected)			S29287		S29287

186. Included when electrical accessories are factory installed.

187. Order two kits.

188. Order three kits.

## Connection

### Rear Connection

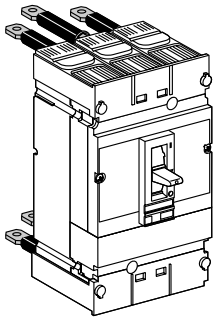

For connection of bus bars or cables with compression lugs. Rear connections are easily installed on the circuit breaker terminals. The same connection may be installed flat, edgewise or at a 45° angle. All combinations are possible. The circuit breaker is mounted on a backplate.

One Long and Two Short

Four Positions Possible for Each Connector

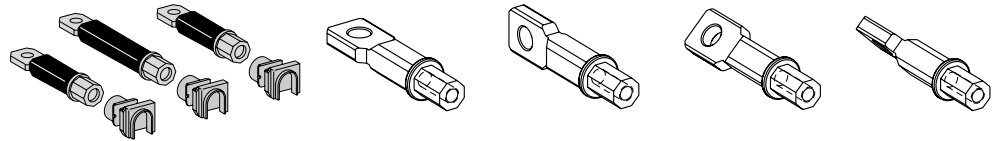

### Rear Connections

Device	Description	H-Frame				J-Frame				L-Frame			
		Poles	Factory Installed Termination No.	Qty.	Field-Installable Cat. No.	Poles	Factory Installed Termination No.	Qty.	Field-Installed Cat. No.	Poles	Factory Installed Termination No.	Qty.	Field-Installed Cat. No.
Mixed Rear Connection Kit <sup>189</sup>		2	S		—	2	S		—	3	S		S32477
		3	S		S37432	3	S		S37437	4	S		S32478
Consisting of:	Short rear connections (set of 2)	2 or 3	—	<sup>2</sup> 190	S37433	2 or 3	—	<sup>2</sup> 191	S37438	3	—	<sup>2</sup> 192 <sup>193</sup>	S432475
	Long rear connections (set of 2)		—		S37434	—		S37439 <sup>194</sup>	—		<sup>2</sup> 195	S432476	
	Short terminal cover	3	—		S37436	3	—		S37400	3	—	<sup>2</sup> 196	S32562
	Short terminal cover	4	—		—	—	—		—	4	—	<sup>2</sup> 196	S32563

### L-Frame Rear Connection Hardware

Description	Catalog No.
Set of 4 M10 x 25 terminal screws and washers for one side.	S36967

189. Kit contains four short rear connections, two long rear connections (four long rear connections for four-pole), hardware and two terminal covers.

190. Order two kits (two in kit x two kits for total of four).

192. Order two kits (two in kit x two kits for total of four).

193. Parts only. No hardware is included.

194. For use with three-pole circuit breakers only.

195. Parts only. No hardware is included.

196. Order two kits (kit contains only one terminal cover, two terminal covers are required per circuit breaker).

## Mechanical Lugs

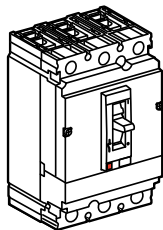

Unit-mount H-, J-, and L-frame circuit breakers can be ordered with mechanical line and load side lugs. The standard lugs can be removed for the installation of compression-type lugs or bus connections. All lugs are UL Listed/CSA Certified for their proper application and marked for use with aluminum and copper (Al/Cu) or copper only (Cu) conductors. Lugs suitable for copper and aluminum conductors are made of tin-plated aluminum. Lugs suitable for use with copper conductors only are made of copper.

Mechanical Lugs for the H- and J-frame circuit breakers lay on top of the circuit breaker terminals and can be installed without the use of any tools. The lugs are held in place with snap features built into the insulating retainer and are secured with the clamp force applied to the wire binding screw.

Mechanical lugs are sold either factory installed or as field installable kits.

### Mechanical Lug Kits for H-Frame and J-Frame Circuit Breakers

	Circuit Breaker Application				Number of Wires Per Lug and Wire Range	Kit Cat. No.	Qty.
	Standard	Ampere Rating	Optional	Ampere Rating			
Al Lugs for Use with Al or Cu Wire	HD, HG, HJ, HL	15–150 A			(1) 14–3/0 AWG Al or Cu	AL150HD	3
	JD, JG, JJ, JL	150–175 A			(1) 4–4/0 AWG Al or Cu	AL175JD	3
	JD, JG, JJ, JL	200–250 A	JD, JG, JJ, JL	150–175 A	(1) 3/0–350 kcmil Al or Cu	AL250JD	3
Cu Lugs for Use with Cu Wire Only			HD, HG, HJ, HL	15–150 A	(1) 14–2/0 AWG Cu	CU150HD	3
			JD, JG, JJ, JL	150–250 A	(1) 1/0–300 kcmil Cu	CU250JD	3
Control Wire Terminal for H-frame lug kit						S37423	2
Control Wire Terminal for J-frame lug kit						S37424	2

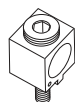

400 A Lug  
AL400L61K3

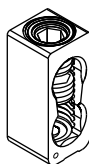

600 A Lug  
AL600LF52K3

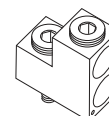

600 A Lug  
AL600LS52K3

### Mechanical Lug Kits for L-Frame Circuit Breakers

	Circuit Breaker Application				Number of Wires Per Lug and Wire Range <sup>197</sup>	Kit Cat. No. <sup>198</sup>	Qty Per Kit	Type of Terminal Shield <sup>199</sup>
	Ampere Rating	Poles	Unit Mount	I-Line				
Al Lugs for Use with Al or Cu Wire	250	3	X	X	(1) 2 AWG–500 kcmil Al (1) 2 AWG–600 kcmil Cu	AL400L61K3	3	Short
		4	X	—		AL400L61K4	4	Medium
	400/600	3	X	—	(2) 2/0 AWG–500 kcmil Al or Cu	AL600LS52K3 <sup>200</sup>	3	Medium
		4	X	—		AL600LS52K4 <sup>200</sup>	4	Medium

197. For control wire installation, use an 8-32 x 1/4 in. screw (not provided) into tapped control wire hole in lower left hand corner of lug.

198. For lug pack information, see .

199. For terminal shield dimensions, see PowerPacT L-Frame Fixed Mounted Circuit Breaker, page 222.

200. Terminal shields are included in mechanical lug kits.

## Mechanical Lug Kits for L-Frame Circuit Breakers (Continued)

	Circuit Breaker Application				Number of Wires Per Lug and Wire Range <sup>201</sup>	Kit Cat. No. <sup>202</sup>	Qty Per Kit	Type of Terminal Shield <sup>203</sup>
	Ampere Rating	Poles	Unit Mount	I-Line				
	400/600	3	X	X	(2) 3/0 AWG–500 kcmil Al or Cu	AL600LF52K3 <sup>201</sup>	3	Short
Cu Lugs for Use with Cu Wire Only	250/400	3	X	X	(1) 2 AWG–500 kcmil Al (1) 2 AWG–600 kcmil Cu	CU400L61K3	3	Short
		4	X	—		CU400L61K4	4	Medium
	400/600	3	X	—	(2) 2/0 AWG–500 kcmil Al or Cu	CU600LS52K3 <sup>201</sup>	3	Medium
		4	X	—		CU600LS52K4 <sup>201</sup>	4	Medium
	400/600	3	X	X	(2) 3/0 AWG–500 kcmil Al or Cu	CU600LF52K3 <sup>201</sup>	3	Short

## Voltage Takeoff (Control Wire Terminals) for Mechanical Lugs and Terminal Nuts

Mechanical Lug Control Wire Terminal

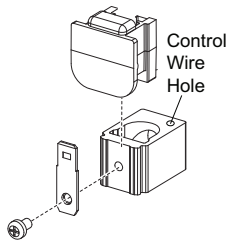

Busbar Control Wire Terminal

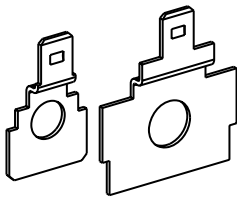

PowerPacT H- and J-Frame mechanical lugs may be equipped with a separate control wire termination. The kit is available factory installed or as a field installable kit. The adaptor is secured underneath the lug and has a tab extension suitable for attachment of a 0.250 inch slip-on connector.

All L-frame mechanical lugs are pre-tapped for control wires. For control wire installation, use an 8–32 x 1/4 in. screw (not provided) into tapped control wire hole in lower left hand corner of the lug.

Fully insulated type connectors must be used to prevent live parts from extending into the wiring gutter area.

### Control Wire Terminals

Description	Frame	Cat. No.	Qty. Per Kit
<b>Mechanical Lugs</b>			
Control Wire Terminal for H-Frame Lugs	HD/HG/HJ/HL	S37423	2
Control Wire Terminal for J-Frame Lugs	JD/JG/JJ/JL	S37424	2
<b>Busbar Connection</b>			
Control Wire Terminal for H-Frame Terminal Nut	HD/HG/HJ/HL	S37429	2
Control Wire Terminal for J-Frame Terminal Nut	JD/JG/JJ/JL	S37430	2

201. For control wire installation, use an 8-32 x 1/4 in. screw (not provided) into tapped control wire hole in lower left hand corner of lug.

202. For lug pack information, see .

203. For terminal shield dimensions, see PowerPacT L-Frame Fixed Mounted Circuit Breaker, page 222.

201. Terminal shields are included in mechanical lug kits.

## Bus-Bar Connections

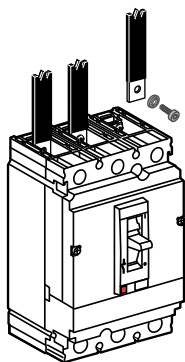

The H-, J- and L-frame circuit breakers may be equipped with captive nuts and screws for direct connection to bars or to compression (crimp) lugs.

For H- and J-frame, these are readily field-installable, simply by removing the mechanical lug and replacing with the appropriate terminal nut inset described in Factory-Installed Terminal Nut Inserts for Bus or Crimp Lug Connection, page 185. They are also available factory-installed, using the Product Selector or by using the catalog suffixes below.

For L-frame, the mechanical lug can be removed, leaving the threaded nut insert intact. This configuration may be ordered with the suffixes described below. Connection hardware (terminal screws) must be ordered as in Factory-Installed Terminal Nut Inserts for Bus or Crimp Lug Connection, page 185.

### Factory-Installed Terminal Nut Inserts for Bus or Crimp Lug Connection

Cat. No. Termination (Position 4)	Special Terminations Options	Description
F	—	Terminal nut insert on both ends; no lugs either end
M	—	Terminal nut insert on OFF end; lugs on ON end only
P	—	Terminal nut insert on ON end; lugs on OFF end only
A	-TA	I-Line on ON end; English terminal nuts on OFF end <sup>202</sup>
A	-TB	I-Line on ON end; Metric terminal nuts on OFF end <sup>202</sup>
F, M, or P	-TW	For -F, Metric terminal nuts on both ends <sup>202</sup>
F, M, or P	-TX	For -M, lugs on ON end; Metric terminal nuts on OFF end For -P, Metric terminal nuts on ON end; lugs on OFF end

### Terminal Nuts for Bus Bar Connection of H-Frame and J-Frame Circuit Breakers

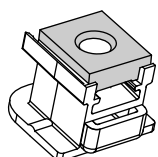

Terminal Nut Insert



Description	Frame	Tap	Cat. No.	Qty. Per Kit	Torque
H-Frame Terminal Nut Insert–English	HD/HG/HJ/HL	1/4/2020	S37425	2	80–90 lb-in. (9–10.2 N•m)
H-Frame Terminal Nut Insert–English	HD/HG/HJ/HL	1/4/2020	S37444	3	
H-Frame Terminal Nut Insert–Metric	HD/HG/HJ/HL	M6	S37426	2	
J-Frame Terminal Nut Insert–English	JD/JG/JJ/JL	1/4/2020	S37427	2	80–90 lb-in. (9–10.2 N•m)
J-Frame Terminal Nut Insert–English	JD/JG/JJ/JL	1/4/2020	S37445	3	
J-Frame Terminal Nut Insert–Metric	JD/JG/JJ/JL	M8	S37428	2	

202. For H- and J-frame only. L-frame terminal nuts are metric only.

## Bar Dimensions

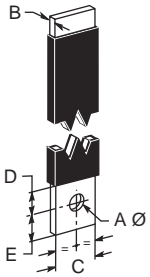

Dimension	H-Frame	J-Frame	L-Frame
A	0.250 in. (6.4 mm)	0.3125 in. (7.9 mm)	0.4 in. (10.2 mm)
B	0.125–0.375 in. (3.2–9.5 mm)	0.125–0.375 in. (3.2–9.5 mm)	0.11–0.39 in. (2.8–9.9 mm)
C	0.50 in. (12.7 mm)	0.50–0.75 in. (12.7–19.0 mm)	1.35 in. (34.3 mm)
D	0.3 in. (7.6 mm)	0.625 in. (15.9 mm)	<0.51 in. (13 mm)
E	0.3 in. (7.6 mm)	0.375 in. (9.5 mm)	0.64 in. (16.3 mm)

### L-Frame Bus Bar Connections Hardware

Description	Cat. No.
Set of 4 M10 x 25 terminal screws and washers for one side.	S36967



## Power Distribution Connectors

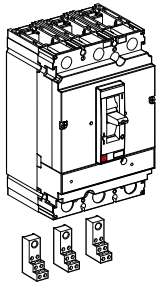

The power distribution connectors (PDC) can be used for multiple load wire connections on one circuit breaker. Use in place of standard distribution lug blocks to save space and time. Field installable kit includes tin-plated aluminum lug, connectors, and required mounting hardware.

- For use on load end of circuit breaker only
- For use in UL 508 Industrial Control applications
- For use in UL 1995/CSA C22.2 No. 236 heating and cooling equipment
- For copper wire only

### Power Distribution Connectors

Frame		Kit No.	Qty. per Kit	Wires per Terminal	Wire Range	Wire Binding Screw Torque	
H-Frame		PDC6HD6	3	6	8–6 AWG (10–16 mm <sup>2</sup> )	25 lb-in. (2.8 N•m)	
					14–10 AWG (2.5–6 mm <sup>2</sup> )	20 lb-in. (2.3 N•m)	
		PDC3HD2	3	3	2 AWG (35 mm <sup>2</sup> )	40 lb-in. (4.5 N•m)	
					14–3 AWG (2.5–35 mm <sup>2</sup> )	35 lb-in. (4.0 N•m)	
J-Frame		PDC6JD4	3	6	8–4 AWG (10–25 mm <sup>2</sup> )	35 lb-in. (4.0 N•m)	
					14–10 AWG (2.5–6 mm <sup>2</sup> )	20 lb-in. (2.3 N•m)	
		PDC3JD20	3	3 total		14–6 AWG Cu (2.5–16 mm <sup>2</sup> ) or 4–1 AWG Cu (25–50 mm <sup>2</sup> )	35 lb-in. (4.0 N•m)
				2		40 lb-in. (4.5 N•m)	
and 1	3–2/0 AWG Cu (35–70 mm <sup>2</sup> )	50 lb-in. (5.6 N•m)					
L-Frame		PDC5DG20L3 <sup>203</sup>	3	5 total		4–1 AWG (25–50 mm <sup>2</sup> ) or 14–6 AWG (2.5–16 mm <sup>2</sup> )	40 lb-in. (4.5 N•m)
				3		35 lb-in. (4.0 N•m)	
				and 2		3–2/0 AWG (35–70 mm <sup>2</sup> )	50 lb-in. (5.6 N•m)
		PDC12DG4L3 <sup>203</sup>	3	12	8–4 AWG (10–25 mm <sup>2</sup> )	35 lb-in. (4.0 N•m)	
					14–10 AWG (2.5–6 mm <sup>2</sup> )	20 lb-in. (2.3 N•m)	

See Terminal Shields, page 189 for the phase barriers for power distribution connectors.

203. Kit includes terminal shield.

## Compression Lugs

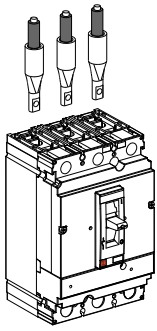

Both copper and aluminum compression lug kits are available for the H-, J-, and L-frame circuit breakers. Each kit contains required insulators and all mounting hardware. Compression lugs require the long lug cover pack, see [PowerPacT L-Frame Circuit Breakers](#), page 222.

### Compression Lug Kits for Al/Cu Connectors

Circuit Breaker	Lug Kit	Rating at 75°C		Poles	Wires per Lug	Wire Range	Lugs per Terminal	Lugs per Kit
		Al	Cu					
<b>Al/Cu Connectors</b>								
H-Frame	YA060HD	≤ 60 A	≤ 60 A	3	1	6–2 AWG Cu or Al (16–35 mm <sup>2</sup> )	1	3
	YA060HD	≤ 150 A	≤ 150 A	3	1	1/0–4/0 AWG Cu or Al (50–95 mm <sup>2</sup> )	1	3
J-Frame	YA150JD	≤ 200 A	≤ 200 A	3	1	1–3/0 AWG Cu or Al (50–95 mm <sup>2</sup> )	1	3
	YA250J35	≤ 250 A	≤ 250 A	3	1	3/0 AWG–350 kcmil Cu or Al (95–185 mm <sup>2</sup> )	1	3
L-Frame	YA400L31K3	230 A	285 A	3	1	4–300 kcmil Al/Cu (25–150 mm <sup>2</sup> )	1	3
	YA600L32K3	460 A	570 A	3	2	4–300 kcmil A/Cu (25–150 mm <sup>2</sup> )	2	6
	YA400L51K3	310 A	380 A	3	1	2/0–500 kcmil A/Cu (70–240 mm <sup>2</sup> )	1	3
	YA600L52K3	620 A	760 A	3	2	2/0–500 kcmil Al/Cu (70–240 mm <sup>2</sup> )	2	6
	YA400L71K3	385 A	380 A	3	1	500–750 kcmil Al (240–400 mm <sup>2</sup> ) 500 kcmil Cu (240 mm <sup>2</sup> )	1	3
	YA600L32K4	460 A	380 A	4	2	4–300 kcmil A/Cu (25–150 mm <sup>2</sup> )	1	8
	YA400L51K4	310 A	380 A	4	1	2/0–500 kcmil Al/Cu (70–240 mm <sup>2</sup> )	2	4
	YA600L52K4	620 A	760 A	4	2	2/0–500 kcmil Al/Cu (70–240 mm <sup>2</sup> )	1	8
	YA400L71K4	385 A	475 A	4	1	500–750 kcmil Al (240–400 mm <sup>2</sup> ) 500 kcmil Cu (240 mm <sup>2</sup> )	2	4

### Compression Lug Kits for Cu Connectors

Circuit Breaker	Lug Kit	Rating at 75°C		Poles	Wires per Lug	Wire Range	Lugs per Terminal	Lugs per Kit
		Al	Cu					
H-Frame	CYA060HD	—	≤ 60 A	3	1	6–1/0 AWG Cu	1	3

**Compression Lug Kits for Cu Connectors (Continued)**

						(16–50 mm <sup>2</sup> )		
	CYA150HD	—	≤ 150 A	3	1	4–2/0 AWG Cu (25–70 mm <sup>2</sup> )	1	3
J-Frame	CYA150JD	—	≤ 150 A	3	1	4–2/0 AWG Cu (25–70 mm <sup>2</sup> )	1	3
	CYA250J3	—	≤ 250 A	3	1	2/0 AWG–300 kcmil Cu (70–185 mm <sup>2</sup> )	1	3
L-Frame	CYA400L31K3	—	285 A	3	1	2/0–300 kcmil Cu (70–150 mm <sup>2</sup> )	1	3
	CYA600L32K3	—	570 A	3	2	2/0–300 kcmil Cu (70–150 mm <sup>2</sup> )	2	6
	CYA400L51K3	—	380 A	3	1	250–500 kcmil Cu (150–240 mm <sup>2</sup> )	1	3
	CYA600L52K3	—	760 A	3	2	250–500 kcmil Cu (150–240 mm <sup>2</sup> )	2	6
	CYA400L31K4	—	285 A	4	1	2/0–300 kcmil Cu (70–150 mm <sup>2</sup> )	1	4
	CYA600L32K4	—	570 A	4	2	2/0–300 kcmil Cu (70–150 mm <sup>2</sup> )	2	8
	CYA400L51K4	—	380 A	4	1	250–500 kcmil Cu (150–240 mm <sup>2</sup> )	1	4
	CYA600L52K4	—	760 A	4	2	250–500 kcmil Cu (150–240 mm <sup>2</sup> )	2	8

**Terminal Shields**

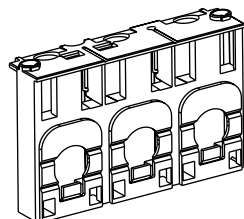

H-Frame Short Lug Shield

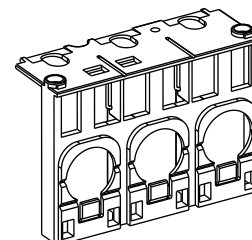

J-Frame Short Lug Shield

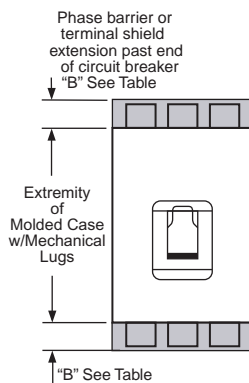

**Terminal Shields and Phase Barriers**

Used With	Description	Dim. B (in.)	Cat. No.	Qty. per Kit		
H- and J-Frame Mechanical Lugs	Frame	Max. Wire Size				
	H-Frame 60 A	3 AWG	0.50	S37446	1	
	H-Frame 150 A	3/0 AWG	0.50	S37447	1	
	J-Frame	350 kcmil	0.24	S37448	1	
H- and J-Frame Power Distribution Connectors and Compression Lugs	Compatible with:					
	PDC	Compression Lugs				
		Aluminum	Copper			
	H-Frame Long Lug Shield	PDC6HD6	YA060HD	CYA060HD	2.24	S37449
PDC3HD2		YA150HD	CYA150HD			1

**Terminal Shields and Phase Barriers (Continued)**

Used With	Description			Dim. B (in.)	Cat. No.	Qty. per Kit	
	J-Frame Long Lug Shield	PDC6JD4	YA150JD	CYA150JD	1.68	S37450	1
		PDC3JD2	—	CYA250J3			1

# Installation Recommendations

**NOTE:** A special 122°F (50°C) rating is available for special high ambient conditions (not UL listed). Order by adding CA suffix to catalog number.

## Operation Conditions

### Temperature Derating

- PowerPacT H-, J-, and L-frame circuit breakers may be used between -13°F and 158°F (-2°C and +70°C). For temperatures higher than 104°F (40°C) inside the enclosure, devices must be derated.
- Circuit breakers should be put into service under normal ambient, operating-temperature conditions.
- The permissible storage-temperature range for PowerPacT H-, J-, and L-frame circuit breakers in the original packing is -58°F<sup>204</sup> and 185°F (-50°C<sup>204</sup> and +85°C).

#### Temperature Derating for H-Frame Trip Unit Thermal Protection—Long-Time

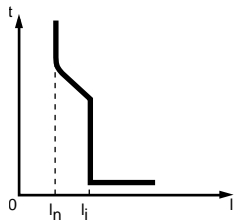

H-Frame Trip Curve

( $I_n$ ) Fixed threshold thermal protection against overload  
 ( $I_i$ ) **Fixed** threshold instantaneous protection against short circuits

Temp. <sup>205</sup>	Rating (A) In																		
	°F	°C	2-3	3-0	3-8	4-6	5-3	60	68	76	88	103	11-2	12-3	137	160	180	22-1	
14	-1-0																		
32	0		2-1	2-8	3-6	4-3	4-9	56	63	71	83	97	10-7	11-7	131	151	171	20-7	
50	10		2-0	2-6	3-3	4-0	4-6	52	59	66	77	90	10-1	111	126	141	161	19-4	
68	20		1-8	2-4	3-1	3-7	4-2	48	54	62	72	84	96	10-5	120	132	152	18-0	
86	30		1-7	2-2	2-8	3-4	3-9	44	50	56	66	77	88	98	110	121	139	16-5	
1-04	40		1-5	2-0	2-5	3-0	3-5	40	45	50	60	70	80	90	100	110	125	15-0	
1-22	50		1-2	1-7	2-1	2-5	3-0	34	38	43	53	62	72	80	86	95	109	13-1	
1-40	60		9	1-4	1-7	2-0	2-4	28	31	35	46	53	63	70	72	80	93	111	

204. -40°F (-40°C) for MicroLogic trip units with an LCD screen.

205. Shaded areas indicate temperature derated values, non-shaded areas inside an enclosure are standard circuit breaker ampere ratings at 104°F (40°C).

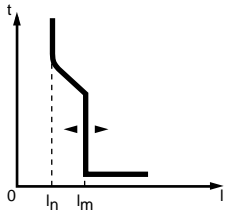

**J-Frame Trip Unit**

( $I_n$ ) Fixed threshold thermal protection against overload

( $I_m$ ) Adjustable instantaneous protection against short circuits

**Temperature Derating for J-Frame Trip Unit Thermal Protection—Long-Time**

Temperature <sup>206</sup>		Rating (A) $I_n$				
°F	°C					
14	-10	221	264	289	330	377
32	0	207	247	273	310	354
50	10	194	230	256	290	330
68	20	180	213	240	270	307
86	30	165	194	220	248	279
104	40	150	175	200	225	250
122	50	131	150	176	193	214
140	60	111	124	151	160	177

**PowerPacT H-, J- and L-Frame Circuit Breakers Equipped with Electronic Trip Units**

Electronic trip units are not affected by variations in temperature. If the trip units are used in high temperature environments, the MicroLogic trip unit setting must nevertheless take into account the temperature limits of the circuit breaker.

Changes in temperature do not affect measurements by electronic trip units.

- The built-in CT sensors with Rogowski coils measure the current.
- The control electronics compare the value of the current to the settings defined for 104°F (40°C).

Because temperature has no effect on the CT measurements, the tripping thresholds do not need to be modified.

However, the temperature rise caused by the flow of current combined with the ambient temperature increases the temperature of the device. To avoid reaching the thermal withstand value, it is necessary to limit the current flowing through the device, that is the maximum  $I_r$  setting as a function of the temperature.

The table below indicates the maximum long-time (LT) protection setting  $I_r$  (A) depending on the ambient temperature.

**Derating Circuit Breakers with MicroLogic Trip Units**

Type of Device	Rating	Temperature						
		104°F (40°C)	113°F (45°C)	122°F (50°C)	131°F (55°C)	140°F (60°C)	149°F (65°C)	158°F (70°C)
<b>H-Frame</b>								
Unit-mount, plug-in or drawout	60 A	No derating						
	100 A	No derating						
	150 A	No derating						
<b>J-Frame</b>								
Unit-mount	250 A	250	250	250	245	237	230	225
Plug-in or drawout	250 A	250	245	237	230	225	220	215
<b>L-Frame</b>								
Unit-mount	400 A	400	400	400	390	380	370	360
Plug-in or drawout	400 A	400	390	380	370	360	350	340

206. Shaded areas indicate temperature related values, non-shaded areas are standard circuit breaker ampere ratings at 104°F (40°C).

**Derating Circuit Breakers with MicroLogic Trip Units (Continued)**

Type of Device	Rating	Temperature						
		104°F (40°C)	113°F (45°C)	122°F (50°C)	131°F (55°C)	140°F (60°C)	149°F (65°C)	158°F (70°C)
Unit-mount	600 A	600	600	600	585	570	550	535
Plug-in or drawout	600 A	570	550	535	520	505	490	475

Example. A unit-mount PowerPacT L-frame circuit breaker equipped with a MicroLogic can have a maximum I<sub>r</sub> setting of:

- 400 A up to 122°F (50°C)
- 380 A up to 140°F (60°C)

**Altitude Derating**

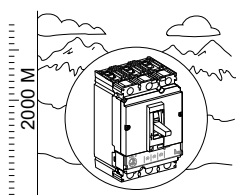

Altitude does not significantly affect the characteristics of PowerPacT H-, J-, and L-frame circuit breakers up to 6560 ft. (2000 m). Above this altitude, it is necessary to take into account the decrease in the dielectric strength and cooling capacity of air.

The following table gives the corrections to be applied for altitudes above 6560 ft. (2000 m). The breaking capacities remain unchanged.

**Altitude Derating**

Altitude		6560 ft (2000 m)	9840 ft (3000 m)	13120 ft (4000 m)	16400 ft (5000 m)
Dielectric withstand voltage		3000 V	2500 V	2100 V	1800 V
Insulation voltage	V <sub>i</sub>	800 V	700 V	600 V	500 V
Maximum operational voltage	V <sub>e</sub>	690 V	590 V	520 V	460 V
Average current capacity (A) at 104°F (40°C)	I <sub>n</sub> x	1.0	0.96	0.93	0.9

**Frequency Derating**

Application of H- and J-frame circuit breakers at frequencies above 60 Hz requires that special consideration be given to the effects of high frequency on the circuit breaker characteristics. Thermal and instantaneous operations must be treated separately.

At frequencies below 60 Hz, the thermal derating of PowerPacT H and J-frame circuit breakers is negligible. However, at frequencies above 60 Hz, thermal derating is required.

One of the most common high frequency applications is at 400 Hz. For 400 Hz derating information, see 400 Hz Applications, page 38.

For more information, refer to Data Bulletin 0100DB0101, *Determining Current Carrying Capacity in Special Applications*.

## Installation in Equipment

### Power from the Top or Bottom

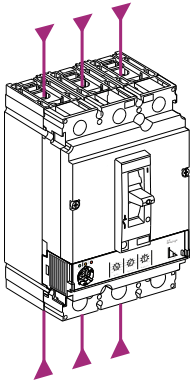

PowerPacT H-, J-, and L-frame circuit breakers with factory-sealed trip units can be supplied from either the top or the bottom without any reduction in performance. This capability facilitates connection when installed in end-use equipment.

All connection and insulation accessories can be used on circuit breakers supplied either from the top or bottom.

### Weight

The table below presents the weights of the circuit breakers and the main accessories, which must be summed to obtain the total weight. The values are valid for all performance categories.

#### Weights

Type of Device	Poles	Circuit Breakers	Base	Cradle	Motor Operator
H-frame, 100 A	2	3.95 lbs. (1.79 kg)	1.75 lbs. (0.8 kg)	4.85 lbs. (2.2 kg)	2.65 lbs. (1.2 kg)
	3	4.52 lbs. (2.05 kg)	1.75 lbs. (0.8 kg)	4.85 lbs. (2.2 kg)	2.65 lbs. (1.2 kg)
H-frame, 150 A	2	4.08 lbs. (1.85 kg)	1.75 lbs. (0.8 kg)	4.85 lbs. (2.2 kg)	2.65 lbs. (1.2 kg)
	3	4.85 lbs. (2.2 kg)	1.75 lbs. (0.8 kg)	4.85 lbs. (2.2 kg)	2.65 lbs. (1.2 kg)
J-frame, 250 A	3	5.29 lbs. (2.4 kg)	1.75 lbs. (0.8 kg)	4.85 lbs. (2.2 kg)	2.65 lbs. (1.2 kg)
L-frame, 600 A	3	13.65 lbs. (6.19 kg)	5.29 lbs. (2.4 kg)	4.85 lbs. (2.2 kg)	6.17 lbs. (2.8 kg)
	4	17.92 lbs. (8.13 kg)	6.17 lbs. (2.8 kg)	4.85 lbs. (2.2 kg)	6.17 lbs. (2.8 kg)



# Safety Clearances and Minimum Distances

## General Rules

When installing a circuit breaker, minimum distances (safety clearances) must be maintained between the device and panels, bars and other protection devices installed nearby. These distances, which depend on the voltage, are defined by tests carried out in accordance with UL standards.

If installation is not checked by type tests, it is also necessary to:

- use insulated bars for circuit-breaker connections
- segregate the busbars using phase barriers

For PowerPacT H-, J-, and L-frame devices, terminal shields and interphase barriers are recommended and may be mandatory depending on the operating voltage of the device and type of installation (unit-mount, drawout, etc.).

## Power Connections

The table below indicates the connection requirements for PowerPacT H-, J-, and L-frame devices to ensure insulation of live parts for the various types of connection.

- unit-mount devices with front connection or rear connection
- plug-in or drawout devices.

Connection accessories such as crimp lugs, terminal extensions (straight, right-angle, double-L and 45°) and spreaders are supplied with interphase barriers. Long terminal shields provide a degree of protection of IP40 (ingress).

## Safety Clearance

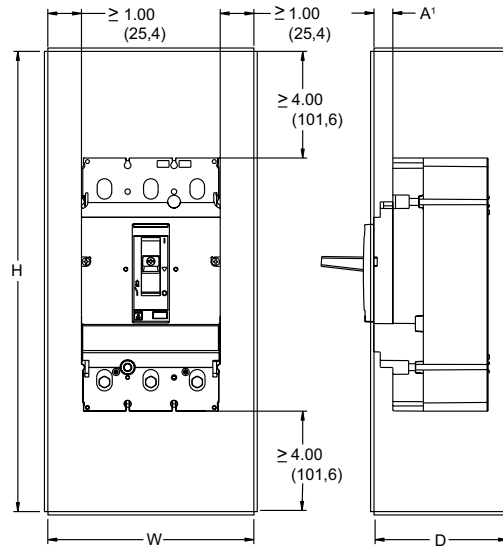

If dimension A < 0.56 in. for H- and J-frame circuit breaker, attach fiber insulating plate, not provided, to enclosure cover.

H- and J-Frame Fiber Insulating Plate

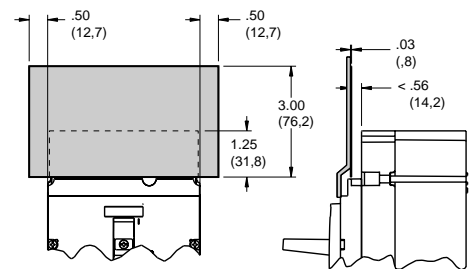

Dimensions: in. (mm)

## Control Wiring

### Remote Tripping by Undervoltage Trip (MN) or Shunt Trip (MX)

Power requirements are approximately:

- 30 VA for pick-up of the undervoltage trip (MN) and shunt trip (MX)
- 300–500 VA for the motor operator.

#### Recommended Maximum Cable Lengths

Power Supply Voltage (Vdc)		Length <sup>207</sup>					
		12 Vdc		24 Vdc		48 Vdc	
Cable cross-section		16 AWG (1.5 mm <sup>2</sup> )	14 AWG (2.5 mm <sup>2</sup> )	16 AWG (1.5 mm <sup>2</sup> )	14 AWG (2.5 mm <sup>2</sup> )	16 AWG (1.5 mm <sup>2</sup> )	14 AWG (2.5 mm <sup>2</sup> )
Undervoltage Trip (MN)	V source 100%	49 ft. (15 m)	—	525 ft. (160 m)	—	2100 ft. (640 m)	—
	V source 85%	23 ft. (7 m)	—	131 ft. (40 m)	—	525 ft. (160 m)	—
Shunt Trip (MX)	V source 100%	197 ft. (60 m)	—	787 ft. (240 m)	—	3150 ft. (960 m)	—
	V source 85%	98 ft. (30 m)	—	394 ft. (120 m)	—	1575 ft. (480 m)	—
Motor Operator	V source 100%	—	—	33 ft. (10 m)	52 ft. (16 m)	213 ft. (65 m)	361 ft. (110 m)
	V source 85%	—	—	6.6 ft. (2 m)	13 ft. (4 m)	56 ft. (17 m)	82 ft. (25 m)

### External Neutral Voltage Tap (ENVT)

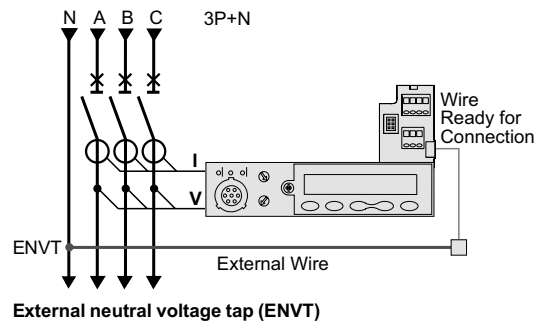

This connection is required for accurate power measurements on three-pole circuit breakers equipped with MicroLogic 5/6 E trip units in installations with a distributed neutral. It can be used to measure phase-neutral voltages and calculate power using the 3 wattmeter method.

PowerPacT H-, J-, and L-frame three-pole circuit breakers come with a wire installed on the device for the connection to the ENVT. This wire is equipped with a connector for connection to an external wire with:

- cross-sectional area of 18–14 AWG (1 mm<sup>2</sup> to 2.5 mm<sup>2</sup>)
- maximum length of 32.8 ft. (10 m).

207. The indicated length is that of each of the two wires.

## External Neutral Current Transformer (ENCT)

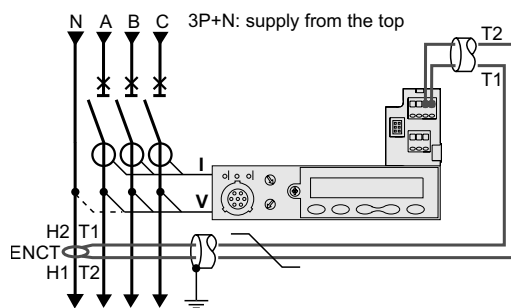

This connection is required to protect the neutral on three-pole circuit breakers equipped with MicroLogic 5/6 A or E trip units in installations with a distributed neutral. For MicroLogic 6 A or E, it is required for ground-fault protection.

The ENCT is connected in the same way for unit-mount, plug-in or drawout devices:

- unit-mount devices are connected using terminals T1 and T2 of the internal terminal block.
- plug-in and drawout devices are not connected using the auxiliary terminals.

The wires must be connected/disconnected inside the devices using terminals T1 and T2.

The ENCT must be connected to the MicroLogic trip unit by a shielded twisted pair. The shielding should be connected to the enclosure earth only at the CT end, no more than 12 in. (30 cm) from the CT.

- the power connections of the CT to the neutral (H2 and H1) must be made in the same way for power supply from the top or the bottom (see the figure). Make sure they are not reversed for devices with power supply from the bottom.
- cross-sectional area of 22–16 AWG (0.4 mm<sup>2</sup> to 1.5 mm<sup>2</sup>)
- maximum length of 32.8 ft. (10 m).

## 24 Vdc Power Supply Module

An external 24 Vdc power supply is required for installations with communication networks, regardless of the type of trip unit.

On installations without communication networks, the power supply is available as an option for MicroLogic 5/6 to:

- modify settings when the circuit breaker is open (OFF position)
- display measurements when the current flowing through the circuit breaker is low
- maintain the display of the cause of tripping

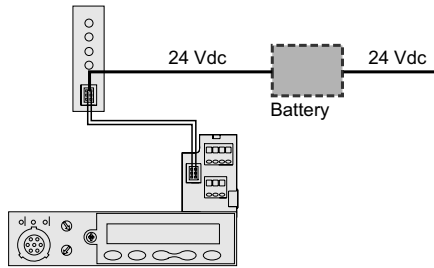

**Power supply, without the communication function, using the terminal block with a backup battery.**

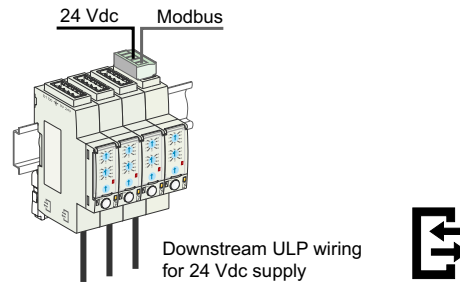

**Power supply, with the communication function, using the Modbus interface.**

To determine the power requirements of the devices, see [Power Requirements](#), page 110.

# Wiring Diagrams

## Unit-Mount Circuit Breakers

**Power      MicroLogic Trip Unit      Remote Operation**

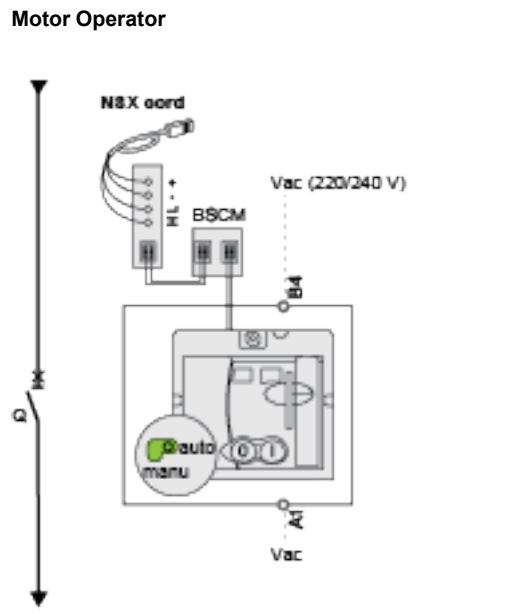
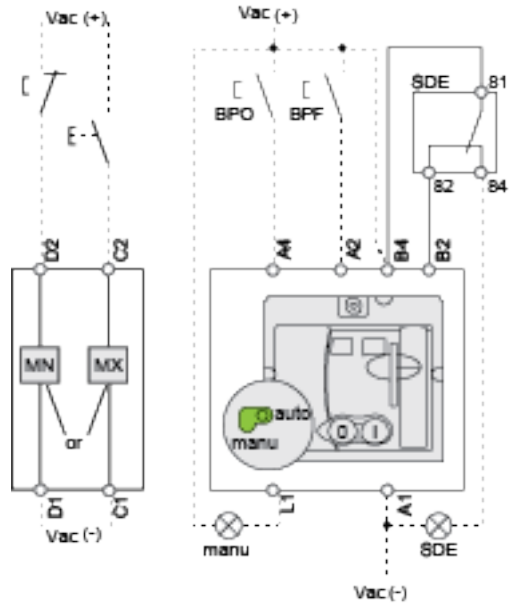
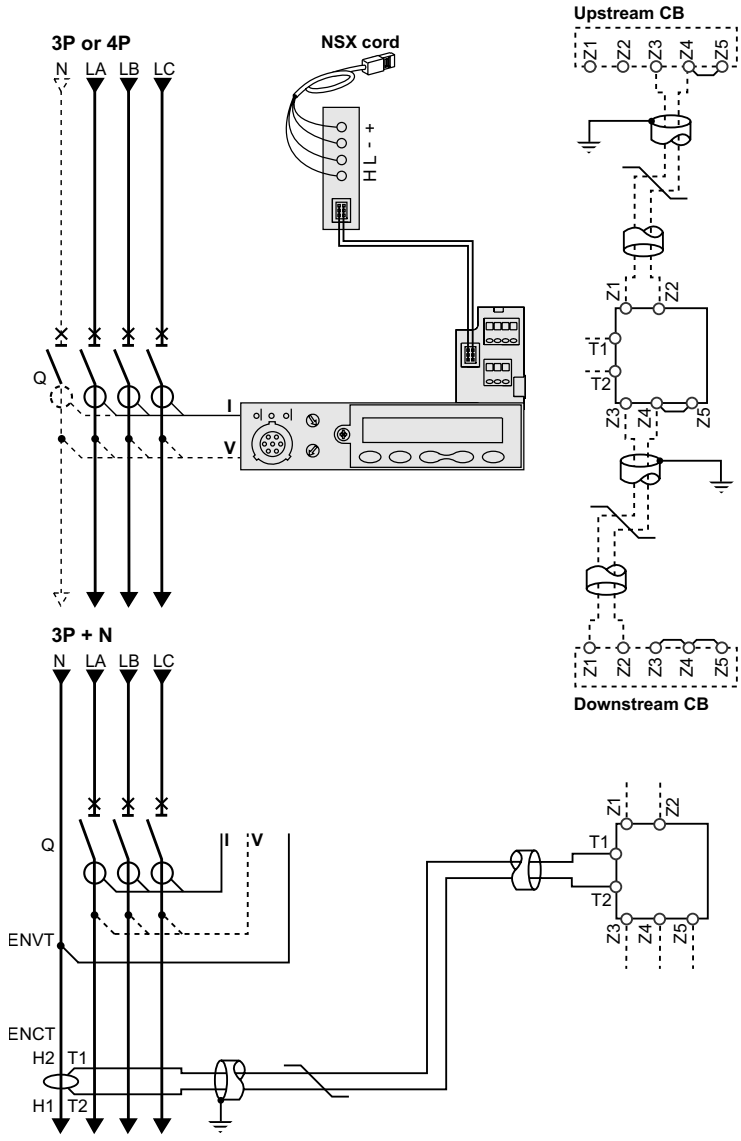

NOTE: Schematic of the communicating motor operator .

**Communicating Motor Operator**

**Indication Contacts**

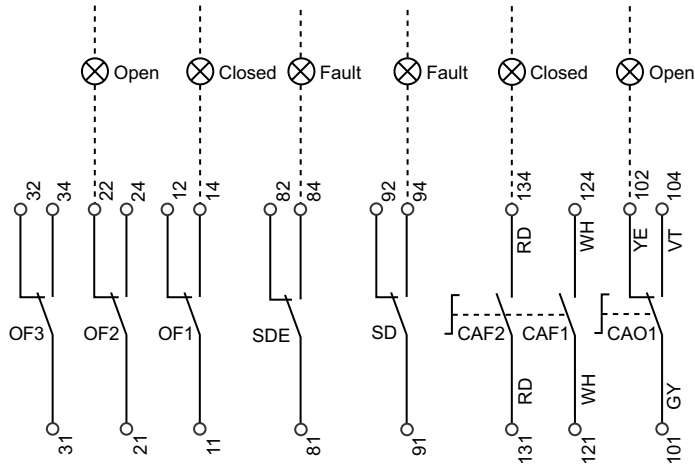

The diagram is shown with circuits de-energized, relays in normal position, and all devices open, connected, and charged. Terminal connections shown as O must be connected by the customer.

**MicroLogic Trip Unit A or E**

A/E	Communication H (WH), L (BL): data -(BK), +(RD): 24 Vdc power supply
A/E	ZSI (Zone Selective Interlocking) Z1: ZSI OUT SOURCE Z2: ZSI OUT Z3: ZSI IN SOURCE Z4: ZSI IN ST (short time) Z5: ZSI IN GF (ground fault) (Z3, Z4, and Z5 for L-frame circuit breaker only)
A/E	ENCT: External Neutral Current Transformer: —Shielded cable with 1 twisted pair (T1, T2) —Shielding earthed at CT end only Connection L = 12 in. (30 cm) max. —Maximum length of 33 ft. (10 m) —Cable size of 22 AWG —Recommended cable: Belden 9451SB or equivalent
E	ENVT: External Neutral Voltage Tap for Connection to the Neutral using a Three-Pole Circuit Breaker

**Color Code for Auxiliary Wiring**

RD: Red	VI: Violet
WH: White	GY: Gray
YE: Yellow	OR: Orange
BK: Black	BL: Blue
GN: Green	

**Remote Operation**

MN	Undervoltage Release
or	
MX	Shunt Release

**Motor Operator**

A4	Opening Order
A2	Closing Order
B4, A1	Power Supply to Motor Operator
L1	Manual Position (manu)
B2	Overcurrent Trip Switch Interlocking (mandatory for correct operation)
BPO	Opening Pushbutton
BPF	Closing Pushbutton

**Communicating Motor Operator**

B4, A1	Motor Operator Power Supply
BSCM	Breaker Status and Control Module

**Indication Contacts**

OF2/OF1	Device ON/OFF Auxiliary Switches
OF3	Device ON/OFF Auxiliary Switches (L-Frame)
SDE	Overcurrent Trip Switch (short-circuit, overload, ground fault, earth leakage)
SD	Alarm Switch
CAF2/CAF1	Early-Make Contact (rotary handle only)
CAO1	Early-Break Contact (rotary handle only)

# Plug-In and Drawout Circuit Breakers

**Power**      **MicroLogic Trip Unit**      **Remote Operation**

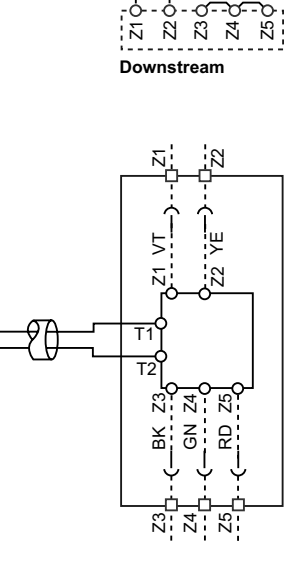
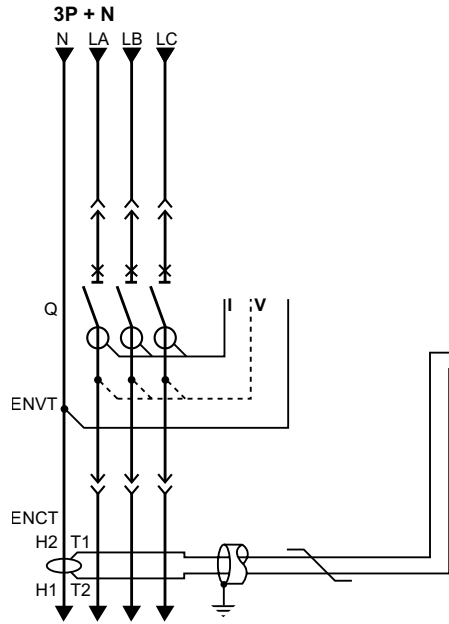
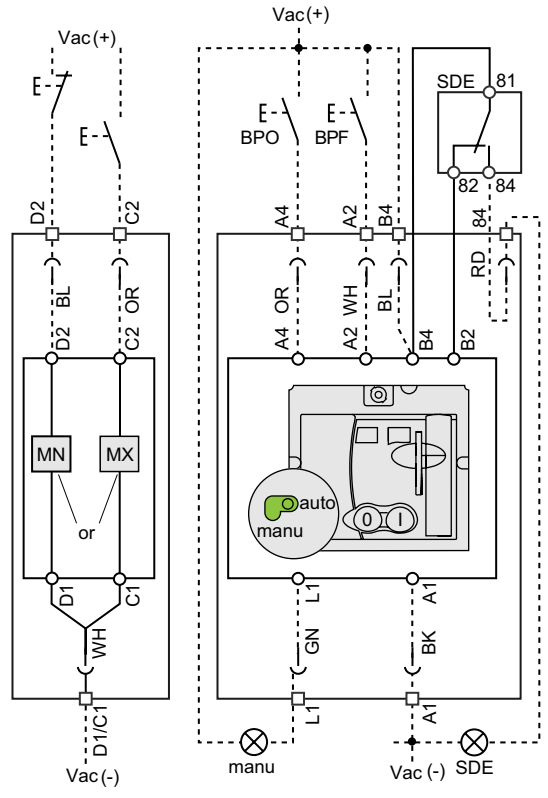
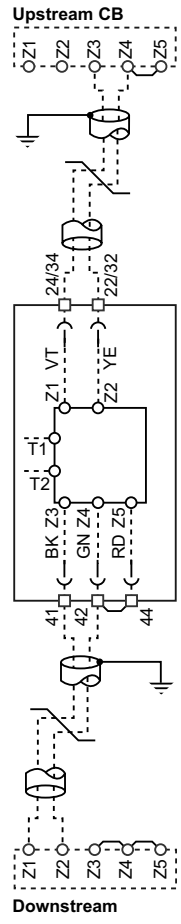
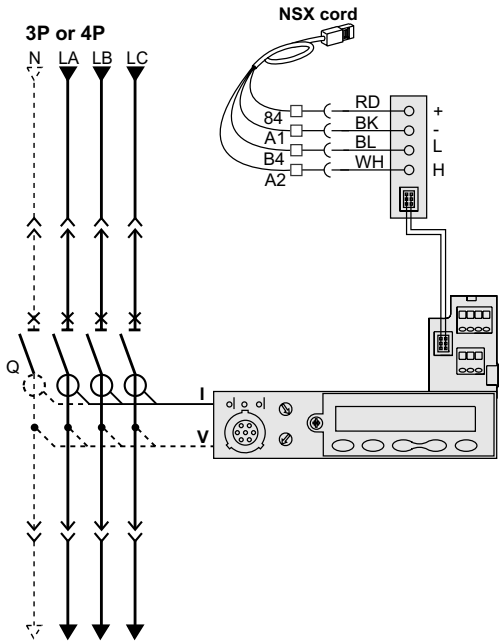

**Motor Operator**

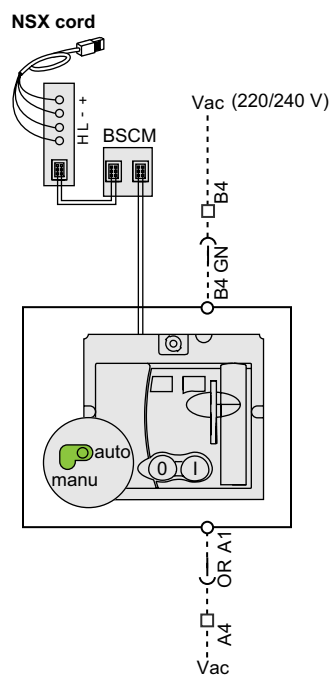

**Communicating Motor Operator**

**Indication Contacts**

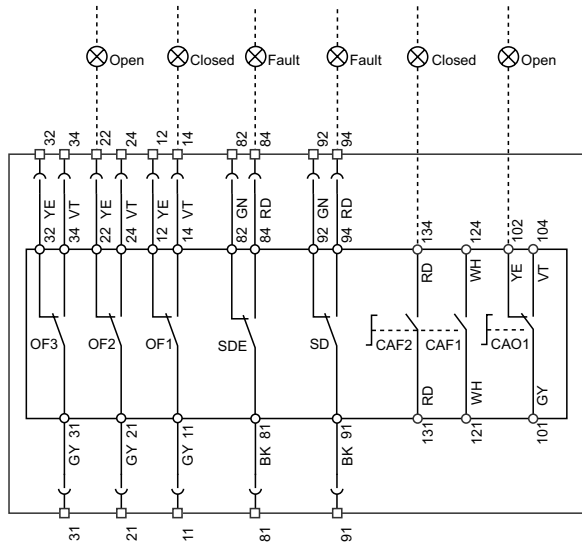

The diagram is shown with circuits de-energized, relays in normal position, and all devices open, connected, and charged. Terminal connections shown as O must be connected by the customer.

**Carriage Switches**

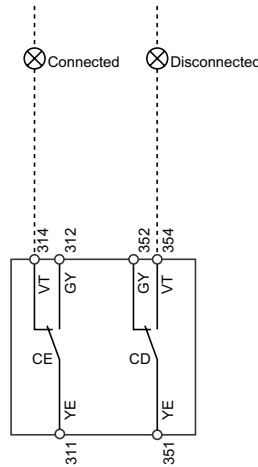

**MicroLogic Trip Unit A or E**

A/E	Communication - (BK), +(RD): 24 Vdc power supply
A/E <sup>208</sup>	ZSI (Zone Selective Interlocking) Z1: ZSI OUT SOURCE Z2: ZSI OUT Z3: ZSI IN SOURCE Z4: ZSI IN ST (short time) Z5: ZSI IN GF (ground fault)
A/E	ENCT: External Neutral Current Transformer: —Shielded cable with 1 twisted pair (T1, T2) —Shielding earthed at CT end only —Connection L = 12 in. (30 cm) max. —Maximum length of 33 ft. (10 m) —Cable size of 22 AWG —Recommended cable: Belden 9451SB or equivalent
E	ENVT: External Neutral Voltage Tap for Connection to the Neutral using a Three-Pole Circuit Breaker

**Color Code for Auxiliary Wiring**

RD: Red	BK: Black	GY: Gray
WH: White	GN: Green	OR: Orange
YE: Yellow	VI: Violet	BL: Blue

**Remote Operation**

MN or	Undervoltage Release
MX	Shunt Release

**Motor Operator**

A4	Opening Order
A2	Closing Order
B4, A1	Power Supply to Motor Operator
L1	Manual Position (manu)
B2	Overcurrent Trip Switch Interlocking (mandatory for correct operation)
BPF	Closing Pushbutton

**Communicating Motor Operator**

B4, A1	Motor Operator Power Supply
BSCM	Breaker Status and Control Module

**Indication Contacts**

OF2/OF1	Device ON/OFF Auxiliary Switches
OF3	Device ON/OFF Auxiliary Switches (L-Frame)
SDE	Overcurrent Trip Switch (short-circuit, overload, ground fault, earth leakage)
SD	Alarm Switch
CAF2/CAF1	Early-Make Contact (rotary handle only)
CAO1	Early-Break Contact (rotary handle only)

208. Z3, Z4, and Z5 for L-frame circuit breaker only.



# Motor Operator

The diagram is shown with circuits de-energized, relays in normal position, and all devices open, connected, and charged.

After tripping initiated by the “Push to trip” button, the undervoltage release (MN), or the shunt release (MX), device can be reset automatically, remotely, or manually.

Following tripping due to an electrical fault, reset must be carried out manually.

**Motor Operator with Automatic Reset**

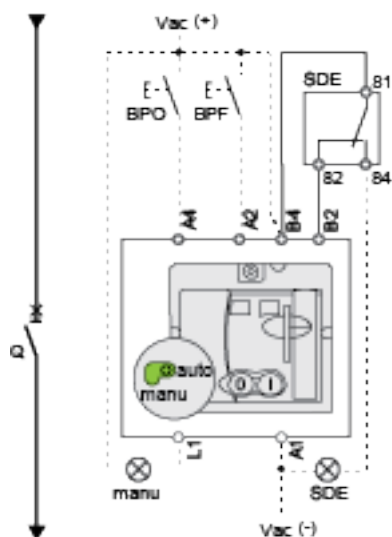

**Motor Operator with Remote Reset**

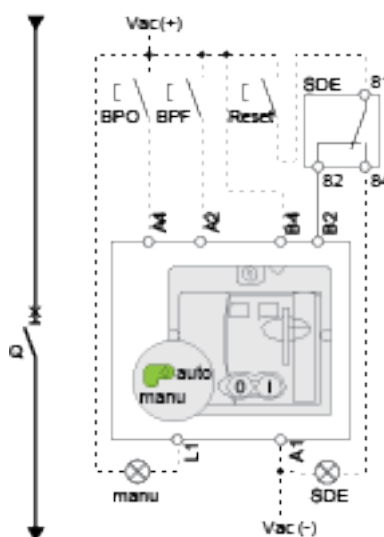

**Symbols**

- Q: Circuit Breaker
- A4: Opening Order
- A2: Closing Order
- B4, A1: Motor Operator Power Supply
- L1: Manual Position (manu)
- B2: Overcurrent Trip Switch Interlocking (mandatory for correct operation)
- BPO: Opening Pushbutton
- BPF: Closing Pushbutton
- SDE: Fault-Trip Indication Contact (short-circuit, overload, ground fault, earth leakage)

**Motor Operator with Manual Reset**

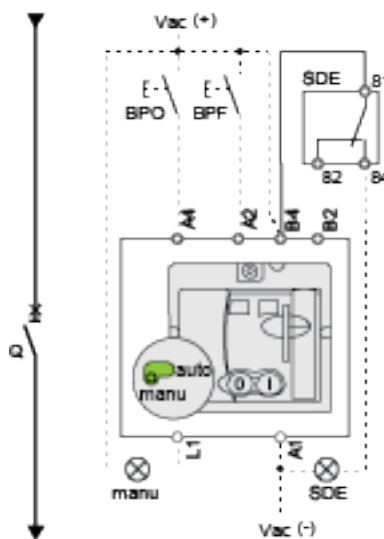

**Symbols** **Communicating Motor Operator**

- Q: Circuit Breaker
- B4, A1: Motor Operator Power Supply
- BSCM: Breaker Status and Control Module

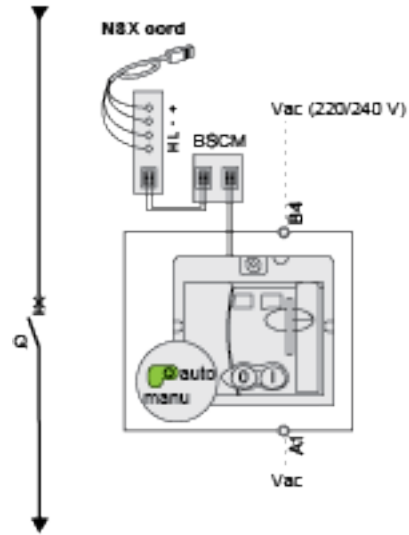

NOTE: Schematic of the communicating motor operator .

**RSU Screen for Communicating Motor Operator**

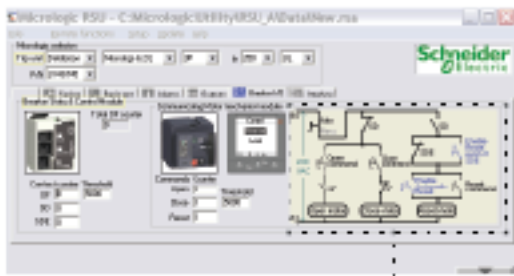

RSU utility setup screen for the communicating motor operator

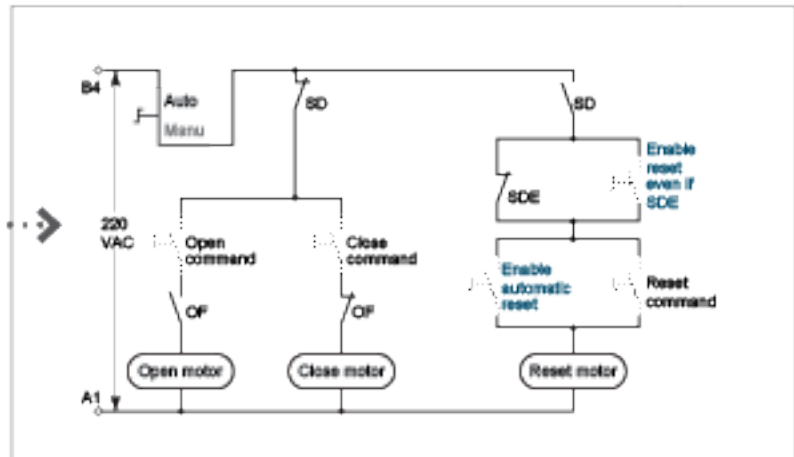

Single-line diagram of communicating motor operator

Opening, closing and reset orders are transmitted through the communication network. The “Enable automatic reset” and “Enable reset even if SDE” parameters must be set using the RSU software using the screen by clicking the blue text.

“Auto/Manu” is a switch on the front of the motor operator.

Terminal connections shown as O must be connected by the customer.

# PowerPacT H & J DC Wiring Diagrams

Type	Grounded Negative <sup>209</sup>	Grounded Middle Point	Ungrounded Source
	250 Vdc	≤250 Vdc	≤250 Vdc
2P			
3P			

Circuit Breaker Specifications (UL® / CSA® / NOM®)	
Circuit Breaker Type	250 Vdc <sup>210</sup>
D, G, J, L	20 kA

209. It is acceptable to ground the positive leg.

210. 250 Vdc ratings only available with PowerPacT H or J circuit breakers with thermal-magnetic trip units (not including MCP).

# SDx Module with MicroLogic Trip Unit

**NOTE:** The diagram is shown with circuits de-energized, relays in normal position, and all devices open, connected, and charged.

Symbols	
<b>SD1, SD3:</b>	SDx Module Power Supply
<b>SD2:</b>	Output 1 (80 mA max.)
<b>SD4:</b>	Output 2 (80 mA max.)

	SD2	SD4
<b>MicroLogic 3</b>	SDT	—
<b>MicroLogic 5</b>	SDT or Output 1	PAL Ir or Output 2
<b>MicroLogic 6</b>	SDT or Output 1	SDG or Output 2

Terminal connections shown as O must be connected by the customer.

### Connection

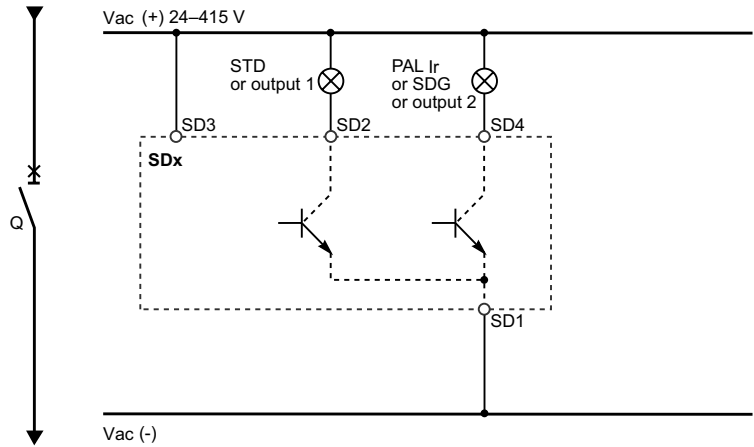

### Operation

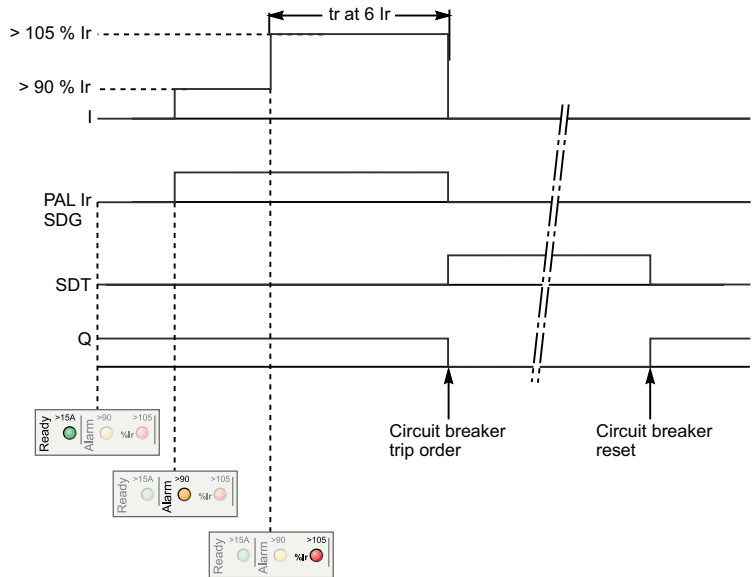

<b>I:</b>	Charge Current
<b>PAL Ir:</b>	Thermal Overload Pre-Alarm
<b>SDG:</b>	Ground-Fault Signal
<b>SDT:</b>	Thermal-Fault Signal
<b>Q:</b>	Circuit Breaker

# SDTAM Module with MicroLogic M Trip Unit

**NOTE:** The diagram is shown with circuits de-energized, relays in normal position, and all devices open, connected, and charged.

Symbols	
<b>SD1, SD3:</b>	SDTAM Module Power Supply
<b>SD2:</b>	Thermal Fault Signal (80 mA max.)
<b>SD4:</b>	Contactor Control Output (80 mA max.)

	SD2	SD4
<b>MicroLogic 2 M</b>	SDT	KA1

Terminal connections shown as O must be connected by the customer.

## Connection

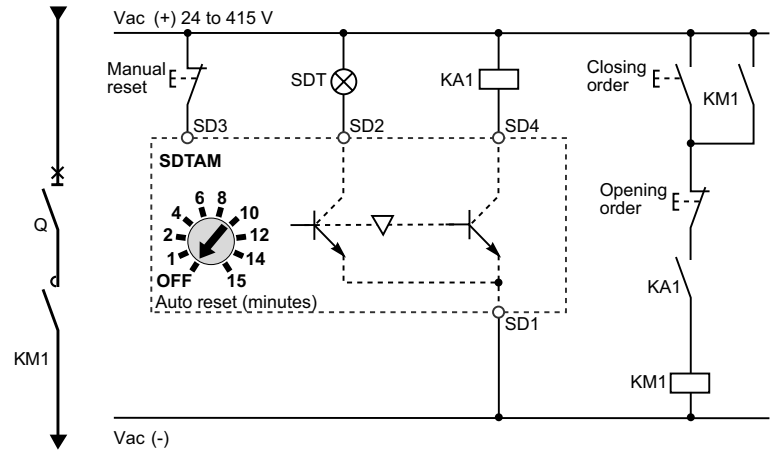

## Operation

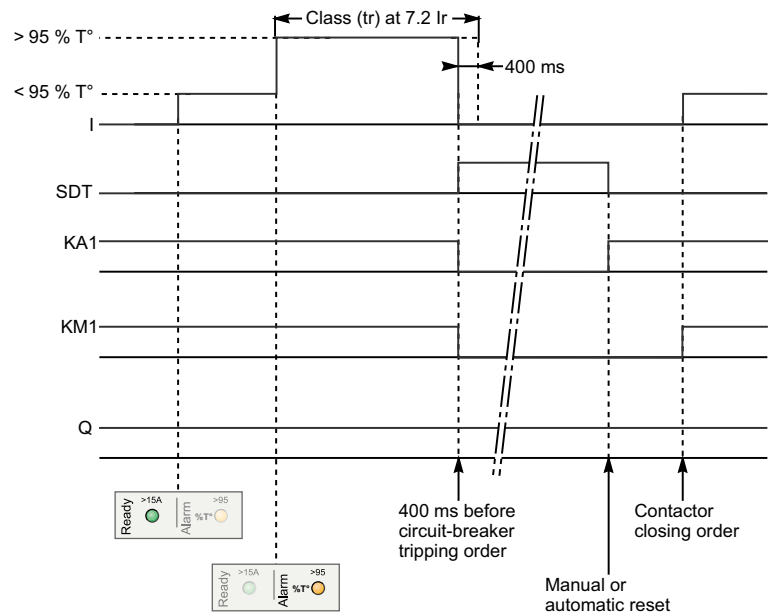

<b>I:</b>	Charge Current
<b>SDT:</b>	Thermal Fault Signal
<b>KA1:</b>	Auxiliary Relay (RBN or RTBT Relay)
<b>KM1:</b>	Motor Contactor
<b>Q:</b>	Circuit Breaker

# Circuit Breaker Dimensions

## Enclosures

### Enclosure Dimensions

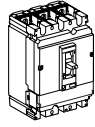
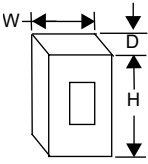
			
		Standard (80%) Rated	100% Rated
HD/HG/HJ/HL	15–150 A	15.6 x 6.12 x 3.49 in. (396 x 155 x 89 mm)	15.6 x 6.12 x 3.49 in. (396 x 155 x 89 mm)
HR		18.13 x 8.63 x 4.13 in. (461 x 219 x 105 mm)	62 x 22.5 x 14 in. (1575 x 572 x 356 mm)
JD/JG/JJ/ JL <sup>211</sup>	150–250 A	18.72 x 6.12 x 3.49 in. (476 x 155 x 89 mm)	18.72 x 6.12 x 3.49 in. (476 x 155 x 89 mm)
JR		28.5 x 12.38 x 5.38 in. (724 x 314 x 137 mm)	62 x 22.5 x 14 in. (1575 x 572 x 356 mm)
LD/LG/LJ/LL	250–600 A	35.48 x 12.00 x 4.45 in. (901 x 305 x 113 mm)	35.48 x 12.00 x 4.45 in. (901 x 305 x 113 mm)
LR		40.5 x 13.75 x 4.33 in. (1030 x 350 x 110 mm)	40.5 x 13.75 x 4.33 in. (1030 x 350 x 110 mm)

### J-Frame Minimum Enclosure Insulation

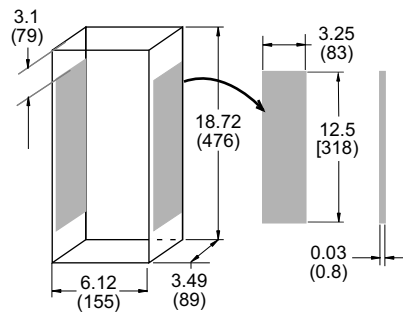

Dimensions: in. (mm)

### L-Frame Minimum Enclosure Insulation for Rear Connection

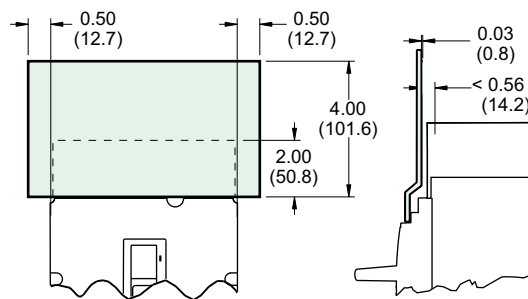

Dimensions: in. (mm)

211. Minimum enclosure insulation required if circuit breaker side < 4.13 in. (105 mm) from metal.

# PowerPacT H-Frame Circuit Breakers

## 15-150 A Bus Bar PowerPacT H-Frame Two-Pole HD/HG Thermal-Magnetic Only Circuit Breaker

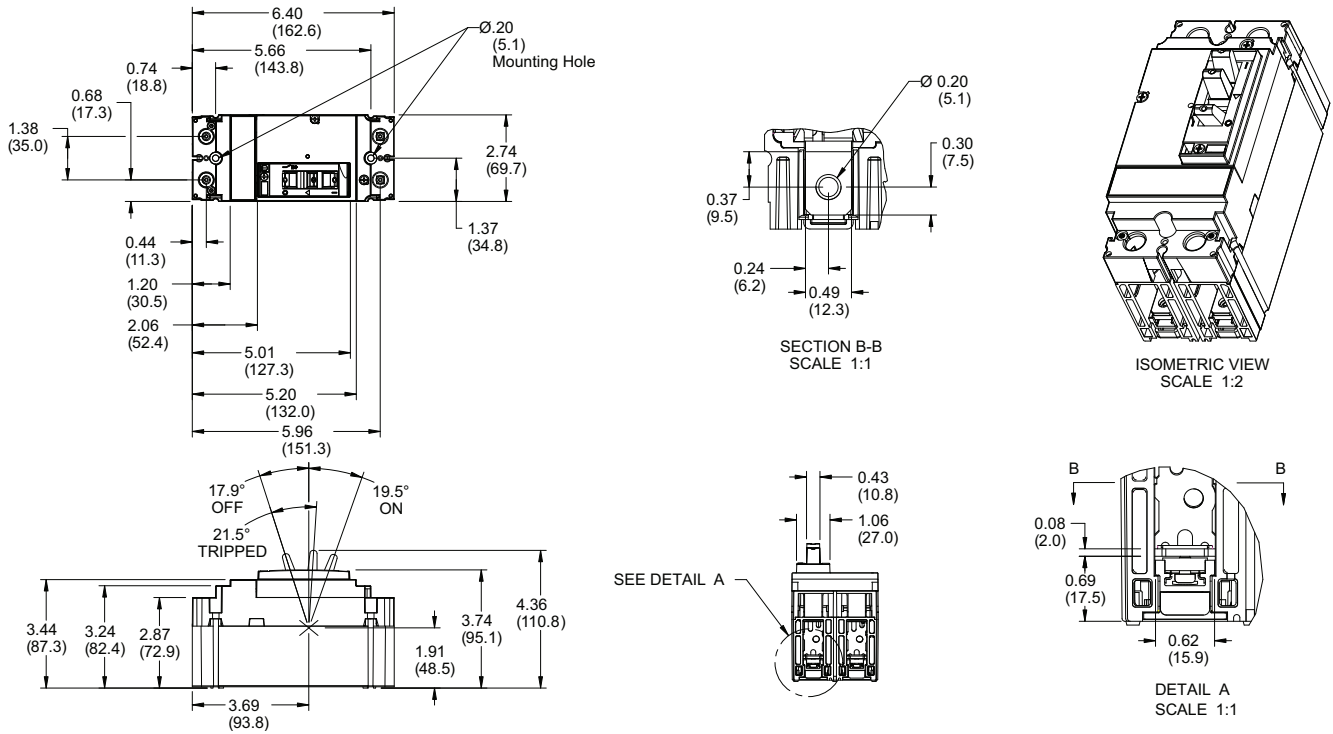

## 15-150 A Unit Mount PowerPacT H-Frame Two-Pole HD/HG Thermal-Magnetic Only Circuit Breaker

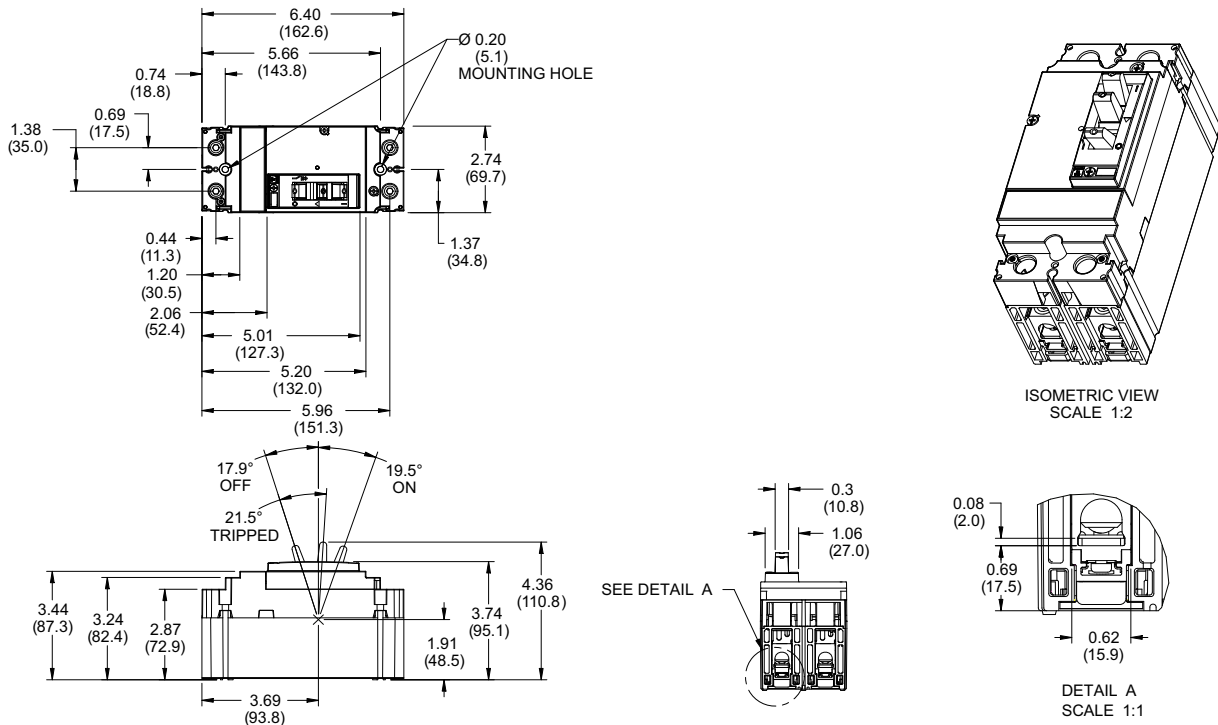





**15–150 A Rear Connected PowerPacT H-Frame Three-Pole Circuit Breaker**

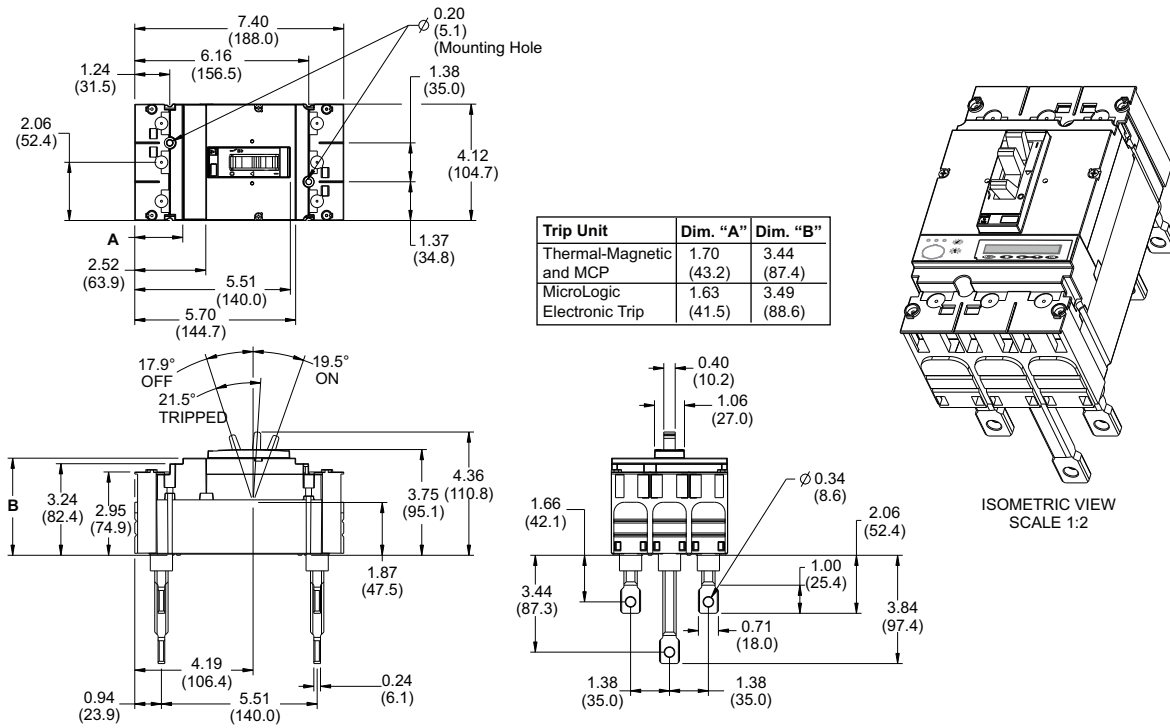

**Motor Operator Detail (PowerPacT H-Frame Circuit Breaker)**

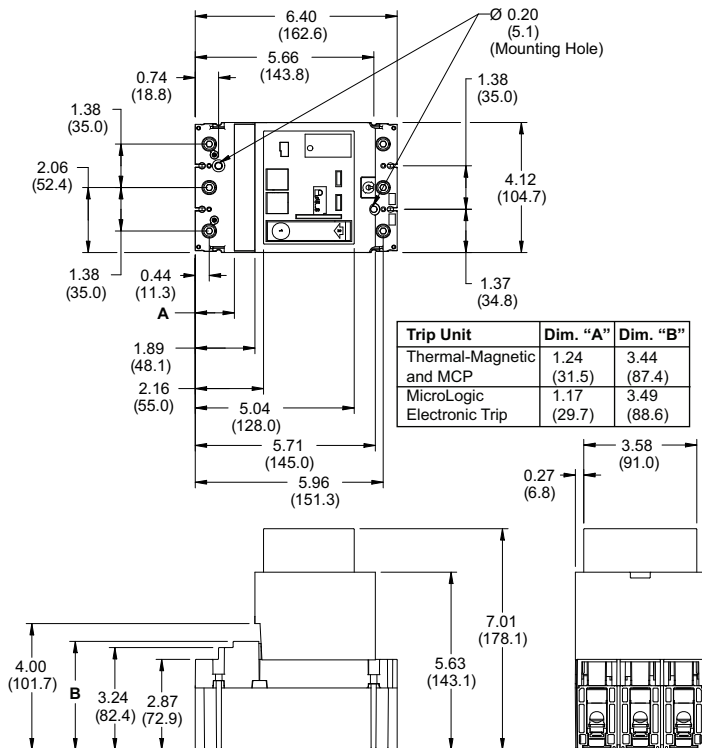

**Rotary Handle Detail (PowerPacT H-Frame Circuit Breaker)**

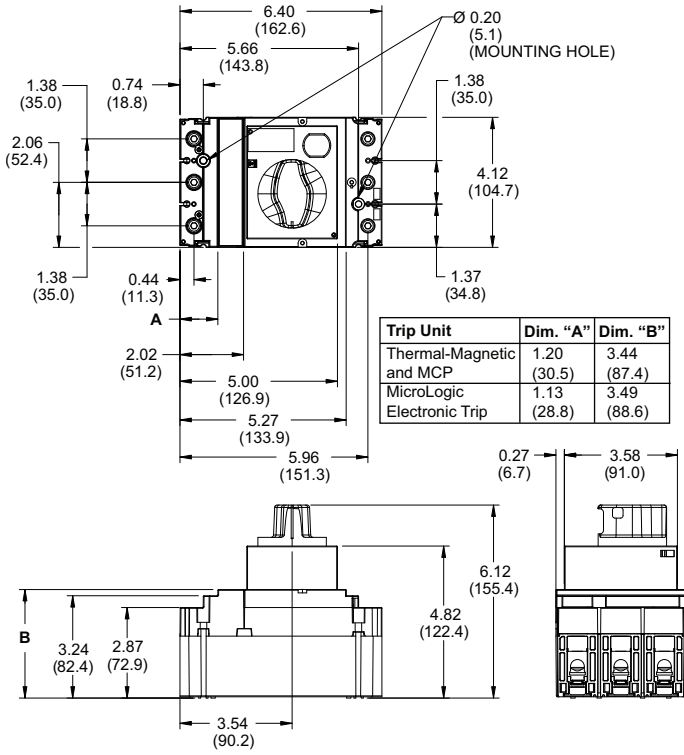

# PowerPacT J-Frame Circuit Breakers

## 150–250 A Bus Bar PowerPacT J-Frame Three-Pole Circuit Breaker

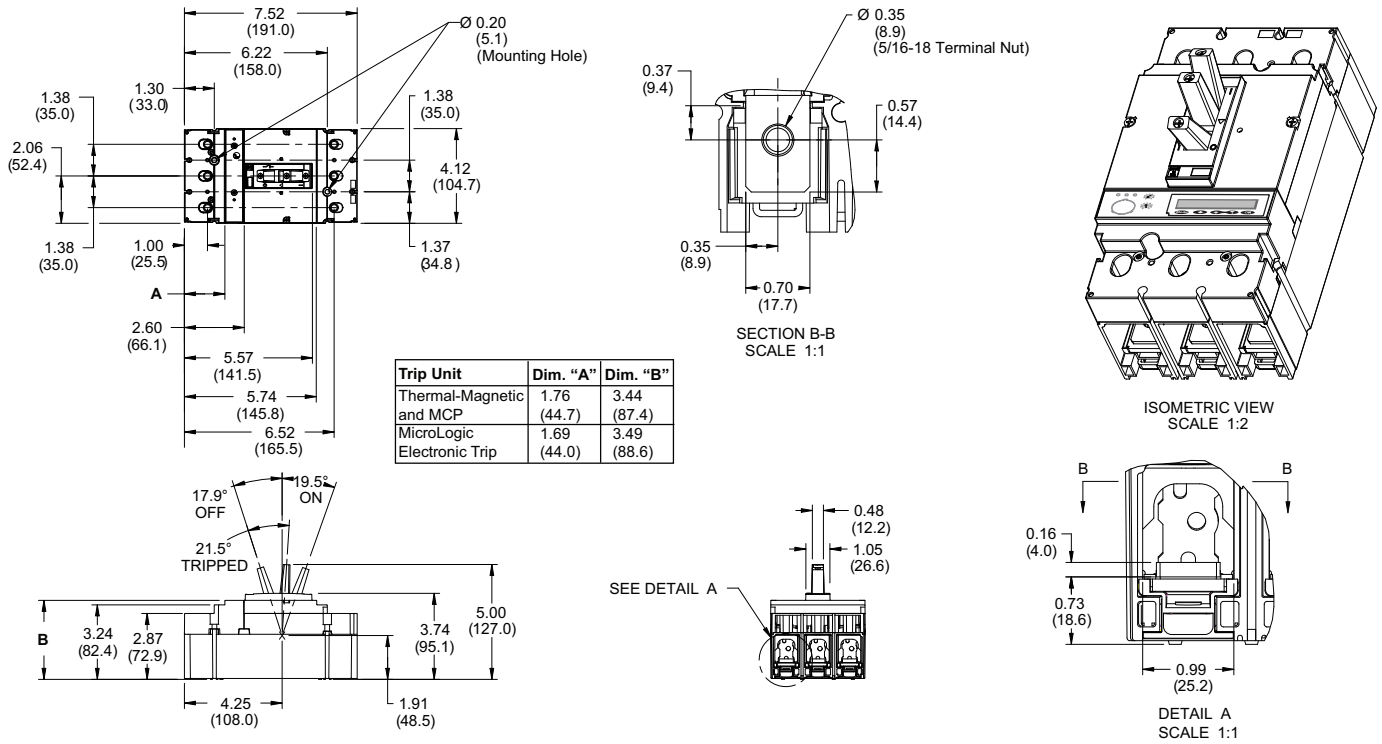

## 150–250 A Lug-Lug PowerPacT J-Frame Three-Pole Circuit Breaker

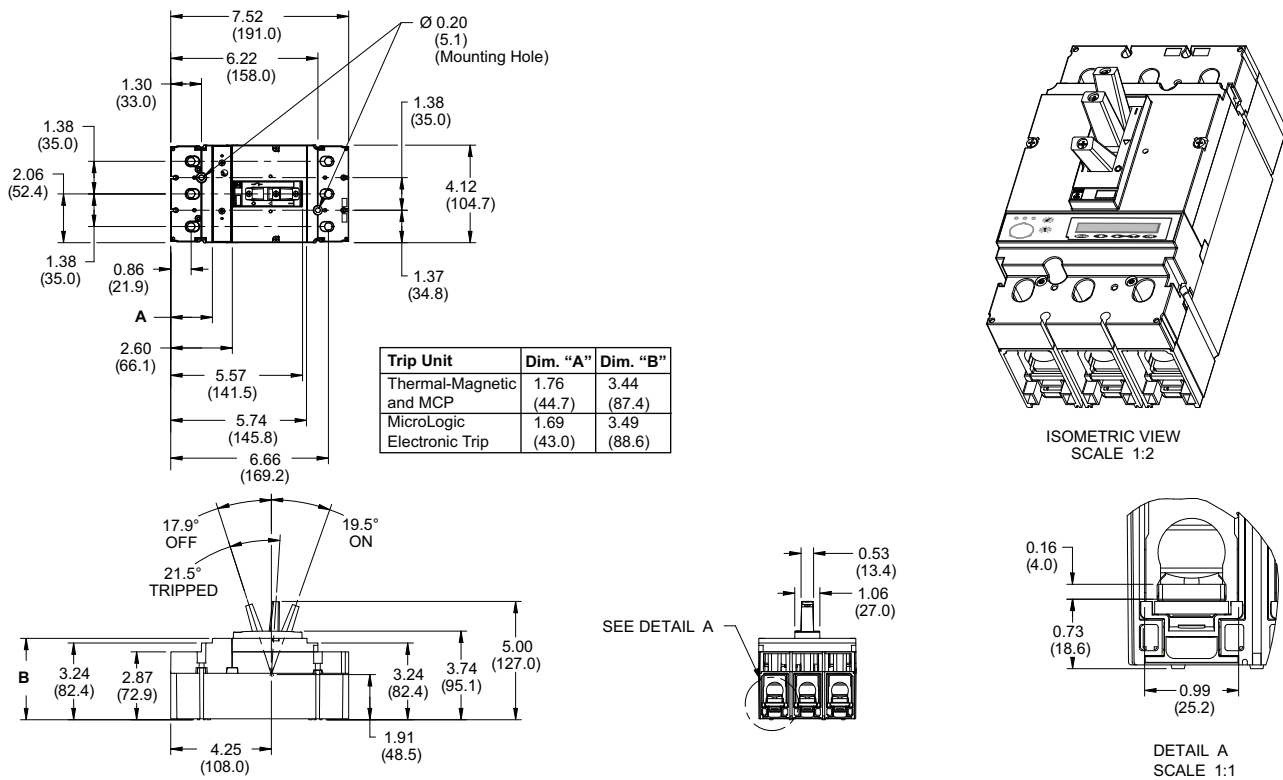

**150–250 A Rear Connected PowerPacT J-Frame Three-Pole Circuit Breaker**

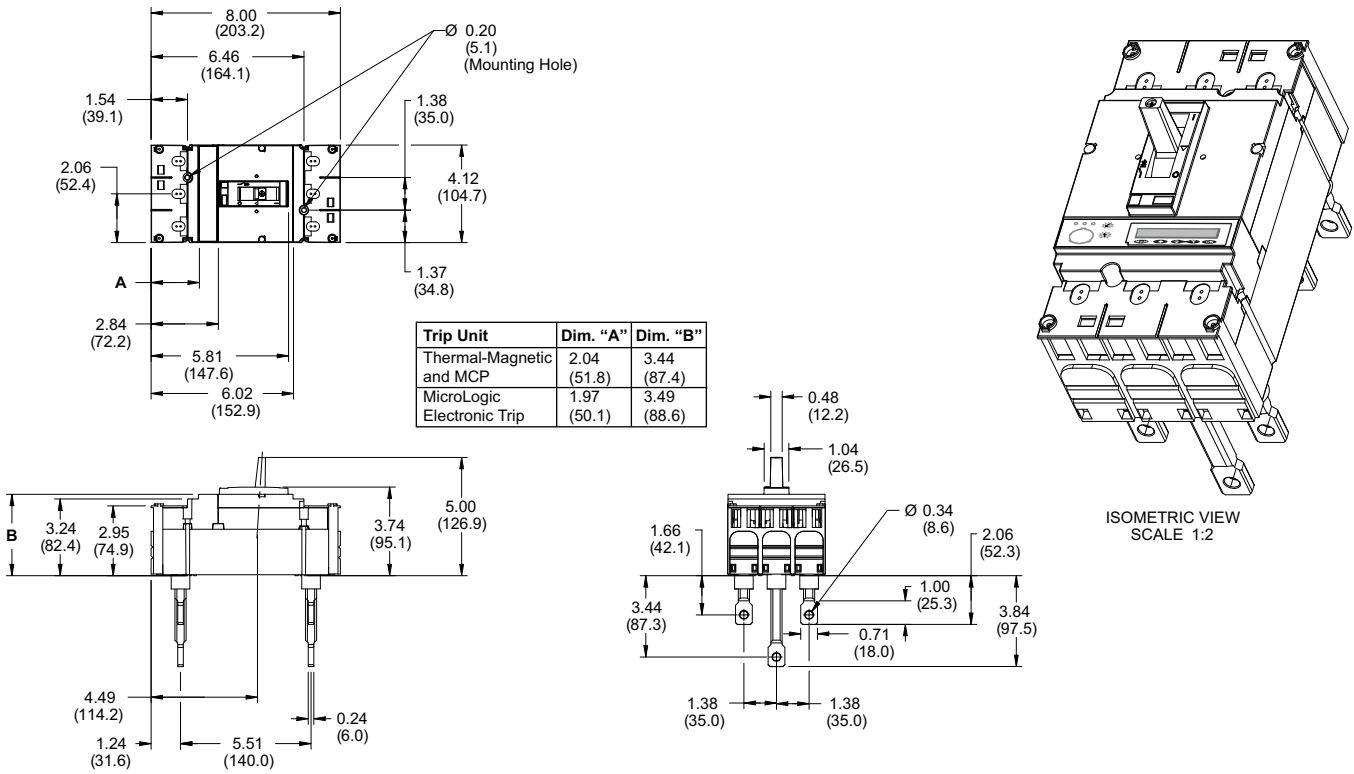

**Motor Operator Detail (PowerPacT J-Frame Circuit Breaker)**

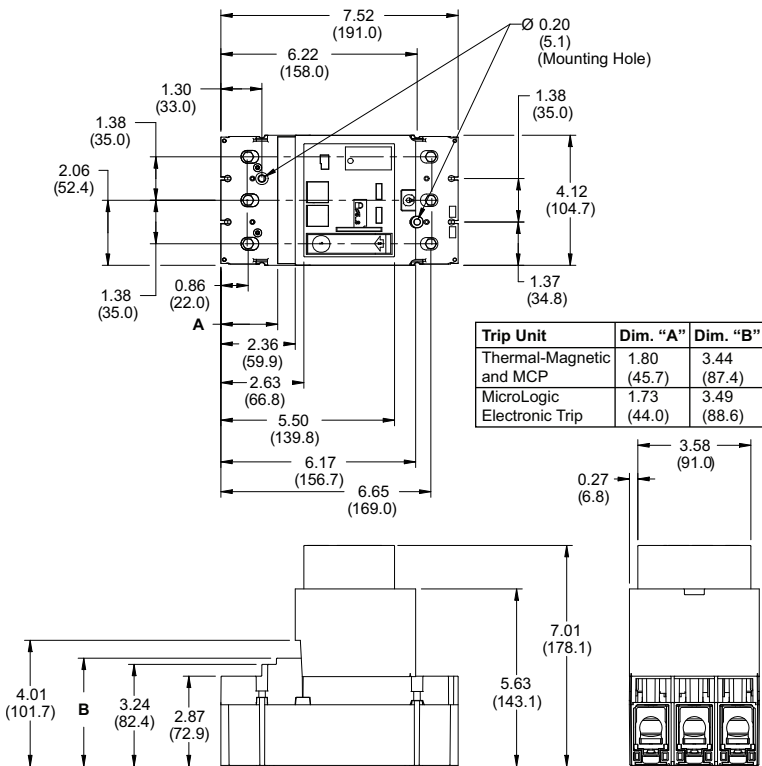

**Rotary Handle Detail (PowerPacT J-Frame Circuit Breaker)**

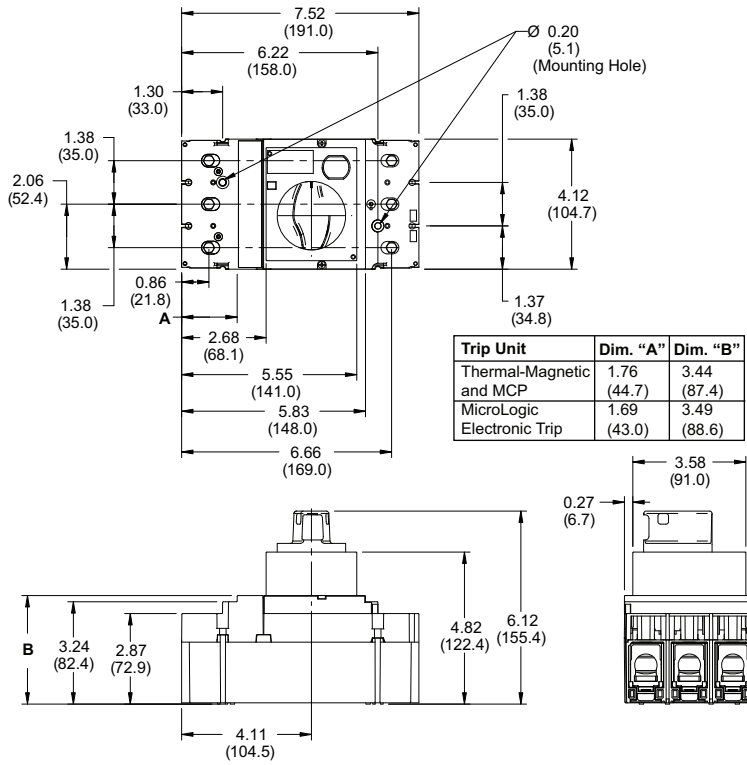

# PowerPacT H- and J-Frame Plug-In Circuit Breakers

## 15–250 A PowerPacT H- and J-Frame Three-Pole Circuit Breaker Plug-In Base

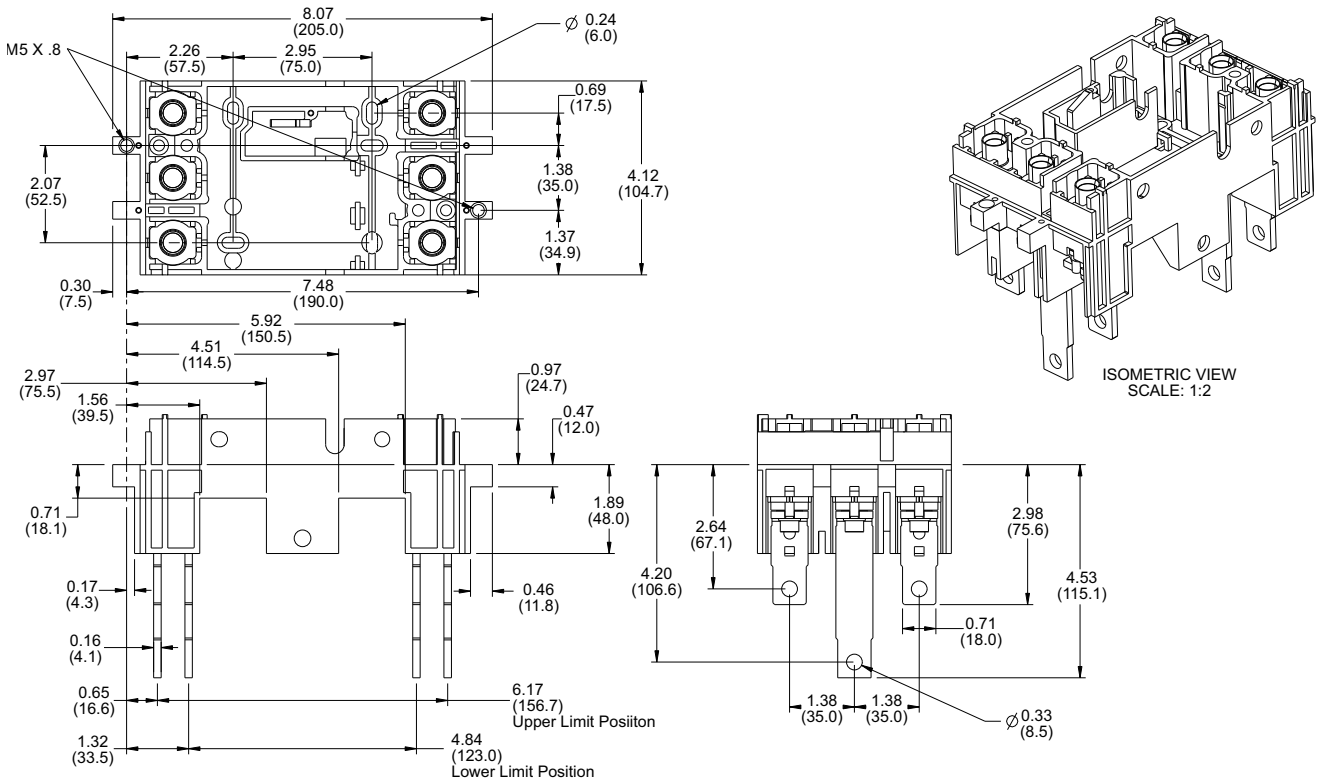

## 15–250 A PowerPacT H- and J-Frame Plug-In Three-Pole Circuit Breaker

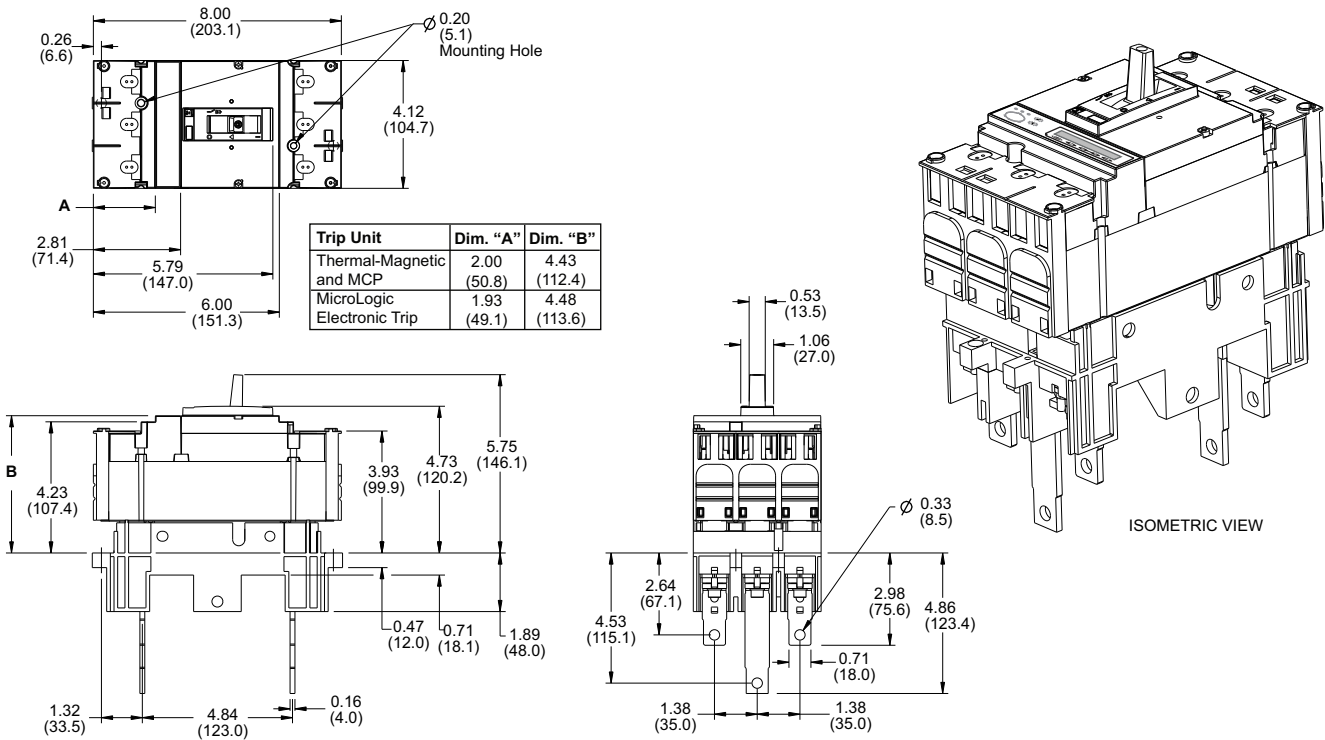

# PowerPac T H- and J-Frame Drawout Circuit Breakers

## 15-250 A PowerPac T H- and J-Frame Three-Pole Circuit Breaker Cradle

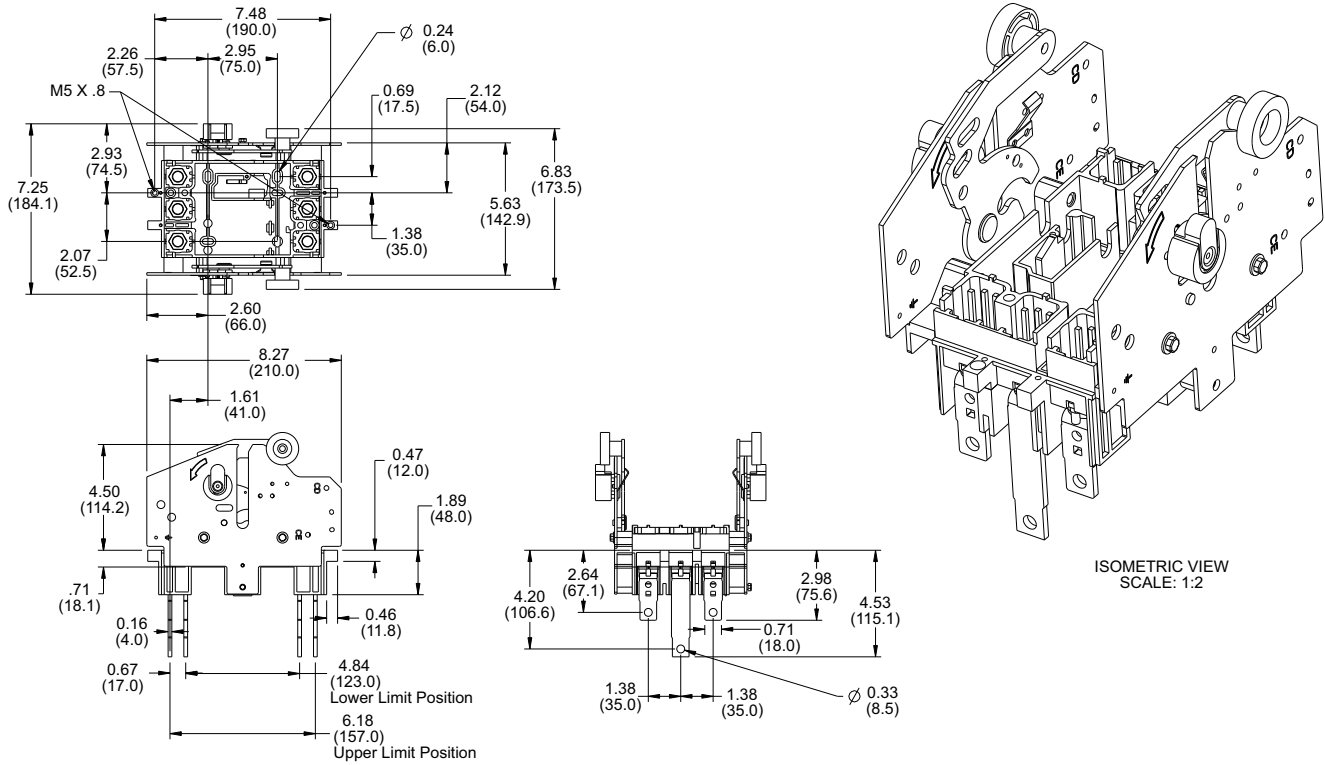

## 15-250 A PowerPac T H- and J-Frame Drawout Three-Pole Circuit Breaker

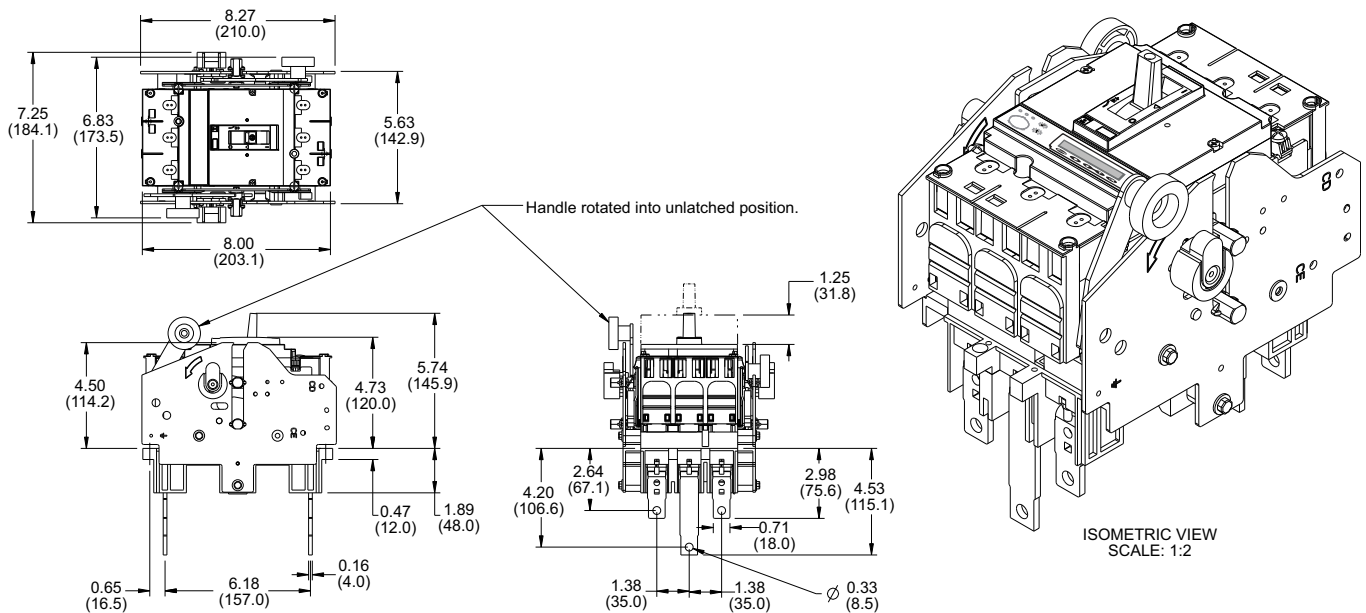

# PowerPacT H- and J-Frame Circuit Breaker Mounting

## PowerPacT H-Frame Two-Pole HD/HG Thermal-Magnetic Only Circuit Breaker

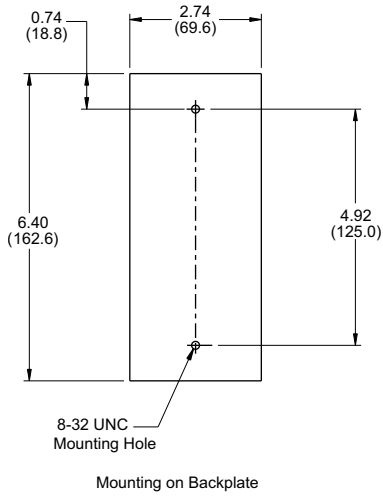

## PowerPacT H- and J-Frame Three-Pole Circuit Breaker

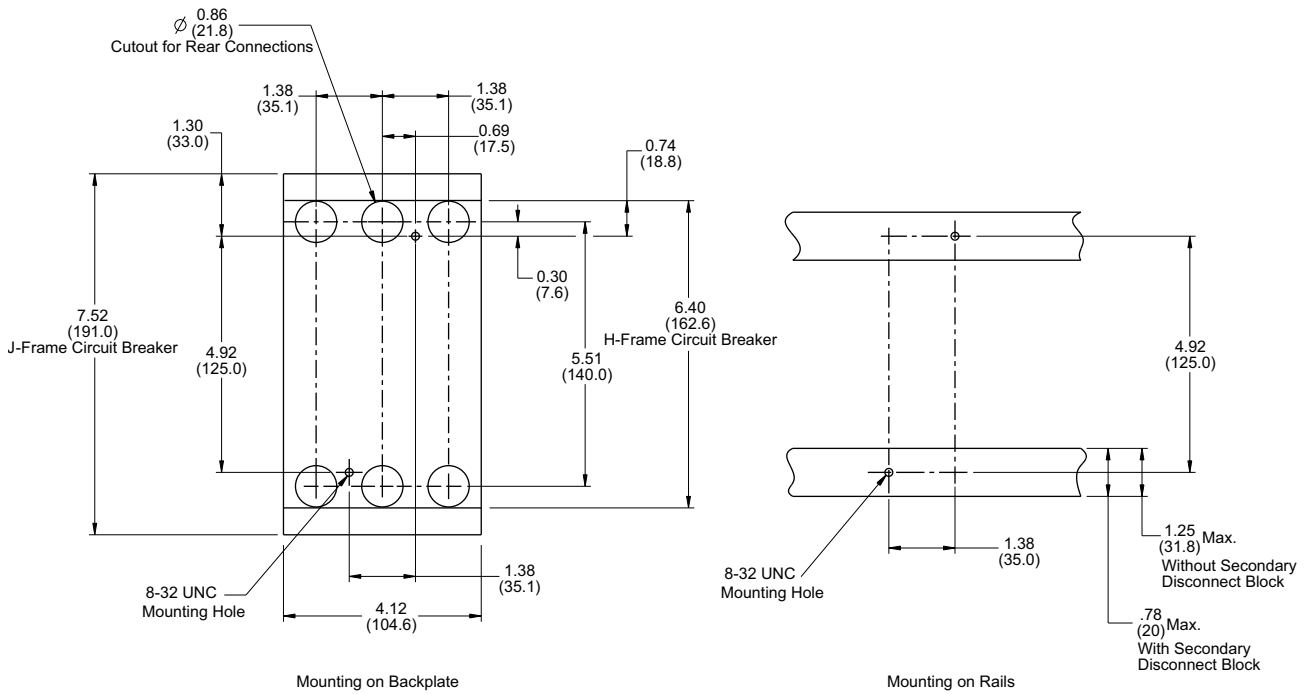



# PowerPacT H- and J-Frame Circuit Breaker Door Cutouts

## PowerPacT H- and J-Frame Circuit Breaker Toggle Handle Door Cutout

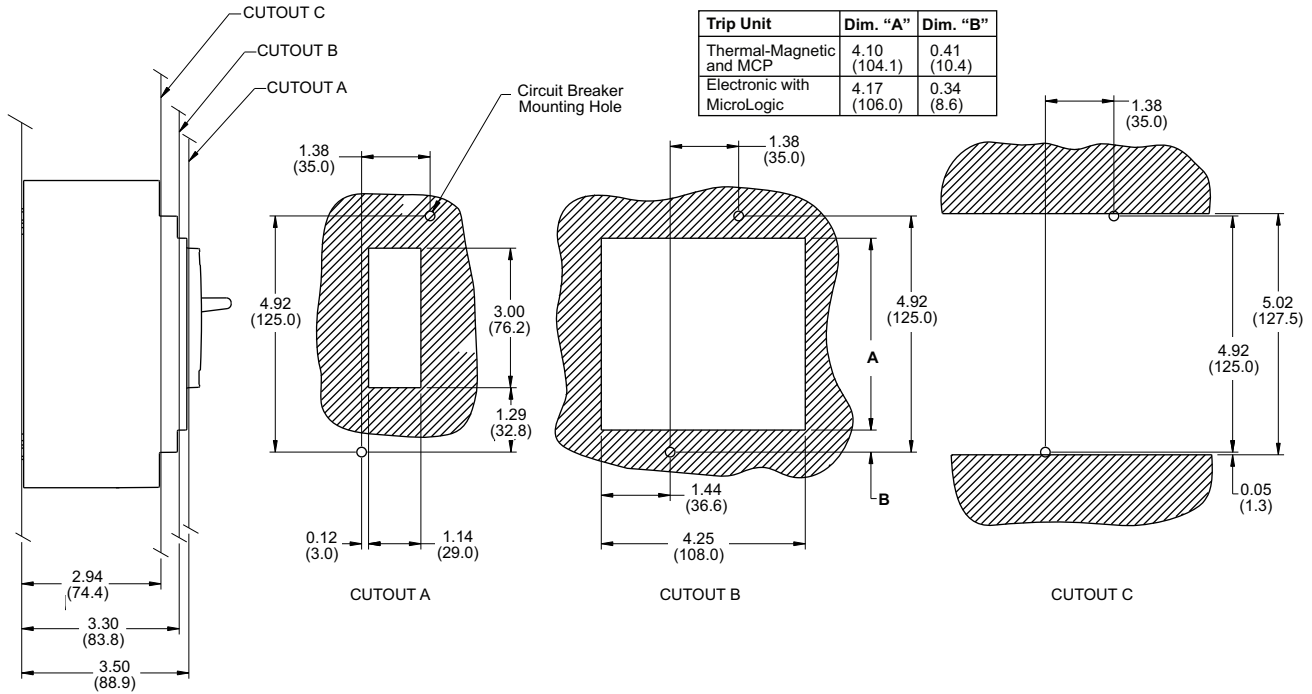

## PowerPacT H- and J-Frame Circuit Breaker Toggle Handle With Escutcheon Door Cutout

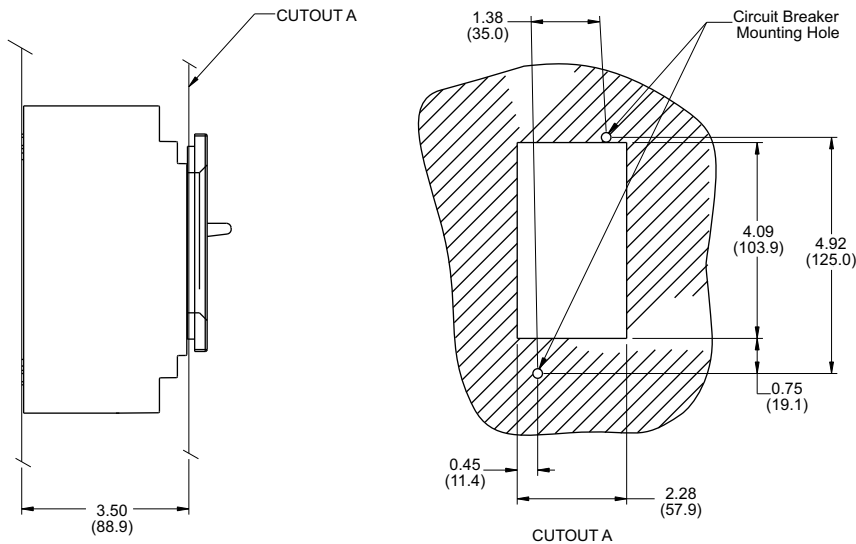

### PowerPacT H- and J-Frame Circuit Breaker Fixed Rotary Handle Cutout

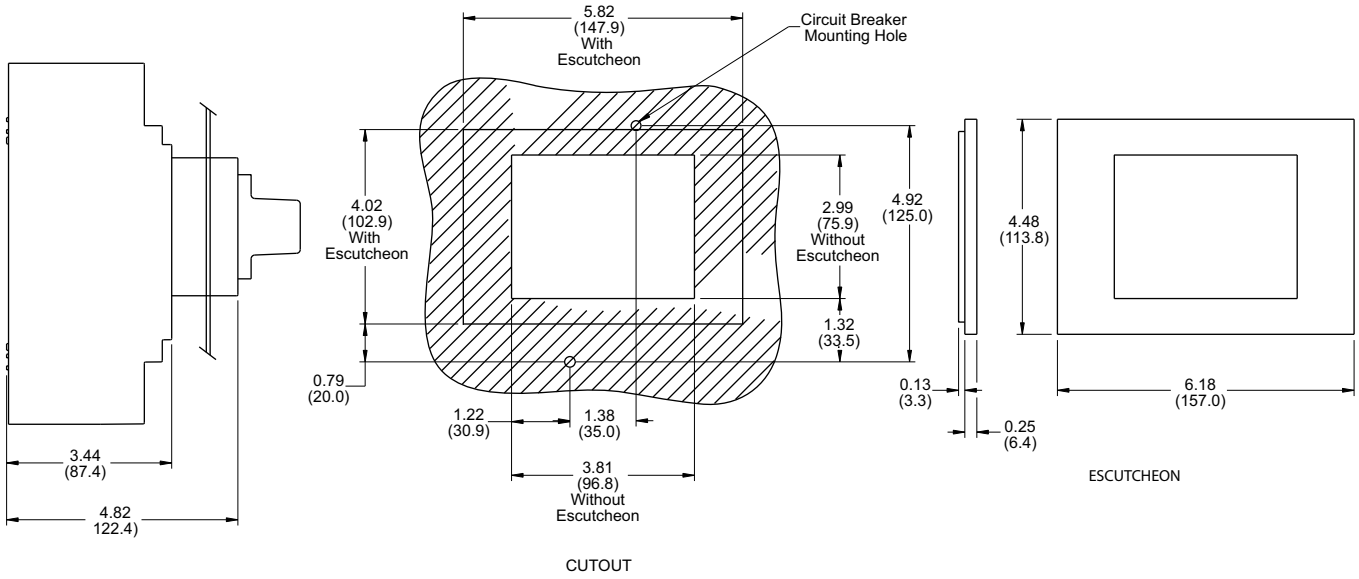

### PowerPacT H- and J-Frame Circuit Breaker Door Mounted Rotary Handle Cutout

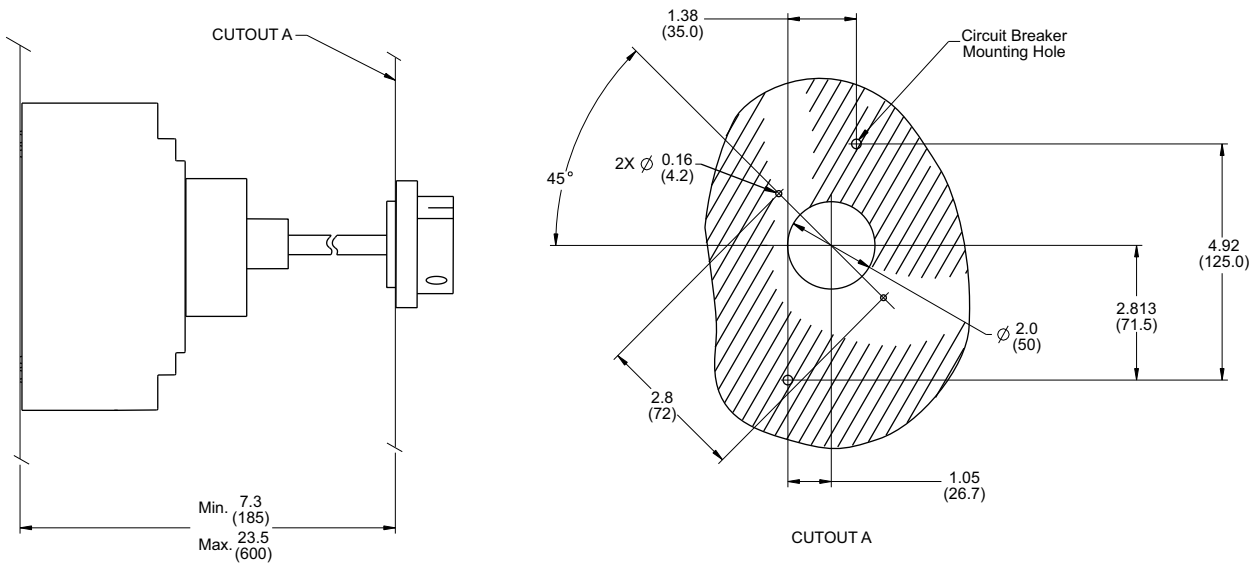

### PowerPacT H- and J-Frame Circuit Breaker Motor Operator Cutout

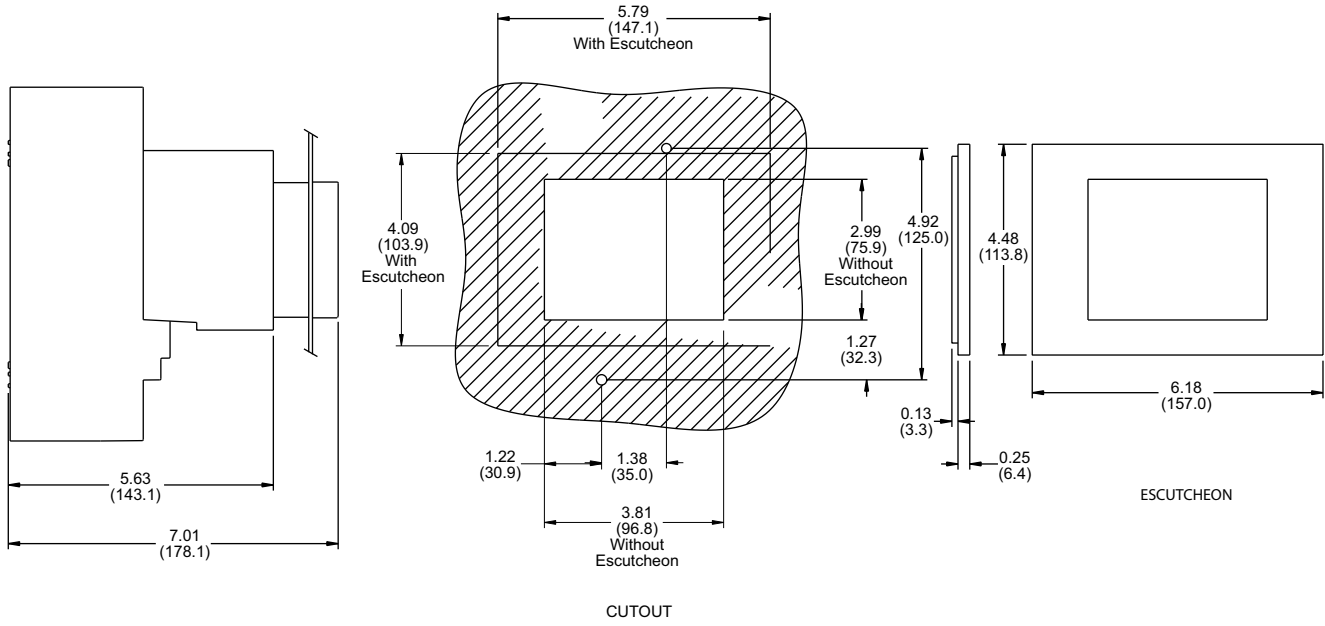

# PowerPacT L-Frame Circuit Breakers

## PowerPacT L-Frame Fixed Mounted Circuit Breaker

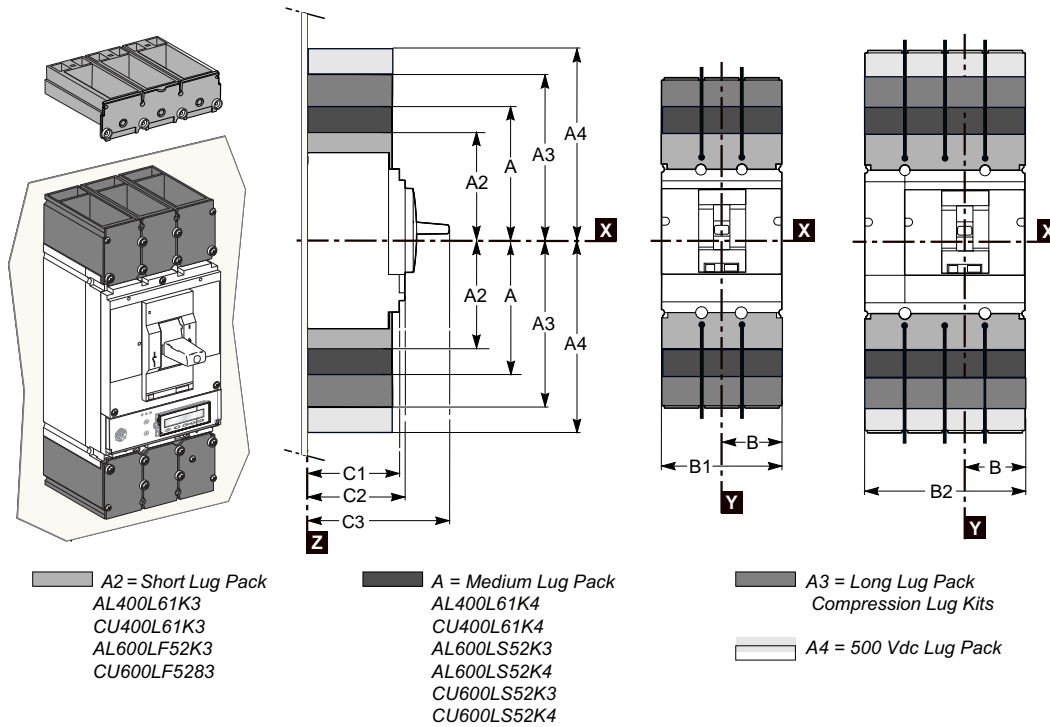

	A	A2	A3	A4	B	B1	B2	C1	C2	C3
inch	6.69	5.65	7.87	9.53	2.76	5.51	7.28	3.76	4.33	6.61
mm	170	143.5	200	242	70	140	185	105	110	168

## PowerPacT L-Frame Circuit Breaker Mounting

Mounting on Backplate

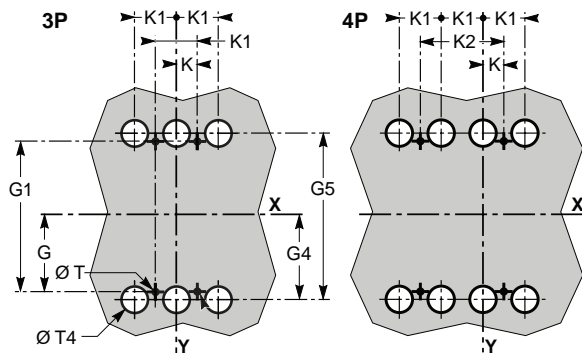

Mounting on Rails

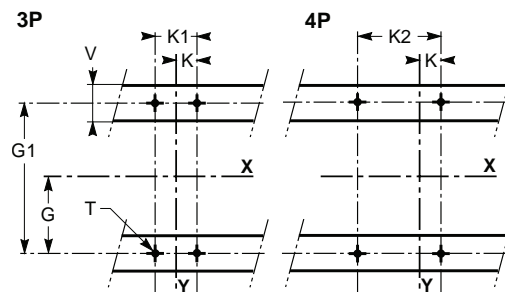

	G	G1	G4	G5	K <sup>212</sup>	K1	K1	K2	T <sup>213</sup>	U <sup>214</sup>
inch	3.93	7.87	4.46	8.93	0.88	1.77	3.54	0.23	1.25	1.38
mm	100	200	113.5	227	22.5	45	90	6	32	35

212. For 2 pole circuit breaker, the middle holes are not required.

213. For rear connected circuit breakers only.

214. V is £ 78 in. (20 mm) on C-frame circuit breakers with secondary disconnecting blocks.

**Front Panel Cutouts for PowerPacT L-Frame Fixed or Plug-In Circuit Breakers**

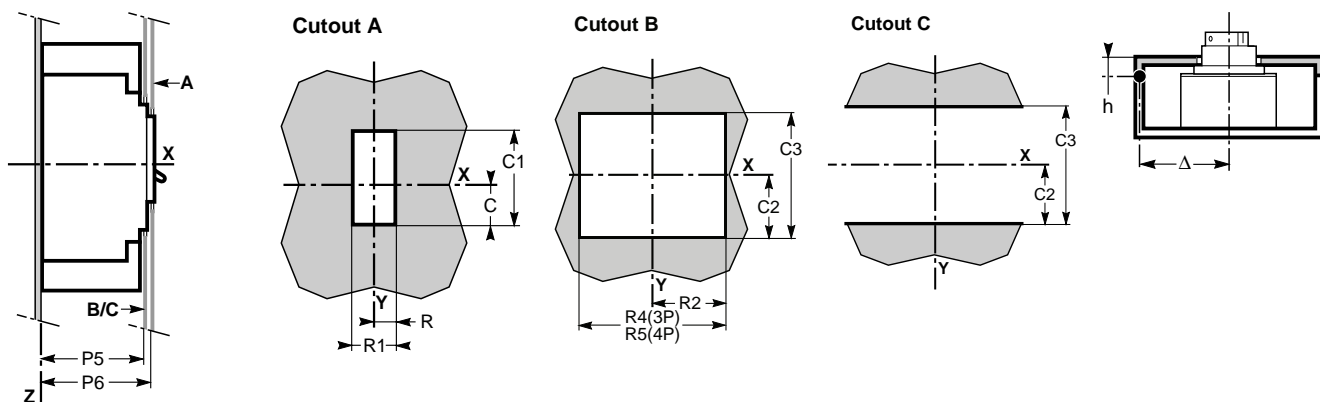

	C	C1	C2	C3	P5	P6	R	R1	R2	R4	R5	Δ
inch	1.63	4.56	3.64	7.24	4.21	4.40	1.24	2.48	2.81	5.62	7.40	3.93 + (5 x h)
mm	41.5	116	92.5	184	107	112	31.5	63	71.5	143	188	100 + (5 x h)

**PowerPacT L-Frame Circuit Breaker Front Panel Cutouts for Toggle Boot and Escutcheon**

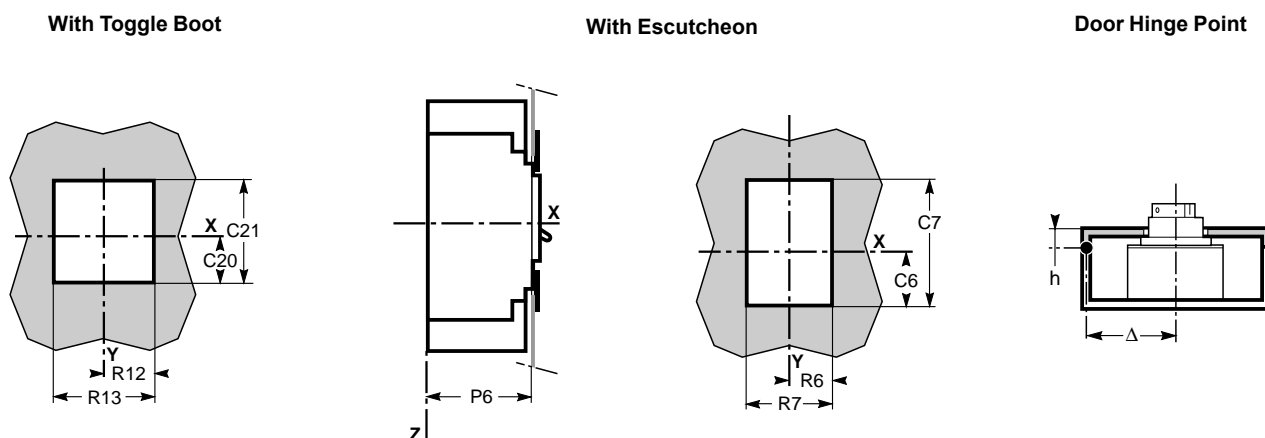

	C6	C7	C20	C21	P6	R6	R7	R12	R13	Δ
inch	2.2	6	1.83	5.00	4.40	3.5	7	2.48	4.96	3.93 + (5 x h)
mm	56.5	155	46.5	126	112	90	180	63	126	100 + (5 x h)

# PowerPacT L-Frame Plug-In and Drawout Mounting

## PowerPacT L-Frame Plug-In Circuit Breaker (On Base)

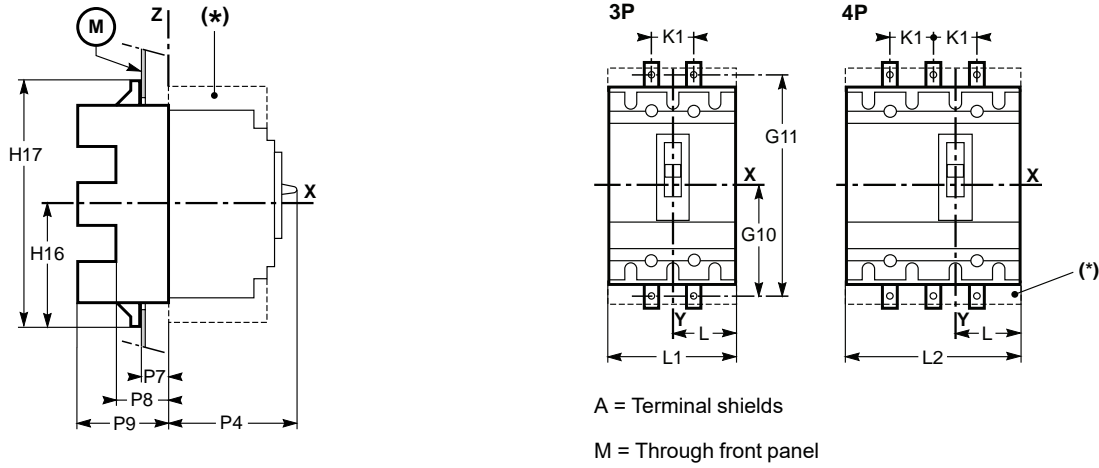

	G10	G11	H16	H17	K1	L	L1	L2	P4	P7	P8	P9
inch	5.90	11.8	6.20	12.40	1.77	2.75	5.51	7.28	6.61	1.06	1.77	3.93
mm	150	300	157.5	315	45	70	140	185	168	27	45	100

## PowerPacT L-Frame Drawout Circuit Breaker (on Cradle)

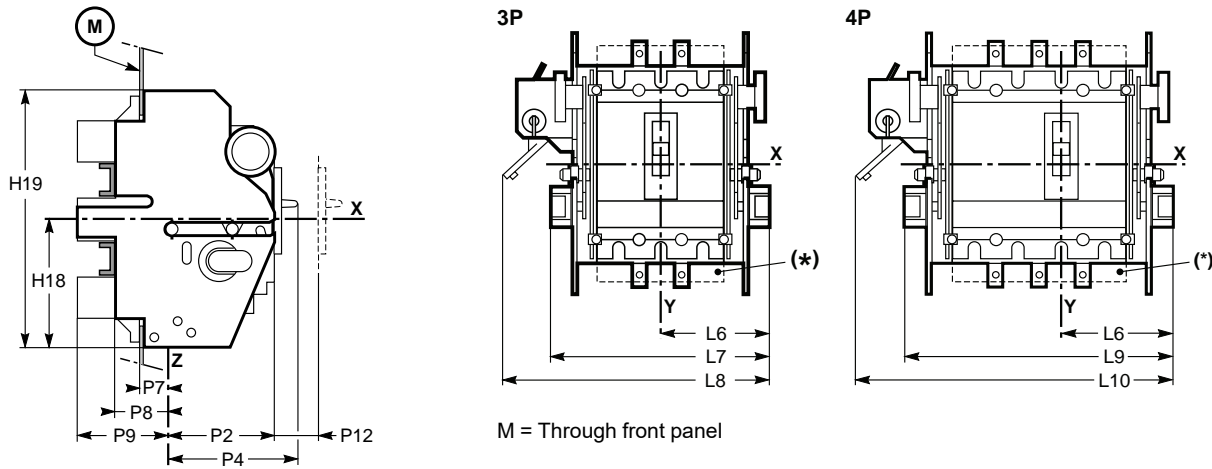

	H18	H19	L6	L7	L8	L10	P2	P4	P7	P8	P9	P12	L9
inch	5.51	11.02	4.33	8.66	98.46	11.61	4.33	6.61	1.06	1.77	3.93	1.25	10.43
mm	140	280	110	220	250	295	110	168	27	45	100	32	265

**PowerPacT L-Frame Circuit Breaker Mounting Through a Backplate**

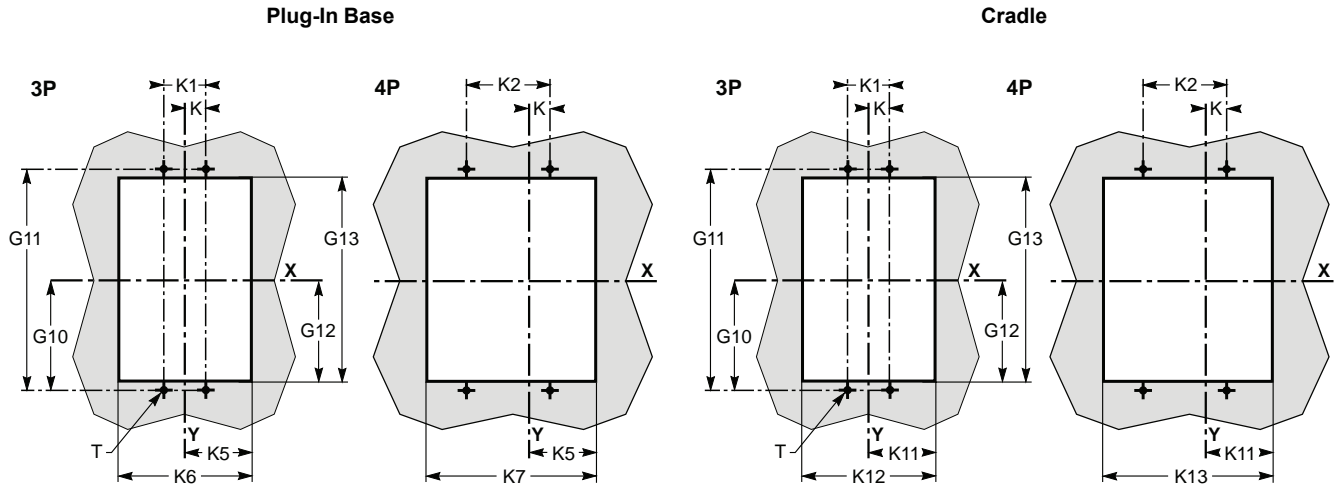

	G10	G11	G12	G13	K	K1	K2	K5	K6	K7	K11	K12	K13
inch	5.90	11.8	5.39	10.7	0.88	1.77	3.54	2.81	2.81	7.4	7.40	3.60	8.98
mm	150	300	137	274	22.5	45	90	71.5	143	188	91.5	183	228

**PowerPacT L-Frame Circuit Breaker Mounting on Rails (Plug-In Base or Cradle)**

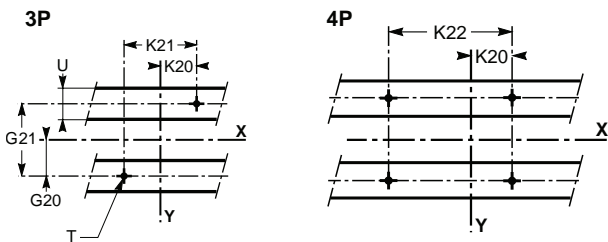

	G20	G21	K20	K21	K22	T
inch	2.95	5.90	8.97	1.96	5.71	0.24
mm	75	150	50	100	145	6

**PowerPacT L-Frame Circuit Breaker Front-Panel Cutouts**

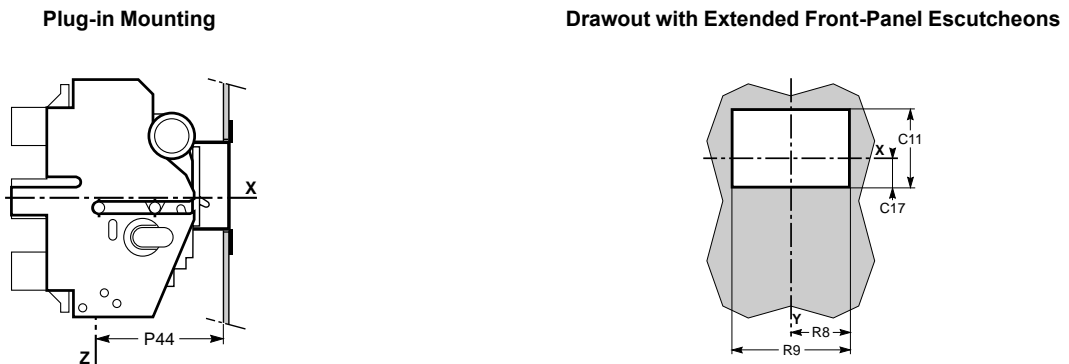

	C11	C17	P44	R8	R9
inch	6.10	2.22	5.78	3.54	7.08
mm	155	56.5	147	90	180

# PowerPacT L-Frame Circuit Breaker Handles and Handle Operators

## PowerPacT L-Frame Circuit Breaker Motor Operators

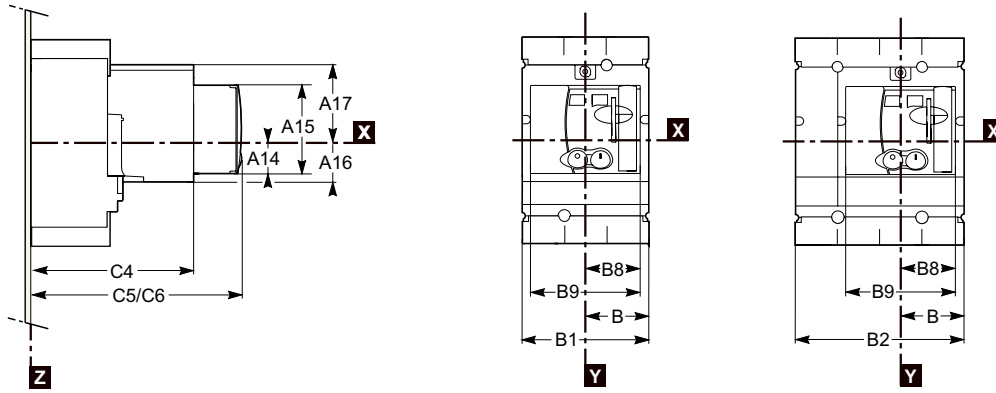

C5: without keylock  
 C6: with keylock

	A14	A15	A16	A17	B	B1	B2	B8	B9	C4	C5	C6	D1
inch	1.57	4.84	2.05	3.94	2.76	5.51	7.28	2.42	4.84	8.46	10.08	10.16	3.94
mm	40	123	52	100	70	140	185	61.5	123	215	256	258	100

## PowerPacT L-Frame Circuit Breaker Motor Operator Front-Panel Cutouts



	C22	C23	P45	R14	R15	Δ
inch	1.63	4.96	8.54	2.53	5.08	3.93 + (5 x h)
mm	41.5	126	217	64.5	129	100 + (5 x h)



**PowerPacT L-Frame Circuit Breaker Cable-Operating Handles**

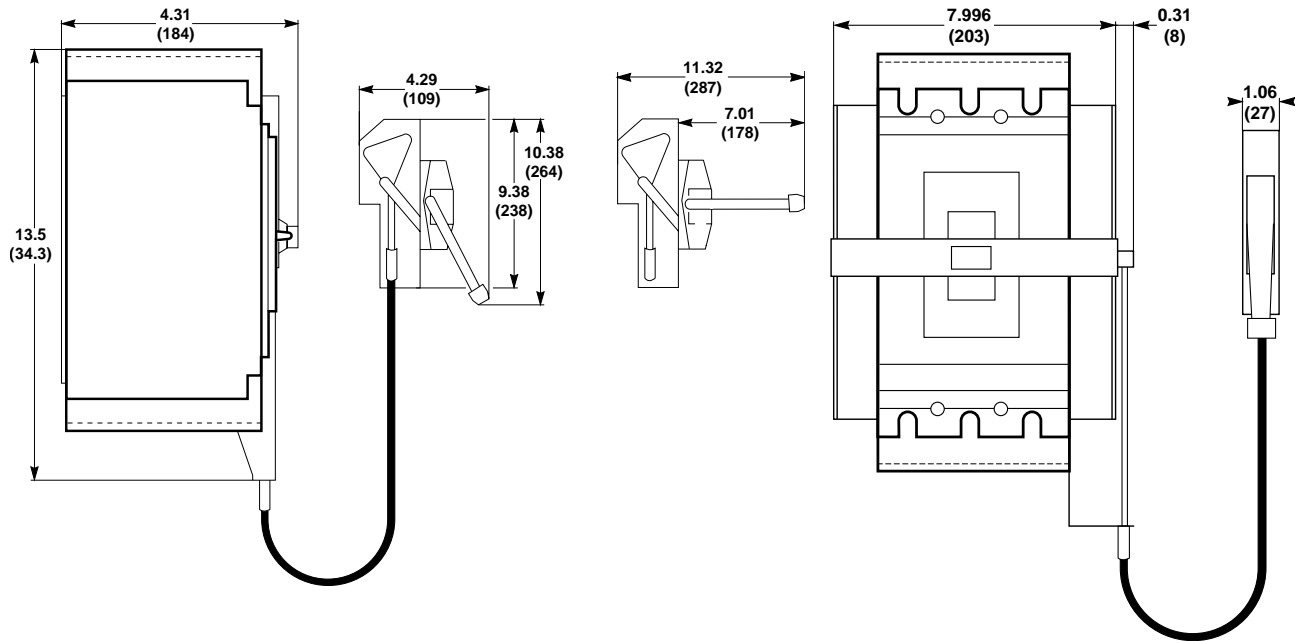

**PowerPacT L-Frame Circuit Breaker Rotary-Operating Handles**

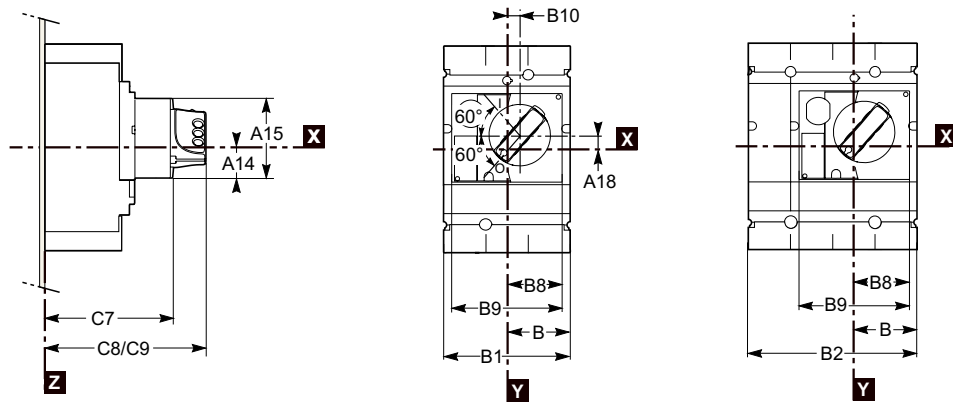

C8: without keylock  
 C9: with keylock

	A14	A15	A18	B	B1	B2	B8	B9	B10	C7	C8	C9	D1
inch	1.57	4.84	0.97	2.76	5.51	7.28	2.42	4.84	0.20	5.71	7.05	7.40	3.94
mm	40	123	24.6	70	140	185	61.5	123	5	145	179	188	100

**PowerPacT L-Frame Motor-Control Center Circuit Breaker Direct Rotary-Operating Handle**

Front-Panel Cutout

Operating Handle

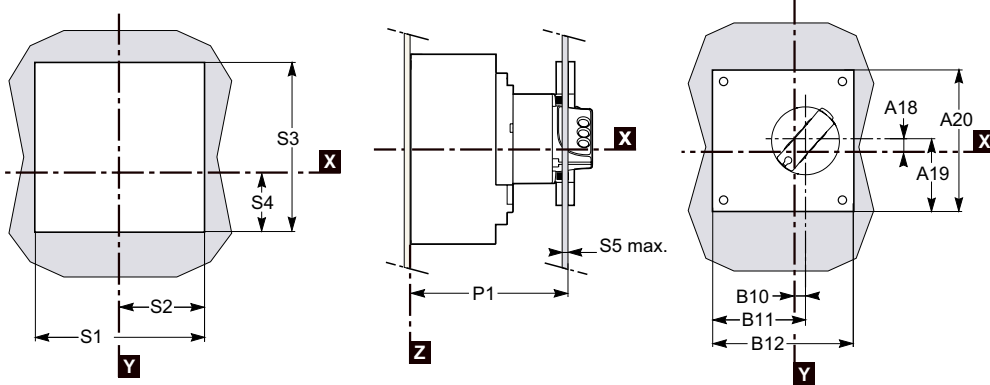

	A18	A19	A20	B10	B11	B12	P1	S1	S2	S3	S4	S5
inch	0.97	3.27	6.30	0.20	3.35	6.30	5.87	5.71	2.95	5.71	2.01	0.04–0.12
mm	24.6	83	160	5	85	160	149	145	75	145	51	1–3

**PowerPacT L-Frame Circuit Breaker Extended Rotary Handle Mounting**

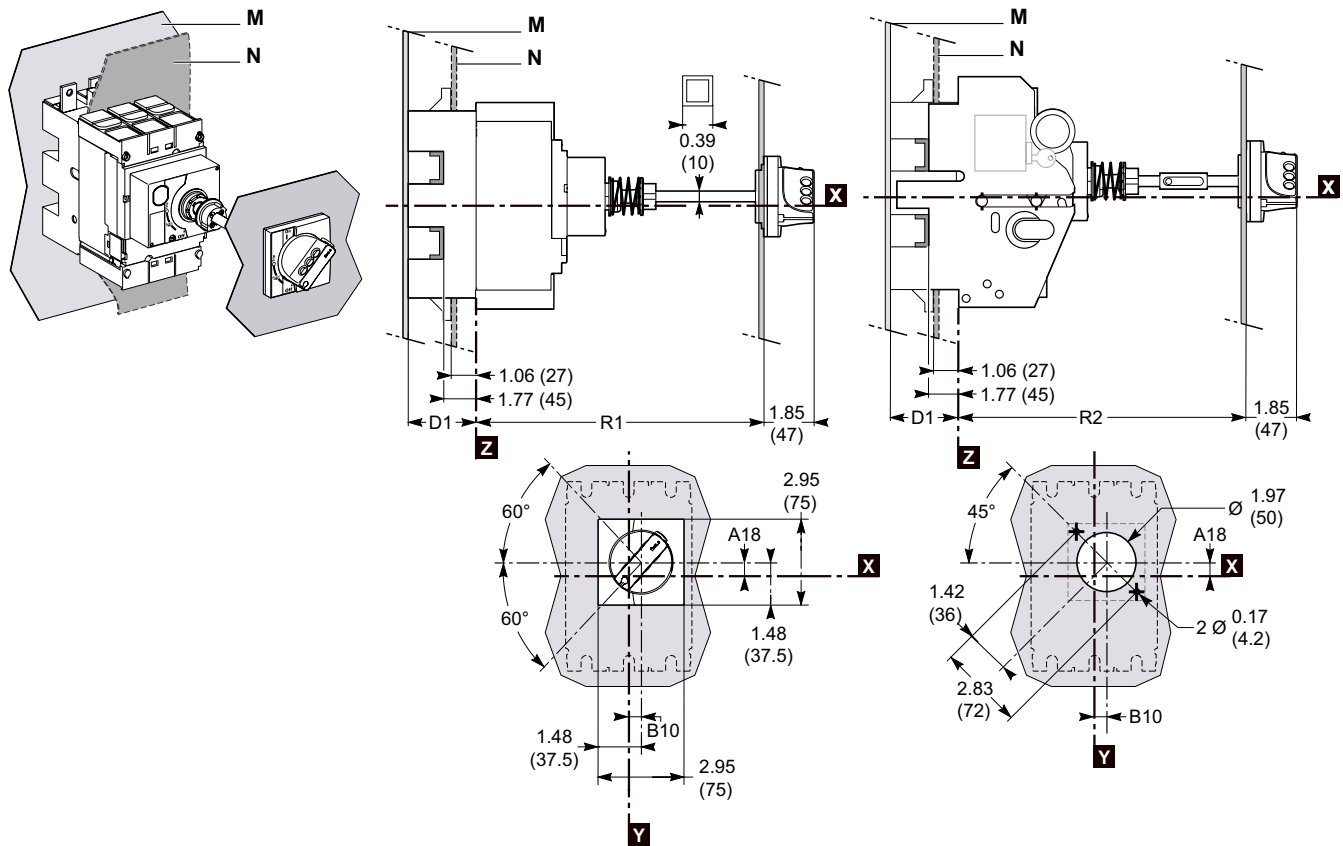

	R1 min	R1 max	R2 min	R2 max	A18	B10	D1
inch	7.68	23.62	10.71	23.62	0.97	0.20	3.94
mm	195	600	272	600	24.6	5	100

# PowerPacT L-Frame Circuit Breaker Front Accessories

## PowerPacT L-Frame Circuit Breaker Extended Escutcheons

For toggle

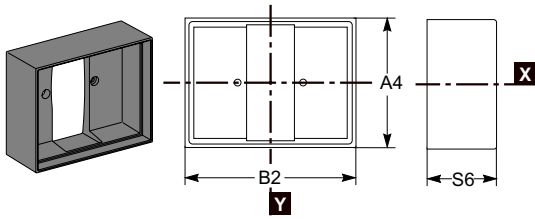

IP43 toggle cover

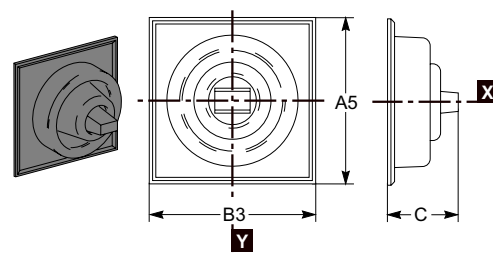

	A4	A5	B2	B3	C	S6
inch	4.82	5.43	4.82	5.43	2.36	1.38
mm	122.5	134	122.5	134	60	35

## PowerPacT L-Frame Circuit Breaker Front-Panel Escutcheons

For Toggle

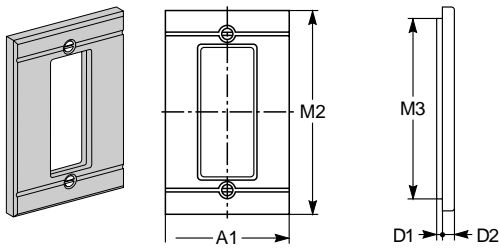

or Extended Escutcheon, Motor Operator Module or Rotary Handle

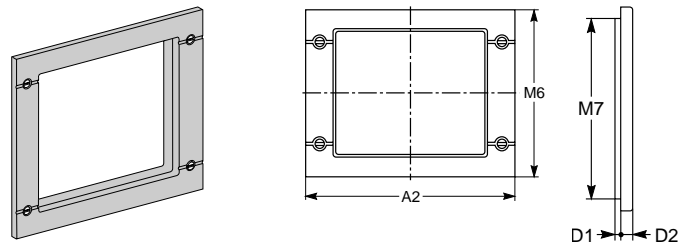

	A1	A2	D1	D2	M2	M3	M6	M7
inch	4.01	7.44	0.13	0.25	6.10	5.59	6.45	5.94
mm	102	189	3.5	6.5	115	142	164	151

# PowerPacT L-Frame Circuit Breaker Interlocking Systems

## PowerPacT L-Frame Circuit Breaker Interlocking Systems with Rotary-Operating Handles

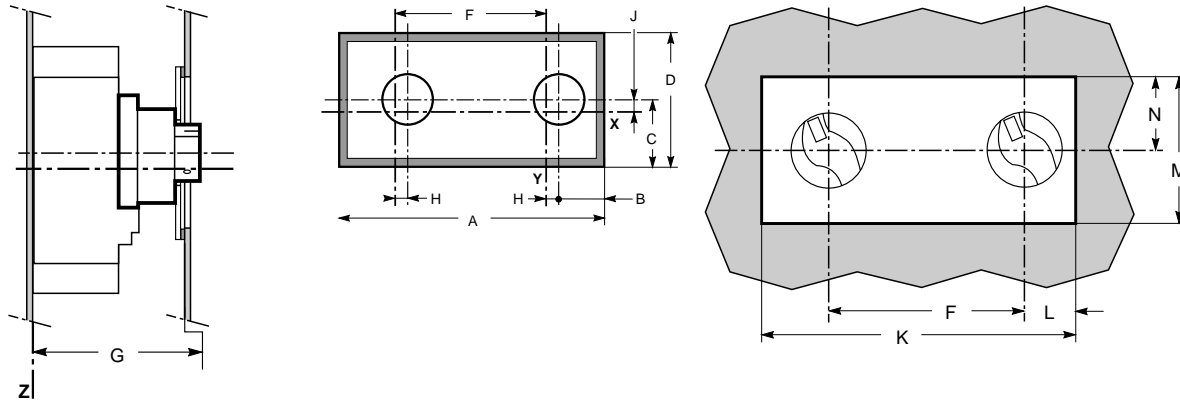

	A	B	C	D	F	G	H	J	K	L	M	N
inch	16.38	4.53	3.94	7.87	8.27	6.18	0.20	0.97	15.20	3.94	6.89	2.93
mm	416	115	100	200	210	157	5	24.6	386	100	175	74.5

## PowerPacT L-Frame Circuit Breaker Interlocking Systems with Toggle Handles

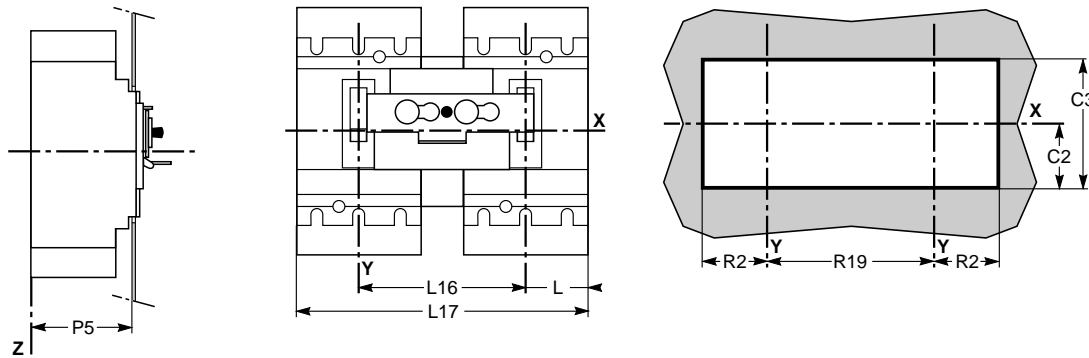

	C2	C3	L	L16	L17	R2	R19	P5
inch	3.64	7.24	2.75	7.28	12.79	2.81	7.28	4.21
mm	92.5	184	70	185	325	71.5	185	107

# PowerPacT L-Frame Circuit Breaker Connectors

## PowerPacT L-Frame Circuit Breaker Fixed-Mounted Connections

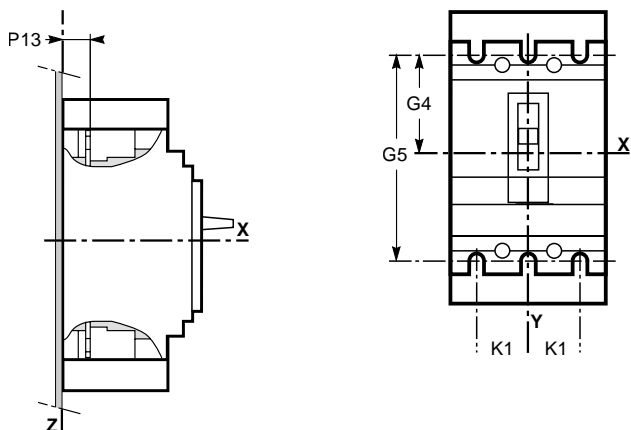

	G4	G5	K1	P13
inch	4.46	8.93	1.77	1.02
mm	113.5	227	45	526

## PowerPacT L-Frame Circuit Breaker Front Connections

### Front Connections

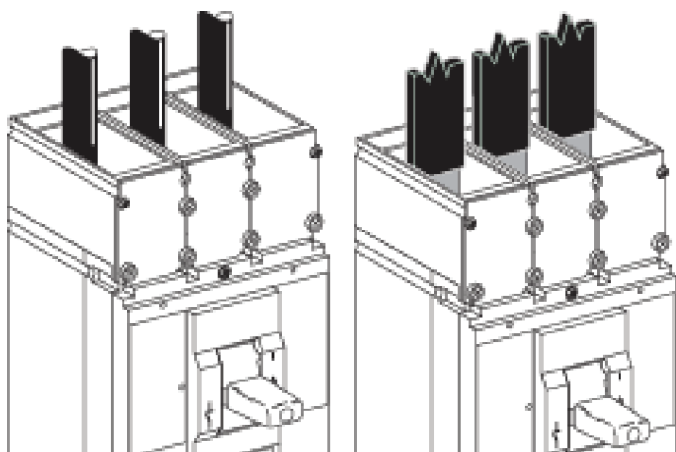

### Bus Bar Connection

M10 Screws

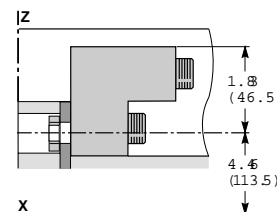
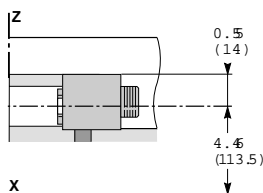
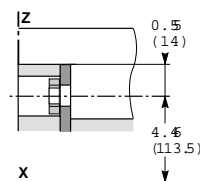

## PowerPacT L-Frame Circuit Breaker Rear Connections

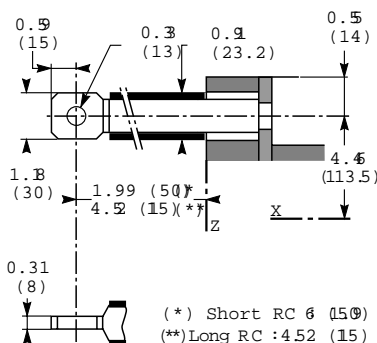
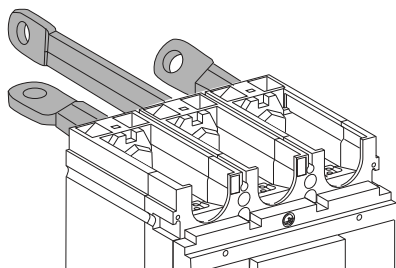

**PowerPacT L-Frame Circuit Breaker Plug-In or Drawout Mounting Connections**

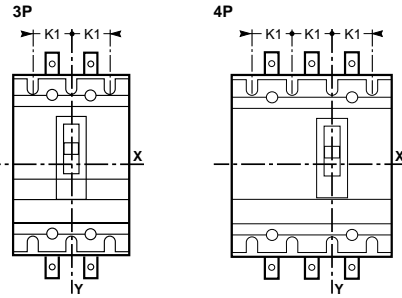
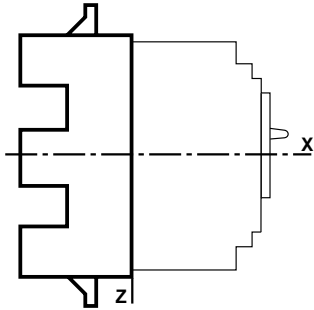

	K1
inch	1.77
mm	45

**PowerPacT L-Frame Circuit Breaker Rear Connections Fitted at Lower Limit**

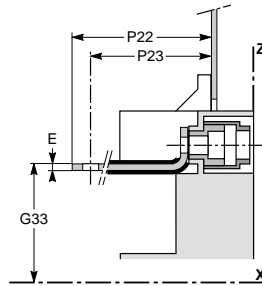
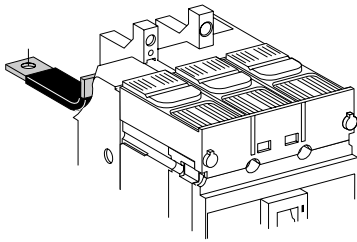

	E	G33	P22	P23
inch	0.23	4.09	4.50–7.14	3.93–6.57
mm	6	104	114.5–181.5	100–167

**PowerPacT L-Frame Circuit Breaker Rear Connections Fitted at Upper Limit**

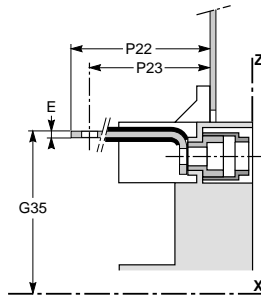
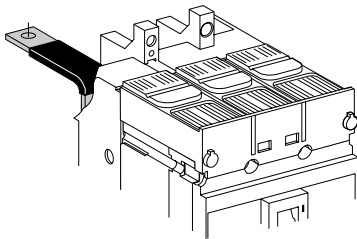

	E	G35	P22	P23
inch	0.23	5.07	4.50–7.14	3.93–6.57
mm	6	129	114.5–181.5	100–167

# Accessory Dimensions

Dimensions are in. (mm).

## IFE Ethernet Interface

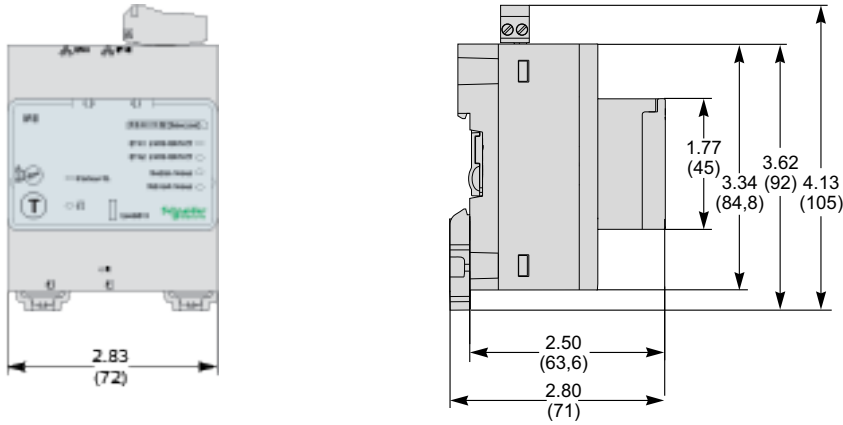

## I/O (Input/Output) Application Module

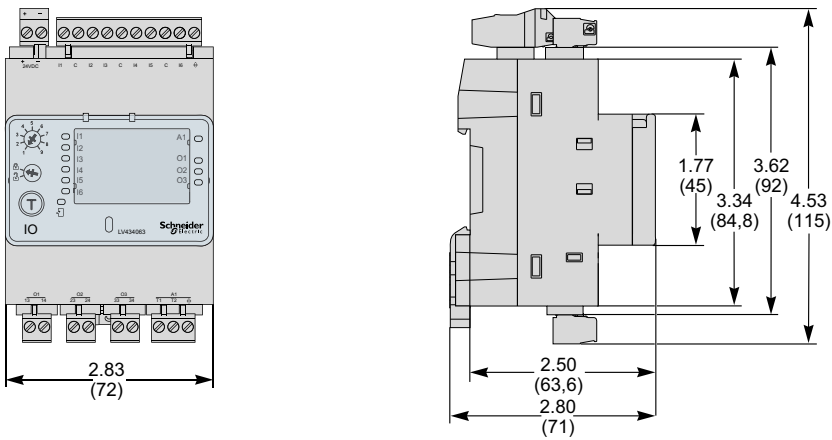

## IFM Modbus-SL Interface

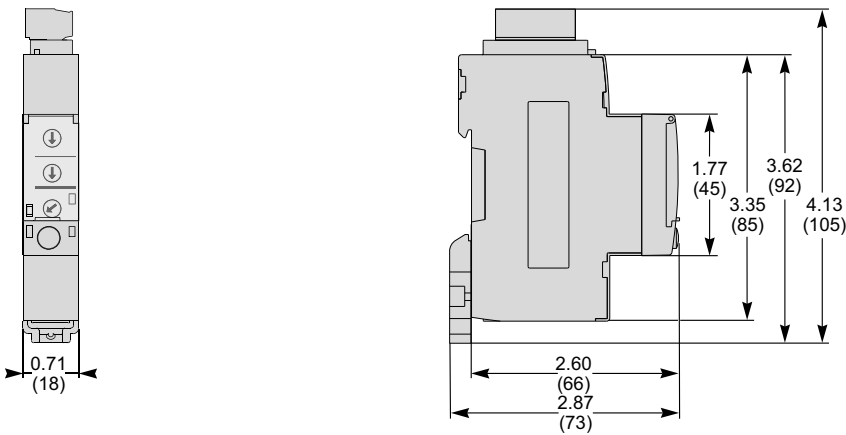

**FDM121 Switchboard Display Dimensions**

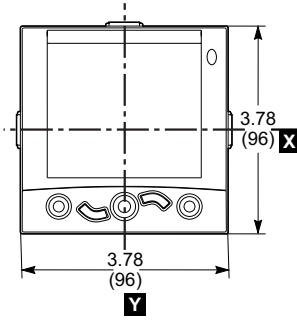
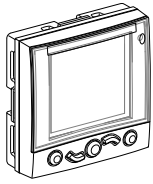

**FDM121 Switchboard Display Mounting Through Panel**

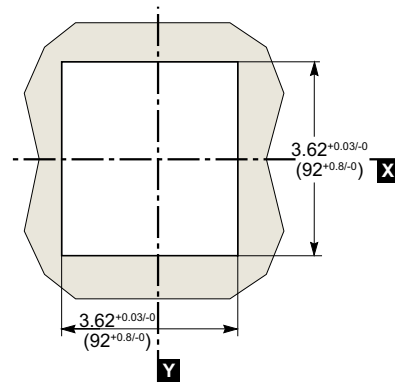
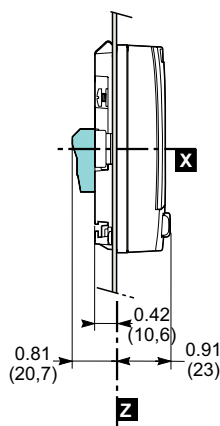
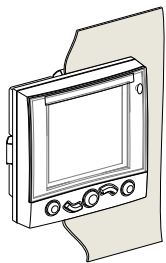

**FDM121 Switchboard Display Mounting On Panel**

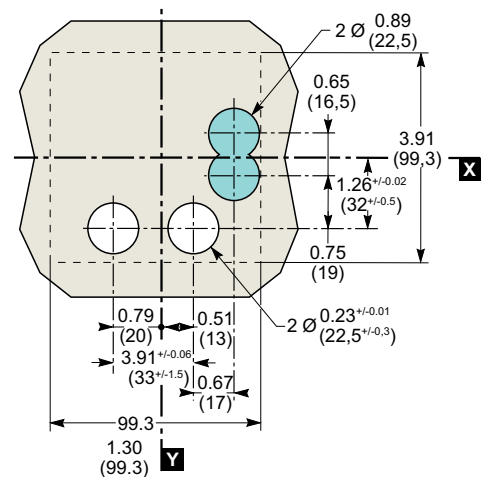
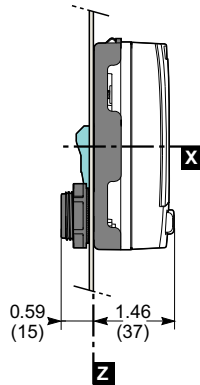
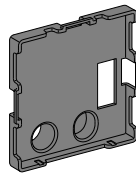
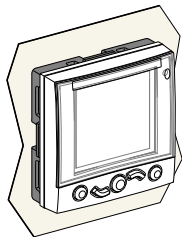



### FDM128 Switchboard Display Dimensions

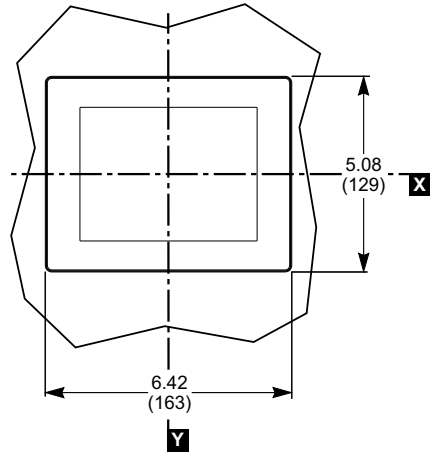
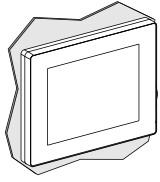

### FDM128 Switchboard Display Mounting on Panel

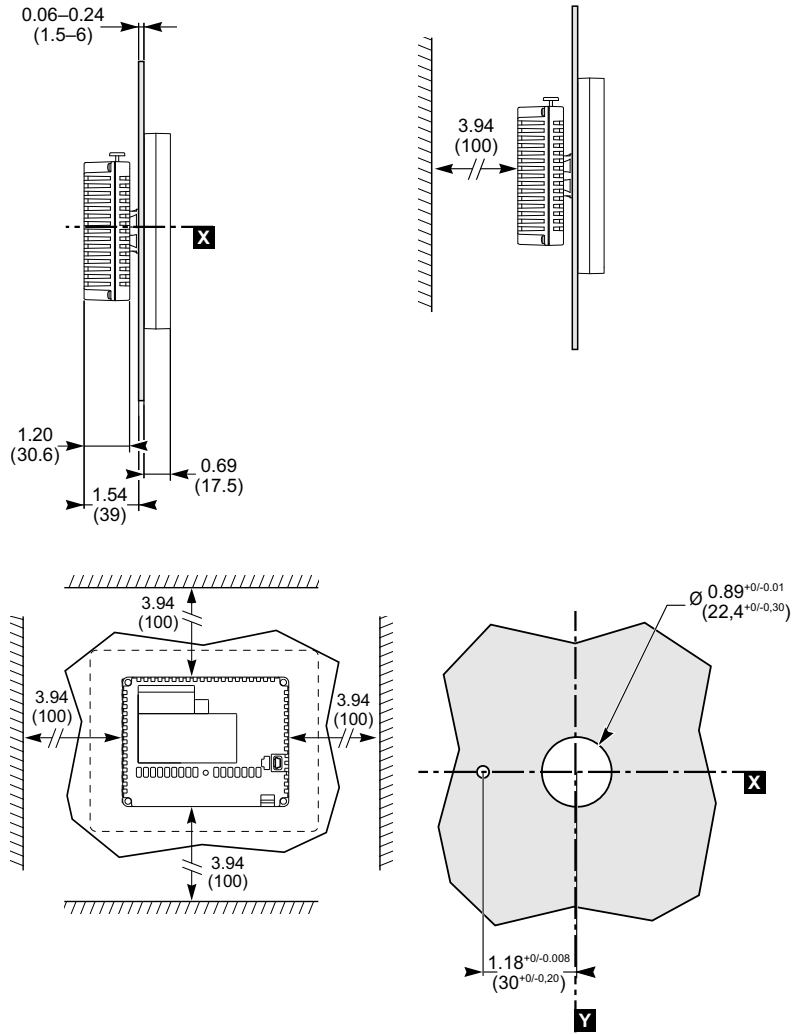
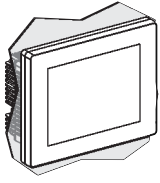

## Circuit Breaker Communication

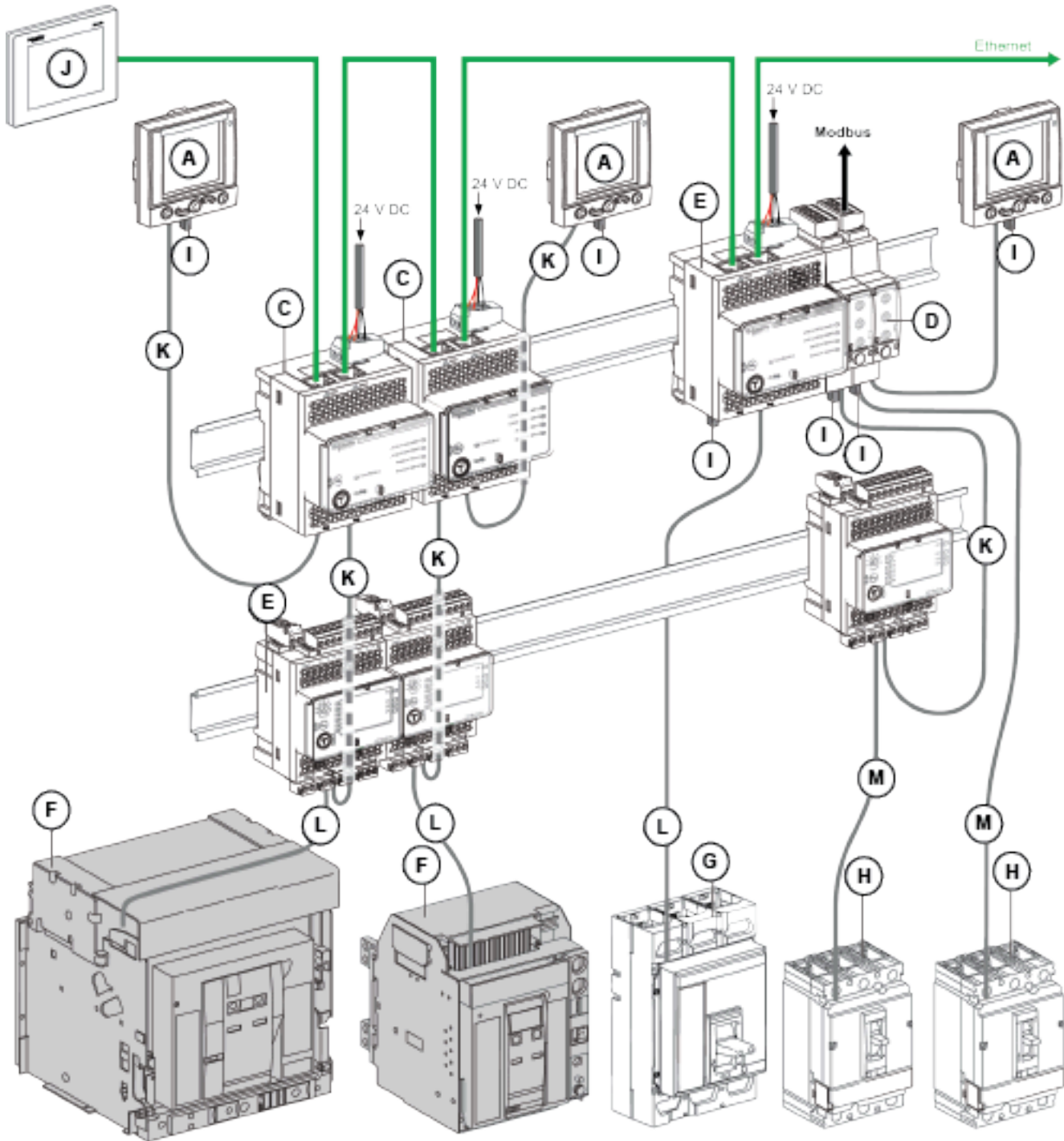

A. FDM121 (TRV00121)

B. IFE client (LV434011)

C. IFE (LV434010)

D. IFM (TRV00210)

E. I/O application module (LV434063)

F. MasterPacT NT/NW

G. PowerPac P/R

H. PowerPac H/J/L

I. ULP termination (TRV00880)

J. FDM128 (LV434128)

K. ULP cable

L. Circuit breaker ULP cord

M. NSX cord

# Trip Curves

## PowerPacT H- and J-Frame Thermal-Magnetic Trip Circuit Breakers

### H-Frame 15–35 A (HD, HG, HJ, and HL) Thermal-Magnetic Trip

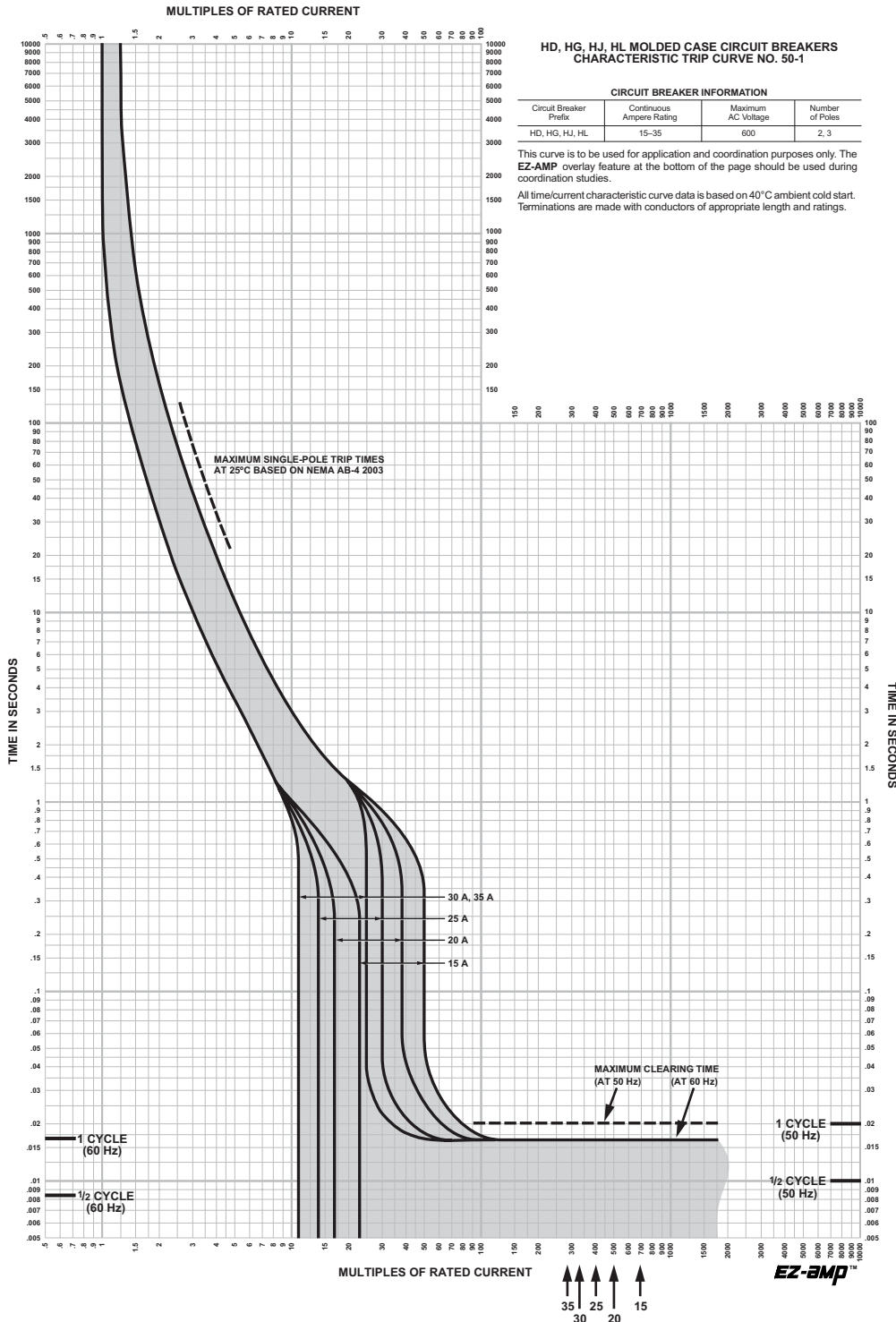

# H-Frame 40-60 A (HD, HG, HJ, and HL) Thermal-Magnetic Trip

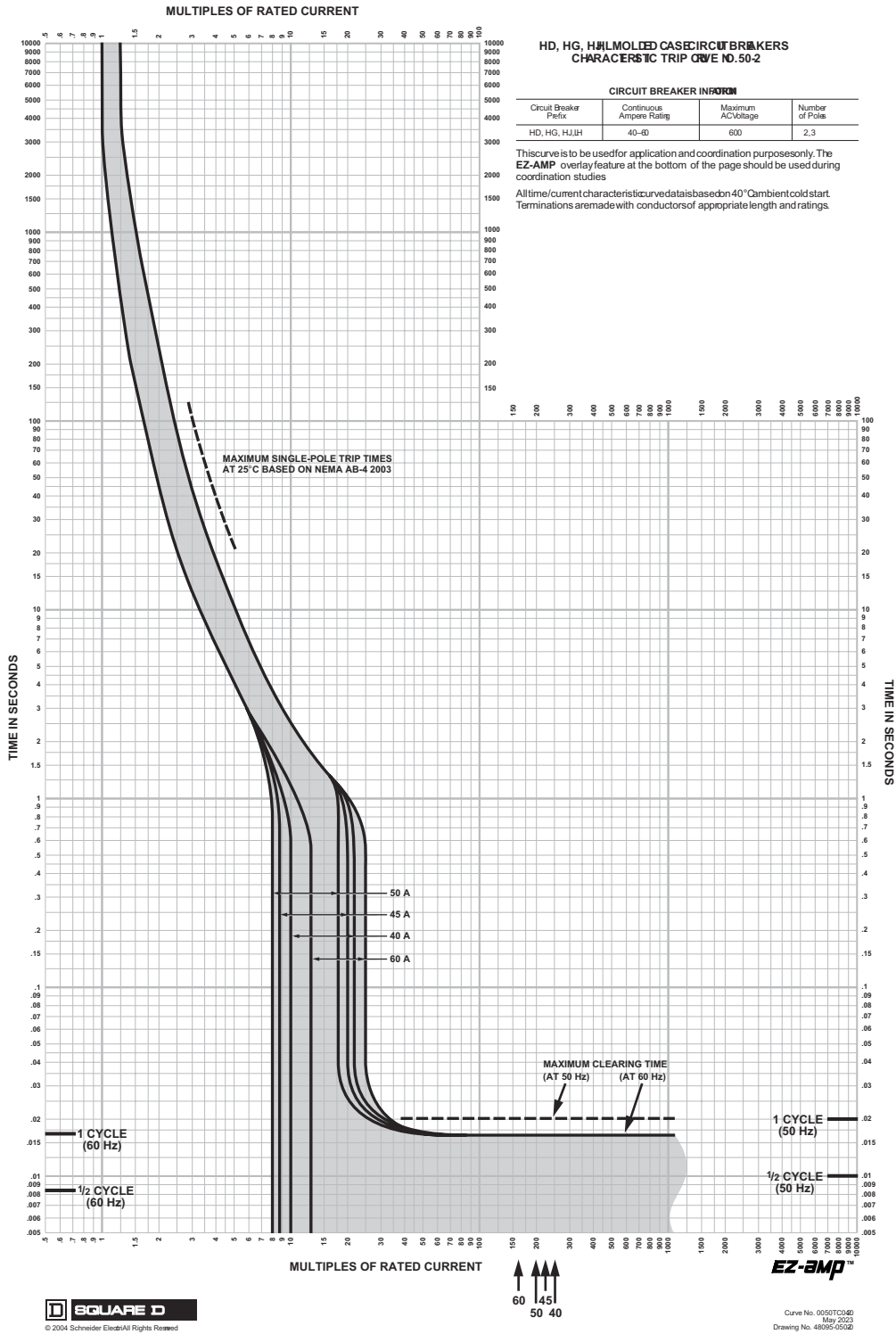

# H-Frame 70-100 A (HD, HG, HJ, and HL) Thermal-Magnetic Trip

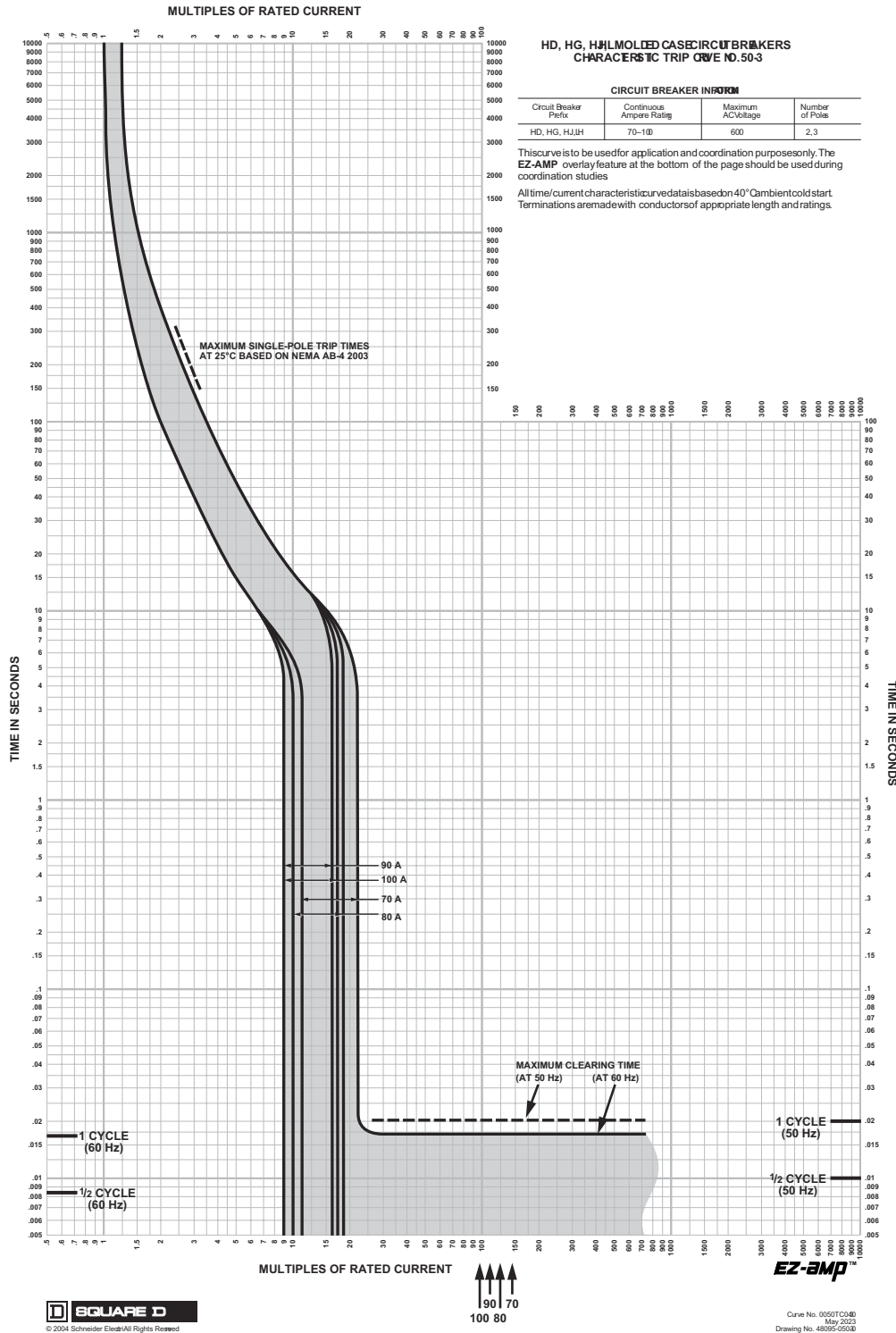

# H-Frame 110–150 A (HD, HG, HJ, and HL) Thermal-Magnetic Trip

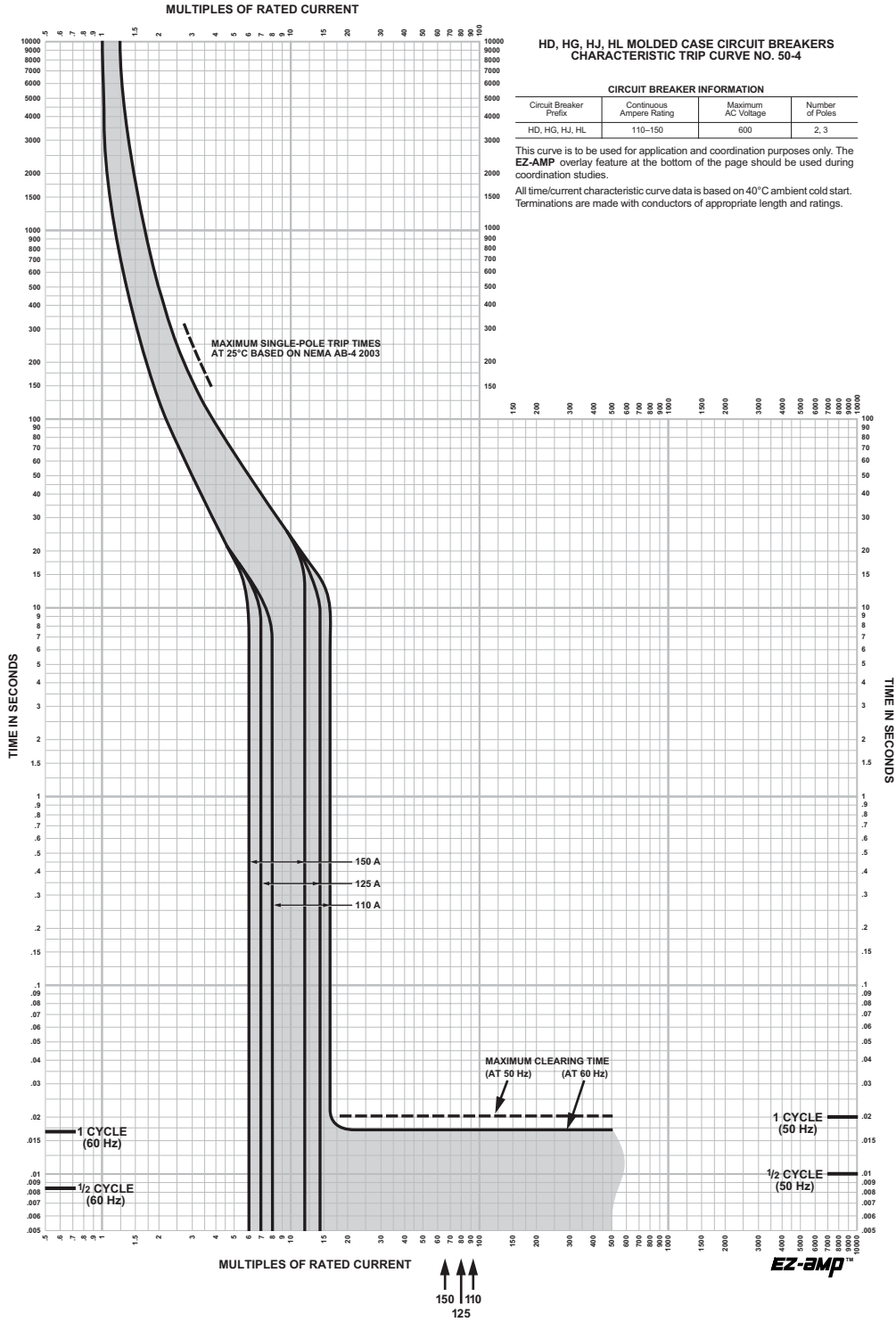

# HG and HL 30 A 500 Vdc Thermal-Magnetic Trip

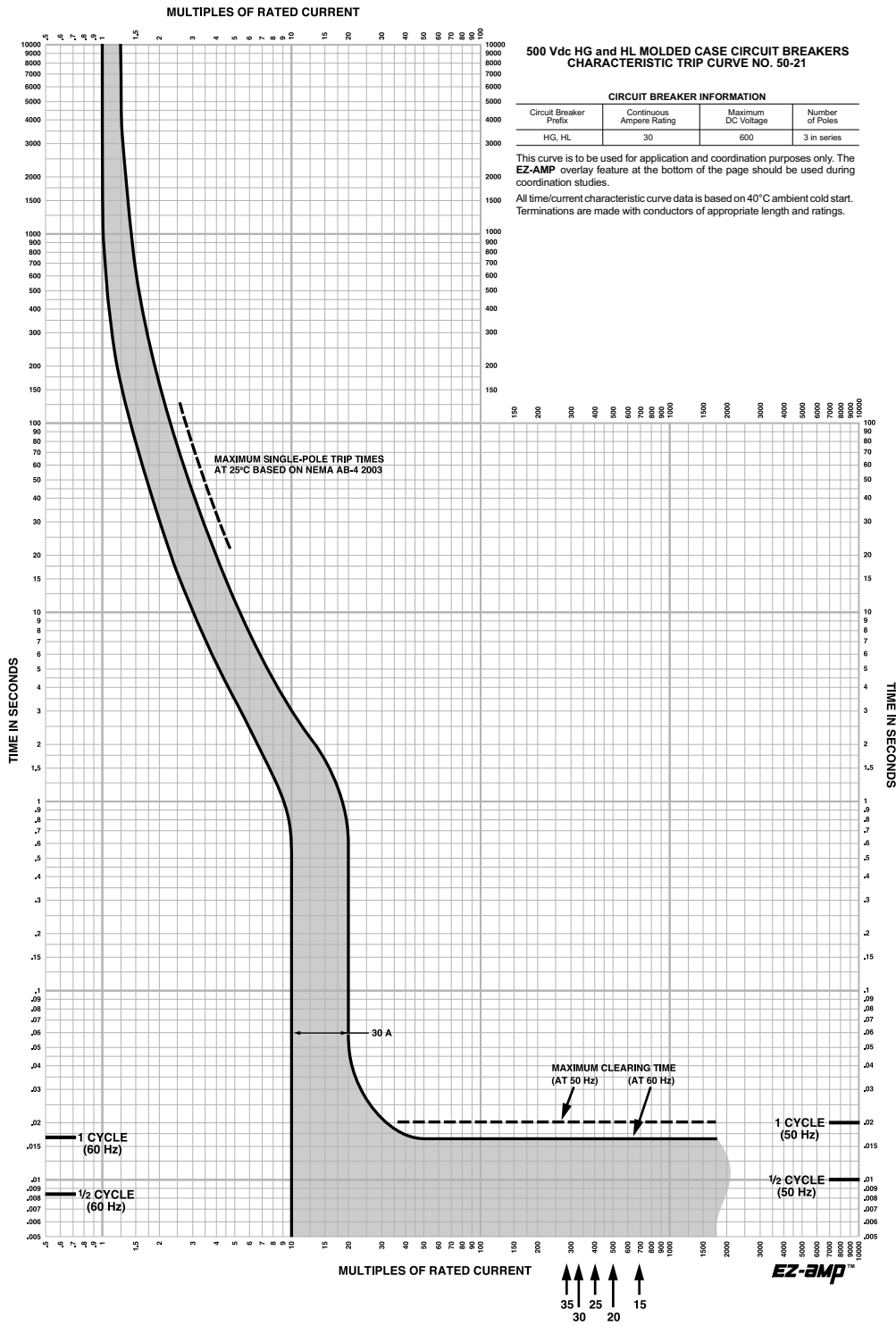

# HG and HL 50 A 500 Vdc Thermal-Magnetic Trip

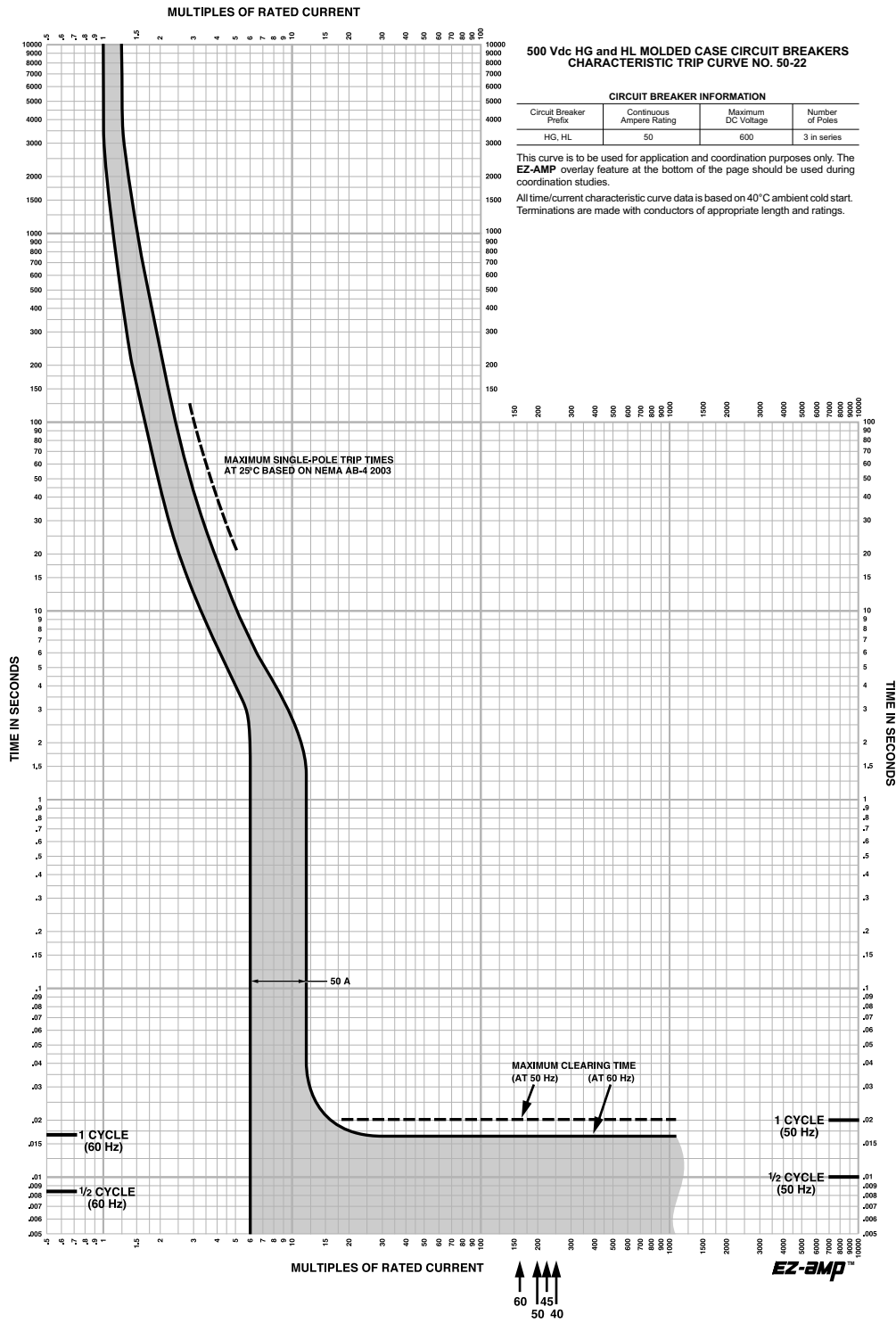



# HG and HL 370 A 500 Vdc Thermal-Magnetic Trip

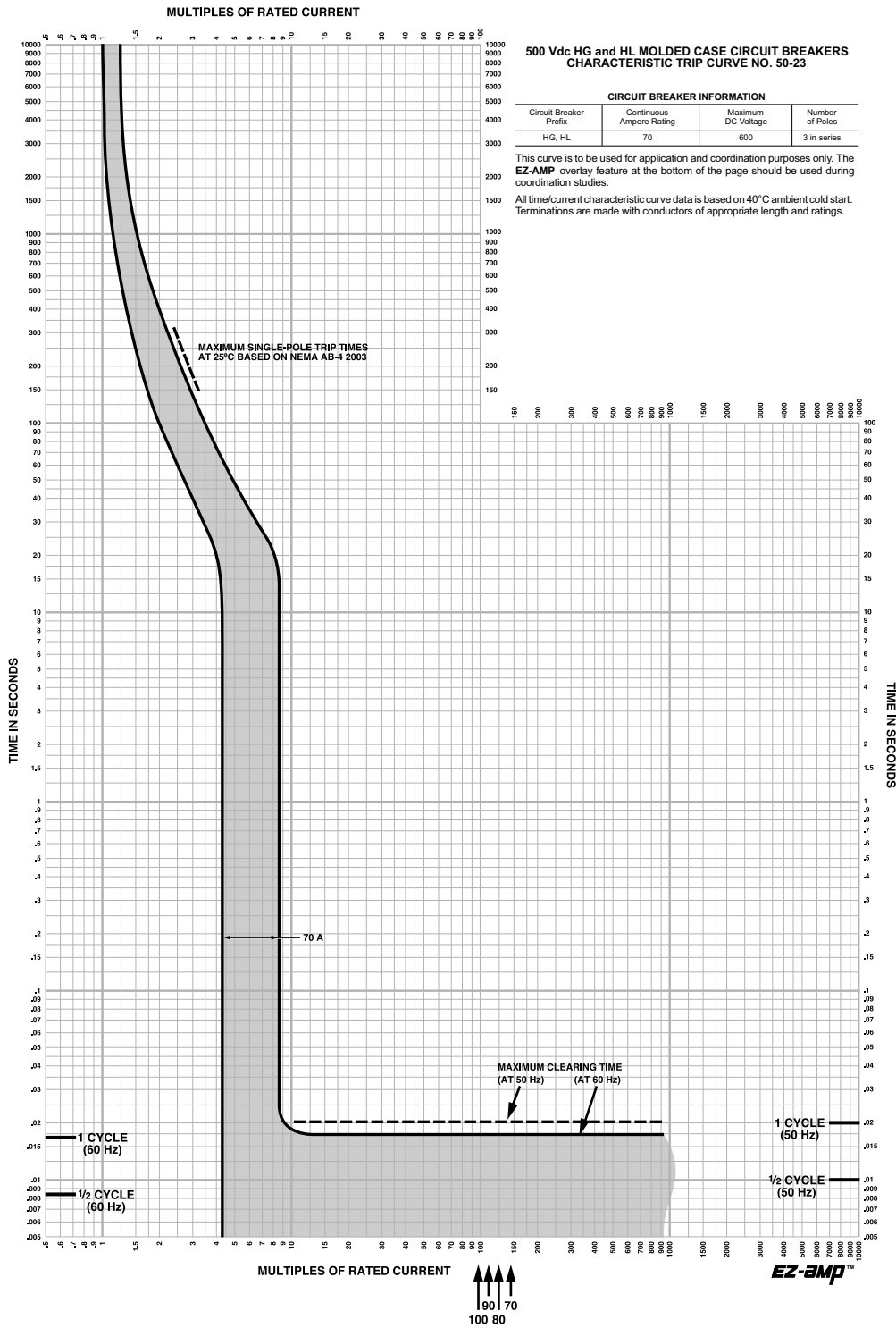

### J-Frame 150–250 A (JD, JG, JJ, JL, and JR) Thermal-Magnetic Trip

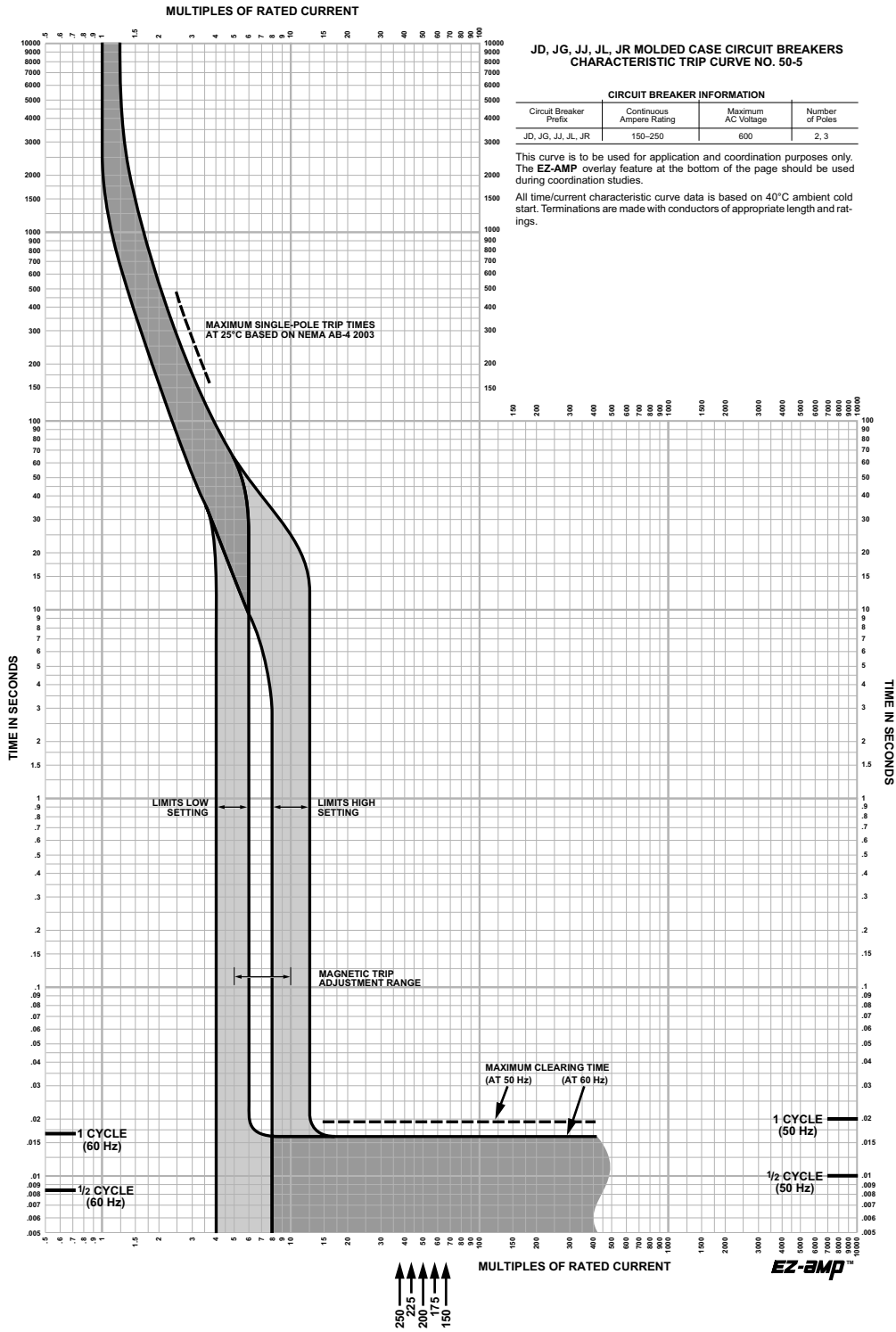

### J-Frame 100 A (JG) 500 Vdc Thermal-Magnetic 500 Trip

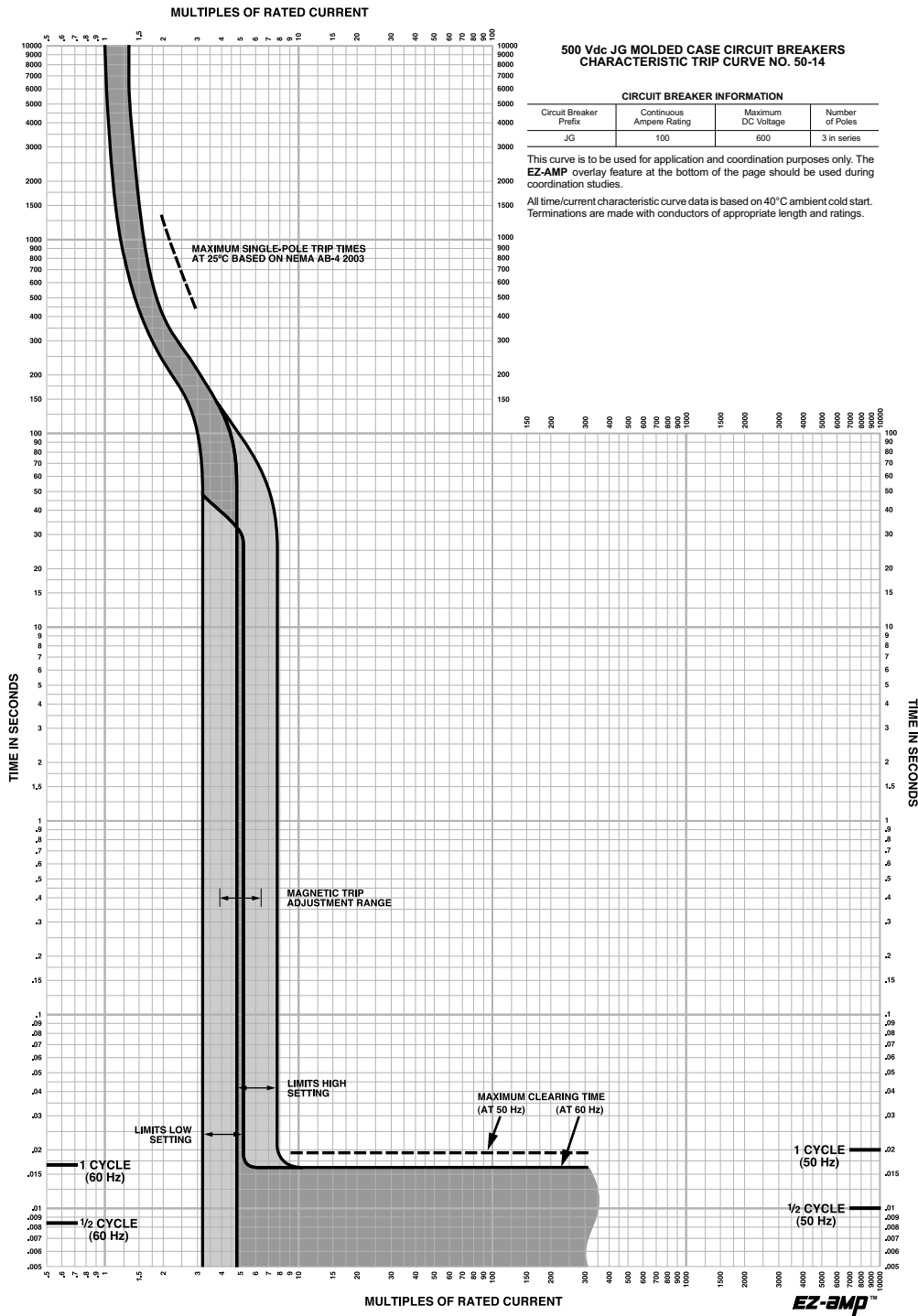

# J-Frame 125 A (JG) 500 Vdc Thermal-Magnetic Trip

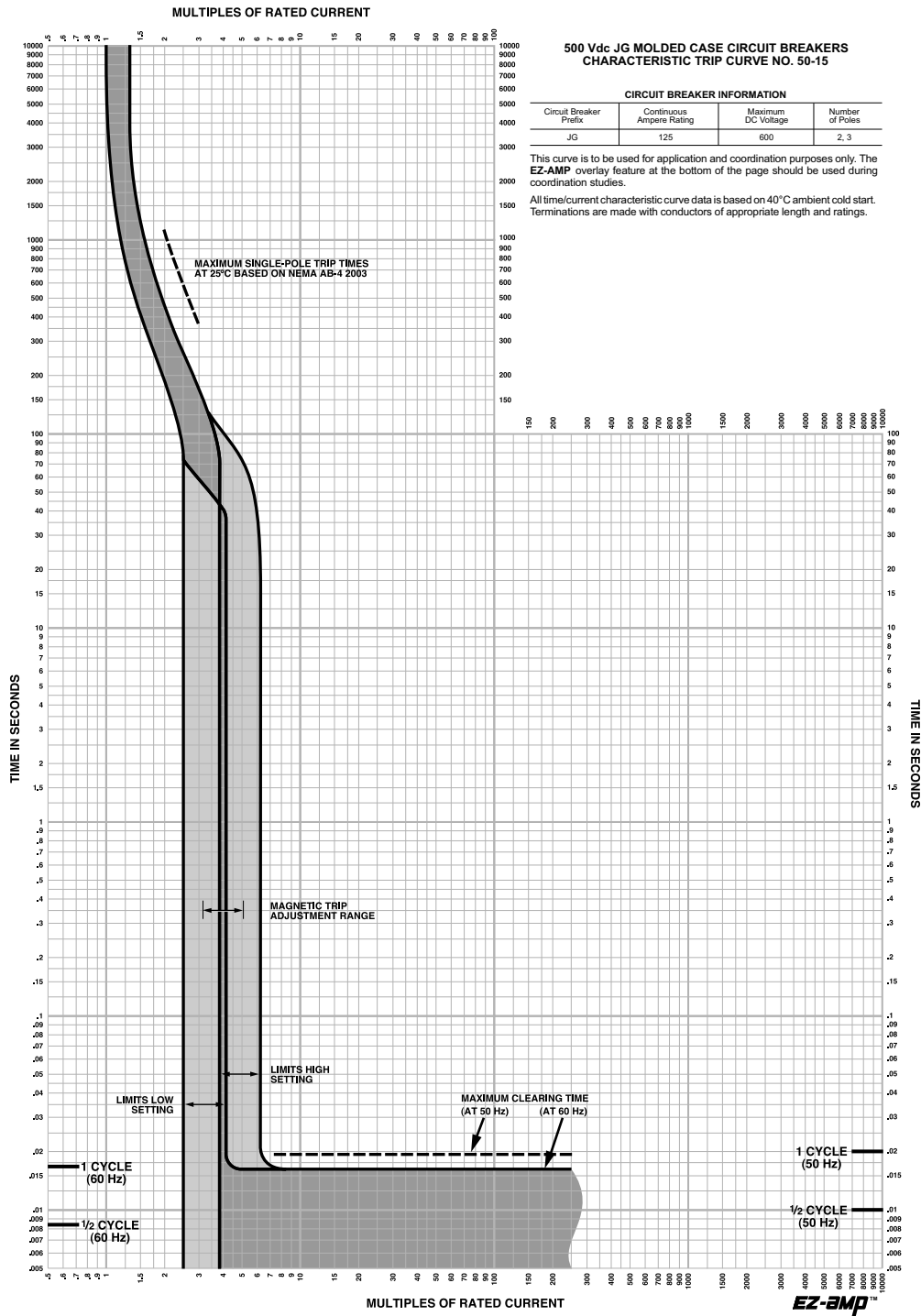

# J-Frame 150 A (JG) 500 Vdc Thermal-Magnetic Trip

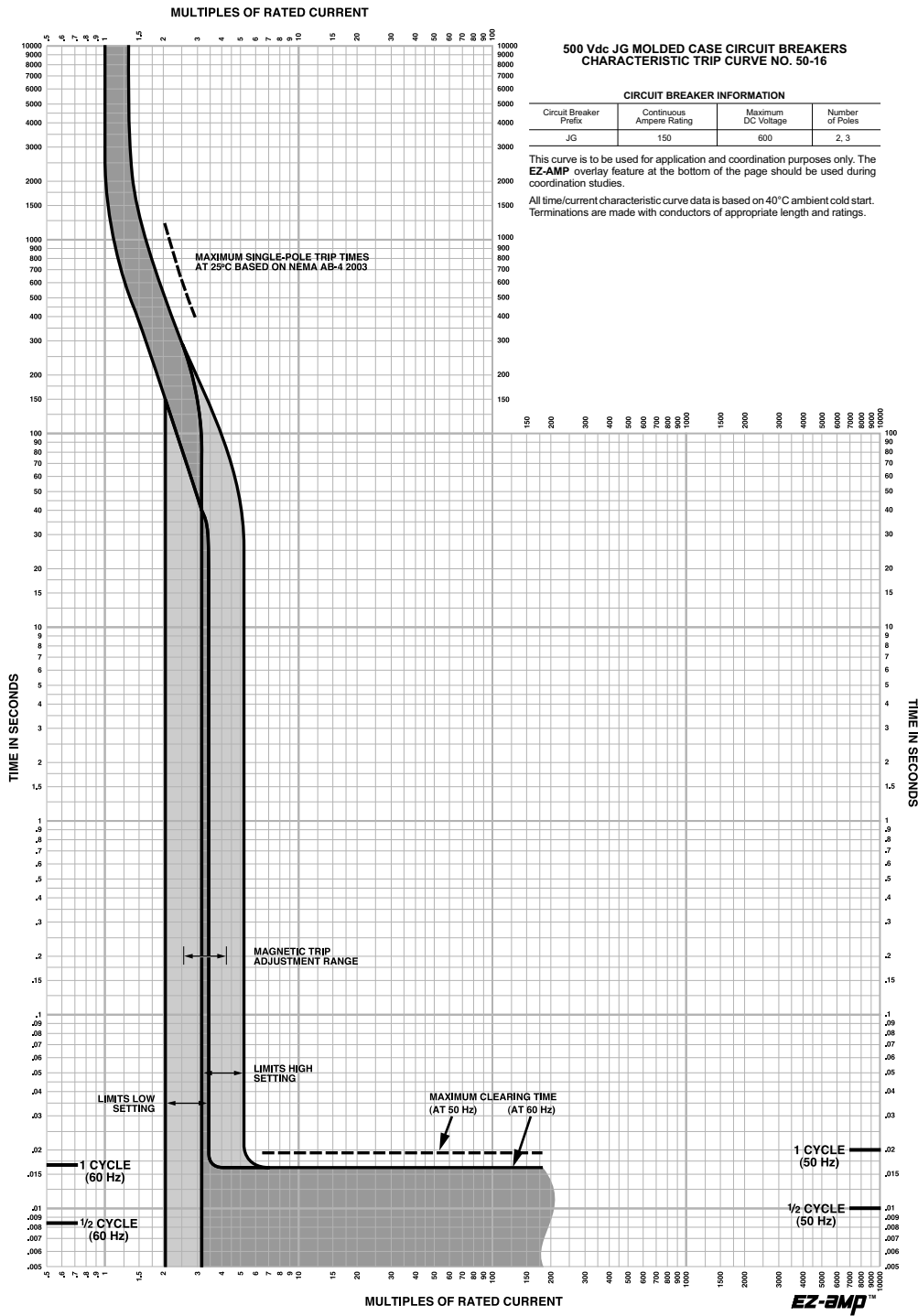

### J-Frame 175 A (JG) 500 Vdc Thermal-Magnetic Trip

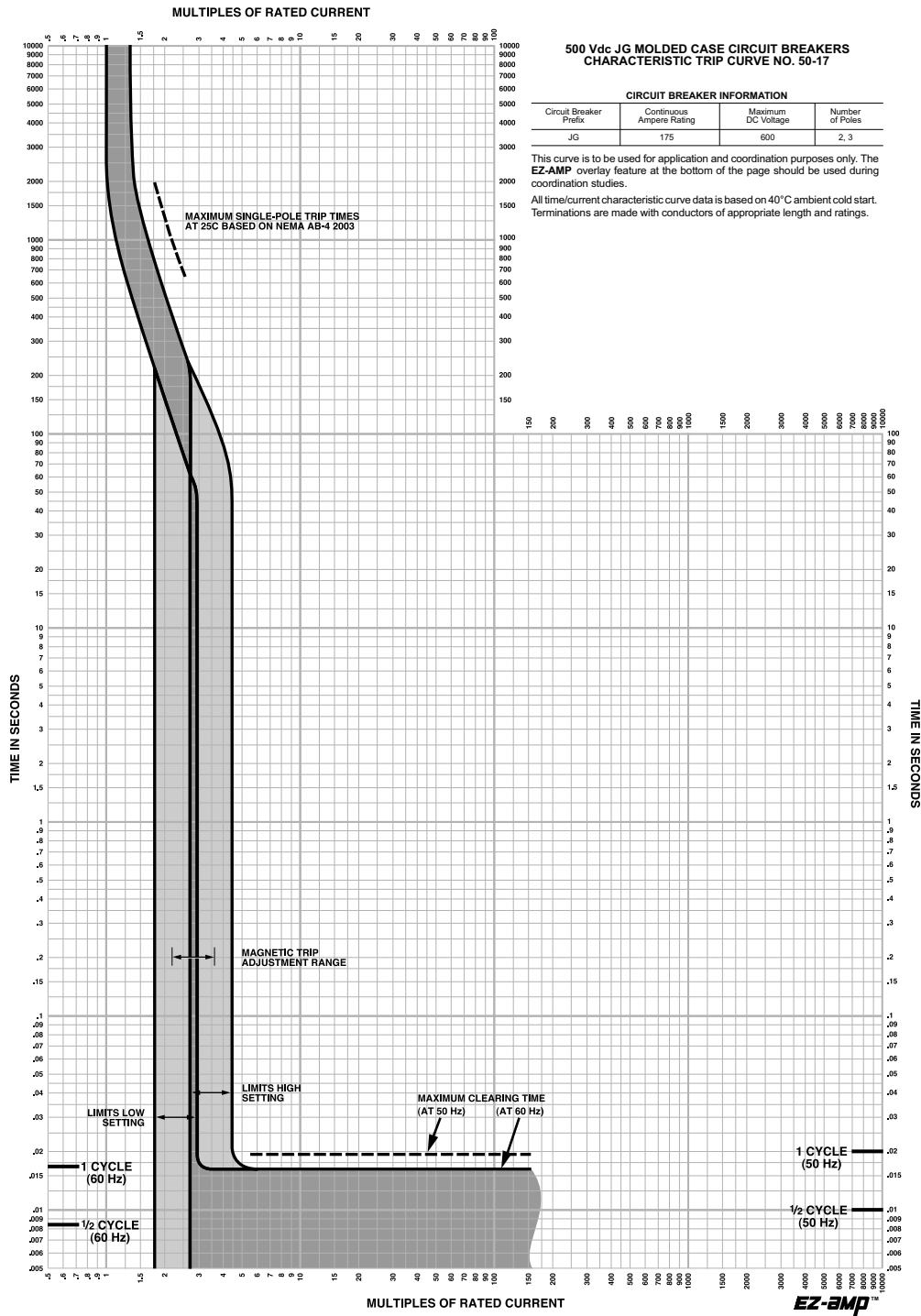

### J-Frame 200 A (JG) 500 Vdc Thermal-Magnetic Trip

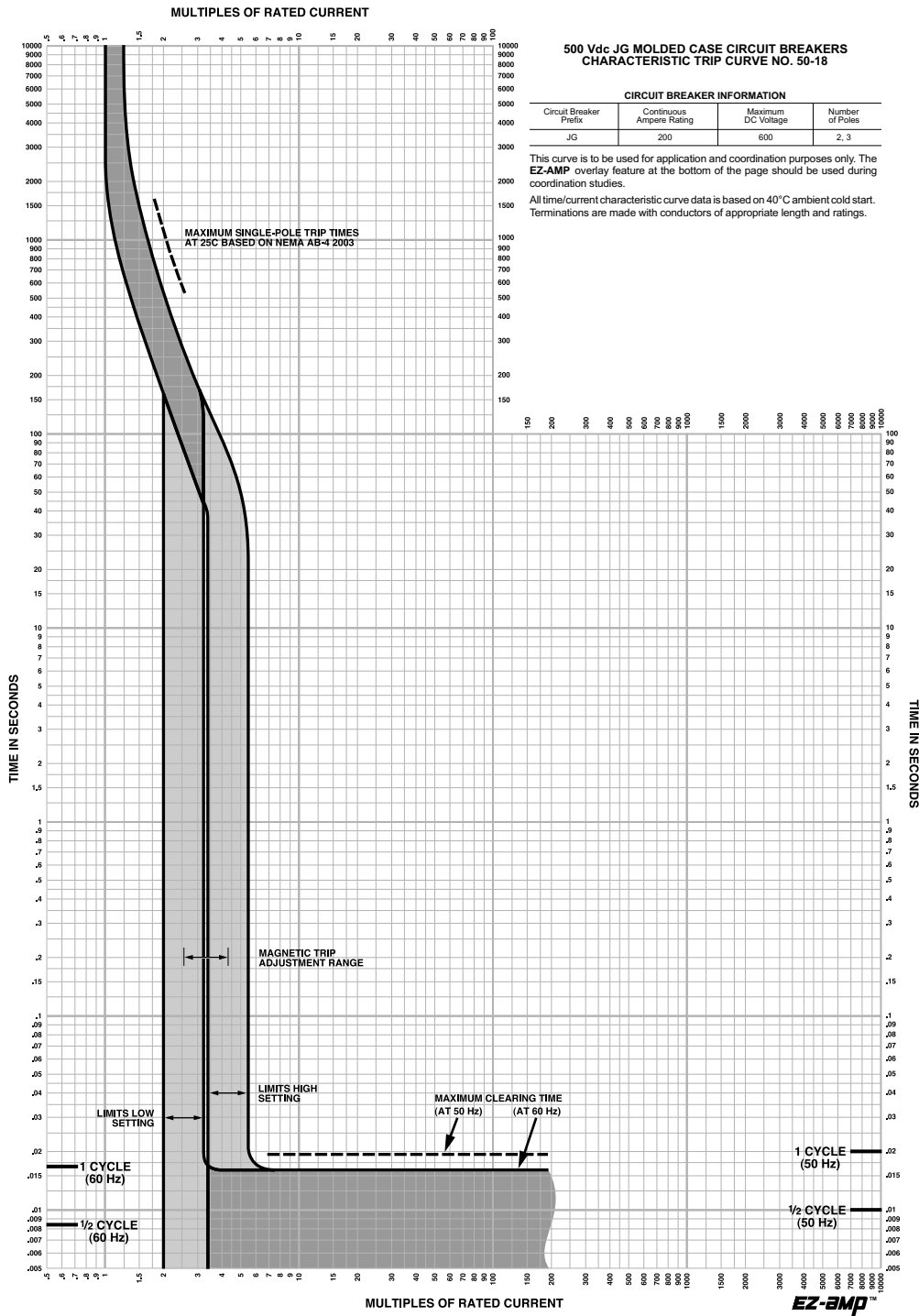

# J-Frame 225 A (JG) 500 Vdc Thermal-Magnetic Trip

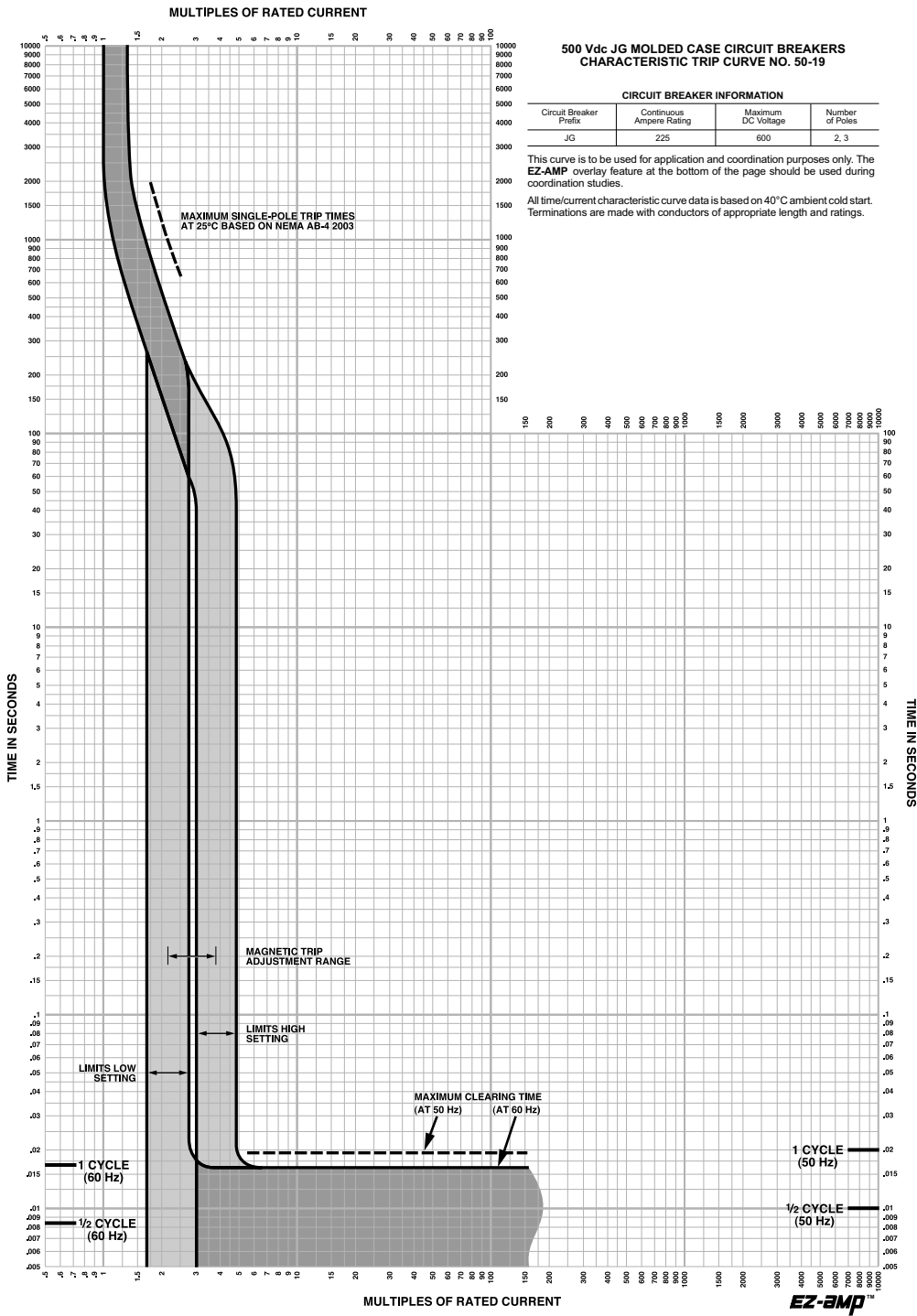



### J-Frame 250 A (JG) 500 Vdc Thermal-Magnetic Trip

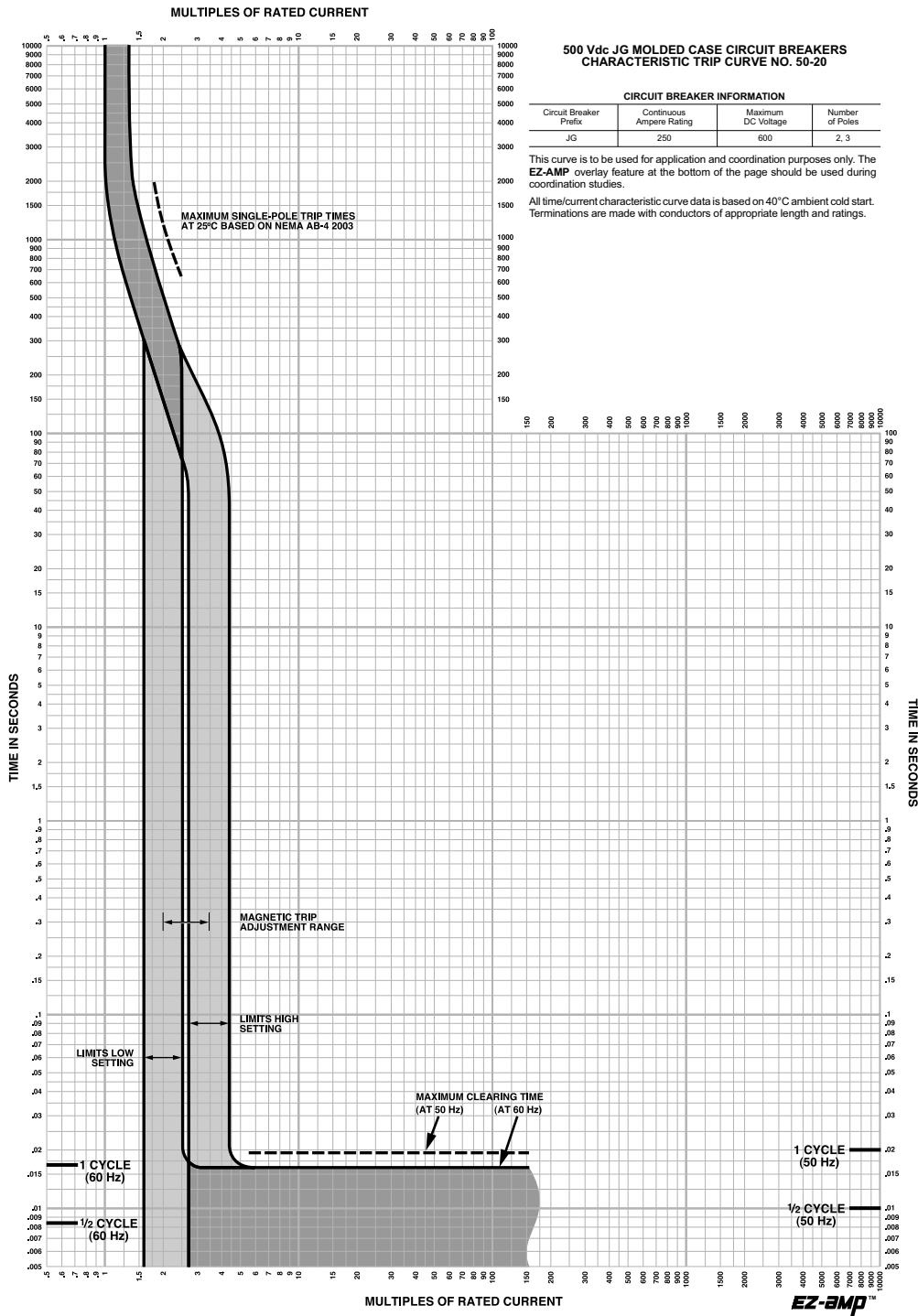

L-Frame 300–450 A (LG and LL) 500 Vdc Thermal-Magnetic Trip

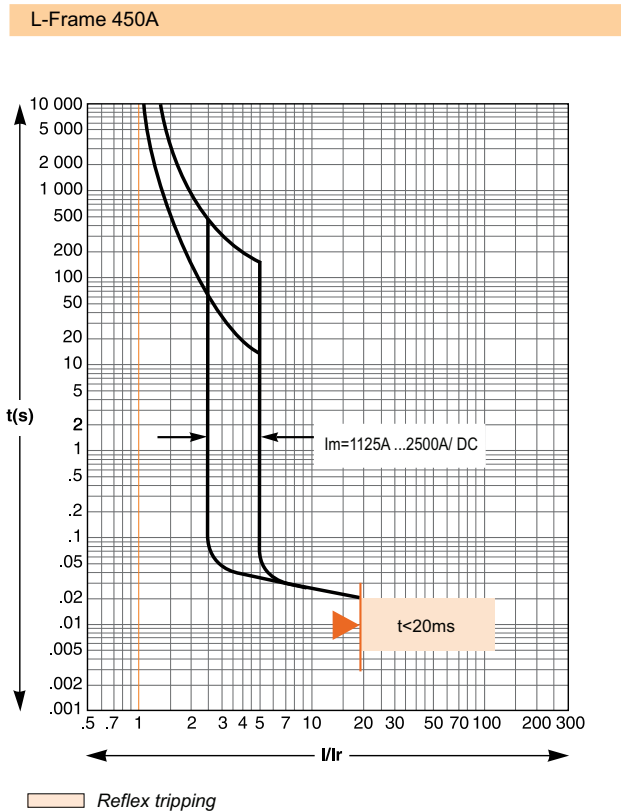
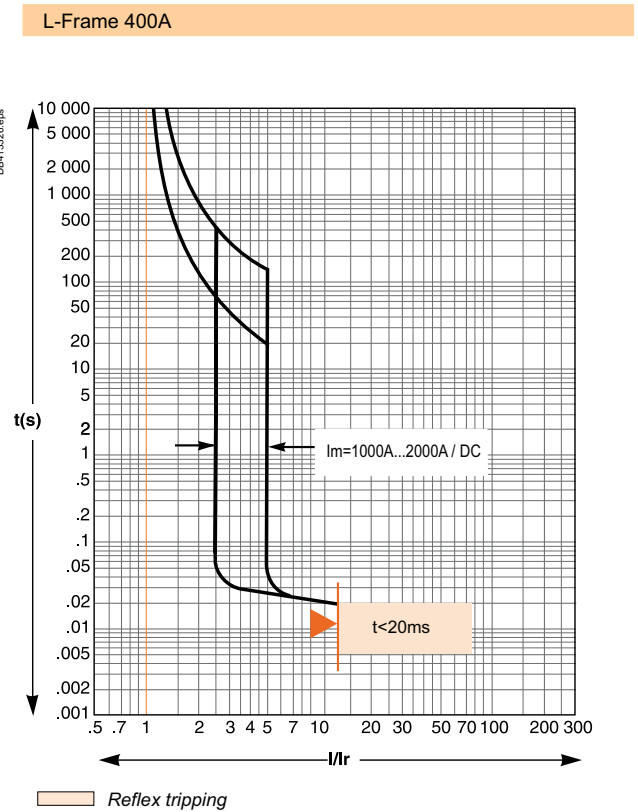
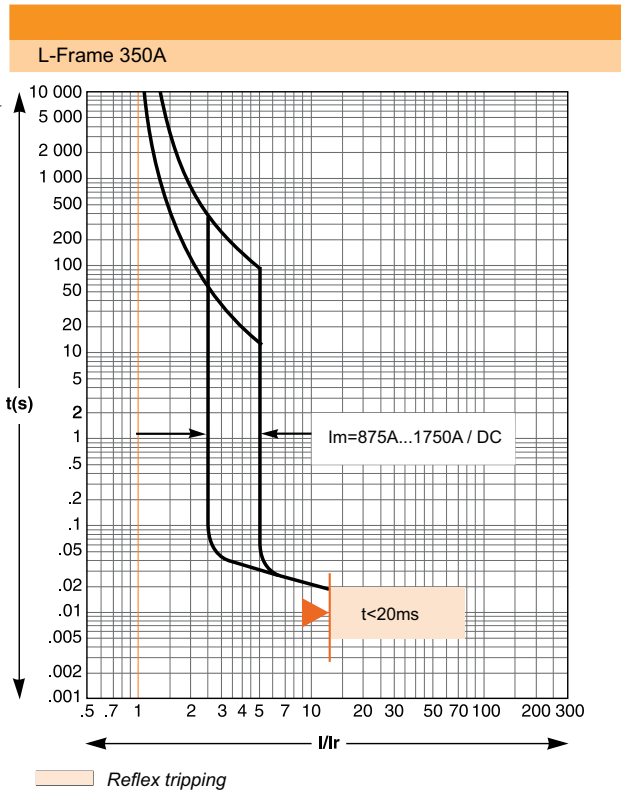
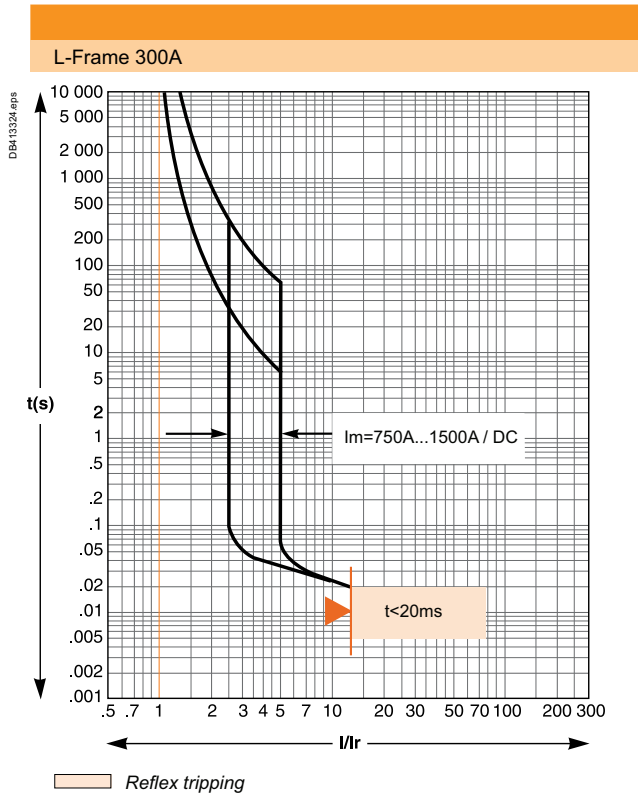

**L-Frame 500–800 A (LG and LL) 500 Vdc Thermal-Magnetic Trip**

L-Frame 500A

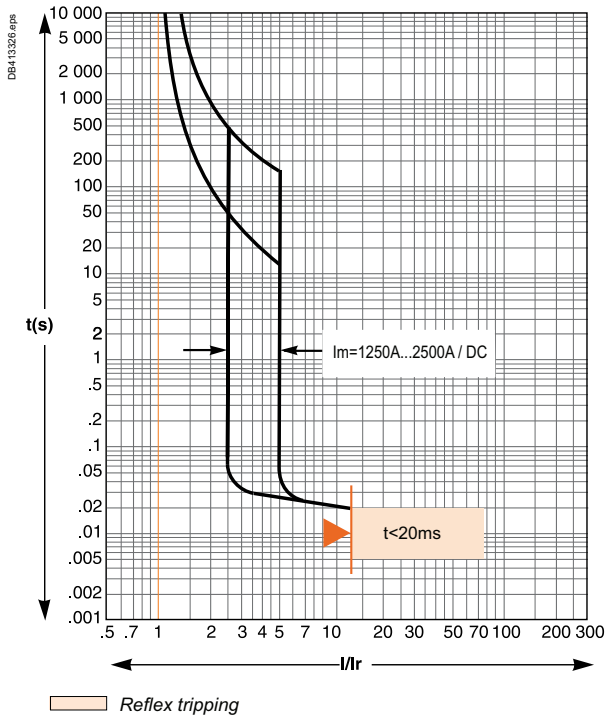

L-Frame 600A

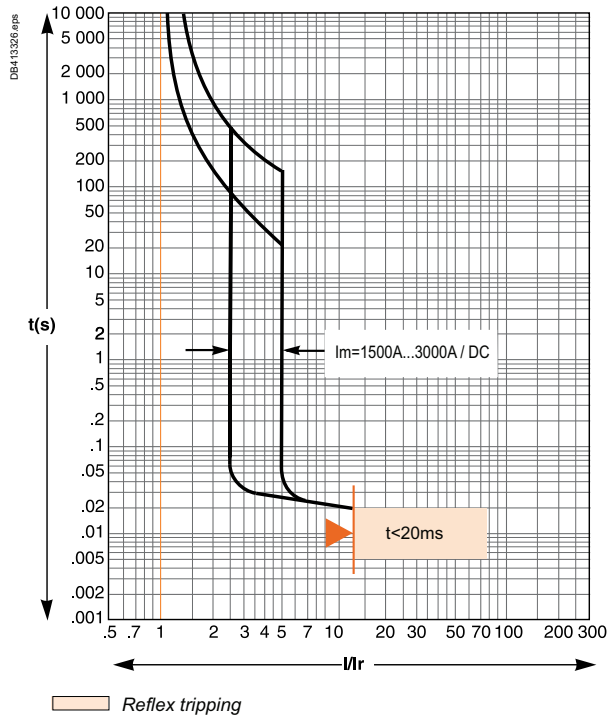

L-Frame 700A

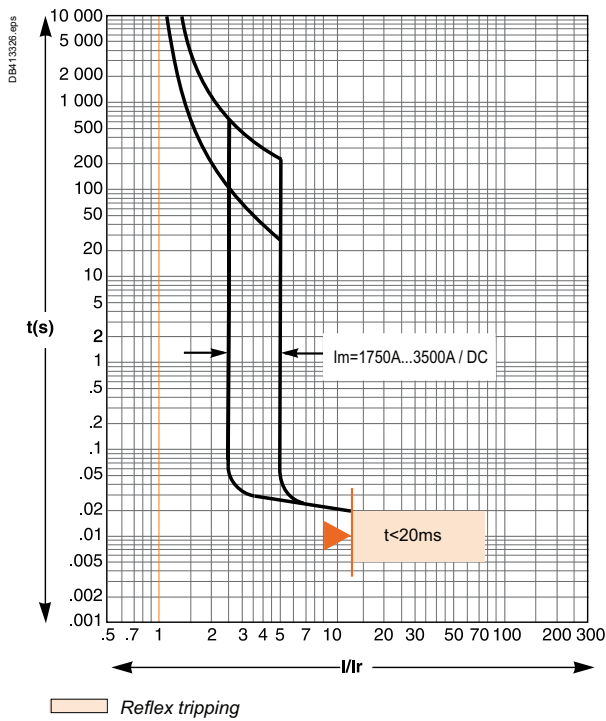

L-Frame 800A

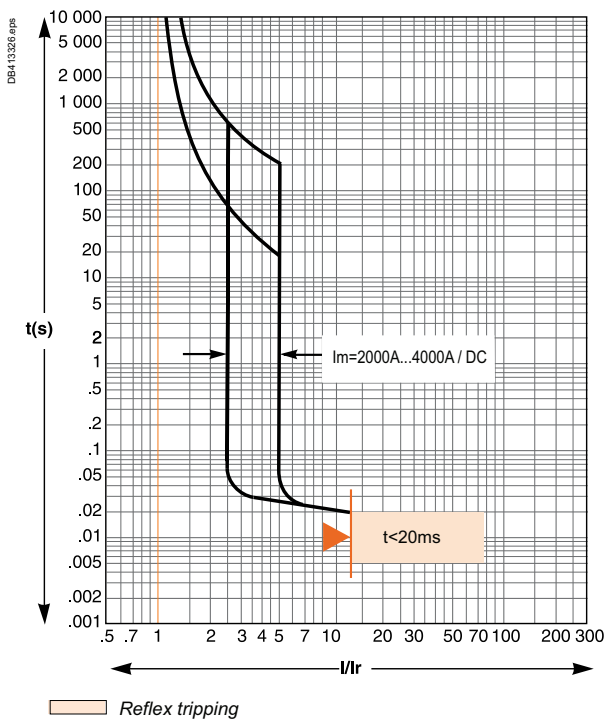

L-Frame 900–1200 A (LG and LL) 500 Vdc Thermal-Magnetic Trip

L-Frame 900A

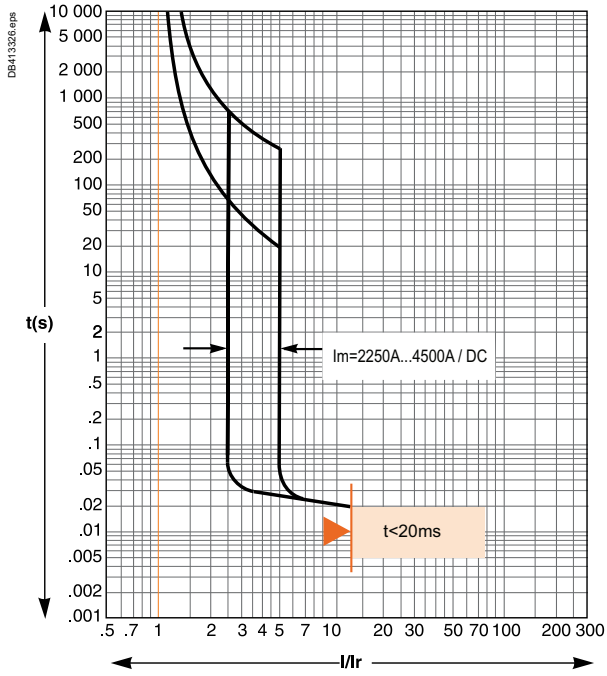

L-Frame 1000A

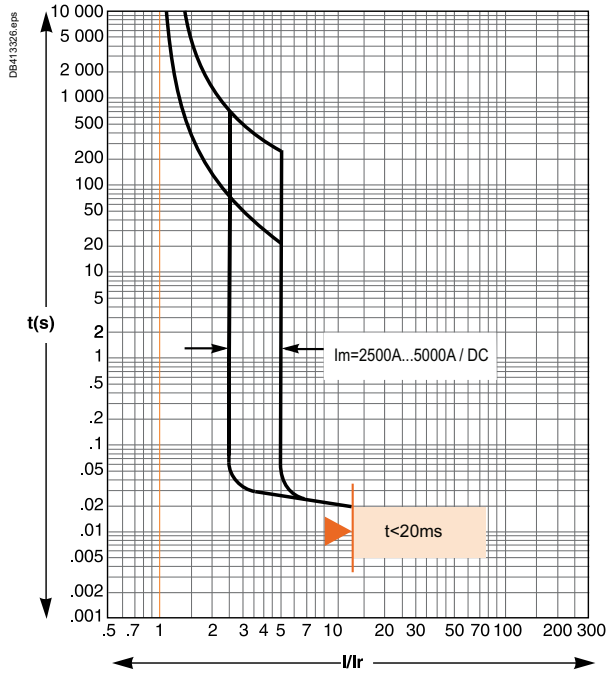

L-Frame 1200A

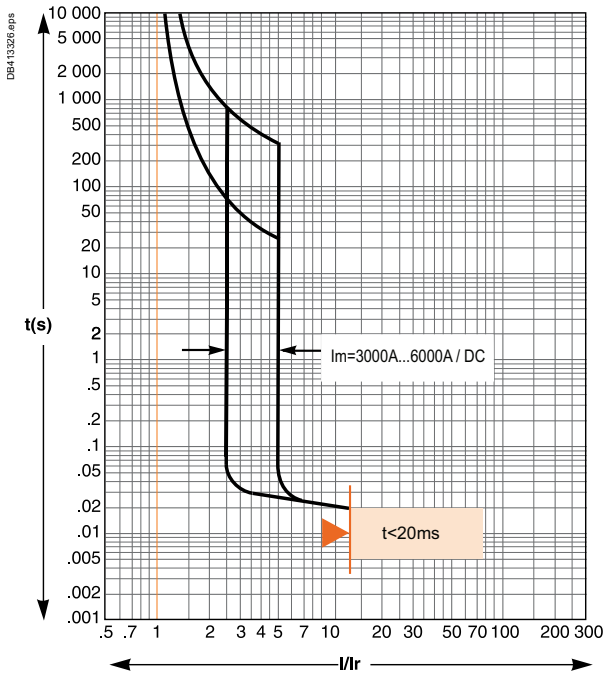

H-Frame 150 A Typical Peak Let-Through Curves

ELECTRONIC MOLDED CASE CIRCUIT BREAKERS  
 POWERPACT™ H-FRAME CURRENT LIMITING CIRCUIT BREAKERS  
 150 A FRAME AT 240, 480 AND 600 V, 3Ø  
 15—150 A

PEAK LET-THROUGH CURRENT  $I_p$

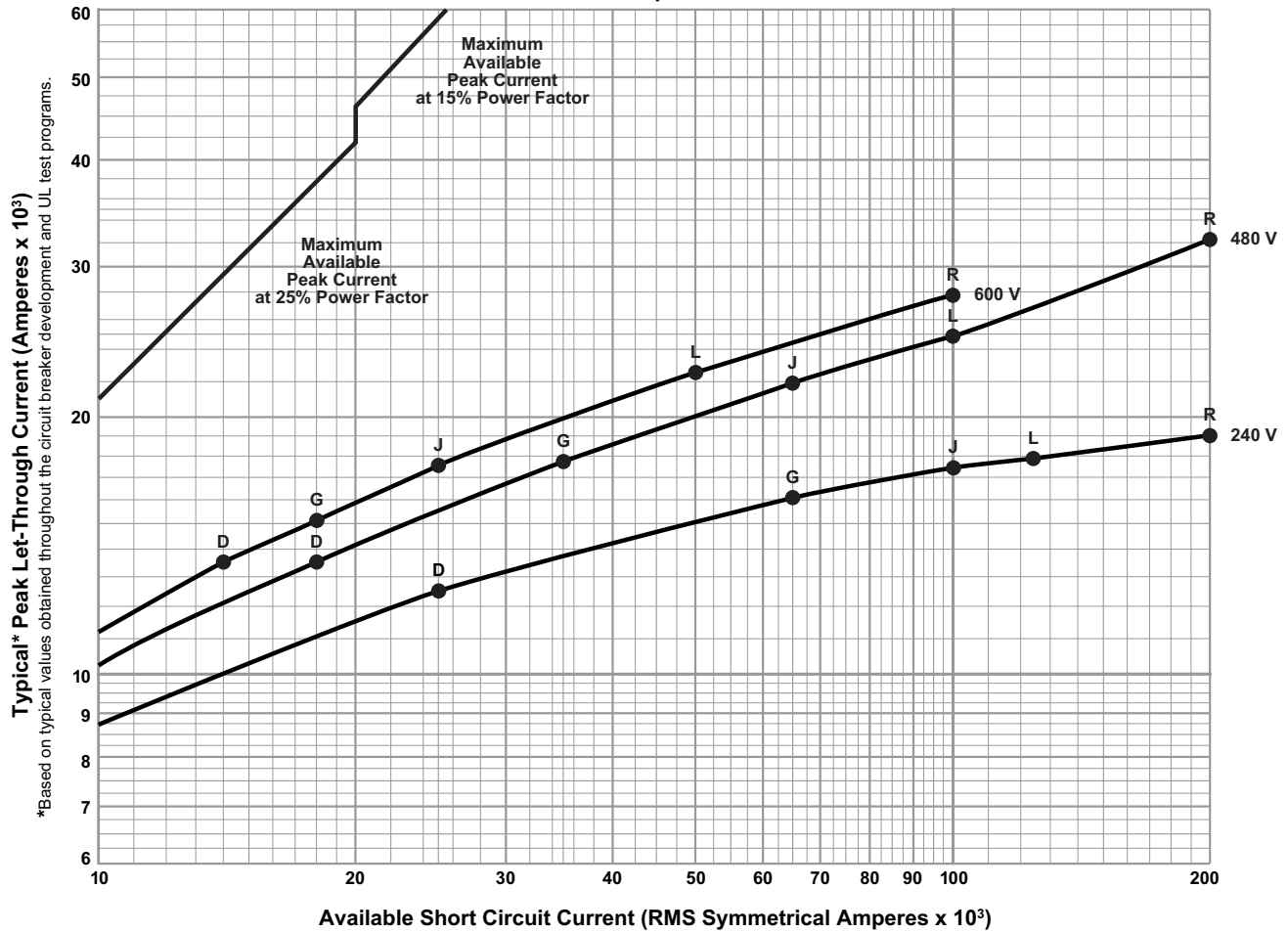

H-Frame 150 A Typical I<sup>2</sup>t Let-Through Curves

ELECTRONIC MOLDED CASE CIRCUIT BREAKERS  
 POWERPACT™ H-FRAME CURRENT LIMITING CIRCUIT BREAKERS  
 150 A FRAME AT 240, 480 AND 600 V, 3Ø  
 15—150 A

LET-THROUGH CURRENT I<sup>2</sup>t

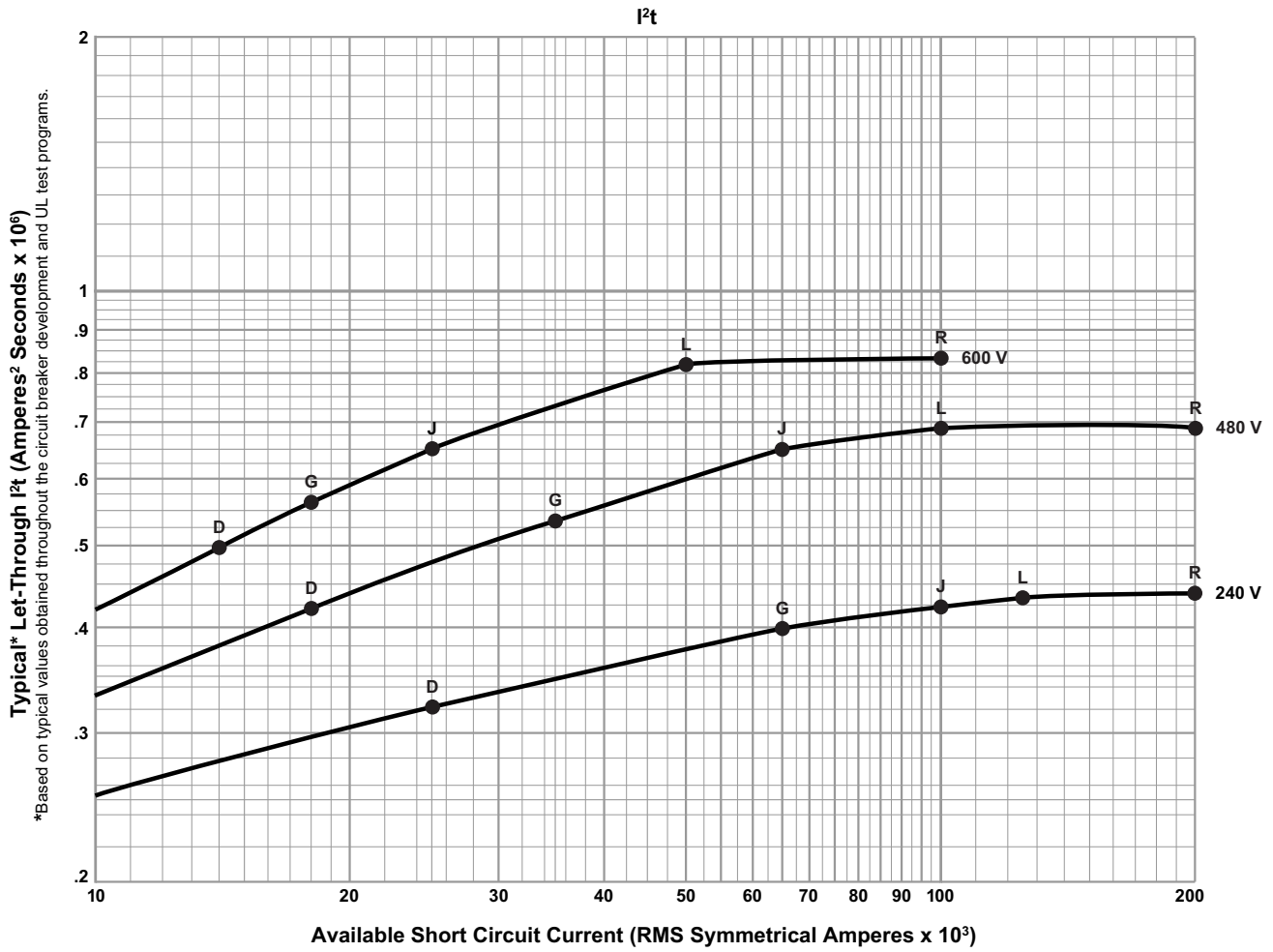

J-Frame 250 A Typical Peak Let-Through Curves

ELECTRONIC MOLDED CASE CIRCUIT BREAKERS  
 POWERPACT™ J-FRAME CURRENT LIMITING CIRCUIT BREAKERS  
 250 A FRAME AT 240, 480 AND 600 V, 3Ø  
 150—250 A

PEAK LET-THROUGH CURRENT  $I_p$

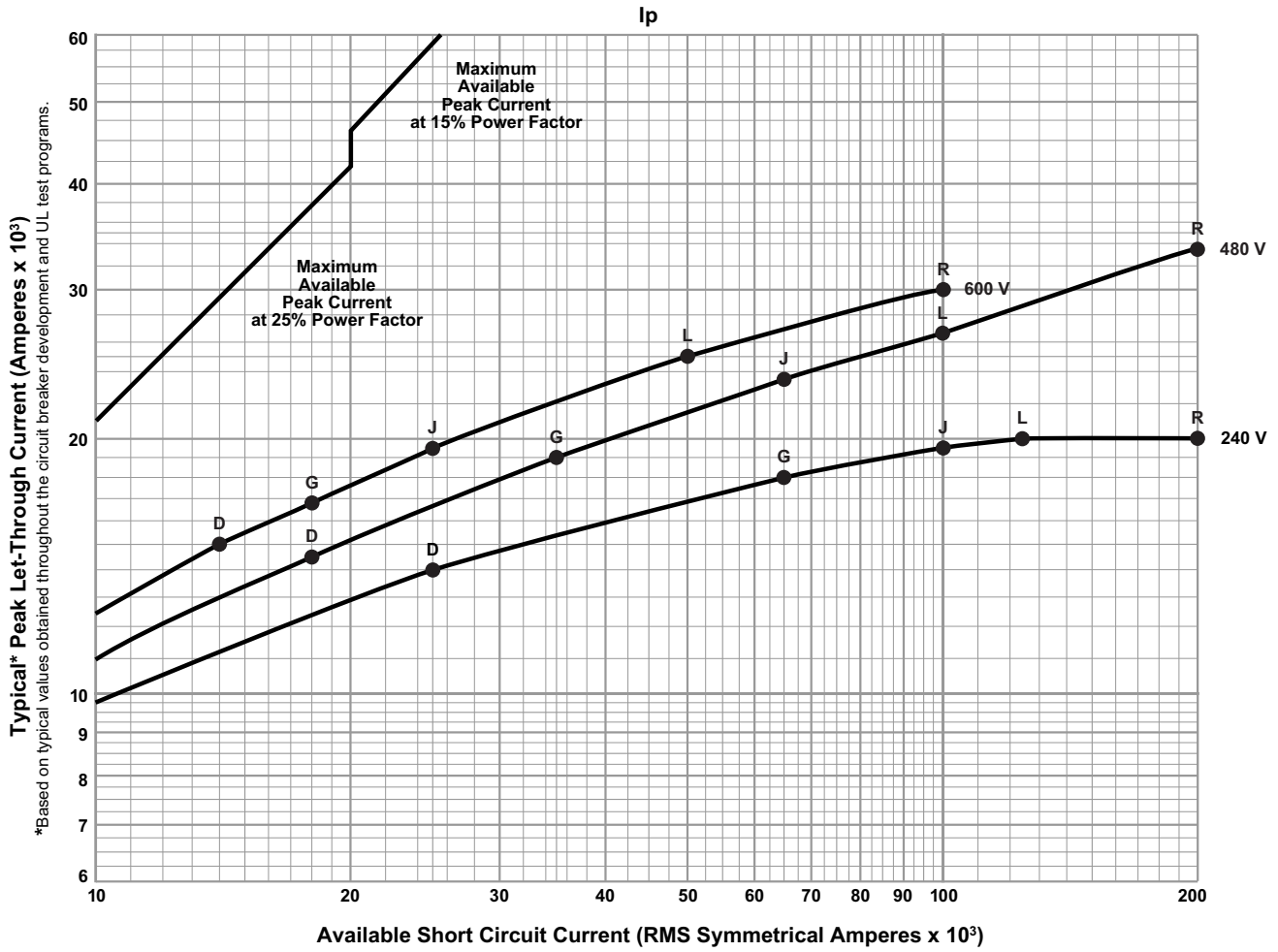

**J-Frame 250 A Typical I<sup>2</sup>t Let-Through Curves**

**ELECTRONIC MOLDED CASE CIRCUIT BREAKERS  
POWERPACT™ J-FRAME CURRENT LIMITING CIRCUIT BREAKERS  
250 A FRAME AT 240, 480 AND 600 V, 3Ø  
150—250 A**

LET-THROUGH CURRENT I<sup>2</sup>t

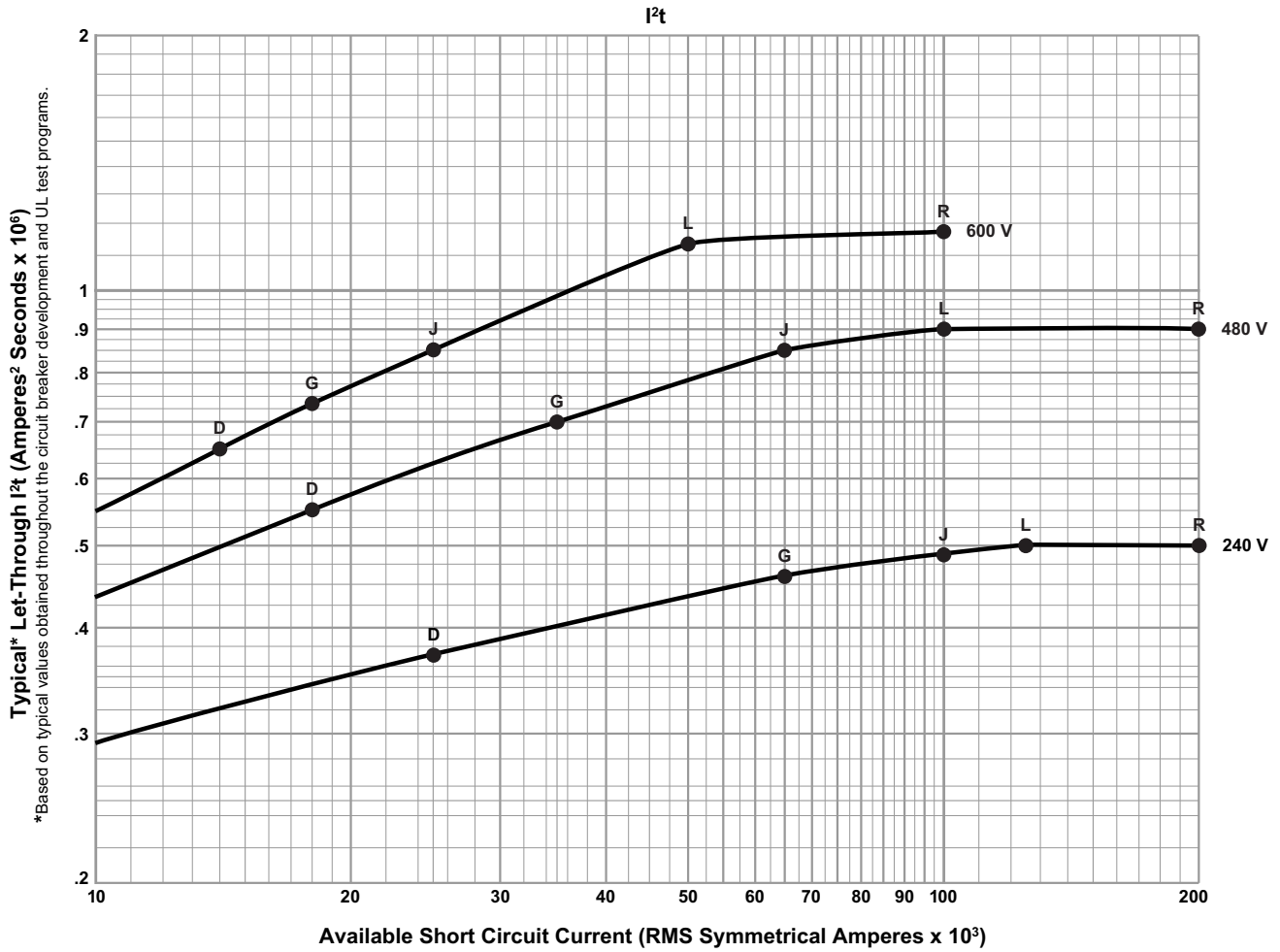



# H- and J-Frame Motor Circuit Protector

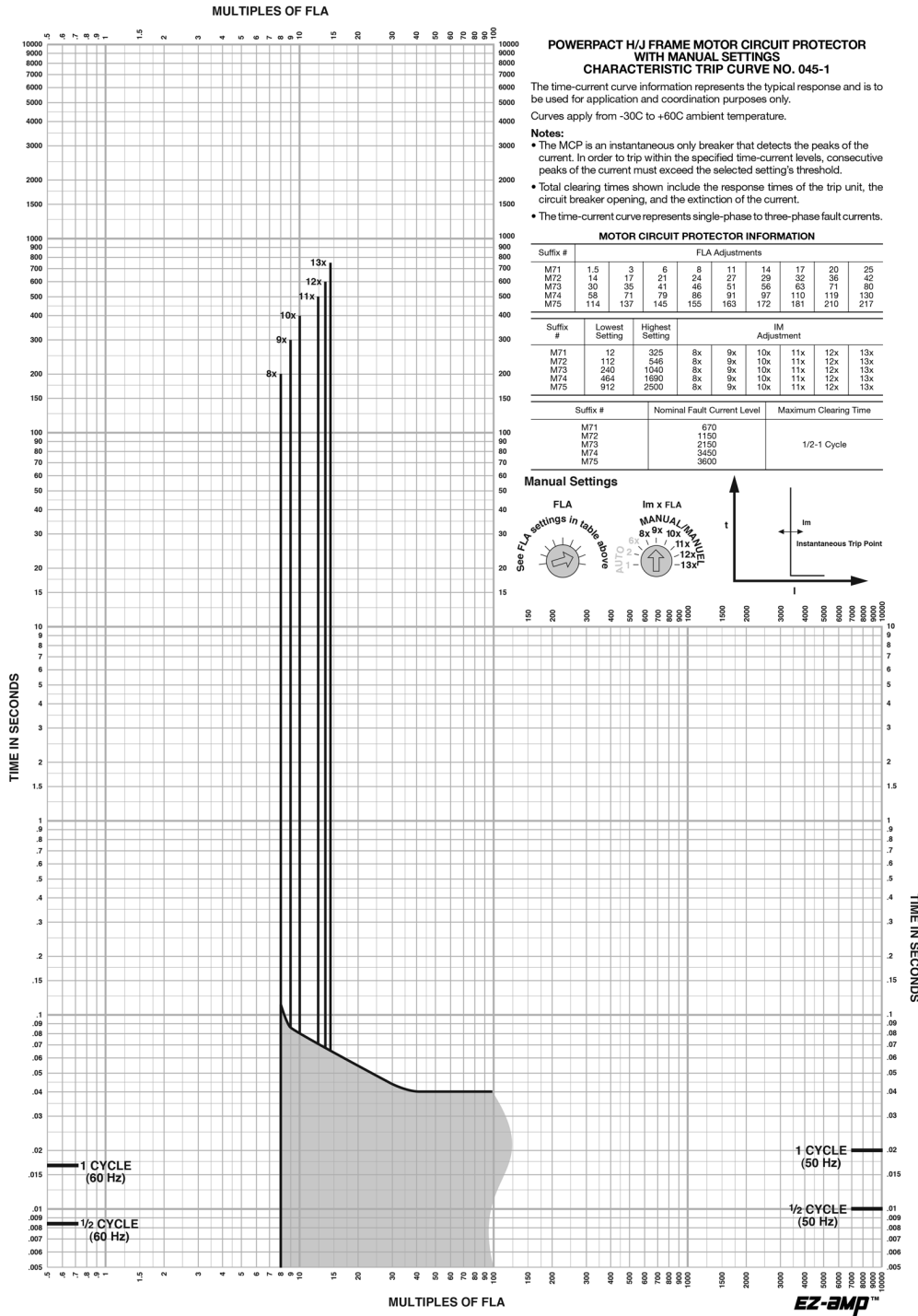

# H- and J-Frame Motor Circuit Protector

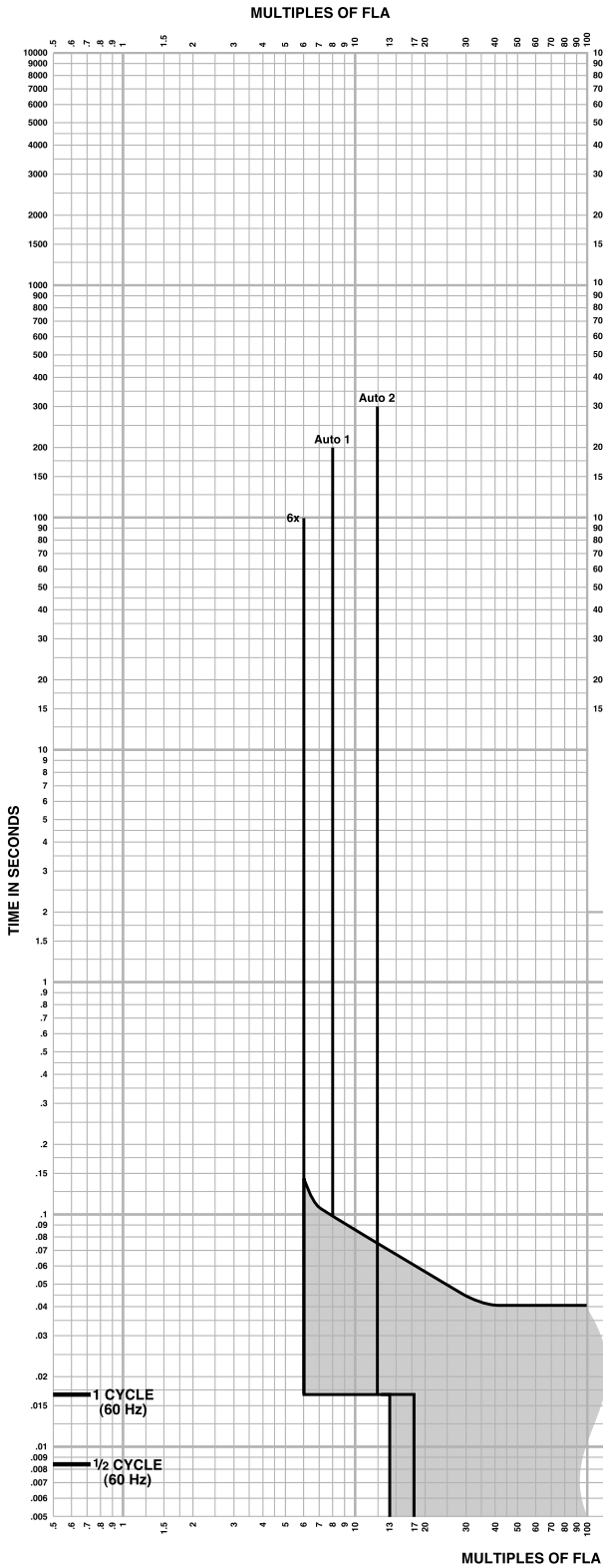

## POWERPACT H/J FRAME MOTOR CIRCUIT PROTECTOR WITH AUTO SETTINGS CHARACTERISTIC TRIP CURVE NO. 045-2

The time-current curve information represents the typical response and is to be used for application and coordination purposes only. Curves apply from -30C to +60C ambient temperature.

**Notes:**

- The MCP is an instantaneous only breaker that detects the peaks of the current. In order to trip within the specified time-current levels, consecutive peaks of the current must exceed the selected setting's threshold.
- Total clearing times shown include the response times of the trip unit, the circuit breaker opening, and the extinction of the current.
- The time-current curve represents single-phase to three-phase fault currents.

**MOTOR CIRCUIT PROTECTOR INFORMATION**

Suffix #	FLA Adjustments									
	1.5	3	6	8	11	14	17	20	25	
M71	14	17	21	24	27	29	32	36	42	
M72	30	36	44	46	51	56	63	71	80	
M73	89	71	79	86	91	97	110	119	130	
M74	114	137	145	155	163	172	181	210	217	
M75										

  

Suffix #	Auto Setting	Instantaneous Trip Point % FLA	Dampening For Motor In-Rush % FLA
M71, M72	Auto 1	800	1300
M73, M74	Auto 2	1100	1700
	6x	600	1300
M75	Auto 1	800	1300
	Auto 2	1100	1100 - 1700
	6x	600	1100 - 1300

Suffix #	Nominal Fault Current Level	Maximum Clearing Time
M71	670	1/2-1 Cycle
M72	1150	
M73	2150	
M74	3450	
M75	3600	

**Automatic Settings**

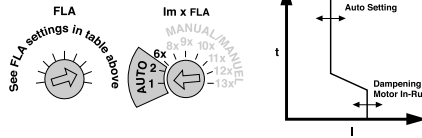

Motor Type/Type de Motor/Type de Moteur	Auto	NEMA	IEC	Type/Type
1	A,B,C,D	N	Standard	
2	B,E	H	Energy Efficient Energie Efficace Energia Efficente	

### H-Frame UL Listed Current-Limiting Circuit Breaker

**THERMAL-MAGNETIC MOLDED CASE CIRCUIT BREAKERS**  
**H-FRAME® CURRENT LIMITING CIRCUIT BREAKERS**  
 H 150 A FRAME AT 240, 480 AND 600 V, 3Ø  
 HJ, HL AND HR 15—150 A

PEAK LET-THROUGH CURRENT  $I_p$

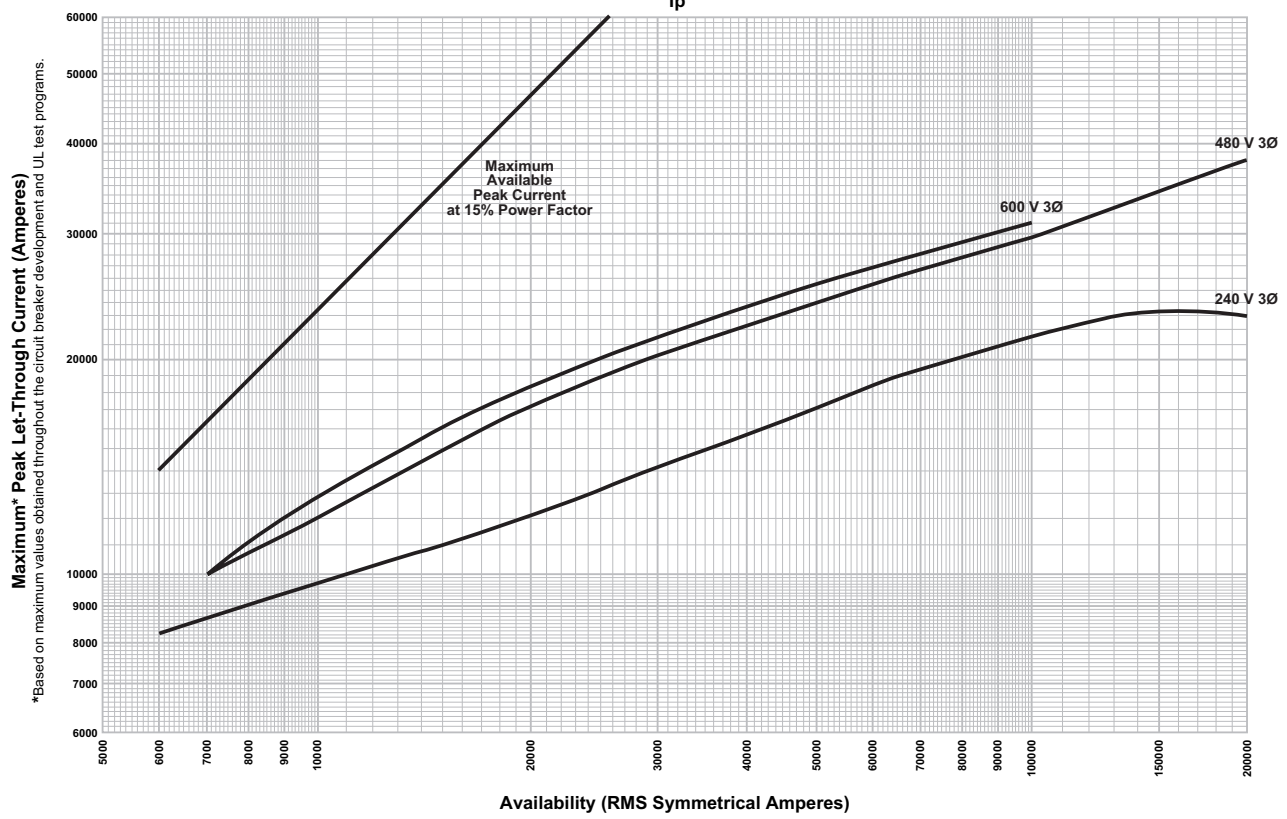

### H-Frame UL Listed Current-Limiting Circuit Breaker

THERMAL-MAGNETIC MOLDED CASE CIRCUIT BREAKERS  
H-FRAME® CURRENT LIMITING CIRCUIT BREAKERS  
H 150 A FRAME AT 240, 480 AND 600 V, 3Ø  
HJ, HL AND HR 15—150 A

LET-THROUGH CURRENT  $I^2t$

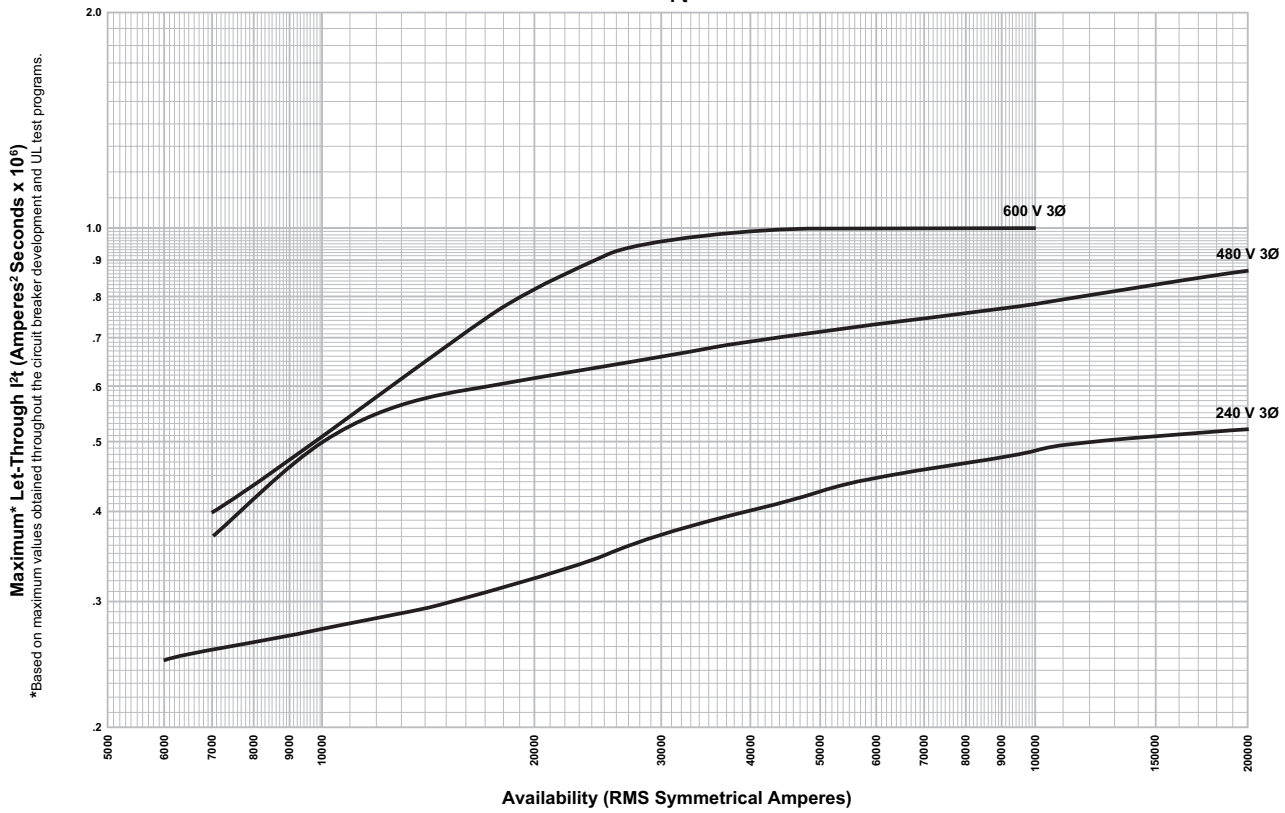

\*Based on maximum values obtained throughout the circuit breaker development and UL test programs.

**J-Frame UL Listed Current -Limiting Circuit Breaker**

**THERMAL-MAGNETIC MOLDED CASE CIRCUIT BREAKERS**  
**J-FRAME® CURRENT LIMITING CIRCUIT BREAKERS**  
 J 250 A FRAME AT 240, 480 AND 600 V, 3Ø  
 JJ, JL AND JR 150—250 A

PEAK LET-THROUGH CURRENT  $I_p$

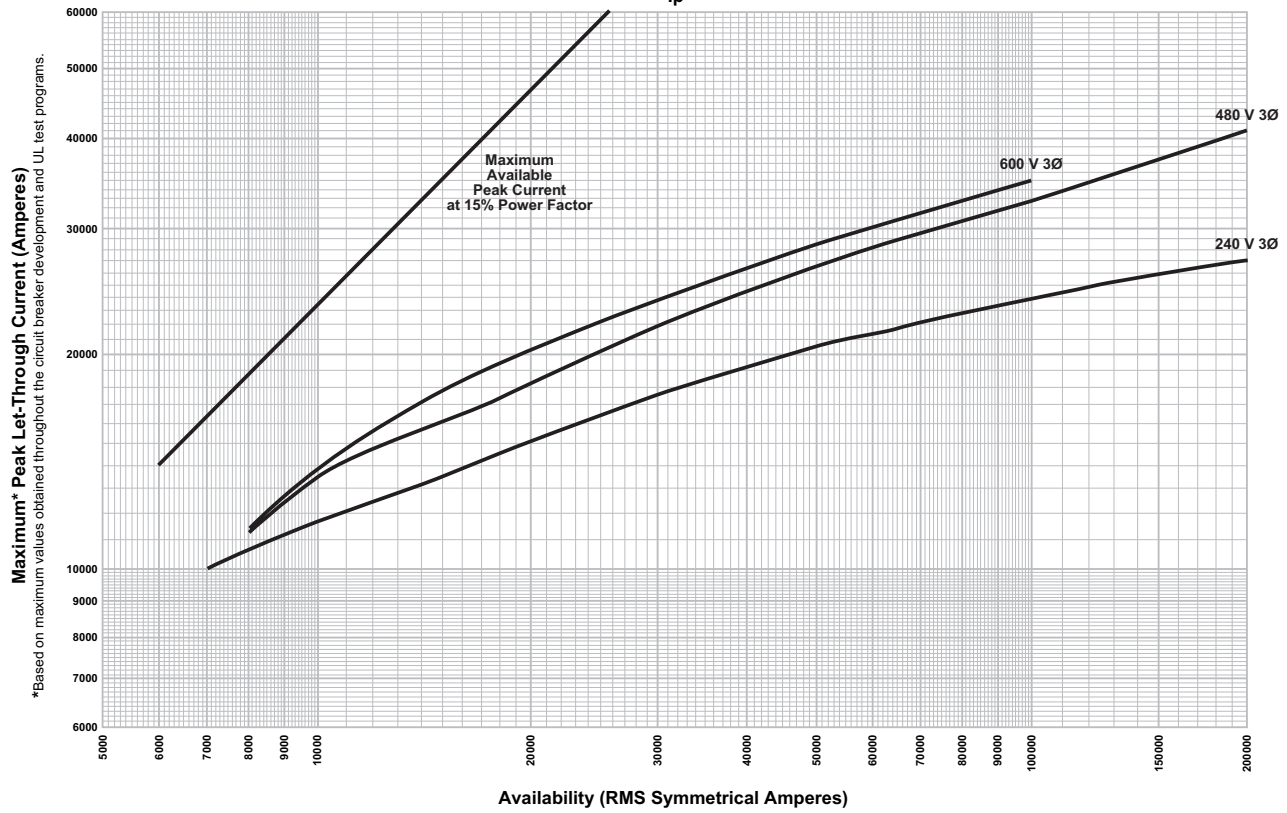

**J-Frame UL Listed Current-Limiting Circuit Breaker**

**THERMAL-MAGNETIC MOLDED CASE CIRCUIT BREAKERS**  
**J-FRAME® CURRENT LIMITING CIRCUIT BREAKERS**  
 J 250 A FRAME AT 240, 480 AND 600 V, 3Ø  
 JJ, JL AND JR 150—250 A

**LET-THROUGH CURRENT  $I^2t$**

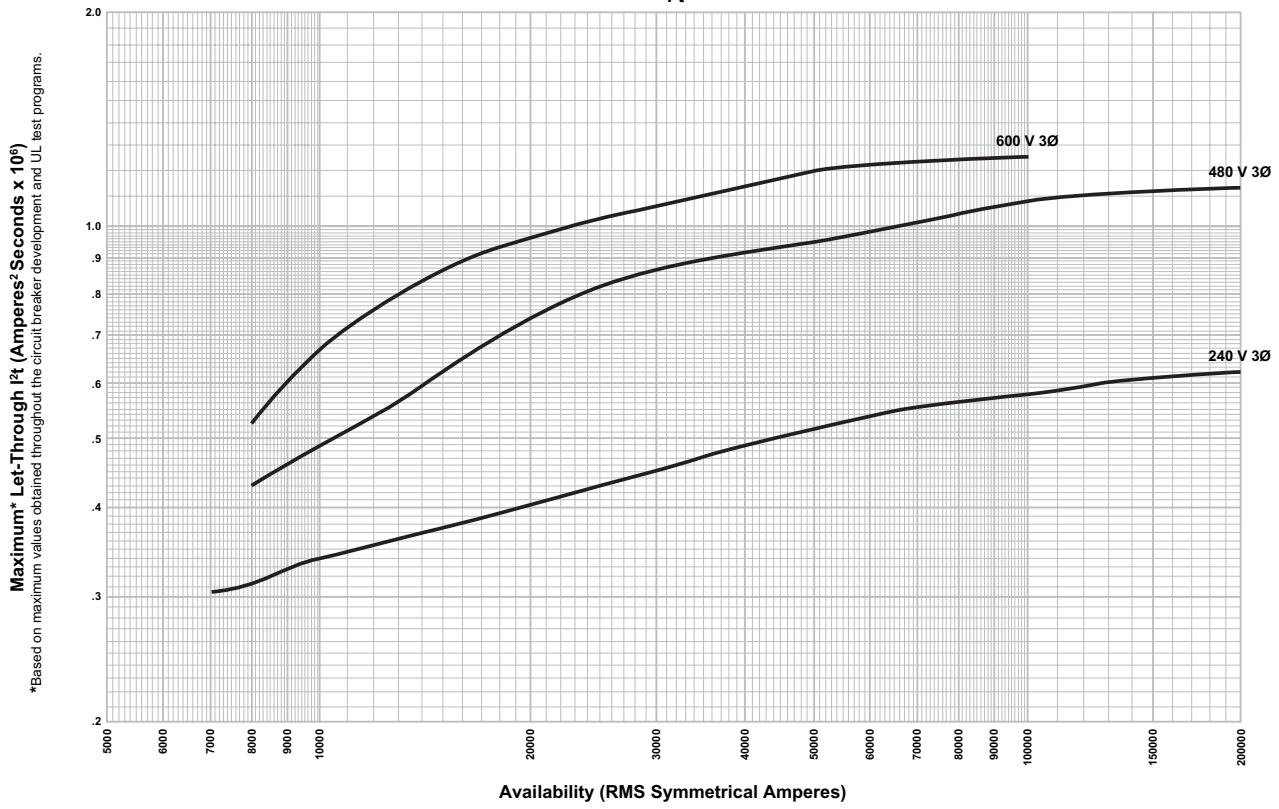

### Ground Fault Module GFM150HD Trip Curve

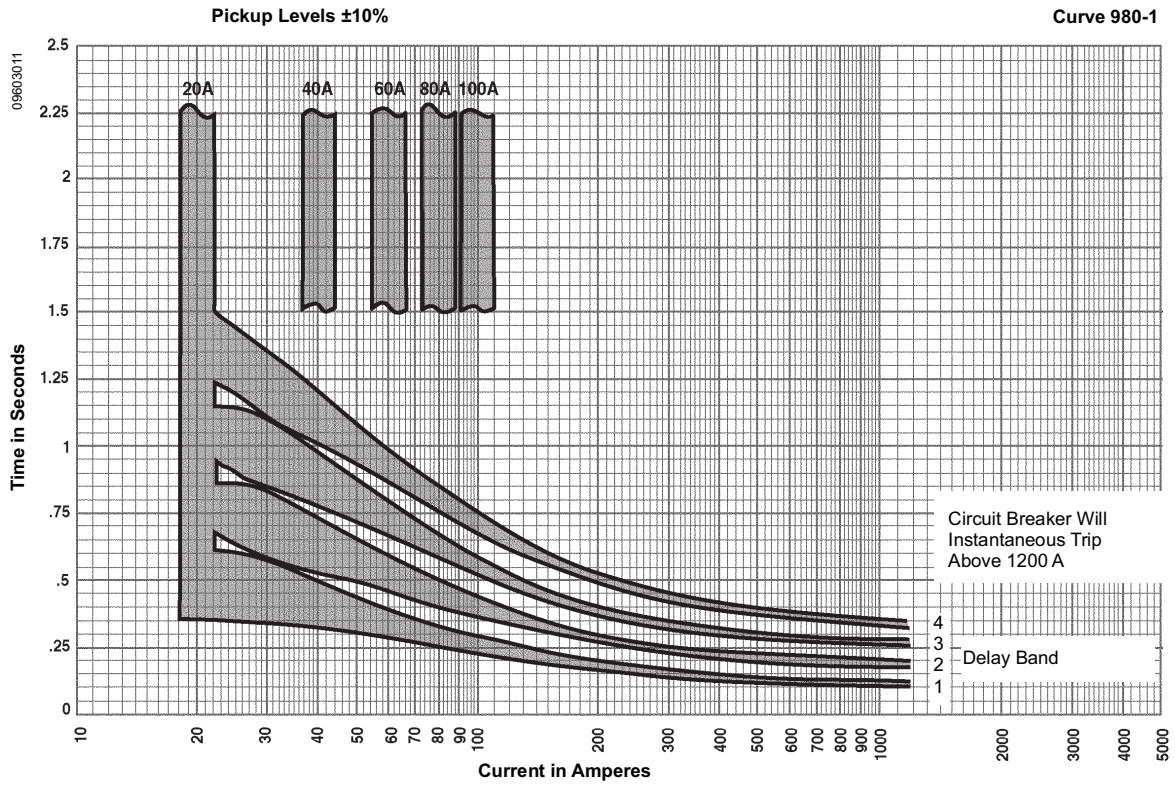

### Ground Fault Module GFM250JD Trip Curve

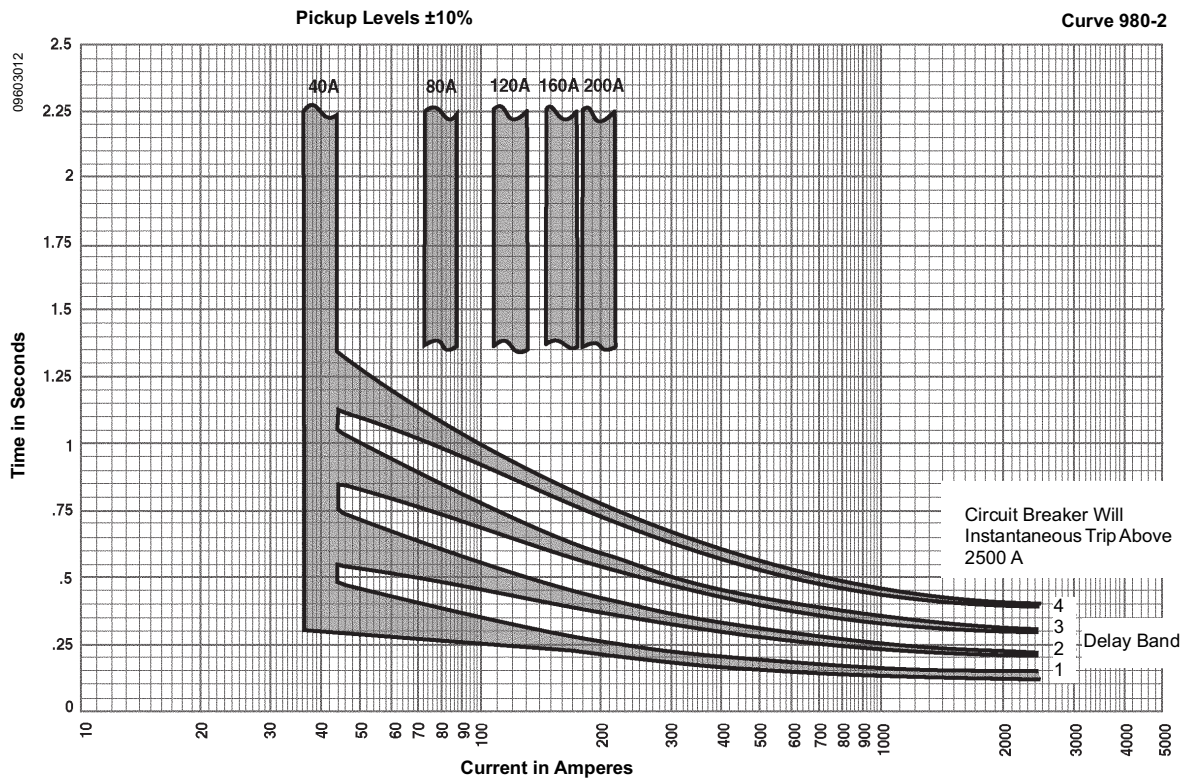

### Earth Leakage Module Trip Curve

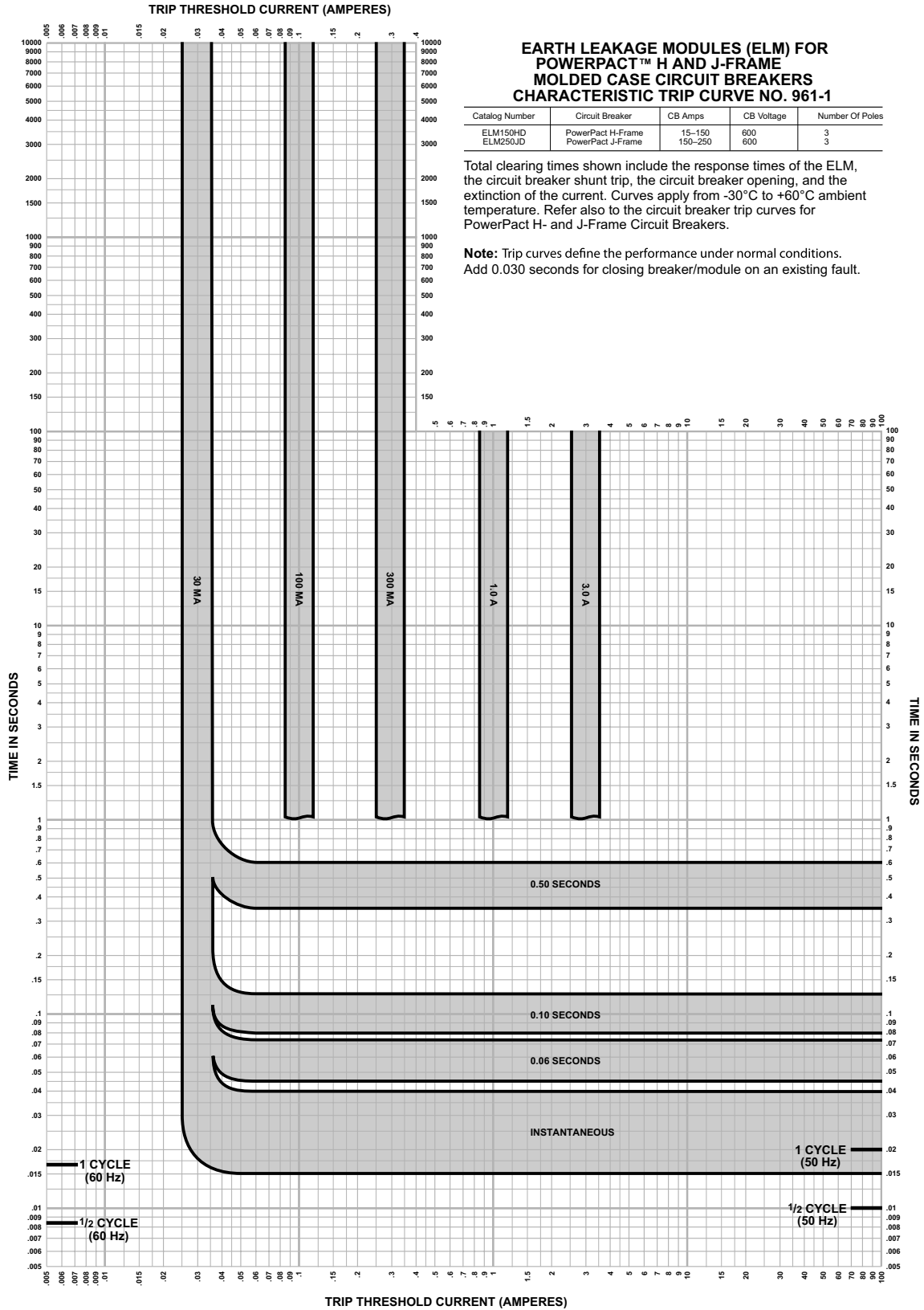



# PowerPacT H- and J-Frame Thermal-Magnetic Trip MCP Instantaneous Trip Points

## M71 Instantaneous Trip Points

	I <sub>m</sub> Setting	Automatic Setting (A)		Manual Adjustment (A)						
		1	2	6x	8x	9x	10x	11x	12x	13x
Motor Type	NEMA	A, B, C, D	B, E	(FLA) x (I <sub>m</sub> )						
	IEC	N	H							
FLA	1.5	12	16.5	9	12	13.5	15	16.5	18	19.5
	3	24	33	18	24	27	30	33	36	39
	6	48	66	36	48	54	60	66	72	78
	8	64	88	48	64	72	80	88	96	104
	11	88	121	66	88	99	110	121	132	143
	14	112	154	84	112	126	140	154	168	182
	17	136	187	102	136	153	170	187	204	221
	20	160	220	120	160	180	200	220	240	260
25	200	275	150	200	225	250	275	300	325	
Dampening for motor in-rush (% FLA)		1300%	1700%	1300%	—					

## M72 Instantaneous Trip Points

	I <sub>m</sub> Setting	Automatic Setting (A) <sup>215</sup>		Manual Adjustment (A) <sup>1</sup>						
		1	2	6x	8x	9x	10x	11x	12x	13x
Motor Type	NEMA	A, B, C, D	B, E	(FLA) x (I <sub>m</sub> )						
	IEC	N	H							
FLA	14	112	154	84	112	126	140	154	168	182
	17	136	187	102	136	153	170	187	204	221
	21	168	231	126	168	189	210	231	252	273
	24	192	264	144	192	216	240	264	288	312
	27	216	297	162	216	243	270	297	324	351
	29	232	319	174	232	261	290	319	348	377
	32	256	352	192	256	288	320	352	384	416
	36	288	396	216	288	324	360	396	432	468
42	336	462	252	336	378	420	462	504	546	
Dampening for motor in-rush (% FLA)		1300%	1700%	1300%	—					

<sup>215</sup>. ± 5% of nominal amperage shown above.

**M73 Instantaneous Trip Points**

	I <sub>m</sub> Setting	Automatic Setting (A) <sup>216</sup>		Manual Adjustment (A)1						
		1	2	6x	8x	9x	10x	11x	12x	13x
Motor Type	NEMA	A, B, C, D	B, E	(FLA) x (I <sub>m</sub> )						
	IEC	N	H							
FLA	30	240	330	180	240	270	300	330	360	390
	35	280	385	210	280	315	350	385	420	455
	41	328	451	246	328	369	410	451	492	533
	46	368	506	276	368	414	460	506	552	598
	51	408	561	306	408	459	510	561	612	663
	56	448	616	336	448	504	560	616	672	728
	63	504	693	378	504	567	630	693	756	819
	71	568	781	426	568	639	710	781	852	923
	80	640	880	480	640	720	800	880	960	1040
Dampening for motor in-rush (% FLA)		1300%	1700%	1300%	—					

**M74 Instantaneous Trip Points**

	I <sub>m</sub> Setting	Automatic Setting (A) <sup>216</sup>		Manual Adjustment (A)1						
		1	2	6x	8x	9x	10x	11x	12x	13x
Motor Type	NEMA	A, B, C, D	B, E	(FLA) x (I <sub>m</sub> )						
	IEC	N	H							
FLA	58	464	638	348	464	522	580	638	696	754
	71	568	781	426	568	639	710	781	852	923
	79	632	869	474	632	711	790	869	948	1027
	86	688	946	516	688	774	860	946	1032	1118
	91	728	1001	546	728	819	910	1001	1092	1183
	97	776	1067	582	776	873	970	1067	1164	1261
	110	880	1210	660	880	990	1100	1210	1320	1430
	119	952	1309	714	952	1071	1190	1309	1428	1547
	130	1040	1430	780	1040	1170	1300	1430	1560	1690
Dampening for motor in-rush (% FLA)		1300%	1700%	1300%	—					

216. ± 5% of nominal amperage shown above.

**M75 Instantaneous Trip Points**

	Im Setting	Automatic Setting (A) <sup>217</sup>		Manual Adjustment (A) <sup>217</sup>						
		1	2	6x	8x	9x	10x	11x	12x	13x
Motor Type	NEMA	A, B, C, D	B, E	(FLA) x (Im)						
	IEC	N	H							
FLA	114	912	1254	684	912	1026	1140	1254	1368	1482
	137	1096	1507	822	1096	1233	1370	1507	1644	1781
	145	1160	1595	870	1160	1305	1450	1595	1740	1885
	155	1240	1705	930	1240	1395	1550	1705	1860	2015
	163	1304	1793	978	1304	1467	1630	1793	1956	2119
	172	1376	1892	1032	1376	1548	1720	1892	2064	2236
	181	1448	1991	1086	1448	1629	1810	1991	2172	2353
	210	1680	2310	1260	1680	1890	2100	2310	2500 <sup>2-</sup> <sub>18</sub>	2500 <sup>21-</sup> <sub>9</sub>
	217	1736	2387	1302	1736	1953	2170	2387	2500 <sup>2-</sup> <sub>20</sub>	2500 <sup>21-</sup> <sub>1</sub>
Dampening for motor in-rush (% FLA)		1100–1300%	1100–1700%	1100–1300%	—					

217. ± 5% of nominal amperage shown above.

218. 2500 A maximum instantaneous trip point.

# PowerPacT H-Frame Electronic Trip Circuit Breakers— 60/100/150 A Frame

## MicroLogic 3.2 Electronic Trip Unit Long Time Trip Curve

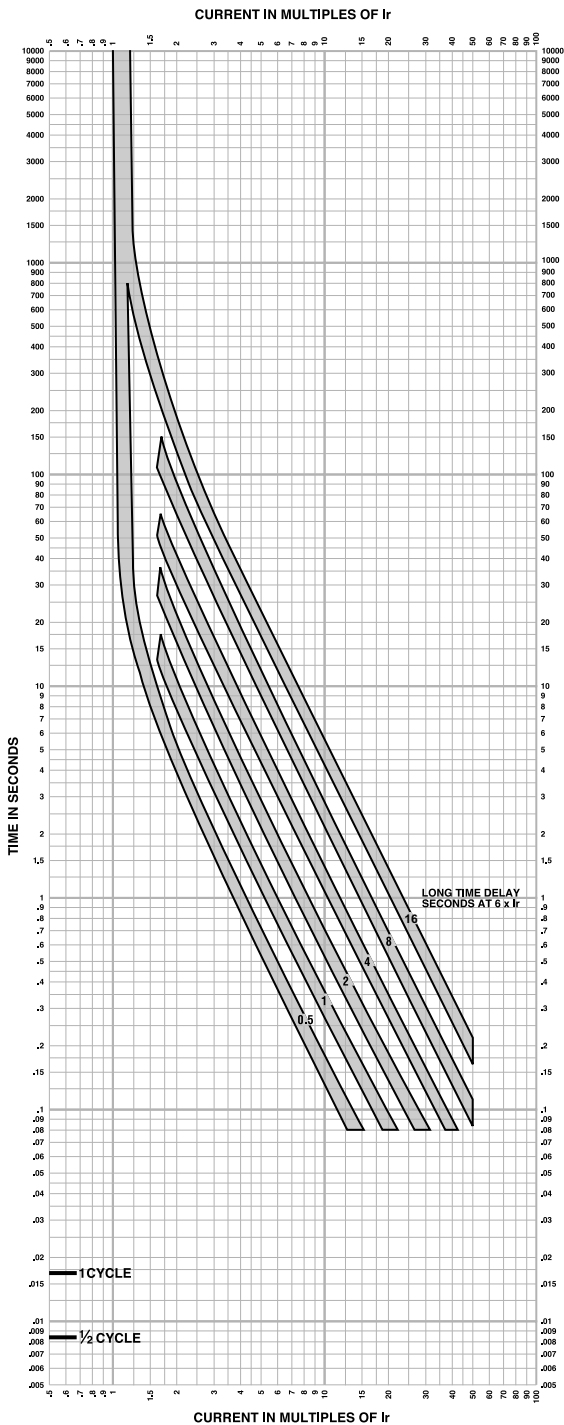

**MICROLOGIC™ ELECTRONIC TRIP UNITS**  
**MicroLogic™ 3.2 Long Time Trip Curve**  
**60A, 100A, 150A H-Frame**

The time-current curve information is to be used for application and coordination purposes only.

**Notes:**

1. There is a thermal-imaging effect that can act to shorten the long-time delay. The thermal imaging effect comes into play if a current above the long-time delay pickup value exists for a time and then is cleared by the tripping of a downstream device or the circuit breaker itself. A subsequent overload will cause the circuit breaker to trip in a shorter time than normal. The amount of time delay reduction is inverse to the amount of time that has elapsed since the previous overload. Approximately 20 minutes is required between overloads to completely reset thermal-imaging.
2. Total clearing times shown include the response times of the trip unit, the circuit breaker opening, and the extinction of the current.

Curves apply from -35°C to +70°C (-31°F to +158°F) ambient temperature.

### MicroLogic 3.2S Electronic Trip Unit Long Time / Short Time Trip Curve

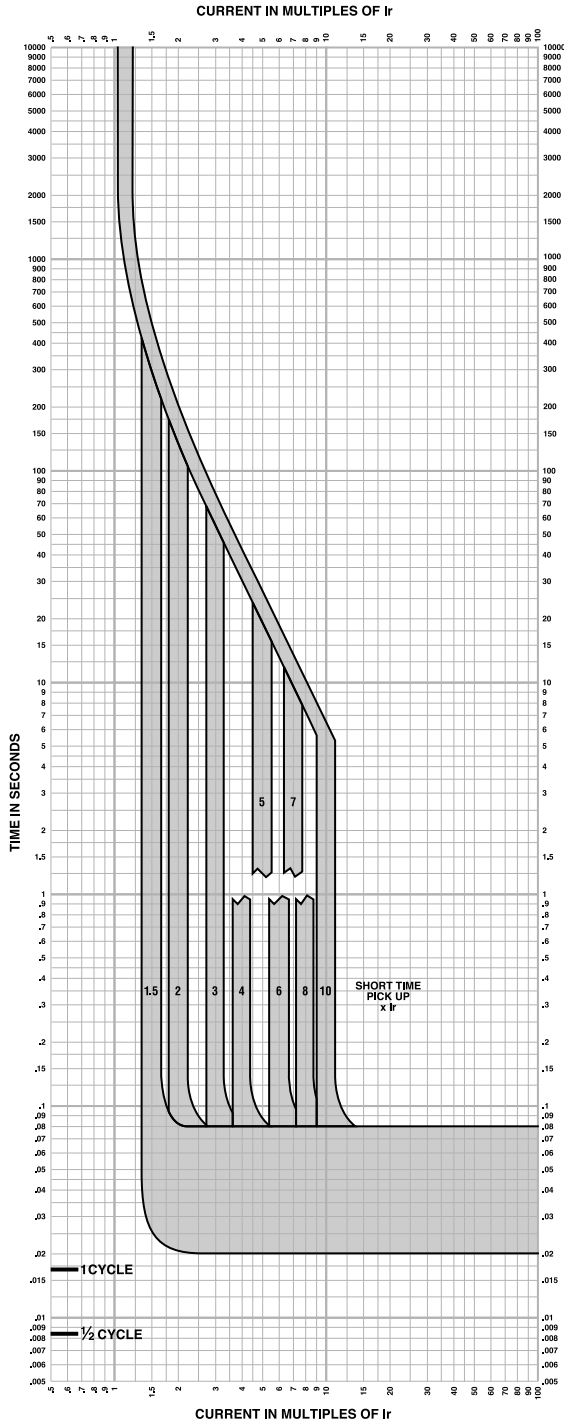

**MICROLOGIC™ ELECTRONIC TRIP UNITS**  
**MicroLogic™ 3.2S Long Time/**  
**Short Time Trip Curve**  
**60A, 100A, 150A H-Frame**

The time-current curve information is to be used for application and coordination purposes only.

**Notes:**

1. There is a thermal-imaging effect that can act to shorten the long-time delay. The thermal imaging effect comes into play if a current above the long-time delay pickup value exists for a time and then is cleared by the tripping of a downstream device or the circuit breaker itself. A subsequent overload will cause the circuit breaker to trip in a shorter time than normal. The amount of time delay reduction is inverse to the amount of time that has elapsed since the previous overload. Approximately 20 minutes is required between overloads to completely reset thermal-imaging.
2. Total clearing times shown include the response times of the trip unit, the circuit breaker opening, and the extinction of the current.

Curves apply from -35°C to +70°C (-31°F to +158°F) ambient temperature.

**MicroLogic 3.2/3.2S/5.2A/5.2E/6.2A/6.2E Electronic Trip Unit Instantaneous Trip Curve**

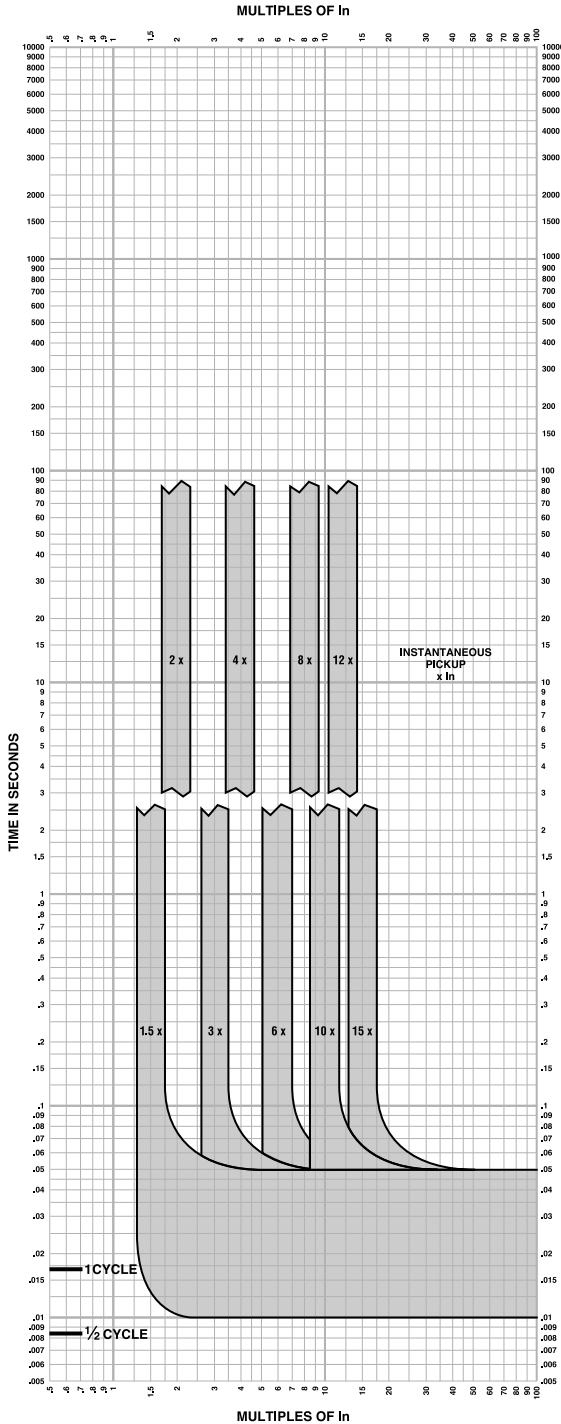

**MICROLOGIC™ ELECTRONIC TRIP UNITS  
MicroLogic™ 3.2/3.2S/5.2A or E/6.2A or E  
Instantaneous Trip Curve  
60A, 100A, 150A H-Frame**

The time-current curve information is to be used for application and coordination purposes only.

**Notes:**

1. There is a thermal-imaging effect that can act to shorten the long-time delay. The thermal imaging effect comes into play if a current above the long-time delay pickup value exists for a time and then is cleared by the tripping of a downstream device or the circuit breaker itself. A subsequent overload will cause the circuit breaker to trip in a shorter time than normal. The amount of time delay reduction is inverse to the amount of time that has elapsed since the previous overload. Approximately 20 minutes is required between overloads to completely reset thermal-imaging.
  2. Total clearing times shown include the response times of the trip unit, the circuit breaker opening, and the extinction of the current.
  3.  $I_n$  = Maximum dial setting of  $I_r$ .  
 60A H-Frame:  $I_n = 60A = \text{Max } I_r \text{ setting}$   
 100A H-Frame:  $I_n = 100A = \text{Max } I_r \text{ setting}$   
 150A H-Frame:  $I_n = 150A = \text{Max } I_r \text{ setting}$
- Curves apply from  $-35^\circ\text{C}$  to  $+70^\circ\text{C}$  ( $-31^\circ\text{F}$  to  $+158^\circ\text{F}$ ) ambient temperature.

### MicroLogic 5.2A/5.2E/6.2A/6.2E Electronic Trip Unit Long Time Trip Curve

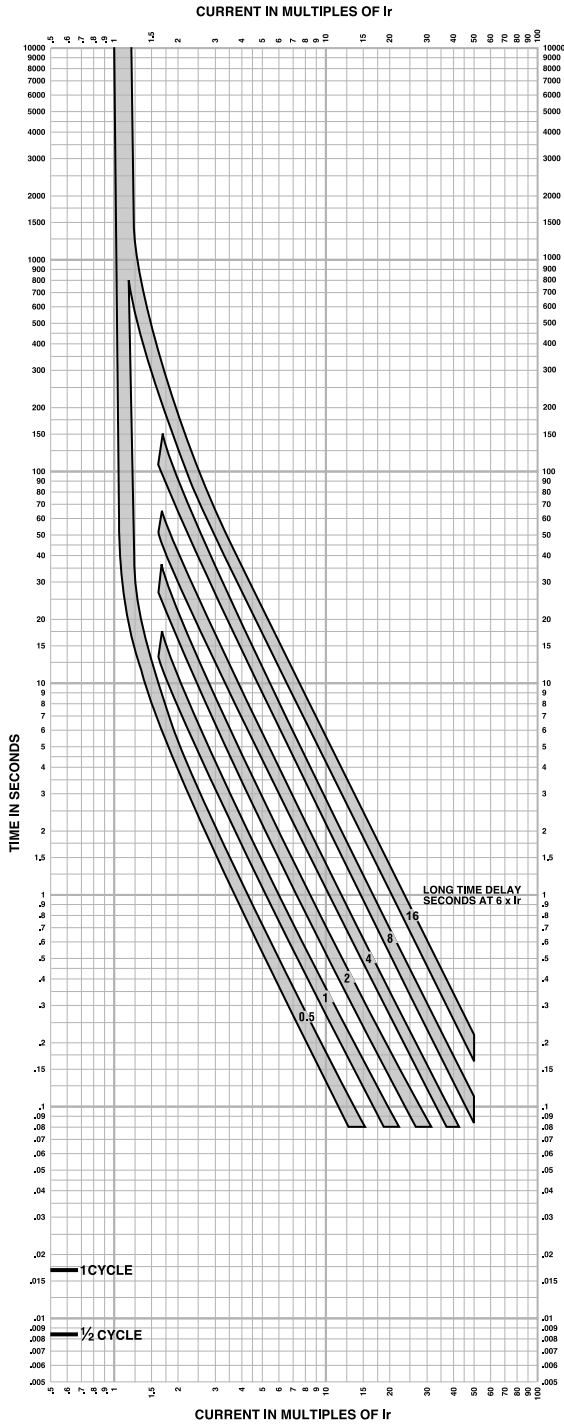

**MICROLOGIC™ ELECTRONIC TRIP UNITS**  
**MicroLogic™ 5.2A or E/6.2A or E**  
**Long Time Trip Curve**  
**60A, 100A, 150A H-Frame**

The time-current curve information is to be used for application and coordination purposes only.

**Notes:**

1. There is a thermal-imaging effect that can act to shorten the long-time delay. The thermal imaging effect comes into play if a current above the long-time delay pickup value exists for a time and then is cleared by the tripping of a downstream device or the circuit breaker itself. A subsequent overload will cause the circuit breaker to trip in a shorter time than normal. The amount of time delay reduction is inverse to the amount of time that has elapsed since the previous overload. Approximately 20 minutes is required between overloads to completely reset thermal-imaging.
2. Total clearing times shown include the response times of the trip unit, the circuit breaker opening, and the extinction of the current.

Curves apply from -35°C to +70°C (-31°F to +158°F) ambient temperature.

### MicroLogic 5.2A/5.2E/6.2A/6.2E Electronic Trip Unit Short Time Trip Curve

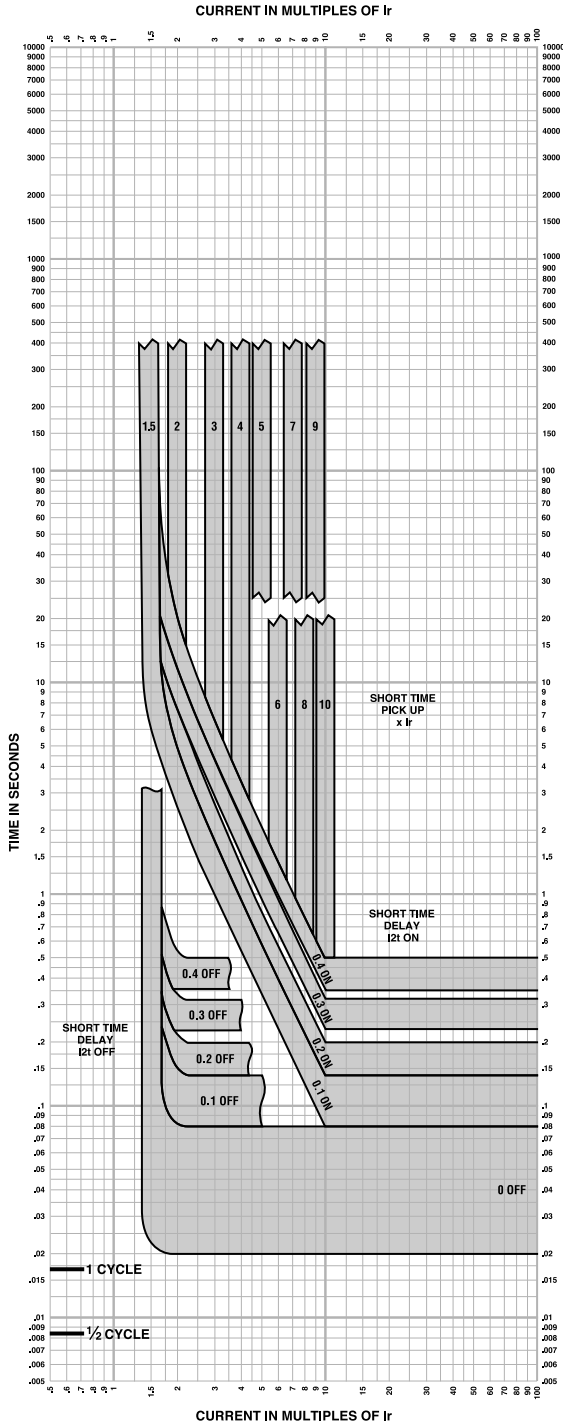

#### MICROLOGIC™ ELECTRONIC TRIP UNITS MicroLogic™ 5.2A or E/6.2A or E Short Time Trip Curve 60A, 100A, 150A H-Frame

The time-current curve information is to be used for application and coordination purposes only.

**Notes:**

1. There is a thermal-imaging effect that can act to shorten the long-time delay. The thermal imaging effect comes into play if a current above the long-time delay pickup value exists for a time and then is cleared by the tripping of a downstream device or the circuit breaker itself. A subsequent overload will cause the circuit breaker to trip in a shorter time than normal. The amount of time delay reduction is inverse to the amount of time that has elapsed since the previous overload. Approximately 20 minutes is required between overloads to completely reset thermal-imaging.
2. Total clearing times shown include the response times of the trip unit, the circuit breaker opening, and the extinction of the current.

Curves apply from -35°C to +70°C (-31°F to +158°F) ambient temperature.



### MicroLogic 6.2A/6.2E Electronic Trip Unit Ground Fault Trip Curve

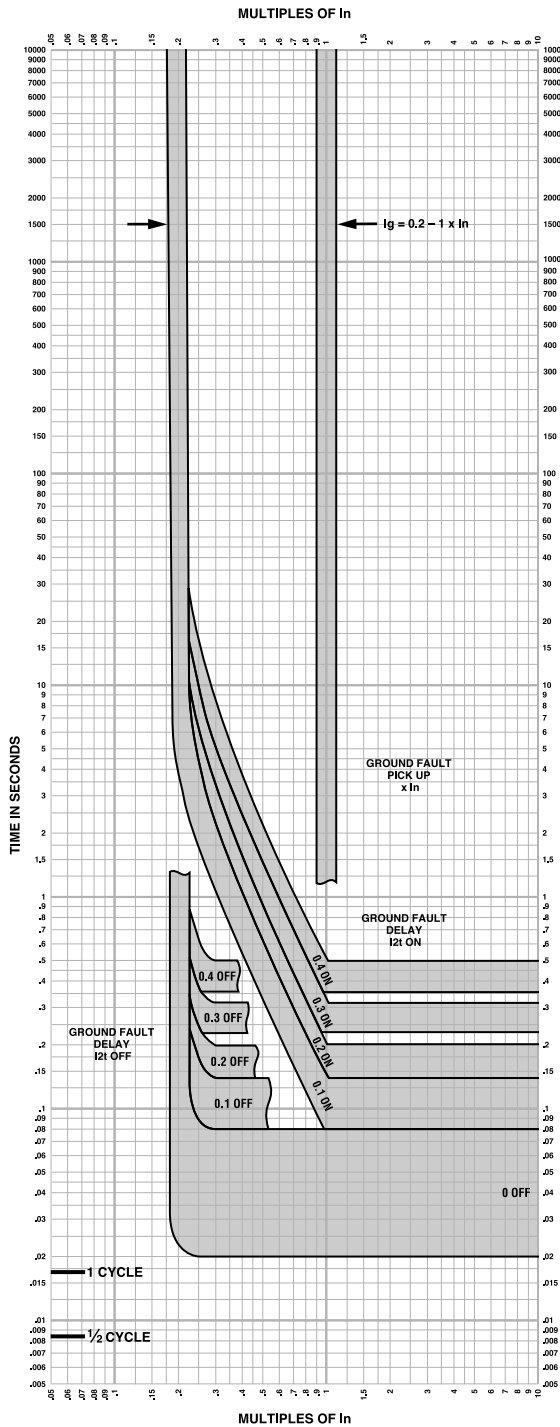

#### MICROLOGIC™ ELECTRONIC TRIP UNITS MicroLogic™ 6.2A or E Ground Fault Trip Curve 100A, 150A H-Frame

The time-current curve information is to be used for application and coordination purposes only.

1. Total clearing times shown include the response times of the trip unit, the circuit breaker opening, and the extinction of the current.

Curves apply from -35°C to +70°C (-31°F to +158°F) ambient temperature.

### MicroLogic 6.2A/6.2E Electronic Trip Unit Ground Fault Trip Curve

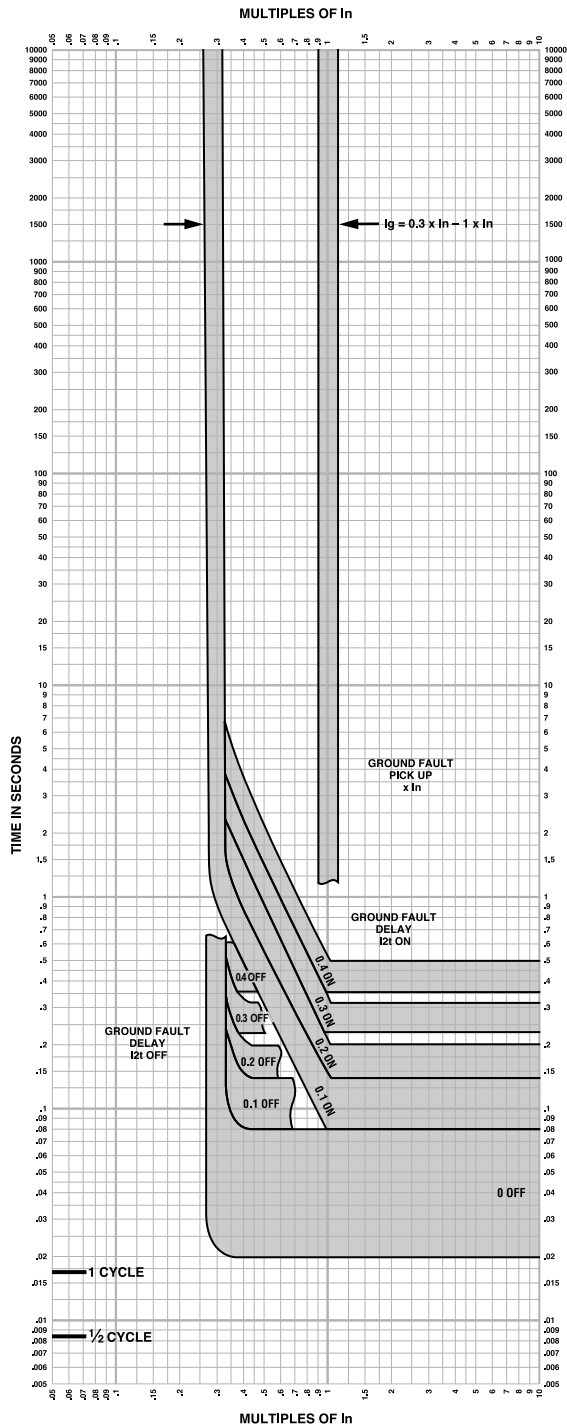

#### MICROLOGIC™ ELECTRONIC TRIP UNITS MicroLogic™ 6.2A or E Ground Fault Trip Curve 60A H-Frame

The time-current curve information is to be used for application and coordination purposes only.

1. Total clearing times shown include the response times of the trip unit, the circuit breaker opening, and the extinction of the current.

Curves apply from -35°C to +70°C (-31°F to +158°F) ambient temperature.

### MicroLogic 2.2 M Electronic Trip Unit Overload Trip Curve

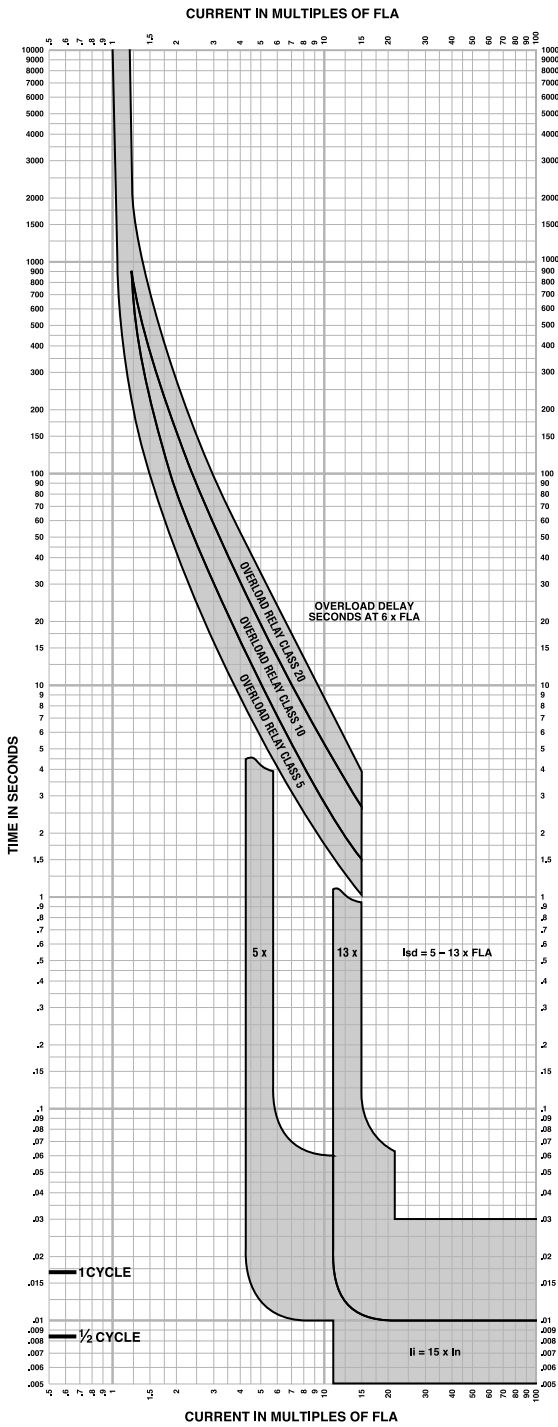

**MICROLOGIC™ ELECTRONIC TRIP UNITS**  
**MicroLogic™ 2.2M Overload Trip Curve**  
**30A, 50A, 100A, 150A H-Frame, 250A J-Frame**

The time-current curve information is to be used for application and coordination purposes only.

**Notes:**

1. If overload still exists past overload relay delay, MCP will open 0.4 seconds later.
2. Total clearing times shown include the response times of the trip unit, the circuit breaker opening, and the extinction of the current.
3. Isd minimum and maximum only shown.
4.  $I_i = 15 \times I_n$   
 $I_n = 30A, 50A, 100A, 150A, 250A$   
 MCP will trip <30ms at  $15 \times I_n$

Curves apply from -35°C to +70°C (-31°F to +158°F) ambient temperature.

# PowerPac T J-Frame Electronic Trip Circuit Breakers—250 A Frame

## MicroLogic 3.2 and 3.2-W Electronic Trip Unit Long-Time Trip Curve

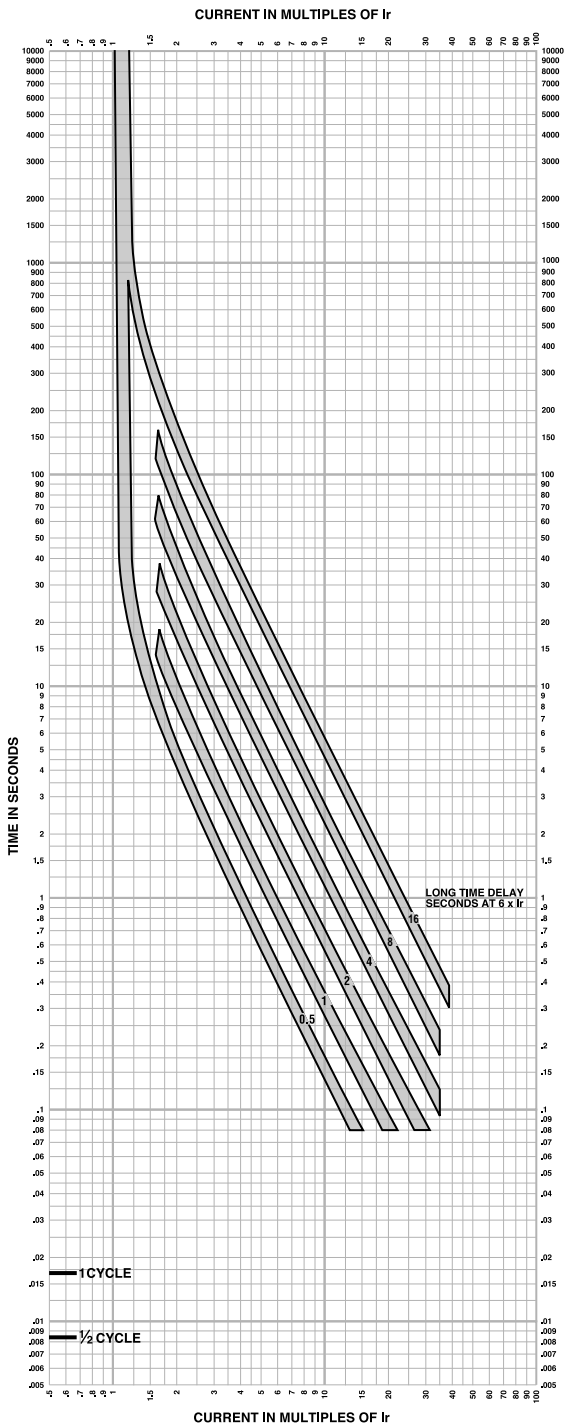

### MICROLOGIC™ ELECTRONIC TRIP UNITS MicroLogic™ 3.2 and 3.2-W Long Time Trip Curve 250A J-Frame

The time-current curve information is to be used for application and coordination purposes only.

**Notes:**

1. There is a thermal-imaging effect that can act to shorten the long-time delay. The thermal imaging effect comes into play if a current above the long-time delay pickup value exists for a time and then is cleared by the tripping of a downstream device or the circuit breaker itself. A subsequent overload will cause the circuit breaker to trip in a shorter time than normal. The amount of time delay reduction is inverse to the amount of time that has elapsed since the previous overload. Approximately 20 minutes is required between overloads to completely reset thermal-imaging.
2. Total clearing times shown include the response times of the trip unit, the circuit breaker opening, and the extinction of the current.

Curves apply from -35°C to +70°C (-31°F to +158°F) ambient temperature.

**MicroLogic 3.2S and 3.2S-W Electronic Trip Unit Long Time / Short Time Trip Curve**

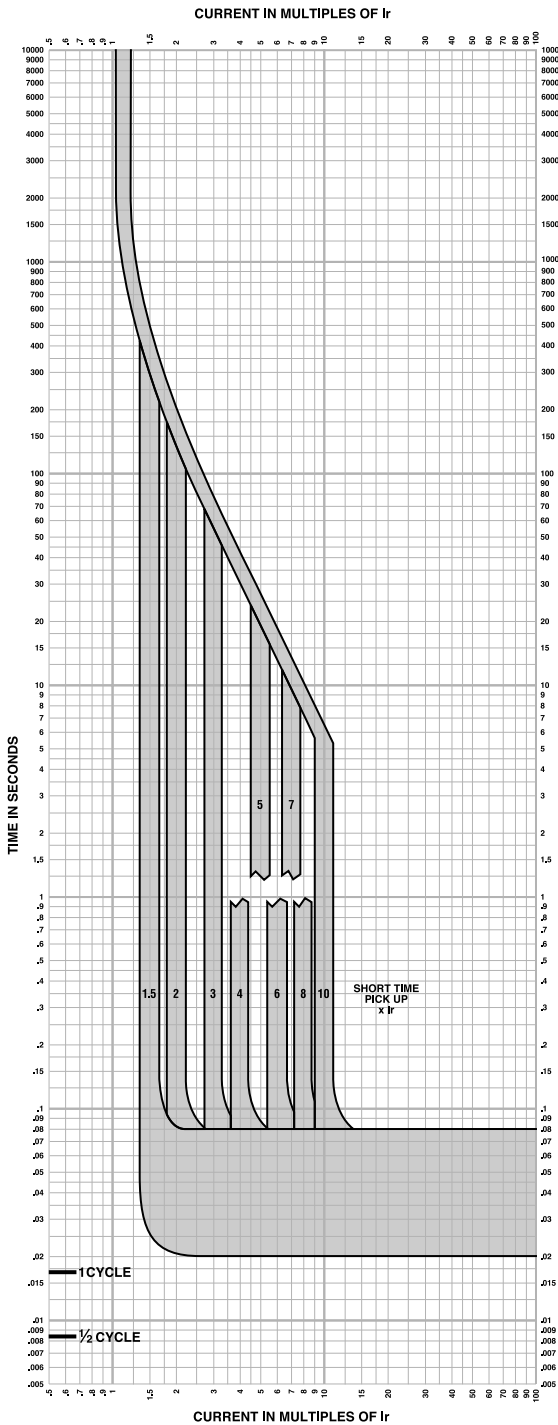

**MICROLOGIC™ ELECTRONIC TRIP UNITS  
MicroLogic™ 3.2S and 3.2S-W  
Long Time/Short Time Trip Curve  
250A J-Frame**

The time-current curve information is to be used for application and coordination purposes only.

**Notes:**

1. There is a thermal-imaging effect that can act to shorten the long-time delay. The thermal imaging effect comes into play if a current above the long-time delay pickup value exists for a time and then is cleared by the tripping of a downstream device or the circuit breaker itself. A subsequent overload will cause the circuit breaker to trip in a shorter time than normal. The amount of time delay reduction is inverse to the amount of time that has elapsed since the previous overload. Approximately 20 minutes is required between overloads to completely reset thermal-imaging.
2. Total clearing times shown include the response times of the trip unit, the circuit breaker opening, and the extinction of the current.

Curves apply from -35°C to +70°C (-31°F to +158°F) ambient temperature.

**MicroLogic 3.2, 3.2-W, 3.2S, 3.2S-W, 5.2A, 5.2A-W, 5.2E, 5.2E-W, 6.2A, 6.2A-W, 6.2E, and 6.2E-W Electronic Trip Curve Instantaneous Trip Curve**

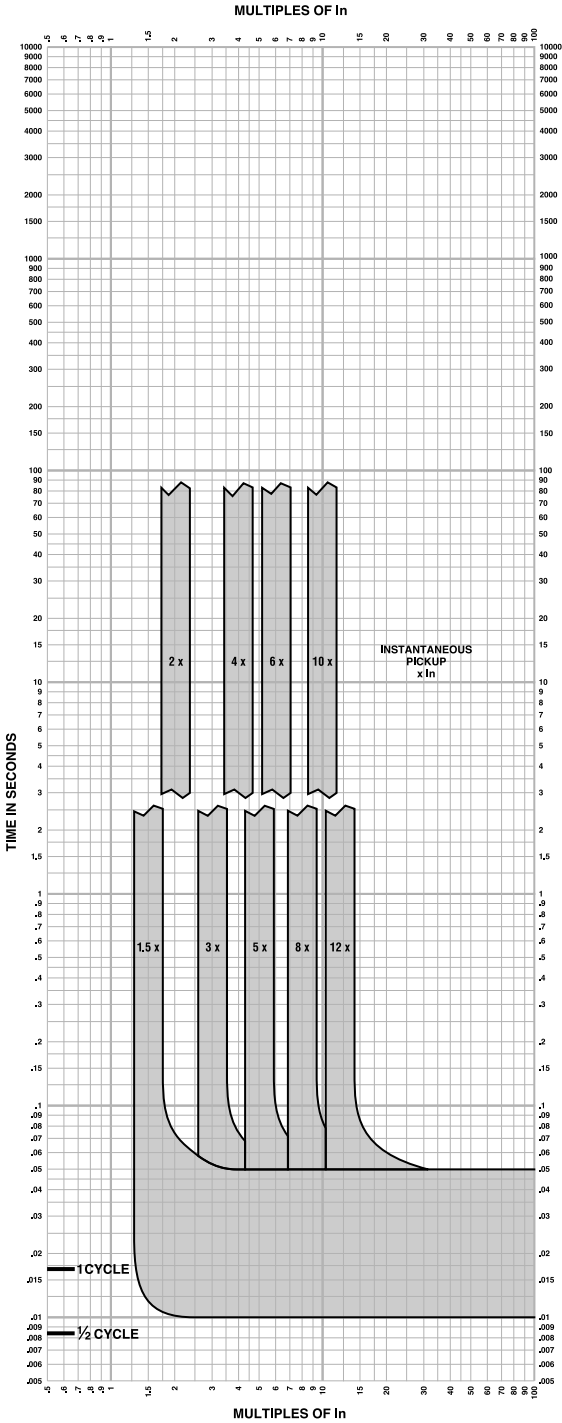

**MICROLOGIC™ ELECTRONIC TRIP UNITS  
MicroLogic™ 3.2, 3.2-W, 3.2S, 3.2S-W,  
5.2A, 5.2A-W, 5.2E, 5.2E-W, 6.2A, 6.2A-W,  
6.2E, and 6.2E-W  
Instantaneous Trip Curve  
250A J-Frame**

The time-current curve information is to be used for application and coordination purposes only.

**Notes:**

1. There is a thermal-imaging effect that can act to shorten the long-time delay. The thermal imaging effect comes into play if a current above the long-time delay pickup value exists for a time and then is cleared by the tripping of a downstream device or the circuit breaker itself. A subsequent overload will cause the circuit breaker to trip in a shorter time than normal. The amount of time delay reduction is inverse to the amount of time that has elapsed since the previous overload. Approximately 20 minutes is required between overloads to completely reset thermal-imaging.
  2. Total clearing times shown include the response times of the trip unit, the circuit breaker opening, and the extinction of the current.
  3. In = Maximum dial setting of Ir.  
250A J-Frame: In = 250A = Max Ir setting
- Curves apply from -35°C to +70°C (-31°F to +158°F) ambient temperature.

**MicroLogic 5.2A, 5.2A-W, 5.2E, 5.2E-W, 6.2A, 6.2A-W, 6.2E, and 6.2E-W Electronic Trip Unit Long Time Trip Curve**

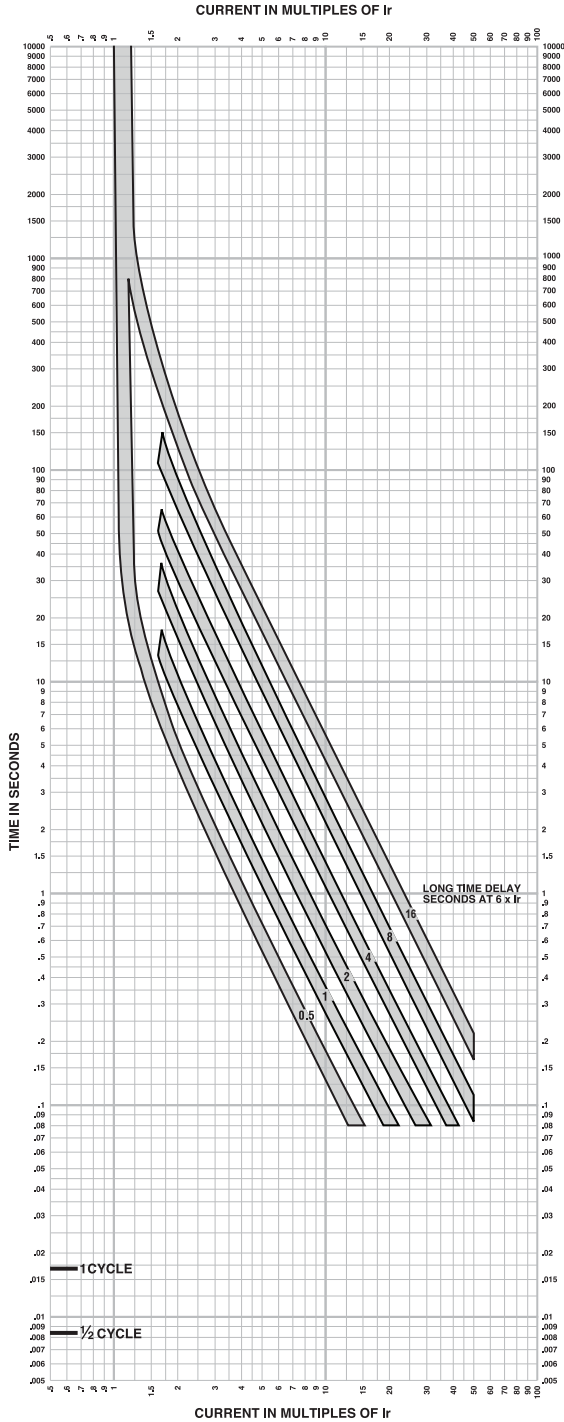

**MICROLOGIC™ ELECTRONIC TRIP UNITS**  
**MicroLogic™ 5.2A, 5.2A-W, 5.2E, 5.2E-W,**  
**6.2A, 6.2A-W, 6.2E, and 6.2E-W**  
**Long Time Trip Curve**  
**250A J-Frame**

The time-current curve information is to be used for application and coordination purposes only.

**Notes:**

1. There is a thermal-imaging effect that can act to shorten the long-time delay. The thermal imaging effect comes into play if a current above the long-time delay pickup value exists for a time and then is cleared by the tripping of a downstream device or the circuit breaker itself. A subsequent overload will cause the circuit breaker to trip in a shorter time than normal. The amount of time delay reduction is inverse to the amount of time that has elapsed since the previous overload. Approximately 20 minutes is required between overloads to completely reset thermal-imaging.
2. Total clearing times shown include the response times of the trip unit, the circuit breaker opening, and the extinction of the current.

Curves apply from -35°C to +70°C (-31°F to +158°F) ambient temperature.

### MicroLogic 5.2A, 5.2A-W, 5.2E, 5.2E-W, 6.2A, 6.2A-W, 6.2E, and 6.2E-W Electronic Trip Unit Short Time Trip Curve

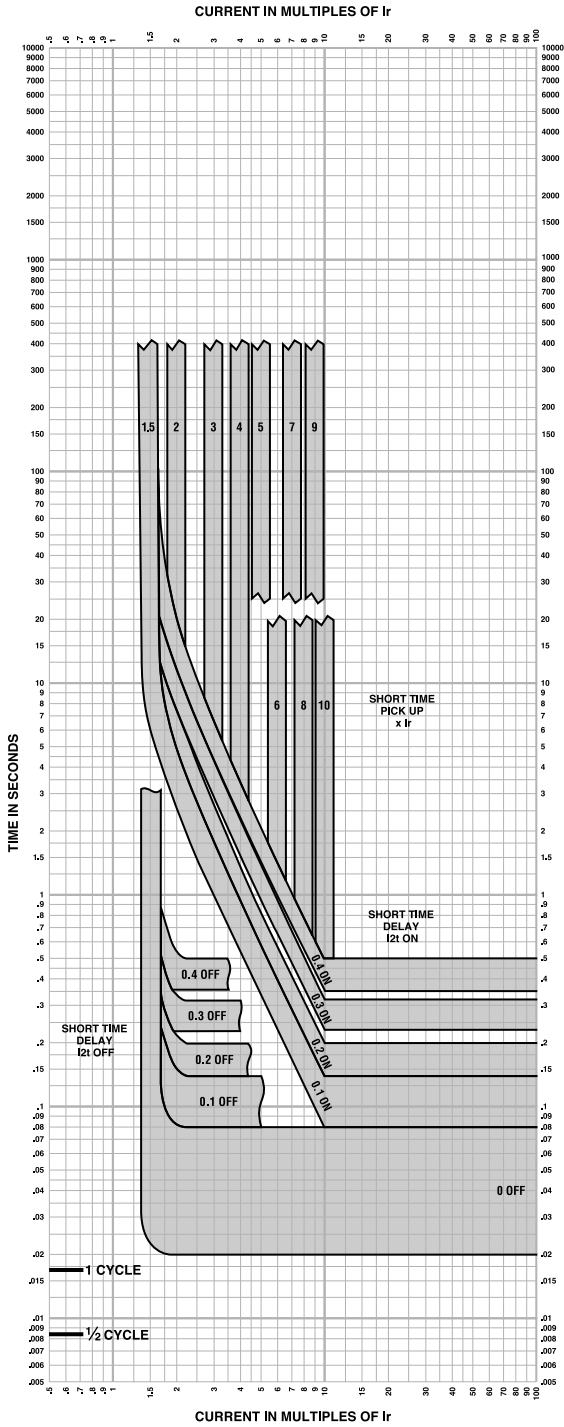

**MICROLOGIC™ ELECTRONIC TRIP UNITS**  
**MicroLogic™ 5.2A, 5.2A-W, 5.2E, 5.2E-W,**  
**6.2A, 6.2A-W, 6.2E, and 6.2E-W**  
**Short Time Trip Curve**  
**250A J-Frame**

The time-current curve information is to be used for application and coordination purposes only.

**Notes:**

1. There is a thermal-imaging effect that can act to shorten the long-time delay. The thermal imaging effect comes into play if a current above the long-time delay pickup value exists for a time and then is cleared by the tripping of a downstream device or the circuit breaker itself. A subsequent overload will cause the circuit breaker to trip in a shorter time than normal. The amount of time delay reduction is inverse to the amount of time that has elapsed since the previous overload. Approximately 20 minutes is required between overloads to completely reset thermal-imaging.
2. Total clearing times shown include the response times of the trip unit, the circuit breaker opening, and the extinction of the current.

Curves apply from -35°C to +70°C (-31°F to +158°F) ambient temperature.



**MicroLogic 6.2A, 6.2A-W, 6.2E, and 6.2E-W Electronic Trip Unit Ground Fault Trip Curve**

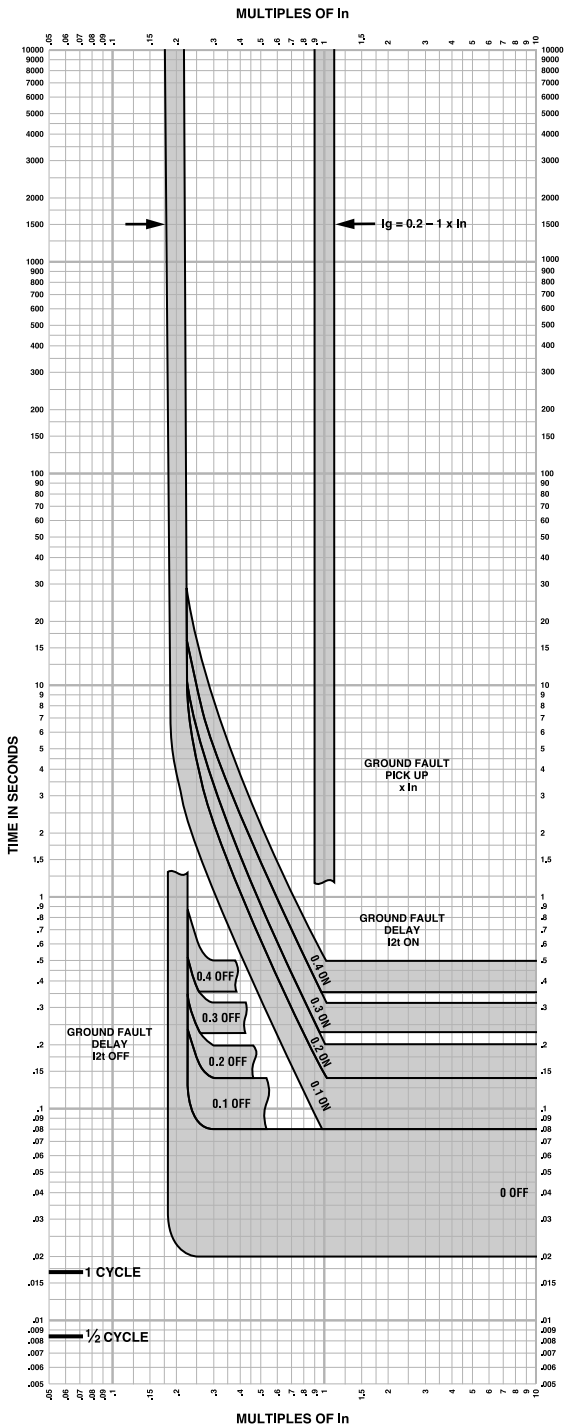

**MICROLOGIC™ ELECTRONIC TRIP UNITS  
MicroLogic™ 6.2A, 6.2A-W, 6.2E, and 6.2E-W  
Ground Fault Trip Curve  
250A J-Frame**

The time-current curve information is to be used for application and coordination purposes only.

1. Total clearing times shown include the response times of the trip unit, the circuit breaker opening, and the extinction of the current.

Curves apply from -35°C to +70°C (-31°F to +158°F) ambient temperature.

### MicroLogic 2.2 M Electronic Trip Unit Overload Trip Curve

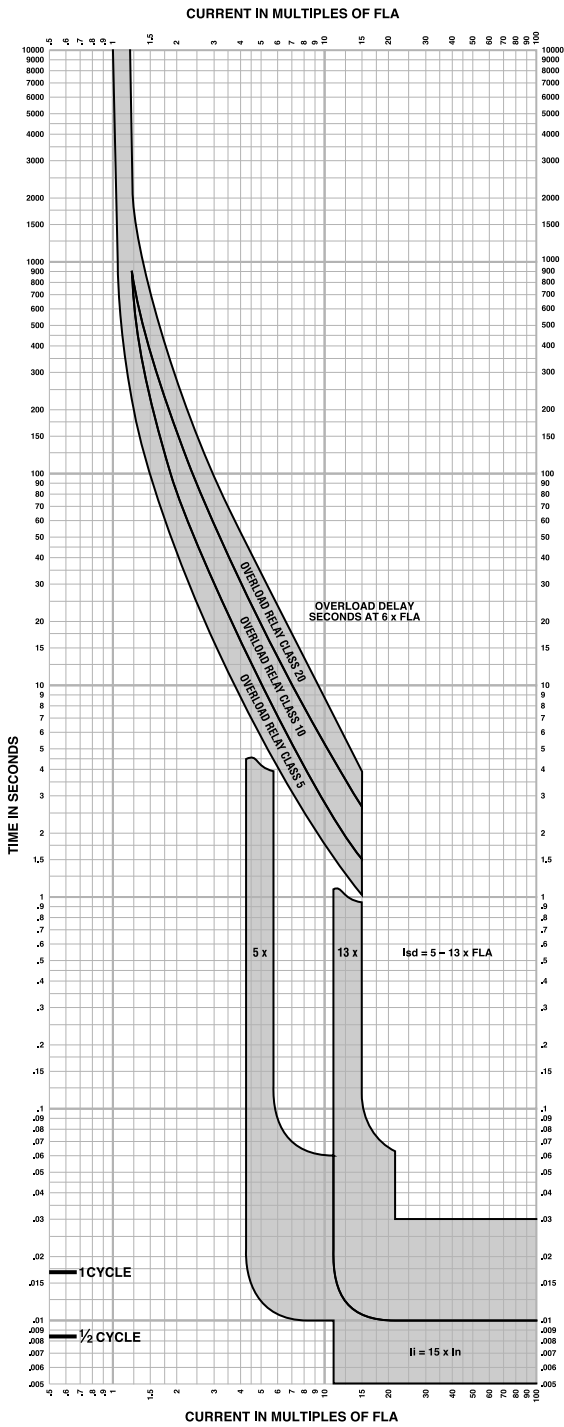

**MICROLOGIC™ ELECTRONIC TRIP UNITS**  
**MicroLogic™ 2.2M Overload Trip Curve**  
**30A, 50A, 100A, 150A H-Frame, 250A J-Frame**

The time-current curve information is to be used for application and coordination purposes only.

**Notes:**

1. If overload still exists past overload relay delay, MCP will open 0.4 seconds later.
  2. Total clearing times shown include the response times of the trip unit, the circuit breaker opening, and the extinction of the current.
  3. Isd minimum and maximum only shown.
  4.  $I_i = 15 \times I_n$   
 $I_n = 30A, 50A, 100A, 150A, 250A$   
 MCP will trip <30ms at  $15 \times I_n$
- Curves apply from -35°C to +70°C (-31°F to +158°F) ambient temperature.

# PowerPacT L-Frame Electronic Trip Circuit Breakers— 250/400/600 A Frame

## MicroLogic 3.3 and 3.3-W Electronic Trip Unit Long Time Trip Curve

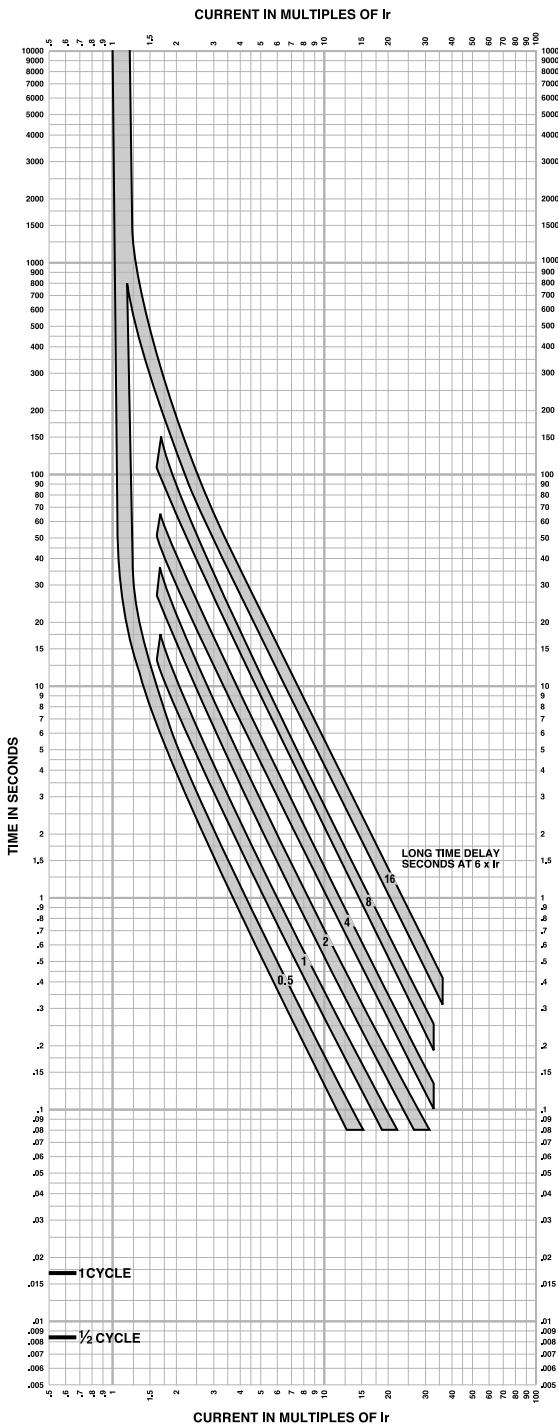

### MICROLOGIC™ ELECTRONIC TRIP UNITS MicroLogic™ 3.3 and 3.3-W Long Time Trip Curve 250A, 400A L-Frame

The time-current curve information is to be used for application and coordination purposes only.

**Notes:**

1. There is a thermal-imaging effect that can act to shorten the long-time delay. The thermal imaging effect comes into play if a current above the long-time delay pickup value exists for a time and then is cleared by the tripping of a downstream device or the circuit breaker itself. A subsequent overload will cause the circuit breaker to trip in a shorter time than normal. The amount of time delay reduction is inverse to the amount of time that has elapsed since the previous overload. Approximately 20 minutes is required between overloads to completely reset thermal-imaging.
2. Total clearing times shown include the response times of the trip unit, the circuit breaker opening, and the extinction of the current.

Curves apply from -35°C to +70°C (-31°F to +158°F) ambient temperature.

**MicroLogic 3.3S and 3.3S-W Electronic Trip Unit Long Time/Short Time Trip Curve**

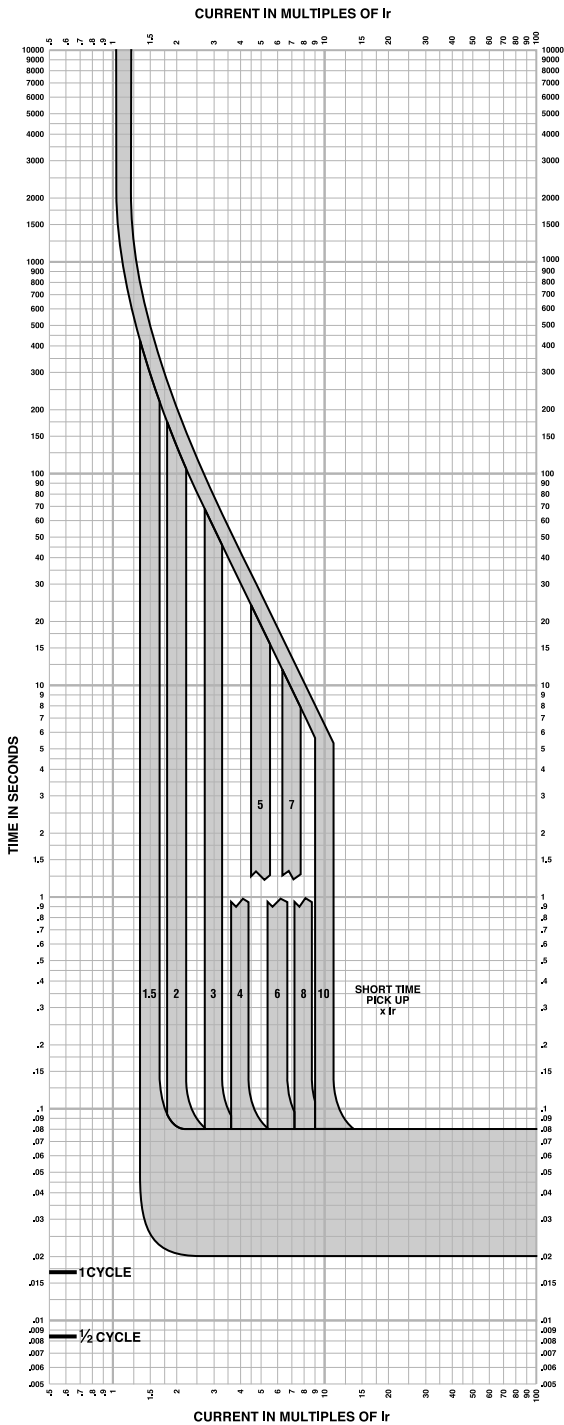

**MICROLOGIC™ ELECTRONIC TRIP UNITS  
MicroLogic™ 3.3S and 3.3S-W  
Long Time/Short Time Trip Curve  
250A, 400A L-Frame**

The time-current curve information is to be used for application and coordination purposes only.

**Notes:**

1. There is a thermal-imaging effect that can act to shorten the long-time delay. The thermal imaging effect comes into play if a current above the long-time delay pickup value exists for a time and then is cleared by the tripping of a downstream device or the circuit breaker itself. A subsequent overload will cause the circuit breaker to trip in a shorter time than normal. The amount of time delay reduction is inverse to the amount of time that has elapsed since the previous overload. Approximately 20 minutes is required between overloads to completely reset thermal-imaging.
2. Total clearing times shown include the response times of the trip unit, the circuit breaker opening, and the extinction of the current.

Curves apply from -35°C to +70°C (-31°F to +158°F) ambient temperature.

**MicroLogic 3.3, 3.3-W, 3.3S, and 3.3S-W Electronic Trip Unit Instantaneous Trip Curve**

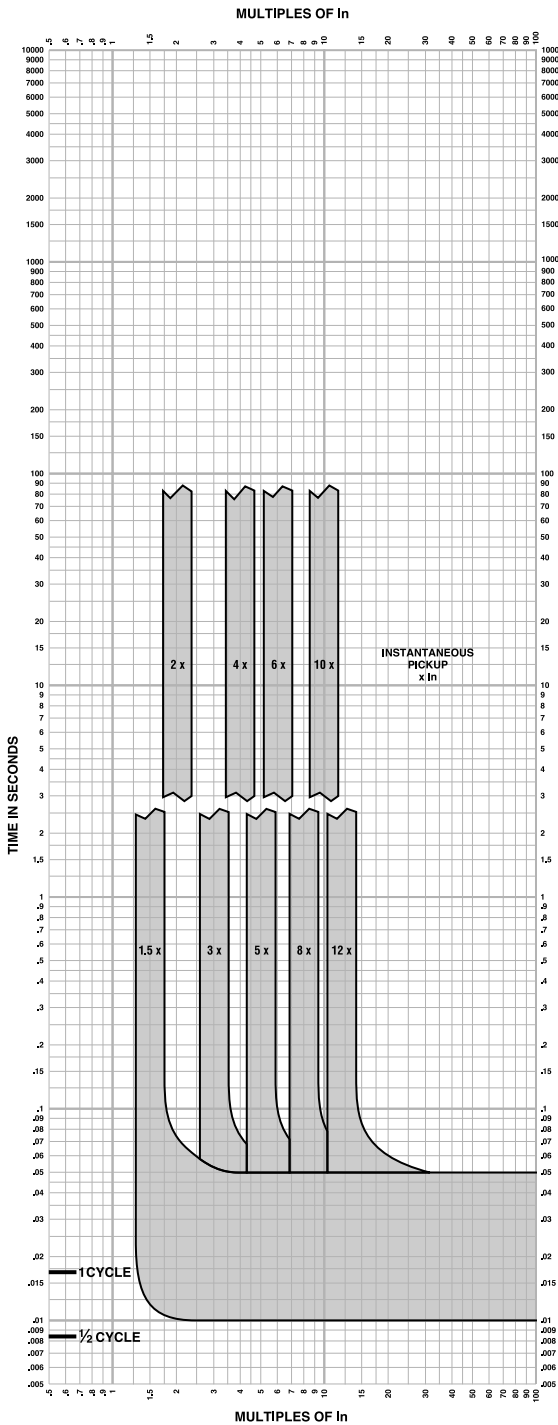

**MICROLOGIC™ ELECTRONIC TRIP UNITS  
MicroLogic™ 3.3, 3.3-W, 3.3S, and 3.3S-W  
Instantaneous Trip Curve  
250A L-Frame**

The time-current curve information is to be used for application and coordination purposes only.

**Notes:**

1. There is a thermal-imaging effect that can act to shorten the long-time delay. The thermal imaging effect comes into play if a current above the long-time delay pickup value exists for a time and then is cleared by the tripping of a downstream device or the circuit breaker itself. A subsequent overload will cause the circuit breaker to trip in a shorter time than normal. The amount of time delay reduction is inverse to the amount of time that has elapsed since the previous overload. Approximately 20 minutes is required between overloads to completely reset thermal-imaging.
  2. Total clearing times shown include the response times of the trip unit, the circuit breaker opening, and the extinction of the current.
  3.  $I_n$  = Maximum dial setting of  $I_r$ .  
250A L-Frame:  $I_n = 250A = \text{Max } I_r$  setting
- Curves apply from  $-35^\circ\text{C}$  to  $+70^\circ\text{C}$  ( $-31^\circ\text{F}$  to  $+158^\circ\text{F}$ ) ambient temperature.

**MicroLogic 3.3, 3.3-W, 3.3S, 3.3S-W, 5.3A, 5.3A-W, 5.3E, 5.3E-W, 6.3A, 6.3A-W, 6.3E, and 6.3E-W Electronic Trip Unit Instantaneous Trip Curve**

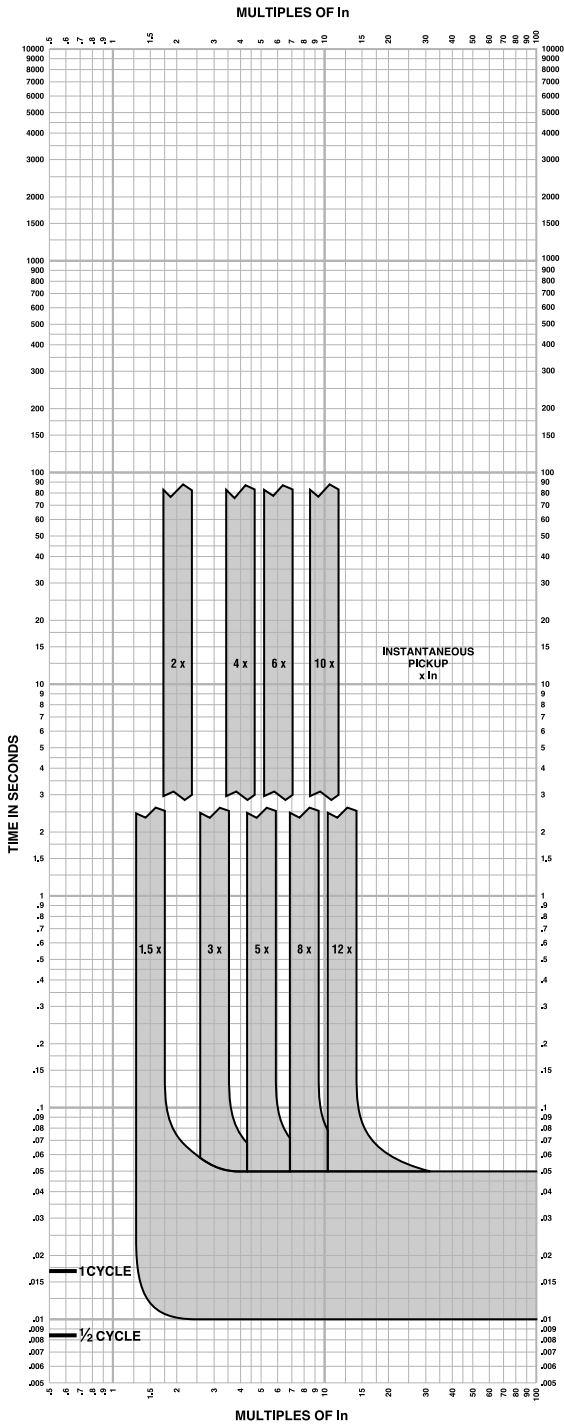

**MICROLOGIC™ ELECTRONIC TRIP UNITS  
MicroLogic™ 3.3, 3.3-W, 3.3S, 3.3S-W,  
5.3A, 5.3A-W, 5.3E, 5.3E-W, 6.3A, 6.3A-W,  
6.3E, and 6.3E-W  
Instantaneous Trip Curve  
400A L-Frame**

The time-current curve information is to be used for application and coordination purposes only.

**Notes:**

1. There is a thermal-imaging effect that can act to shorten the long-time delay. The thermal imaging effect comes into play if a current above the long-time delay pickup value exists for a time and then is cleared by the tripping of a downstream device or the circuit breaker itself. A subsequent overload will cause the circuit breaker to trip in a shorter time than normal. The amount of time delay reduction is inverse to the amount of time that has elapsed since the previous overload. Approximately 20 minutes is required between overloads to completely reset thermal-imaging.
2. Total clearing times shown include the response times of the trip unit, the circuit breaker opening, and the extinction of the current.
3. In = Maximum dial setting of Ir.  
400A L-Frame: In = 400A = Max Ir setting

Curves apply from -35°C to +70°C (-31°F to +158°F) ambient temperature.

**MicroLogic 5.3A, 5.3A-W, 5.3E, 5.3E-W, 6.3A, 6.3A-W, 6.3E, and 6.3E-W Electronic Trip Unit Long Time Trip Curve**

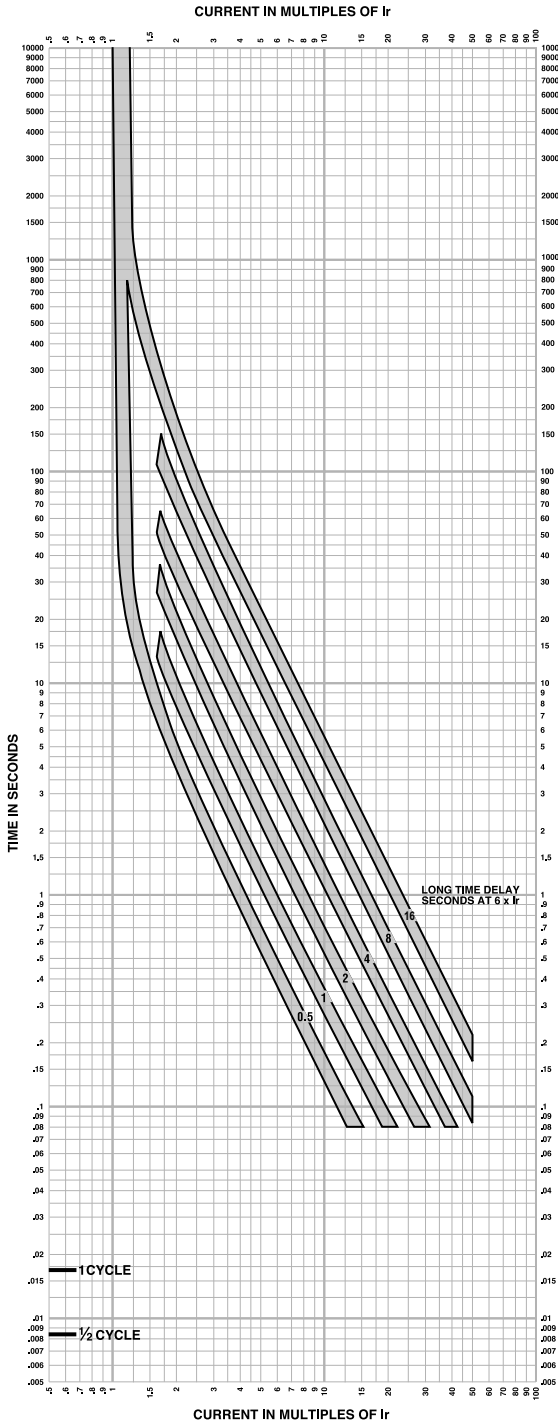

**MICROLOGIC™ ELECTRONIC TRIP UNITS  
MicroLogic™ 5.3A, 5.3A-W, 5.3E, 5.3E-W,  
6.3A, 6.3A-W, 6.3E, and 6.3E-W  
Long Time Trip Curve  
400A L-Frame**

The time-current curve information is to be used for application and coordination purposes only.

**Notes:**

1. There is a thermal-imaging effect that can act to shorten the long-time delay. The thermal imaging effect comes into play if a current above the long-time delay pickup value exists for a time and then is cleared by the tripping of a downstream device or the circuit breaker itself. A subsequent overload will cause the circuit breaker to trip in a shorter time than normal. The amount of time delay reduction is inverse to the amount of time that has elapsed since the previous overload. Approximately 20 minutes is required between overloads to completely reset thermal-imaging.
2. Total clearing times shown include the response times of the trip unit, the circuit breaker opening, and the extinction of the current.

Curves apply from -35°C to +70°C (-31°F to +158°F) ambient temperature.

**MicroLogic 5.3, 5.3A-W, 5.3E, 5.3E-W, 6.3A, 6.3A-W, 6.3E, and 6.3E-W Electronic Trip Unit Short Time Trip Curve**

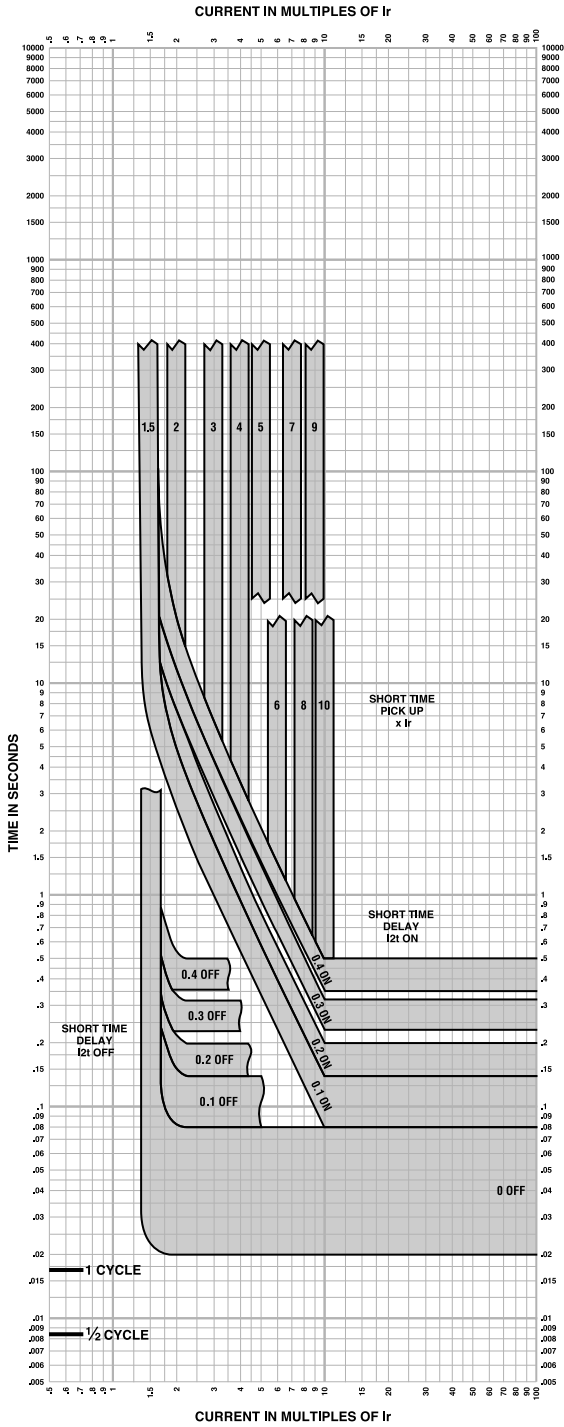

**MICROLOGIC™ ELECTRONIC TRIP UNITS  
MicroLogic™ 5.3A, 5.3A-W, 5.3E, 5.3E-W,  
6.3A, 6.3A-W, 6.3E, and 6.3E-W  
Short Time Trip Curve  
400A L-Frame**

The time-current curve information is to be used for application and coordination purposes only.

**Notes:**

1. There is a thermal-imaging effect that can act to shorten the long-time delay. The thermal imaging effect comes into play if a current above the long-time delay pickup value exists for a time and then is cleared by the tripping of a downstream device or the circuit breaker itself. A subsequent overload will cause the circuit breaker to trip in a shorter time than normal. The amount of time delay reduction is inverse to the amount of time that has elapsed since the previous overload. Approximately 20 minutes is required between overloads to completely reset thermal-imaging.
2. Total clearing times shown include the response times of the trip unit, the circuit breaker opening, and the extinction of the current.

Curves apply from -35°C to +70°C (-31°F to +158°F) ambient temperature.



### MicroLogic 1.3 M Electronic Trip Unit Instantaneous Trip Curve

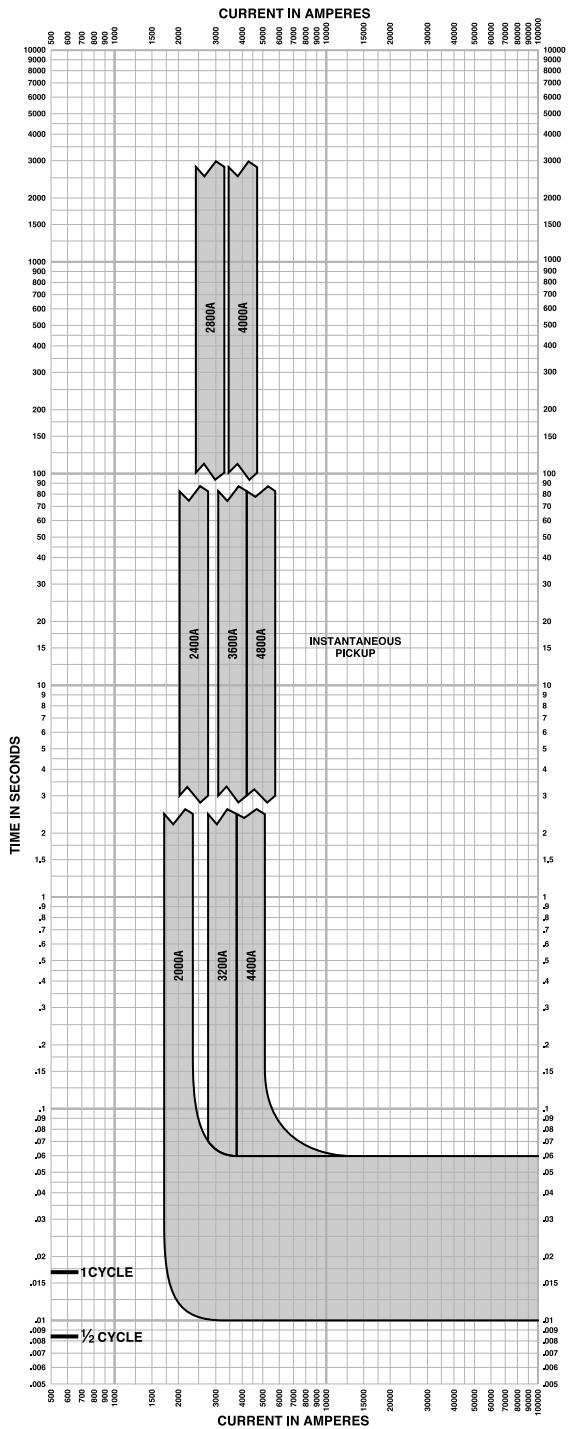

#### MICROLOGIC™ ELECTRONIC TRIP UNITS MicroLogic™ 1.3M Instantaneous Trip Curve 400A L-Frame

The time-current curve information is to be used for application and coordination purposes only.

**Notes:**

1. Total clearing times shown include the response times of the trip unit, the circuit breaker opening, and the extinction of the current.

Curves apply from -35°C to +70°C (-31°F to +158°F) ambient temperature.

### MicroLogic 2.3 M Electronic Trip Unit Overload Trip Curve

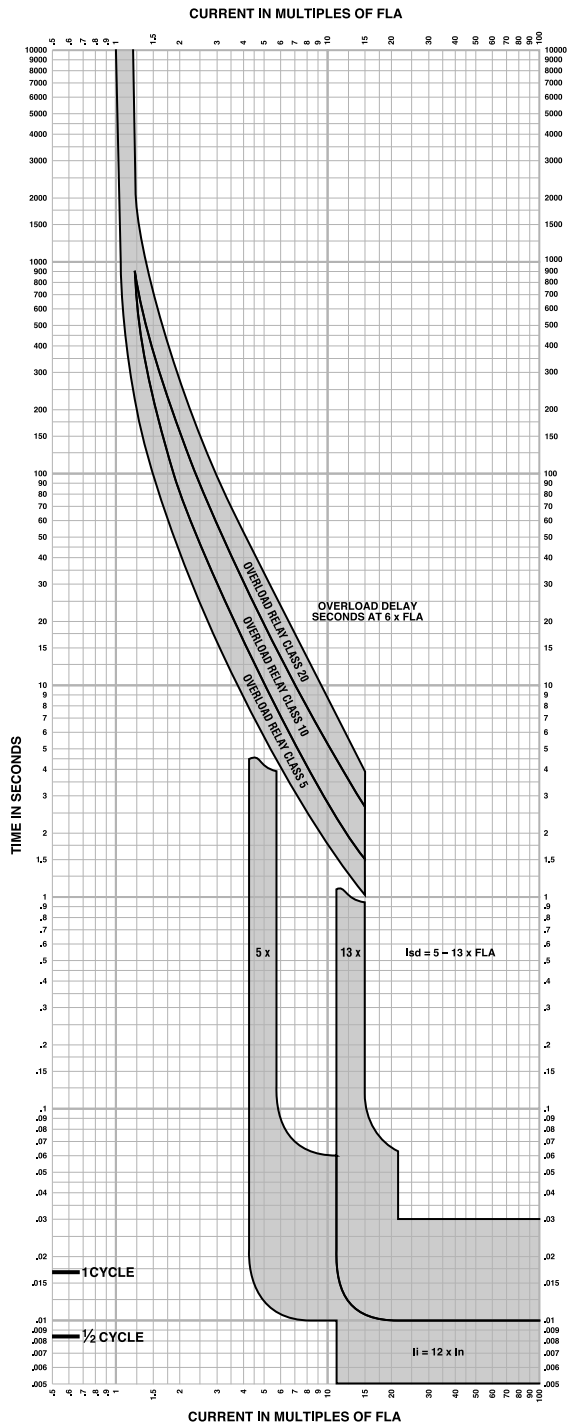

**MICROLOGIC™ ELECTRONIC TRIP UNITS**  
**MicroLogic™ 2.3M Overload Trip Curve**  
**400A, 600A L-Frame**

The time-current curve information is to be used for application and coordination purposes only.

**Notes:**

1. If overload still exists past overload relay delay, MCP will open 0.4 seconds later.
2. Total clearing times shown include the response times of the trip unit, the circuit breaker opening, and the extinction of the current.
3. Isd minimum and maximum only shown.
4.  $I_i = 12 \times I_n$   
 $I_n = 400A, 600A$   
 MCP will trip <30ms at  $12 \times I_n$

Curves apply from -35°C to +70°C (-31°F to +158°F) ambient temperature.

### MicroLogic 3.3 and 3.3W Electronic Trip Unit Long Time Trip Curve

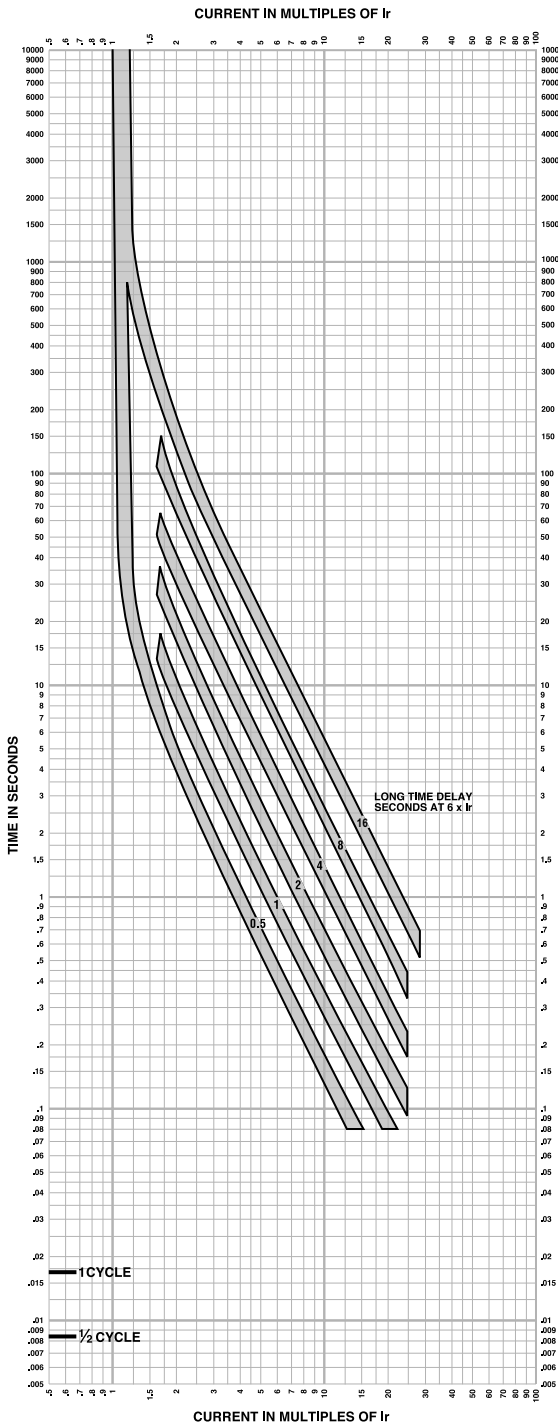

#### MICROLOGIC™ ELECTRONIC TRIP UNITS MicroLogic™ 3.3 and 3.3-W Long Time Trip Curve 600A L-Frame

The time-current curve information is to be used for application and coordination purposes only.

**Notes:**

1. There is a thermal-imaging effect that can act to shorten the long-time delay. The thermal imaging effect comes into play if a current above the long-time delay pickup value exists for a time and then is cleared by the tripping of a downstream device or the circuit breaker itself. A subsequent overload will cause the circuit breaker to trip in a shorter time than normal. The amount of time delay reduction is inverse to the amount of time that has elapsed since the previous overload. Approximately 20 minutes is required between overloads to completely reset thermal-imaging.
2. Total clearing times shown include the response times of the trip unit, the circuit breaker opening, and the extinction of the current.

Curves apply from -35°C to +70°C (-31°F to +158°F) ambient temperature.

### MicroLogic 3.3S and 3.3S-W Electronic Trip Unit Long Time/Short Time Trip Curve

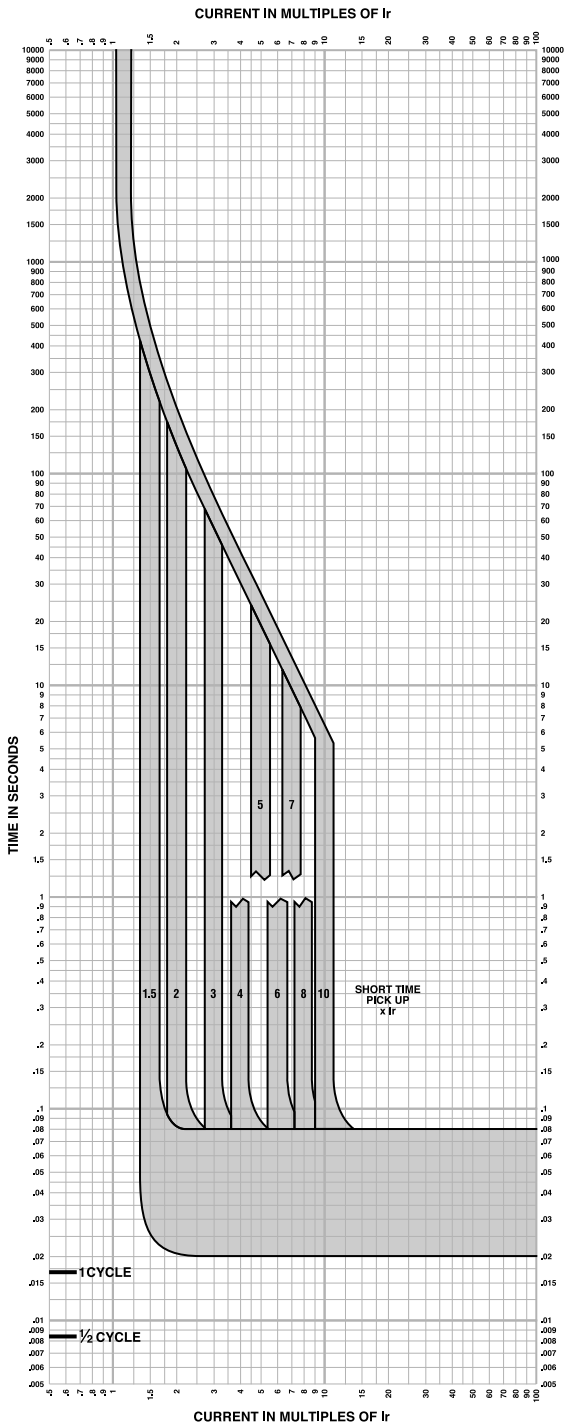

#### MICROLOGIC™ ELECTRONIC TRIP UNITS MicroLogic™ 3.3S and 3.3S-W Long Time/Short Time Trip Curve 600A L-Frame

The time-current curve information is to be used for application and coordination purposes only.

**Notes:**

1. There is a thermal-imaging effect that can act to shorten the long-time delay. The thermal imaging effect comes into play if a current above the long-time delay pickup value exists for a time and then is cleared by the tripping of a downstream device or the circuit breaker itself. A subsequent overload will cause the circuit breaker to trip in a shorter time than normal. The amount of time delay reduction is inverse to the amount of time that has elapsed since the previous overload. Approximately 20 minutes is required between overloads to completely reset thermal-imaging.
2. Total clearing times shown include the response times of the trip unit, the circuit breaker opening, and the extinction of the current.

Curves apply from -35°C to +70°C (-31°F to +158°F) ambient temperature.

**MicroLogic 3.3, 3.3-W, 3.3S, 3.3S-W, 5.3A, 5.3A-W, 5.3E, 5.3E-W, 6.3A, 6.3A-W, 6.3E, and 6.3E-W Electronic Trip Unit Instantaneous Trip Curve**

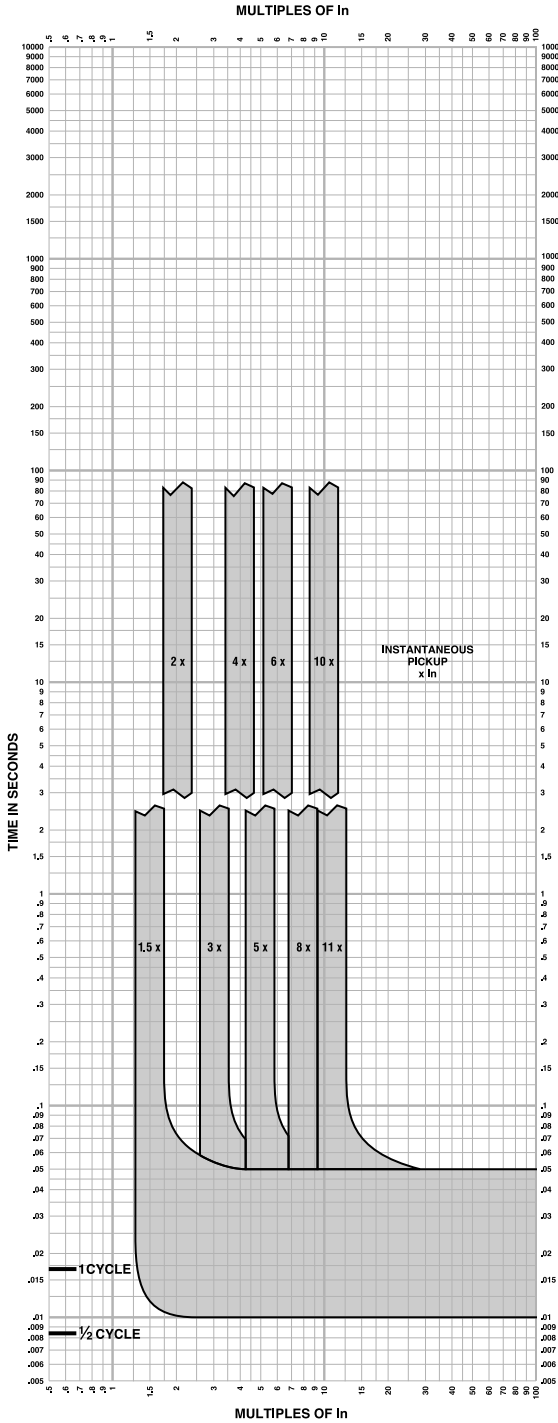

**MICROLOGIC™ ELECTRONIC TRIP UNITS  
MicroLogic™ 3.3, 3.3-W, 3.3S, 3.3S-W,  
5.3A, 5.3A-W, 5.3E, 5.3E-W, 6.3A, 6.3A-W,  
6.3E, and 6.3E-W  
Instantaneous Trip Curve  
600A L-Frame**

The time-current curve information is to be used for application and coordination purposes only.

**Notes:**

1. There is a thermal-imaging effect that can act to shorten the long-time delay. The thermal imaging effect comes into play if a current above the long-time delay pickup value exists for a time and then is cleared by the tripping of a downstream device or the circuit breaker itself. A subsequent overload will cause the circuit breaker to trip in a shorter time than normal. The amount of time delay reduction is inverse to the amount of time that has elapsed since the previous overload. Approximately 20 minutes is required between overloads to completely reset thermal-imaging.
  2. Total clearing times shown include the response times of the trip unit, the circuit breaker opening, and the extinction of the current.
  3.  $I_n$  = Maximum dial setting of  $I_r$ .  
600A L-Frame:  $I_n$  = 600A = Max  $I_r$  setting
- Curves apply from -35°C to +70°C (-31°F to +158°F) ambient temperature.

**MicroLogic 5.3A, 5.3A-W, 5.3E, 5.3E-W, 6.3A, 6.3A-W, 6.3E, and 6.3E-W Electronic Trip Unit Long Time Trip Curve**

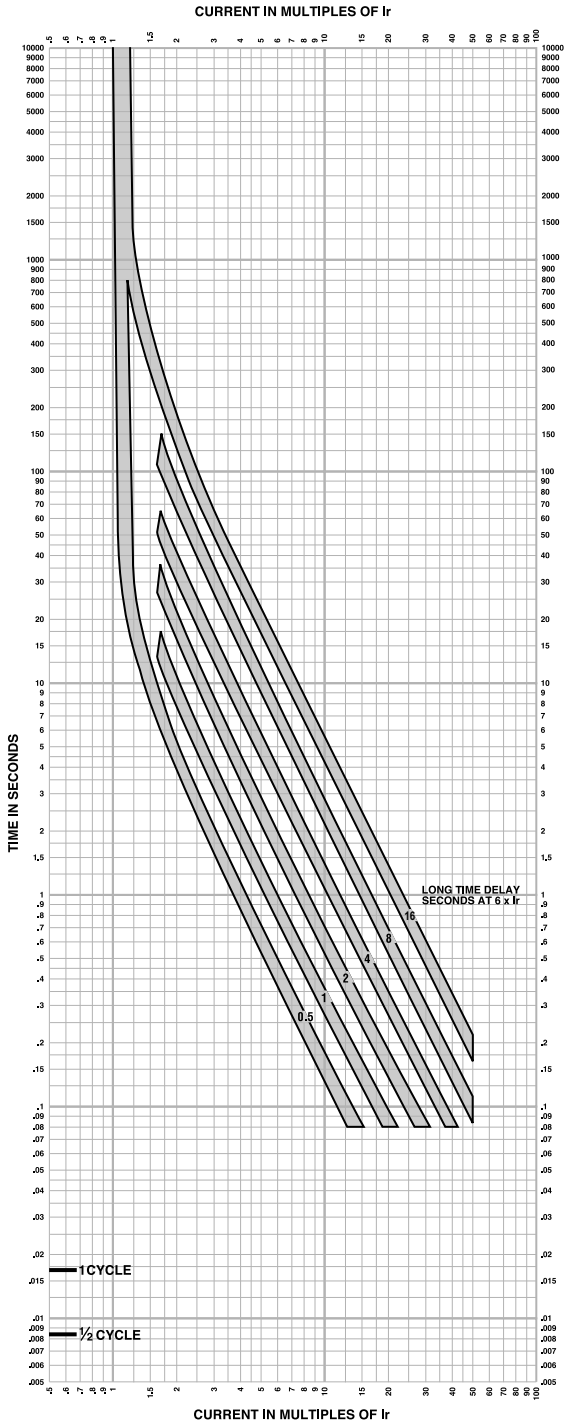

**MICROLOGIC™ ELECTRONIC TRIP UNITS**  
**MicroLogic™ 5.3A, 5.3A-W, 5.3E, 5.3E-W,**  
**6.3A, 6.3A-W, 6.3E, and 6.3E-W**  
**Long Time Trip Curve**  
**600A L-Frame**

The time-current curve information is to be used for application and coordination purposes only.

**Notes:**

1. There is a thermal-imaging effect that can act to shorten the long-time delay. The thermal imaging effect comes into play if a current above the long-time delay pickup value exists for a time and then is cleared by the tripping of a downstream device or the circuit breaker itself. A subsequent overload will cause the circuit breaker to trip in a shorter time than normal. The amount of time delay reduction is inverse to the amount of time that has elapsed since the previous overload. Approximately 20 minutes is required between overloads to completely reset thermal-imaging.
2. Total clearing times shown include the response times of the trip unit, the circuit breaker opening, and the extinction of the current.

Curves apply from -35°C to +70°C (-31°F to +158°F) ambient temperature.

**MicroLogic 5.3A, 5.3A-W, 5.3E, 5.3E-W, 6.3A, 6.3A-W, 6.3E, and 6.3E-W Electronic Trip Unit Short Time Trip Curve**

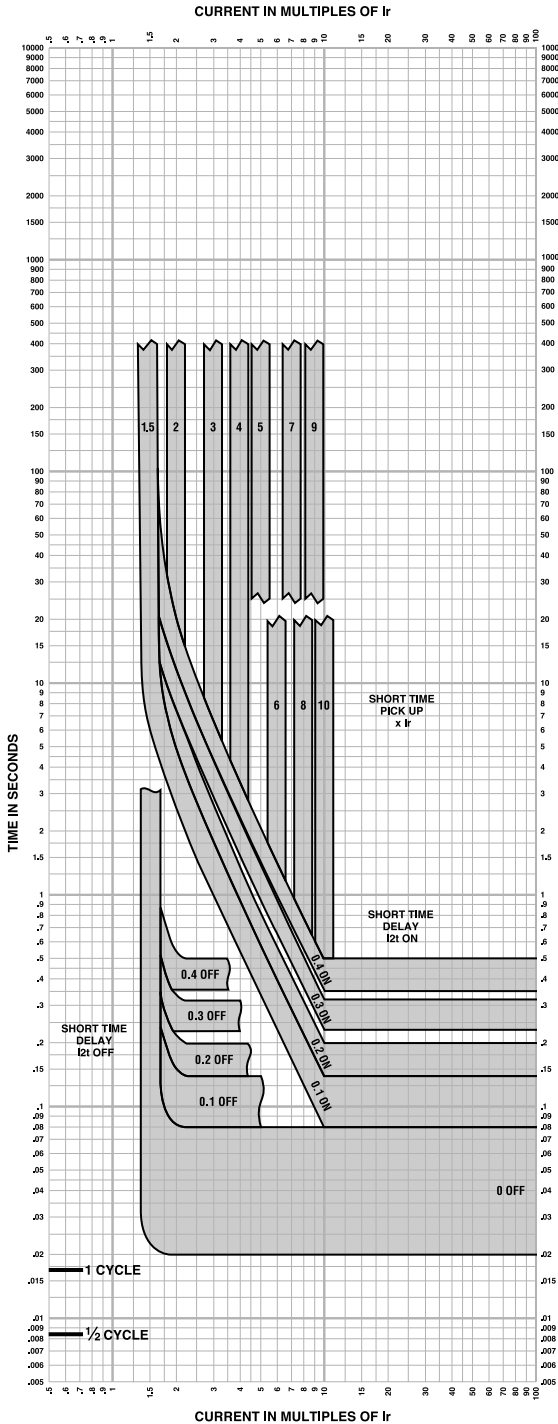

**MICROLOGIC™ ELECTRONIC TRIP UNITS  
MicroLogic™ 5.3A, 5.3A-W, 5.3E, 5.3E-W,  
6.3A, 6.3A-W, 6.3E, and 6.3E-W  
Short Time Trip Curve  
600A L-Frame**

The time-current curve information is to be used for application and coordination purposes only.

**Notes:**

1. There is a thermal-imaging effect that can act to shorten the long-time delay. The thermal imaging effect comes into play if a current above the long-time delay pickup value exists for a time and then is cleared by the tripping of a downstream device or the circuit breaker itself. A subsequent overload will cause the circuit breaker to trip in a shorter time than normal. The amount of time delay reduction is inverse to the amount of time that has elapsed since the previous overload. Approximately 20 minutes is required between overloads to completely reset thermal-imaging.
  2. Total clearing times shown include the response times of the trip unit, the circuit breaker opening, and the extinction of the current.
- Curves apply from -35°C to +70°C (-31°F to +158°F) ambient temperature.

**MicroLogic 6.3A, 6.3A-W, 6.3E, and 6.3E-W Ground-Fault Trip Curve**

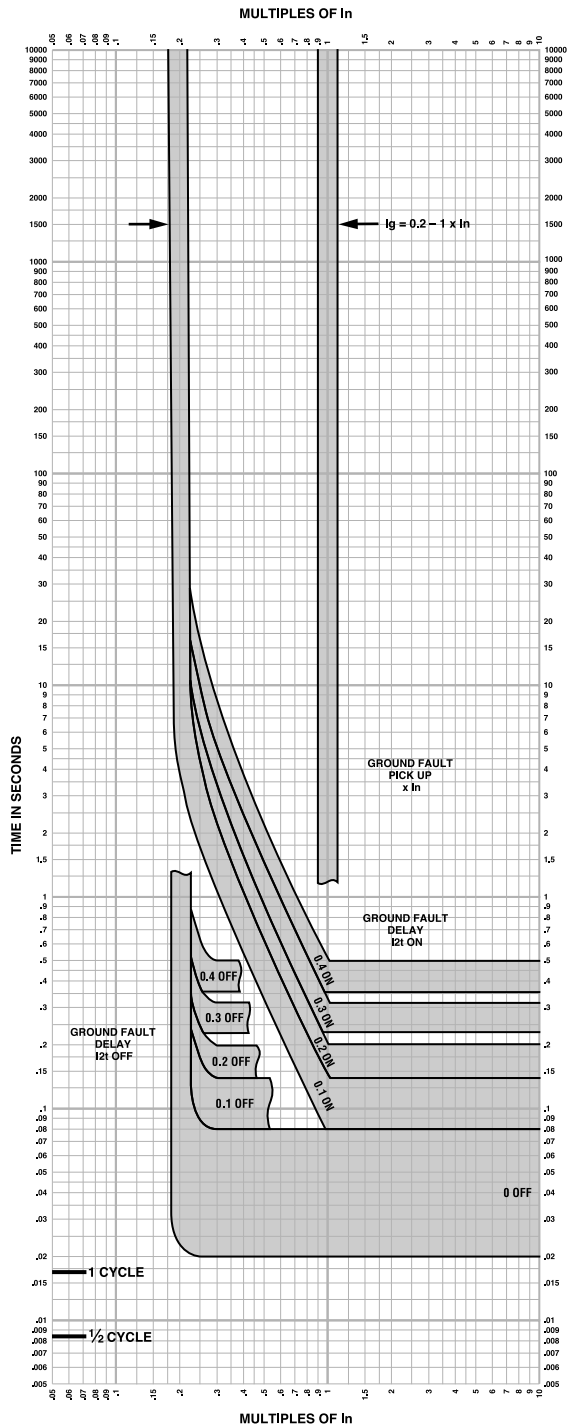

**MICROLOGIC™ ELECTRONIC TRIP UNITS  
MicroLogic™ 6.3A, 6.3A-W, 6.3E, and 6.3E-W  
Ground Fault Trip Curve  
400A, 600A L-Frame**

The time-current curve information is to be used for application and coordination purposes only.

1. Total clearing times shown include the response times of the trip unit, the circuit breaker opening, and the extinction of the current.

Curves apply from -35°C to +70°C (-31°F to +158°F) ambient temperature.



### MicroLogic 1.3 M Electronic Trip Unit Instantaneous Trip Curve

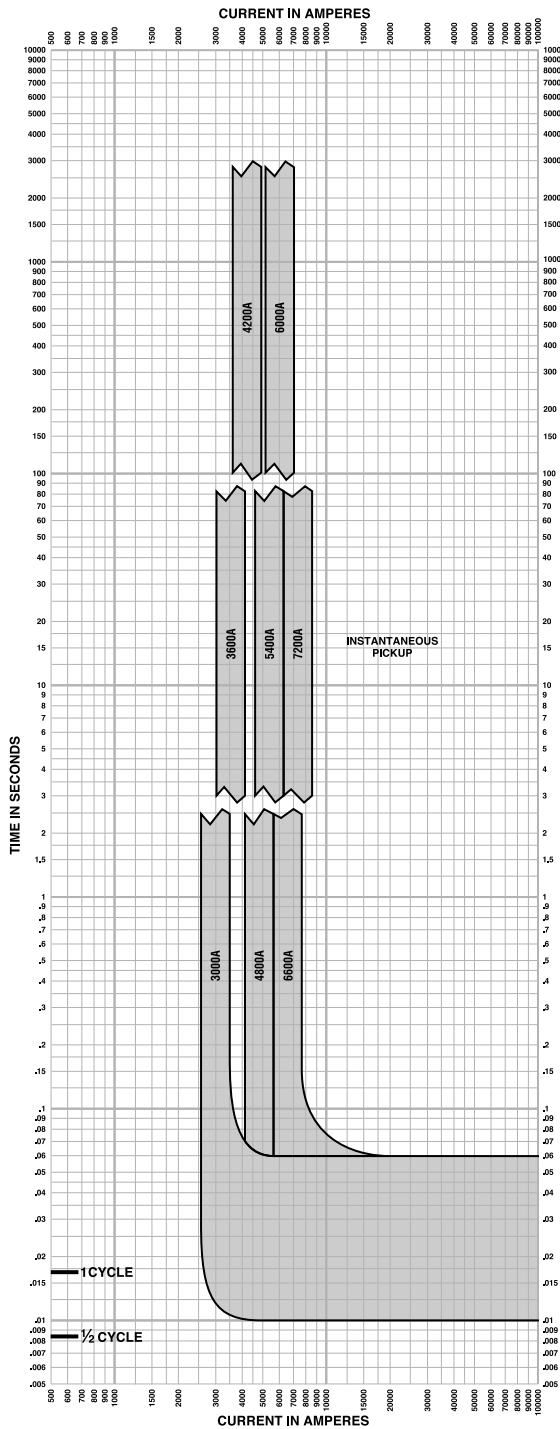

#### MICROLOGIC™ ELECTRONIC TRIP UNITS MicroLogic™ 1.3M Instantaneous Trip Curve 600A L-Frame

The time-current curve information is to be used for application and coordination purposes only.

**Notes:**

1. Total clearing times shown include the response times of the trip unit, the circuit breaker opening, and the extinction of the current.

Curves apply from -35°C to +70°C (-31°F to +158°F) ambient temperature.

**L-Frame 600 A Typical Peak Let-Through Curves**

**ELECTRONIC MOLDED CASE CIRCUIT BREAKERS**  
**POWERPACT™ L-FRAME CURRENT LIMITING CIRCUIT BREAKERS**  
 600 A FRAME AT 240, 480 AND 600 V, 3Ø  
 LD, LG, LJ, LL AND LR 250—600 A  
**PEAK LET-THROUGH CURRENT  $I_p$**

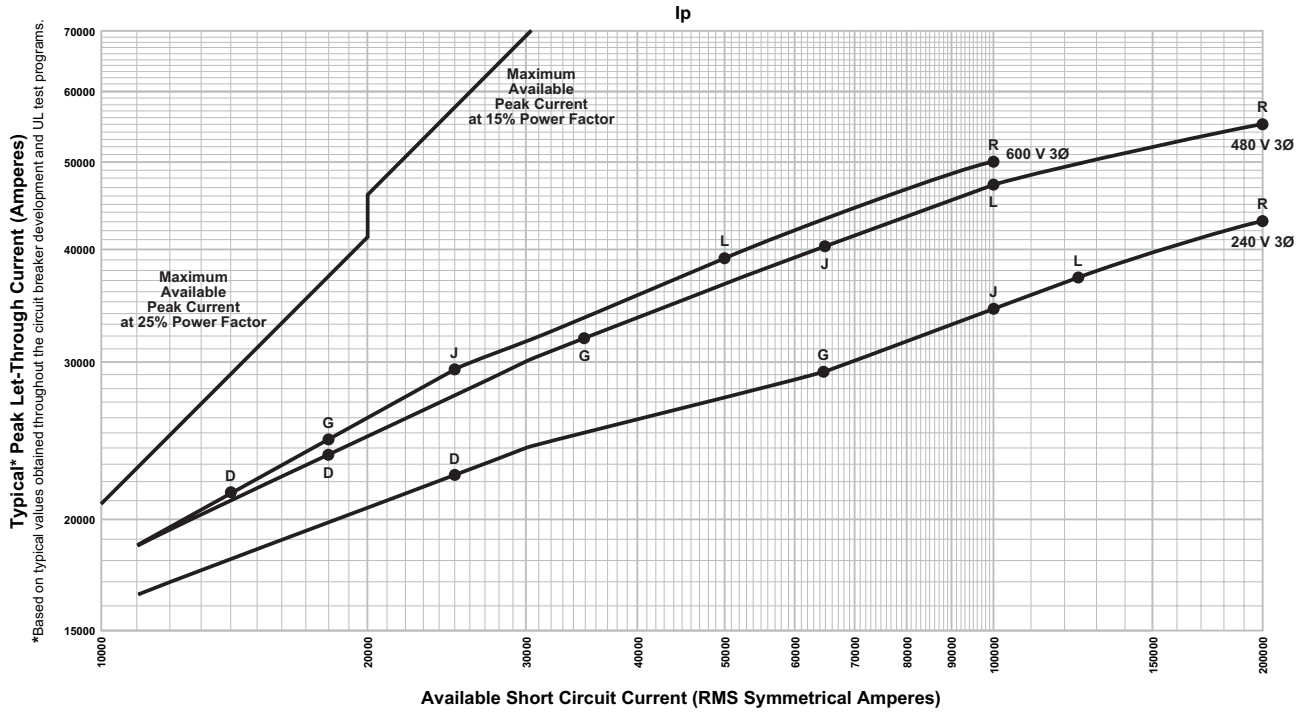

L-Frame 600 A Typical I<sup>2</sup>t Let-Through Curves

ELECTRONIC MOLDED CASE CIRCUIT BREAKERS  
 POWERPACT™ L-FRAME CURRENT LIMITING CIRCUIT BREAKERS  
 600 A FRAME AT 240, 480 AND 600 V, 3Ø  
 LD, LG, LJ, LL AND LR 250—600 A  
 LET-THROUGH I<sup>2</sup>t

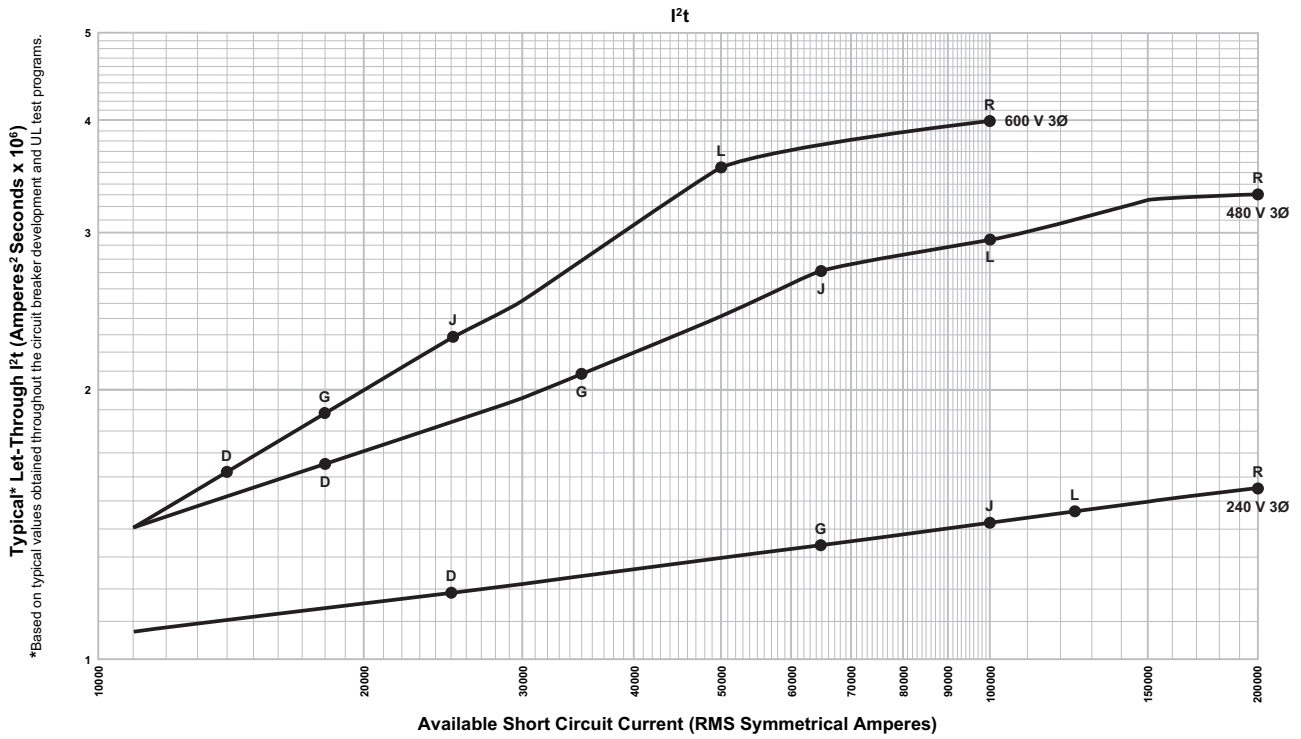

**L-Frame UL Listed Current-Limiting Circuit Breaker**

**ELECTRONIC MOLDED CASE CIRCUIT BREAKERS  
 POWERPACT™ L-FRAME CURRENT LIMITING CIRCUIT BREAKERS  
 600 A FRAME AT 240, 480 AND 600 V, 3Ø  
 LJ, LL AND LR 250—600 A  
 PEAK LET-THROUGH CURRENT  $I_p$**

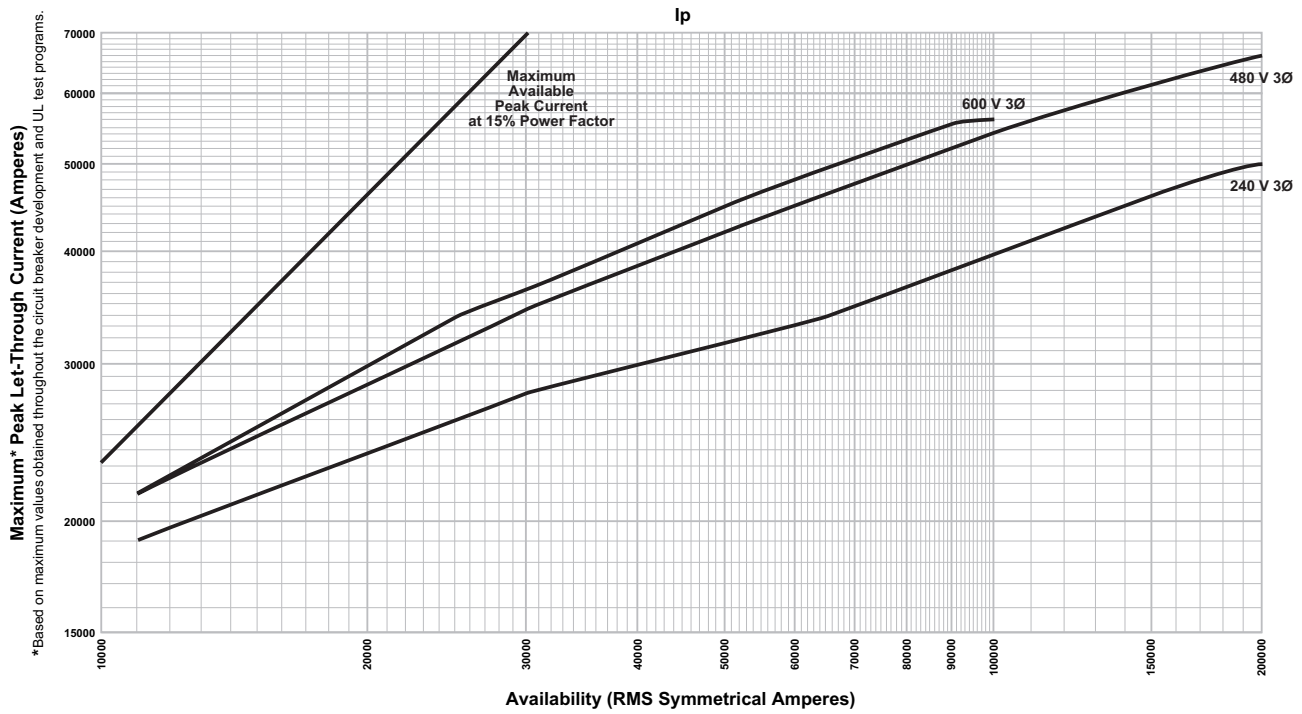

**L-Frame UL Listed Current-Limiting Circuit Breaker**

**ELECTRONIC MOLDED CASE CIRCUIT BREAKERS**  
**POWERPACT™ L-FRAME CURRENT LIMITING CIRCUIT BREAKERS**  
 600 A FRAME AT 240, 480 AND 600 V, 3Ø  
 LJ, LL AND LR 250—600 A  
**LET-THROUGH I<sup>2</sup>t**

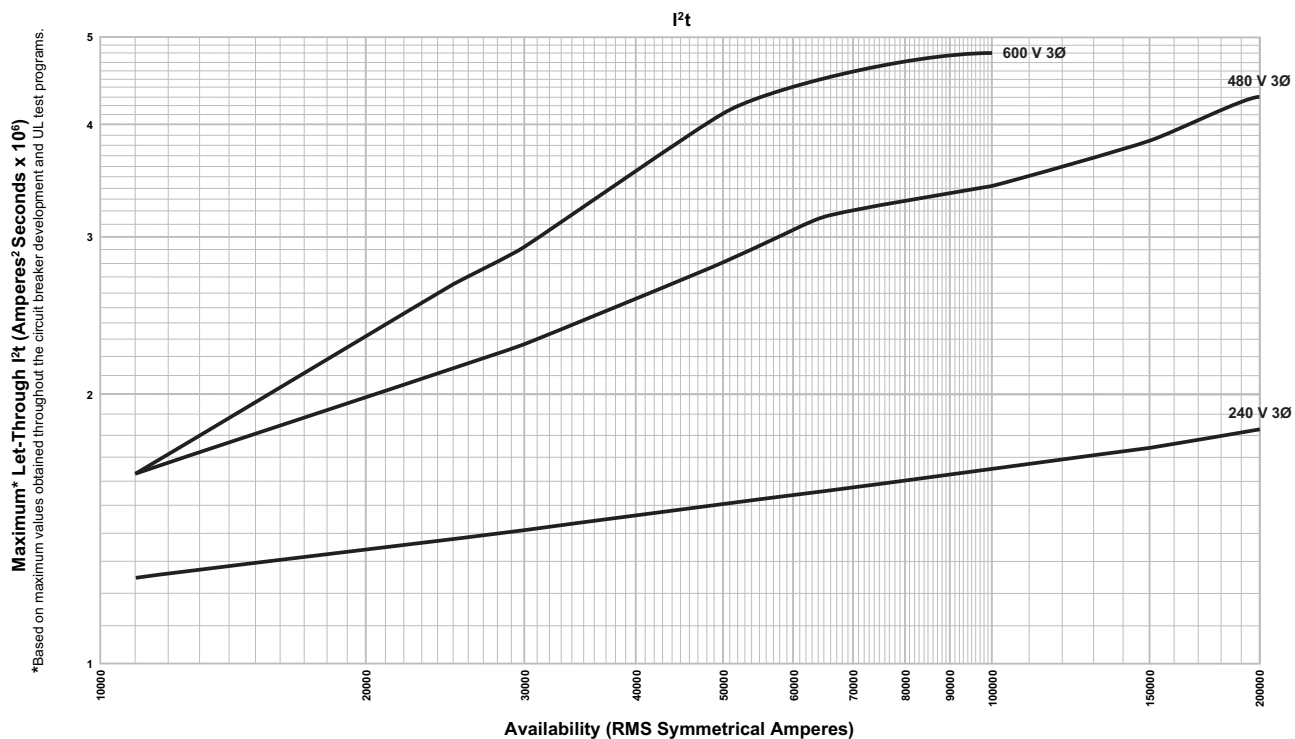

**L-Frame Circuit Breaker Reflex Tripping**

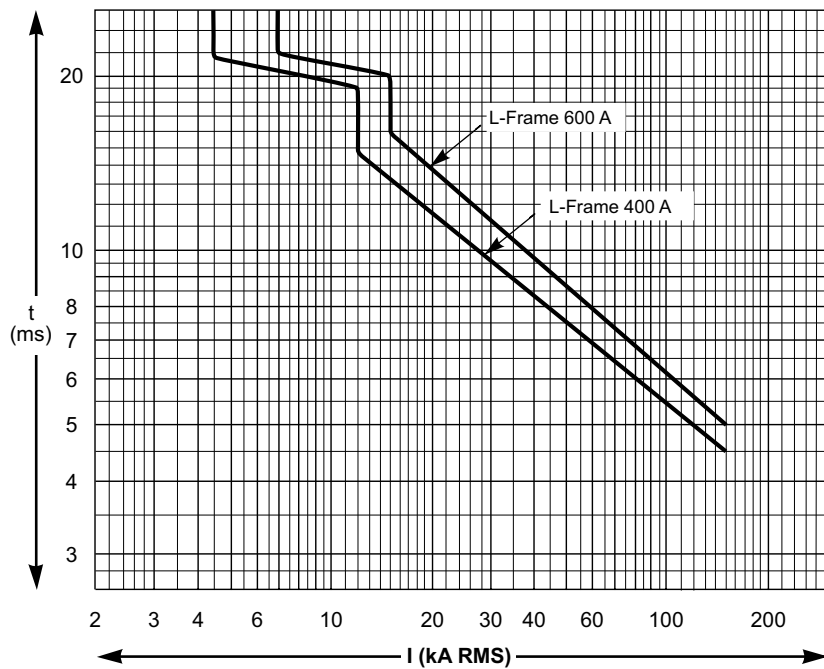

Schneider Electric  
Andover, MA 01810 USA  
800 Federal Street  
USA

888-778-2733

[www.se.com](http://www.se.com)

As standards, specifications, and design change from time to time,  
please ask for confirmation of the information given in this publication.

© 2001 – 2024 Schneider Electric. All rights reserved.

0611CT1001 R09/24