

The essential guide

InstaKits

IEC enclosed starters

Helping you easily
select the right product

2010



General Information

LE Starters Catalogue composition guide

A	B	C	D	E	F	G	H	I	J	K	L		
STARTER FAMILY	TYPE	CONTACTOR SIZE	LINE PROTECTION	PROTECTION SIZE	ENCLOSURE TYPE	WIRING TYPE	LINE/CCT PRIMARY	COIL	FREQ.	OVERLOAD TYPE	OVERLOAD		
LE	1 FVNR	D09 7.5HP @ 600V	3 WITHOUT LINE PROTECTION	A NONE	6 TYPE 1	0 CONTACTOR ONLY NO PROVISION FOR OVERLOAD (2)	O NO CONTROL TRANSFORMER	B 24V	7 50/60HZ	0 NO OVERLOAD	01 0.1 to 0.16A 02 0.16 to 0.25A 03 0.25 to 0.40A 04 0.40 to 0.63A 05 0.63 to 1.0A 06 1.0 to 1.7A 07 1.6 to 2.5A 08 2.5 to 4A 10 4 to 6A 12 5.5 to 8A 14 7 to 10A 16 9 to 13A 21 12 to 18A 22 16 to 24A 25 (D40A-D65A) 17 to 25A 32 23 to 32A 35 30 to 80A 53 23 to 32A 55 30 to 40A 57 37 to 50A 59 48 to 65A 61 55 to 70A 63 63 to 80A 65 80 to 104 67 95 to 120A 69 110 to 140A 71 132 to 220A 75 200 to 330A 79 300 to 500A 81 380 to 630A		
	2 FVR	D12 10HP @ 600V										B FC 30A CB 3A	
	3 RV STAR DELTA	D18 15HP @ 600V											
	F RV STAR DELTA CLOSED TRANSITION	D25 20HP @ 600V	6 FUSED ROTARY HANDLE	C FC 60A CB 7A	7 TYPE 12			1 HARD WIRED NO UNIVERSAL PLUG				X 600V WITH CONTROL TRANSFORMER	G 120V
	8 FVNR 2 SPEED 1 WINDING	D32 25HP @ 600V											
	9 FVNR 2 SPEED 2 WINDINGS	D40 30HP @ 600V											
	P RV PART WINDING	D50 40HP @ 600V	7 WITH MCP GJL 480V max. ROTARY HANDLE	E FC 200A CB 30A	8 TYPE 4	2 INSTAKIT C/W UNIVERSAL PLUG	T 480V WITH CONTROL TRANSFORMER	L 208V					
	T RV AUTO TRANSFORMER	D65 50HP @ 600V							F FC 400A CB 50A				
	S FVNR 1 PH.	D80 60HP @ 600V											
	R FVR 1 PH.	D11 75HP @ 600V	8 FUSED FLANGE HANDLE	G FC 600A CB 100A	9 TYPE 4X (1)	3 WITH EEMAC TYPE 4X ENCLOSURE WATER-TIGHT AND RUST PROOF POLYESTER (1)	M 220/240V WITH CONTROL TRANSFORMER	M 220/240V					
	V FVNR 2S2W CONSTANT HP	D15 100HP @ 600V							H FC 800A CB 150A				
	W FVNR 2S2W CONSTANT HP	F18 125HP @ 600V											
		F26 150HP @ 600V	9 WITH MCP 600V max. FLANGED HANDLE	J FC 1200A CB 250A	P WITH EEMAC TYPE 4X ENCLOSURE WATER-TIGHT AND RUST PROOF POLYESTER (1)	L 208V WITH CONTROL TRANSFORMER	T 480V	G 120V WITH CONTROL TRANSFORMER					
		F33 200HP @ 600V							K FC1600A CB 400A				
		F40 250HP @ 600V											
		F50 400HP @ 600V	L CB 600A	M CB 800A	N CB 1000A	G 120V WITH CONTROL TRANSFORMER	X 600V						
		F63 600HP @ 600V											

Note: FC= fuse clip
CB= MCCB

- To obtain the complete catalogue no., select A letter or digit from each of the columns A through L.
- Example: LE1D098B62OG7112 is a full voltage, non-reversing starter with a fusible disconnect, 30A fuse clips in a type 1 enclosure, with no control transformer, a 120VAC coil

(1) Consult sales office for prices.
(2) Contactor only, reset button not included.

Catalogue numbers.....pages 2 to 11
Dimensions / Wiring diagrams.....pages 18 to 23

Enclosed, 3 Pole
Control Circuit: A.C.

3 Phase, Non Reversing

Maximum Continuous Current per CSA at 600V		Auxiliary Contacts	Catalogue Number (1) Complete the catalogue number by adding the coil voltage code from table below.			
A	NO	NC	NEMA Type 1	Price	NEMA Type 12	Price
20	1	1	LE1D093A60O●	\$292.	LE1D093A70O●	\$420.
25	1	1	LE1D123A60O●	362.	LE1D123A70O●	490.
32	1	1	LE1D183A60O●	406.	LE1D183A70O●	534.
40	1	1	LE1D253A60O●	578.	LE1D253A70O●	818.
50	1	1	LE1D323A60O●	672.	LE1D323A70O●	912.
60	1	1	LE1D403A60O●	764.	LE1D403A70O●	1004.
70	1	1	LE1D503A60O●	808.	LE1D503A70O●	1048.
80	1	1	LE1D653A60O●	1010.	LE1D653A70O●	1250.
125	1	1	LE1D803A60O●	1132.	LE1D803A70O●	1412.
175	2	2	LE1D113A60O●	1920.	LE1F113A70O●	2648.
200	2	2	LE1D153A60O●	2416.	LE1F153A70O●	3428.
200	2	2	LE1F183A60O●	2912.	LE1F183A70O●	4208.
285	2	2	LE1F263A60O●	4512.	LE1F263A70O●	6328.
370	2	2	LE1F333A60O●	8048.	LE1F333A70O●	10716.
420	2	2	LE1F403A60O●	11584.	LE1F403A70O●	15104.
700	2	2	LE1F503A60O●	32512.	LE1F503A70O●	36832.
1000	2	2	LE1F633A60O●	43184.	LE1F633A70O●	47504.
1500	2	2	LE1CPB3A60O●	TBA	LE1CPBA70O●	TBA
2000	2	2	LE1CRB3A60O●	TBA	LE1CRBA70O●	TBA

(1) Coil Voltage Table

Voltage (Volts)	24	120	208	240	480	600
Code	B7	G7	L7	M7	T7	X7

How to Order:

To Order Specify:	Example
<ul style="list-style-type: none"> ● Catalogue Number ● Coil voltage code 	LE1D093A60OG7

Non-Reversing Instakits™ (1)



LE1D●●3A62

Maximum HP							NEMA Type 1		NEMA Type 12		NEMA Type 4		
1 Phase	3 Phase					Assembly	Catalogue		Catalogue		Catalogue		
Hp	Hp	Hp	Hp	Hp	Hp	(2)	(3)	Number (4)	Price	Number (4)	Price	Number (4)	Price
0.3	1	2	2	5	7.5	Factory		LE1D093A62O□	\$552.	LE1D093A72O□	\$632.	LE1D093A81O□	\$1092.
						Customer		LE1D093A62OG70	408.	LE1D093A72OG70	488.	-	-
0.5	2	3	3	7.5	10	Factory		LE1D123A62O□	670.	LE1D123A72O□	750.	LE1D123A81O□	1208.
						Customer		LE1D123A62OG70	526.	LE1D123A72OG70	606.	-	-
1	3	5	5	10	15	Factory		LE1D183A62O□	738.	LE1D183A72O□	818.	LE1D183A81O□	1256.
						Customer		LE1D183A62OG70	578.	LE1D183A72OG70	658.	-	-
2	3	7.5	7.5	15	20	Factory		LE1D253A62O□	794.	LE1D253A72O□	986.	LE1D253A81O□	1304.
						Customer		LE1D253A62OG70	634.	LE1D253A72OG70	826.	-	-
2	5	10	10	20	25	Factory		LE1D323A62O□	1028.	LE1D323A72O□	1220.	LE1D323A81O□	1608.
						Customer		LE1D323A62OG70	800.	LE1D323A72OG70	992.	-	-
3	5	10	10	30	30	Factory		LE1D403A62O□	1192.	LE1D403A72O□	1544.	LE1D403A81O□	1912.
						Customer		LE1D403A62OG70	964.	LE1D403A72OG70	1316.	-	-
3	7.5	15	15	40	40	Factory		LE1D503A62O□	1358.	LE1D503A72O□	1710.	LE1D503A81O□	2520.
						Customer		LE1D503A62OG70	1018.	LE1D503A72OG70	1370.	-	-
5	10	20	20	40	50	Factory		LE1D653A62O□	1558.	LE1D653A72O□	1910.	LE1D653A81O□	3192.
						Customer		LE1D653A62OG70	1218.	LE1D653A72OG70	1570.	-	-
7.5	15	25	30	60	60	Factory		LE1D803A62O□	1710.	LE1D803A72O□	2062.	LE1D803A81O□	3864.
						Customer		LE1D803A62OG70	1370.	LE1D803A72OG70	1722.	-	-
-	-	30	40	75	75	Factory		LE1D113A62O□	2232.	LE1D113A72O□	2648.	LE1D113A81O□	4756.
						Customer		-	-	-	-	-	-
-	-	40	50	100	100	Factory		LE1D153A62O□	2272.	LE1D153A72O□	3428.	LE1D153A81O□	6146.
						Customer		-	-	-	-	-	-
-	-	50	60	125	125	Factory		LE1F183A62O□	3512.	LE1F183A72O□	4208.	LE1F183A81O□	7736.
						Customer		-	-	-	-	-	-
-	-	60	75	150	150	Factory		LE1F263A62O□	4952.	LE1F263A72O□	6328.	LE1F263A81O□	9208.
						Customer		-	-	-	-	-	-
-	-	75	100	200	200	Factory		LE1F333A62O□	8268.	LE1F333A72O□	10716.	LE1F333A81O□	12656.
						Customer		-	-	-	-	-	-
-	-	100	125	250	250	Factory		LE1F403A62O□	11584.	LE1F403A72O□	15104.	LE1F403A81O□	15104.
						Customer		-	-	-	-	-	-
-	-	150	200	400	400	Factory		LE1F503A62O□	32512.	LE1F503A72O□	36832.	LE1F503A81O□	40512.
						Customer		-	-	-	-	-	-
-	-	-	300	600	600	Factory		LE1F633A61O□	43184.	LE1F633A71O□	47504.	LE1F633A81O□	51184.
						Customer		-	-	-	-	-	-

(1) Instakits™ design available in NEMA Type 1 and Type 12 enclosures only.

(2) Factory assembled:

a) Replace (●) with corresponding coil voltage code in the table below.

Voltage (volts)	24V	120V	208V	240V	480V	600V
Code	B7	G7	L7	M7	T7	X7

b) Replace (□) with corresponding O/L relay suffix number listed on page 1. (Price included in starter price.)

(3) Customer Assembled:

a) For coil voltage other than 120 volts, replace suffix letter G7 by corresponding letter on above coil voltage table.

b) Select exact O/L relay part number on page 24 / 25 and add price to starter price.

(4) To obtain a single phase non-reversing starter, change prefix LE1 to LES. (eg. LE1D093A62OG70 becomes LESD093A62OG70). Price remains unchanged. Not applicable to LE1F● devices.

How to Order:

Catalogue numbers	pages 2 to 11
Overload relays	pages 24 to 25
Factory Modifications	pages 12 to 17
Dimensions	pages 18 to 21
Wiring Diagrams	pages 22 to 23

To Order Specify:	Example			
● Catalogue Number	Catalogue Number	Coil Voltage Code	Overload Relay Suffix	Factory Mod's
● Coil Voltage Code	LE1D093A62O	G7	112	
● Overload Relay Suffix				
● Factory Modifications (alphabetical order)				

IEC Full Voltage Combination Starters

Non-Reversing with Fusible Disconnect Instakits™ (1)



LE1D●●8●62

Maximum HP 3 Phase					NEMA Type 1	NEMA Type 12	NEMA Type 4			
208V	230V	460V	575V	Assembly	Catalogue	Catalogue	Catalogue			
Hp	Hp	Hp	Hp	(2) (3)	Number	Price	Number	Price	Number	Price
2	2	5	7.5	Factory	LE1D098B62O●□	\$1328.	LE1D098B72O●□	\$1664.	LE1D098B81O●□	\$2900.
				Customer	LE1D098B62OG70	1184.	LE1D098B72OG70	1520.	-	-
3	3	7.5	10	Factory	LE1D128B62O●□	1446.	LE1D128B72O●□	1782.	LE1D128B81O●□	3096.
				Customer	LE1D128B62OG70	1302.	LE1D128B72OG70	1638.	-	-
5	5	10	15	Factory	LE1D188B62O●□	1514.	LE1D188B72O●□	1850.	LE1D188B81O●□	3136.
				Customer	LE1D188B62OG70	1354.	LE1D188B72OG70	1690.	-	-
7.5	7.5	15	20	Factory	LE1D258C62O●□	1570.	LE1D258C72O●□	1902.	LE1D258C81O●□	3176.
				Customer	LE1D258C62OG70	1410.	LE1D258C72OG70	1746.	-	-
10	10	20	25	Factory	LE1D328C62O●□	1804.	LE1D328C72O●□	2140.	LE1D328C81O●□	3616.
				Customer	LE1D328C62OG70	1576.	LE1D328C72OG70	1912.	-	-
10	10	30	30	Factory	LE1D408C62O●□	2048.	LE1D408C72O●□	2528.	LE1D408C81O●□	4056.
				Customer	LE1D408C62OG70	1820.	LE1D408C72OG70	2300.	-	-
15	15	40	40	Factory	LE1D508D62O●□	2214.	LE1D508D72O●□	2694.	LE1D508D81O●□	4936.
				Customer	LE1D508D62OG70	1874.	LE1D508D72OG70	2354.	-	-
20	20	40	50	Factory	LE1D658D62O●□	2902.	LE1D658D72O●□	3334.	LE1D658D81O●□	6664.
				Customer	LE1D658D62OG70	2562.	LE1D658D72OG70	3042.	-	-
25	30	60	60	Factory	LE1D808E62O●□	3310.	LE1D808E72O●□	3790.	LE1D808E81O●□	8392.
				Customer	LE1D808E62OG70	3210.	LE1D808E72OG70	3690.	-	-
30	40	75	75	Factory	LE1D118E62O●□	4072.	LE1D118E72O●□	4554.	LE1D118E81O●□	9492.
				Customer	-	-	-	-	-	-
40	50	100	100	Factory	LE1D158E62O●□	5012.	LE1D158E72O●□	5893.	LE1D158E81O●□	11326.
				Customer	-	-	-	-	-	-
50	60	125	125	Factory	LE1F188E62O●□	5952.	LE1F188E72O●□	7232.	LE1F188E81O●□	13160.
				Customer	-	-	-	-	-	-
60	75	150	150	Factory	LE1F268F61O●□	7752.	LE1F268F71O●□	8292.	LE1F268F81O●□	16744.
				Customer	-	-	-	-	-	-
75	100	200	200	Factory	LE1F338F61O●□	12124.	LE1F338F71O●□	13544.	LE1F338F81O●□	23908.
				Customer	-	-	-	-	-	-
100	125	250	250	Factory	LE1F408F61O●□	16496.	LE1F408F71O●□	18796.	LE1F408F81O●□	31072.
				Customer	-	-	-	-	-	-
150	200	300	400	Factory	LE1F508G61O●□	46712.	LE1F508G71O●□	52232.	LE1F508G81O●□	597576.
				Customer	-	-	-	-	-	-

(1) Instakits™ design offered in NEMA Type 1 and Type 12 enclosures.

(2) Factory assembled:

a) Replace (l) with corresponding coil voltage code in the table below.

Voltage (volts)	24V	120V	208V	240V	480V	600V
Code	B7	G7	L7	M7	T7	X7

b) Replace (q) with corresponding O/L relay suffix number listed on page 1 (Price included in starter price.)

(3) Customer Assembled:

- a) For coil voltage other than 120 volts, replace suffix letter G7 by corresponding letter on above coil voltage table.
- b) Select exact O/L relay part number on pages 24 / 25 and add price to starter price.

(4) For fuse clips different from the ones proposed on this page specify your requirement using the catalogue composition guide page 1

Catalogue numbers pages 2 to 11
 Overload relays pages 24 to 25
 Factory Modifications pages 12 to 17
 Dimensions pages 18 to 21
 Wiring Diagrams pages 22 to 23

How to Order:

To Order Specify:	Example			
● Catalogue Number	Catalogue Number	Coil Voltage Code	Overload Relay Suffix	Factory Mod's
● Coil Voltage Code	LE1D098B62O	G7	112	□
● Overload Relay Suffix				
● Factory Modifications (alphabetical order)				

Non-Reversing with Instantaneous Trip Circuit Interrupter Instakits™ (1)



LE1D●●9●62

Maximum HP				NEMA Type 1		NEMA Type 12		NEMA Type 4		
3 Phase				Catalogue		Catalogue		Catalogue		
208V	230V	460V	575V	Number	Price	Number	Price	Number	Price	
2	2	5	7.5	Factory	LE1D099E620□	\$1904.	LE1D099E720□	\$2288.	LE1D099E810□	\$3560.
				Customer	LE1D099E62OG70	1760.	LE1D099E72OG70	2144.	-	-
3	3	7.5	10	Factory	LE1D129E620●	2022.	LE1D129E720●	2406.	LE1D129E810●	3640.
				Customer	LE1D129E62OG70	1878.	LE1D129D72OG70	2262.	-	-
5	5	10	15	Factory	LE1D189E620●	2090.	LE1D189E720●	2474.	LE1D189E810●	3680.
				Customer	LE1D189E62OG70	1930.	LE1D189E72OG70	2314.	-	-
7.5	7.5	15	20	Factory	LE1D259E620●	2146.	LE1D259E720●	2530.	LE1D259E810●	3720.
				Customer	LE1D259E62OG70	1986.	LE1D259E72OG70	2370.	-	-
10	10	20	25	Factory	LE1D329F620□	2380.	LE1D329F720□	2764.	LE1D329F810□	4032.
				Customer	LE1D329F62OG70	2152.	LE1D329F72OG70	2536.	-	-
10	10	30	30	Factory	LE1D409F620●	2816.	LE1D409F720●	3136.	LE1D409F810●	4344.
				Customer	LE1D409F62OG70	2588.	LE1D409F72OG70	2908.	-	-
15	15	40	40	Factory	LE1D509G620●	2982.	LE1D509G720●	3302.	LE1D509G810●	4968.
				Customer	LE1D509G62OG70	2642.	LE1D509G72OG70	2962.	-	-
20	20	40	50	Factory	LE1D659G620●	3542.	LE1D659G720●	4318.	LE1D659G810●	6760.
				Customer	LE1D659G62OG70	3202.	LE1D659G72OG70	3978.	-	-
25	30	60	60	Factory	LE1D809G620●	3694.	LE1D809G720●	4470.	LE1D809G810●	8552.
				Customer	LE1D809G62OG70	3354.	LE1D809G72OG70	4130.	-	-
30	40	75	75	Factory	LE1D119H620□	4424.	LE1D119H720□	4904.	LE1D119J820□	10020.
				Customer	-	-	-	-	-	-
40	50	100	-	Factory	LE1D159J620●	6292.	LE1D159J720●	6932.	LE1D159J810●	12462.
		100		Factory	LE1D159H620□	6292.	LE1D159H720□	6932.	LE1D159H810□	12462.
50	60	125	125	Factory	LE1F189J620●	8160.	LE1F189J720●	8960.	LE1F189J810●	14904.
				Customer	-	-	-	-	-	-
60	75	150	150	Factory	LE1F269J620●	9600.	LE1F269J720●	10880.	LE1F269J810●	19068.
				Customer	-	-	-	-	-	-
75	100	200	200	Factory	LE1F339K620●	15912.	LE1F339K720●	17832.	LE1F339K810●	27382.
				Customer	-	-	-	-	-	-
100	125	250	250	Factory	LE1F409K620●	22224.	LE1F409K720●	24784.	LE1F409K810●	35696.
				Customer	-	-	-	-	-	-
150	200	400	400	Factory	LE1F509L610●	47752.	LE1F509L710●	52072.	LE1F509L810●	55752.
				Customer	-	-	-	-	-	-
-	300	600	600	Factory	LE1F639M610●	64592.	LE1F639M710●	68912.	LE1F639M810●	72592.
				Customer	-	-	-	-	-	-

(1) Instakits™ design available in NEMA Type 1 and Type 12 enclosures only.

(2) Factory assembled:

a) Replace (●) with corresponding coil voltage code in the table below.

Voltage (volts)	24V	120V	208V	240V	480V	600V
Code	B7	G7	L7	P7	T7	X7

b) Replace (□) with corresponding O/L relay suffix number listed on page 1 (Price included in starter price.)

(3) Customer Assembled:

a) For coil voltage other than 120 volts, replace suffix letter G7 by corresponding letter on above coil voltage table.

b) Select exact O/L relay part number on page 24 / 25 and add price to starter price.

(4) For breaker, frame/trip different from the ones proposed on this page specify your requirement using the catalogue composition guide page 1.

How to Order:

To Order Specify:	Example			
● Catalogue Number	Catalogue Number	Coil Voltage Code	Overload Relay Suffix	Factory Mod's
● Coil Voltage Code				
● Overload Relay Suffix				
● Factory Modifications (alphabetical order)				
	LE1D099D620	G7	112	

Catalogue numbers	pages 2 to 11
Overload relays	pages 24 to 25
Factory Modifications	pages 12 to 17
Dimensions	pages 18 to 21
Wiring Diagrams	pages 22 to 23

Instakits™ (1)



LE2D●●3●A62

Maximum HP							NEMA	NEMA	NEMA	
1 Phase		3 Phase					Type 1	Type 12	Type 4	
120V	240V	208V	230V	460V	575V	Assembly	Catalogue	Catalogue	Catalogue	
Hp	Hp	Hp	Hp	Hp	Hp	(2) (3)	Number (4)	Number (4)	Number (4)	
							Price	Price	Price	
0.3	1	2	2	5	7.5	Factory	LE2D093A62O●□ \$1168.	LE2D093A72O●□ \$1296.	LE2D093A81O●□ \$1880.	
							Customer	LE2D093A62OG70 1024.	LE2D093A72OG70 1152.	-
0.5	2	3	3	7.5	10	Factory	LE2D123A62O●□ 1342.	LE2D123A72O●□ 1470.	LE2D123A81O●□ 2104.	
							Customer	LE2D123A62OG70 1198.	LE2D123A72OG70 1326.	-
1	3	5	5	10	15	Factory	LE2D183A62O●□ 1466.	LE2D183A72O●□ 1594.	LE2D183A81O●□ 2344.	
							Customer	LE2D183A62OG70 1306.	LE2D183A72OG70 1434.	-
2	3	7.5	7.5	15	20	Factory	LE2D253A62O●□ 1574.	LE2D253A72O●□ 1862.	LE2D253A81O●□ 2584.	
							Customer	LE2D253A62OG70 1414.	LE2D253A72OG70 1702.	-
2	5	10	10	20	25	Factory	LE2D323A62O●□ 1934.	LE2D323A72O●□ 2222.	LE2D323A81O●□ 3096.	
							Customer	LE2D323A62OG70 1706.	LE2D323A72OG70 1994.	-
3	5	10	10	30	30	Factory	LE2D403A62O●□ 2378.	LE2D403A72O●□ 2858.	LE2D403A81O●□ 3608.	
							Customer	LE2D403A62OG70 2150.	LE2D403A72OG70 2630.	-
3	7.5	15	15	40	40	Factory	LE2D503A62O●□ 2598.	LE2D503A72O●□ 3078.	LE2D503A81O●□ 4632.	
							Customer	LE2D503A62OG70 2258.	LE2D503A72OG70 2738.	-
5	10	20	20	40	50	Factory	LE2D653A62O●□ 3344.	LE2D653A72O●□ 3824.	LE2D653A81O●□ 6000.	
							Customer	LE2D653A62OG70 3004.	LE2D653A72OG70 3484.	-
7.5	15	25	30	60	60	Factory	LE2D80A62GO●□ 3954.	LE2D80A72GO●□ 4722.	LE2D80A81O●□ 7676.	
							Customer	-	-	-
-	-	30	40	75	75	Factory	LE2D113A62O●□ 4904.	LE2D113A72O●□ 5960.	LE2D113A82O●□ 9352.	
							Customer	-	-	-
-	-	40	50	100	100	Factory	LE2D153A62O●□ 6264.	LE2D153A72O●□ 7592.	LE2D153A81O●□ 12656.	
							Customer	-	-	-
-	-	50	60	125	125	Factory	LE2F183A62O●□ 7624.	LE2F183A72O●□ 9224.	LE2F183A81O●□ 15960.	
							Customer	-	-	-
-	-	60	75	150	150	Factory	LE2F263A62O●□ 11600.	LE2F263A72O●□ 13240.	LE2F263A81O●□ 18988.	
							Customer	-	-	-
-	-	75	100	200	200	Factory	LE2F333A61O●□ 18528.	LE2F333A71O●□ 21108.	LE2F333A81O●□ 25038.	
							Customer	-	-	-
-	-	100	125	250	250	Factory	LE2F403A61O●□ 25456.	LE2F403A71O●□ 28976.	LE2F403A81O●□ 31088.	
							Customer	-	-	-
-	-	150	200	400	400	Factory	LE2F503A61O●□ 55756.	LE2F503A71O●□ 60076.	LE2F503A81O●□ 64608.	
							Customer	-	-	-
-	-	-	300	600	600	Factory	LE2F633A61O●□ 75980.	LE2F633A71O●□ 80300.	LE2F633A81O●□ 84880.	
							Customer	-	-	-

- (1) Instakits™ design available in NEMA Type 1 and Type 12 enclosures only.
- (2) Factory assembled:
- Replace (●) with corresponding coil voltage code in the table below.

Voltage (volts)	24V	120V	208V	240V	480V	600V
Code	B7	G7	L7	M7	T7	X7
 - Replace (□) with corresponding O/L relay suffix number listed on page 1 (Price included in starter price.)
- (3) Customer Assembled:
- For coil voltage other than 120 volts, replace suffix letter G7 by corresponding letter on above coil voltage table.
 - Select exact O/L relay part number on page 24 / 25 and add price to starter price.
- (4) To obtain a single phase reversing starter, change prefix LE2 to LER. (eg. LE2D093A62OG70 becomes LERD093A62OG70).
- For use on single phase application, connect a power cable between terminals T3 on O/L relay and L2 on contactor.

How to Order:

Catalogue numbers pages 2 to 11
 Overload relays pages 24 to 25
 Factory Modifications pages 12 to 17
 Dimensions pages 18 to 21
 Wiring Diagrams pages 22 to 23

To Order Specify:	Example			
	Catalogue Number	Coil Voltage Code	Overload Relay Suffix	Factory Mod's
<ul style="list-style-type: none"> ● Catalogue Number ● Coil Voltage Code ● Overload Relay Suffix ● Factory Modifications (alphabetical order) 	LE2D093A62O	G7	112	

IEC Full Voltage Reversing Combination Starters

With Fusible Disconnect
Instakits™ (1)



LE2D●●9●62

Maximum HP 3 Phase					NEMA Type 1	NEMA Type 12	NEMA Type 4			
208V	230V	460V	575V	Assembly	Catalogue	Catalogue	Catalogue			
Hp	Hp	Hp	Hp	(2) (3)	Number	Price	Number	Price	Number	Price
2	2	5	7.5	Factory	LE2D098B620●□	\$1944.	LE2D098B720●□	\$2280.	LE2D098B810●□	\$3548.
				Customer	LE2D098B620G70	1800.	LE2D098B720G70	2136.	-	-
3	3	7.5	10	Factory	LE2D128B620●□	2118.	LE2D128B720●□	2454.	LE2D128B810●□	4408.
				Customer	LE2D128B620G70	1974.	LE2D128B720G70	2310.	-	-
5	5	10	15	Factory	LE2D188B620●□	2242.	LE2D188B720●□	2578.	LE2D188B810●□	4488.
				Customer	LE2D188B620G70	2082.	LE2D188B720G70	2418.	-	-
7.5	7.5	15	20	Factory	LE2D258C620●□	2350.	LE2D258C720●□	2686.	LE2D258C810●□	4568.
				Customer	LE2D258C620G70	2190.	LE2D258C720G70	2526.	-	-
10	10	20	25	Factory	LE2D328C620●□	2710.	LE2D328C720●□	3046.	LE2D328C810●□	5256.
				Customer	LE2D328C620G70	2482.	LE2D328C720G70	2818.	-	-
10	10	30	30	Factory	LE2D408C620●□	3234.	LE2D408C720●□	3714.	LE2D408C810●□	5944.
				Customer	LE2D408C620G70	3006.	LE2D408C720G70	3486.	-	-
15	15	40	40	Factory	LE2D508D620●□	3454.	LE2D508D720●□	3934.	LE2D508D810●□	7320.
				Customer	LE2D508D620G70	3114.	LE2D508D720G70	3594.	-	-
20	20	40	50	Factory	LE2D658D620●□	4688.	LE2D658D720●□	5168.	LE2D658D810●□	9872.
				Customer	LE2D658D620G70	4348.	LE2D658D720G70	4828.	-	-
25	30	60	65	Factory	LE2D808E620●□	4516.	LE2D808E720●□	7818.	LE2D808E810●□	12190.
				Customer	-	-	-	-	-	-
30	40	75	75	Factory	LE2D118E620●□	4684.	LE2D118E720●□	10808.	LE2D118E810●□	14508.
				Customer	-	-	-	-	-	-
40	50	100	100	Factory	LE2D158E620●□	9618.	LE2D158E720●□	13800.	LE1D158E810●□	17978.
				Customer	-	-	-	-	-	-
50	60	125	125	Factory	LE2F188E620●□	14552.	LE2F188E720●□	16792.	LE2F188E810●□	21448.
				Customer	-	-	-	-	-	-
60	75	150	150	Factory	LE2F268F610●□	18768.	LE2F268F710●□	21048.	LE2F268F810●□	26312.
				Customer	-	-	-	-	-	-
75	100	200	200	Factory	LE2F338F610●□	30080.	LE2F338F710●□	33652.	LE2F338F810●□	37712.
				Customer	-	-	-	-	-	-
100	125	250	250	Factory	LE2F408F610●□	41392.	LE2F408F710●□	46256.	LE2F408F810●□	49112.
				Customer	-	-	-	-	-	-
125	150	300	400	Factory	LE2F508G610●□	72076.	LE2F508G710●□	77596.	LE2F508G810●□	79512.
				Customer	-	-	-	-	-	-

(1) *Instakits™* design available in NEMA Type 1 and Type 12 enclosures only.

(2) Factory assembled:

a) Replace (●) with corresponding coil voltage code in the table below.

Voltage (volts)	24V	120V	208V	240V	480V	600V
Code	B7	G7	L7	M7	T7	X7

b) Replace (□) with corresponding O/L relay suffix number listed on pages 1 (Price included in starter price.)

(3) Customer Assembled:

- a) For coil voltage other than 120 volts, replace suffix letter G7 by corresponding letter on above coil voltage table.
- b) Select exact O/L relay part number on pages 24 / 25 and add price to starter price.

(4) For fuse clips different from the ones proposed on this page specify your requirement using the catalogue composition guide page 1.

How to Order:

To Order Specify:	Example			
● Catalogue Number	Catalogue Number	Coil Voltage Code	Overload Relay Suffix	Factory Mod's
● Coil Voltage Code	LE2D098B620	G7	112	
● Overload Relay Suffix				
● Fuse Clip Suffix				
● Factory Modifications (alphabetical order)				

Catalogue numbers pages 2 to 11
 Overload relays pages 24 to 25
 Factory Modifications pages 12 to 17
 Dimensions pages 18 to 21
 Wiring Diagrams pages 22 to 23

With Instantaneous Trip Circuit Interrupter Instakits™ (1)



LE2D●●9●62

Maximum HP 3 Phase					NEMA Type 1	NEMA Type 12	NEMA Type 4			
208V	230V	460V	575V	Assembly	Catalogue	Catalogue	Catalogue			
Hp	Hp	Hp	Hp	(2) (3)	Number	Price	Number	Price	Number	Price
2	2	5	7.5	Factory	LE2D099E62O●□	\$2520.	LE2D099E72O●□	\$2904.	LE2D099E81O●□	\$4300.
				Customer	LE2D099E62OG70	2376.	LE2D099E72OG70	2760.	-	-
3	3	7.5	10	Factory	LE2D129E62O●□	2694.	LE2D129E72O●□	3078.	LE2D129E81O●□	4888.
				Customer	LE2D129E62OG70	2550.	LE2D129E72OG70	2934.	-	-
5	5	10	15	Factory	LE2D189E62O●□	2818.	LE2D189E72O●□	3202.	LE2D189E81O●□	4984.
				Customer	LE2D189E62OG70	2658.	LE2D189E72OG70	3042.	-	-
7.5	7.5	15	20	Factory	LE2D259E62O●□	2926.	LE2D259E72O●□	3310.	LE2D259E81O●□	5080.
				Customer	LE2D259E62OG70	2766.	LE2D259E72OG70	3150.	-	-
10	10	20	25	Factory	LE2D329F62O●□	3286.	LE2D329F72O●□	3670.	LE2D329F81O●□	5792.
				Customer	LE2D329F62OG70	3058.	LE2D329F72OG70	3442.	-	-
10	10	30	30	Factory	LE2D409F62O●□	4002.	LE2D409F72O●□	4322.	LE2D409F81O●□	6504.
				Customer	LE2D409F62OG70	3774.	LE2D409F72OG70	4094.	-	-
15	15	40	40	Factory	LE2D509G62O●□	4222.	LE2D509G72O●□	4542.	LE2D509G81O●□	7928.
				Customer	LE2D509G62OG70	3882.	LE2D509G72OG70	4202.	-	-
20	20	40	50	Factory	LE2D659G62O●□	5328.	LE2D659G72O●□	6104.	LE2D659G81O●□	10260.
				Customer	LE2D659G62OG70	4988.	LE2D659G72OG70	5764.	-	-
25	30	60	60	Factory	LE2D809G62O●□	7682.	LE2D809G72O●□	8982.	LE2D809G81GO●□	12650.
				Customer	-	-	-	-	-	-
30	40	75	75	Factory	LE2D119H62O●□	10376.	LE2D119H71O●□	12200.	LE2D119H81O●□	15040.
				Customer	-	-	-	-	-	-
40	50	100	-	Factory	LE2D159J62O●□	14320.	LE2D159J72O●□	16352.	LE2D159J81O●□	19116.
		100		Customer	-	-	-	-	-	-
				Factory	LE2D159H62O●□I	14320.	LE2D159H72O●□I	16352.	LE2D159H81O●□I	19116.
50	60	125	125	Factory	LE2F189J62O●□	18264.	LE2F189J72O●□	20504.	LE2F189J81O●□	23192.
				Customer	-	-	-	-	-	-
60	75	150	150	Factory	LE2F269J62O●□	22240.	LE2F269J72O●□	24520.	LE2F269J81O●□	28632.
				Customer	-	-	-	-	-	-
75	100	200	200	Factory	LE2F339K61O●□	31680.	LE2F339K71O●□	35180.	LE2F339K81O●□	39508.
				Customer	-	-	-	-	-	-
100	125	250	250	Factory	LE2F409K61O●□	41120.	LE2F409K71O●□	45840.	LE2F409K81O●□	50384.
				Customer	-	-	-	-	-	-
150	200	400	400	Factory	LE2F509L61O●□	71420.	LE2F509L71O●□	76940.	LE2F509L81O●□	80272.
				Customer	-	-	-	-	-	-
-	300	600	600	Factory	LE2F639M61O●□	97692.	LE2F509M71O●□	103212.	LE2F509M81O●□	106544.
				Customer	-	-	-	-	-	-

(1) Instakits™ design offered in NEMA Type 1 and Type 12 enclosures.

(2) Factory assembled:

a) Replace (●) with corresponding coil voltage code in the table below.

Voltage (volts)	24V	120V	208V	240V	480V	600V
Code	B7	G7	L7	M7	T7	X7

b) Replace (□) with corresponding O/L relay suffix number listed on page 1 (Price included in starter price.)

(3) Customer Assembled:

a) For coil voltage other than 120 volts, replace suffix letter G7 by corresponding letter on above coil voltage table.

b) Select exact O/L relay part number on pages 24 / 25 and add price to starter price.

(4) For breaker, frame/trip different from the ones proposed on this page specify your requirement using the catalogue composition guide page 1.

How to Order:

To Order Specify:	Example			
● Catalogue Number	Catalogue Number	Coil Voltage Code	Overload Relay Suffix	Factory Mod's
● Coil Voltage Code	LE1D099D62O	G7	112	
● Overload Relay Suffix				
● Factory Modifications (alphabetical order)				

Catalogue numbers	pages 2 to 11
Overload relays	pages 24 to 25
Factory Modifications	pages 12 to 17
Dimensions	pages 18 to 21
Wiring Diagrams	pages 22 to 23

IEC Full Voltage Magnetic Starters

Consequent Pole Separate Winding Instakits™ (1)

Type of motor	Max HP 3 phase				Instantaneous contacts per contactor	NEMA Type 1		NEMA Type 12		NEMA Type 4	
	208V	230V	460V	575V		Catalogue Number	Price ⁽¹⁾	Catalogue Number	Price ⁽¹⁾	Catalogue Number	Price ⁽¹⁾
2 Speed 1 Winding - Consequent Pole											
Constant or Variable Torque	3	3	7.5	7.5	1 NO + 1 NC	LE8D123A62O	\$2368.	LE8D123A72O	\$2816.	LE8D123A81O	\$4150.
	7.5	7.5	15	15	1 NO + 1 NC	LE8D253A62O	2592.	LE8D253A72O	3088.	LE8D253A81O	4374.
	10	10	30	30	1 NO + 1 NC	LE8D503A62O	4432.	LE8D503A72O	5136.	LE8D503A81O	8328.
	20	20	40	50	1 NO + 1 NC	LE8D653A62O	6560.	LE8D653A72O	7760.	LE8D653A81O	10040.
	30	40	75	75	2 NO + 2 NC	LE8D113A62O	7360.	LE8D113A72O	8960.	LE8D113A81O	11952.
	50	60	125	125	2 NO + 2 NC	LE8F183A61O	18192.	LE8F183A71O	19792.	LE8F183A81O	23076.
	60	75	150	150	2 NO + 2 NC	LE8F263A61O	19616.	LE8F263A71O	22784.	LE8F263A81O	25492.
	100	125	250	250	2 NO + 2 NC	LE8F403A61O	38656.	LE8F403A71O	51824.	LE8F403A81O	57824.
Constant HP	1.5	1.5	3	3	1 NO + 1 NC	LEVD123A61O	2368.	LEVD123A71O	2816.	LEVD123A81O	4150.
	5	5	10	10	1 NO + 1 NC	LEVD253A61O	2592.	LEVD253A71O	3088.	LEVD253A81O	4374.
	10	10	20	20	1 NO + 1 NC	LEVD503A61O	4432.	LEVD503A71O	5136.	LEVD503A81O	8328.
	15	15	40	40	1 NO + 1 NC	LEVD653A61O	6560.	LEVD653A71O	7760.	LEVD653A81O	10040.
	20	30	60	60	2 NO + 2 NC	LEVD113A61O	7360.	LEVD113A71O	8960.	LEVD113A81O	11952.
	40	50	100	100	2 NO + 2 NC	LEVF183A61O	18192.	LEVF183A71O	19792.	LEVF183A81O	23076.
	50	60	125	125	2 NO + 2 NC	LEVF263A61O	19616.	LEVF263A71O	22784.	LEVF263A81O	25492.
	75	100	200	200	2 NO + 2 NC	LEVF403A61O	38656.	LEVF403A71O	51824.	LEVF403A81O	57824.
2 Speed 2 Winding - Separate Winding											
Constant or Variable Torque	3	3	7.5	7.5	1 NO + 1 NC	LE9D123A62O	\$1728.	LE9D123A72O	\$2176.	LE9D123A81O	\$3510.
	7.5	7.5	15	15	1 NO + 1 NC	LE9D253A62O	2128.	LE9D253A72O	2624.	LE9D253A81O	3910.
	10	10	30	30	1 NO + 1 NC	LE9D503A62O	3552.	LE9D503A72O	4272.	LE9D503A81O	7448.
	20	20	40	50	1 NO + 1 NC	LE9D653A62O	4896.	LE9D653A72O	6032.	LE9D653A81O	8376.
	30	40	75	75	2 NO + 2 NC	LE9D113A62O	5632.	LE9D113A72O	7232.	LE9D113A81O	9132.
	50	60	125	125	2 NO + 2 NC	LE9F183A61O	12848.	LE9F183A71O	14448.	LE9F183A81O	17440.
	60	75	150	150	2 NO + 2 NC	LE9F263A61O	13792.	LE9F263A71O	16960.	LE9F263A81O	21792.
	100	125	250	250	2 NO + 2 NC	LE9F403A61O	32400.	LE9F403A71O	45568.	LE9F403A81O	52400.
Constant HP	1.5	1.5	3	3	1 NO + 1 NC	LEWD123A61O	1728.	LEWD123A71O	2176.	LEWD123A81O	3510.
	5	5	10	10	1 NO + 1 NC	LEWD253A61O	2128.	LEWD253A71O	2634.	LEWD253A81O	3910.
	10	10	20	20	1 NO + 1 NC	LEWD503A61O	3552.	LEWD503A71O	4272.	LEWD503A81O	7448.
	15	15	40	40	1 NO + 1 NC	LEWD653A61O	4896.	LEWD653A71O	6032.	LEWD653A81O	8376.
	20	30	60	60	2 NO + 2 NC	LEWD113A61O	5632.	LEWD113A71O	7232.	LEWD113A81O	9132.
	40	50	100	100	2 NO + 2 NC	LEWF183A61O	12848.	LEWF183A71O	14448.	LEWF183A81O	17440.
	50	60	125	125	2 NO + 2 NC	LEWF263A61O	13792.	LEWF263A71O	16960.	LEWF263A81O	21792.
	75	100	200	200	2 NO + 2 NC	LEWF403A61O	32400.	LEWF403A71O	45568.	LEWF403A81O	52400.

(1) Starter includes 3 phase overload relays.

•Standard Coil Voltages (60 Hz)

Voltage (volts)	24V	120V	208V	240V	480V	600V
Code	B7	G7	L7	M7	T7	X7

□Thermal Overload Relay Selection Chart

		Type LRD														Type LR9F															
O.L. setting range in amps.	from	0.1	0.16	0.25	0.40	0.63	1	1.6	2.5	4	5.5	7	9	12	16	23	30	37	48	55	63	80	95	110	48	60	90	132	200	300	380
	to	0.16	0.25	0.40	0.63	1	1.6	2.5	4	6	8	10	13	18	24	32	40	50	65	70	80	104	120	140	80	100	150	220	330	500	630
Suffix No.		01	02	03	04	05	06	07	08	10	12	14	16	21	22	53	55	57	59	61	63	65	67	69	63	67	69	71	75	79	81

Catalogue numbers pages 2 to 11
 Overload relays pages 24 to 25
 Factory Modifications pages 12 to 17
 Dimensions pages 18 to 21
 Wiring Diagrams pages 22 to 23

To Order Specify:	Example:				
● Catalogue Number	Catalogue Number	Coil Voltage Code	O/L Relay Suffixes	Factory Mod's	
● Coil Voltage Code	LE8D123A61O	G7	114	10	
● O/L Relay Suffix (x2)					
● Factory Modifications (alphabetical order)					

Part Winding, Wye-Delta and Autotransformer Instakits™ (1)

Max HP 3 phase					Instantaneous contacts per contactor	NEMA Type 1 Catalogue Number	Price ⁽¹⁾	NEMA Type 12 Catalogue Number	Price ⁽¹⁾	NEMA Type 4 Catalogue Number	Price ⁽¹⁾
208V	230V	460V	575V								
Part Winding											
10	15	30	30	1 NO + 1 NC	LEPD253A62O	\$3472.	LEPD253A72O	\$4272.	LEPD253A81O	\$6072.	
25	30	60	60	1 NO + 1 NC	LEPD503A62O	4672.	LEPD503A72O	5312.	LEPD503A81O	7272.	
30	40	80	100	1 NO + 1 NC	LEPD653A62O	5120.	LEPD653A72O	6320.	LEPD653A81O	9632.	
60	75	150	150	2 NO + 2 NC	LEPD113A62O	6720.	LEPD113A72O	7920.	LEPD113A81O	12596.	
75	100	200	200	2 NO + 2 NC	LEPF183A62O	8768.	LEPF183A72O	11168.	LEPF183A81O	14768.	
100	150	300	300	2 NO + 2 NC	LEPF263A62O	15184.	LEPF263A72O	18388.	LEPF263A81O	23184.	
200	250	500	500	2 NO + 2 NC	LEPF403A61O	31608.	LEPF403A71O	36000.	LEPF403A81O	43608.	
Wye Delta Open Transition											
10	10	25	25	1 NO + 1 NC	LE3D253A62O	\$5264.	LE3D253A72O	\$6864.	LE3D253A81O	\$7864.	
15	25	50	50	1 NO + 1 NC	LE3D503A62O	6264.	LE3D503A72O	7904.	LE3D503A81O	9896.	
30	30	75	75	1 NO + 1 NC	LE3D653A62O	7792.	LE3D653A72O	9792.	LE3D653A81O	12152.	
50	60	125	125	2 NO + 2 NC	LE3D113A62O	9520.	LE3D113A72O	10496.	LE3D113A81O	14032.	
75	100	200	200	2 NO + 2 NC	LE3F183A61O	18128.	LE3F183A71O	19328.	LE3F183A81O	24004.	
100	125	250	250	2 NO + 2 NC	LE3F263A61O	19824.	LE3F263A71O	23024.	LE3F263A81O	27824.	
150	200	400	400	2 NO + 2 NC	LE3F403A61O	35552.	LE3F403A71O	39872.	LE3F403A81O	43552.	
Autotransformer (2)											
-	-	15	15	1 NO + 1 NC	LETD253A62O	\$8192.	LETD253A72O	\$9472.	LETD253A81O	\$13152.	
-	-	25	25	1 NO + 1 NC	LETD503A62O	8432.	LETD503A72O	9712.	LETD503A81O	13392.	
-	-	30	30	1 NO + 1 NC	LETD503A62O	8880.	LETD503A72O	10160.	LETD503A81O	13840.	
-	-	40	50	1 NO + 1 NC	LETD653A62O	10960.	LETD653A72O	12880.	LETD653A81O	15920.	
-	-	60	60	2 NO + 2 NC	LETD113A62O	12080.	LETD113A72O	14000.	LETD113A81O	17040.	
-	-	75	75	2 NO + 2 NC	LETD113A62O	18800.	LETD113A72O	20720.	LETD113A81O	27920.	
-	-	100	100	2 NO + 2 NC	LETF183A61O	20080.	LETF183A71O	21488.	LETF183A81O	29200.	
-	-	125	125	2 NO + 2 NC	LETF183A61O	21120.	LETF183A71O	23536.	LETF183A81O	30240.	
-	-	150	150	2 NO + 2 NC	LETF263A61O	28320.	LETF263A71O	31856.	LETF263A81O	43440.	
-	-	200	200	2 NO + 2 NC	LETF403A61O	37400.	LETF403A71O	40280.	LETF403A81O	46520.	
-	-	250	250	2 NO + 2 NC	LETF403A61O	40080.	LETF403A71O	43016.	LETF403A81O	49016.	
-	-	300	300	2 NO + 2 NC	LETF503A61O	53600.	LETF503A71O	57440.	LETF503A81O	63440.	
-	-	400	400	2 NO + 2 NC	LETF503A61O	66048.	LETF503A71O	70984.	LETF503A81O	76984.	
-	-	500	500	2 NO + 2 NC	LETF633A61O	74568.	LETF633A71O	80568.	LETF633A81O	86588.	

● Standard Coil Voltages (60 Hz)

Voltage (volts)	24V	120V	208V	240V	480V	600V
Code	B7	G7	L7	M7	T7	X7

- (1) 3 phase overload relay with thermal compensation included in price.
 (2) 200V and 230V, 3 phase autotransformer starters are also available. Please consult us.

XXXX Motor Voltage and Horsepower Suffix

Voltage	Maximum Hp at													
	15	25	30	50	60	75	100	125	150	200	250	300	400	500
460V	4015	4025	4030	4050	4060	4075	4100	4125	4150	4200	4250	4300	4400	4500
575V	5015	5025	5030	5050	5060	5075	5100	5125	5150	5200	5250	5300	5400	5500

□ Thermal Overload Relay Selection Chart

O.L. setting range in amps. Suffix No.	Type LRD														Type LR9F																
	from	0.1	0.16	0.25	0.40	0.63	1	1.6	2.5	4	5.5	7	9	12	16	23	30	37	48	55	63	80	95	110	48	60	90	132	220	300	380
	to	0.16	0.25	0.40	0.63	1	1.6	2.5	4	6	8	10	13	18	24	32	40	50	65	70	80	104	120	140	80	100	150	220	330	500	630
	01	02	03	04	05	06	07	08	10	12	14	16	21	22	53	55	57	59	61	63	65	67	69	63	67	69	71	75	79	81	

Catalogue numbers pages 2 to 11
 Overload relays pages 24 to 25
 Factory Modifications pages 12 to 17
 Dimensions pages 18 to 21
 Wiring Diagrams pages 22 to 23

To Order Specify:	Example:				
● Catalogue Number	Catalogue Number	Coil Voltage Code	O/L Relay Suffixes	Motor Voltage & Hp Suffix	Factory Mod's
● Coil Voltage Code					
● O/L Relay Suffix					
● Motor Voltage & Hp Suffix	LETD253A61O	G7	121	5015	
● Factory Modifications (alphabetical order)					

IEC Reduced Voltage Combination Starters

Autotransformer Type – Closed Transition
With Fusible Disconnect Switch or Circuit Breaker

Max HP 3 phase 208V 230V 460V 575V	Instantaneous contacts per contactor	NEMA Type 1		NEMA Type 12		NEMA Type 4	
		Catalogue Number ⁽²⁾⁽¹⁾	Price ⁽¹⁾	Catalogue Number ⁽²⁾⁽¹⁾	Price ⁽¹⁾	Catalogue Number ⁽²⁾⁽¹⁾	Price ⁽¹⁾
Disconnect Switch							
- - 15 15	1 NO + 1 NC	LETD258C61O●□xxxx	\$10160.	LETD258C71O●□xxxx	\$11440.	LETD2588C1O●□xxxx	\$14160.
- - 25 25	1 NO + 1 NC	LETD508D61O●□xxxx	10912.	LETD508D71O●□xxxx	12192.	LETD5088D1O●□xxxx	14960.
- - 30 30	1 NO + 1 NC	LETD508D61O●□xxxx	11360.	LETD508D71O●□xxxx	12640.	LETD5088D1O●□xxxx	15360.
- - 40 50	1 NO + 1 NC	LETD658D61O●□xxxx	14160.	LETD638D71O●□xxxx	16080.	LETD6388D1O●□xxxx	18160.
- - 60 60	2 NO + 2 NC	LETD118E61O●□xxxx	15280.	LETD118E71O●□xxxx	17200.	LETD1188E1O●□xxxx	19280.
- - 75 75	2 NO + 2 NC	LETD118E61O●□xxxx	22496.	LETD118E71O●□xxxx	24256.	LETD1188E1O●□xxxx	26496.
- - 100 100	2 NO + 2 NC	LETF188E61O●□xxxx	23776.	LETF188E71O●□xxxx	25184.	LETF1888E1O●□xxxx	27776.
- - 125 125	2 NO + 2 NC	LETF188E61O●□xxxx	26576.	LETF188E71O●□xxxx	28992.	LETF1888E1O●□xxxx	30576.
- - 150 150	2 NO + 2 NC	LETF268F61O●□xxxx	34016.	LETF268F71O●□xxxx	37552.	LETF2688F1O●□xxxx	42016.
- - 200 200	2 NO + 2 NC	LETF408F61O●□xxxx	39992.	LETF408F71O●□xxxx	46872.	LETF4088F1O●□xxxx	51992.
- - 250 250	2 NO + 2 NC	LETF408F61O●□xxxx	54464.	LETF408F71O●□xxxx	57400.	LETF4088F1O●□xxxx	66464.
- - 300 300	2 NO + 2 NC	LETF508G61O●□xxxx	68224.	LETF508G71O●□xxxx	72064.	LETF5088G1O●□xxxx	80224.
- - 400 400	2 NO + 2 NC	LETF508G61O●□xxxx	81472.	LETF508G71O●□xxxx	86408.	LETF5088G1O●□xxxx	93472.
Circuit Breaker type							
- - 15 15	1 NO + 1 NC	LETD259E61O●□xxxx	\$10448.	LETD259E71O●□xxxx	\$11728.	LETD259E81O●□xxxx	\$14448.
- - 25 25	1 NO + 1 NC	LETD509F61O●□xxxx	11424.	LETD509F71O●□xxxx	12704.	LETD509F81O●□xxxx	15424.
- - 30 30	1 NO + 1 NC	LETD509F61O●□xxxx	11872.	LETD509F71O●□xxxx	13152.	LETD509F81O●□xxxx	15872.
- - 40 50	1 NO + 1 NC	LETD659G61O●□xxxx	14672.	LETD639G71O●□xxxx	16592.	LETD639G81O●□xxxx	20672.
- - 60 60	2 NO + 2 NC	LETD119G61O●□xxxx	15792.	LETD119G71O●□xxxx	17712.	LETD119G81O●□xxxx	21792.
- - 75 75	2 NO + 2 NC	LETD119H61O●□xxxx	24272.	LETD119H71O●□xxxx	26192.	LETD119H81O●□xxxx	28272.
- - 100 100	2 NO + 2 NC	LETF189*61O●□xxxx	25552.	LETF189*71O●□xxxx	26960.	LETF189*81O●□xxxx	29552.
- - 125 125	2 NO + 2 NC	LETF189J61O●□xxxx	31760.	LETF189J71O●□xxxx	34176.	LETF189J81O●□xxxx	39760.
- - 150 150	2 NO + 2 NC	LETF269J61O●□xxxx	38960.	LETF269J71O●□xxxx	42496.	LETF269J81O●□xxxx	44960.
- - 200 200	2 NO + 2 NC	LETF409K61O●□xxxx	48040.	LETF409K71O●□xxxx	50920.	LETF409K81O●□xxxx	54040.
- - 250 250	2 NO + 2 NC	LETF409K61O●□xxxx	55744.	LETF409K71O●□xxxx	58680.	LETF409K81O●□xxxx	67744.
- - 300 300	2 NO + 2 NC	LETF509L61O●□xxxx	69264.	LETF509L71O●□xxxx	73104.	LETF509L81O●□xxxx	81264.
- - 400 400	2 NO + 2 NC	LETF509L61O●□xxxx	81712.	LETF509L71O●□xxxx	86648.	LETF509L81O●□xxxx	93712.
- - 500 500	2 NO + 2 NC	LETF639M61O●□xxxx	96280.	LETF639M71O●□xxxx	102280.	LETF639M81O●□xxxx	108280.

● Standard Coil Voltages (60 Hz)

Voltage (volts)	24V	120V	208V	240V	480V	600V
Code	B7	G7	L7	M7	T7	X7

(1) Starter prices include a 3 phase overload relay with thermal compensation.
(2) 200V and 230V, 3 phase autotransformer starters are also available. Please consult us.

Replace * with "H" for 100HP at 600V breaker (MCP) or "J" for 100HP at 480V breaker (MCP)

XXXX Motor Voltage and Horsepower Suffix

Voltage	Maximum Hp at													
	15	25	30	50	60	75	100	125	150	200	250	300	400	500
460V	4015	4025	4030	4050	4060	4075	4100	4125	4150	4200	4250	4300	4400	4500
575V	5015	5025	5030	5050	5060	5075	5100	5125	5150	5200	5250	5300	5400	5500

□ Thermal Overload Relay Selection Chart

O.L. setting range in amps.	Type LRD														Type LR9F																	
	from	0.1	0.16	0.25	0.40	0.63	1	1.25	1.6	2.5	4	5.5	7	9	12	16	23	30	37	48	55	63	80	95	110	48	60	90	132	220	300	380
Suffix No.		01	02	03	04	05	06	X6	07	08	10	12	14	16	21	22	53	55	57	59	61	63	65	67	69	63	67	69	71	75	79	81

Catalogue numbers pages 2 to 11
Overload relays pages 24 to 25
Factory Modifications pages 12 to 17
Dimensions pages 18 to 21
Wiring Diagrams pages 22 to 23

To Order Specify:	Example:					
● Catalogue Number	Catalogue	Coil	O/L	Motor	Fuse	Factory
● Coil Voltage Code	Number	Voltage	Relay	Voltage &	Clip	Mod's
● O/L Relay Suffix		Code	Suffixes	Hp Suffix	Suffix	
● Motor Voltage & Hp Suffix	LETD258C61O	G7	121	5015	101J	
● Fuse Clips Suffix						
● Factory Modifications (alphabetical order)						

Modifications

One operator on cover									
Symbol	Description	Colour	Nameplate	Assembly by	NEMA Type 1 Suffix/Cat. No. (3)	Price	NEMA Type 12 Suffix/Cat. No. (3)	Price	
	Push button mushroom 40mm	Red	Emergency Stop	Factory	A06A	\$80.	A07A	\$192.	
				Customer	-	-	-	-	
	Push button (double touch)	Black Red	I O	Factory	A06I	128.	A07I	192.	
				Customer	LA9CA06IO	80.	LA9CA06IO	80.	
	2 Position selector switch	Black	Off On	Factory	A06D	128.	A07D	352.	
				Customer	LA9CA06DT	80.	LA9CA06DT	80.	
	3 Position selector switch	Black	Hand off auto	Factory	A06E	128.	A07E	352.	
				Customer	LA9CA06ET	116.	LA9CA06ET	116.	
	Pilot light (full voltage)	Green	Power on	Factory	A06S	158.	A07S	350.	
				Customer	LA9CA06ST	128.	LA9CA06ST	128.	
	Pilot light (transformer type)	Green	Power on	Factory	A06F	240.	A07F	432.	
				Customer	LA9CA06FT●	210.	LA9CA06FT●	210.	
	Pilot light (LED type)				LA9CA16ST● (2)		LA9CA16ST● (2)		
Two operators on cover									
	2 push buttons		Start Stop	Factory	A06G	\$128.	A07G	\$352.	
				Customer	LA9CA06GT	116.	LA9CA06GT	116.	
	2 push buttons		I O	Factory	A06T	128.	A07T	352.	
				Customer	-	-	-	-	
	2 position selector switch, Pilot light (transformer type)	Black Green	Off On	Factory	A06H	368.	A07H	784.	
				Customer	LA9CA06HT● (1)	322.	LA9CA06HT● (1)	322.	
	2 position selector switch, Pilot light (full voltage)		Off-on Power on	Factory	A06W	286.	A07W	702.	
				Customer	LA9CA06WT	240.	LA9CA06WT	240.	
	2 position selector switch, LED type Pilot light	Black Green	Off On	Factory	A16W	286.	A17W	702.	
				Customer	LA9CA16WT● (2)	240.	LA9CA16WT● (2)	240.	
	3 position selector switch, Pilot light (transformer type)		Hand off auto Power on	Factory	A06J	368.	A07J	784.	
				Customer	LA9CA06JT● (1)	322.	LA9CA06JT● (1)	322.	
	3 position selector switch, Pilot light (full voltage)		Hand off auto Power on	Factory	A06U	286.	A07U	702.	
				Customer	LA9CA06UT	240.	LA9CA06UT	240.	
	3 position selector switch, LED type Pilot light		Hand off auto Power on	Factory	A16U	286.	A17U	702.	
				Customer	LA9CA16UT● (2)	240.	LA9CA16UT● (2)	240.	
	2 pilot lights (transformer type)	Green Red	Start Stop	Factory	A06K	480.	A07K	864.	
				Customer	-	-	-	-	
	2 LED type	G/R	Start/Stop	Factory	A16K		A17K		
	2 illuminated push buttons (direct)	Green	Start	Factory	A26G	960.	A27G	960.	
		Red	Stop	Customer	-	-	-	-	
	2 LED type illuminated push buttons	G/R	Start/Stop	Factory	A56G	960.	A57G	960.	

(1) Replace (●) with coil voltage code corresponding to the pilot light voltage.

Voltage (volts) 24V 120V 208/240V 480V 600V
Code B G M T X

(2) LED type are available for voltage code: B, G, & M.
 (3) Catalogue numbers beginning with LA9 are only for starters with a "2" before voltage code. (Instakits) When using a factory option that does not have a corresponding customer kit the 10th digit of the starter must change from a "2" to a "1".

Catalogue numbers pages 2 to 11
 Overload relays pages 24 to 25
 Factory Modifications pages 12 to 17
 Dimensions pages 18 to 21
 Wiring Diagrams pages 22 to 23

How to Order:

To Order Specify:	Example			
● Catalogue Number	Catalogue Number	Coil Voltage Code	Overload Relay Suffix	Factory Mod's
● Coil Voltage Code	LE1D0930A62O	G7	112	A06A
● Overload Relay Suffix				
● Fuse Clip Suffix				
● Factory Modifications (alphabetical order)				

Modifications

Three operators on cover

Symbol	Description	Color	Nameplate	Assembly by	NEMA Type 1 Suffix/Cat. No. (3)	Price	NEMA Type 12 Suffix/Cat. No. (3)	Price
	3 Push buttons	Green	Forward	Factory	A06L	\$480	A07L	\$640
		Yellow	Reverse	Customer	LA9CA06LT	436	LA9CA06LT	436
		Red	Stop					
	3 Push buttons	Green	Fast	Factory	A06M	480	A07M	640
		Yellow	Slow	Customer	LA9CA06M	436	LA9CA06MT	436
		Red	Stop					
	2 Push buttons LED type pilot	Black	Power on	Factory	A16V	274	A17V	690
		Red	Start	Customer	LA9CA16VT● (2)	240	LA9CA16VT● (2)	240
		Green	Stop					
	2 Push buttons Pilot light (transformer type)	Black	Power on	Factory	A06N	368	A07N	784
		Red	Start	Customer	LA9CA06NT● (1)	334	LA9CA06NT● (1)	334
		Green	Stop					
	2 Position selector switch Pilot lights (transformer type)	Black	Off	Factory	A06P	608	A07P	1216
		Red/Green	On	Customer	—		—	
		Yellow	Trip					
	2 Position selector switch Pilot lights (LED type)	Black	Off	Factory	A16P	608	A17P	1216
		Green	On	Customer	LA9CA16PT●	368	LA9CA16PT●	368
		Yellow	Trip					
	3 Position selector switch Pilot lights (LED type)	Black	Off	Factory	A36Q	608	A37Q	1216
		Red	On	Customer	LA9CA36QT●	368	LA9CA36QT●	368
		Yellow	Trip					
	3 Position selector switch Pilot lights (LED type)	Black	Off	Factory	A16Q	608	A17Q	1216
		Green	On	Customer	LA9CA16QT●	368	LA9CA16QT●	368
		Yellow	Trip					
	1 push button (double touch) 2 pilot lights (transformer type)	Green	Start	Factory	A06R	608	A07R	1216
		Red	Stop	Customer	—		—	
	1 push button (double touch) 2 pilot lights (LED type)	Green	Start	Factory	A16R	608	A17R	1216
		Red	Stop	Customer	—		—	
	2 Illuminated push buttons 1 push button	Green	Forward	Factory	A26L	960	A27L	960
		Yellow	Reverse	Customer	A56L		A57L	
		Red	Stop					
	2 Illuminated push buttons 1 push button	Green	Fast	Factory	A26M	960	A27M	960
		Yellow	Slow	Customer	A56M		A57M	
		Red	Stop					

(1) Replace (●) with coil voltage code corresponding to the pilot light voltage.

Voltage (volts)	24V	120V	208/240V	480V	600V
Code	B	G	M	T	X

(2) LED type are available for voltage code : B, G & M.

(3) Catalogue numbers beginning with LA9 are only for Starters with a "2" before voltage code. (InstaKits.)

When using a factory option that does not have a corresponding customer kit the 10th digit of the starter must change from a "2" to a "1".

How to Order:

To Order Specify:	Example								
<ul style="list-style-type: none"> ● Catalogue Number ● Coil Voltage Code ● Overload Relay Suffix ● Fuse Clip Suffix ● Factory Modifications (alphabetical order) 	<table border="1"> <tr> <td>Catalogue Number</td> <td>Coil Voltage Code</td> <td>Overload Relay Suffix</td> <td>Factory Mod's</td> </tr> <tr> <td>LE1D0930A62O</td> <td>G7</td> <td>112</td> <td>A06A</td> </tr> </table>	Catalogue Number	Coil Voltage Code	Overload Relay Suffix	Factory Mod's	LE1D0930A62O	G7	112	A06A
Catalogue Number	Coil Voltage Code	Overload Relay Suffix	Factory Mod's						
LE1D0930A62O	G7	112	A06A						

Catalogue numbers pages 2 to 11
 Overload relays pages 24 to 25
 Factory Modifications pages 12 to 17
 Dimensions pages 18 to 21
 Wiring Diagrams pages 22 to 23

Modifications

Control Circuit Transformer*

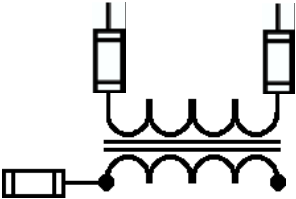
Symbol	Description	VA	For Starter	Assembly by	NEMA Type 1 and 12 Suffix/Cat. No. (2)	Price	
	Full voltage starters (Standard VA capacity)	50	LE1, LE2, LES, LER				
			D09 - D32	Factory	A206P	\$432.	
		100	I18	Customer	LA9TFD32●	232.	
			D40 - D80	Factory	A206P	530.	
		150		Customer	LA9TFD80●	285.	
			D115 - D150, I63	Factory	A206P	705.	
		200		Customer	LA9TFD15●	380.	
			F185	Factory	A206P	850.	
		250		Customer	LA9TFD18●	455.	
			F265	Factory	A206P	995.	
		350		Customer	LA9TFD26●	535.	
			F400 - F500	Factory	A206P	1375.	
		500		Customer	LA9TFD40●	740.	
			F630	Factory	A206P	1875.	
				Customer	LA9TFD63●	1000.	
		Full voltage starters + 100 VA extra capacity		D09 - D80	Factory	A208P	768.
				D11 - D15	Customer	-	-
				F18 - F63	Factory	A208P	944.
					Customer	-	-
		Full voltage starters special primary or secondary voltage		D09 - D80	Factory	A209P	472.
				I18 - I63	Customer	-	-
				D11 - D15	Factory	A209P	672.
				F18 - F63	Customer	-	-
		Reduced voltage starters (Standard VA capacity)		LE3, LET, LEP			
		D09 - D80		Factory	A406P	768.	
				Customer	-	-	
		D11 - D15		Factory	A406P	1248.	
				Customer	-	-	
		F18 - F63		Customer	-	-	
	Reduced voltage starters + 100 VA extra capacity		D09 - D80	Factory	A408P	1104.	
				Customer	-	-	
		D11 - D15		Factory	A408P	1584.	
				Customer	-	-	
		F18 - F63		Customer	-	-	
	Reduced voltage starters special primary or secondary voltage		D09 - D80	Factory	A409P	848.	
				Customer	-	-	
		D11 - D15		Factory	A409P	1376.	
				Customer	-	-	
		F18 - F63					
				Customer	-	-	

Note: To order a control circuit transformer as a factory modification, replace the 11th digit (O) of the starter catalog number with a primary letter from the table below. (see ex.)

* Prices include the secondary fuse; terminal not included.

(1) Replace (●) by corresponding suffix from table below.

(2) Catalogue numbers beginning with LA9 are only for Starters with a "2" before voltage code. (InstaKits.)

When using a factory option that does not have a corresponding customer kit the 10th digit of the starter must change from a "2" to a "1".

Secondary	Primary				
	600V	480V	208V	240V	120V
120V	X	T	L	M	-
24V	A	B	D	C	E

● Suffix

How to Order:

To Order Specify:

- Catalogue Number
- Coil Voltage Code
- Overload Relay Suffix
- Factory Modifications (alphabetical order)





Example

Catalogue Number	Coil Voltage Code	Overload Relay Suffix	Factory Mod's
LE1D098B62X	G7	112	A206P

Catalogue numbers pages 2 to 11
 Overload relays pages 24 to 25
 Factory Modifications pages 12 to 17
 Dimensions pages 18 to 21
 Wiring Diagrams pages 22 to 23

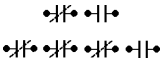
Modifications

Control Circuit

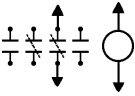
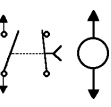
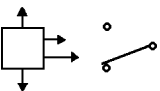
Symbol	Description		For Starter	Assembly by	NEMA Type 1 and 12 Suffix/Cat. No. (2)	Price
	Auxiliary contact block (terminals and wiring not included)	2 contacts	All listed	Factory	A200	\$176.
		4 contacts	All listed	Customer	LADN11	
	Auxiliary contact blocks on disconnect	NO or NC wired	All listed	Factory	A101	320.
		NO or NC unwired	All listed	Customer	-	-
				Factory	A102	176.
				Customer	-	-
	Auxiliary contact blocks on instantaneous trip circuit interrupter	NO or NC wired	All listed	Factory	A103	464.
				Customer	-	-
	Fuses for control circuit (terminals not included)	2 x 600V fuses	All listed	Factory	A104	352.
		1 x 250V fuse	All listed	Customer	-	-
		2 x 250V fuse	All listed	Factory	A105	176.
	Control circuit relay	4 poles unwired	All listed	Factory	A111	320.(1)
				Customer	-	-
		4 poles unwired (coil and 1 contact wired; terminals not included)	All listed	Factory	A112	848.(1)
				Customer	-	-
	Time delay relay	Unwired	All listed	Factory	A113	352.(1)
				Customer	-	-
		Wired (coil and 1 contact wired; terminals not included)	All listed	Factory	A114	720.(1)
		Customer	-	-		
	Thermistor control relay, LT3●● c/w 10 terminals max		All listed	Factory	A115	720.(1)
				Customer	-	-

Note: To order 2 auxiliary contacts supplied as a factory modification, add the appropriate suffix to the end of the catalogue number. (see below)

- (1) Basic relay price must also be added to starter price.
- (2) Catalogue numbers beginning with LA9 are only for Starters with a "2" before voltage code. (InstaKits.)

Catalogue numbers pages 2 to 11
 Overload relays pages 24 to 25
 Factory Modifications pages 12 to 17
 Dimensions pages 18 to 21
 Wiring Diagrams pages 22 to 23

How to Order:

To Order Specify:	Example			
<ul style="list-style-type: none"> ● Catalogue Number ● Coil Voltage Code ● Overload Relay Suffix ● Fuse Clip Suffix ● Factory Modifications (alphabetical order) 	Catalogue Number	Coil Voltage Code	Overload Relay Suffix	Factory Mod's
	LE1D098B62O	G 7	112	A200

Modifications

Meters

Symbol	Description	For Starter	Assembly by	NEMA Type 1 and 12 Suffix/Cat. No.	Price
	Ammeter 3.5" panel type c/w 5 amps. C.T. and 2 controls terminals	All listed	Factory Customer	A135 -	\$1856. -
	Voltmeter 3.5" panel type c/w 0-750 Volts max. c/w 2 x 600V terminals	All listed	Factory Customer	A140 -	1856. -
	Elapsed time meter 3.5" panel type c/w 2 control terminals	All listed	Factory Customer	A138 -	928. -
	3 phase switch (ammeter or voltmeter)	All listed	Factory Customer	A136 -	768. -
	Extra current transformer	All listed	Factory Customer	A137 -	1232. -

Terminal Blocks

	1-5 wired control terminals	All listed	Factory Customer	A605 -	\$160. per starter -
	1-10 wired control terminals	All listed	Factory Customer	A610 -	240. per starter -

Overload Relays

	Class 20	All listed	Factory Customer	A020 -	Included in starter price see page add price of selected model to starter price
--	----------	------------	---------------------	-----------	---

Enclosure Modifications

Cover Gasket	LE...862	Factory	A165	\$160.
	LE...962	Customer	-	-

Special

Give all details in writing	All listed	Factory	A999	Price to be determined
		Customer	-	-

Note: To order an ammeter supplied as a factory modification add the appropriate suffix to the end of the catalogue No.

Catalogue numbers pages 2 to 11
 Overload relays pages 24 to 25
 Factory Modifications pages 12 to 17
 Dimensions pages 18 to 21
 Wiring Diagrams pages 22 to 23

IEC Starters

Factory or Field Installed

InstaKits™ Adaptor for Remote Control Only

Description	For Starter	Assembly by	NEMA Type 1 and 12 Suffix/Cat. No.	Price
7 wire adaptor	-	Factory	-	-
		Customer	LA9AADIS7	\$40.

InstaKits™ Adaptor for Local + Remote Control

3 wire adaptor	-	Factory	-	-
		Customer	LA9AADIS3	40.
4 wire adaptor	-	Factory	-	-
		Customer	LA9AADIS4	40.
5 wire adaptor	-	Factory	-	-
		Customer	LA9AADIS5	40.

InstaKits for Local + Remote Control Connection

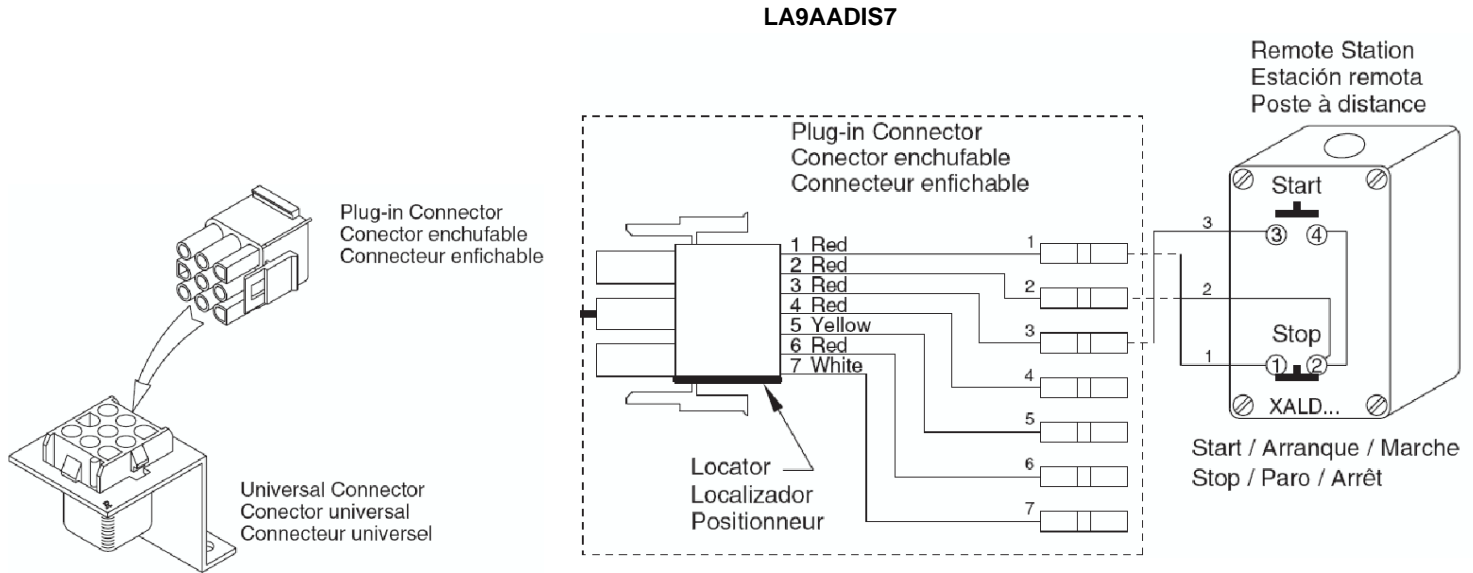

Nameplates

2 x 0.5" glued	all listed	Factory	A141	\$24.
		Customer	-	-
3 x 1" glued	all listed	Factory	A142	40.
		Customer	-	-
2 x 0.5" screwed	all listed	Factory	A241	24.
		Customer	-	-
3 x 1" screwed	all listed	Factory	A242	40.
		Customer	-	-

Catalogue numbers pages 2 to 11
 Overload relays pages 24 to 25
 Factory Modifications pages 12 to 17
 Dimensions pages 18 to 21
 Wiring Diagrams pages 22 to 23

How to Order:

To Order Specify:	Example
● Catalogue Number	LA9AADIS7

Dimensions

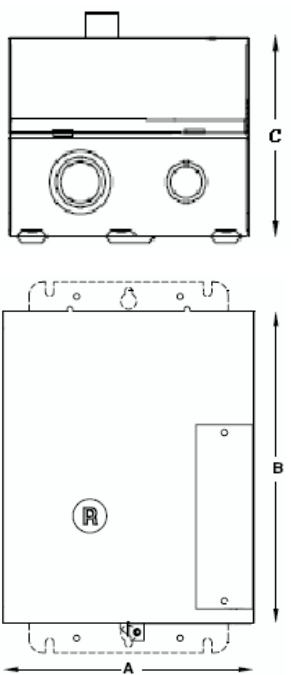

Figure 1

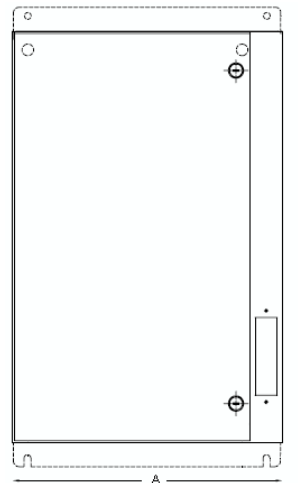
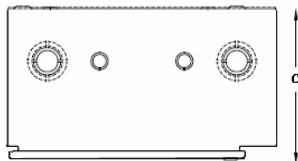

Figure 2

Layout	Catalogue No.	Figure No.	Width (B)	Height (A)	Depth (C)
FVNR Starters - LE1 NEMA Type 1					
	LE1D093A62		172	255	178
	LE1D123A62		172	255	178
	LE1D183A62		172	255	178
	LE1D253A62	1	172	255	178
	LE1D323A62		172	255	178
	LE1D403A62		270	355	188
	LE1D503A62		270	355	188
	LE1D653A62		270	355	188
	LE1D803A62		270	355	188
	LE1D113A62		438	667	247
	LE1D153A62	2	438	667	247
	LE1F263A61		500	732	289
	LE1F403A61		580	930	294
	LE1F503A61		762	1067	313
FVNR Starters - LE1 NEMA Type 12					
	LE1D093A72		172	255	156
	LE1D123A72		172	255	156
	LE1D183A72		172	255	156
	LE1D253A72	1	172	255	156
	LE1D323A72		172	255	156
	LE1D403A72		270	355	188
	LE1D503A72		270	355	188
	LE1D653A72		270	355	188
	LE1D803A72		270	355	188
	LE1D113A72		438	667	247
	LE1D153A72	2	438	667	247
	LE1F263A71		500	732	287
	LE1F403A71		580	930	292
	LE1F503A71		762	1067	340
FVR Starters - LE2 NEMA Type 1					
	LE2D093A62		220	275	188
	LE2D123A62		220	275	188
	LE2D183A62		220	275	188
	LE2D253A62	1	220	275	188
	LE2D323A62		220	275	188
	LE2D403A62		270	355	188
	LE2D503A62		270	355	188
	LE2D653A62		270	355	188
	LE2D803A62		270	355	188
	LE2D113A61		438	667	247
	LE2D153A61	2	438	667	247
	LE2F263A61		500	732	289
	LE2F403A61		580	930	294
	LE2F503A61		762	1067	313
FVR Starters - LE2 NEMA Type 12					
	LE2D093A72		220	275	188
	LE2D123A72		220	275	188
	LE2D183A72		220	275	188
	LE2D253A72	1	220	275	188
	LE2D323A72		220	275	188
	LE2D403A72		270	355	188
	LE2D503A72		270	355	188
	LE2D653A72		270	355	188
	LE2D803A72		270	355	188
	LE2D113A72		438	667	247
	LE2D153A72	2	438	667	247
	LE2F263A71		500	732	287
	LE2F403A71		580	930	292
	LE2F503A71		762	1067	340

Catalogue numbers pages 2 to 11
 Overload relays pages 24 to 25
 Factory Modifications pages 12 to 17
 Dimensions pages 18 to 21
 Wiring Diagrams pages 22 to 23

Note: All dimensions are in millimeters. To convert to inches, multiply by .0394

Dimensions

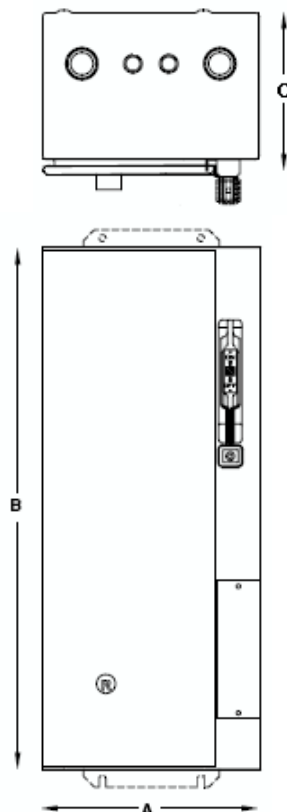

Layout	Catalogue No.	Width (B)	Height (A)	Depth (C)
Combination FVNR Starters – Fusible Switch Type – LE1 – NEMA 1/NEMA 12				
	LE1D098B62/8B72	254	610	193
	LE1D128B62/8B72	254	610	193
	LE1D188B62/8B72	254	610	193
	LE1D258C62/8C72	254	610	193
	LE1D328C62/8C72	254	610	193
	LE1D408C62/8C72	254	610	193
	LE1D508D62/8D72	508	610	233
	LE1D658D62/8D72	508	610	233
	LE1D808E62/8E72	508	1220	252
	LE1F●●861/871	Consult local Schneider Canada Sales Office		
Combination FVNR Starters with instantaneous trip circuit interrupter – LE1 – NEMA 1/NEMA 12				
	LE1D099D62/9D72	254	610	193
	LE1D129D62/9D72	254	610	193
	LE1D189E62/9E72	254	610	193
	LE1D259E62/9E72	254	610	193
	LE1D329F62/9F72	254	610	193
	LE1D409F62/9F72	254	610	193
	LE1D509G62/9G72	254	610	193
	LE1D659G62/9G72	254	610	193
	LE1D809G62/9G72	254	610	200
	LE1F●●961/971	Consult local Schneider Canada Sales Office		
Combination FVR Starters – Fusible Switch Type – LE2 – NEMA 1/NEMA 12				
	LE2D098B62/8B72	254	610	193
	LE2D128B62/8B72	254	610	193
	LE2D188B62/8B72	254	610	193
	LE2D258C62/8C72	254	610	193
	LE2D328C62/8C72	254	610	193
	LE2D408C62/8C72	508	610	233
	LE2D508D62/8D72	508	610	233
	LE2D658D62/8D72	508	610	233
	LE2D808E62/8E72	508	1220	252
	LE2F●●861/871	Consult local Schneider Canada Sales Office		
Combination FVR Starters – Circuit Interrupter – LE2 – NEMA 1/NEMA 12				
	LE2D09962/9D72	254	610	193
	LE2D12962/9D72	254	610	193
	LE2D18962/9E72	254	610	193
	LE2D25962/9E72	254	610	193
	LE2D32962/9F72	254	610	193
	LE2D40962/9F72	508	610	233
	LE2D50962/9G72	508	610	233
	LE2D65962/9G72	508	610	233
	LE2D80962/9G72	508	610	233
	LE2F●●961/971	Consult local Schneider Canada Sales Office		

Note: All dimensions are in millimeters. To convert to inches, multiply by .0394

Catalogue numbers pages 2 to 11
 Overload relays pages 24 to 25
 Factory Modifications pages 12 to 17
 Dimensions pages 18 to 21
 Wiring Diagrams pages 22 to 23

Dimensions

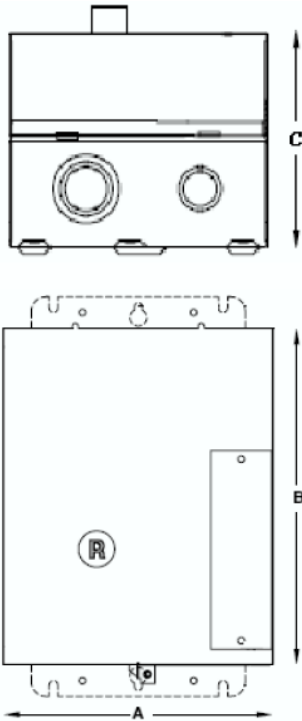

Figure 1

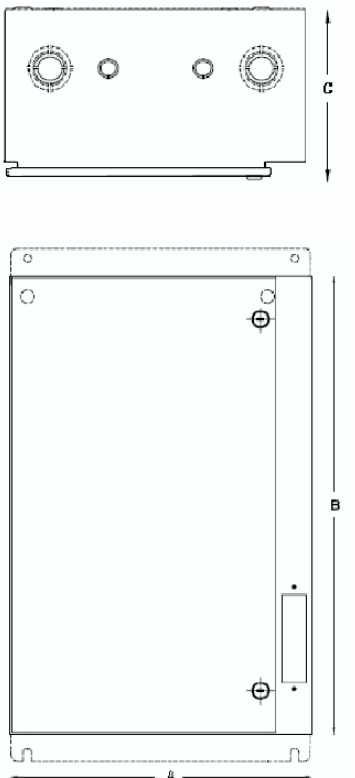

Figure 2

Layout	Catalogue Number	Figure No.	Width (B)	Height (A)	Depth (C)
FVNR Starters – 1 Phase – LES – NEMA Type 1/NEMA Type 12					
	LESD093A62/3A72		172	255	178
	LESD123A62/3A72		172	255	178
	LESD183A62/3A72	1	172	255	178
	LESD253A62/3A72		172	255	178
	LESD323A62/3A72		172	255	178
	LESD403A62/3A72		270	355	188
	LESD503A62/3A72		270	355	188
	LESD653A62/3A72		270	355	188
	LESD803A62/3A72		270	355	188
FVR Starters – 1 Phase – LERD – NEMA Type 1/NEMA Type 12					
	LERD093A62/3A72		172	255	145
	LERD123A62/3A72		172	255	145
	LERD183A62/3A72	1	172	255	145
	LERD253A62/3A72		172	255	145
	LERD323A62/3A72		172	255	145
	LERD403A62/3A72		270	355	188
	LERD503A62/3A72		270	355	188
	LERD653A62/3A72		270	355	188
Reduced Voltage Starters – LEP – NEMA Type 1/NEMA Type 12					
	LEPD253A61/3A71		438	667	249
	LEPD503A61/3A71		438	667	249
	LEPD653A61/3A71	2	438	667	249
	LEPF113A61/3A71		580	930	294
	LEPF183A61/3A71		580	930	294
Reduced Voltage Starters – LET (Non-combination) – NEMA Type 1/NEMA Type 12					
	LETD253A61/3A71		404	468	249
	LETD503A61/3A71		500	732	289
	LETD653A61/3A71	2	500	732	289
	LETF113A61/3A71		580	930	294
	LETF183A61/3A71		580	930	294
	LETF263A61/3A71		762	1067	313
	LETF403A61/3A71		914	1219	442
	LETF503A61/3A71		914	1219	442

Note: All dimensions are in millimeters. To convert to inches, multiply by .0394

Catalogue numbers pages 2 to 11
 Overload relays pages 24 to 25
 Factory Modifications pages 12 to 17
 Dimensions pages 18 to 21
 Wiring Diagrams pages 22 to 23

Dimensions

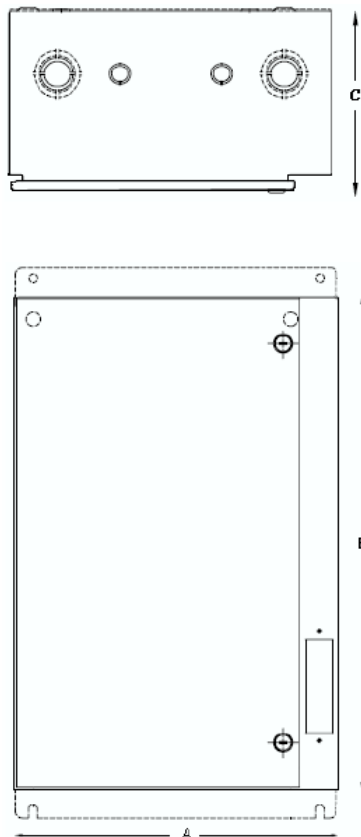

Figure 1

Layout	Catalogue Number	Figure No.	Width (B)	Height (A)	Depth (C)
2 Speed Starters – LE8 – NEMA Type 1/NEMA Type 12					
	LE8D093A61/3A71	1	311	432	226
	LE8D123A61/3A71		311	432	226
	LE8D183A61/3A71		311	432	226
	LE8D253A61/3A71		311	432	226
	LE8D323A61/3A71		311	432	226
	LE8D403A61/3A71		404	468	249
	LE8D503A61/3A71		404	468	249
	LE8D653A61/3A71		404	468	249
	LE8F113A61/3A71		580	930	294
	LE8F183A61/3A71		580	930	294
	LE8F263A61/3A71		762	914	313
2 Speed Starters – LE9 – NEMA Type 1/NEMA Type 12					
	LE9D093A61/3A71	1	254	303	189
	LE9D123A61/3A71		254	303	189
	LE9D183A61/3A71		254	303	189
	LE9D253A61/3A71		254	303	189
	LE9D323A61/3A71		254	303	189
	LE9D403A61/3A71		311	432	226
	LE9D503A61/3A71		311	432	226
	LE9D653A61/3A71		311	432	226
	LE9F113A61/3A71		500	732	289
	LE9F183A61/3A71		500	732	289
Reduced Voltage Starters – LE3 – NEMA Type 1/NEMA Type 12					
	LE3D403A61/3A71	1	404	468	249
	LE3D503A61/3A71		404	468	249
	LE3D653A61/3A71		404	468	249
	LE3F113A61/3A71		580	930	294
	LE3F183A61/3A71		580	930	294

Note: All dimensions are in millimeters. To convert to inches, multiply by .0394

Catalogue numbers	pages 2 to 11
Overload relays	pages 24 to 25
Factory Modifications	pages 12 to 17
Dimensions	pages 18 to 21
Wiring Diagrams	pages 22 to 23

Wiring Diagrams

Non-Reversing (LE1)

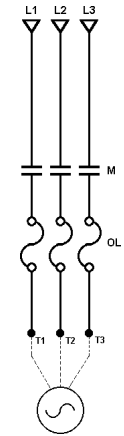

LE1...3

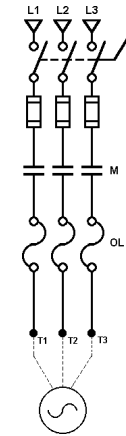

LE1...8

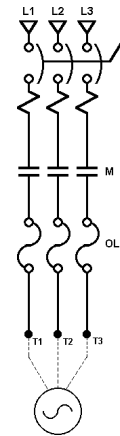

LE1...9

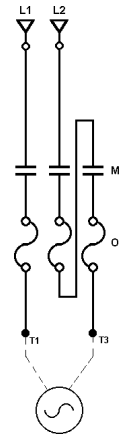

LES...

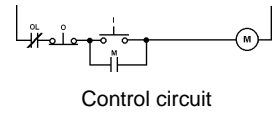

Reversing (LE2)

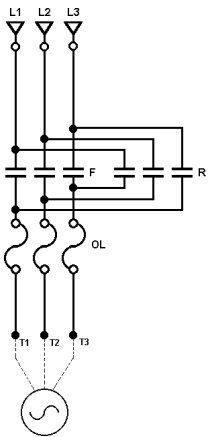

LE2...3

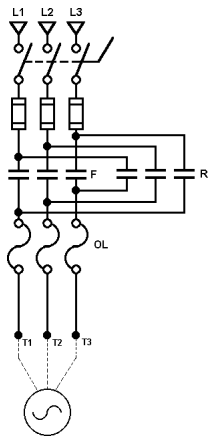

LE2...8

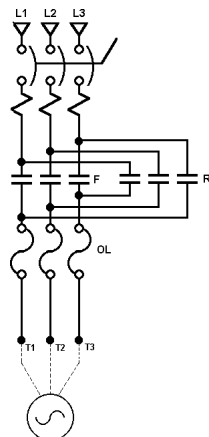

LE2...9

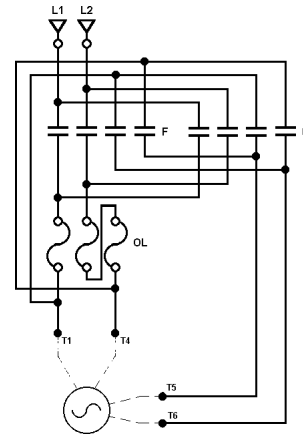

LER...

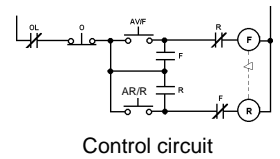

2 Speed (LE8, LE9)

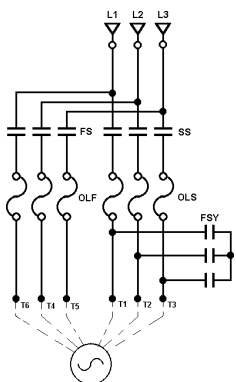

LE8...3

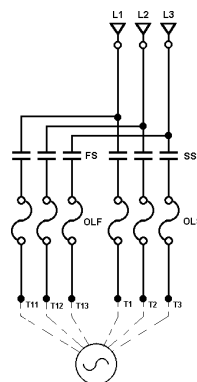
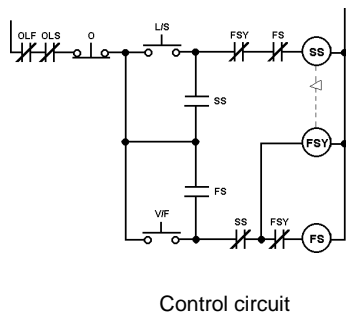

LE9...9

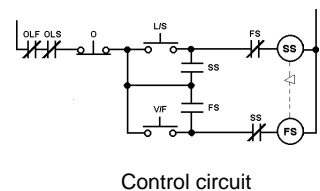

Wiring Diagrams

Part winding (LEP), Wye-Delta (LE3)

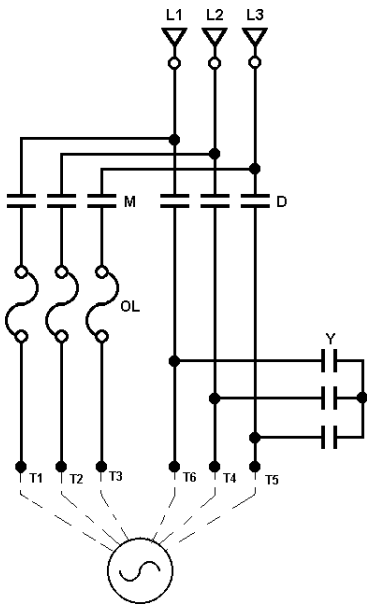

LE3•••

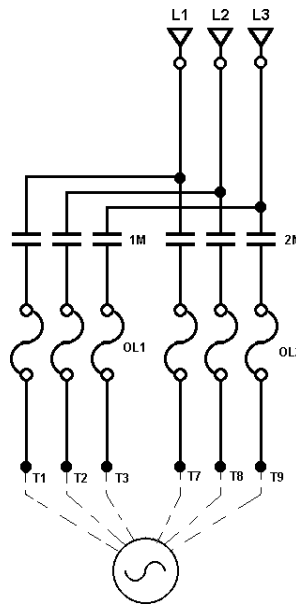
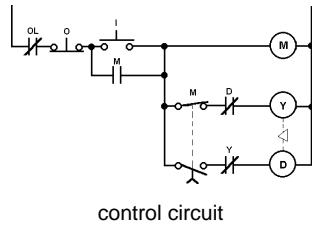

LEP•••

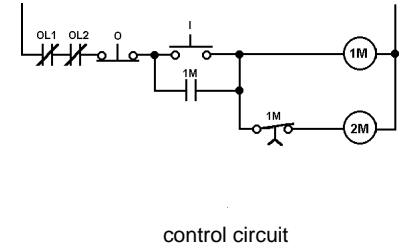

Autotransformer (LET)

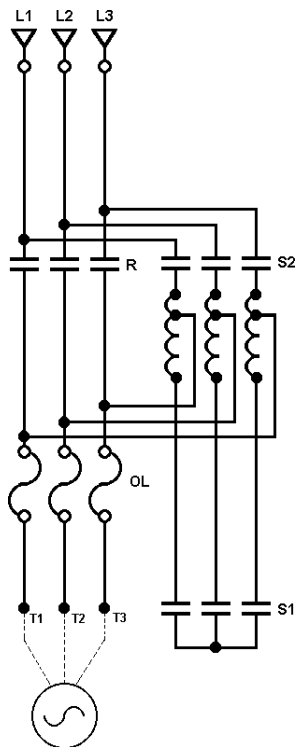

LET••3

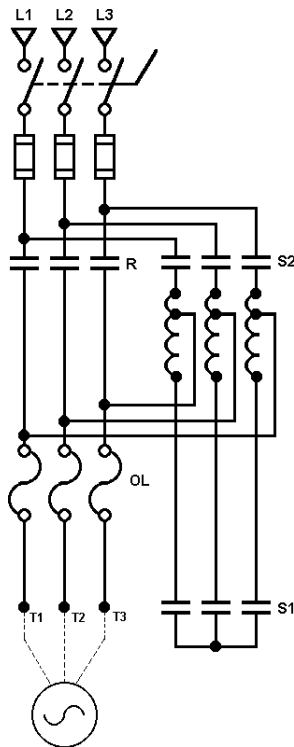

LET••8

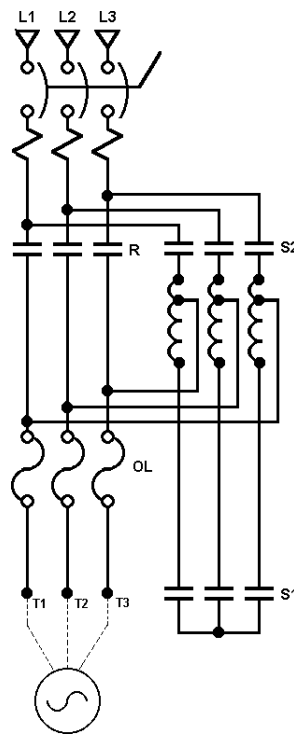

LET••9

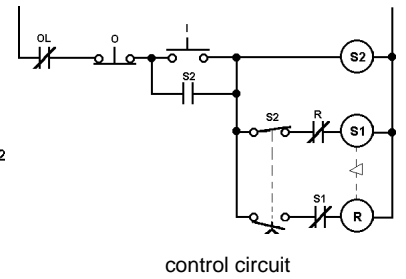



Selection of 3-pole Bimetallic and Solid-state Overload Relays
Compensated and differential overload relays with manual resetting

Horse power rating [HP]						Contactor	Overload			
60 Hz 1800rpm (service factor = 1)							Relay setting	Suffix	Class 10	Class 20
1 Phase		3 Phase				LC1 or LC2	Range	Number	Catalogue	Catalogue
120V	240V	208V	230V	480V	575V			Number	Number	
						D09-D32	0.10 - 0.16	1	LRD01	
						D09-D32	0.16 - 0.25	2	LRD02	
						D09-D32	0.25 - 0.40	3	LRD03	
				1/4	1/4	D09-D32	0.40 - 0.63	4	LRD04	
				1/3	1/3	D09-D32	0.63 - 1	5	LRD05	
				1/2		D09-D32	0.63 - 1	5	LRD05	
		1/4	1/4		1/2	D09-D32	1 - 1.6	6	LRD06	
		1/3	1/3	3/4	3/4	D09-D32	1 - 1.6	6	LRD06	
		1/2	1/2	1	1	D09-D32	1.6 - 2.5	7	LRD07	
			3/4	11/2	11/2	D09-D32	1.6 - 2.5	7	LRD07	
	1/4	3/4			2	D09-D32	2.5 - 4	8	LRD08	LRD1508
	1/3	1	1	2	3	D09-D32	2.5 - 4	8	LRD08	LRD1508
	1/2	11/2	11/2	3		D09-D32	4 - 6	10	LRD10	LRD1510
1/3	3/4	2	2		5	D09-D32	5.5 - 8	12	LRD12	LRD1512
	1			5	7 1/2	D09-D32	7 - 10	14	LRD14	LRD1514
			3			D12-D32	7 - 10	14	LRD14	LRD1514
	11/2					D12-D32	9 - 13	16	LRD16	LRD1516
1/2	2	3		7 1/2	10	D12-D32	9 - 13	16	LRD16	LRD1516
3/4						D18-D32	12 - 18	21	LRD21	LRD1521
1	3	5	5	10	15	D18-D32	12 - 18	21	LRD21	LRD1521
2	3	7 1/2	7 1/2	15	20	D25-D32	16 - 24	22	LRD22	LRD1522
2						D32	23 - 28	30		LRD1530
2	5	10	10	20	25	D32	23 - 32	32	LRD32	LRD1532
						D32	30 - 38	35	LRD35	
						D80	17 - 25	22	LRD3322	LR2D3522
						D80	23 - 32	53	LRD3353	LR2D3553
						D80	30 - 40	55	LRD3355	LR2D3555
						D80	37 - 50	57	LRD3357	LR2D3557
						D40A-D65A	9 - 13	13	LRD313	LRD313L
						D40A-D65A	12 - 18	18	LRD318	LRD318L
						D40A-D65A	17 - 25	25	LRD325	LRD325L
	5		10			D40A-D65A	23 - 32	32	LRD332	LRD332L
				25		D40A-D65A	30 - 40	40	LRD340	LRD340L
3		10		30	30	D40A-D65A	30 - 40	40	LRD340	LRD340L
3						D50A-D65A	30 - 40	40	LRD340	LRD340L
	7 1/2	15	15	40	40	D50A-D65A	37 - 50	50	LRD350	LRD350L
5	10	20	20	40	50	D65A	48 - 65	65	LRD365	LRD365L
				60		D80	48 - 65	59	LRD3359	LR2D3559
			25	50		D80	55 - 70	61	LRD3361	LR2D3561
7.5	15	25	30	60		D80	63 - 80	63	LRD3363	LR2D3563
						D80	80 - 104	65	LRD3365	
		30		75	75	D115 -D150	60 - 100	67	LR9D5367	LR9D5567
			40			D115 -D150	90 - 150	69	LR9D5369	LR9D5569
		40	50	100	100	D150	90 - 150	69	LR9D5369	LR9D5569



For use with contactor	LC1-D	LC1-F
Motor current	60...150 A	30...630 A
Basic reference, to be completed	LR9-D	LR9-F

Relay setting range	Fuse to be used with selected relay international applications		For mounting beneath contactor LC1-	Compensated and differential		or not with alarm Class 10 or 20
	aM	gG		Class 10	Class 20	
60...100	100	160	D115 and D150	LR9-D5367	LR9-D5567	
90...150	160	250	D115 and D150	LR9-D5369	LR9-F5569	
30...50	50	80	F115...F185	LR9-F5357	LR9-F5557	LR9-F57
48...80	80	125	F115...F185	LR9-F5363	LR9-F5563	LR9-F63
60...100	100	200	F115...F185	LR9-F5367	LR9-F5567	LR9-F67
90...150	160	250	F115...F185	LR9-F5369	LR9-F5569	LR9-F69
132...220	250	315	F185...F400	LR9-F5371	LR9-F5571	LR9-F71
200...330	400	500	F225...F500	LR9-F7375	LR9-F7575	LR9-F75
300...500	500	800	F225...F500	LR9-F7379	LR9-F7579	LR9-F79
380...630	630	800	F400...F630 and F800	LR9-F7381	LR9-F7581	LR9-F81

Short circuit protection for North American applications: circuit breakers selected in accordance with CEC and local codes; fuses selected with maximum of 400% full load current.

Accessories

Remote control

Function	Reset	Stop and/or Reset
Electrical reset ⁽¹⁾	LA7-D03• ⁽²⁾	
Reset by flexible cable (length 0.5 m)	LA7-D305	
Adapter for door interlock mechanism		LA7-D1020

Operating head for pushbutton

Spring return	ZA2-BL639	ZA2-BL432
---------------	-----------	-----------

Rod with snap-off end

Adjustable from 17 to 120 mm	ZA2-BZ13	
------------------------------	----------	--

Insulated terminal blocks

For relays LR9-F5•57, F5•63, F5•67, F5•69, F57, F63, F67 and F69	Set of 2 blocks
	LA9-F103

(1) The time for which the coil of remote electrical reset device LA7-D03 can remain energised depends on its rest time: 1 s pulse with 9 s rest time; 5 s pulse duration with 30 s rest time; 10 s pulse duration with 90 s rest time; maximum pulse duration 20 s with rest time of 300 s. Minimum pulse time: 200 ms.

(2) Reference to be completed by adding the coil voltage code.

Schneider Electric

Our products provide quality solutions, meeting all your automation and control applications requirements.



A worldwide presence

- More than 5,000 points of sale in 130 countries.
- A range of products that meets the standards in the country in which they will be used.

Canadian Support

- 200 dedicated sales engineers operate from 22 regional sales centres and 13 technical service centres across Canada.
- Our sales engineers are skilled at assessing individual requirements. Combined with the expert support of our product specialists, they will develop the most effective and economical solution for you, taking relevant regulations and standards into account.

Customer service: (800) 565-6699

Schneider Electric Canada, Inc.

19 Waterman Avenue
Toronto, ON M4B 1Y2
Phone: 1-800-565-6699
www.schneider-electric.ca