



Altivar Soft Starter ATS130

Soft starters for simple machines
from 11 to 55 kW/10 to 75 HP

Quick access to product information

Get technical information about your product

References

Modicon TM3
I/O expansion modules for Modicon controllers
Analog I/O modules

References	Modicon TM3 analog input modules	number and type of channels	Output range	Resolution	Input terminal block (V)	Reference	Weight (kg)
TM3AI2H	2 voltage/current inputs	-10...+10 VDC 0...+10 VDC 0...20 mA A, 20 mA	10 000 cr	0.001%	TM3AI2H	0.150	
			10 000 cr	0.002%	TM3AI2H	0.150	
TM3AI4H	4 voltage/current inputs	-10...+10 VDC 0...+10 VDC 0...20 mA A, 20 mA	12 000 cr	0.001%	TM3AI4H	0.200	
			11 000 cr	0.002%	TM3AI4H	0.200	
TM3AI8H	8 voltage/current inputs	-10...+10 VDC 0...+10 VDC 0...20 mA A, 20 mA	16 000 cr	0.001%	TM3AI8H	0.250	
			15 000 cr	0.002%	TM3AI8H	0.250	
TM3TI2	2 differential temperature inputs (J, K, R, S, T, N, E, C, NiPt100, NiPt1000)	-10...+10 VDC 0...+10 VDC 0...20 mA A, 20 mA	10 000 cr	0.001%	TM3TI2	0.150	
			10 000 cr	0.002%	TM3TI2	0.150	
TM3TI4	4 differential temperature inputs (J, K, R, S, T, N, E, C, NiPt100, NiPt1000)	-10...+10 VDC 0...+10 VDC 0...20 mA A, 20 mA	12 000 cr	0.001%	TM3TI4	0.200	
			11 000 cr	0.002%	TM3TI4	0.200	

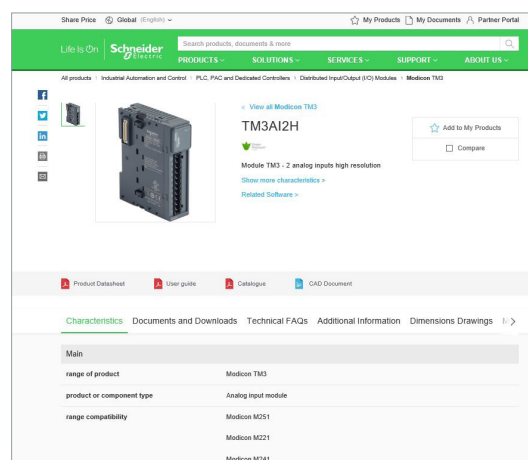

Each commercial reference presented in a catalog contains a hyperlink. Click on it to obtain the technical information of the product:

- Characteristics, Dimensions and drawings, Mounting and clearance, Connections and schemas, Performance curves
- Product image, Instruction sheet, User guide, Product certifications, End of life manual

Find your catalog

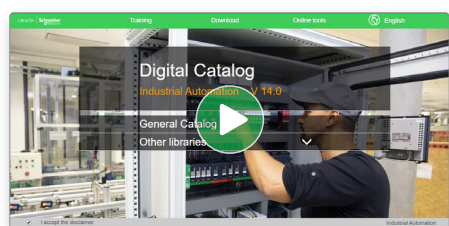

- > With just 3 clicks, you can access the Industrial Automation and Control catalogs, in both English and French
- > Consult digital automation catalogs at [Digi-Cat Online](#)

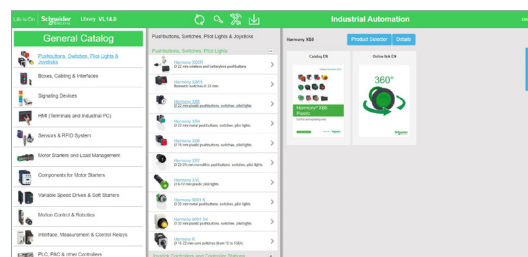

- Up-to-date catalogs
- Embedded product selectors, 360° pictures
- Optimized search by commercial references

Select your training



- > Find the right [Training](#) for your needs on our Global website
- > Locate the training center with the selector tool, using this [link](#)

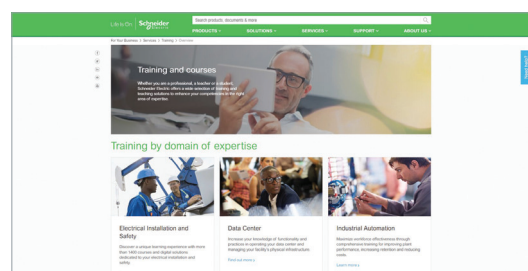

Life Is On

Schneider Electric

mySchneider, your personalized digital experience

Access an all-in-one customized online experience and benefit from tailored business services, resources, and tools to efficiently support your business operations.

- **Efficiency:** In just a few clicks, find all the information and support you need to get the job done.
- **Simplicity:** Use a single login to access all business services, in one place, available 24/7. You no longer need to log in to multiple platforms.
- **Personalization:** Benefit from content, tools, and business services tailored to your activity, and customize your landing page based on your preferences.

Watch the How-to Videos



Order management

- > [Select Products and Add to Cart](#)
- > [Check for Products' Price and Availability](#)
- > [Order Products with Generic Commercial References](#)



Product information

- > [Find a Product Data Sheet and Related Documents](#)
- > [Select Products and Add to Cart](#)
- > [Stay Up to Date on the Status of My Products](#)



Support

- > [Get Quicker Answers Thanks to Online Support](#)

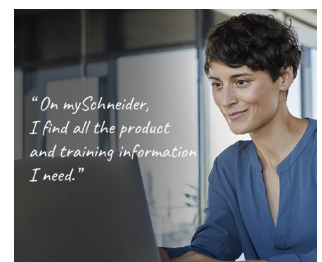

Training

- > [Access Trainings Dedicated to My Activity](#)

"On mySchneider, I find all the product and training information I need."

[Create your account](#)

Life Is 

Schneider
Electric



Digital tools to select your Altivar Soft Starter ATS130 solution

Product selector for ATS130

- Easy selection of the ATS130 commercial reference
- Expand it with options and accessories
- Get the Bill of Material in standard format
- Drop it into the product cart
- Access technical information and documentation



[Scan or click on the QR code](#)

EcoStruxure™ Motor Control Configurator

- From your application, select your soft starter reference
- Expand it with coordinated combination, options, and accessories
- Convert into the Bill of Material and add the product to the cart
- Directly access product documentation
- Save, rework, share your solution with unique ID



[Scan or click on the QR code](#)

EcoStruxure™ Motor Management Design

- From your project, perform electrical design calculation
- Compare direct-on-line, soft starter, and variable speed drive
- Verify starting feasibility from mechanical standpoint
- Verify that power factor and harmonics levels objectives are met
- Build a complete Motor Management solution: circuit breakers, soft starters, drives, contactors, MCC panels, power quality monitoring
- Get a summary report with calculations and recommended offers



[Scan or click on the QR code](#)



Altivar

Discover [Altivar](#)

Variable speed drives and soft starters

Improve your energy efficiency and sustainability with Altivar variable speed drives and soft starters. Manage motor control applications up to 20 MW with products ranging from compact products to custom-engineered solutions. Our connected devices offer built-in intelligence to improve operational efficiency, availability, and functional safety in various application areas, such as industrial processes, machines, or buildings.

Explore our offer

- [Altivar Process](#)
- [Altivar Machine](#)
- [Altivar Building](#)
- [Altivar Soft Starters](#)

Life Is 

Schneider
Electric

Green Premium™

Enhance sustainability with Altivar™ Soft Starter ATS130

Superior environmental performance thanks to upgradability solutions

Altivar™ Soft Starter ATS130 is **RoHS** and **REACH** compliant

- Transparent environment information
- Life Cycle Analysis, compliant with ISO 14025
- Circular instructions

Altivar™ Soft Starter ATS130 brings key benefits to help you achieve **superior upgradable performance** by enhancing its monitoring functions and its starting capabilities by combination with other hardware components.

Upgradeable to a soft motor starter solution

Altivar Soft Starter ATS130 can easily be integrated with the matching TeSys Deca circuit breaker.

The result is a **compact soft motor starter** assembled in a single block, covering short-circuit protection, motor thermal protection, phase loss and phase unbalance protection, along with soft start and stop functions.

Benefits

- High **starting capabilities**
- Optimized **motor starter architecture**
- Reduced **integration time and cost**
- **Preventive maintenance free**
- Compliance with **harsh industrial environments**
- Compatible with **low-depth cabinets**



Experience our offer on se.com/green-premium

Best-in-class starting capabilities

Altivar Soft Starter ATS130 achieves one of the widest duty cycles of its category, helping to ensure a better **machine start availability**.

The **optional fan upgrades the operating cycles/hour**, multiplying it by up to 2 compared to natural convection, thus avoiding the need to oversize your soft starter selection for stringent applications.

Preventive maintenance free

The **EverLink™** power terminals of ATS130 help to ensure a tight connection over time, retightening campaign are no longer required each year, thanks to the patented creep compensation system integrated in.

For control wires, a spring control terminal provides lifetime connection pressure also.

Robust in uncontrolled industrial environments

Altivar Soft Starter ATS130 withstands harsh industrial environments as it complies with chemical class **3C3** and mechanical class **3S3** according to IEC 60721-3-3 Ed. 2002 without salt mist.

In a warmer than expected cabinet, the **overheat monitoring** function will help to prevent excessive starting numbers, and internal diagnosis will report a detected error through a front face LED.

General contents

Altivar Soft Starter ATS130

Altivar Soft Starter selection guide page 4

■ **General presentation**..... page 6

■ **Altivar Soft Starter ATS130 presentation**

□ The offer page 9

□ Description page 10

■ **Selection criteria**

□ Selection criteria for Altivar Soft Starter ATS130 page 11

□ **References**

- ATS130 in-line, motor power in kW page 12

- ATS130 in-line, motor power in HP page 12

- Breakdown of ATS130 reference page 12

- Options page 13

□ Service cycle capabilities page 14

□ Verification of ATS130 capabilities according to machine cycle page 15

■ **Type of coordination**

□ Presentation page 17

□ IEC 60947-4-1 and 60947-4-2 coordination tables page 18

□ UL 60547-4-1 and UL 60947-4-2 coordination tables..... page 19

□ References and selection tables..... page 20

■ **Dimensions**..... page 21

■ **Field services**..... page 22

■ **Product reference index**..... page 24

To be competitive in today's digital era, machine builders must be innovative. Smart machines, those that are better connected, more flexible, more efficient, and safe, are enabling machine builders to innovate in ways never before possible.

EcoStruxure, Schneider Electric's open, IoT-enabled architecture and platform, offers powerful solutions for the digital era. As part of this, EcoStruxure Machine brings powerful opportunities for machine builders and OEMs, empowering them to offer smart machines and compete in the new, digital era.

EcoStruxure Machine brings together key technologies for product connectivity and edge control on premises, and cloud technologies to provide analytics and digital services. EcoStruxure Machine helps you bring more innovation and added value to your customers throughout the entire machine life cycle.

Innovation at Every Level for Machines is full systems across three layers:

- Connected products
Our connected products for measuring, actuating, device level monitoring, and control adhere to open standards to provide unmatched integration opportunities and flexibility
- Edge Control
We are IIoT-ready with a proven set of tested and validated reference architectures that enable the design of end-to-end open, connected, and interoperable systems based on industry standards. Ethernet and OPC UA facilitates IT/OT convergence meaning machine builders reap benefits from web interfaces and cloud.

- Apps, Analytics & Services
Seamless integration of machines to the IT layer allows the collection and aggregation of data ready for analysis – for machine builders and end users alike this means increased uptime and the ability to find information faster for more efficient operations and maintenance.

These levels are completely integrated from shop floor to top floor. And we have cloud offers and end-to-end cybersecurity wrapped around.

EcoStruxure Machine makes it easier for OEMs/ machine builders to offer their customers smarter machines. The advent of smart machines is driven by the changing needs of end users:

- Evolving workforce
- Reducing costs
- Dynamic markets
- Shorter life cycles
- Prioritizing functional safety and cybersecurity

EcoStruxure Machine provides one solution for the whole machine life cycle:

- With Smart Design & Engineering the time to market is reduced by up to 30% using our automated engineering and the simulation capabilities
- During Commissioning & Operation of the machine, resources such as energy, material and loss can be improved, and with seamless integration to the IT world efficiency can be improved by up to 40%
- Smart Maintenance & Services reduces the time for corrective actions up to 50%

EcoStruxure™ Machine

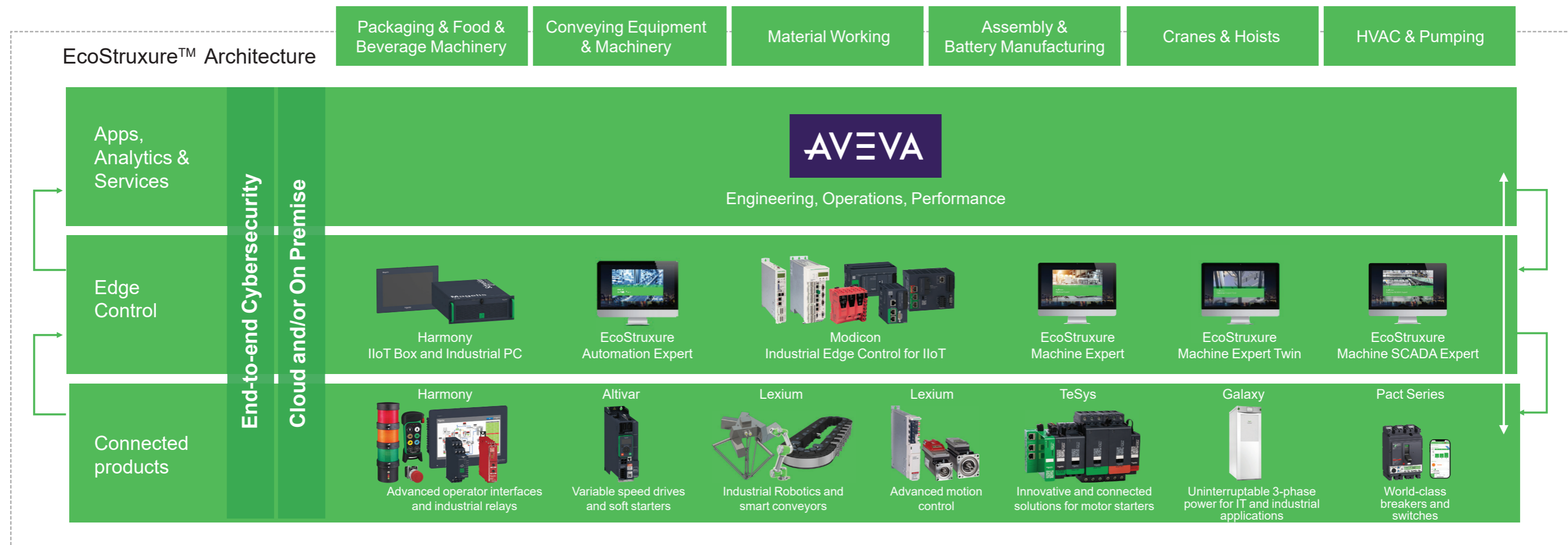

* The Schneider Electric industrial software business and AVEVA have merged to trade as AVEVA Group plc, a UK listed company. The Schneider Electric and Life is On trademarks are owned by Schneider Electric and are being licensed to AVEVA by Schneider Electric.

Altivar Soft Starter

Soft starters for asynchronous motors
Altivar Soft Starter ranges

Market segments	Simple machines		Industrial machines		Process and infrastructures, demanding machines	
Applications	Simple starting	Simple starting and stopping	Simple starting and stopping for pumps and fans		Controlled starting and stopping for pumps, fans, compressors, mixers, crushers, conveyors	
						
Operational voltage range Ue (V)	110...480	200...480	200...480	230...440	208...600	208...690
Operational current range Ie (A)	3...25	6...32	38...105	17...590	17...590	17...1,200
Power range	For 50...60 Hz line supply (kW/HP)					
Single-phase 110...230 V (kW)	0.37...2.2	–	–	–	–	–
Three-phase 200...240 V (kW/HP)	–	0.75...7.5/1...10	–	–	–	–
200...480 V (kW/HP)	0.37...11/0.5...15	–	–	–	–	–
200 V (HP)	–	–	10...30	–	–	–
208 V (HP)	–	–	10...30	–	3...150	3...400
230...240 V (kW/HP)	–	–	11...30/10...40	–	4...160/5...200	4...355/5...450
380...440 V (kW)	1.1...11	1.5...15	18.5...55	7.5...355	7.5...355	7.5...710
460...480 V (HP)	0.5...15	2...20	25...75	–	10...400	10...1,000
500...525 V (kW)	–	–	–	–	9...400	9...800
575 V (HP)	–	–	–	–	15...500	15...1,200
660...690 V (kW)	–	–	–	–	–	11...900
Motor control	Operating cycle		Normal duty		Normal duty and heavy duty	
Current limiting	–		350% current rating		500% current rating (700% rated motor current)	
Boost	–		Yes		Yes	
Type of control	Configurable voltage ramp		–		Torque control (TCS = torque control system), voltage control	
Deceleration	–		Voltage ramp		Torque ramp	
Braking	–		–		Yes	
Number of controlled phases	1	2	3		–	
Connection inside the delta	–		Yes		–	
Bypass	Integrated		–		Yes	
Functions	Motor overload monitoring		External		Electronic embedded, or with PTC	
Other monitoring	–		Soft starter overheating		Underload, overload, motor phase loss, line phase inversion, excessive acceleration time, current overload, ground leakage	
Pre-heating	–		–		Underload, overload, motor phase loss, line phase inversion, overcurrent, excessive acceleration time, current overload, ground leakage	
Smoke extraction	–		–		Yes	
Multi-motor cascade	–		–		Yes	
Second motor set	–		–		Yes	
Communication	Embedded		–		Yes	
Option modules	–		–		Modbus serial link	
Communication and runtime tools	2 potentiometers		3 potentiometers		7-segment display, SoMove software	
Number of I/O	Analog inputs		–		1 PTC probe	
Digital inputs	–		3		–	
Analog outputs	–		–		–	
Digital outputs	–		1		–	
Relay outputs	–		1		–	
Standards and certifications	IEC/EN 60947-4-2 CE, UL, CSA, C-Tick, CCC		IEC/EN 60947-4-2 CE, CCC, UKCA, RCM, EAC, REACH, RoHs		IEC/EN 60947-4-2, EMC class A CE, UL, CSA, C-Tick, GOST, CCC	
References	ATS01N1●●●●		ATS01N2●●●●		ATS130N2●●●LT	
					ATS22●●●Q	
					ATS22●●●S6	
					ATS480●●●Y	

Altivar Soft Starter ATS130

Soft starters for asynchronous motors

Optimized ATS130 soft starters for motor management



Optimized soft starters for motor management

Altivar Soft Starter ATS130 is designed to increase the competitiveness of simple machines through :

- Optimization of machine design
- Operational efficiency during manufacturing

Combined with TeSys Deca frame 3 and 4 thermal magnetic circuit breakers, the Altivar Soft Starter ATS130 range offers a compact and optimized solution for motor management that provides:

- High starting capabilities
- Less stress for mechanics
- Protection of the system
- Energy efficiency
- Continuity of service

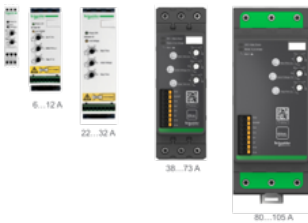

Much more than a power extension of ATS01

Altivar Soft Starter ATS130 consists of one range only covering:

- Operational voltage from 200 to 480 V
- Operational rated current from 38 to 105 A

Altivar Soft Starters ATS130 and ATS01 share the same format, settings, and features such as soft start, soft stop, and boost, to meet the requirements of normal duty applications such as:

- Pumps
- Fans
- Compressors
- Conveyors

ATS130 extends the ATS01 power range up to 55 kW at 400 V and up to 75 HP at 480 V, keeping the small size while providing a number of advantages.

High flexibility in machine design

- > Mechanical flexibility
- > Electrical flexibility

Preventive maintenance free

- > Creep compensation terminals
- > No fan as standard

ATS130 Soft Motor Starter

- > Compact solution
- > Tested combination



Altivar Soft Starter ATS130

Soft starters for asynchronous motors
Complete motor management solution and optimize
machine design

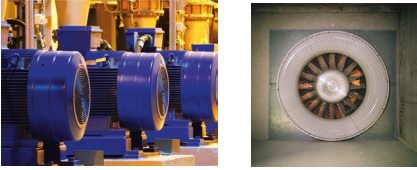

Complete motor management solution

Altivar Soft Starter ATS130 offers an integrated soft motor starter in combination with TeSys Deca circuit breakers to deliver a complete motor management solution that helps to ensure:

- Starting and operating modes
- Suitable protection and integration in industrial control systems
- Maximize the energy efficiency
- Proper operation of applications

A tested, compact assembly, easy to mount and wire

The ATS130 soft motor starter includes the following features:

- Soft starting
- Soft stopping
- Disconnection and isolation
- Short-circuit and motor overload protections

The alternative to a direct on-line motor starter for flexible control panels

The ATS130 motor starter has the same width as a DOL motor starter, 55 or 81 mm and is also compatible with a 200 mm cabinet depth. According to requirements it is easy to install either a DOL or an ATS130 Soft Motor Starter.

Optimize machine design

Mechanical flexibility for mounting

- > On DIN rail
- > On back plate
- > Side-by-side mounting
- > Adapted to 200 mm cabinet depth

Electrical flexibility

- > ATS130 is the alternative to direct on-line in the same width (55 or 81 mm) without the need for control panel redesign
- > Two to four products:
 - Thermal magnetic circuit breaker and ATS130
 - Fuses, contactor, overload relay, and ATS130
- > TeSys Deca frame 3 and frame 4 can be mechanically and electrically attached in a compact assembly: ATS130 Soft Motor Starter

Altivar Soft Starter ATS130

Soft starters for asynchronous motors
Increase operational efficiency and superior sustainability



Increase operational efficiency

Save time during manufacturing

- > Reduce mounting: Just simple “clicks” are necessary to mount the ATS130 or the complete ATS130 soft motor starter on a DIN rail.
- > Reduce wiring: control terminals are spring type as standard.

Robust

- > ATS130 meets the requirements for harsh environments and complies with 3C3 and 3S3 of standard IEC/EN 60721-3-3 ed. 2002 without salt mist in an IP20 degree of protection. Sensitivity to mains fluctuations is low thanks to its wide operational mains voltage range.

High starting capabilities to ensure continuity of service

- > With its duty cycle of 70%, ATS130 is designed to make the most of your motor even in S4 service while matching the starting requirements of the application.

Preventive maintenance free

- > ATS130 has no cooling fan as standard so there is no wear, no clogging, no cleaning, and no replacement. ATS130 is equipped with EverLink power connection and spring terminals for the control section so retightening or tightening torque check are not necessary for power and control connections.

Superior sustainability

Green Premium

Altivar Soft Starter ATS130 is a Green Premium product designed to take account of environmental considerations. With the Schneider Electric Green Premium ecolabel, ATS130 meets the following requirements:

- > Use of hazardous substances
 - Compliance with the European RoHS directive (2011/65/EU and 2015/863/EU) and RoHS China
 - Compliance with REACH regulation No.1907/2006 for the declaration of substances of very high concern (SVHC), authorization (Annex XIV), and restriction (Annex XVII)
 - In terms of restrictions, Green Premium goes beyond the requirements of the current directives and regulations.
- > Environmental impact

The Product Environmental Profile (PEP) is a quantitative Type III Environmental Declaration in compliance with ISO 14025 that helps to ensure appropriate reliability and transparency. Based on a Life Cycle Assessment (LCA) of the product along its whole life cycle, the document presents the different impacts such as energy consumption, carbon footprint, consumption of raw materials, and pollution of air, water, and soil.
- > End-of-Life management

The ATS130 circularity profile information document in accordance with IEC 62635 guidance contains the instructions for responsible disposal of the products and maximizes recycling in a step towards a more circular economy, improving operational efficiency and reducing environmental hazards.



Altivar Soft Starter ATS130

Soft starters for asynchronous motors



The offer

The Altivar Soft Starter ATS130 is a 2-phase controller with four thyristors using voltage ramp to control acceleration and deceleration of three-phase squirrel cage asynchronous motors up to 55 kW/75 HP. The integrated bypass limits the heat dissipation when the motor is running in steady state.

The ATS130 is a compact and cost-effective solution designed to:

- Reduce machine operating costs by reducing mechanical stress and improving machine availability
- Reduce the risk of severe damage by reducing fluid shocks and improving installation availability
- Reduce the stress on the electrical distribution system by reducing line current peaks and voltage drops during motor starts

Altivar Soft Starter ATS130 consists of one range only covering:

- Operational voltage from 200 V (-15%) to 480 V (10%)
- Operational current from 38 to 105 A
- Mains frequency from 50 to 60 Hz (-5%...5%)

A 24 VDC (-10%...10%) power supply is required for the ATS130 control circuit that consumes 21.6 W at peak during the start and stop phases. When the motor is running in steady state the control circuit consumes 3 W.

This power requirement does not include the consumption of external devices such as lights, relays, etc.

Based on ATS130 and TeSys Deca frame 3 or 4 circuit breaker, ATS130 soft motor starter is a solution that includes all functions in a tested, compact, and easy-to-assemble combination.

Robust

The Altivar Soft Starter ATS130 is designed to adapt to the harshest environments.

- Ambient operating temperature:
 - -10...40 °C/14...104 °F without derating
 - Up to 60 °C/140 °F with derating of:
 - 1.5% per 1 °C above 40 °C/104 °F for current ratings from 38 to 73 A
 - 2% per 1 °C above 40 °C/104 °F for current ratings from 80 to 105 A
- Relative humidity without condensing: 5...95%
- Storage and transport temperature: -40...70 °C/-40...158 °F
- Withstand to harsh environments
 - Conforming to IEC/EN 60721-3-3 ed. 2002:
 - Chemical substances class 3C3 without salt mist
 - Mechanical substances class 3S3
 - Mechanical conditions class 3M4
 - Printed circuit boards with protective coating
- Operating altitude:
 - 0...1,000 m/0...3,281 ft without derating
 - 1,000...4,000 m/3,281...13,124 ft with derating of 1% per 100 m/328 ft

Installation

ATS130 is intended to be mounted in a cabinet.

- The protection ratings of the products is IP20 as standard
- Mounting on DIN rail or on a back plate
- Standalone or side-by-side, refer to 14

Electromagnetic compatibility (EMC)

Compliance with electromagnetic compatibility requirements has been incorporated into the design of the Altivar Soft Starter ATS130 to help ensure equipment meets CE marking requirements.

Radiated on conducted emissions according to IEC 60947-4-2 class A on all ATS130 ratings.



Altivar Soft Starter ATS130

Soft starters for asynchronous motors

Certifications

The Altivar Soft Starter ATS130 range has the following certifications:

- UKCA
- CE
- CCC
- RCM
- EAC
- REACH
- RoHs Europe
- RoHs China
- PEP Eco passport

Marking: CE, CCC, RCM, UKCA

Functions

Altivar Soft Starters ATS130 embed functions related to start/stop performance and monitoring, including:

- Voltage ramp to control the motor during acceleration and deceleration periods
- Integrated bypass
- Variable initial voltage to help ensure the motor rotation when a start is commanded
- Boost to overcome any mechanical friction at start
- ATS130 heatsink temperature monitoring

Motor overload monitoring is performed by either a thermal magnetic circuit breaker or a motor overload relay.

Description

- 1 – EverLink power terminal for mains connection
- 2 – Name tag
- 3 – Power supply and control supply status LED
- 4 – Motor running and detected error LED
- 5 – Starting time setting
- 6 – Initial voltage setting
- 7 – Deceleration time setting
- 8 – Identification QR code and access to technical information
- 9 – Spring-type control terminals:
 - DQ1 Open collector digital output
 - Boost Digital input to activate “Boost” function
 - P24 Control power supply input (24 V DC)
 - DI2 Digital input to activate start function
 - DI1 Digital input to activate stop function
 - 0V Control power supply input (0 V DC)
 - R1A-R1C Relay output NO contact
- 10 – EverLink power terminal for motor connection
- 11 – Slide-in fixing point for back plate mounting
- 12 – DIN rail mounting lock

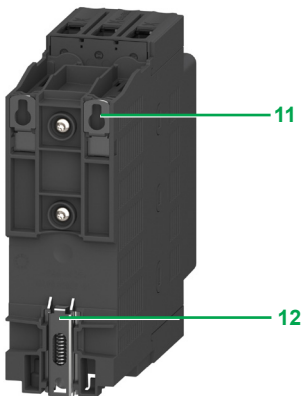

Selection criteria for Altivar Soft Starter ATS130

ATS130 is designed for normal duty applications.

There are two selection criteria:

- The mains voltage: one range to cover 200 to 480 V
- The rated motor power and rated motor current: motor power according to the mains voltage and rated current from 38 to 105 A

Some verifications are necessary according to:

- Mounting conditions (side-by-side, ATS130 soft motor starter), see [page 14](#)
- Machine cycles, see [page 15](#)

Type of application	Starting current (% I _n)	Starting time (s)
Centrifugal pump	300	5 to 15
Piston pump (deceleration ramp for soft stop)	350	5 to 10
Fan	300	10 to 20
Cold compressor	300	5 to 10
Screw compressor	300	3 to 20
Piston compressor	350	5 to 10
Conveyor	300	3 to 10
Lifting screw	300	3 to 10
Elevator	350	5 to 10
Mixer	350	5 to 10



Motor service duty S1

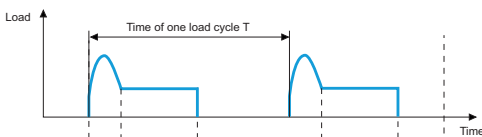

Motor service duty S4

From an application standpoint, the overload is defined depending on the service duty of the motor, S1 (continuous operation) or S4 (intermittent operation), by the following attributes:

- The service factor
- The value of the overcurrent
- The duration of the overcurrent

Altivar Soft Starter ATS130 has the following overload capabilities for a standalone mounting (vertical with clearances):

Service type	Overload (starting)		Service cycle	
	Overcurrent	Duration	No. of starts/h	Conduction
Normal duty				
S1	3 x I _n	5 s	Continuous operation after starting	
S4	3 x I _n	5 s	According to current ratings	70%

Altivar Soft Starter ATS130

Soft starters for asynchronous motors
Connection in-line, normal duty

ATS130 in-line, motor power in kW							
Motor nameplate			ATS130				
Rated operational voltage (Ue)			Reference	Operational rated current (Ie)	Power dissipated at Ie	Power loss independent of motor current	Weight
Rated motor power	230 V	400 V					
kW	kW	kW		A	W	W	kg/lb
11	18.5	22	ATS130N2D38LT	38	7	3	1.26/ 2.78
11	22	22	ATS130N2D45LT	45	9	3	
18.5	30	37	ATS130N2D65LT	65	16	3	
22	37	45	ATS130N2D73LT	73	20	3	
22	45	45	ATS130N2D80LT	80	16	3	2.055/ 4.53
30	55	55	ATS130N2C11LT	105	27	3	

ATS130 in-line, motor power in HP								
Motor nameplate				ATS130				
Rated operational voltage (Ue)				Reference	Operational rated current (Ie)	Power dissipated at Ie	Power loss independent of motor current	Weight
Rated motor power	200 V	208 V	230 V					
HP	HP	HP	HP		A	W	W	kg/lb
10	10	10	25	ATS130N2D38LT	38	7	3	1.26/ 2.78
10	10	15	30	ATS130N2D45LT	45	9	3	
20	20	20	50	ATS130N2D65LT	65	16	3	
20	20	25	50	ATS130N2D73LT	73	20	3	
25	25	30	60	ATS130N2D80LT	80	16	3	2.055/ 4.53
30	30	40	75	ATS130N2C11LT	105	27	3	

Breakdown of ATS130 reference

Breakdown of the ATS130 product reference:

	ATS	130	N2	D	45	LT
Product range	Altivar Soft Starter					
Type	130					
Number of controlled phases during starting and stopping	N2 2-phase control					
Factor for current rating	D current x 1 C current x 10					
Current multiplicand	11-38-45-65-73-80					
Mains voltage	LT 200 to 480 VAC					

For example, for the reference ATS130N2D45LT, the current rating is 45 A (45 x 1).
The current rating is defined as the rated operational current in normal duty, in-line, at 40 °C/104 °F.

Altivar Soft Starter ATS130

Soft starters for asynchronous motors

Options



Altivar Soft Starter ATS130 options

Fixing kit for mounting a circuit breaker onto the ATS130

The fixing kit allows an ATS130 soft motor starter to be built: a TeSys Deca thermal magnetic circuit breaker **1** is mounted on the plastic part **2** (same as a DIN rail mounting), then connected to the ATS130.

The fixing kit allows easy mounting of the circuit breaker, easy connection to the ATS130, and proper cooling of the ATS130.

Altivar Soft Starter ATS130	TeSys Deca circuit breaker (1)	Fixing kit	Weight
Reference	Reference	Reference	kg/lb
ATS130N2D38LT ATS130N2D45LT ATS130N2D65LT	GV3P●●1 (2)	VW3G921304	0.065/0.143
ATS130N2D80LT ATS130N2C11LT	GV4PB●●●	VW3G921305 (3)	0.14/0.30

(1) Refer to the coordination tables on [page 18](#).

(2) To assemble a GV3P40 to P65 circuit breaker with an Altivar Soft Starter ATS130, it is possible to use the circuit breaker supplied without downstream EverLink® power terminal block. To order this product, add the digit 1 to the end of the references selected above. Example: GV3P65 becomes GV3P651.

(3) Includes three copper bars to connect a TeSys Deca frame 4 to the ATS130.

Cooling fan

The cooling fan **3** is necessary to extend the starting capabilities of ATS130 when the application requirements are higher than the starting capabilities indicated in the tables on [page 14](#).

The use of a cooling fan doubles the possible number of starts of the ATS130.

Altivar Soft Starter ATS130	Cooling fan	Weight
Reference	Reference	kg/lb
All ratings ATS130N2D38LT ATS130N2D45LT ATS130N2D65LT ATS130N2D73LT ATS130N2D80LT ATS130N2C11LT	VW3G941305	0.016/0.035

Altivar Soft Starter ATS130 service cycle capabilities

ATS130 is designed in accordance with the AC-3a (formerly AC-53a) utilization category as defined in IEC/EN 60947-4-2 that indicates the service cycle capabilities as follows:

105 : AC-53a 3 – 5 : 70 – 10

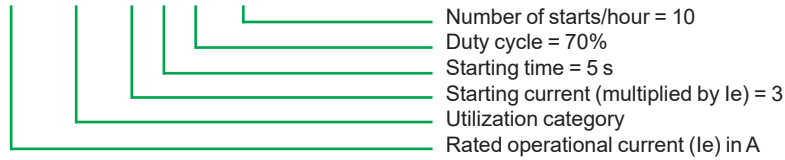

ATS130 service cycle capabilities at 40 °C/104 °F ambient temperature and 1,000 m/3,280 ft altitude without optional cooling fan:



Standalone Altivar Soft Starter ATS130

Standalone mounting, vertically mounted with clearances

Reference	Ie	Starting current	Starting time	Duty cycle	Starts/hour	Operation capabilities	Starting capabilities
	A	x Ie	s				
ATS130N2D38LT	38	3	5	70%	50	112	30
ATS130N2D45LT	45	3	5	70%	35	104	30
ATS130N2D65LT	65	3	5	70%	13	92	26
ATS130N2D73LT	73	3	5	70%	10	90	26
ATS130N2D80LT	80	3	5	70%	25	99	45
ATS130N2C11LT	105	3	5	70%	10	90	37



Two side-by-side Altivar Soft Starter ATS130

Side-by-side, vertically mounted

Reference	Ie	Starting current	Starting time	Duty cycle	Starts/hour	Operation capabilities	Starting capabilities
	A	x Ie	s				
ATS130N2D38LT	38	3	5	70%	32	103	24
ATS130N2D45LT	45	3	5	70%	24	98	25
ATS130N2D65LT	65	3	5	70%	10	90	23
ATS130N2D73LT	73	3	5	70%	7	88	22
ATS130N2D80LT	80	3	5	70%	15	93	35
ATS130N2C11LT	105	3	5	70%	6	88	29



Vertical mounting of ATS130 soft motor starter solution

ATS130 soft motor starter solution vertically mounted with clearances

Reference	Ie	Starting current	Starting time	Duty cycle	Starts/hour	Operation capabilities	Starting capabilities
	A	x Ie	s				
ATS130N2D38LT	38	3	5	70%	50	112	30
ATS130N2D45LT	45	3	5	70%	35	104	30
ATS130N2D65LT	65	3	5	70%	7	88	19
ATS130N2D80LT	80	3	5	50%	25	88	45
ATS130N2C11LT	105	3	5	70%	10	90	37

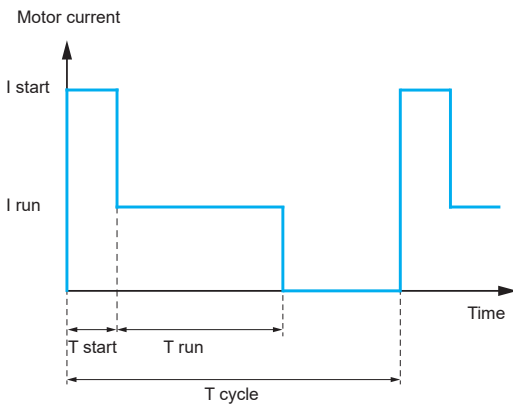

Machine cycle requirements

Verification of ATS130 capabilities according to machine cycle

It is necessary to verify that the ATS130 soft starter you choose matches the machine requirement for starting capabilities and operation capabilities on the complete cycle, as well as the environment conditions such as ambient temperature and altitude:

- Ambient temperature
 - If the ambient temperature exceeds 40 °C/104 °F, the rated operational current I_e shall be derated by:
 - 1.5% per 1 °C above 40 °C/104 °F up to 60 °C/140 °F for current ratings from 38 to 73 A
 - 2% per 1 °C above 40 °C/104 °F for current ratings from 80 to 105 A
 - Then check that the motor current in steady state will not exceed the calculated I_e.
- Altitude
 - If the altitude exceeds 1,000 m/3,280 ft, I_e shall be derated by 1% per 100 m/328 ft above 1,000 m/3,280 ft up to 4,000 m/13,123 ft.
 - Then check that the motor current in steady state will not exceed the calculated I_e.
- Starting requirements of the machine
 - If the starting current, starting time, or number of starts per hour required by the application exceeds the values mentioned on the service capabilities tables (page 14), the starting requirements of the machine shall be calculated as follows:

$$\text{Starting requirements} = \sqrt{\frac{(I_{\text{start}})^2 \times T_{\text{start}} \times \text{Starts/h}}{3,600}}$$

- Compare the starting requirements calculated with the ATS130 starting capabilities value given in the tables of the "Service cycle capability" page refer to the table corresponding to the mounting conditions on page 14)

Machine system requirements	Action
Below ATS130 starting capabilities	Verify the operation capabilities on the complete cycle
Above ATS130 starting capabilities	Install the optional cooling fan on the ATS130 to double its starting capability. Compare the starting requirements with the starting capabilities of the ATS130 with fan.

- Example calculation

Application requirements	Calculation
Motor power: 30 kW Power supply: 400 V Standalone mounting with clearance	Refer to the tables on page 12 Matching ATS130 reference is ATS130N2D65LT
I _{start} = 192 A T _{start} = 15 s Starts/h = 4	Starting requirements = $\sqrt{\frac{192^2 \times 15 \times 4}{3,600}} = 24.8$

The starting requirements (24.8) are below the ATS130 starting capabilities (26), which means that this ATS130 product meets the starting requirements of the machine.

Verification of ATS130 capabilities according to machine cycle (continued)

- Operation capabilities on the complete cycle
- The operation requirements on the complete cycle are determined by the following formula:

$$\text{Application cycle requirement} = \sqrt{\frac{(I_{start}^2 \times T_{start} \times \frac{\text{starts}}{h}) + (I_{run}^2 \times T_{run} \times \frac{\text{starts}}{h})}{0.6 \times I_e}}$$

Verify that the application cycle requirements are lower than the operation capabilities of the ATS130 that corresponds to the mounting conditions (refer to the tables on [page 14](#)).

Note that the ATS130 operation capabilities shall be derated according to altitude (if >1,000 m/3,280 ft) and ambient temperature (if >40 °C/104 °F).

- Example calculation

Application requirements

Motor power: 30 kW
Power supply: 400 V
Standalone mounting with clearance

Calculation

Matching ATS130 reference is **ATS130N2D65LT**

I_{start} = 192 A
T_{start} = 15 s
Starts/h = 4
I_{run} = 60 A
T_{run} = 600 s

Application cycle requirement =

$$\sqrt{\frac{(192^2 \times 15 \times 4) + (60^2 \times 600 \times 4)}{0.6 \times 65}} = 84.5$$

The application cycle requirements (84.5) are below the ATS130 operating capabilities (92), which means that this ATS130 product can be used in this configuration.

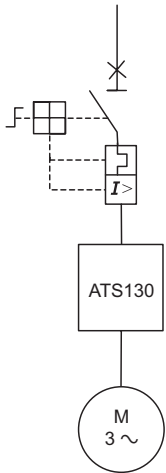

Combination with thermal magnetic circuit breaker

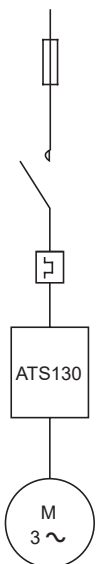

Combination with fuses, contactor, and overload relay

Presentation

Type of coordination

The EN/IEC 60947-4-1 standard makes a distinction between two different types of coordination, which are designated type 1 coordination and type 2 coordination:

- Type 1 coordination requires that, under short-circuit conditions, the contactor or soft starter shall cause no danger to persons or the installation and may not be suitable for further service without repair and replacement of parts.
- Type 2 coordination requires that, under short-circuit conditions, the contactor or soft starter shall cause no danger to persons or the installation and shall be suitable for further use. The risk of contact welding is recognized, in which case the manufacturer shall indicate the measures to be taken as regards the maintenance of the equipment.

The associated fast-acting fuses and ATS130 have not been tested for type 2 coordination (according to IEC 60947-4-1 and IEC 60947-4-2).

Note: Use of a short-circuit protection device (SCPD) that does not comply with the manufacturer's specification can invalidate the coordination.

Avoid automatic restart

Undervoltage, motor phase loss, or phase failure are automatically reset when the system returns to normal.

An automatic restart is initiated, and the motor can restart if a start command is present.

To avoid an automatic restart, phase failure, or undervoltage, monitoring devices must be integrated into the control circuits such as:

- Auxiliary contact of the circuit breaker
- Undervoltage monitoring devices
- Auxiliary contact of overload relay and contactor

Motor overload monitoring

External motor thermal monitoring must be provided. It can be performed by using a TeSys Deca frame 3 or 4 thermal magnetic circuit breaker, or by using an LRD●●●● overload relay. Refer to the combinations for customer assembly on [page 18](#).

Thermal monitoring shall be according to the motor rated current.

Control supply

The control section of the ATS130 must be supplied by an external 24 VDC (-10%...10%) power supply.

The power consumed by each ATS130 control section is:

- 21.6 W peak when the ATS130 is starting or stopping the motor
- 3 W when the motor is running in steady state: ATS130 in bypass mode

This power requirement does not include the consumption of external devices such as lights, relays, etc.

With circuit breaker - ATS130 connected in-line

Motor power			Combination	ATS130	Circuit breaker (1) (2)		Minimum enclosure volume	
230 V kW	380 V 400 V 415 V kW	440V kW			Q1 Reference	Auxiliary contact blocks Reference	dm ³	in ³
11	18.5	22	25	ATS130N2D38LT	GV3P40	GVAE11	48	2,929
11	22	22	25	ATS130N2D45LT	GV3P50			
18.5	30	37	25	ATS130N2D65LT	GV3P65			
22	37	45	25	ATS130N2D73LT	GV3P73			
–	45	45	25	ATS130N2D80LT	GV4PB115● (3) (4)	GV4AE11 (5)	63	3,840
30	55	55	25	ATS130N2C11LT				

ATS130 soft motor starter

Motor power			Combination	ATS130	Circuit breaker (1) (2)		Minimum enclosure volume	
230 V kW	380 V 400 V 415 V kW	440V kW			Q1 Reference	Auxiliary contact blocks Reference	dm ³	in ³
11	18.5	22	25	ATS130N2D38LT	GV3P401 (6)	GVAE11	48	2,929
11	22	22	25	ATS130N2D45LT	GV3P501 (6)			
18.5	30	37	25	ATS130N2D65LT	GV3P651 (6)			
22	37	–	25	ATS130N2D80LT	GV4PB80● (3) (4) (7)	GV4AE11 (5)	63	3,840
–	45	45	25	ATS130N2D80LT	GV4PB115● (3) (4) (7)			
30	55	55	25	ATS130N2C11LT				

With fuse, contactor, and overload relay - ATS130 connected in-line

Motor power			Combination	ATS130	AM fuse		Fuse disconnecter (8)	Line contactor (9) KM1	Overload relay (1)	Minimum enclosure volume	
230 V kW	380 V 400 V 415 V kW	440V kW			Reference	Reference				Size	Reference
11	18.5	22	50	ATS130N2D38LT	DF2FA40	22 x 58	GS1JD3	LC1D40A●●	LRD340	48	2,929
11	22	22	50	ATS130N2D45LT	DF2FA50	22 x 58	GS1JD3	LC1D50A●●	LRD350		
18.5	30	37	50	ATS130N2D65LT	DF2FA63	22 x 58	GS1JD3	LC1D65A●●	LRD365		
22	37	45	50	ATS130N2D73LT	DF2FA80	22 x 58	GS1JD3	LC1D80A●●	LRD380		
22	45	45	50	ATS130N2D80LT	DF2FA80	22 x 58	GS1JD3	LC1D95●●	LRD3365		
30	55	55	50	ATS130N2C11LT	DF2FA125	22 x 58	GS1KD3	LC1D115●●	LRD4367		

- (1) Set the thermal monitoring current to the rated motor current.
- (2) The Altivar Soft Starter ATS130 must be equipped with an auxiliary contact block on the circuit breaker (OF position). Integrate the contact into the control circuit to help prevent an automatic restart (refer to [page 20](#)).
- (3) The date part of manufacturing code of the TeSys Deca frame 4 circuit breaker must be higher than [PL24183●●●●●●●●](#) (24=year, 18=week of the year, 3=day of week).
- (4) Replace ● with the appropriate breaking capacity code of the circuit breaker (refer to [page 20](#)). You can use the EcoStruxure™ Motor Control Configurator tool to support your customization.
- (5) The auxiliary contact is used for the Open/Close OF function.
- (6) This circuit breaker is not equipped with a downstream EverLink® power terminal block. The Altivar Soft Starter ATS130 must be equipped with the fixing kit [VW3G921304](#) to mount the circuit breaker onto the ATS130.
- (7) The Altivar Soft Starter ATS130 must be equipped with the fixing kit [VW3G921305](#) to mount the circuit breaker onto the ATS130.
- (8) The direct operating handle is sold separately, consult the TeSys catalog.
- (9) Replace ●● with the appropriate control circuit voltage code (refer to [page 20](#)).

With circuit breaker - ATS130 connected in-line for North American market (UL applications)

Motor power				Combination	ATS130	Circuit breaker (1) (2)			Minimum enclosure volume	
200 V	208 V	230 V	460V			Q1	Auxiliary contact block	Line spacer	dm ³	in ³
HP	HP	HP	HP	Iq (kA)	Reference	Reference	Reference	Reference		
10	10	10	25	25	ATS130N2D38LT	GV3P40	GVAE11	GV3G66	48	2,929
10	10	15	30	25	ATS130N2D45LT	GV3P50				
20	20	20	40	25	ATS130N2D65LT	GV3P65				
20	20	25	50	25	ATS130N2D73LT	GV4PB80● (3) (4)	GV4AE11 (5)	–		
25	25	30	60	25	ATS130N2D80LT	GV4PB80● (3) (4)			63	3,840
30	30	40	75	25	ATS130N2C11LT	GV4PB115● (3) (4)				

ATS130 soft motor starter for North American market (UL applications)

Motor power				Combination	ATS130	Circuit breaker (1) (2)			Minimum enclosure volume	
200 V	208 V	230 V	460V			Q1	Auxiliary contact block	Line spacer	dm ³	in ³
HP	HP	HP	HP	Iq (kA)	Reference	Reference	Reference	Reference		
10	10	10	25	25	ATS130N2D38LT	GV3P401 (6)	GVAE11	GV3G66	48	2,929
10	10	15	30	25	ATS130N2D45LT	GV3P501 (6)				
20	20	20	40	25	ATS130N2D65LT	GV3P651 (6)				
25	25	30	60	25	ATS130N2D80LT	GV4PB80● (3) (4) (7)	GV4AE11 (5)	–	63	3,840
30	30	40	75	25	ATS130N2C11LT	GV4PB115● (3) (4) (7)				

With class J fuses, contactor, and overload relay - ATS130 connected in-line for North American market (UL applications)

Motor power				Combination	ATS130	Class J fuse	Line contactor (8)	Overload relay (1)	Minimum enclosure volume	
200 V	208 V	230 V	460V						Reference	Reference
HP	HP	HP	HP	Iq (kA)	Reference	A	Reference	Reference		
10	10	10	25	65	ATS130N2D38LT	60	LC1D40A●●	LRD340	48	2,929
10	10	15	30	65	ATS130N2D45LT	90	LC1D50A●●	LRD350		
20	20	20	50	65	ATS130N2D65LT	110	LC1D80●●	LRD3361		
20	20	25	50	65	ATS130N2D73LT	150	LC1D80●●	LRD3363		
25	25	30	60	65	ATS130N2D80LT	175				
30	30	40	75	65	ATS130N2C11LT	200	LC1D115●●	LRD4365		

- (1) Set the thermal monitoring current to the rated motor current.
- (2) The Altivar Soft Starter ATS130 must be equipped with auxiliary contact block(s) on the circuit breaker (OF position). Integrate the contact into the control circuit to help prevent an automatic restart (refer to [page 20](#)).
- (3) The date part of manufacturing code of the TeSys Deca frame 4 circuit breaker must be higher than [PL24183●●●●●●●●](#) (24=year, 18=week of the year, 3=day of week).
- (4) Replace ● with the appropriate breaking capacity code of the circuit breaker (refer to [page 20](#)). You can use the EcoStruxure™ Motor Control Configurator tool to support your customization.
- (5) The auxiliary contact is used for the Open/Close OF function.
- (6) This circuit breaker is not equipped with a downstream EverLink® power terminal block. The Altivar Soft Starter ATS130 must be equipped with the fixing kit [VW3G921304](#) to mount the circuit breaker onto the ATS130.
- (7) The Altivar Soft Starter ATS130 must be equipped with the fixing kit [VW3G921305](#) to mount the circuit breaker onto the ATS130.
- (8) Replace ●● with the appropriate control circuit voltage code (refer to [page 20](#)).

Line contactor reference table

Basic reference	Power supply AC	Control voltage code													
		24	42	48	110	115	220	230	240	380	400	415	440	500	
LC1D18...D150 (1)	50/60 Hz	B7	D7	E7	F7	FE7	M7	P7	U7	Q7	V7	N7	R7	S7	
LC1D18...D65 (2)	50 Hz	B5	D5	E5	-	-	-	P5	-	-	-	-	-	-	
LC1D80...D115	50 Hz	B5	D5	E5	F5	FE5	M5	P5	U5	Q5	V5	N5	R5	S5	
LC1D80...D115	60 Hz	B6	-	E6	F6	-	M6	-	U6	Q6	-	-	R6	-	
	DC	12	24	36	48	60	72	110	125	220	250	440			
LC1D18...D38 (3)	U 0.7...1.25 Uc	JD	BD	CD	ED	ND	SD	FD	GD	MD	UD	RD			
LC1D40A...D65A (3)	U 0.75...1.25 Uc	JD	(5)	(5)	(5)	(5)	(5)	(5)	(5)	(5)	(5)	RD			
LC1D80...D95	U 0.85...1.1 Uc	JD	BD	CD	ED	ND	SD	FD	GD	MD	UD	RD			
	U 0.75...1.2 Uc	JW	BW	CW	EW	-	SW	FW	-	MW	-	-			
LC1D115...150 (4)	U 0.75...1.2 Uc	-	BD	-	ED	ND	SD	FD	GD	MD	UD	RD			
	DC (low consumption)	5	12	20	24	48	110	220	250						
LC1D18...D38 (3)	U 0.8...1.25 Uc	AL	JL	ZL	BL	EL	FL	ML	UL						
	AC/DC (low consumption)														
LC1D18...D150	See TeSys D Green, page B8/4 of TeSys catalog														

Circuit breaker auxiliary contact blocks reference table

Designation	Contact type	Functions	Reference
TeSys GV3P auxiliary contact block	1 NO + 1 NC	-	GVAE11
TeSys GV3P auxiliary contact block	1 C/O	Short-circuit signaling	GVAM11
TeSys GV4 auxiliary contact block	1 C/O	Open/Close OF, trip alarm SD	GV4AE11

GV4PB circuit breaker - selection according to short-circuit current rating (SCCR)

240 V AC	480Y/277 V AC	600Y/347 V AC	Reference
SCCR	SCCR	SCCR	
kA	kA	kA	
35	18	14	GV4PB●●●B
65	35	18	GV4PB●●●N
100	65	25	GV4PB●●●S

(1) D115 and D150 coils with built-in suppression as standard, by bidirectional peak limiting diode.

(2) Not available with "connection for lugs or bars".

(3) Coils with integral suppression device fitted as standard, by bidirectional peak limiting diode.

(4) Coil with built-in suppression device as standard.

(5) For these coil voltages, choose from TeSys D Green contactors. Same root product reference, just add BBE coil voltage code for 24 V DC, BNE for 24-60 V AC/DC, EHE for 48-130 V AC/DC, KUE for 100-250 V AC/DC. Example: LC1D40ABBE

Altivar Soft Starter ATS130

Soft starters for asynchronous motors

Soft starters

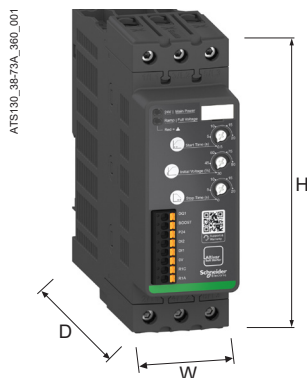

Altivar Soft Starter ATS130

Reference	W x H x D	
	mm	in.
ATS130N2D38LT	55 x 166 x 165	2.17 x 6.54 x 6.50
ATS130N2D45LT		
ATS130N2D65LT		
ATS130N2D73LT		
ATS130N2D80LT	81 x 197 x 180	3.19 x 7.76 x 7.09
ATS130N2C11LT		

Variable speed drives and soft starters

A whole world of Services for your drives and soft starters by Schneider Electric

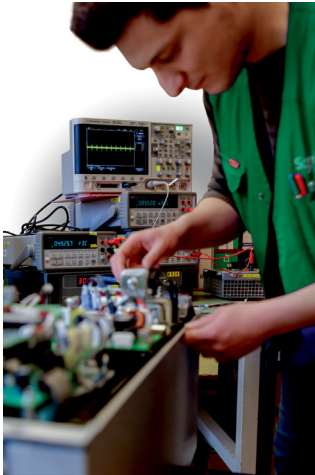

Support and services offer by Schneider Electric

Variable speed drives and soft starters are an important part of your operation, with downtime having a significant impact on your business. Protecting that investment through comprehensive services means that you can continue to deliver optimally throughout the lifecycle of your drive and soft starter. Our range of services is designed to help you get more out of your drives and soft starters, your operation, and to improve your environmental impact.



Install

- **Extended Warranty** service helps you control your maintenance costs. Schneider Electric will provide a replacement drive and soft starter or repair the product on site during a period of one or three years more than the standard warranty, in all conditions covered by the extended warranty.
- **Start-up** service is the first essential step in maintenance and optimal operational performance of the drive or soft starter. Our comprehensive review checks up to 100 parameters and is especially designed for drives and soft starters in simple applications.
- **Commissioning** service ensures a reliable start for operations with more complex applications and drive systems. The unique requirements of your process need to be carefully considered to ensure efficient operations.

Operate

- **Preventive Maintenance** service performs predetermined maintenance actions according to a product-specific schedule. The work is carried out by certified technical experts following Schneider Electric instructions. This service minimizes unplanned downtime and extends your equipment lifetime.
- **Remote Technical Support** brings you expert product assistance over the phone, email, chat, or web for any technical questions relating to your drives and soft starters, including configuration, diagnostics, and maintenance. Our global support team is multi-lingual with support available up to R&D level experts if needed.
- **On-Site Expert Assistance** service offers you highly skilled field service experts to troubleshoot and resolve drive or soft starter equipment-related matters at your site, as a back-up source of expertise for your personnel.
- **Spare Part Management** service identifies and manages your critical spare parts either on your site or offsite. This service ensures that you have access to the spares you need without having to invest in capital to maintain the stock.

(1) Services available in countries that have the right structure and capabilities.

Variable speed drives and soft starters

A whole world of Services for your drives and soft starters by Schneider Electric



Support and services offer by Schneider Electric (continued)

Optimize

- **Training** service offers eLearning, classroom, and onsite training provision to enhance the technical installation, commissioning, and maintenance competencies of your personnel. Added competence translates into further process efficiency and reliability, as well as employee satisfaction.
- **EcoStruxure Asset Advisor** service enables you to move from reactive to predictive maintenance and access actionable insight provided by the advisor. The service predicts drive- and motor-related actions through connected devices and advanced algorithms monitored by Schneider Electric's experts.

Renew

- **Drive Revitalization** is an excellent choice if you prefer to use your aging drives longer and want to extend their service life with affordable and comprehensive inspection and replacement of all critical parts.
- **Drive and soft starter replacement** involves modernizing equipment by replacing the previous aged or obsolete product with a new one matched to the purpose. The service can be extended with engineering in case the device and process requires more advanced engineering.

Circular economy

- **Spare Parts** are available from our local, regional, and global stocks. Original equipment parts from Schneider Electric are reliable and easily available. They will help to keep your product in operation for longer.
- **Repair** allows you to extend the life of your drive or soft starter. The affected product can be replaced, or repaired on site or at our repair centers, depending on the type of product in question.
- **Fast Exchange by refurbished drive or soft starter (1)** gives a second life to inoperative drives or soft starters. In this case, we offer an immediate exchange with a replacement refurbished drive or soft starter and take back the product, repair it, and keep it ready for the next exchange.
- **Take-back and recycling (1)** is the last step to improve your environmental impact. Unrepairable products are dismantled, raw materials are collected and given a second life. Up to 85% of the product components can be recycled.

Service contracts secure recovery, availability, and outcome

Service contracts manage the safety and performance of your assets through well-defined maintenance plans tailored to your operational needs. The predefined service contract – Advantage Service Plan – and fully customizable “à la carte” service contract are built from the services in the “Operate” and “Optimize” phases and service levels defining availability, response, and lead times matching your particular needs. You will enjoy priority access to Schneider Electric support when you need it, as well as having an expert partner to plan the long-term evolution of your drives and soft starters.

mySchneider app

With the mySchneider app you have easy 24/7 access to product information and expert support. All registered users have access to additional features, such as real-time notifications, order tracking, product pricing, and availability. The mySchneider app is available for download from the IOS and Android app store.

Schneider Electric – helping you succeed

Schneider Electric, the leader in digital transformation of energy management and automation, has operations in more than 100 countries. With this global footprint we have certified field service representatives, regional expert and advanced level support up to product R&D to provide you the right support across the lifecycle of your drives and soft starters. Furthermore, we offer an extensive network of local and global repair centers and a logistics chain that underpins our ability to respond to your needs.

To order services or find out more, please contact your local Schneider Electric service center.

(1) Services available in countries that have the right structure and capabilities.

A		LC1D115FE7	18	LRD350	18
ATS130N2C11LT	12		19		19
	18	LC1D115M7	18	LRD365	18
	19		19	LRD380	18
	21	LC1D115P7	18	LRD4365	19
ATS130N2D38LT	12		19	LRD4367	18
	18	LC1D40AB7	18	V	
	19		19	VW3G921304	13
	21	LC1D40ABBE	18		18
ATS130N2D45LT	12		19		19
	18	LC1D40AF7	18	VW3G921305	13
	19		19		18
	21	LC1D40AFE7	18		19
ATS130N2D65LT	12		19	VW3G941305	13
	18	LC1D40AM7	18		
	19		19		
	21	LC1D40AP7	18		
ATS130N2D73LT	12		19		
	18	LC1D40AU7	18		
	19		19		
	21	LC1D50AB7	18		
ATS130N2D80LT	12		19		
	18	LC1D50ABBE	18		
	19		19		
	21	LC1D50AF7	18		
D			19		
DF2FA125	18	LC1D50AFE7	18		
DF2FA40	18		19		
DF2FA50	18	LC1D50AM7	18		
DF2FA63	18		19		
DF2FA80	18	LC1D50AP7	18		
G			19		
GS1JD3	18	LC1D50AU7	18		
GS1KD3	18		19		
GV3G66	19	LC1D65AB7	18		
GV3P40	18	LC1D65ABBE	18		
	19	LC1D65AF7	18		
GV3P401	18	LC1D65AFE7	18		
	19	LC1D65AM7	18		
GV3P50	18	LC1D65AP7	18		
	19	LC1D65AU7	18		
GV3P501	18	LC1D80AB7	18		
	19		19		
GV3P65	18	LC1D80ABBE	18		
	19		19		
GV3P651	18	LC1D80AKUE	18		
	19		19		
GV3P73	18	LC1D80AM7	18		
GV4AE11	18		19		
	20	LC1D80AP7	18		
GV4PB115B	18		19		
	19	LC1D80B7	19		
GV4PB115N	18	LC1D80BD	19		
	19	LC1D80F7	19		
GV4PB115S	18	LC1D80FE7	19		
	19	LC1D80M7	19		
GV4PB80B	18	LC1D80P7	19		
	19	LC1D80U7	19		
GV4PB80N	18	LC1D95B7	18		
	19	LC1D95BD	18		
GV4PB80S	18	LC1D95FE7	18		
	19	LC1D95M7	18		
GVAE11	18	LC1D95P7	18		
	19	LRD3361	19		
	20	LRD3363	19		
GVAM11	20	LRD3365	18		
L			19		
LC1D115B7	18	LRD340	18		
	19		19		
LC1D115BD	18				
	19				

Legal information

The information provided in this Catalog contains description of Schneider Electric products, solutions and services ("Offer") with technical specifications and technical characteristics of the performance of the corresponding Offer.

The content of this document is subject to revision at any time without notice due to continued progress in methodology, design and manufacturing.

To the extent permitted by applicable law, no responsibility or liability is assumed by Schneider Electric and its subsidiaries for any type of damages arising out of or in connection with (i) informational content of this Catalog not conforming with or exceeding the technical specifications, or (ii) any error contained in this Catalog, or (iii) any use, decision, act or omission made or taken on basis of or in reliance on any information contained or referred to in this Catalog.

SCHNEIDER ELECTRIC MAKES NO WARRANTY OR REPRESENTATION OF ANY KIND, WHETHER EXPRESS OR IMPLIED, AS TO WHETHER THIS CATALOG OR ANY INFORMATION CONTAINED THEREIN SUCH AS PRODUCTS AND SERVICES WILL MEET REQUIREMENTS, EXPECTATIONS OR PURPOSE OF ANY PERSON MAKING USE THEREOF.

Schneider Electric brand and any trademarks of Schneider Electric and its subsidiaries referred to in this Catalog are property of Schneider Electric or its subsidiaries. All other brands are trademarks of their respective owners.

This Catalog and its content are protected under applicable copyright laws and provided for informative use only. No part of this Catalog may be reproduced or transmitted in any form or by any means (electronic, mechanical, photocopying, recording, or otherwise), for any purpose, without the prior written permission of Schneider Electric.

Copyright, intellectual, and all other proprietary rights in the content of this Catalog (including but not limited to software, audio, video, text, and photographs) rests with Schneider Electric or its licensors. All rights in such content not expressly granted herein are reserved. No rights of any kind are licensed or assigned or shall otherwise pass to persons accessing this information.

Life Is On



Learn more about our products at www.se.com

The information provided in this documentation contains general descriptions and/or technical characteristics of the performance of the products contained herein. This documentation is not intended as a substitute for and is not to be used for determining suitability or reliability of these products for specific user applications. It is the duty of any such user or integrator to perform the appropriate and complete risk analysis, evaluation and testing of the products with respect to the relevant specific application or use thereof. Neither Schneider Electric nor any of its affiliates or subsidiaries shall be responsible or liable for misuse of the information contained herein.

Design: Schneider Electric
Photos: Schneider Electric

Schneider Electric Industries SAS

Head Office
35, rue Joseph Monier - CS 30323
F-92500 Rueil-Malmaison Cedex
France

DIA2ED2230101EN
March 2024 - V1.0