

# Conext™ XW+ Multi-Cluster Power System

## Planning Guide

975-0648-01-01 Rev B  
06-2016

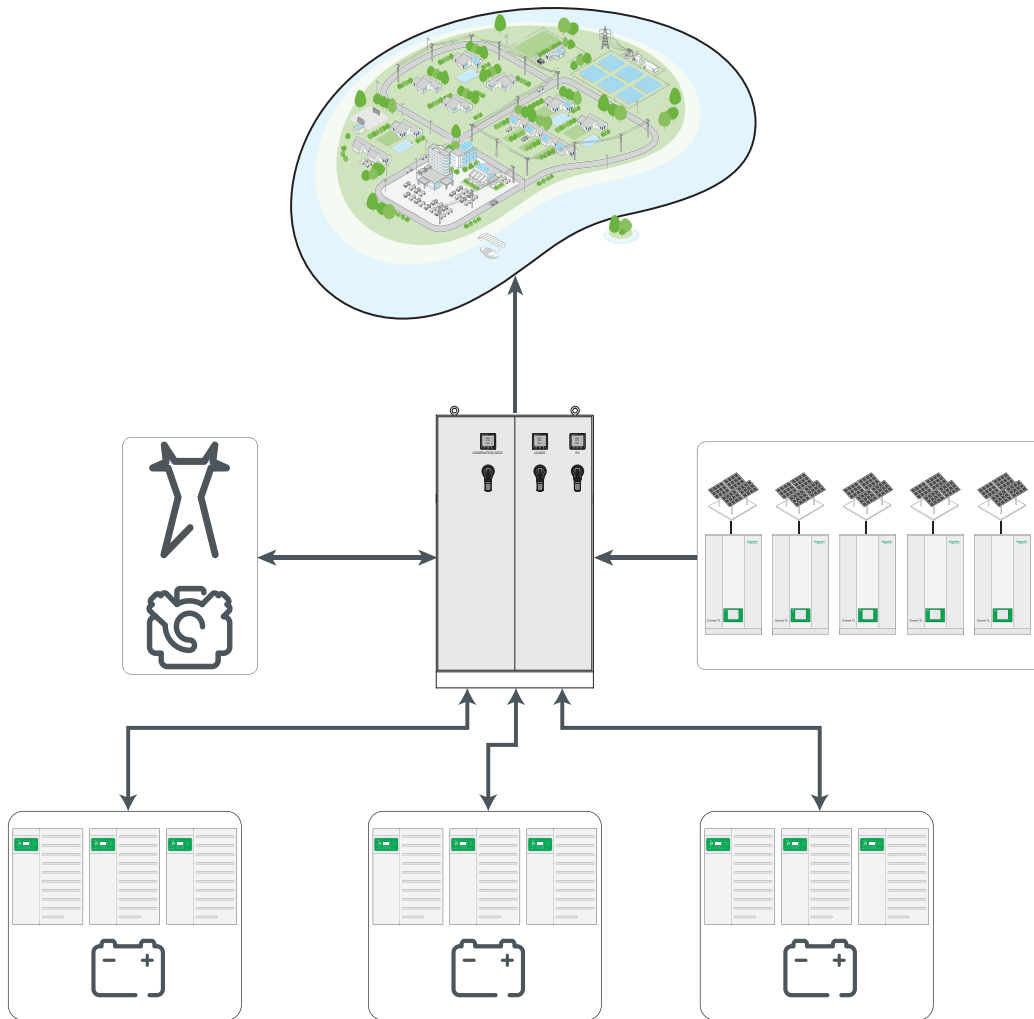

Copyright © 2014-2016 Schneider Electric. All Rights Reserved. All trademarks are owned by Schneider Electric Industries SAS or its affiliated companies.

### **Exclusion for Documentation**

UNLESS SPECIFICALLY AGREED TO IN WRITING, SELLER

(A) MAKES NO WARRANTY AS TO THE ACCURACY, SUFFICIENCY OR SUITABILITY OF ANY TECHNICAL OR OTHER INFORMATION PROVIDED IN ITS MANUALS OR OTHER DOCUMENTATION;

(B) ASSUMES NO RESPONSIBILITY OR LIABILITY FOR LOSSES, DAMAGES, COSTS OR EXPENSES, WHETHER SPECIAL, DIRECT, INDIRECT, CONSEQUENTIAL OR INCIDENTAL, WHICH MIGHT ARISE OUT OF THE USE OF SUCH INFORMATION. THE USE OF ANY SUCH INFORMATION WILL BE ENTIRELY AT THE USER'S RISK; AND

(C) REMINDS YOU THAT IF THIS MANUAL IS IN ANY LANGUAGE OTHER THAN ENGLISH, ALTHOUGH STEPS HAVE BEEN TAKEN TO MAINTAIN THE ACCURACY OF THE TRANSLATION, THE ACCURACY CANNOT BE GUARANTEED. APPROVED CONTENT IS CONTAINED WITH THE ENGLISH LANGUAGE VERSION WHICH IS POSTED AT [HTTP://SOLAR.SCHNEIDER-ELECTRIC.COM](http://solar.schneider-electric.com).

**Document Number:** 975-0648-01-01    **Revision:** Rev B    **Date:** 06-2016

**Contact Information:**<http://solar.schneider-electric.com>

Please contact your local Schneider Electric Sales Representative or visit our website at:

<http://solar.schneider-electric.com/tech-support/>

**Limited Circulation. Not for public release.**

# About This Guide

## Purpose

The purpose of this Planning Guide is to provide explanations for designing a Conext™ XW+ Multi-Cluster Power System using the Conext XW+ inverter/charger and other power devices like the Conext TL, Conext RL, Conext CL, Conext ComBox, MPPT Solar Charge Controllers and Balance of System (BOS) components.

## Scope

The Guide provides general planning information and design considerations. It does not contain specific instructions on how to build a Multi-Cluster Power System but rather it contains supportive information on design concepts.

The information provided in this guide does not modify, replace, or waive any instruction or recommendations described in the product installation and owner's guides including warranties of Schneider Electric products. Always consult the installation and owner's guides of a Schneider Electric product when installing and using that product in a Conext XW+ Multi-Cluster Power System.

For help in designing a power system contact your Schneider Electric Sales Representative or visit the Schneider Electric website for more information at <http://solar.schneider-electric.com>.

## Audience

The Guide is intended for system integrators or engineers who plan to design a Conext XW+ Multi-Cluster Power System using Schneider Electric equipment. The information in this manual is intended for qualified personnel. Qualified personnel have training, knowledge, and experience in:

- Analyzing application needs and designing PV-Hybrid Systems that include a generator.
- Installing electrical equipment and PV power systems (up to 1000 V).
- Applying all applicable installation codes.
- Analyzing and reducing the hazards involved in performing electrical work.

This Guide is focused on the performance and design of Multi-Cluster Power Systems. It is expected that the reader has prior knowledge of performances and features of other Schneider Electric products which are installed and integrated into the system. All of this information are found in the following documents:

- *Conext XW+ Owner's Guide*: 975-0713-01-01 and 975-0240-01-01
- *Conext XW+ Installation Guide*: 975-0714-01-01 and 975-0239-01-01
- *MPPT Charge/Controller Owner's Guide*: 975-0400-01-01 and 975-0560-01-01
- *AGS Owner's Guide*: 975-0307-01-01
- *Battery Monitor Owner's Guide*: 975-0691-01-01
- *Xanbus Network Sizing Guide*: 975-0646-01-01
- *Multi-Unit Power System Design Guide*: 975-0739-01-01
- *AC Coupling Solution Guide*: 976-0240-01-01

## Organization

This Guide is organized into:

Chapter 1, "Introduction"

Chapter 2, "Electrical Architecture"

Chapter 3, "Design Concepts"

Appendix A, "AC Combiner Box"

Appendix B, "75 kVA Power Systems Wiring"

## Conventions Used

The following conventions are used in this guide.

### **DANGER**

DANGER indicates an imminently hazardous situation, which, if not avoided, will result in death or serious injury.

### **WARNING**

WARNING indicates a potentially hazardous situation, which, if not avoided, can result in death or serious injury.

### **CAUTION**

CAUTION indicates a potentially hazardous situation, which, if not avoided, can result in moderate or minor injury.

### **NOTICE**

NOTICE indicates important information that you need to read carefully.

## Related Information

You can find more information about Schneider Electric as well as its products and services at <http://solar.schneider-electric.com>.



# Contents

## 1 Introduction

Introduction to Multi-Cluster Hybrid Power Systems	1-2
Typical Applications for a Battery Based Hybrid Power System	1-2
Multi-cluster Based Modular Power System	1-3
Benefits of a Modular System	1-4
Building Blocks of a Modular System	1-5

## 2 Electrical Architecture

Introduction	2-2
The Difference Between DC Coupling and AC Coupling	2-2
Choosing Between AC, DC, or Hybrid Coupling	2-4
Analyzing the Load Profile	2-5
Examining the Location	2-6
Studying Usage Ratio of Peak PV kilowatts to Peak Load kilowatts	2-7
Integrating with Other Energy Sources	2-7
Integrating Grid and Backup Generator	2-7
Choosing Retrofit or New Installation	2-8
Xanbus Network Size	2-8
Accessories for a Multi-Cluster System	2-8

## 3 Design Concepts

Introduction	3-2
Power Ratings of the System	3-3
External Contactor	3-4
Multiple Battery Banks	3-9
Multi-Cluster Power System Architecture	3-12
Off Grid AC-Coupled Architecture Theory of Operation	3-13
Grid Tie with Backup DC-Coupled Architecture Theory of Operation	3-16
Multi-Cluster Power System Limitations and Behavior	3-18
76.5 kVA Off Grid System for IEC using AC-Coupled PV	3-19
Components or Bricks	3-19
64.8kVA Grid Tie with Backup System using DC-Coupled PV	3-22
Components or Bricks	3-23

**A AC Combiner Box**

Introduction ----- A-2  
AC Combiner Box Control Schematic ----- A-3  
AC Combiner Box - 9 for North America----- A-4  
AC Combiner Box - 9 for IEC----- A-5  
List of Components from Schneider Electric to Build the AC Combiner Box ----- A-6

**B 75 kVA Power Systems Wiring**

76.5kVA Off Grid System for IEC using AC-Coupled PV Wiring Diagram----- B-3  
64.8kVA Grid Tie with Backup System using DC-Coupled PV Wiring Diagram----- B-4

# 1

## Introduction

Chapter 1 contains general information about:

- Introduction to Multi-Cluster Hybrid Power Systems
- Typical Applications for a Battery Based Hybrid Power System
- Multi-cluster Based Modular Power System

## Introduction to Multi-Cluster Hybrid Power Systems

Battery-based hybrid power systems have a huge potential to address the power needs of remote communities or small-scale commercial facilities. Battery storage as a central element in the power system allows many applications to:

- reduce dependency on diesel
- utilize solar power
- provide backup power from unreliable grid and
- offset utility grid consumption during peak hours

The Conext XW+ Multi-Cluster Power System has been developed to enable a system designer to build a modular power system using multiple Conext XW+ inverter/chargers and the family of Conext power conversion products and accessories.

### Cluster

A cluster is a group of power conversion devices including battery-based inverters that are connected in parallel to a common battery bank. For small to medium sized power systems up to 36kVA, it may be possible to design a system as a single cluster. But for systems with higher power ratings, it may be required to build the system using multiple clusters to simplify balance of system (BOS), performance, and redundancy.

## Typical Applications for a Battery Based Hybrid Power System

Power systems are generally categorized by how power is generated, stored, used, and distributed in a specific application. The types of power systems that are referred to in this guide are:

1. **Village/Community Electrification** - mainly residential dwellings isolated from the utility grid with a local grid typically formed using a diesel generator as a primary energy source. The goal is to reduce the dependency on the diesel generator for power by storing energy in batteries and using battery-based inverters to provide electricity allowing the diesel generator to be turned off or down for maintenance. Solar energy can also be used to charge batteries especially during seasons when sun exposure is strong.
2. **Commercial Off Grid** - mainly farms, long term seasonal resorts, or “containerized” power systems. The goal is similar to community electrification; that is to reduce dependency on diesel generators for power.
3. **Commercial Grid Tie with Backup application** - mainly buildings in urban settings where the utility grid is available. The main goals are to mitigate the effects of interruptions by ensuring continuity of electrical service during brownouts and blackouts and to reduce utility grid consumption when the price for energy is high. In jurisdictions where the utility company applies tier pricing, solar energy that has been stored during the day can be used up during peak hours.

## Multi-cluster Based Modular Power System

A modular system is based on the concept of modular design where a whole system is made up of individual components that are independent and self-contained by themselves.

A multi-cluster based modular power system builds on the concept of modular design where a 70 kVA capacity power system consists of smaller clusters that can functionally exist on their own. Modules are known as bricks or clusters. These clusters can either work collectively or individually to allow the whole system to compensate for down times such as routine maintenance, emergency repairs, and energy demand spikes.

For example, nine 8.5 kVA inverters in a modularized system of three clusters of three inverters can do the job of a single 75 kVA industrial-sized inverter.

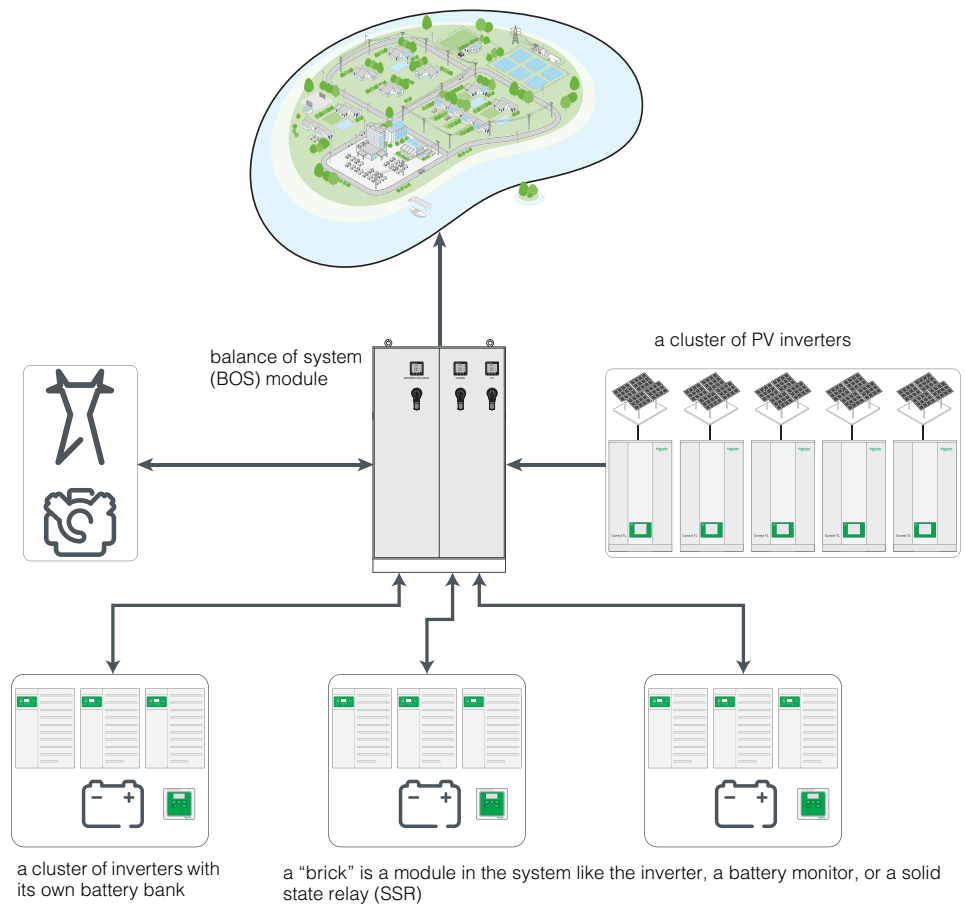



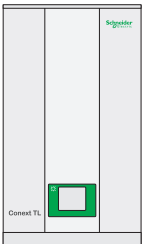









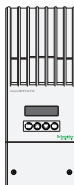

**Figure 1-1** Multi-Cluster Modular Power System











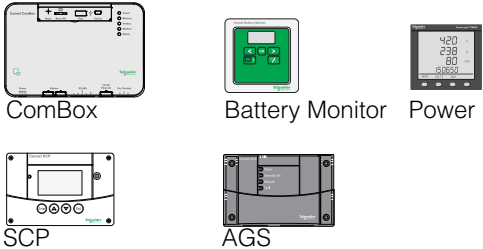



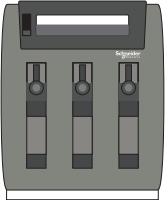

## Benefits of a Modular System

- **Reliability and redundancy** – failure of one unit does not cause a total system shutdown as with little re-configuration the system can be made to operate at reduced capacity
- **Logistical simplicity** – lighter weight products can be easily handled by two people without special lifts are especially essential for installations in remote areas
- **Simpler installation** – modularity allows installations to be spread, grouped, and wired easily
- **Reusability** – the same bricks can be reconfigured in various system sizes like: six XW+ 8548 for 51kVA, and nine XW+8548 for 76.5kVA
- **Low voltage (48 V) battery banks** – smaller modular bricks allow easy integration of batteries at 48V which do not require separate rooms or specialized training for high-voltage battery maintenance
- **Scalability** – suitable for future expansion for allowing incremental scaling
- **Easy to replace** – easy replacement of single units that may require repair or service

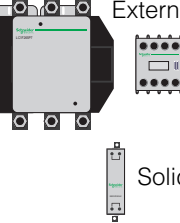

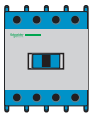

## Building Blocks of a Modular System

The following Schneider Electric power devices are the building blocks (also called bricks) of a modular system.

Brick	Description	Product Number
<b>Power Conversion Devices</b>		
 <p data-bbox="399 512 716 569">Conext XW+ Inverter/Charger North America (NA) and IEC</p>	Conext XW+ 8548 E 	865-8548-61
	Conext XW+ 6848 NA 	865-6848-01
 <p data-bbox="399 768 716 800">Conext TL three-phase Inverter</p>  <p data-bbox="621 890 764 974">Conext RL single-phase Inverter for IEC 230/400VAC</p>	Conext TL 8000 E 	PVSNVC8000
	Conext TL 10000 E 	PVSNVC10000
	Conext TL 15000 E 	PVSNVC15000
	Conext TL 20000 E 	PVSNVC20000
	Conext RL 3000 E 	PVSNVC3000
	Conext RL 4000 E 	PVSNVC4000
	Conext RL 5000 E 	PVSNVC5000
 <p data-bbox="358 1115 756 1146">MPPT 80 600 Solar Charge Controller</p>  <p data-bbox="561 1226 773 1278">MPPT 60 150 Solar Charge Controller</p>	Conext MPPT 60 150 	865-1030-1
	Conext MPPT 80 600 	865-1032

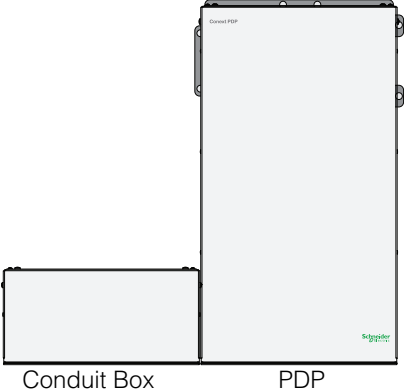
Brick	Description	Product Number
<b>Monitoring and Communication Devices</b>		
 <p>ComBox      Battery Monitor      Power Meter</p> <p>SCP      AGS</p>	<p>Conext ComBox </p> <p>Conext Battery Monitor </p> <p>Energy and Power Meters</p> <ul style="list-style-type: none"> <li>• PowerLogic PM8XXX </li> <li>• EM35XX </li> <li>• Acti 9 iEM32xx </li> <li>• PowerLogic PM5XXX </li> </ul> <p>Conext SCP </p> <p>Conext AGS </p>	<p>865-1058</p> <p>865-1080-01</p> <ul style="list-style-type: none"> <li>• PM8000</li> <li>• EM3500</li> <li>• A9MEM3210-75</li> <li>• PM5000</li> </ul> <p>865-1050-01</p> <p>865-1060-01</p>
<b>Balance of Systems (BOS)</b>		
 <p>Battery Fuse Combiner Box</p> <p>for IEC applications only</p>	<p>Conext Battery Fuse Combiner Box 250 </p>	<p>865-1031-01</p>
 <p>External Contactor</p> <p>Auxiliary Contactor</p> <p>Solid State Relay</p>	<p>TeSys F External Contactor </p> <p>TeSys K Auxiliary Contactor </p> <p>Solid State Relay (SSR) </p>	<p>LC1F400FE7</p> <p>LADN22</p> <p>SSRD CDS20A1</p>
 <p>External Transfer Switch for Single-phase configuration</p>	<p>TeSys LC1 4P Contactor </p>	<p>LC1D80008M5</p> <p>LC1D80008U6</p> <p>LC1D80008P7</p> <p>LC1D80008M5</p> <p>LC1D80008G6</p>



Brick	Description	Product Number
<p>For UL<sup>®</sup>-certified applications only</p>  <p>Conduit Box      PDP</p>	Conext XW+ Power Distribution Panel (PDP) 	865-1015-01
	Conext XW+ PDP Without AC Breakers 	865-1014-01
	Conext Three-Phase Breaker Kit for XW+ PDP 	865-1315-01
<b>Commissioning and Configuration Device</b>		
Conext Configuration Tool	Configuration device and program	865-1155-01

**Important:** This is not an exhaustive list. You may find some components in the following illustrations and wiring diagrams which are not listed in the table. Please go to <http://solar.schneider-electric.com> for more information and connect with a Schneider Electric professional who will be able to provide further guidance, advice, and recommendations about the power system you are planning to build.

•THIS PAGE INTENTIONALLY BLANK•

# 2

## Electrical Architecture

Chapter 2 contains information about:

- The Difference Between DC Coupling and AC Coupling
- Choosing Between AC, DC, or Hybrid Coupling

## Introduction

The electrical architecture for Conext Multi-Cluster Hybrid Power Systems refers to the electrical connection of the various components and the choice of components to be used in building the system. The selection of the electrical architecture is based on analyzing the loads, the need for energy storage, and the capacity of installed PV, while optimizing capital and operational expenditures.

Related to this, one important decision regarding the electrical architecture is the choice on how to integrate the installed PV into the power system. A choice has to be made between:

- DC-Coupled system (also known as DC coupling)
- AC-Coupled system (also known as AC coupling)
- Hybrid-Coupled system (also known as hybrid coupling)

The decision to integrate PV into the system is important in system design because it directly affects the selection of power conversion devices for the PV, the choice of balance of system (BOS) components and affects system behavior during abnormal conditions.

## The Difference Between DC Coupling and AC Coupling

In a battery-based hybrid power system solar energy can be integrated through the use of either a PV Inverter or an MPPT Solar Charge Controller. When a PV inverter is used, the AC (PV Inverter AC Output) is wired to the AC Load terminals of the battery-based inverter which is why this method is called AC coupling. DC coupling, on the other hand, uses an MPPT Solar Charge Controller which provides DC power and is wired to the battery bank and DC terminals of the battery-based inverter.

Both technologies convert power through single-stage power conversion. For example, the PV Inverter converts from DC to AC and the MPPT Solar Charge Controller from DC to DC. Typical efficiency for both device types are comparable. However, there are several factors which could influence the choice between the two architectures, namely:

- how much energy is consumed during the sunny hours of the day
- the location of PV modules and “racking”
- integration with existing energy sources and equipment

See the illustration on “AC-Coupled versus DC-Coupled Residential Power System” on page 2–3.

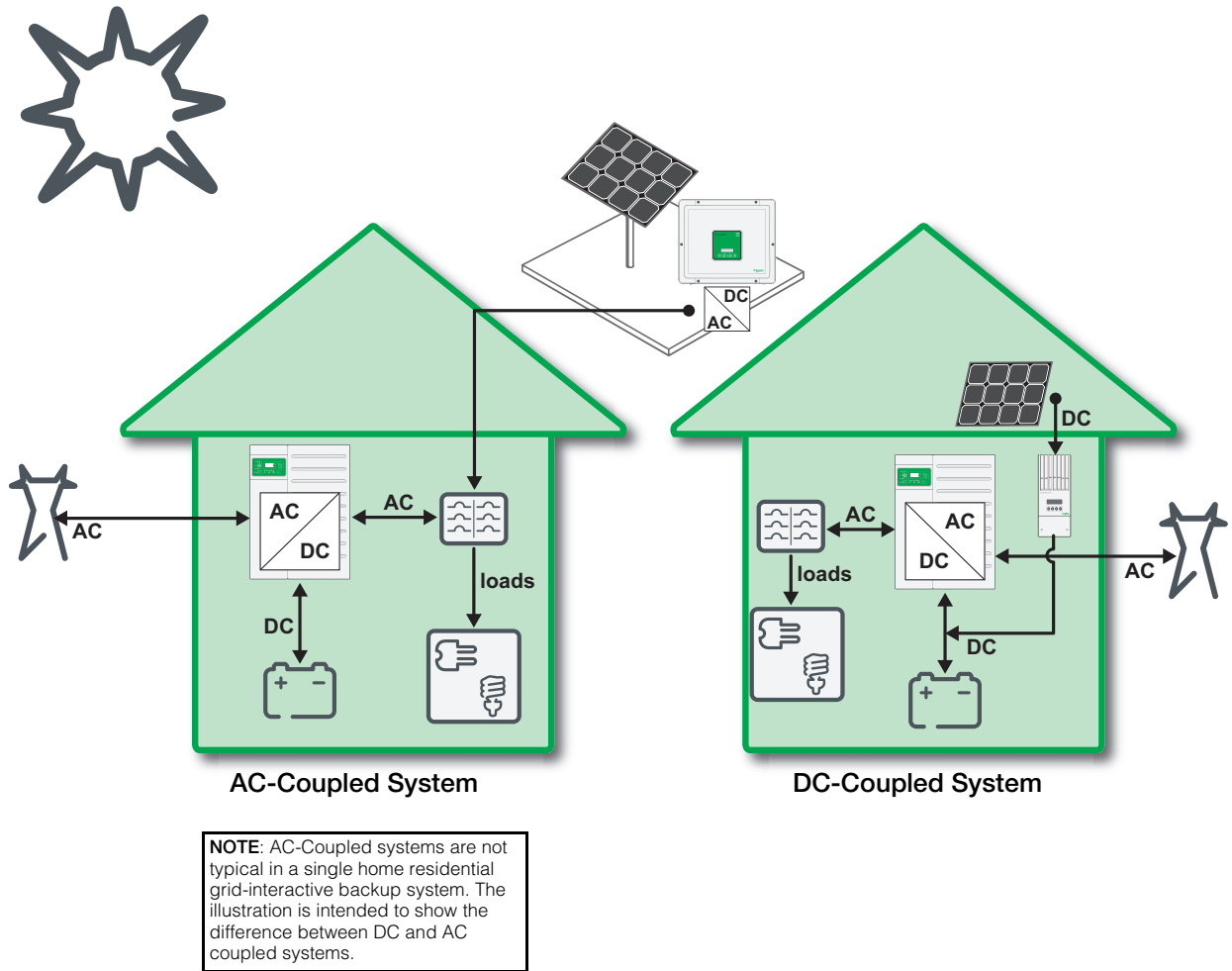

Figure 2-1 AC-Coupled versus DC-Coupled Residential Power System

## Choosing Between AC, DC, or Hybrid Coupling

Unlike the utility grid which can continually provide energy to supply the power needs of a large group of consumers, a localized off grid system or grid tie backup system must be more attuned to the power needs of a smaller subset of power consumers. Building a local power system, whether off grid or grid tie, is a big investment. Before building a local power system and deciding which type of coupling is best such as by AC, DC, or a hybrid of both, there are other things to consider aside from the financial cost. Factors like intended use, performance, ease of installation, reliability, and size are also needed to aid in choosing the appropriate type of electrical coupling.

The following factors influence your choice between DC, AC, or hybrid coupling:

- load profile
- location
- usage ratio of peak PV kilowatts to peak load kilowatts
- other available energy sources
- retrofit (upgrade) or new installation
- system size
- application of peak load shaving

## Analyzing the Load Profile

The load profile is typically a snapshot of the power needs and energy usage during a 24 hour period. It provides two valuable information, the peak load on the system and when it happens, total energy usage per day, and how much coincides with the sunny hours of the day.

The following graphs show different load profiles in two different applications.

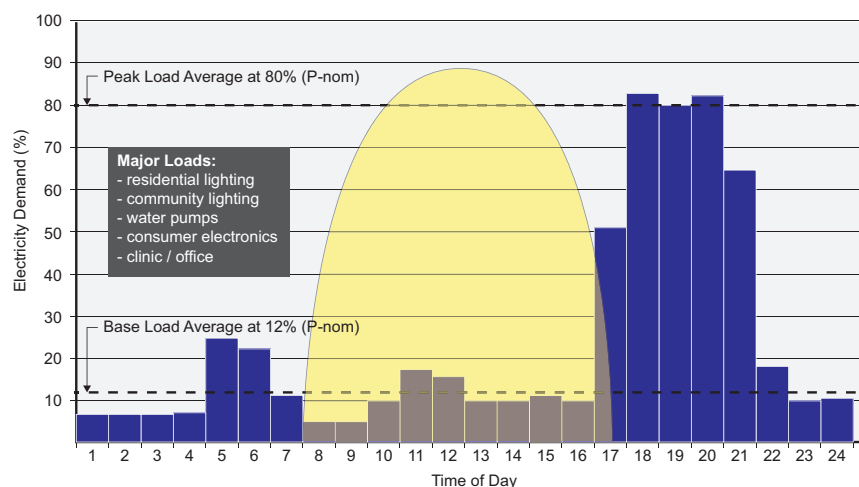
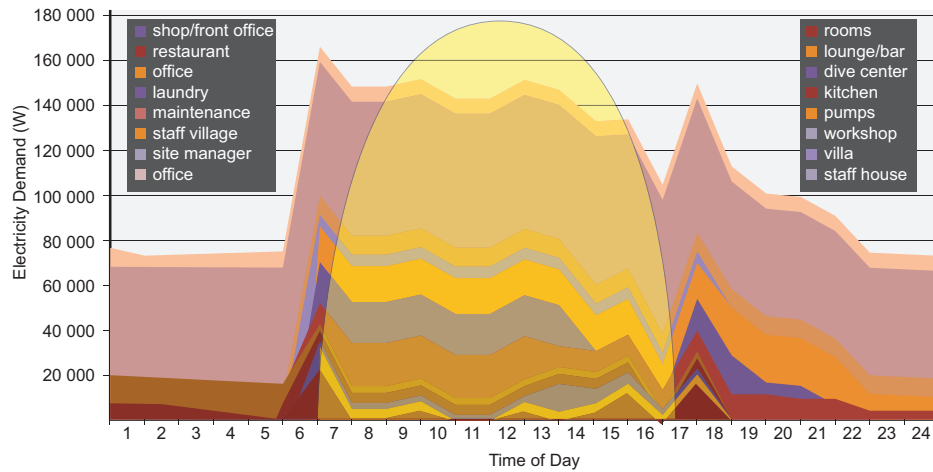

**Figure 2-2** Remote Community in South East Asia<sup>a</sup>

a.Source: Renewable Energy Option for Sustainable Rural Electrification in Indonesia, Chayun Budiono

In Figure 2-2, 80% of the energy is used during peak times for four hours between 17:00 to 21:00 and 12% during non peak times for 20 hours. Figure 2-2 shows a graph of a typical remote residential community which consumes a majority of energy during the evening hours. Collectively, the lights are a major load and some loads are basic electronics such as TV and radio. In such a community electrification project, the load profile does not coincide with the sunny hours of the day (from 8:00 to 17:00). Therefore, all the energy that will be consumed later must be stored in batteries initially by harvesting solar energy during day time. If a DC-Coupled configuration is chosen, the energy is stored into batteries in a single stage conversion. And, if an AC-Coupled configuration is chosen, the energy will have to be converted to AC and then again from AC to DC by the battery inverter. This results in two stages of power conversion which is a less efficient process.

In contrast, Figure 2-3 shows a commercial installation such as a hotel resort which consume more power during the day and decreasing as day turns to night. The load-profile coincides with the sunny hours (from 8:00 to 17:00) of the day. In this case, if an AC-Coupled configuration is chosen, the energy harvested from the PV is directly converted to AC and used by loads which results in a single stage conversion. If a DC-Coupled configuration is chosen, the energy is converted from the PV to batteries and from batteries to the loads, resulting in a less efficient two stage conversion.



**Figure 2-3** Hotel Resort in Africa<sup>a</sup>

a. Source: VoltZon Vamizi Island Resort

Analyzing load profiles such as these helps in determining what coupling system is appropriate to optimize hardware selection and thereby capital investment. See “Power Ratings of the System” on page 3–3.

## Examining the Location

The locations of the electrical room where the batteries are stored and where the PV is installed play a significant role in choosing between a DC-Coupled and AC-Coupled system. For example, if a community or resort desires to install PV but wants to leverage the roof space of each villa or home and reuse the AC distribution network, an AC-Coupled system will simplify installation, wiring, and BOS. However, if the PV can be installed at a distance but co-located, DC or AC-Coupled systems should be considered.

It is typically thought that if PV arrays were located at a distance of more than 20 meters away, this made a compelling case for using an AC-Coupled system to avoid running higher gauge PV wires. This case point is outdated and only applicable when comparing DC-Coupled MPPT chargers that accept 150 to 200 VDC inputs with PV Inverters that accept up to 600 to 1000 VDC. Newer models of MPPT chargers like the Conext MPPT 80 600 Solar Charge Controller can accept higher voltage strings and can benefit from the same reduced BOS, just like the PV inverters.

Generally speaking, the benefits of an AC or DC-Coupled system are the same when the capacity of the power system is less than 40 kilowatts (kVA). When the capacity exceeds 40 kVA then an AC-Coupled system is advised when the PV array is located away from XW+ inverter and battery. However, in case of AC coupling with a generator, a provision shall be made to install a disconnect device to protect the generator from being back fed by the AC PV system.



## Studying Usage Ratio of Peak PV kilowatts to Peak Load kilowatts

If loads are to be operated continuously for 24 hours such as a pumping station but PV energy is only available for an average of six hours, the PV array peak power capacity has to be sized more than four times the average load demand in order to store enough energy for non-sunny hours.

### Example

A relay station in the Middle East is converted to solar powered instead of diesel run to save cost from refueling and periodic maintenance of the diesel generator. The base load is about 4.5 kVA during daytime and peak load is about 6 kVA at nighttime for a total daily consumption of 120 kWh. However, the PV is available only for six hours each day. Therefore, all the energy needed daily should be harvested and stored during daytime for later use at nighttime. A PV array size of 24 kVA is required to harvest all energy and store the surplus not drawn by the 4.5 kVA daytime load. In such a system, the ratio of PV kVA to peak load kVA is 24 to 6 (that is, 4 times). If an AC-Coupled solution is used, a 24 kVA PV inverter is needed and an equivalent 24 kVA battery inverter is also needed to convert and store the PV energy into the batteries. On the other hand, a DC-Coupled solution where the MPPT chargers could be sized to 24 kVA while the battery inverter is sized to 6 kVA peak load, there is already cost savings on the extra equipment as well as efficiency from a single stage power conversion process.

## Integrating with Other Energy Sources

Often there is a need to integrate more than one energy source to complement the PV such as wind, micro-hydro, or biogas plants. It is important to identify the characteristics of other energy sources, most significantly, these two aspects:

- **generated power** is capable to be DC-Coupled or AC-Coupled
- **type of regulation available** if DC-Coupled (load-diversion controller) or AC-Coupled (frequency shift power injection)

## Integrating Grid and Backup Generator

The XW+ inverter/charger has two AC ports which allow for integrating two AC sources as grid forming devices in the power system. When an external contactor scheme is used (see “External Contactor” on page 3–4) to achieve higher pass-through capacity, an external source changeover mechanism is required to switch the AC source from grid to generator.

When the grid (or backup generator or loads) causes the power systems' AC voltage and frequency to be distorted or to fluctuate, it is recommended to avoid an AC-Coupled system since the PV inverters coupled to the AC bus use this voltage and frequency as a reference to couple and produce power. In such a case, poor quality voltage and frequency may result in reduced energy production from the PV.

When sizing a generator for the power system, it is recommended to choose a minimum size that is more than the power rating of the loads including the power rating for charging XW+ system.

## Choosing Retrofit or New Installation

Consider system size and type when deciding which coupling system to implement. Here are some examples:

- Existing Installation** For an existing commercial installation with grid-tie PV, adding a battery inverter results in an AC-Coupled system.
- New Installation** If the new battery-based system is for a commercial grid tie backup system and is a candidate for FIT, then you can consider choosing either an AC-Coupled system or DC-Coupled system. If the loads coincide to the sunny hours of the day, an AC-Coupled system may be suitable. Note that in applications where grid outages happen more frequently, the battery inverter may not be able to regulate the power of the PV inverter by using the frequency shift method since the PV inverter profile would be locked to the country code and anti-islanding scheme for the country. There are several ways to tackle this challenge. One is by installing an external anti-islanding protection switch and configuring the PV inverter for off grid mode or by isolating the PV inverter completely during a grid outage. Alternatively, a DC-Coupled system can be used especially if the objective is to store the energy during daytime to offset consumption during the nighttime hours.
- Grid-interactive or smart grid systems** Grid-interactive and smart grid backup systems do not necessarily sell power back to the grid. These power systems are prioritized to self-consume the energy they produce.
- If the new system is a commercial grid-interactive backup system and is under a tiered two-part tariff program with a utility grid operator, then consider a DC-Coupled system. Consider the same when your goal is for self-consumption and selling to the grid is not a priority.

## Xanbus Network Size

The Xanbus network which is based on CAN bus communication protocols interconnects the various Conext and/or Xanbus-enabled devices. The Xanbus network allows communication between the devices but has limited bandwidth in regards to the amount of data that can be exchanged through it.

As a result, when designing a power system that is interconnected via a Xanbus network, always follow the guidelines recommended in the *Xanbus Network Sizing Guide* (document part number: 975-0646-01-01). Ignoring the recommendations may yield an unreliable system.

## Accessories for a Multi-Cluster System

When used with a Multi-Cluster system, the Conext SCP shall only be used to set the system in operating or standby modes. It shall not be used for device configurations. Use the Conext Configuration Tool for commissioning and configuring the larger Multi-Cluster system.

# 3

## Design Concepts

Chapter 3 contains information about:

- Power Ratings of the System
- External Contactor
- Multiple Battery Banks
- Multi-Cluster Power System Architecture
- 76.5 kVA Off Grid System for IEC using AC-Coupled PV
- 64.8kVA Grid Tie with Backup System using DC-Coupled PV

## Introduction

A Conext Multi-Cluster Hybrid Power System possesses an electrical architecture with a few vital components and inverter/charger behaviors which are unique to a multiple unit system and differs significantly from single unit operation.

Understanding these behaviors during the early design stage helps in making informed decisions. The following design concepts are discussed:

- Ratings of the system (see page 3-3)
- External contactor and power conversion through a single AC-port (see page 3-4)
- Multiple battery banks (see page 3-9)

## Power Ratings of the System

Sizing and selecting the number of modular battery inverters necessary to build a hybrid system is an important first step in the system design after analyzing the load profile (see “Analyzing the Load Profile” on page 2–5). The following tables of XW+ cluster power ratings will assist you in determining the power capability of your Conext XW+ Multi-Cluster System.

**Table 3-1** Three-Phase Conext XW+ Multi-Cluster System Power Ratings IEC

XW+ Unit	XW+ 8548 model			
	continuous (kVA)		peak (kVA) @25 C (30-min)	Grid-Sell (kVA)
	@25 C	@40 C		
3-unit	20.4	18.0	25.5	18.0
6-unit	40.8	36.0	51.0	36.0
9-unit	61.2	54.0	76.5	54.0

### NOTICE

#### EQUIPMENT SETUP HAZARD

When designing a multi-cluster system, use the same XW+ model for all clusters. It is not advisable to mix and match XW+ models. For example, to get a 65kVA system @ 40 C, do not combine a 6-unit XW+ 8548 with a 6-unit XW+ 7048.

**Failure to follow these instructions can result in equipment damage.**

**Table 3-2** Three-Phase Conext XW+ Multi-Cluster System Power Ratings NA

XW+ Unit	XW+ 6848 model			
	continuous* (kVA)		peak* (kVA) @25 C (30-min)	Grid-Sell* (kVA)
	@25 C	@40 C		
3-unit	17.2		21.6	17.2
6-unit	34.5		43.2	34.5
9-unit	51.8		64.8	51.8

\* Continuous and grid-sell power in a three-phase multi-cluster system for North American models are limited by the 80% breaker derating rule of NEC when using a 60A breaker necessary to be used with all XW+ models. Peak power is limited by the trip characteristics of a 3P-60A QOU breaker.

# External Contactor

In a multi-cluster system an external contactor replaces the function of the internal transfer relays in the XW+ units thereby allowing for higher system power levels. The reason for that is that in a system with multiple units in parallel on one phase, using the internal transfer relays pose two main challenges, namely:

- it is not possible to ensure equal sharing of current through the parallel relays in a pass-through mode (when a generator or grid is available) as circuit impedances vary among the units, thus introducing the possibility that an upstream breaker on any one of the inverters may trip
- it is not possible to achieve an exact synchronized transfer of all the individual relays, introducing the possibility that the contacts of the last relay to open, when under heavy load will be damaged

The challenge is presented in the second scenario in the illustrations below.

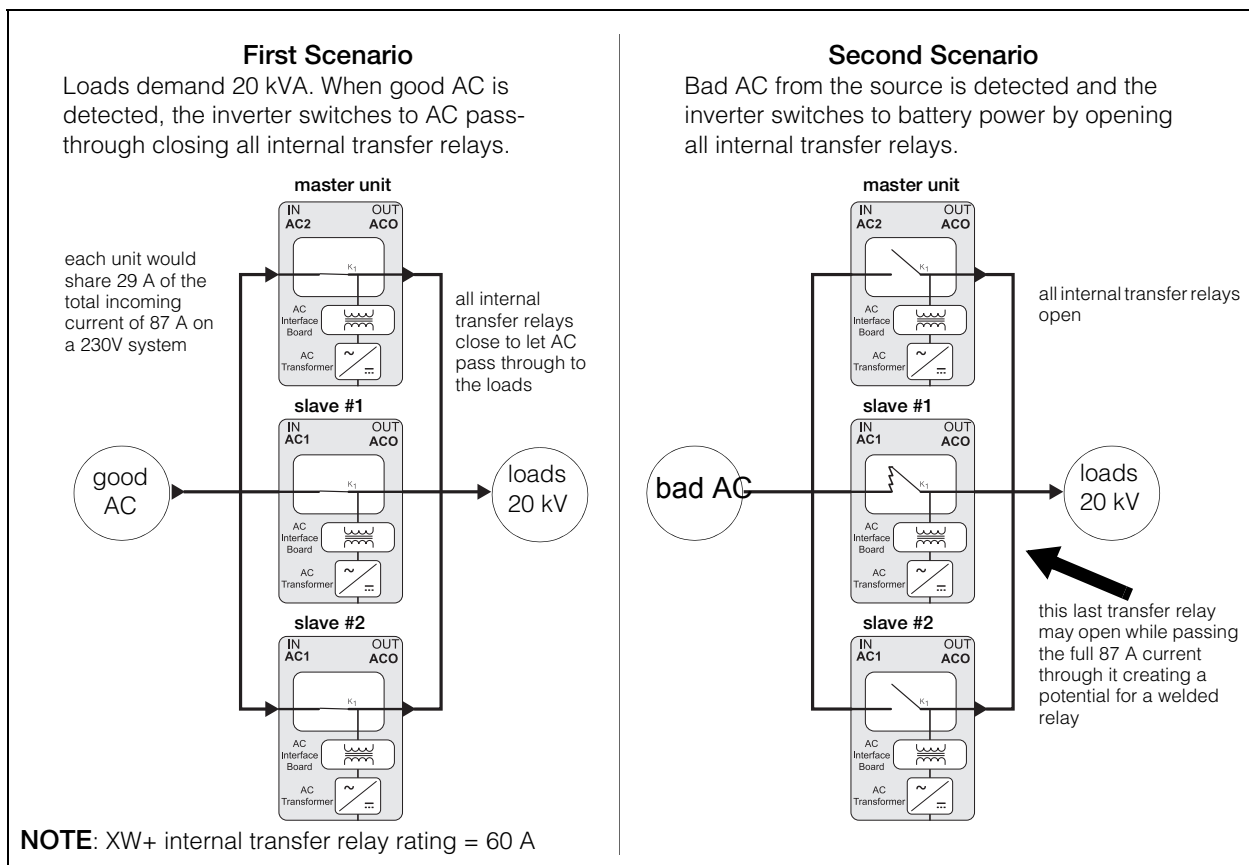

Figure 3-1 Internal Transfer Relay Limits

## When to Use an External Contactor

In the second scenario of Figure 3-1, an external contactor is used when the power system cannot rely on the performance of individual internal transfer relays of parallel XW+ inverters. If the internal transfer relays are welded, that can cause permanent damage to the product and affect the whole power system.

An external contactor should also be used instead of internal transfer relays when it can be determined in the planning stage that the transfer capacity per phase of a power system will exceed that of the inverters' individual internal transfer relay rating. For example, when six XW+ 8548 inverters are configured in three-phase configuration with two units per phase in parallel to power 36kVA loads, the calculated current per phase is 52A. This is lower than the transfer relay rating of 60A of a single XW+ inverter. Therefore, it is considered safe to rely on the internal transfer relays. However, nine XW+ 8548 inverters which are configured in three-phase configuration to power 50kVA loads have a calculated current per phase of 72A. This calculated value puts it above the internal transfer rating of 60A. Therefore, in this case the use of an external contactor is recommended.

The XW+ units can be configured to operate using an external contactor by running the Multi-Cluster configuration wizard on the Conext Configuration Tool.

### **NOTICE**

#### **CONFIGURATION SETTING HAZARD**

Enable the External Transfer setting only in conjunction with the use of an external contactor for a three-phase system and not a single-phase system.

**Failure to follow these instructions can cause equipment damage.**

Using an external contactor has advantages such as:

- it enables a system pass-through capacity higher than the limits of the internal transfer relay ratings
- it simplifies electrical wiring because all power conversions from inverting, charging, and grid-selling happen through a single AC port

With an external contactor, the loads are wired to an AC bus to which the XW+ units are also connected. The generator (or grid) source is connected to the AC bus through an external contactor. The loads are powered through the XW+ units when the contactor is open. When an AC source is qualified, the external contactor closes and the XW+ units go into charge mode while the loads are powered from the AC source. For an illustration, see Figure 3-2, "External Contactor Behavior" on page 3–6.

Additional details on the use and limitations of using an external contactor can be found in the *Multi-Unit Power System Design Guide*: 975-0739-01-01.

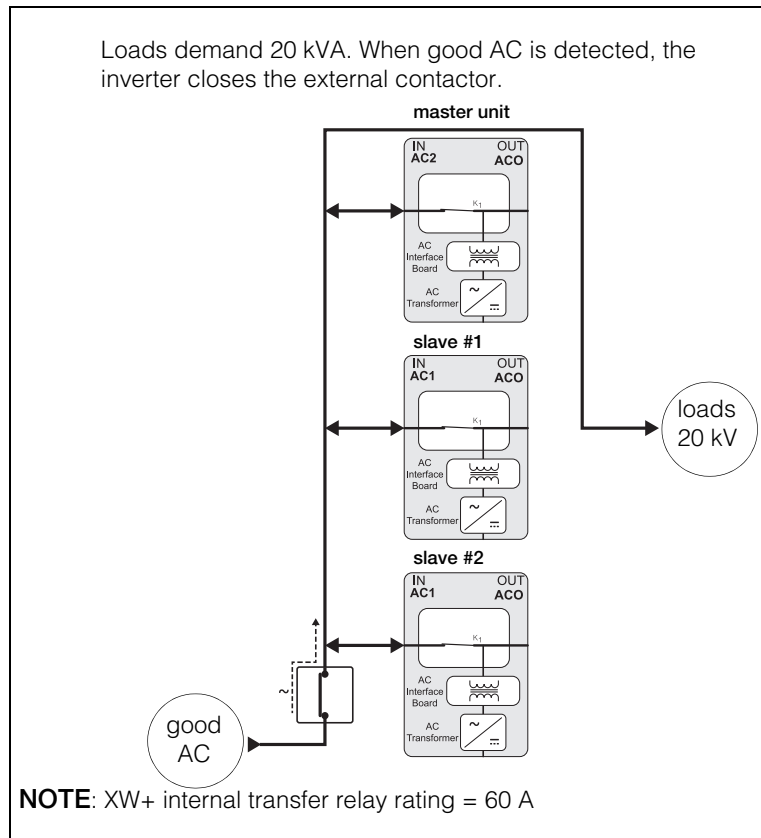

**Figure 3-2** External Contactor Behavior

**Application**

The next illustration on Figure 3-3 on page 3-7 shows how an external contactor is wired between an AC source such as grid (or generator) and XW+ multiple unit systems. The three XW+ inverters, configured as Phase Masters of L1, L2, and L3 respectively, are responsible for qualifying and synchronizing the voltage, frequency, and phase before the external contactor is closed. Whenever the voltage, frequency, or phase of the incoming AC source is found to be out of range, the AC source is disqualified and the external contactor is opened.

In multi-cluster mode, only one AC input port is used for power flow. For Master units, the AC2 input port (**GEN (AC2)**) must be used and for Slave units the AC1 input port (**GRID (AC1)**) is used. Only the inverter/charger units configured as Masters require an additional voltage sense line on the AC2 input port (**GEN (AC2)**). See Figure 3-3, “Typical Three-Phase Application Wiring for Master Devices” on page 3-7 for wiring information.

	Master	Slaves
<b>AC1 ports</b>	used for grid/genset voltage sensing and synchronization	used for power flow
<b>AC2 ports</b>	used for power flow	not used



The external contactor is controlled by the L1 Master (also known as Phase-1 Master) XW+ using its AUX port terminal. Since the driving amps needed to trigger the coil of an external contactor could range up to 20 A, an intermediate Solid State Relay (SSR) is needed as shown in Figure 3-3. The AUX port typically provides a 12 V signal to the SSR which then provides 120/230 VAC to the contactor coil. To ensure a fail-safe system, an auxiliary contactor is installed alongside the external contactor to enable the system to monitor the state of the external contactor.

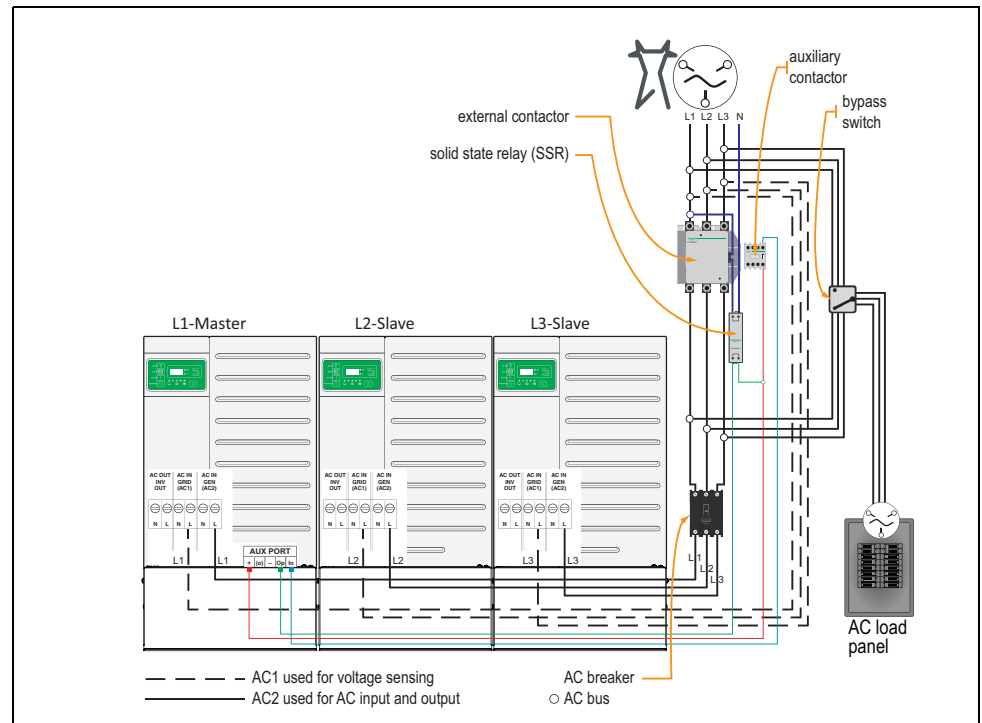

**Figure 3-3** Typical Three-Phase Application Wiring for Master Devices

The drawbacks of using an external contactor are:

- since an external transfer is used, the two AC input ports of the XW+ cannot be used to directly integrate two different AC sources. To overcome this limitation it is recommended to use an external source changeover system.
- features such as peak load shaving and generator support rely on the internal current sensors of the XW+ to sense the difference between current draw from the grid/generator and current flow to the loads which is now not possible in this scheme.

***NOTICE***

**EQUIPMENT TYPE HAZARD**

The transfer time for the external contactor to close or open is not seamless and could cause devices that are susceptible to a short period brownout to go through a power cycle.

Typical transfer times for when the external contactor closes is less than 100 milliseconds while when it opens is less than 200 milliseconds depending on the size of the external contactor. A hybrid multi-cluster system when primarily installed for backup applications in a commercial facility cannot replicate the functions of an online UPS (uninterruptible power system) device. Therefore, installing a properly rated UPS device for sensitive electronics is still recommended.

**Failure to follow these instructions can result in equipment damage.**

# Multiple Battery Banks

## Why set up multiple battery banks?

Many battery manufacturers recommend that in general, lead-acid based deep cycle batteries in a power system must be configured to a maximum of three battery strings in parallel. This physical limitation is based on a combination of hardware constraints, chemistries, and present technology.

Individual batteries come standard in 2-, 4-, 6-, and 12-voltage ratings with various amp-hour capacities. For systems requiring large storage capacity, 2 V cells are preferred which come typically in 1000Ah, 1500Ah, up to a maximum of 3000Ah capacities. Sizes up to 1500Ah are easily available and preferred.

**Design Scenario 1** Single 300 kVAh battery bank for a 48 V three-phase power system

300 kVAh @ 48 V is ~6000 Ah battery bank using readily available 2 V 1500 Ah batteries which requires four parallel strings of 24 batteries each. A single battery bank of four strings is difficult to install and equally difficult to maintain.

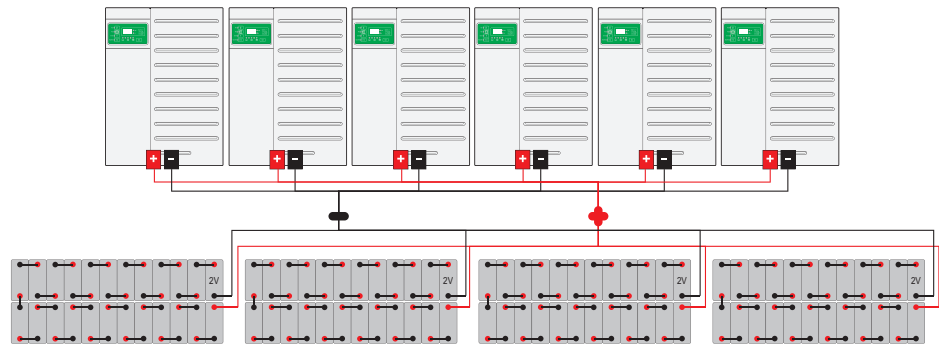

**Design Scenario 2** Multiple battery banks for a 48 V three-phase power system

Whether single battery bank or multiple battery banks, 96 pieces of 2 V 1500 Ah batteries are needed to create a 300 kVAh @ 48 V system. In design scenario 2, the batteries are split into two 3000 Ah capacity battery banks. Three XW+ inverters are configured so that each have their own battery bank.

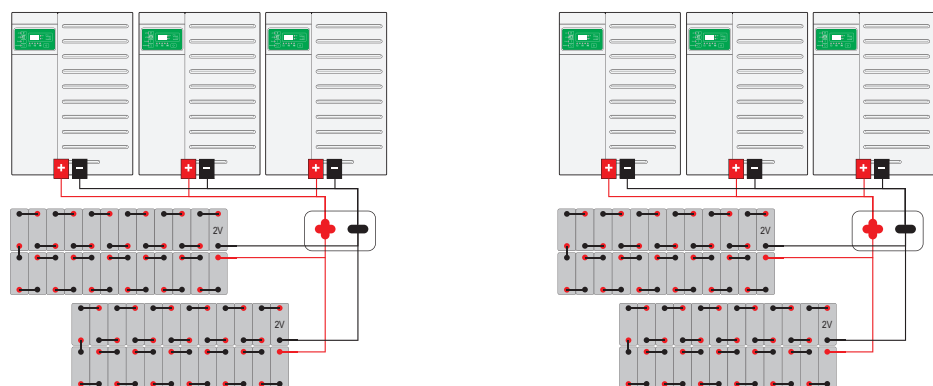

**Advantages of a multiple battery bank setup**

Splitting the battery banks into groups provides several benefits in the form of simpler installation (see 1) and improved battery performance (see 2).

1. Simplified Installation
  - since a fewer number of strings are paralleled, the necessary combiners, cables, fuses and short-circuit protectors are of lower current (amps) ratings which make them easier to install and source
  - physically, the battery banks can be spread out
  - allows scaling a system of three XWs to add another three XWs but not mixing the old and new battery banks
2. Improved Battery Life and Performance
  - better charging of batteries because charging state transitions are coordinated between fewer parallel strings
  - currents are better shared with fewer strings, thus realizing a better charging and discharging of the battery bank and avoids one string over exercised than the other

<b><i>NOTICE</i></b>
----------------------

<b>BATTERY INSTALLATION AND SELECTION HAZARD</b>
--

Always consult individual battery manufacturers for specific information details about battery brands, ratings, configuration, and installation requirements.
---

<b>Failure to follow these instructions can result in equipment damage.</b>
---

**Behavior of multiple battery banks**

When multiple battery banks are used in a system, each of the XW+ and MPPT units connected to the battery bank needs to be programmed via “DC Association”. Certain operations of charge-state-synchronization, temperature compensation, and battery faults are localized to devices connected to a battery bank.

**Charge State Synchronization** In a multiple battery bank setup, individual battery banks may not transition between charge states in a synchronized manner, thus requiring each bank to be treated individually. Therefore, devices will synchronize charge states only among the devices connected to that battery bank. For example, two battery banks are charging from the connected MPPT units. Battery Bank 1 is in bulk stage while Battery Bank 2 transitions to absorption stage by receiving more solar power from the connected MPPT units.

**Temperature Based Compensation** In large storage systems, the temperatures of battery cells can vary significantly between battery banks especially when the batteries are spread out. Therefore, XW+ and MPPT units compensate the charging voltage based on the highest temperature reported for the battery bank to which they are physically connected.

**Fault Detection** When a battery-related fault is detected in the system, only those XW+ and MPPT units that are connected to the battery bank will stop power conversion and enter into a fault state. Meanwhile, the rest of the system continues to operate.

**Energy Balancing<sup>1</sup>** With multiple battery banks, it is very likely to have the batteries diverge in state-of-charge after cycles of charge and discharge. This effect is compounded in DC-Coupled systems where the solar energy harvested by MPPT units which are connected to one battery bank is more than the others. Therefore, it is important to balance the load share between the XW+ inverters proportional to the energy stored in the batteries to which they are connected, so as to avoid a premature start of the generator. This can be achieved by enabling the Energy Balancing feature in the Advanced Settings of the XW+ unit.

### ***NOTICE***

#### **BATTERY SETUP HAZARD**

It is recommended to use separate battery banks when the number of battery strings in parallel is more than three or when the system is being scaled to a higher power system by adding inverters and battery storage.

**Failure to follow these instructions can result in equipment damage.**

---

1. The Energy Balancing feature is available only when each battery bank is monitored by a Context Battery Monitor. Without the battery monitor, the XW+ system cannot know the state-of-charge (SOC) of each battery bank and adjust the discharge power accordingly.

## Multi-Cluster Power System Architecture

Multi-Cluster power systems using XW+ units can be configured for North American (UL<sup>®</sup>, 120/208V) or the rest of the world (IEC, 230V) installations. Applications can be either Off Grid or Grid Tie and each application can be either AC-Coupled, DC-Coupled, or hybrid AC-DC Coupled system. All in all, there are nine possible configurations as shown below. The last column shows the featured examples in this guide as reference points to explain the design concepts.

Standard	Application	Architecture	Featured Examples
IEC	Off Grid	AC-Coupled	Island Hotel Resort
		DC-Coupled	
		Hybrid	
	Grid Tie	AC-Coupled	
		DC-Coupled	
		Hybrid	
UL <sup>®</sup>	Off Grid	AC-Coupled	Commercial Backup
		DC-Coupled	
		Hybrid	
	Grid Tie	AC-Coupled	
		DC-Coupled	
		Hybrid	

The example for an IEC Off Grid AC-Coupled Architecture is an island hotel resort power system (see Figure B-1, “76.5kVA Off Grid System for IEC using AC-Coupled PV Wiring Diagram” on page B-3).

The example for a NA Grid Tie with Backup DC-Coupled Architecture is a mid-sized commercial backup power system (see Figure B-2, “64.8kVA Grid Tie with Backup System using DC-Coupled PV Wiring Diagram” on page B-4).

In both configurations an external contactor is employed and nine XW+ units are used. The nine XW+ inverterchargers are divided into three clusters of three XW+ inverters. The first group is the master cluster and the succeeding groups are slave clusters. One of the XW+ units in a cluster represents L1, the second L2, and a third L3 in a three-phase system.

## Off Grid AC-Coupled Architecture Theory of Operation

There are four modes that typify a full day of operation in an Off Grid AC-Coupled Architecture. They are:

- **No PV Available** - this mode is characterized by charged up batteries supplying power to the loads. Battery energy continues to be depleted.
- **PV < Loads** - this mode is when both batteries and the PV inverters are supplying power to the loads.
- **PV > Loads** - this mode is when the PV inverters are supplying power to the loads while recharging the batteries.
- **Generator Start** - this mode is characterized by batteries that continues to supply power to the loads but eventually triggers the generator to start. The generator supplies power to the loads and recharges the batteries.

**NO PV AVAILABLE:** The external contactor is open. The loads are drawing power from the batteries. The PV Inverters are dormant.

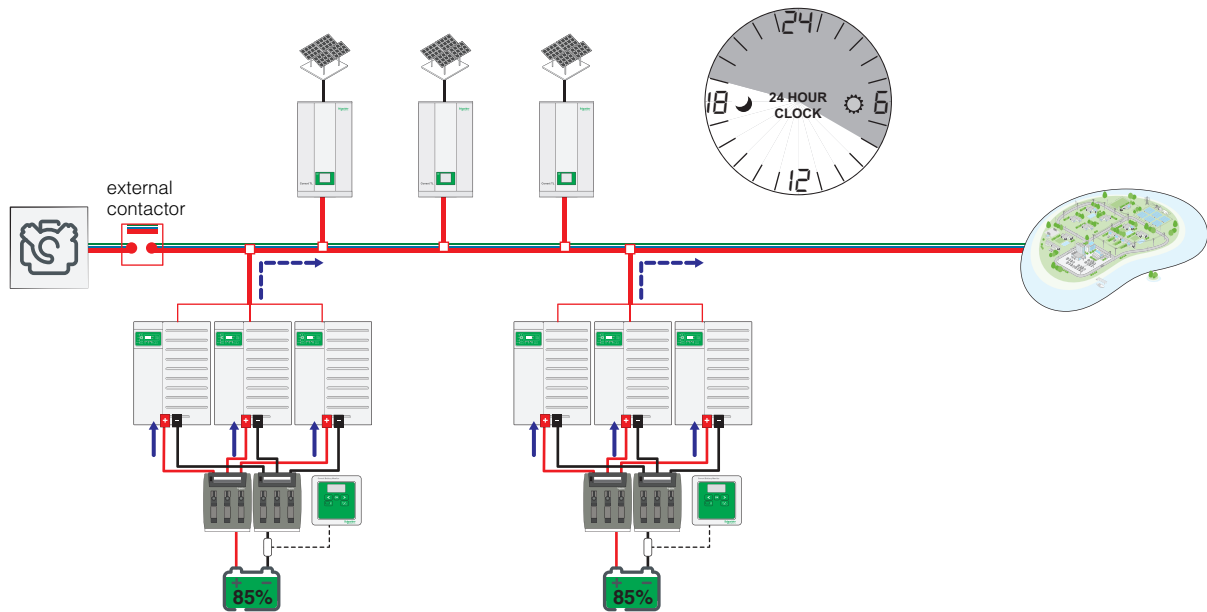

During this mode the loads draw power from the batteries.

**PV kVA < Load kVA:** The external contactor is open. The loads are partly drawing power from the batteries. The PV Inverters are also partly supplying power to the loads.

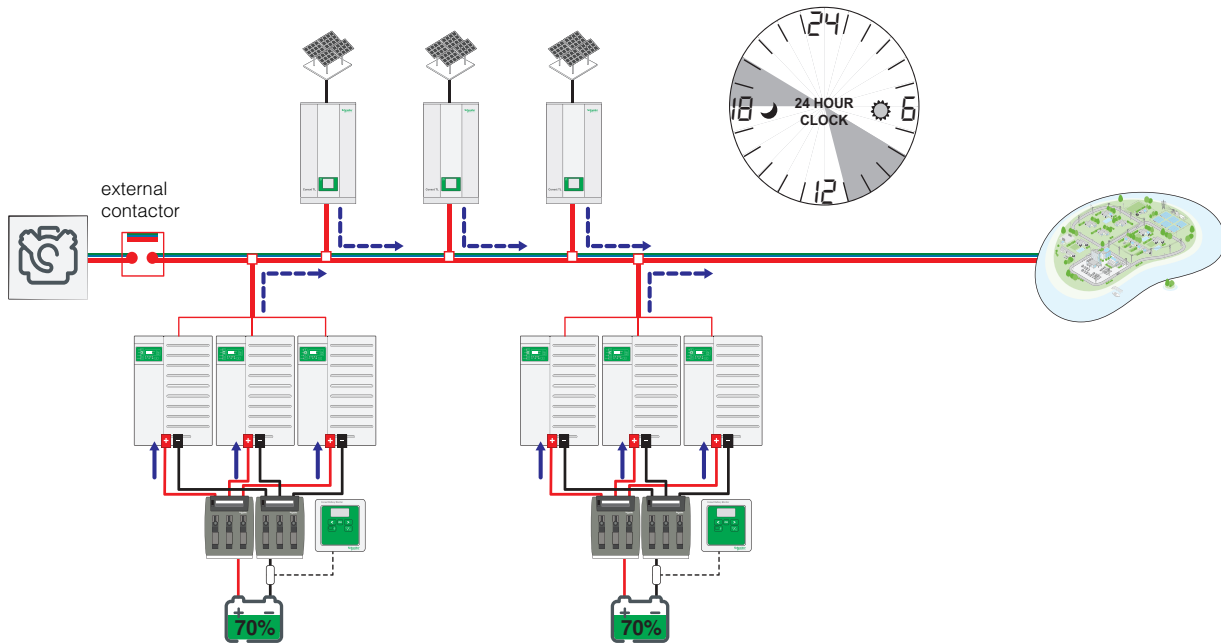

The external contactor remains open. Meanwhile, as PV becomes more available during the day, demand from the loads is continuously met but the batteries slowly get depleted.

**PV kVA > Load kVA:** The external contactor remains open. The PV Inverters harvest more power and start to charge the batteries while also supplying power to the loads.

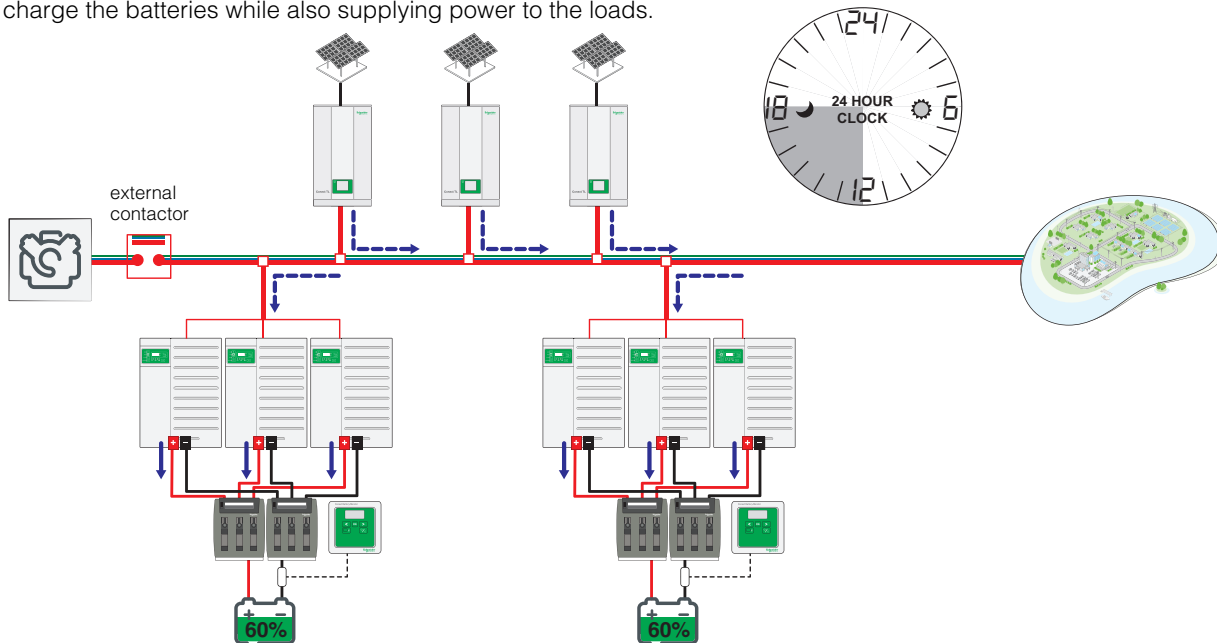

When the batteries reach absorption stage, the XW+ shifts the output frequency to control the output power from the PV Inverters: to provide only the necessary power to the loads, go to absorption charge state and transition to float.



**Generator Start:** This mode is usually started while the loads continue to draw power from the batteries. The generator is engaged when battery energy runs low. AC is qualified before closing the external contactor. When qualified AC is detected, the external contactor closes. The loads are drawing pass-through AC power from the generator and at the same time the batteries are being charged. The charging status transitions from bulk to absorption, then to float. The PV Inverters are dormant.

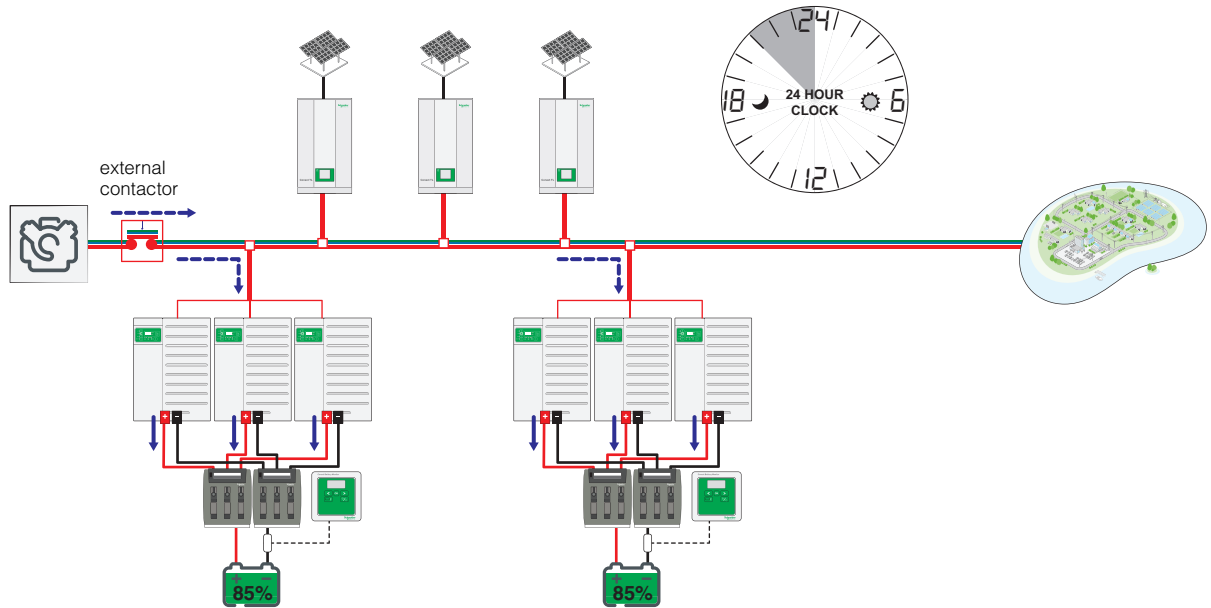

Eventually, when the batteries have been recharged, the external contactor opens and the generator is disengaged. The loads draw power from the batteries. The PV Inverters remain dormant.

## Grid Tie with Backup DC-Coupled Architecture Theory of Operation

There are three modes that typify the various operations in a Grid Tie with Backup DC-Coupled Architecture that is also configured for grid support.

- **No PV Available, Grid Available** - this mode is characterized by the grid powering the loads directly. Batteries may be charged from the grid, if the grid is configured as a charging source.
- **PV Available, Grid Available** - there is a surplus of solar energy that cannot be stored in the batteries. The surplus energy is used to power the loads and offset consumption from the grid.
- **Grid Outage** - the inverters are powering the loads from the batteries.

**No PV Available, Grid Available:** The external contactor is closed. The loads are drawing power from the utility grid. The batteries are being charged from the grid.

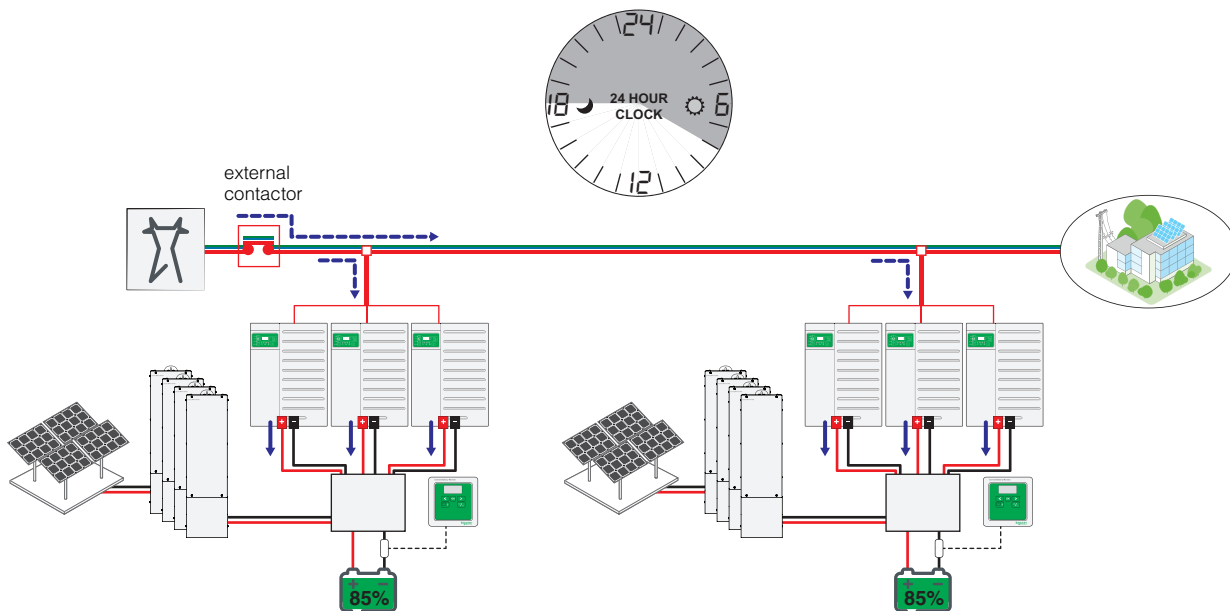

During this mode the external contactor will only open when bad AC is detected or when grid power becomes unavailable such as a brownout or blackout.

**PV Available, Grid Available:** In this mode, at the beginning of the day the MPPT units charge the batteries in bulk mode while the XW+ inverters remain idle. When the charging state transitions to absorption mode, the XW+ inverters start to export surplus PV power that cannot be stored in the batteries. The exported power are self-consumed by the loads and if the exported power is more than the loads can consume then it is routed to the grid. The power that is exported to the grid is always proportional to the power that the MPPT units (connected to same battery bank) are harvesting. So, if PV power is reduced, exported power is also reduced. This avoids batteries from cycling which instead is kept fully charged and readily available when a grid outage happens.

**Note:** This operation is possible only when the XW+ units are configured to Enhanced Grid Support mode or else they can be configured to sell power based on a fixed battery voltage setting and/or between fixed hours of the day. Please refer to the XW+ Installation and Owners Guides for details. The Enhanced Grid Support feature requires that the XW+ and MPPT devices are on the same Xanbus network. For systems with a split Xanbus network, this feature is not possible.

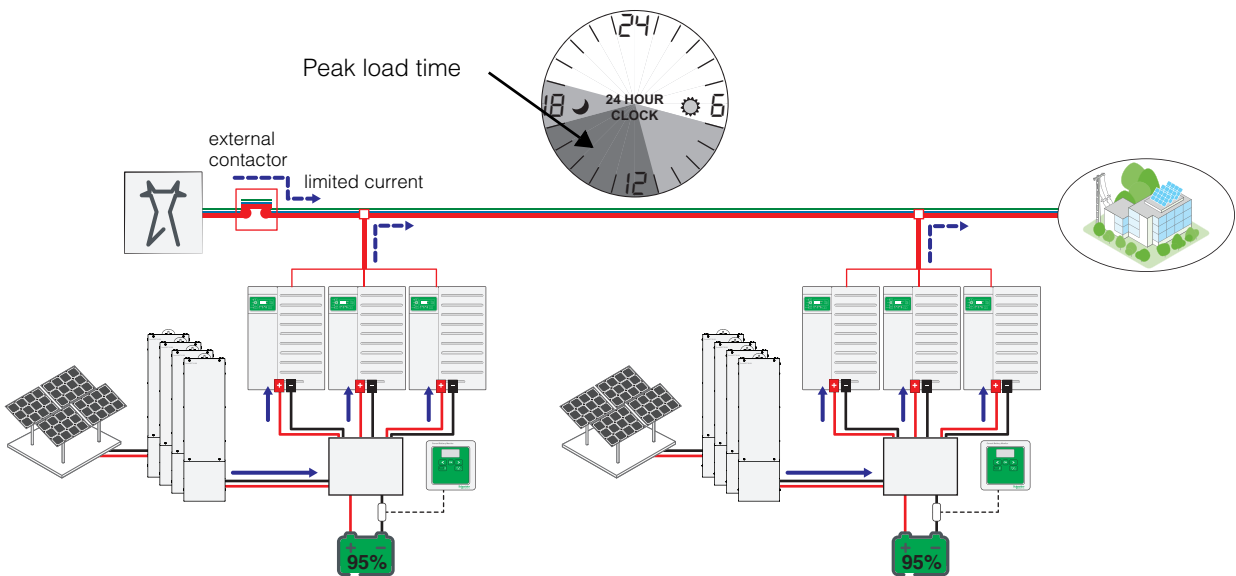

**Grid Outage:** In this mode, the external contactor is opened and the loads are powered by the XW+ inverters with energy stored in batteries. The system operation is similar to that of an off grid system. When grid power is restored, the XW+ Master cluster qualifies the incoming AC and closes the external contactor. Loads are powered from the grid again.

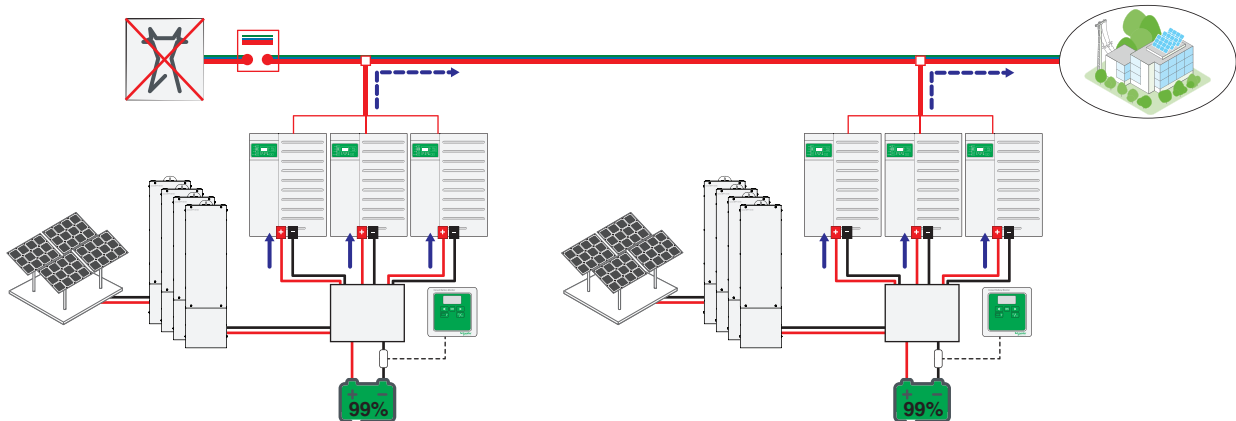

## Multi-Cluster Power System Limitations and Behavior

### SCP

These SCP settings are affected when the SCP and several XW+ units are connected in the same Xanbus network.

- **Cascading** - this System Setting in the SCP does not apply in Multi-Cluster Configuration with different DC Associations, meaning each cluster has its own battery bank while the XW+ units are connected under a single Xanbus network. Set **Cascading = Disabled**.
- **Copy From** - this XW+ Advanced Setting does not apply in a Xanbus network with more than three XW+ units.

### AGS

These AGS settings below apply when a generator (GenSet) is used as a primary source of AC.

- **Load** - this AGS setting enables and disables the Load Start and Load Stop triggers. This mode of operation is not supported by the AGS connected to a multi-cluster with an external contactor. To prevent the generator from nuisance cycling when the multi-cluster XW+ units are installed with an external contactor (that is, the generator starts and stops in a loop) set **Load = Disabled** under the **Cfg Trigger** menu. Any other features involving state-of-charge (SoC) or battery voltage as a trigger source are supported by AGS.
- **Gen Cool Down** under **Cfg Gen** menu
- The XW+ multi-cluster unit can only be connected to a single AC source (Generator or Grid). However, both can be connected in the system using an automatic transfer switch. In this case, the AGS will not exercise the Generator.

### ComBox / Insight

The following features in ComBox and Insight are not available.

- Grid input power or energy metering and reporting
- Grid export power or energy metering and reporting
- Generator input power or energy metering and reporting
- Load output power or energy metering and reporting

### XW+

These features are not available in Multi-Cluster Systems

- **Grid Support** for Self-Consumption Only (Net Zero)  
**NOTE:** The XW+ system can still sell or export energy to the grid, but it cannot self-limit for “self-consumption only” operation
- **Load Shave**
- **Search Mode**
- **Gen Support**

## 76.5 kVA Off Grid System for IEC using AC-Coupled PV

A holiday resort project is a good illustration for showing the design process and selection of various building blocks and accessories needed to build an AC-Coupled off grid system based on Conext XW+.

Considering a load profile with seasonal variations and balancing use with a generator, an AC-Coupled design is optimized with the following ratings:

Requirements	Ratings
Loads	70 kVA peak
Battery Inverter	76.5 kVA (30-min rating)
Battery Storage	1.2MWh
PV Inverter	80 kVA
Generator	180 kVA

A simplified electrical diagram for the project is illustrated in Figure B-1 on page B-3. The design is comprised of:

1. **Power conversion equipment:** Battery Inverters (nine XW+ 8548 E) and PV Inverters (four Conext TL 20000 E)
2. **BOS:** Battery fused-disconnects, DC and AC BOS for PV Inverter, AC-Combiner BOX
3. **Monitoring and control accessories:** System Control Panel (SCP), Auto Generator Start (AGS), ComBox, Battery Monitors

### Components or Bricks

**Important:** Refer to Figure B-1, “76.5kVA Off Grid System for IEC using AC-Coupled PV Wiring Diagram” on page B-3.

#	Description
A	Battery Inverters (nine XW+ 8548 E) are grouped into three clusters. One cluster consists of three inverters. Each inverter is associated to one phase of the three phases. Each cluster is connected to its own battery bank. For each XW+ inverter, only one AC port is wired for power conversion to the AC Combiner Box. The Master cluster and Slave clusters are wired with an external contactor device that is explained earlier in “External Contactor” on page 3-4.
B	Battery Fused-Disconnects are used to interface the three positive (+ve) and three negative (-ve) battery cables from the three inverter cluster to the battery bank.

#	Description
C	The DC and AC BOS for a PV inverter consists of standard disconnects. You can refer to the guide titled “Safe and reliable photovoltaic energy generation” to select the correct parts based on the geography, local code, and module type.
D	PV Inverters (four Conext TL 20000 E) provide dual MPP (Maximum Power Point) trackers with a wide voltage range and a peak efficiency of greater than 98%.
E	The AC Combiner Box is intended to integrate a generator, the XW+ AC interconnects, the LOAD output, and the PV Input to the system. A reference design of the AC Combiner Box, its contents, and layout is described in “AC Combiner Box” on page A-1.
F	The Auto Generator Start (AGS) controls the starting / stopping of the generator based on battery triggers such as voltage, state-of-charge (SOC), charge-state. It can also be programmed not to trigger a Start during a quiet time or force a Start after every fixed hours of idle time (to exercise the generator). See “Multi-Cluster Power System Limitations and Behavior” on page 3-18.
G	The Battery Monitor keeps track of the voltage, current, SOC, and amp-hours in/out of a system. Also provides status of the battery to the connected devices on the communication network, such as allowing SOC-based Start and Stop from the AGS.
H	The ComBox enables configuration, control, and status reporting of devices connected to the network through a web browser user interface (UI). It also doubles as a data logger to record energy production/ consumption levels over hours/days/months/years and as a communication gateway for remote monitoring. There are three ComBoxes on the system. ComBox Slave1 is dedicated to all XanBus connected devices. ComBox Slave 2 is connected to all RS-485 devices and the ComBox Master is dedicated to aggregate the two slave ComBoxes and provide a unified view of the system to the end user. Refer to the <i>Xanbus Network Sizing Guide for Conext XW+ Systems</i> (Document Number: 975-0646-01-01), for more details on selection/configuration of the ComBox for large area networks.
I	The System Control Panel (SCP) allows for a local LCD interface for easy access of the system. This is a required accessory but its use is limited to setting the system in operating or standby modes. The advantage is the SCP has quick access to control or put all system devices in standby without having to access a web UI.  However, it shall not be used for device configurations. Use the Conext Configuration Tool and/or the Conext ComBox for commissioning and configuring the larger Multi-Cluster system. See “Multi-Cluster Power System Limitations and Behavior” on page 3-18.

#	Description
<b>J</b>	Power Meters are required accessories in the system. It is recommended to install them to enable remote monitoring and diagnostics of the system. In case an AC-Coupled PV inverter might backfeed to a generator, the power meter can be programmed to have a Digital I/O alarm set off when a reverse power flow is detected (disconnecting the inline external contactor with the PV inverter feed for a fixed period). At the time of writing this guide the ComBox supports the PM8XXX, PM5XXX, EM35XX, and Acti 9 iEM32XX range of Schneider Electric Power Meters.
<b>K</b>	A weather sensor like a pyranometer can be used to measure irradiance and temperature so as to cross check the power production of the PV plant within an expected range. At the time of writing this guide the ComBox supports the SMP3 Pyranometer from Kipp & Zonnen.
<b>L</b>	A network router is essential to allow a network bridge between the Slave and Master ComBoxes. It is recommended to use an industrial grade router that is capable of providing DHCP addresses to facilitate the installation process. Choose one that can be configured for port-forwarding, support DYDNS services, or VPN.
<b>M</b>	A cellular modem is essential to enable remote monitoring of the system. It is recommended to use an industrial grade modem that is capable of remote configuration such as the WR-21 from Digi (PN:WR21-U91B-DE1-SF).  Currently however, the ComBox is not compatible with cellular modems.

## 64.8kVA Grid Tie with Backup System using DC-Coupled PV

A commercial building project is a good illustration for showing the design process and selection of various building blocks and accessories needed to build a DC-Coupled grid tie system based on Conext XW+. The commercial building is expected to experience grid outages that are random and sometimes for an extended period. It is expected that the commercial building will self-consume the PV power before exporting the energy to the grid and maintain batteries in a fully-charged state. The batteries cycle through the bulk phase at the beginning of every day for maintenance.

All three electrical architectures (AC-Coupled, DC-Coupled, or Hybrid system) can be implemented with the commercial building project considering typical use cases and battery maintenance. Choosing an AC-Coupled system could boost efficiency by up to 4%, however, a grid outage might pose a challenge. Usually, the PV Inverter has to be set to allow anti-islanding based on frequency, therefore, the battery inverter will not be able to control the PV inverter output through the frequency shift method. Instead, either a secondary anti-islanding detection and isolation device is required (to allow PV inverter operation based on frequency shift method) or a communication and control device to signal the PV inverter to reduce output power (that is, to generate only what the loads can consume while also keeping the batteries in a charged state). Additionally, a generator or bypass device may have to be integrated into the system which could pose further challenges when an AC-Coupled system is chosen.

To simplify the installation, configuration, and operation, a DC-Coupled system is preferred. Consider the following ratings:

Requirements	Ratings
Loads	60 kVA peak
Battery Inverter	64.8 kVA (30-min rating)
Battery Storage	800kVAh
PV Charge Controller	57.6 kVA
Bypass Capacity	400A peak (144 kVA)

A simplified electrical diagram for the project is illustrated in Figure B-2 on page B-4. The design is comprised of:

1. **Power conversion equipment:** Battery Inverters (nine XW+ 6848 NA) and MPPT Charge Controllers (twelve MPPT 80 600)
2. **BOS:** Power Distribution Panels (PDP), PV Disconnects, AC Combiner Box
3. **Monitoring and control accessories:** System Control Panel (SCP), ComBox, Battery Monitors



## Components or Bricks

**Important:** Refer to Figure B-2, “64.8kVA Grid Tie with Backup System using DC-Coupled PV Wiring Diagram” on page B-4.

#	Description
A	Battery Inverters (nine XW+ 6848 NA) are grouped into three clusters. One cluster consists of three inverters. Each inverter is associated to one phase of the three phases. Each cluster is connected to its own battery bank. For each XW+ inverter, only one AC port is wired for power conversion to the AC Combiner Box. The Master cluster and Slave clusters are wired with an external contactor device that is explained earlier in “External Contactor” on page 3-4.
B	MPPT Solar Charge Controller (twelve MPPT 80 600) are grouped into four clusters. Each cluster consists of four MPPT solar charge controllers providing a total of 320 A charging current. Each MPPT is connected to a PV array of 5kVA with two strings, each with 10x 250 W modules.
C	Power Distribution Panel (PDP) houses the AC and DC breakers integrating the inverter, the battery, and AC input and output.
D	The PV Combiner Box is intended to integrate the PV modules and the MPPT solar charge controllers. It houses PV string combiners and DC disconnects.
E	The Battery Monitor keeps track of the voltage, current, SOC, and amp-hours in/out of a system. Also provides status of the battery to the connected devices on the communication network, such as allowing SOC-based Start and Stop from the AGS.
F	The ComBox enables configuration, control, and status reporting of devices connected to the network through a web browser user interface (UI). It also doubles as a data logger to record energy production/consumption levels over hours/days/months/years and as a communication gateway for remote monitoring. There are three ComBoxes on the system. ComBox Slave1 is dedicated to all XanBus connected devices. ComBox Slave 2 is connected to all RS-485 devices and the ComBox Master is dedicated to aggregate the two slave ComBoxes and provide a unified view of the system to the end user. Refer to the <i>Xanbus Network Sizing Guide for Conext XW+ Systems</i> (Document Number: 975-0646-01-01), for more details on selection/configuration of the ComBox for large area networks.

#	Description
<b>G</b>	<p>The System Control Panel (SCP) allows for a local LCD interface for easy access of the system. This is a required accessory but its use is limited to setting the system in operating or standby modes. The advantage is the SCP has quick access to control or put all system devices in standby without having to access a web UI.</p> <p>However, it shall not be used for device configurations. Use the Conext Configuration Tool for commissioning and configuring the larger Multi-Cluster system. See “Multi-Cluster Power System Limitations and Behavior” on page 3–18.</p>
<b>H</b>	<p>Power Meters are required accessories in the system to ensure that power flow is monitored. It is recommended to install them to enable remote monitoring and diagnostics of the system. In case an AC-Coupled PV inverter might backfeed to a generator, the power meter can be programmed to have a Digital I/O alarm set off when a reverse power flow is detected (disconnecting the inline external contactor with the PV inverter feed for a fixed period). At the time of writing this guide the ComBox supports the PM8XXX, PM5XXX, EM35XX, and Acti 9 iEM32XX range of Schneider Electric Power Meters.</p>
<b>I</b>	<p>A network router is essential to allow a network bridge between the Slave and Master ComBoxes. It is recommended to use an industrial grade router that is capable of providing DHCP addresses to facilitate the installation process. Choose one that can be configured for port-forwarding, support DYDNS services, or VPN.</p>
<b>J</b>	<p>A cellular modem is essential to enable remote monitoring of the system. It is recommended to use an industrial grade modem that is capable of remote configuration such as the WR-21 from Digi (PN:WR21-U91B-DE1-SF).</p> <p>Currently however, the ComBox is not compatible with cellular modems.</p>
<b>K</b>	<p>A bypass device is a high current manual switch which is installed to switch between an alternative power source and a battery-based power source.</p> <p>The primary purpose of the bypass device is to provide a means to isolate the external contactor for the purpose of troubleshooting while maintaining a power supply to the local loads.</p>

# A

## AC Combiner Box

Appendix A contains information and schematics for:

- AC Combiner Box Control Schematic
- AC Combiner Box - 9 for North America
- AC Combiner Box - 9 for IEC

## Introduction

The AC Combiner Box for a Conext XW+ Multi-Cluster system is a basic low voltage switchgear electrical panel. It provides an interface for the XW+ inverters, loads, AC sources, and/or PV inverters.

Based on the kind of application and the use-case scenario, the AC Combiner Box can be configured as a simple combiner box for the outputs of the XW+ inverters which are connected to the loads in a DC-Coupled system with no diesel generator or PV inverter sources. A more elaborate use-case for the AC Combiner Box is a hybrid-coupled off grid system which requires a diesel generator that is interfaced with an AC contactor and a PV inverter which is interfaced through a separate AC contactor that protects against backfeeding to the generator. In addition, a manual bypass may be added to this AC Combiner Box as a safeguard to isolate the entire system and to run it on diesel generator during maintenance.

Therefore, the best approach to custom build an AC Combiner Box for your project is to provide an electrical architecture design reference to one of the Schneider Electric panel builders within your geographical area. Use the link below to find the authorized Schneider Electric panel builder in your location<sup>1</sup>.

**[Schneider Electric Alliance Partner Locator](#)** 

You may also consult the Sales Applications Engineer in your region who can provide you with further support and details on the AC Combiner Box.

On the following pages, a schematic of two AC Combiner Boxes is presented showing their key components and wiring.

<b><i>NOTICE</i></b>
<b>EQUIPMENT SELECTION RISK</b> For reliable operation of the system, certain components of the AC Combiner Box must be used specifically, according to the designated make and model highlighted in the List of Components from Schneider Electric to Build the AC Combiner Box on page A-6. <b>Failure to follow these instructions can result in damage to equipment.</b>

---

1. <http://www2.schneider-electric.com/sites/corporate/en/customers/alliance/alliance-partner.page>

# AC Combiner Box Control Schematic

Note: Subject to change without notice.

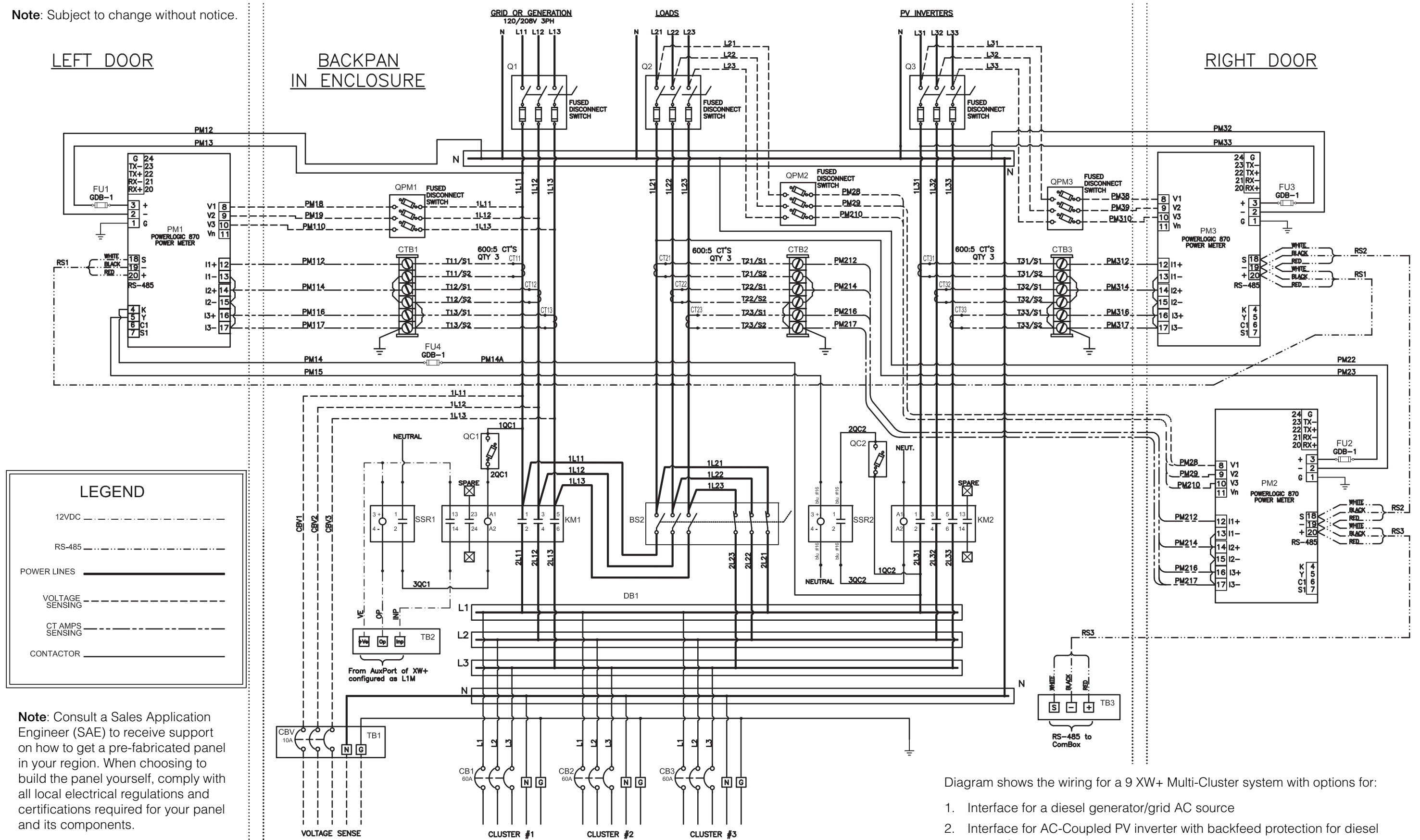

Diagram shows the wiring for a 9 XW+ Multi-Cluster system with options for:

1. Interface for a diesel generator/grid AC source
2. Interface for AC-Coupled PV inverter with backfeed protection for diesel generator
3. Manual bypass/source changeover switch

Figure A-1 AC Combiner Box - 9 Control Schematics

# AC Combiner Box - 9 for North America

Note: Subject to change without notice.

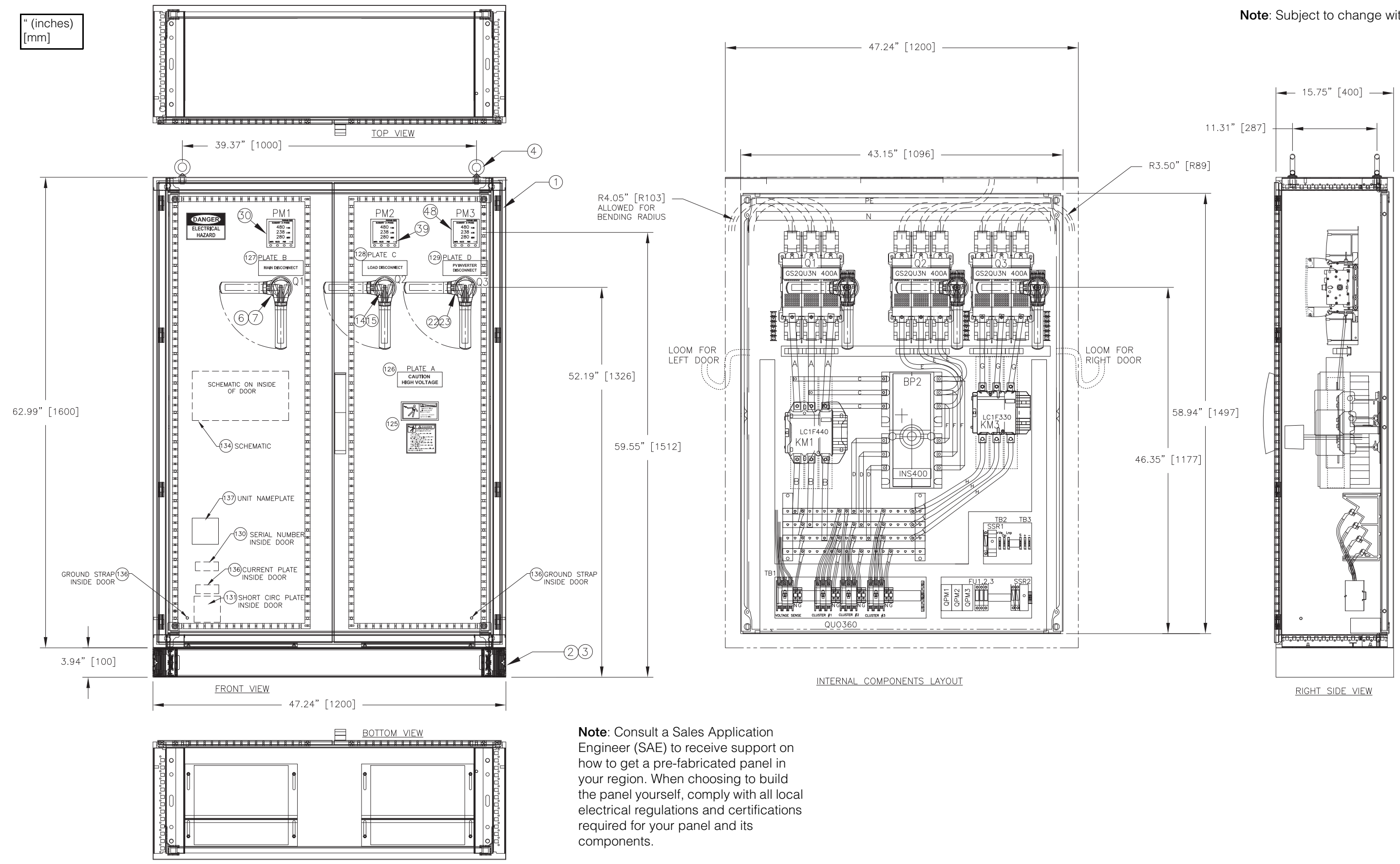

Note: Consult a Sales Application Engineer (SAE) to receive support on how to get a pre-fabricated panel in your region. When choosing to build the panel yourself, comply with all local electrical regulations and certifications required for your panel and its components.

Figure A-2 AC Combiner Box - 9 NA Dimensions

# AC Combiner Box - 9 for IEC

in mm **Note:** Subject to change without notice.

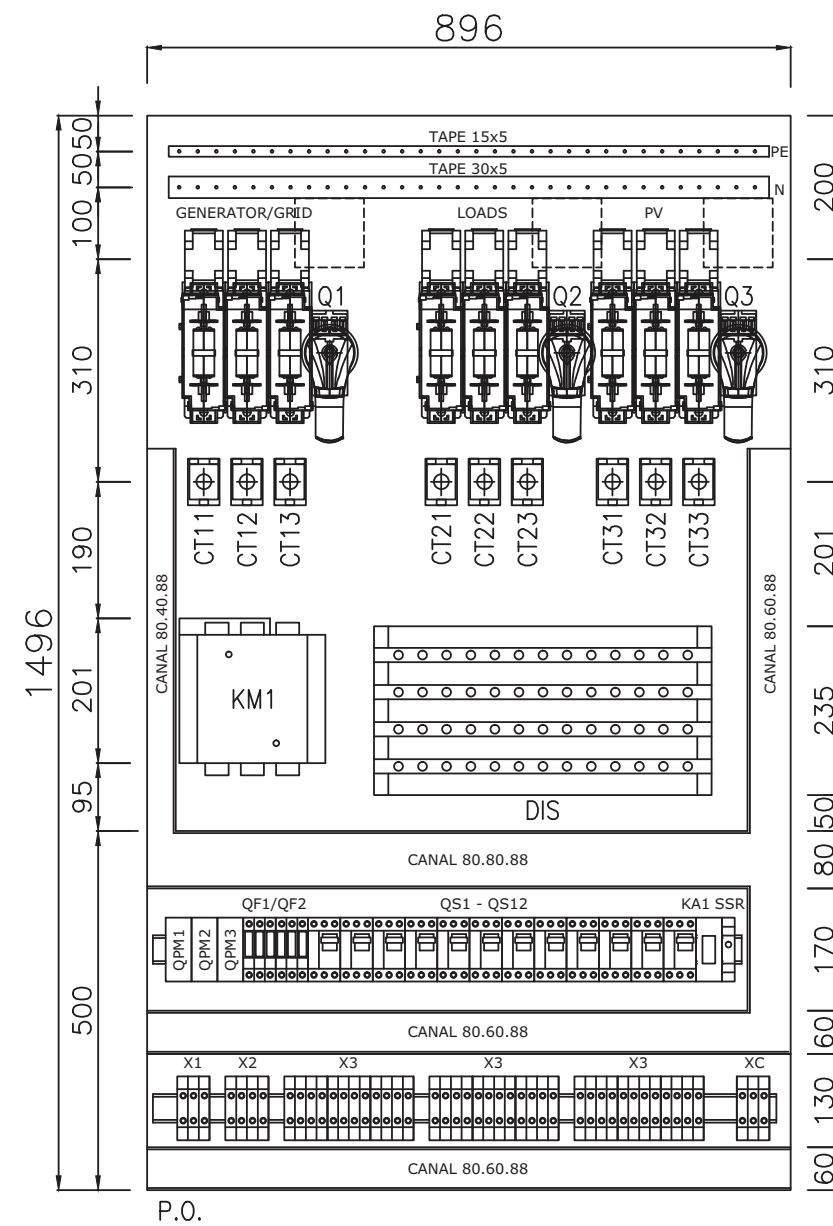
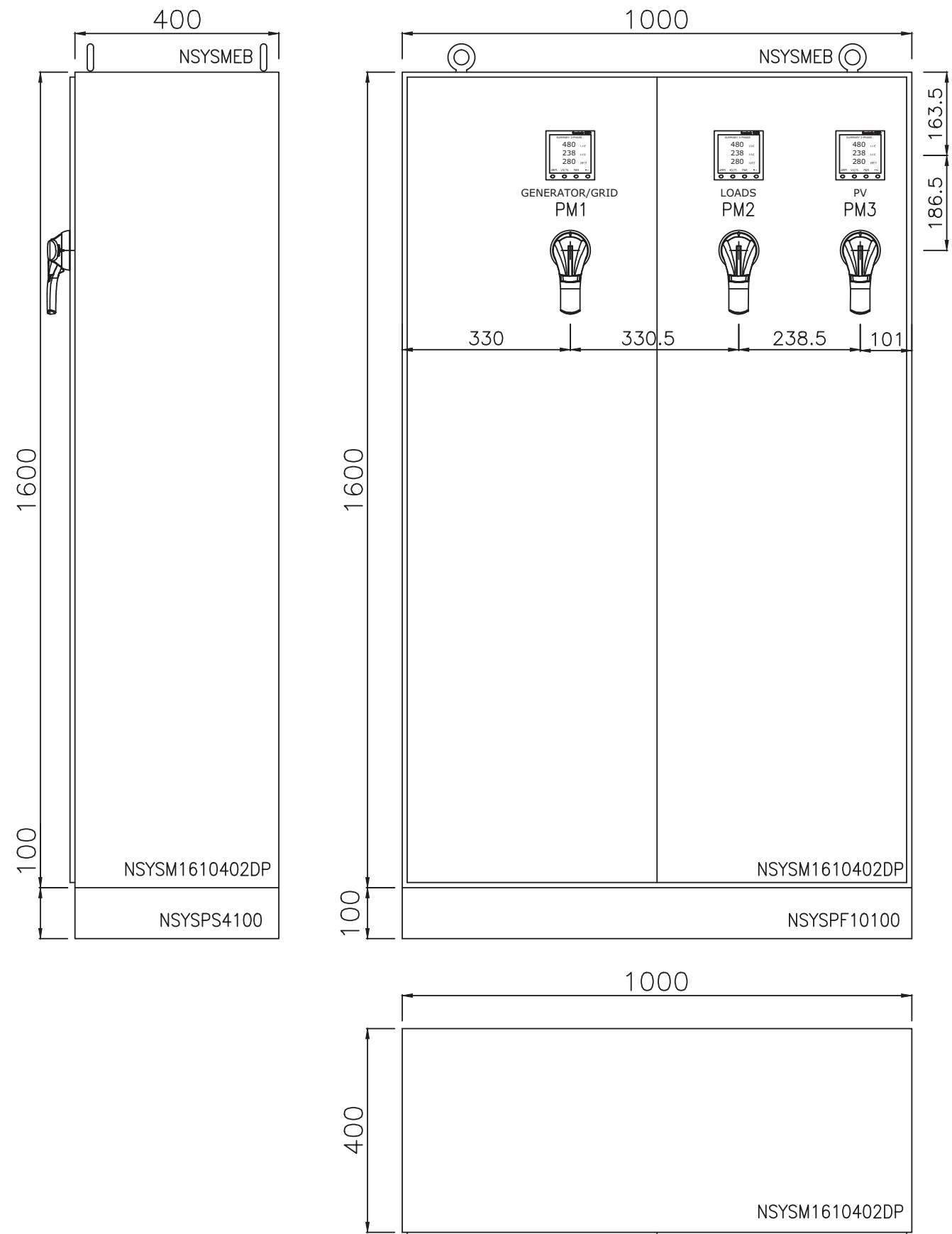

**Note:** Consult a Sales Application Engineer (SAE) to receive support on how to get a pre-fabricated panel in your region. When choosing to build the panel yourself, comply with all local electrical regulations and certifications required for your panel and its components.

Figure A-3 AC Combiner Box - 9 IEC Dimensions

# List of Components from Schneider Electric to Build the AC Combiner Box

Component	Item Description	Model	Certification
Enclosure	Enclosure Option 1 - 1600x1200x400 mm, 2-door w/ mounting plate	NSYSM1612402DP	UL / IEC / CSA
	Base Front Option 1 - 100x1200 mm	NSYSPP12100	UL / IEC / CSA
	Base Side Option 1 - 100x400 mm	NSYSPS4100	UL / IEC / CSA
	Enclosure Option 2 - 1600x1000x400 mm, 2-door w/ mounting plate	NSYSM1610402DP	UL / IEC / CSA
	Base Front Option 2 - 100x1200 mm	NSYSPP10100	UL / IEC / CSA
	Base Side Option 2 - 100x400 mm	NSYSPS4100	UL / IEC / CSA
	Enclosure Option 3 - 1600x1000x400 mm, 2-door w/ mounting plate	NSYSM14640P	UL / IEC / CSA
	Base Front Option 3 - 100x600 mm	NSYSPP6100	UL / IEC / CSA
	Base Side Option 3 - 100x400 mm	NSYSPS4100	UL / IEC / CSA
	Transport Lugs	NSYSMEB	UL / IEC / CSA
Over Current Protection	Fuse AC Disconnects - 400A	GS2QQ3	IEC
		GS2AH530	IEC
	Fuse AC Disconnects - 250A	GS2N3	IEC
		GS2AH530	IEC
	Fuse AC Disconnects - 160A	GS2LL3	IEC
		GS2AH530	IEC
	Fuse AC Disconnects - 400A - UL	GS2QU3N	UL / IEC / CSA
		GS2AH430	UL / IEC / CSA
	300A Circuit Breaker UL	LAL36300	UL / IEC / CSA
	400A Circuit Breaker UL	LAL36400	UL / IEC / CSA
	400A NSX Circuit Breaker IEC	LV432676	UL / IEC / CSA
	320A NSX Circuit Breaker IEC	LV432750	UL / IEC / CSA
	160A NSX Circuit Breaker IEC	LV430830	UL / IEC / CSA
	Inverter Circuit Breaker - 60A - D-curve	MG17474 MG24546	UL / IEC / CSA
	Inverter Circuit Breaker - 15A - D-curve	17471	UL / IEC / CSA
Inverter Circuit Breaker - 35A - D-curve	60199	UL / IEC / CSA	
Control Power Fuse Disconnect w/ LED_Blow Fuse -2P	DF102V	UL / IEC / CSA	
Control Power Fuse Disconnect w/ LED_Blow Fuse - 3P	DF103V	UL / IEC / CSA	
Switchgear and Contactors	Power Contactor - 330A 230V coil	LC1F330P7	UL / IEC / CSA
	Power Contactor - 265A 230V coil	LC1F265P7	UL / IEC / CSA
	Power Contactor - 185A 230V coil	LC1F185P7	UL / IEC / CSA
	Power Contactor - 400A 120V coil	LC1F400G7	UL / IEC / CSA
	Power Contactor - 300A 120V coil	LC1F330G7	UL / IEC / CSA
	SSR - DIN - input 4-32 V DC, output 24-280 V AC, 20A	SSRD20A1	UL / IEC / CSA
	SSR - DIN - input 90-280 V AC, output 24-280 V AC, 30A	SSRDP8S30A1	UL / IEC / CSA
	Auxiliary Contact Block 2NO, 2NC	LADN22	UL / IEC / CSA
	Bypass Switch/Manual Source ChangeOver Double Throw - INS - 400A	31150	IEC
	Bypass Switch/Manual Source ChangeOver Double Throw - INS - 250A	31146	IEC
	Bypass Switch/Manual Source ChangeOver Double Throw - INS - 160A	31144	IEC
	Bypass Switch/Manual Source ChangeOver Double Throw - SquareD - 400A	82345	UL
	Bypass Switch/Manual Source ChangeOver Double Throw - SquareD - 200A	82344	UL
	Downstream bar Bypass 100..250 for IEC	29358	IEC
	Downstream bar Bypass 400..630	32619	IEC
Power Measurement	Power Meters - PM 8000	PM8000	UL / IEC / CSA
	Power Meter Add-on I/O	PM8M22	UL / IEC / CSA
	CT DIN mount 250A:5A Cable DIA 21mm	METSECT5CC025	IEC
	CT DIN mount 500A:5A Cable DIA 35mm	METSECT5MF050	IEC
	CT 250A:5A (mountable screw leads)	64R-251	UL
	CT 500A:5A (mountable screw leads)	64R-501	UL
	CT 250A:5A (fly leads)	54R-251	UL
	CT 500A:5A (fly leads)	54R-501	UL
Internal Wiring	4P MULTISTAGE BUSBAR BLOCK 250A	04053	IEC
	4P MULTISTAGE BUSBAR BLOCK 400A	04054	IEC

**Note:** The highlighted items are not substitutable with any equivalent make/model. Doing so will risk the reliable operation of the system affecting transfer time, fault protection, and could lead to equipment damage. Other components such as enclosure, over current protection can be substituted if necessary to comply with local code and application need.



# B

## 75 kVA Power Systems Wiring

Appendix B contains information for:

- 76.5kVA Off Grid System for IEC using AC-Coupled PV Wiring Diagram
- 64.8kVA Grid Tie with Backup System using DC-Coupled PV Wiring Diagram



# 76.5kVA Off Grid System for IEC using AC-Coupled PV



- System Components (Bricks)**
- A Conext XW+ 8548 E
  - B Battery Fused-Disconnects
  - C DC/AC BOS for PV Inverter
  - D Conext TL 20000E PV Inverter
  - E AC Combiner Box - 9 IEC
  - F AGS - see \* below
  - G Conext Battery Monitor
  - H Conext ComBox
  - I SCP - see \*\* below
  - J PowerLogic PM870 Power Meter
  - K Pyranometer
  - L Network router
  - M Cellular modem
- \* When a Generator is also a power source, Load = Disabled.  
 \*\* These features will not work: Cascading and Copy From.  
 \*\*\* Use of a Protection System required.

- LEGEND**
- Battery shunt
  - Xanbus Network Terminator
  - Xanbus
  - Sync
  - RS 485
  - Ethernet
  - Batt Sense, V, I, shunt
  - AUX Cont, +12, Trig, Sense
  - Gen Voltage Sense
  - AC Breaker connection
  - AC Bus connection
  - Line AC - Cable
  - Neutral AC - Cable
  - Ground AC - Cable
  - DC +ve Cable
  - DC -ve Cable

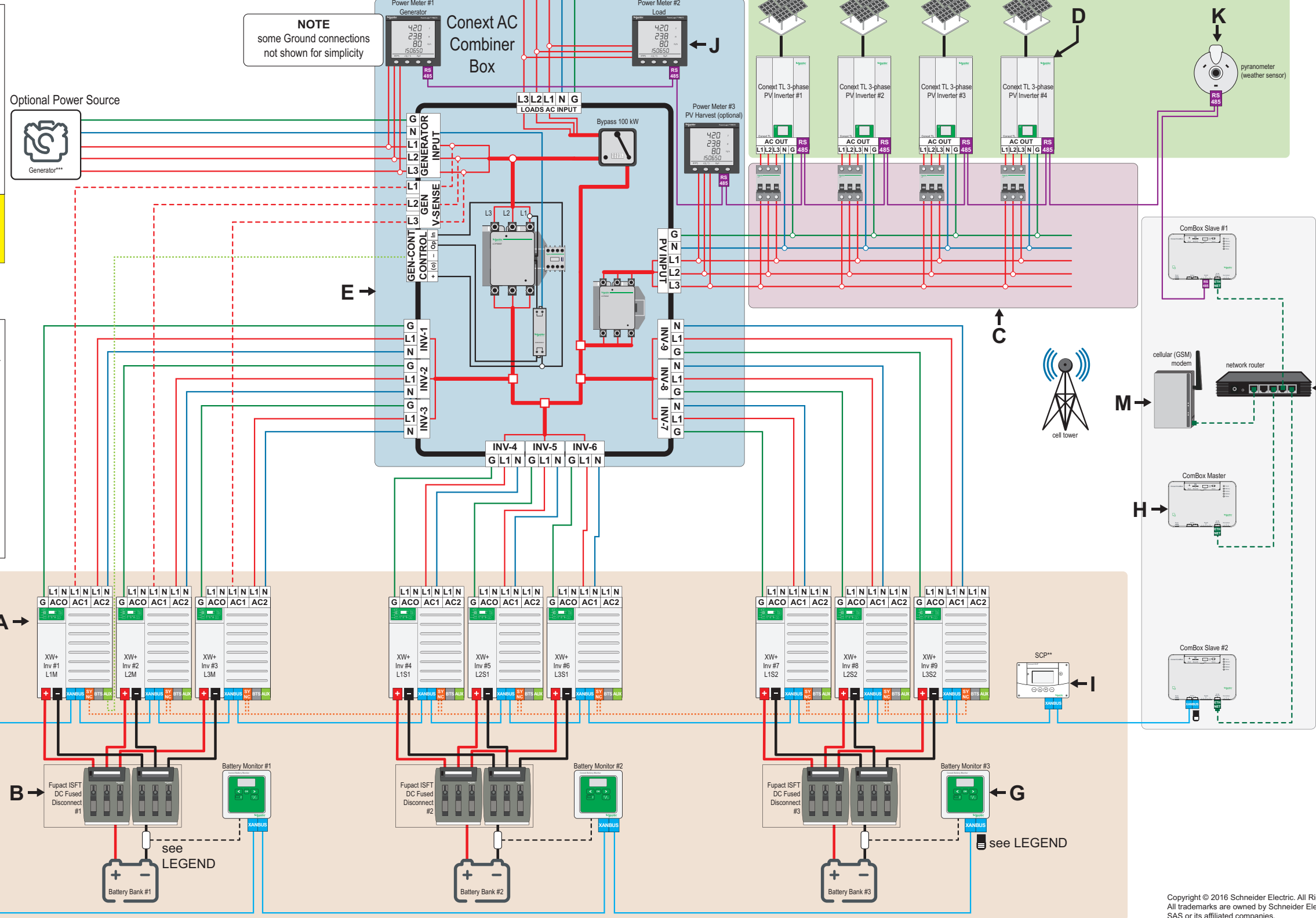

Copyright © 2016 Schneider Electric. All Rights Reserved. All trademarks are owned by Schneider Electric Industries SAS or its affiliated companies.

Figure B-1 76.5kVA Off Grid System for IEC using AC-Coupled PV Wiring Diagram

# 64.8kVA Grid Tie with Backup System using DC-Coupled PV

- System Components (Bricks)**
- A Conext XW+ 6848 NA
  - B MPPT 80 600 Solar Charge Controller
  - C Power Distribution Panel (PDP)
  - D PV Combiner Box
  - E Conext Battery Monitor
  - F Conext ComBox
  - G SCP - see \* below
  - H PowerLogic PM870 Power Meter
  - I Network router
  - J Cellular modem
  - K Bypass device
- \* These features do not apply:  
Cascading and Copy From.

- LEGEND**
- Battery shunt
  - Xanbus Network Terminator
  - Xanbus
  - Sync
  - RS 485
  - Ethernet
  - Batt Sense, V, Ishunt
  - AUX Cont, +12, Trig, Sense
  - Gen Voltage Sense
  - Line AC - Cable
  - Neutral AC - Cable
  - Ground AC - Cable
  - DC +ve Cable
  - DC -ve Cable

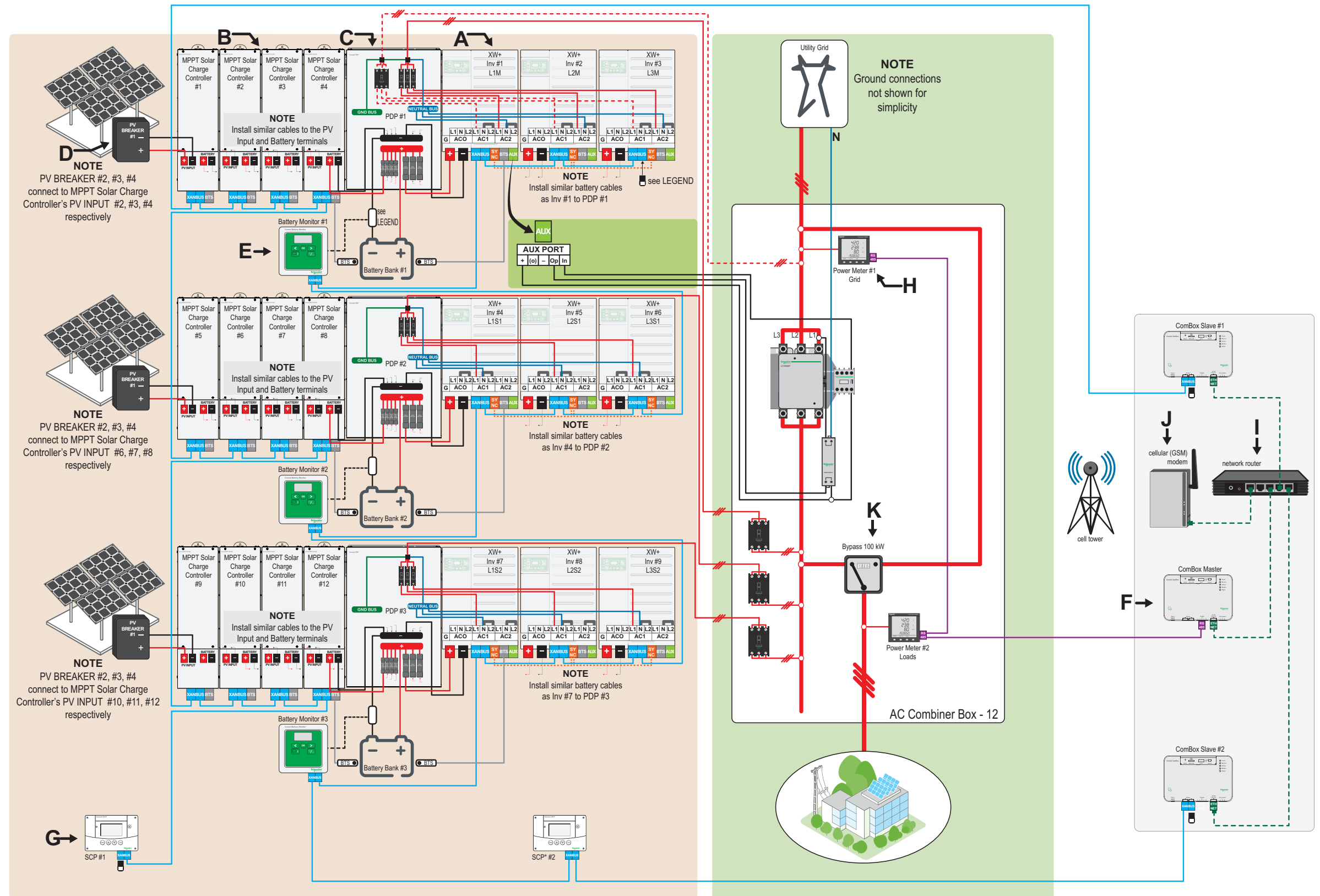

Copyright © 2016 Schneider Electric. All Rights Reserved.  
All trademarks are owned by Schneider Electric Industries SAS or its affiliated companies.

Figure B-2 64.8kVA Grid Tie with Backup System using DC-Coupled PV Wiring Diagram



## Schneider Electric

<http://solar.schneider-electric.com>

As standards, specifications, and designs change from time to time, please ask for confirmation of the information given in this publication.

© 2016 Schneider Electric. All rights reserved.

975-0648-01-01 Rev B

Printed in:

**Limited Circulation. Not for public release.**