

# Galaxy VS

## UPS for External Batteries

### Technical Specifications

20-150 kW 380/400/415/440 V

Latest updates are available on the Schneider Electric website  
1/2024



# Legal Information

The information provided in this document contains general descriptions, technical characteristics and/or recommendations related to products/solutions.

This document is not intended as a substitute for a detailed study or operational and site-specific development or schematic plan. It is not to be used for determining suitability or reliability of the products/solutions for specific user applications. It is the duty of any such user to perform or have any professional expert of its choice (integrator, specifier or the like) perform the appropriate and comprehensive risk analysis, evaluation and testing of the products/solutions with respect to the relevant specific application or use thereof.

The Schneider Electric brand and any trademarks of Schneider Electric SE and its subsidiaries referred to in this document are the property of Schneider Electric SE or its subsidiaries. All other brands may be trademarks of their respective owner.

This document and its content are protected under applicable copyright laws and provided for informative use only. No part of this document may be reproduced or transmitted in any form or by any means (electronic, mechanical, photocopying, recording, or otherwise), for any purpose, without the prior written permission of Schneider Electric.

Schneider Electric does not grant any right or license for commercial use of the document or its content, except for a non-exclusive and personal license to consult it on an "as is" basis.

Schneider Electric reserves the right to make changes or updates with respect to or in the content of this document or the format thereof, at any time without notice.

**To the extent permitted by applicable law, no responsibility or liability is assumed by Schneider Electric and its subsidiaries for any errors or omissions in the informational content of this document, as well as any non-intended use or misuse of the content thereof.**

## Access to Your Product Manuals Online

### Find the UPS Manuals, Submittal Drawings, and Other Documentation for Your Specific UPS Here:

In your web browser, type in <https://www.go2se.com/ref=> and the commercial reference for your product.

Example: <https://www.go2se.com/ref=GVSUPS20KHS>

### Find the UPS Manuals, Relevant Auxiliary Product Manuals, and Option Manuals Here:

Scan the code to go to the Galaxy VS online manual portal:

**IEC (380/400/415/440 V)**



[https://www.productinfo.schneider-electric.com/galaxyvs\\_iec/](https://www.productinfo.schneider-electric.com/galaxyvs_iec/)

Here you can find your UPS installation manual, UPS operation manual, and UPS technical specifications, and you can also find installation manuals for your auxiliary products and options.

This online manual portal is available on all devices and offers digital pages, search functionality across the different documents in the portal, and PDF download for offline use.

### Learn More About the Galaxy VS Here:

Go to <https://www.se.com/ww/en/product-range/65772> to learn more about this product.



# Table of Contents

Important Safety Instructions — SAVE THESE INSTRUCTIONS .....	7
Electromagnetic Compatibility .....	8
Safety Precautions .....	8
Model list .....	10
Single System Overview .....	12
Parallel System Overview .....	13
Input Voltage Window .....	16
Inverter Short Circuit Capabilities (Bypass not Available) .....	17
Efficiency .....	20
Derating Due to Load Power Factor .....	23
Leakage Current .....	24
Batteries .....	25
End of Discharge Voltage .....	25
Standard VRLA Voltage Levels .....	25
Compliance .....	27
Regional Seismic Compliance .....	27
Communication and Management .....	28
EPO .....	28
Configurable Input Contacts and Output Relays .....	29
Requirements for a Third Party Battery Solution .....	30
Third Party Battery Breaker Requirements .....	30
Guidance for Organizing Battery Cables .....	31
Specifications for 400 V Systems .....	32
Input Specifications 400 V .....	32
Bypass Specifications 400 V .....	33
Output Specifications 400 V .....	34
Battery Specifications 400 V .....	35
Surge Protection Device (SPD) .....	36
Recommended Cable Sizes 400 V .....	37
Recommended Upstream Protection 400 V .....	39
Specifications for 440 V Marine Systems .....	41
Input Specifications 440 V Marine Systems .....	41
Bypass Specifications 440 V Marine Systems .....	42
Output Specifications 440 V Marine Systems .....	43
Battery Specifications 440 V Marine Systems .....	44
Surge Protection Device (SPD) .....	45
Recommended Cable Sizes 440 V Marine Systems .....	46
Recommended Upstream Protection 440 V Marine Systems .....	48
Recommended Bolt and Lug Sizes for IEC .....	50
Torque Specifications .....	51
Physical .....	52
UPS Shipping Weights and Dimensions .....	52
UPS Weights and Dimensions .....	52
Clearance .....	53

Environment..... 54  
Heat Dissipation for 400 V in BTU/hr ..... 54

Drawings ..... 58  
20-50 kW 400 V UPS ..... 59  
60-100 kW 400 V UPS ..... 60  
120-150 kW 400 V UPS ..... 61

Options ..... 62  
Configuration Options ..... 62  
Hardware Options..... 62  
Weights and Dimensions for Options..... 66  
Maintenance Bypass Panel Shipping Weights and Dimensions ..... 66  
Maintenance Bypass Panel Weights and Dimensions ..... 66  
Parallel Maintenance Bypass Panel Weights and Dimensions ..... 66  
Parallel Maintenance Bypass Panel Shipping Weights and  
Dimensions ..... 66  
Battery Breaker Box Shipping Weights and Dimensions..... 66  
Battery Breaker Box Weights and Dimensions ..... 67  
Classic Battery Cabinet Shipping Weights and Dimensions ..... 67  
Classic Battery Cabinet Weights and Dimensions..... 67  
Empty Battery Cabinet Shipping Weight and Dimensions..... 67  
Empty Battery Cabinet Weight and Dimensions..... 67  
Modular Battery Cabinet Shipping Weights and Dimensions..... 68  
Modular Battery Cabinet Weights and Dimensions ..... 68  
Remote Alarm Panel Shipping Weights and Dimensions..... 68  
Remote Alarm Panel Weights and Dimensions..... 68

Limited Factory Warranty..... 69

# Important Safety Instructions — SAVE THESE INSTRUCTIONS

Read these instructions carefully and look at the equipment to become familiar with it before trying to install, operate, service or maintain it. The following safety messages may appear throughout this manual or on the equipment to warn of potential hazards or to call attention to information that clarifies or simplifies a procedure.



The addition of this symbol to a “Danger” or “Warning” safety message indicates that an electrical hazard exists which will result in personal injury if the instructions are not followed.



This is the safety alert symbol. It is used to alert you to potential personal injury hazards. Obey all safety messages with this symbol to avoid possible injury or death.

## DANGER

**DANGER** indicates a hazardous situation which, if not avoided, **will result in death or serious injury.**

**Failure to follow these instructions will result in death or serious injury.**

## WARNING

**WARNING** indicates a hazardous situation which, if not avoided, **could result in death or serious injury.**

**Failure to follow these instructions can result in death, serious injury, or equipment damage.**

## CAUTION

**CAUTION** indicates a hazardous situation which, if not avoided, **could result in minor or moderate injury.**

**Failure to follow these instructions can result in injury or equipment damage.**

## NOTICE

**NOTICE** is used to address practices not related to physical injury. The safety alert symbol shall not be used with this type of safety message.

**Failure to follow these instructions can result in equipment damage.**

## Please Note

Electrical equipment should only be installed, operated, serviced, and maintained by qualified personnel. No responsibility is assumed by Schneider Electric for any consequences arising out of the use of this material.

A qualified person is one who has skills and knowledge related to the construction, installation, and operation of electrical equipment and has received safety training to recognize and avoid the hazards involved.

Per IEC 62040-1: "Uninterruptible power systems (UPS) -- Part 1: Safety Requirements," this equipment, including battery access, must be inspected, installed and maintained by a skilled person.

The skilled person is a person with relevant education and experience to enable him or her to perceive risks and to avoid hazards which the equipment can create (reference IEC 62040-1, section 3.102).

## Electromagnetic Compatibility

### NOTICE

#### RISK OF ELECTROMAGNETIC DISTURBANCE

This is a product category C2 UPS product. In a residential environment, this product may cause radio interference, in which case the user may be required to take additional measures.

**Failure to follow these instructions can result in equipment damage.**

## Safety Precautions

### ⚠ DANGER

#### HAZARD OF ELECTRIC SHOCK, EXPLOSION, OR ARC FLASH

- The product must be installed according to the specifications and requirements as defined by Schneider Electric. It concerns in particular the external and internal protections (upstream circuit breakers, battery circuit breakers, cabling, etc.) and environmental requirements. No responsibility is assumed by Schneider Electric if these requirements are not respected.
- After the UPS system has been electrically wired, do not start up the system. Start-up must only be performed by Schneider Electric.

**Failure to follow these instructions will result in death or serious injury.**

### ⚠ DANGER

#### HAZARD OF ELECTRIC SHOCK, EXPLOSION, OR ARC FLASH

The UPS System must be installed according to local and national regulations. Install the UPS according to:

- IEC 60364 (including 60364-4-41- protection against electric shock, 60364-4-42 - protection against thermal effect, and 60364-4-43 - protection against overcurrent), **or**
- NEC NFPA 70

depending on which one of the standards apply in your local area.

**Failure to follow these instructions will result in death or serious injury.**

### ⚠ DANGER

#### HAZARD OF ELECTRIC SHOCK, EXPLOSION, OR ARC FLASH

- Install the UPS system in a temperature controlled area free of conductive contaminants and humidity.
- Install the UPS system on a non-flammable, level, and solid surface (e.g. concrete) that can support the weight of the system.

**Failure to follow these instructions will result in death or serious injury.**



**⚠ DANGER**

**HAZARD OF ELECTRIC SHOCK, EXPLOSION, OR ARC FLASH**

The UPS is not designed for and must therefore not be installed in the following unusual operating environments:

- Damaging fumes
- Explosive mixtures of dust or gases, corrosive gases, or conductive or radiant heat from other sources
- Moisture, abrasive dust, steam or in an excessively damp environment
- Fungus, insects, vermin
- Salt-laden air or contaminated cooling refrigerant
- Pollution degree higher than 2 according to IEC 60664-1
- Exposure to abnormal vibrations, shocks, and tilting
- Exposure to direct sunlight, heat sources, or strong electromagnetic fields

**Failure to follow these instructions will result in death or serious injury.**

**NOTICE**

**RISK OF OVERHEATING**

Respect the clearance requirements around the UPS system and do not cover the product's ventilation openings when the UPS system is in operation.

**Failure to follow these instructions can result in equipment damage.**

**NOTICE**

**RISK OF EQUIPMENT DAMAGE**

Do not connect the UPS output to regenerative load systems including photovoltaic systems and speed drives.

**Failure to follow these instructions can result in equipment damage.**

## Model list



### UPS Models for External Batteries

- Galaxy VS UPS 20 kW 400 V, for external batteries, start-up 5x8 (GVSUPS20KHS)
- Galaxy VS UPS 30 kW 400 V, for external batteries, start-up 5x8 (GVSUPS30KHS)
- Galaxy VS UPS 40 kW 400 V, for external batteries, start-up 5x8 (GVSUPS40KHS)
- Galaxy VS UPS 50 kW 400 V, for external batteries, start-up 5x8 (GVSUPS50KHS)
- Galaxy VS UPS 60 kW 400 V, for external batteries, start-up 5x8 (GVSUPS60KHS)
- Galaxy VS UPS 80 kW 400 V, for external batteries, start-up 5x8 (GVSUPS80KHS)
- Galaxy VS UPS 100 kW 400 V, for external batteries, start-up 5x8 (GVSUPS100KHS)
- Galaxy VS UPS 120 kW 400 V, for external batteries, start-up 5x8 (GVSUPS120KHS)
- Galaxy VS UPS 150 kW 400 V, for external batteries, start-up 5x8 (GVSUPS150KHS)

### UPS Models for External Batteries with N+1 Power Module

- Galaxy VS UPS 20 kW 400 V, with N+1 power module for external batteries, start-up 5x8 (GVSUPS20KRHS)
- Galaxy VS UPS 30 kW 400 V, with N+1 power module for external batteries, start-up 5x8 (GVSUPS30KRHS)
- Galaxy VS UPS 40 kW 400 V, with N+1 power module for external batteries, start-up 5x8 (GVSUPS40KRHS)
- Galaxy VS UPS 50 kW 400 V, with N+1 power module for external batteries, start-up 5x8 (GVSUPS50KRHS)
- Galaxy VS UPS 60 kW 400 V, with N+1 power module for external batteries, start-up 5x8 (GVSUPS60KRHS)
- Galaxy VS UPS 80 kW 400 V, with N+1 power module for external batteries, start-up 5x8 (GVSUPS80KRHS)
- Galaxy VS UPS 100 kW 400 V, with N+1 power module for external batteries, start-up 5x8 (GVSUPS100KRHS)

## Scalable UPS Models for External Batteries

- Galaxy VS UPS 50 kW 400 V scalable to 150 kW for external batteries, halogen-free cables, start-up 5x8 (GVSUPS50K150HS)

## Marine-Certified UPS Models for External Batteries

- Galaxy VS UPS 20 kW 400 V, for external batteries, halogen-free cables, marine certified, start-up 5x8 (GVSUPS20KMHS)
- Galaxy VS UPS 30 kW 400 V, for external batteries, halogen-free cables, marine certified, start-up 5x8 (GVSUPS30KMHS)
- Galaxy VS UPS 40 kW 400 V, for external batteries, halogen-free cables, marine certified, start-up 5x8 (GVSUPS40KMHS)
- Galaxy VS UPS 50 kW 400 V, for external batteries, halogen-free cables, marine certified, start-up 5x8 (GVSUPS50KMHS)
- Galaxy VS UPS 60 kW 400 V, for external batteries, halogen-free cables, marine certified, start-up 5x8 (GVSUPS60KMHS)
- Galaxy VS UPS 80 kW 400 V, for external batteries, halogen-free cables, marine certified, start-up 5x8 (GVSUPS80KMHS)
- Galaxy VS UPS 100 kW 400 V, for external batteries, halogen-free cables, marine certified, start-up 5x8 (GVSUPS100KMHS)
- Galaxy VS UPS 120 kW 400 V, for external batteries, halogen-free cables, marine certified, start-up 5x8 (GVSUPS120KMHS)
- Galaxy VS UPS 150 kW 400 V, for external batteries, halogen-free cables, marine certified, start-up 5x8 (GVSUPS150KMHS)

# Single System Overview

UIB	Unit input breaker
SSIB	Static switch input breaker
IMB	Internal maintenance breaker
UOB	Unit output breaker
BB	Battery breaker

**Single System – Single Mains**

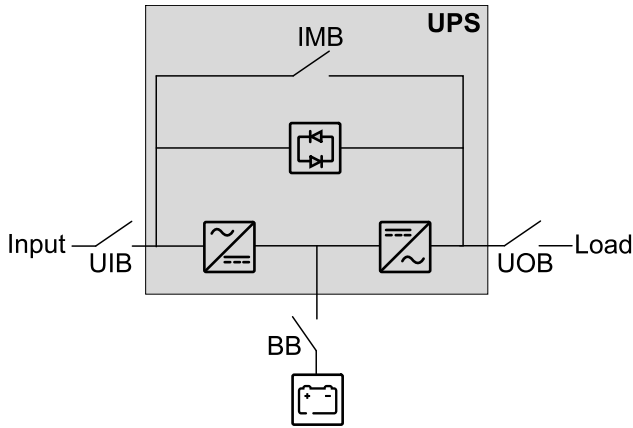

**Single System – Dual Mains**

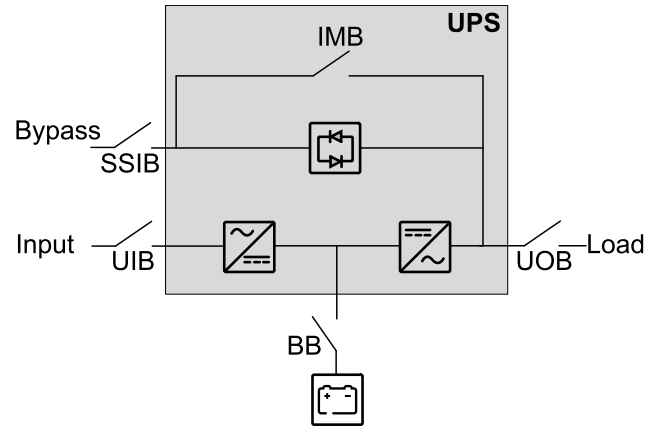

# Parallel System Overview

UIB	Unit input breaker
SSIB	Static switch input breaker
IMB	Internal maintenance breaker
UOB	Unit output breaker
SIB	System isolation breaker
BB	Battery breaker
MBB	External maintenance bypass breaker

## Simplified 1+1 Parallel System

Galaxy VS can support 2 UPSs in a simplified 1+1 parallel system for redundancy with shared unit input breaker UIB and static switch input breaker SSIB.

**Simplified 1+1 Parallel System – Single Mains**

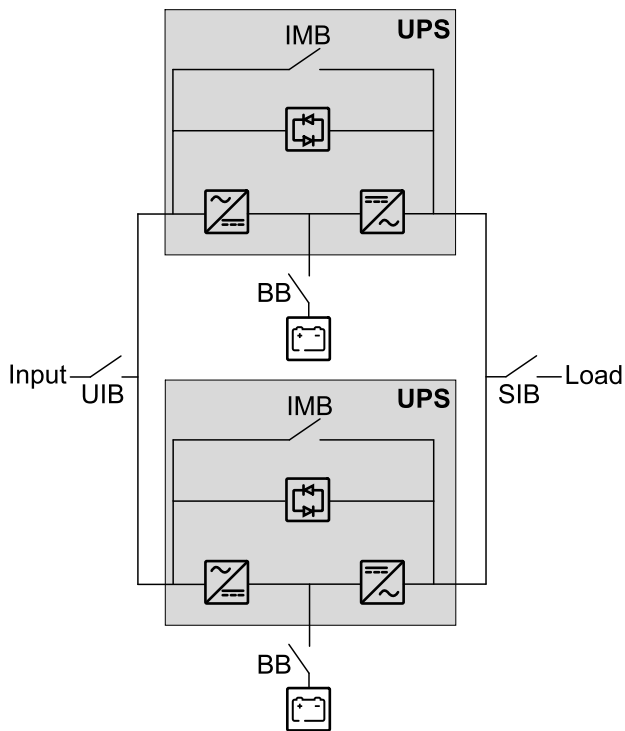

**Simplified 1+1 Parallel System – Dual Mains**

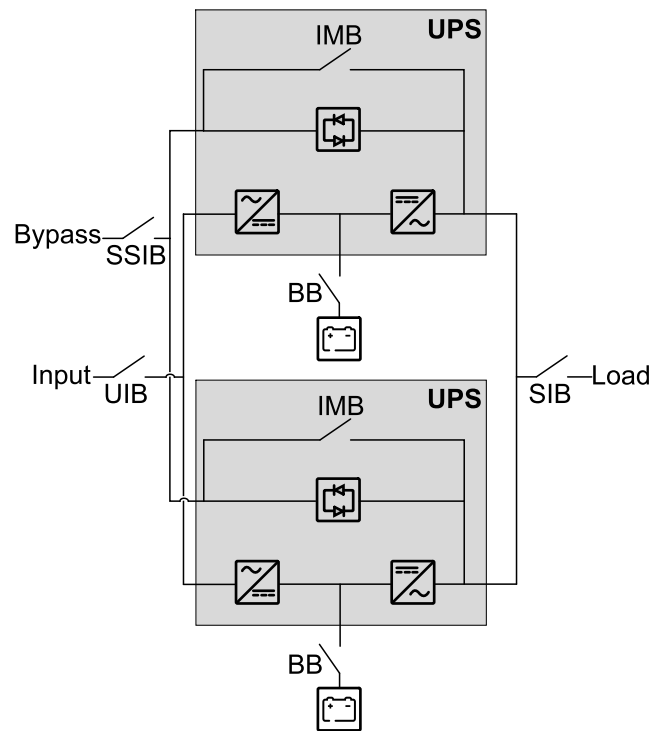

## Parallel System with Individual Unit Input Breaker UIB and Static Switch Input Breaker SSIB

Galaxy VS can support up to 4 UPSs in parallel for capacity and up to 3+1 UPSs in parallel for redundancy with individual unit input breaker UIB and static switch input breaker SSIB.

**NOTE:** The internal maintenance breaker IMB can only be used in a simplified 1+1 parallel system. In any other parallel system, an external maintenance bypass breaker MBB must be provided and the internal maintenance breaker IMB\* must be padlocked in the open position.

Parallel System – Single Mains

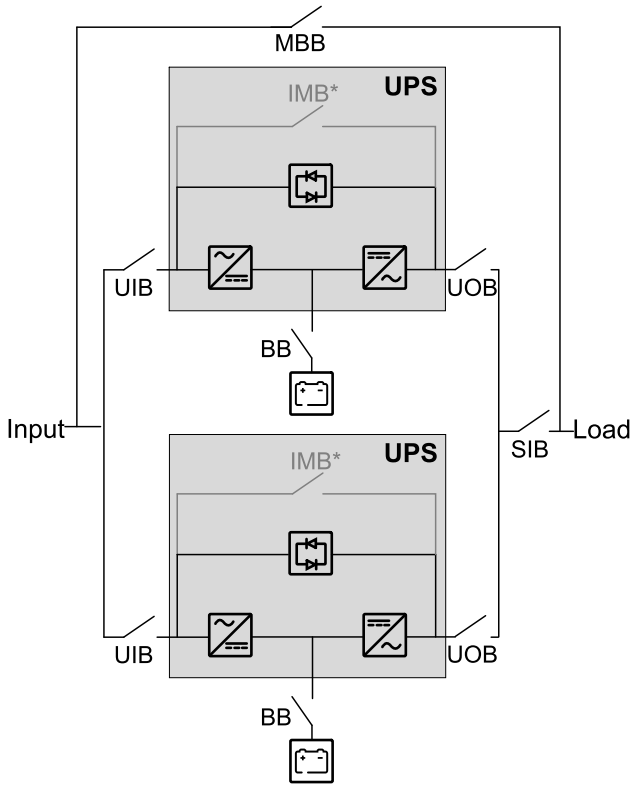

Parallel System – Dual Mains

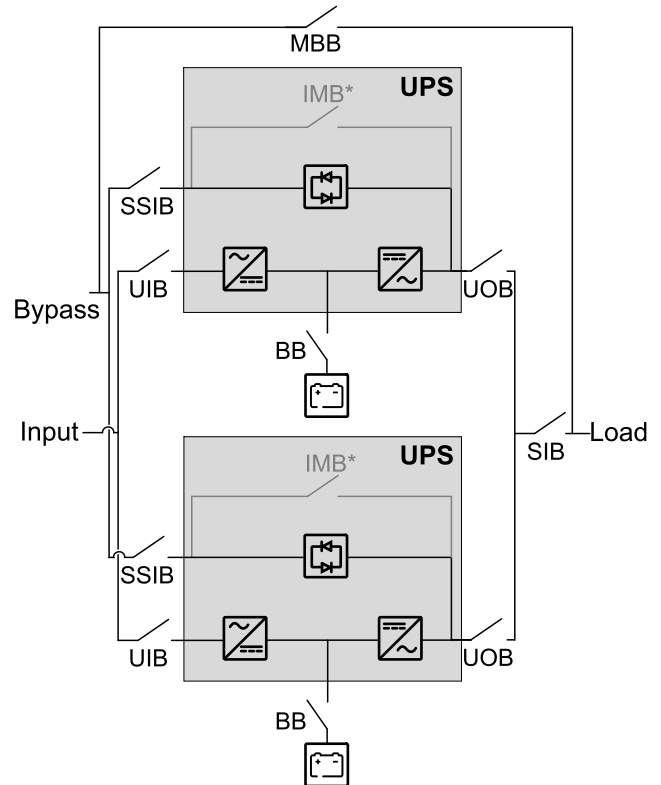

## Parallel System with Shared Unit Input Breaker UIB and Static Switch Input Breaker SSIB

Galaxy VS can support up to 4 UPSs in parallel for capacity and up to 3+1 UPSs in parallel for redundancy with shared unit input breaker UIB and static switch input breaker SSIB.

**NOTE:** The internal maintenance breaker IMB can only be used in a simplified 1+1 parallel system. In any other parallel system, an external maintenance bypass breaker MBB must be provided and the internal maintenance breaker IMB\* must be padlocked in the open position.

Parallel System – Single Mains

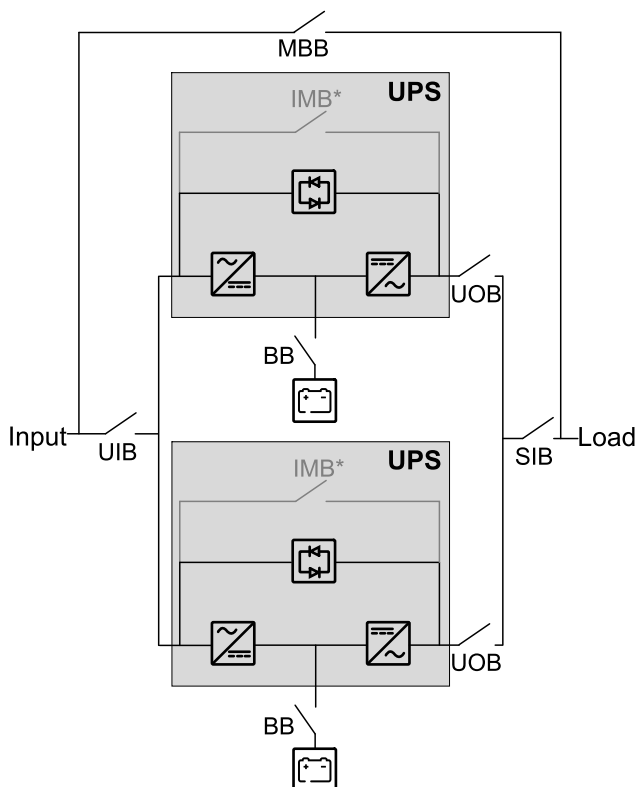

Parallel System – Dual Mains

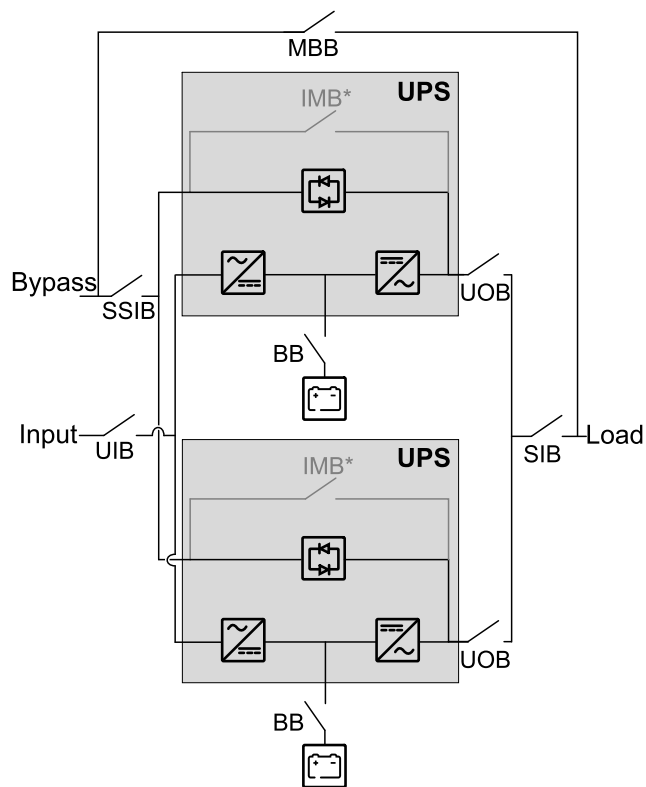

# Input Voltage Window

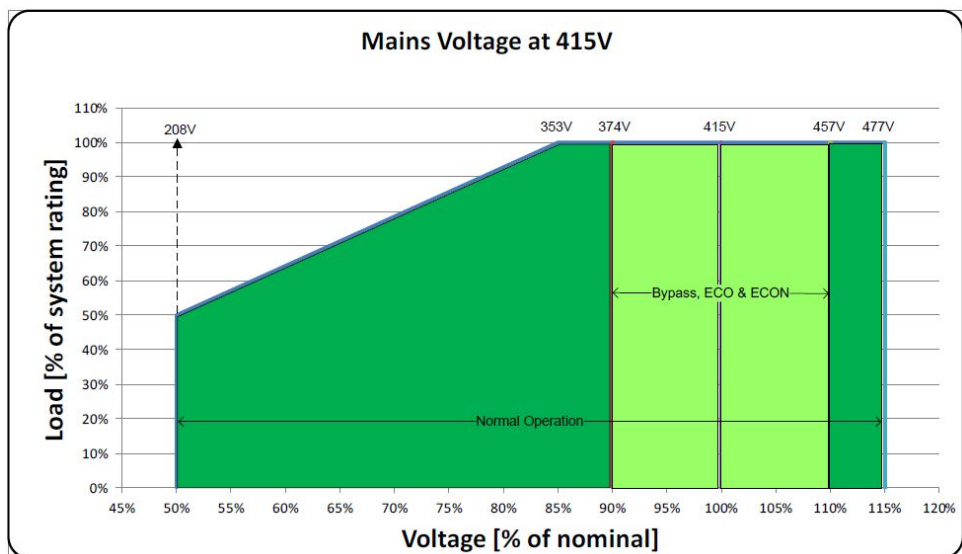
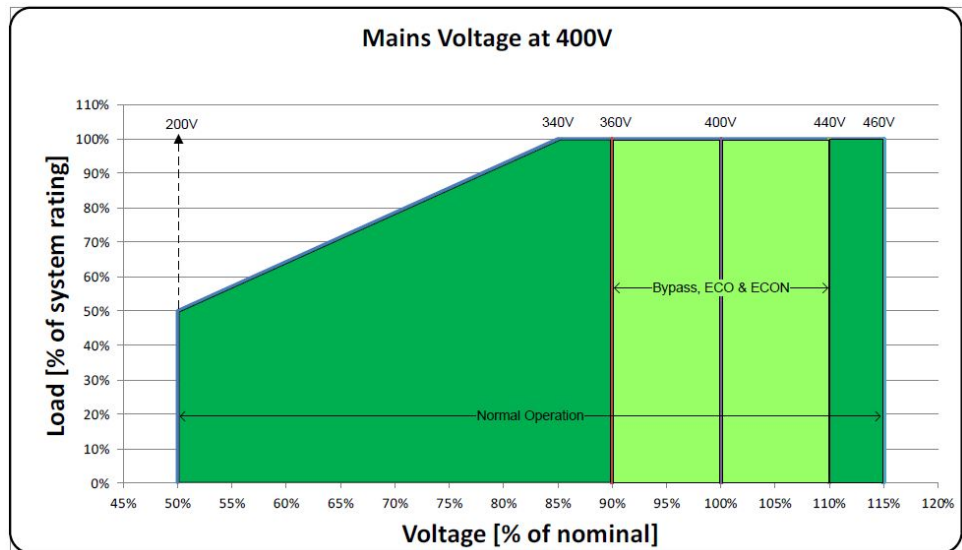
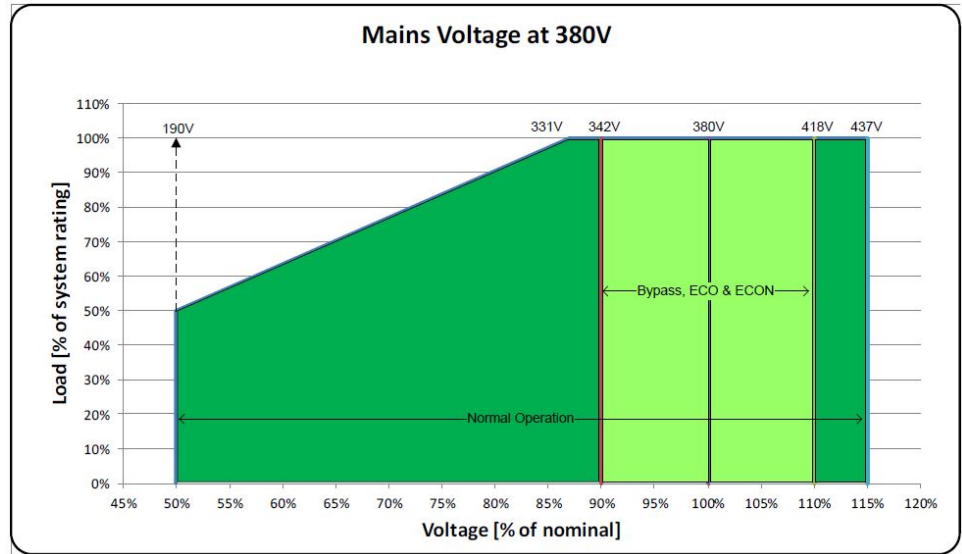



# Inverter Short Circuit Capabilities (Bypass not Available)

## IK1 – Short Circuit between a Phase and Neutral

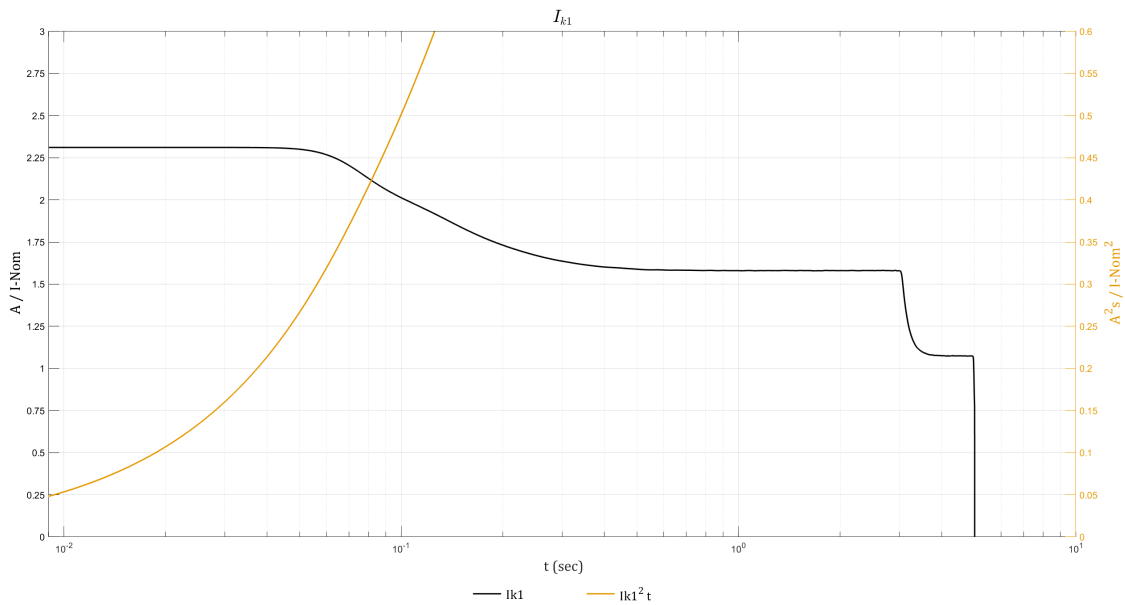

### IK1 400 V

S [kVA]	10ms; I[A]/I <sup>2</sup> t [A <sup>2</sup> t]	20ms; I[A]/I <sup>2</sup> t [A <sup>2</sup> t]	30ms; I[A]/I <sup>2</sup> t [A <sup>2</sup> t]	100ms; I[A]/I <sup>2</sup> t [A <sup>2</sup> t]	1s; I[A]/I <sup>2</sup> t [A <sup>2</sup> t]
10	33 / 11	33 / 22	33 / 33	29 / 104	23 / 603
15	50 / 25	50 / 50	50 / 75	44 / 235	34 / 1356
20	67 / 45	67 / 89	67 / 134	58 / 418	46 / 2411
30	100 / 100	100 / 200	100 / 300	87 / 940	68 / 5420
40	133 / 180	133 / 360	133 / 530	116 / 1670	91 / 9640
50	167 / 280	167 / 560	167 / 830	145 / 2610	114 / 15070
60	200 / 400	200 / 800	200 / 1200	174 / 3760	137 / 21700
80	267 / 710	267 / 1420	267 / 2140	232 / 6690	182 / 38580
100	334 / 1110	334 / 2230	334 / 3340	291 / 10450	228 / 60270
120	400 / 1600	400 / 3210	400 / 4810	349 / 15050	274 / 86800
150	500 / 2500	500 / 5010	500 / 7510	436 / 23510	342 / 135620

## IK2 – Short Circuit between Two Phases

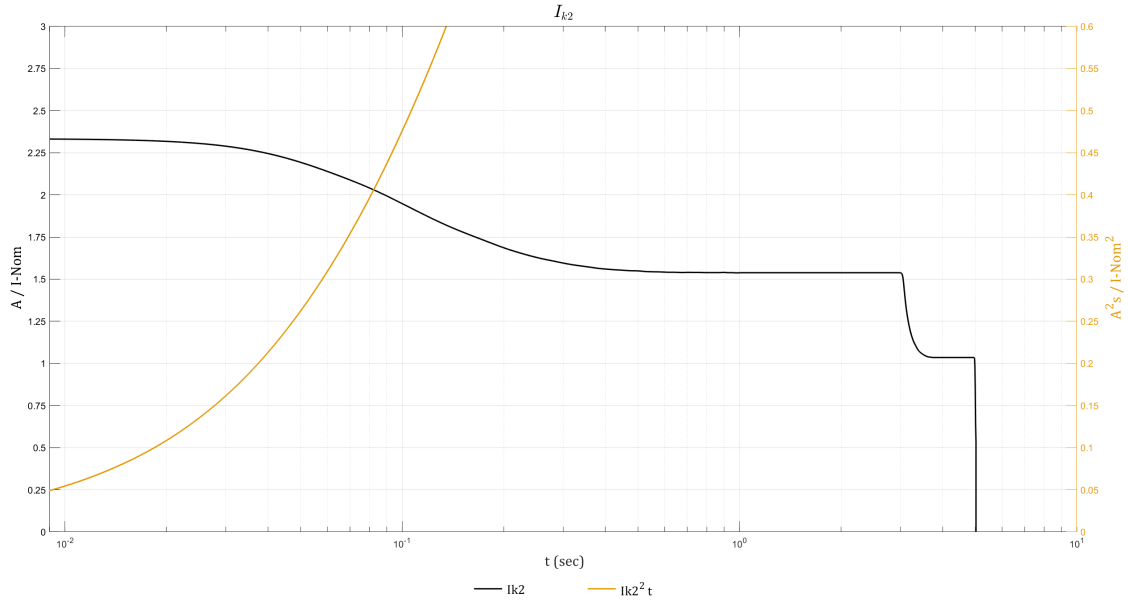

### IK2 400 V

S [kVA]	10ms; I[A]/I <sup>2</sup> t [A <sup>2</sup> t]	20ms; I[A]/I <sup>2</sup> t [A <sup>2</sup> t]	30ms; I[A]/I <sup>2</sup> t [A <sup>2</sup> t]	100ms; I[A]/I <sup>2</sup> t [A <sup>2</sup> t]	1s; I[A]/I <sup>2</sup> t [A <sup>2</sup> t]
10	34 / 11	33 / 23	33 / 34	28 / 99	22 / 571
15	50 / 26	50 / 51	50 / 76	42 / 223	33 / 1285
20	67 / 45	67 / 90	67 / 135	56 / 397	44 / 2284
30	101 / 100	100 / 200	100 / 300	84 / 890	67 / 5140
40	135 / 180	134 / 360	134 / 540	112 / 1590	89 / 9140
50	168 / 280	167 / 570	167 / 840	141 / 2480	111 / 14280
60	202 / 410	201 / 810	201 / 1210	169 / 3570	133 / 20560
80	269 / 730	268 / 1450	268 / 2150	225 / 6350	178 / 36550
100	336 / 1130	335 / 2260	335 / 3370	281 / 9920	222 / 57110
120	404 / 1630	401 / 3250	401 / 4850	337 / 14280	266 / 82230
150	505 / 2550	502 / 5090	502 / 7580	422 / 22320	333 / 128490

## IK3 – Short Circuit between Three Phases

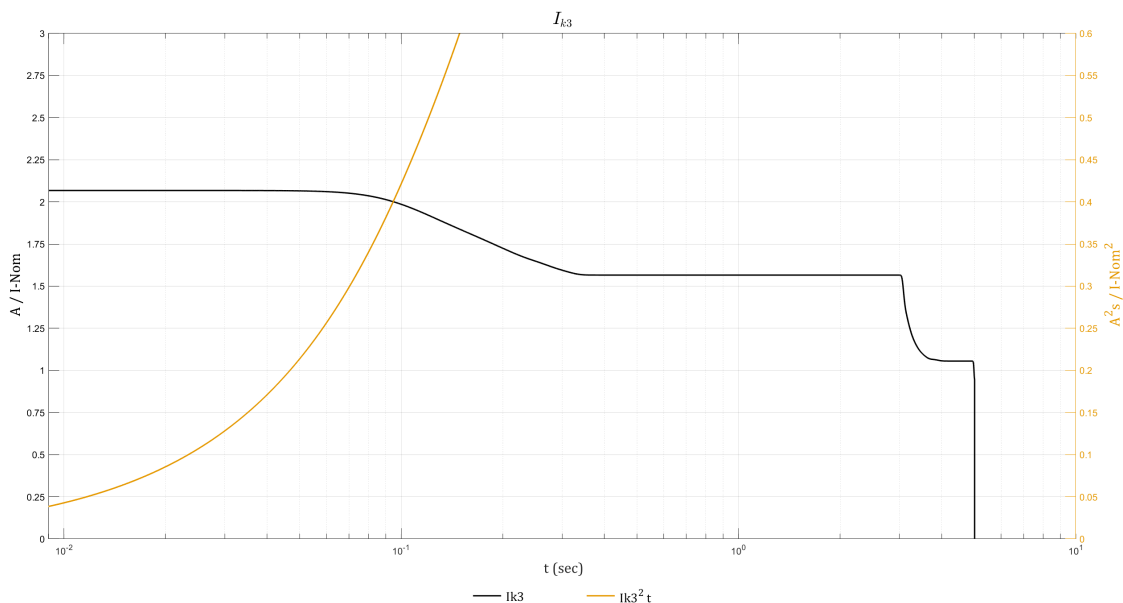

### IK3 400 V

S [kVA]	10ms; I[A]/I <sup>2</sup> t [A <sup>2</sup> t]	20ms; I[A]/I <sup>2</sup> t [A <sup>2</sup> t]	30ms; I[A]/I <sup>2</sup> t [A <sup>2</sup> t]	100ms; I[A]/I <sup>2</sup> t [A <sup>2</sup> t]	1s; I[A]/I <sup>2</sup> t [A <sup>2</sup> t]
10	30 / 9	30 / 18	30 / 27	29 / 88	23 / 574
15	45 / 20	45 / 40	45 / 60	43 / 198	34 / 1290
20	60 / 36	60 / 71	60 / 107	57 / 351	45 / 2294
30	90 / 80	90 / 160	90 / 240	86 / 790	68 / 5160
40	119 / 140	119 / 290	119 / 430	115 / 1400	90 / 9180
50	149 / 220	149 / 450	149 / 670	143 / 2200	113 / 14340
60	179 / 320	179 / 640	179 / 960	172 / 3160	136 / 20650
80	239 / 570	239 / 1140	239 / 1710	229 / 5620	181 / 36710
100	298 / 890	298 / 1780	298 / 2670	287 / 8780	226 / 57350
120	358 / 1280	358 / 2570	358 / 3850	344 / 12640	271 / 82590
150	448 / 2000	448 / 4010	448 / 6010	430 / 19760	339 / 129040

# Efficiency

**NOTE:** The values for 60 kW in battery operation are preliminary values.

20 kW	Normal operation			ECO mode		
Voltage (V)	380	400	415	380	400	415
25% load	94.0%	94.4%	94.1%	96.9%	96.7%	96.7%
50% load	95.7%	96.1%	95.9%	98.1%	98.2%	98.2%
75% load	96.4%	96.6%	96.6%	98.6%	98.7%	98.7%
100% load	96.7%	96.9%	96.9%	98.8%	98.9%	98.9%

20 kW	eConversion			Battery operation		
Voltage (V)	380	400	415	380	400	415
25% load	95.6%	95.4%	95.3%	93.6%	93.6%	93.6%
50% load	97.7%	97.6%	97.6%	95.7%	95.7%	95.7%
75% load	98.4%	98.3%	98.3%	96.3%	96.3%	96.3%
100% load	98.7%	98.7%	98.7%	96.6%	96.6%	96.6%

30 kW	Normal operation			ECO mode		
Voltage (V)	380	400	415	380	400	415
25% load	95.0%	95.5%	95.3%	97.7%	97.7%	97.7%
50% load	96.4%	96.6%	96.6%	98.6%	98.7%	98.7%
75% load	96.7%	97.0%	96.9%	98.9%	98.9%	99.0%
100% load	96.8%	97.0%	97.0%	99.1%	99.1%	99.1%

30 kW	eConversion			Battery operation		
Voltage (V)	380	400	415	380	400	415
25% load	97.0%	96.9%	96.8%	95.0%	95.0%	95.0%
50% load	98.4%	98.3%	98.3%	96.3%	96.3%	96.3%
75% load	98.8%	98.8%	98.8%	96.6%	96.6%	96.6%
100% load	99.0%	99.0%	99.0%	96.7%	96.7%	96.7%

40 kW	Normal operation			ECO mode		
Voltage (V)	380	400	415	380	400	415
25% load	95.7%	96.1%	95.9%	98.1%	98.2%	98.2%
50% load	96.7%	96.9%	96.9%	98.8%	98.9%	98.9%
75% load	96.8%	97.0%	97.0%	99.1%	99.1%	99.1%
100% load	96.7%	96.9%	96.9%	99.2%	99.2%	99.2%

40 kW	eConversion			Battery operation		
Voltage (V)	380	400	415	380	400	415
25% load	97.7%	97.6%	97.6%	95.7%	95.7%	95.7%
50% load	98.7%	98.7%	98.7%	96.6%	96.6%	96.6%
75% load	99.0%	99.0%	99.0%	96.7%	96.7%	96.7%
100% load	99.2%	99.2%	99.2%	96.6%	96.6%	96.6%

50 kW	Normal operation			ECO mode		
Voltage (V)	380	400	415	380	400	415
25% load	96.2%	96.4%	96.3%	98.4%	98.5%	98.4%
50% load	96.8%	97.0%	97.0%	99.0%	99.0%	99.0%
75% load	96.7%	97.0%	97.0%	99.2%	99.2%	99.2%
100% load	96.4%	96.7%	96.8%	99.2%	99.3%	99.3%

50 kW	eConversion			Battery operation		
Voltage (V)	380	400	415	380	400	415
25% load	98.1%	98.0%	98.0%	96.1%	96.1%	96.1%
50% load	98.9%	98.9%	98.9%	96.7%	96.7%	96.7%
75% load	99.2%	99.1%	99.1%	96.7%	96.7%	96.7%
100% load	99.3%	99.3%	99.3%	96.5%	96.5%	96.5%

60 kW	Normal operation			ECO mode		
Voltage (V)	380	400	415	380	400	415
25% load	96.0%	96.0%	96.0%	98.3%	98.3%	98.3%
50% load	96.8%	96.9%	96.9%	98.9%	98.9%	98.9%
75% load	96.9%	97.0%	97.0%	99.1%	99.1%	99.1%
100% load	96.7%	96.9%	97.0%	99.2%	99.2%	99.2%

60 kW	eConversion			Battery operation		
Voltage (V)	380	400	415	380	400	415
25% load	98.1%	98.0%	97.9%	95.2%	95.2%	95.2%
50% load	98.8%	98.8%	98.7%	96.4%	96.4%	96.4%
75% load	99.1%	99.0%	99.1%	96.7%	96.7%	96.7%
100% load	99.1%	99.1%	99.2%	96.7%	96.7%	96.7%

80 kW	Normal operation			ECO mode		
Voltage (V)	380	400	415	380	400	415
25% load	96.2%	96.3%	96.3%	98.6%	98.6%	98.6%
50% load	96.9%	97.1%	97.0%	99.0%	99.1%	99.1%
75% load	96.9%	97.1%	97.1%	99.2%	99.2%	99.2%
100% load	96.8%	97.0%	97.1%	99.3%	99.3%	99.3%

80 kW	eConversion			Battery operation		
Voltage (V)	380	400	415	380	400	415
25% load	98.1%	98.0%	98.0%	95.8%	95.8%	95.8%
50% load	98.9%	98.9%	98.9%	96.6%	96.6%	96.6%
75% load	99.1%	99.1%	99.1%	96.7%	96.7%	96.7%
100% load	99.3%	99.3%	99.3%	96.6%	96.6%	96.6%

100 kW	Normal operation			ECO mode		
Voltage (V)	380	400	415	380	400	415
25% load	96.5%	96.6%	96.6%	98.8%	98.8%	98.8%
50% load	96.9%	97.1%	97.1%	99.1%	99.1%	99.2%

100 kW	Normal operation			ECO mode		
Voltage (V)	380	400	415	380	400	415
75% load	96.9%	97.1%	97.2%	99.3%	99.3%	99.3%
100% load	96.6%	96.8%	96.9%	99.3%	99.3%	99.4%

100 kW	eConversion			Battery operation		
Voltage (V)	380	400	415	380	400	415
25% load	98.4%	98.4%	98.4%	96.2%	96.2%	96.2%
50% load	99.1%	99.1%	99.0%	96.7%	96.7%	96.7%
75% load	99.2%	99.3%	99.3%	96.7%	96.7%	96.7%
100% load	99.3%	99.3%	99.3%	96.5%	96.5%	96.5%

120 kW	Normal operation			ECO mode		
Voltage (V)	380	400	415	380	400	415
25% load	96.5%	96.5%	96.5%	98.7%	98.7%	98.7%
50% load	97.0%	97.0%	97.1%	99.1%	99.1%	99.1%
75% load	96.9%	97.0%	97.1%	99.2%	99.2%	99.2%
100% load	96.6%	96.7%	96.9%	99.2%	99.3%	99.3%

120 kW	eConversion			Battery operation		
Voltage (V)	380	400	415	380	400	415
25% load	98.4%	98.4%	98.4%	NA	NA	NA
50% load	99.0%	99.0%	99.0%	NA	NA	NA
75% load	99.2%	99.2%	99.2%	NA	NA	NA
100% load	99.3%	99.3%	99.3%	NA	NA	NA

150 kW	Normal operation			ECO mode		
Voltage (V)	380	400	415	380	400	415
25% load	96.5%	96.5%	96.5%	98.8%	98.9%	98.9%
50% load	97.0%	97.1%	97.1%	99.1%	99.2%	99.2%
75% load	96.9%	97.0%	97.1%	99.2%	99.2%	99.3%
100% load	96.5%	96.8%	96.9%	99.2%	99.3%	99.3%

150 kW	eConversion			Battery operation		
Voltage (V)	380	400	415	380	400	415
25% load	98.6%	98.6%	98.5%	NA	NA	NA
50% load	99.1%	99.1%	99.1%	NA	NA	NA
75% load	99.2%	99.3%	99.3%	NA	NA	NA
100% load	99.2%	99.3%	99.3%	NA	NA	NA

# Derating Due to Load Power Factor

0.7 leading to 0.7 lagging without derating.

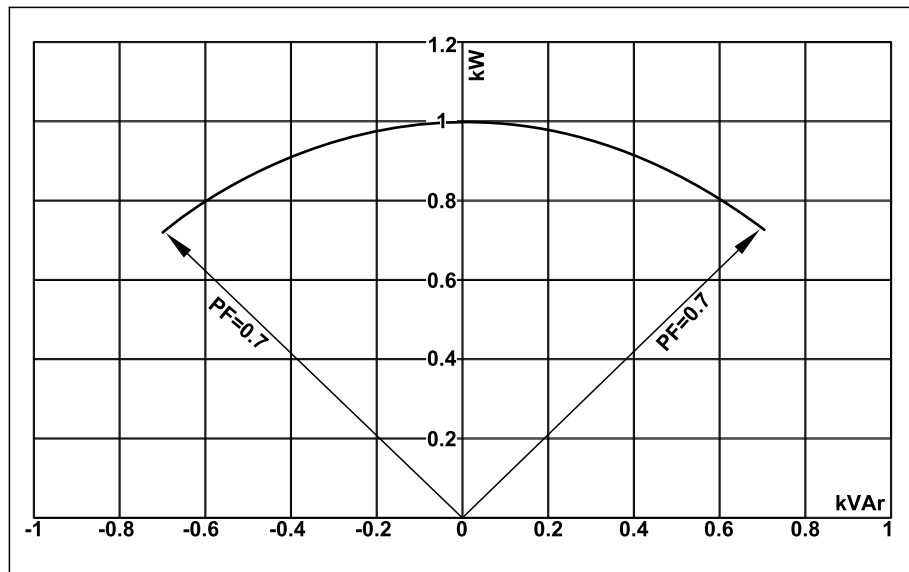

UPS rating	UPS output					
	Lagging			Leading		
PF=1	PF=0.7	PF=0.8	PF=0.9	PF=0.9	PF=0.8	PF=0.7
20 kVA/kW	20 kVA / 14 kW	20 kVA / 16 kW	20 kVA / 18 kW	20 kVA / 18 kW	20 kVA / 16 kW	20 kVA / 14 kW
30 kVA/kW	30 kVA / 21 kW	30 kVA / 24 kW	30 kVA / 27 kW	30 kVA / 27 kW	30 kVA / 24 kW	30 kVA / 21 kW
40 kVA/kW	40 kVA / 28 kW	40 kVA / 32 kW	40 kVA / 36 kW	40 kVA / 36 kW	40 kVA / 32 kW	40 kVA / 28 kW
50 kVA/kW	50 kVA / 35 kW	50 kVA / 40 kW	50 kVA / 45 kW	50 kVA / 45 kW	50 kVA / 40 kW	50 kVA / 35 kW
60 kVA/kW	60 kVA / 42 kW	60 kVA / 48 kW	60 kVA / 54 kW	60 kVA / 54 kW	60 kVA / 48 kW	60 kVA / 42 kW
80 kVA/kW	80 kVA / 56 kW	80 kVA / 64 kW	80 kVA / 72 kW	80 kVA / 72 kW	80 kVA / 64 kW	80 kVA / 56 kW
100 kVA/kW	100 kVA / 70 kW	100 kVA / 80 kW	100 kVA / 90 kW	100 kVA / 90 kW	100 kVA / 80 kW	100 kVA / 70 kW
120 kVA/kW	120 kVA / 84 kW	120 kVA / 96 kW	120 kVA / 108 kW	120 kVA / 108 kW	120 kVA / 96 kW	120 kVA / 84 kW
150 kVA/kW	150 kVA / 105 kW	150 kVA / 120 kW	150 kVA / 135 kW	150 kVA / 135 kW	150 kVA / 120 kW	150 kVA / 105 kW

# Leakage Current

## 380/400/415 V UPS system 4-wire installation at 100% load

UPS rating	Leakage current
20-50 kW	62 mA
60-100 kW	67 mA
120-150 kW	91 mA



# Batteries

## End of Discharge Voltage

The voltage is 1.6 to 1.75 per cell depending on discharge ratio.

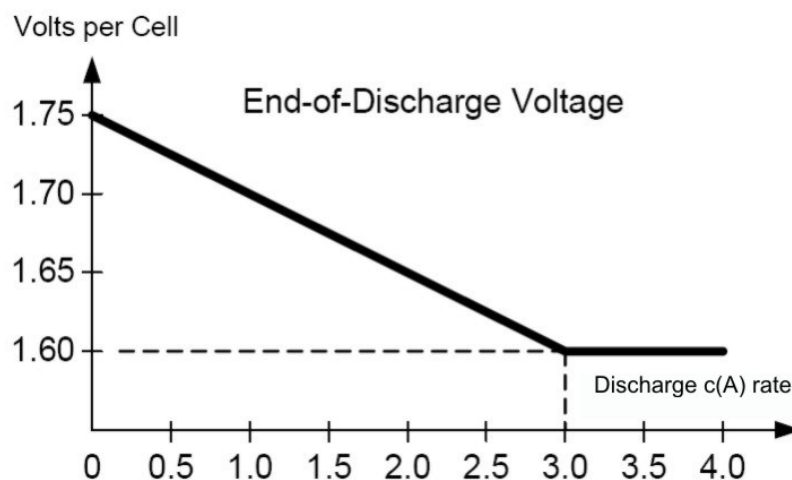

## Standard VRLA Voltage Levels

Standard VRLA Voltage Levels  
(at nominal temperature)

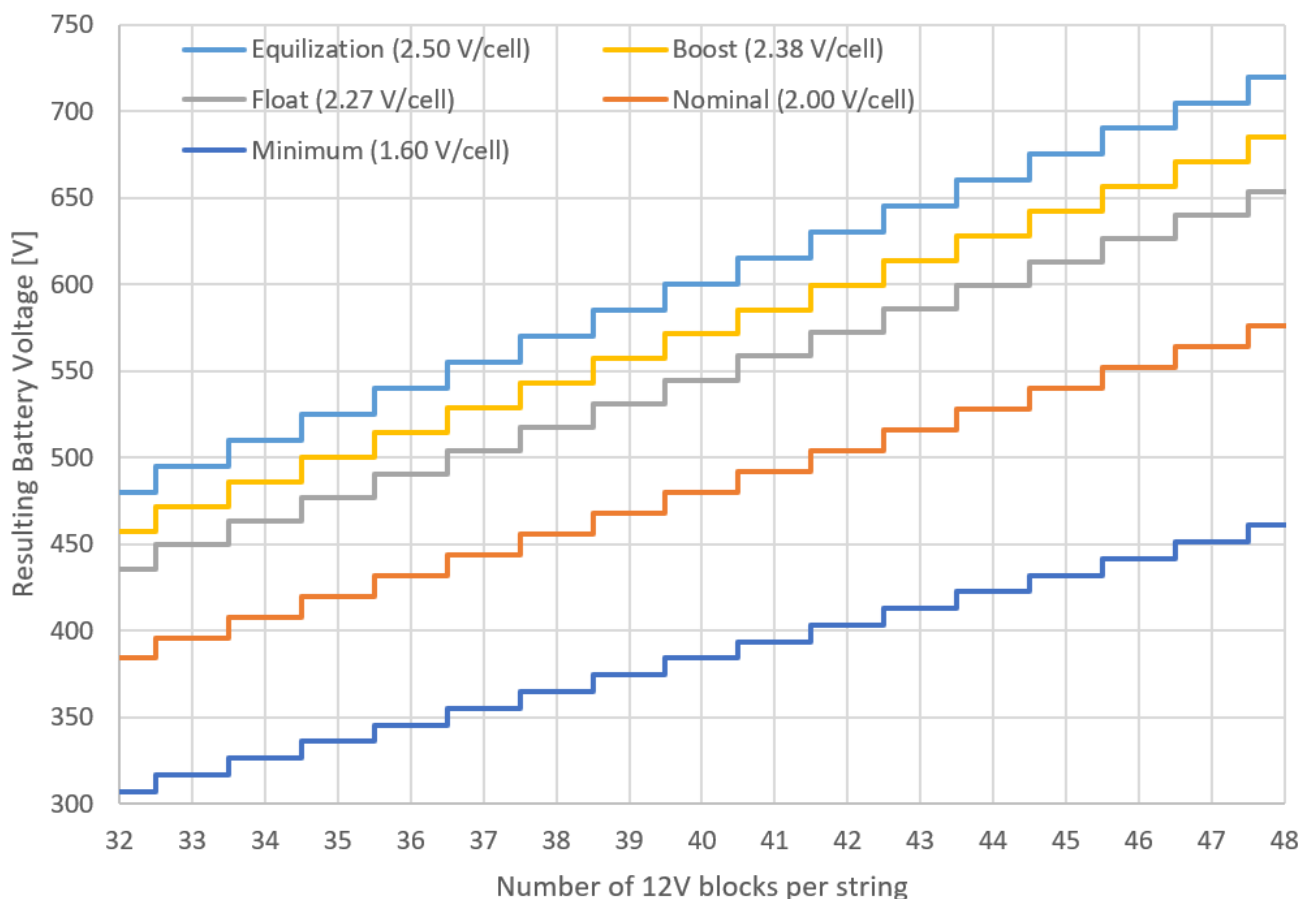

**NOTE:** Specific configurations may differ from the general constraint shown above.

## Compliance

Safety	IEC 62040-1: 2017, Edition 2.0, Uninterruptible Power Systems (UPS) - Part 1: Safety requirements UL 1778 5th edition
EMC/EMI/RFI	IEC 62040-2: 2016, 3rd edition Uninterruptible Power Systems (UPS) - Part 2: Electromagnetic compatibility (EMC) requirements C2 FCC Part 15 Subpart B, Class A IEEE C62.41-1991 Location Category B1, IEEE Recommended Practice on Surge Voltages in Low-Voltage AC Power Circuits
Transportation	IEC 60721-4-2 Level 2M2
Seismic	ICC-ES AC 156 (2015); OSHPD Pre-approved; Sds=1.45 g for z/h=1 and Sds=2.00 g for z/h=0; Ip=1.5
Earthing system	TN-C, TN-S, TT, IT
Overvoltage category	This UPS is OVCII compliant. If the UPS is installed in an environment with an OVC rating higher than II, an SPD (surge protection device) must be installed upstream of the UPS to reduce the overvoltage category to OVCII.
Protective class	I
Pollution degree	2
Marine <sup>1</sup>	TYPE APPROVAL CERTIFICATE is found to comply with DNV GL rules for classification – Ships, offshore units, and high speed and light craft (Class Guideline: DNVGL-CG-0339). Certificate number: TAE00004A2 TYPE APPROVAL CERTIFICATE is found to comply with Bureau Veritas Rules for the Classification of Steel Ships (Test Specification: E10). Certificate number: 64254/A0 BV

## Performance

Performance in accordance with: IEC 62040-3: 2021, 3rd edition Uninterruptible Power Systems (UPS) - Part 3: Method of specifying the performance and test requirements.

Output performance classification (according to IEC 62040-3, Clause 5.3.4): VFI-SS-11

## Regional Seismic Compliance

Certificate available upon request.

Country/Region	Code ID	Hazard level ground	Hazard level roof
Argentina	INPRES-CIRSOC103	Zone 4	Zone 4
Australia	AS 1170.4-2007	Z = 0.22	Z = 0.22
Canada <sup>2</sup>	2020 NBCC	S <sub>a</sub> = 2.0	S <sub>a</sub> = 1.46
Chile	NCh 433.Of1996	Zone 3	Zone 2
China	GB 50011-2010 (2016)	α <sub>Max</sub> = 1.4	α <sub>Max</sub> = 1.2
Europe	Eurocode 8 EN1998-1	α <sub>gR</sub> = 0.45	α <sub>gR</sub> = 0.3
India	IS 1893 (Part 1) : 2016	Z = 0.36	Z = 0.36
Japan	Building Standard Law	Zone A	Zone A
New Zealand	NZS 1170.5:2004+A1	Z = 0.6	Z = 0.42
Peru	N.T.E. - E.030	Zone 4	Zone 4
Russia	SNIP II-7-81 (SP 14.13330.2014)	MSK 10	MSK 9
Taiwan	CPA 2011 Seismic Design Code	S <sub>s</sub> <sup>D</sup> = 0.8	S <sub>s</sub> <sup>D</sup> = 0.8
U.S.A. <sup>2</sup>	ASCE 7-16 / IBC 2018	S <sub>DS</sub> = 2.0	S <sub>DS</sub> = 1.47

1. Only for marine UPS models.

2. OSHPD Pre-approved in accordance with AC156 test protocol.

# Communication and Management

Local area network	1 Gbps – 1 port as default
Modbus	Modbus (SCADA)
Output relays	4 x SELV configurable
Input contacts	4 x SELV configurable
Standard control panel	4.3 inch touchscreen display
Audible alarm	Yes
Emergency Power Off (EPO)	Options: <ul style="list-style-type: none"> <li>• Normally Open (NO)</li> <li>• Normally Closed (NC)</li> <li>• External 24 VDC SELV</li> </ul>
External switchgear	UIB UOB SSIB MBB SIB
External synchronization	No
Battery monitoring	Available for external battery solutions

## EPO

### EPO Configurations (640–4864 terminal J6600, 1–9)

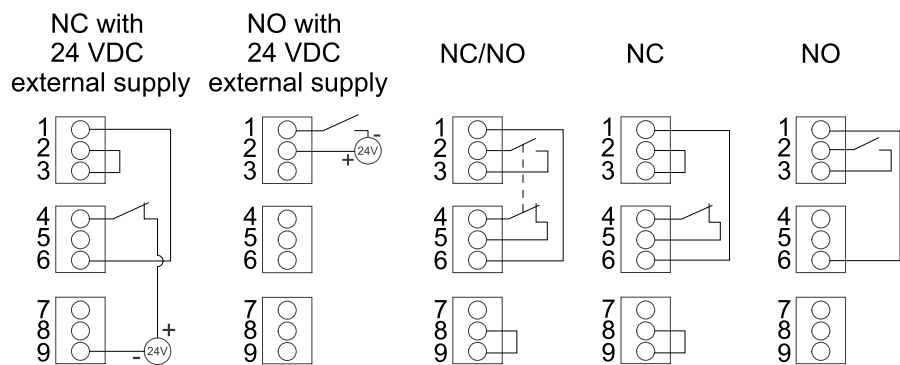

The EPO input supports 24 VDC.

**NOTE:** The default setting for the EPO activation is to turn off the inverter.

If you want the EPO activation to transfer the UPS into forced static bypass operation instead, please contact Schneider Electric.

# Configurable Input Contacts and Output Relays

## Input Contacts

Four input contacts are available and can be configured to indicate a given event via the display. The input contacts support 24 VDC 10 mA.

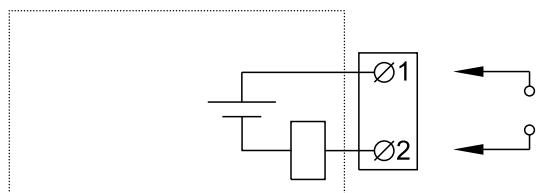

Name	Description	Location
IN _1 (input contact 1)	Configurable input contact	640-4864 terminal J6616, 1–2
IN _2 (input contact 2)	Configurable input contact	640-4864 terminal J6616, 3–4
IN _3 (input contact 3)	Configurable input contact	640-4864 terminal J6616, 5–6
IN _4 (input contact 4)	Configurable input contact	640-4864 terminal J6616, 7–8

## Output Relays

Four output relays are available and can be configured to activate on one or more events via the display.

The output relays support 24 VAC/VDC 1 A. All external circuitry must be fused with maximum 1 A fast acting fuses.

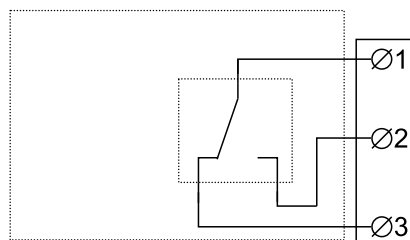

Name	Description	Location
OUT _1 (output relay 1)	Configurable output relay	640-4864 terminal J6617, 1–3
OUT _2 (output relay 2)	Configurable output relay	640-4864 terminal J6617, 4–6
OUT _3 (output relay 3)	Configurable output relay	640-4864 terminal J6617, 7–9
OUT _4 (output relay 4)	Configurable output relay	640-4864 terminal J6617, 10–12

**Energized check mode:** When this mode is enabled, it means that the output relay is activated when the events associated with the output relay are not present (normally activated). **Energized check mode** is individually set for each output relay and makes it possible to detect if the power supply to the output relays is lost, as all output relays will deactivate and the events associated with the output relays will be indicated as present.

# Requirements for a Third Party Battery Solution

Battery breaker boxes from Schneider Electric are recommended for the battery interface. Please contact Schneider Electric for more information.

## Third Party Battery Breaker Requirements

 **DANGER**

**HAZARD OF ELECTRIC SHOCK, EXPLOSION, OR ARC FLASH**

All selected battery breakers must be equipped with instantaneous trip functionality with an undervoltage release coil or a shunt trip release coil.

**Failure to follow these instructions will result in death or serious injury.**

**NOTE:** There are more factors to consider when selecting a battery breaker than the requirements listed below. Please contact Schneider Electric for more information.

### Design Requirements for Battery Breaker

Battery breaker rated DC voltage > Normal battery voltage	The normal voltage of the battery configuration is defined as the highest nominal occurring battery voltage. This can be equivalent to the float voltage which may be defined as <b>number of battery blocks x number of cells x cell float voltage</b> .
Battery breaker rated DC current > Rated discharge battery current	This current is controlled by the UPS and must include maximum discharge current. This will typically be the current at the end of discharge (minimum operation DC voltage or in overload condition or a combination).
DC landings	Two DC landings for DC cables are required.
AUX switches for monitoring	One AUX switch must be installed in each battery breaker and connected to the UPS. The UPS can monitor up to two battery breakers.
Short-circuit breaking capability	The short-circuit breaking capability must be higher than the short-circuit DC current of the (largest) battery configuration.
Minimum trip current	The minimum short-circuit current to trip the battery breaker must match the (smallest) battery configuration, to make the breaker trip in case of a short circuit, up to the end of its life time.

## Guidance for Organizing Battery Cables

**NOTE:** For 3rd party batteries, use only high rate batteries for UPS applications.

**NOTE:** When the battery bank is placed remotely, the organizing of the cables is important to reduce voltage drop and inductance. The distance between the battery bank and the UPS must not exceed 200 m (656 ft). Contact Schneider Electric for installations with a longer distance.

**NOTE:** To minimize the risk of electromagnetic radiation, it is highly recommended to follow the below guidance and to use grounded metallic tray supports.

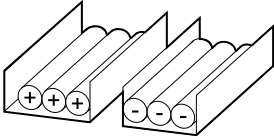
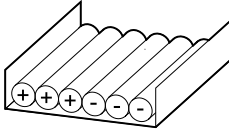
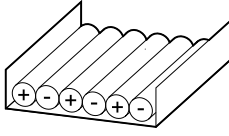
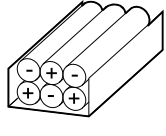
Cable Length				
<30 m	Not recommended	Acceptable	Recommended	Recommended
31–75 m	Not recommended	Not recommended	Acceptable	Recommended
76–150 m	Not recommended	Not recommended	Acceptable	Recommended
151–200 m	Not recommended	Not recommended	Not recommended	Recommended

# Specifications for 400 V Systems

## Input Specifications 400 V

UPS rating	20 kW	30 kW	40 kW	50 kW	60 kW	80 kW	100 kW	120 kW	150 kW
Voltage (V)	380/400/415								
Connections	Input connections in single mains system: 4-wire (L1, L2, L3, N, PE) WYE Input connections in dual mains system: 3-wire (L1, L2, L3, PE) WYE <sup>3 4</sup>								
Input voltage range (V)	380 V: 331-437 400 V: 340-460 415 V: 353-477								
Frequency range (Hz)	40-70								
Nominal input current (A)	32/30/29	47/45/43	63/60/58	79/75/72	95/90/87	126/120/116	158/150/144	189/180/173	237/225/217
Maximum input current (A)	39/37/36	58/55/53	77/73/70	93/92/91	116/110/106	154/146/141	185/183/176	231/220/212	281/278/274
Input current limitation (A)	40/38/37	60/57/55	79/75/73	93/93/91	119/113/109	158/148/145	185/184/180	238/226/218	278/278/274
Input power factor	0.99 for load greater than 50% 0.95 for load greater than 25%								
Total harmonic distortion (THDI)	<5% at 100% load	<3% at 100% load							
Minimum short circuit rating	Dependent on upstream protection. See section for ' <b>Recommended Upstream Protection 400 V</b> ' for details.								
Maximum short circuit rating	65 kA RMS								
Protection	Built-in backfeed protection and fuses								
Ramp-in	Programmable and adaptive 1-40 seconds								

**NOTE:** For a UPS with N+1 power module, the input power factor is 0.99 at 100% load and the total harmonic distortion (THDI) is <6% at full linear load (symmetrical).

3. TN, TT, and IT power distribution systems are supported. For further information, contact Schneider Electric.

4. **Only for dual mains system with upstream 4-pole breakers:** Install an N connection with the input cables (L1, L2, L3, N, PE). Refer to earthing schematics for TN-S dual mains 4-pole circuit breaker.



## Bypass Specifications 400 V

UPS rating	20 kW	30 kW	40 kW	50 kW	60 kW	80 kW	100 kW	120 kW	150 kW
Voltage (V)	380/400/415								
Connections	4-wire (L1, L2, L3, N, PE) WYE								
Bypass voltage range (V)	380 V: 342-418 400 V: 360-440 415 V: 374-457								
Frequency range (Hz)	50/60 ± 1, 50/60 ± 3, 50/60 ± 10 (user selectable)								
Nominal bypass current (A)	32/30/29	47/45/43	62/59/57	78/74/71	94/88/85	125/119/114	156/148/143	187/178/172	234/223/215
Nominal neutral current (A) <sup>5</sup>	53/50/48	79/75/72	105/100/96	131/125/120	158/150/144	210/200/193	271/250/241	263/250/241	263/250/241
Minimum short circuit rating	Dependent on upstream protection. See section for ' <b>Recommended Upstream Protection 400 V</b> ' for details.								
Maximum short circuit rating	65 kA RMS								
Protection	Built-in backfeed protection and fuses Internal fuse specifications: Rated 400 A, prearcing 33 kA <sup>2</sup> s						Built-in backfeed protection and fuses Internal fuse specifications: Rated 550 A, prearcing 52 kA <sup>2</sup> s		

5. Harmonic currents in neutral are only considered to be 1.73 x nominal up till 100 kW. Above 100 kW only resistive load is considered.

## Output Specifications 400 V

UPS rating	20 kW	30 kW	40 kW	50 kW	60 kW	80 kW	100 kW	120 kW	150 kW
Voltage (V)	380/400/415								
Connections	4-wire (L1, L2, L3, N, PE)								
Output voltage regulation	Symmetrical load $\pm 1\%$ Asymmetrical load $\pm 3\%$								
Overload capacity	150% for 1 minute (in normal operation) 125% for 10 minutes (in normal operation) 125% for 1 minute (in battery operation) 110% continuous (bypass operation) 1000% for 100 milliseconds (bypass operation)								
Dynamic load response	$\pm 5\%$ after 2 milliseconds $\pm 1\%$ after 50 milliseconds								
Output power factor	1								
Nominal output current (A)	30/29/28	46/43/42	61/58/56	76/72/70	91/87/83	122/115/ 111	152/144/ 139	182/173/ 167	228/217/ 209
Minimum short circuit rating <sup>6</sup>	Dependent on upstream protection. See section for ' <b>Recommended Upstream Protection 400 V</b> ' for details.								
Maximum short circuit rating <sup>7</sup>	65 kA RMS								
Inverter output short circuit capabilities	Varies with time. See graph and table values in Inverter Short Circuit Capabilities (Bypass not Available), page 17.								
Frequency regulation (Hz)	50/60 Hz bypass synchronized – 50/60 Hz $\pm 0.1\%$ free-running								
Synchronized slew rate (Hz/sec)	Programmable to 0.25, 0.5, 1, 2, 4, 6								
Output performance classification (according to IEC 62040-3:2021)	VFI-SS-11								
Total harmonic distortion (THDU)	<1% for linear load <5% for non-linear load								
Load crest factor	2.5								
Load power factor	From 0.7 leading to 0.7 lagging without any derating								

6. Minimum short circuit rating for output takes backfeeding energy through the bypass of parallel UPSs into consideration.

7. Maximum short circuit rating for output takes backfeeding energy through the bypass of parallel UPSs into consideration.

# Battery Specifications 400 V



**HAZARD OF ELECTRIC SHOCK, EXPLOSION, OR ARC FLASH**

- Protection of the energy storage device: An overcurrent protective device must be located in close proximity to the energy storage device.
- Trip delay must be set to zero on all battery breakers.

**Failure to follow these instructions will result in death or serious injury.**

UPS rating	20 kW	30 kW	40 kW	50 kW	60 kW	80 kW	100 kW	120 kW	150 kW
Charging power in % of output power at 0-40% load <sup>8</sup>	80%								
Charging power in % of output power at 100% load	20% <sup>9</sup>								
Maximum charging power (at 0-40% load) (kW) <sup>8</sup>	16	24	32	40	48	64	80	96	120
Maximum charging power (at 100% load) (kW)	4	6	8	10	12	16	20	24	30
Nominal battery voltage (VDC)	32-48 blocks: 384-576			40-48 blocks: 480-576	35-48 blocks: 420-576	32-48 blocks: 384-576	40-48 blocks: 480-576		
Nominal float voltage (VDC)	32-48 blocks: 436-654			40-48 blocks: 545-654	35-48 blocks: 477-654	32-48 blocks: 436-654	40-48 blocks: 545-654		
Maximum boost voltage (VDC)	720 for 48 blocks								
Temperature compensation (per cell)	-3.3mV/°C, for T ≥ 25 °C – 0mV/°C, for T < 25 °C								
End of discharge voltage (full load) (VDC)	32 blocks: 307			40 blocks: 384	35 blocks: 336	32 blocks: 307	40 blocks: 384		
Battery current at full load and nominal battery voltage (A) <sup>10</sup>	54	81	109	109	130	174	218	261	326
Battery current at full load and minimum battery voltage (A) <sup>10</sup>	68	102	136	136	163	217	271	326	407
Ripple current	< 5% C20 (5 minute runtime)								
Battery test	Manual/automatic (selectable)								
Maximum short circuit rating	10 kA								

**NOTE:** For a 60 kW UPS with N+1 power module, the supported battery block quantity is 32-48 blocks.

8. Values based on 48 blocks.  
 9. At 380 V only 15% for 50 kW, 100 kW, and 150 kW.  
 10. Values based on 20-40 kW: 32 blocks; 50-150 kW: 40 blocks.

## Surge Protection Device (SPD)

**⚡ ⚠ DANGER**

**HAZARD OF ELECTRIC SHOCK, EXPLOSION, OR ARC FLASH**

This UPS is OVCII (Over Voltage Category Class II) compliant. This UPS must only be installed in an OVCII compliant environment.

- If the UPS is installed in an environment with an OVC rating higher than II, an SPD (surge protection device) must be installed upstream of the UPS to reduce the overvoltage category to OVCII.
- The SPD must include a status indicator to show the user if the SPD is operational or is no longer functioning according to design. The status indicator may be visual and/or audible and/or may have remote signalling and/or output contact capability in accordance with IEC 62040-1.

**Failure to follow these instructions will result in death or serious injury.**

## Surge Protection Device Requirements

Select a surge protection device that complies with the following requirements:

Class	Type 2
Rated voltage (Ur)	230/400 V, 277/480 V
Voltage protection level (Up)	< 2.5 kV
Short circuit rating (Iscsr) <sup>11</sup>	According to installation prospective short circuit level
Earthing system <sup>12</sup>	TN-S, TT, IT, TN-C
Poles	3P/4P depending on earthing configuration
Standards	IEC 61643-11 / UL 1449
Monitoring	Yes

11. Lower short circuit rating can be achieved with fuse protection.  
 12. Corner grounding not permitted.

# Recommended Cable Sizes 400 V

**⚠️⚠️ DANGER**

**HAZARD OF ELECTRIC SHOCK, EXPLOSION, OR ARC FLASH**

All wiring must comply with all applicable national and/or electrical codes. The maximum allowable cable size is 150 mm<sup>2</sup>.

**Failure to follow these instructions will result in death or serious injury.**

The maximum number of cable connections per busbar: Two on input/output/bypass busbars; Four on DC+/DC- busbars; Six on N/PE busbars.

**NOTE:** Overcurrent protection is to be provided by others.

Cable sizes in this manual are based on table B.52.3 and table B.52.5 of IEC 60364-5-52 with the following assertions:

- 90 °C conductors
- An ambient temperature of 30 °C
- Use of copper or aluminum conductors
- Installation method C

PE cable size is based on table 54.2 of IEC 60364-4-54.

If the ambient temperature is greater than 30 °C, larger conductors are to be selected in accordance with the correction factors of the IEC.

**NOTE:** For the scalable UPS (GVSUPS50K150HS), always size the cables for a UPS rating of 150 kW.

**NOTE:** Recommended cable sizes and maximum allowable cable size may vary for the auxiliary products. Not all auxiliary products support aluminum cables. Refer to the installation manual provided with the auxiliary product.

**NOTE:** The DC cable sizes given here are recommendations – Always follow the specific instructions in the battery solution documentation for DC cable sizes and DC PE cable sizes and ensure that the DC cable sizes match the battery breaker rating.

**NOTE:** Neutral conductor is sized to handle 1.73 times phase current in case of high harmonic content from non-linear loads. If non or less harmonic currents are expected, neutral conductor can be sized accordingly but not less than the phase conductor.

**NOTE:** 20-40 kW: DC cables are sized according to 32 battery blocks. 50-100 kW: DC cables are sized according to 40 battery blocks.

## Copper

UPS rating	20 kW	30 kW	40 kW	50 kW	60 kW	80 kW	100 kW	120 kW	150 kW
Input phases (mm <sup>2</sup> )	6	10	16	25	35	50	70	95	120
Input PE (mm <sup>2</sup> )	6	10	16	16	16	25	35	50	70
Bypass/output phases (mm <sup>2</sup> )	6	6	10	16	25	35	50	70	95
Bypass PE/output PE (mm <sup>2</sup> )	6	6	10	16	16	16	25	35	50
Neutral (mm <sup>2</sup> )	10	16	25	35	50	70	95	95	95
DC+/DC- (mm <sup>2</sup> )	10	25	35	35	50	70	95	95	2 x 70
DC PE (mm <sup>2</sup> )	10	16	16	16	25	35	50	50	70

**Aluminum**

<b>UPS rating</b>	<b>20 kW</b>	<b>30 kW</b>	<b>40 kW</b>	<b>50 kW</b>	<b>60 kW</b>	<b>80 kW</b>	<b>100 kW</b>	<b>120 kW</b>	<b>150 kW</b>
Input phases (mm <sup>2</sup> )	6	16	25	35	50	70	95	120	150
Input PE (mm <sup>2</sup> )	6	16	16	16	25	35	50	70	95
Bypass/output phases (mm <sup>2</sup> )	6	10	16	25	35	50	70	95	150
Bypass PE/output PE (mm <sup>2</sup> )	6	10	16	16	16	25	35	50	95
Neutral (mm <sup>2</sup> )	10	25	35	50	70	95	2 x 70	2 x 70	2 x 70
DC+/DC- (mm <sup>2</sup> )	16	35	50	50	70	95	2 x 70	2 x 70	2 x 95
DC PE (mm <sup>2</sup> )	16	16	25	25	35	50	70	70	95

## Recommended Upstream Protection 400 V

### **⚠️⚠️ DANGER**

#### **HAZARD OF ELECTRIC SHOCK, EXPLOSION, OR ARC FLASH**

- For parallel systems, instantaneous override (li) values must not be set higher than 1250 A. Place the label 885-92556 adjacent to the upstream circuit breaker to inform about the hazard.
- For UPS rating 20-120 kW: In parallel systems with three or more UPSs, a circuit breaker must be installed on the output of each UPS. The unit output breaker (UOB) instantaneous override (li) values must not be set higher than 1250 A.
- For UPS rating 150 kW: In parallel systems with two or more UPSs, a circuit breaker must be installed on the output of each UPS. The unit output breaker (UOB) instantaneous override (li) values must not be set higher than 1250 A.

**Failure to follow these instructions will result in death or serious injury.**

**NOTE:** Only 3-pole circuit breakers are listed in the table below. For countries where local directives require 4-pole breakers in all positions, the listed references for breakers must be revised for ordering of breakers.

**NOTE:** For 4-pole breakers in bypass and if neutral conductor is expected to carry a high current, due to line-neutral non-linear load, the circuit breaker must be rated according to expected neutral current.

**NOTE:** For the scalable UPS (GVSUPS50K150HS), always size the upstream protection for a UPS rating of 150 kW.

### **NOTICE**

#### **RISK OF UNINTENTIONAL DEVICE OPERATION**

If a residual current-operated protective device (RCD-B) is used upstream as ground fault protection, then the RCD-B shall be sized to not trip on the leakage current of this product, which can be up to 91 mA.

**Failure to follow these instructions can result in equipment damage.**

## Upstream Protection for IEC and Minimum Prospective Phase-To-Earth Short Circuit at the UPS Input/Bypass Terminals

### **⚠️ DANGER**

#### **HAZARD OF ELECTRIC SHOCK, EXPLOSION, OR ARC FLASH**

The upstream overcurrent protective device (and its settings) must be sized to ensure a disconnecting time within 0.2 seconds for a minimum prospective phase-to-earth short circuit current calculated or measured at the input/bypass terminals of the UPS.

**Failure to follow these instructions will result in death or serious injury.**

Compliance is assured with the recommended breaker (and its settings) from the table below.

## Recommended Upstream Protection for 400 V IEC

$I_{k_{Ph-PE}}$  is the minimum prospective phase-to-earth short circuit current required at the input/bypass terminals of the UPS. The  $I_{k_{Ph-PE}}$  in the table is based on the recommended protective device.

UPS rating	20 kW		30 kW		40 kW	
	Input	Bypass	Input	Bypass	Input	Bypass
$I_{k_{Ph-PE}}$ (kA)	0.6	0.5	0.6	0.5	0.7	0.6
Breaker type	NSX100H TM40D (C10H3TM040)	NSX100H TM32D (C10H3TM032)	NSX100H TM63D (C10H3TM063)	NSX100H TM50D (C10H3TM050)	NSX100H TM80D (C10H3TM080)	NSX100H TM63D (C10H3TM063)
$I_n$	40	32	63	50	80	63
$I_r$	40	32	63	50	80	63
$I_m$	500 (fixed)	400 (fixed)	500 (fixed)	500 (fixed)	640 (fixed)	500 (fixed)

UPS rating	50 kW		60 kW		80 kW		100 kW	
	Input	Bypass	Input	Bypass	Input	Bypass	Input	Bypass
$I_{k_{Ph-PE}}$ (kA)	0.8	0.7	1.5	0.8	1.6	1.5	2	1.6
Breaker type	NSX100H TM100D (C10H3TM100)	NSX100H TM80D (C10H3TM080)	NSX160H TM125D (C16H3TM125)	NSX100H TM100D (C10H3TM100)	NSX160H TM160D (C16H3TM160)	NSX160H TM125D (C16H3TM125)	NSX250H TM200D (C25H3TM200)	NSX160H TM160D (C16H3TM160)
$I_n$	100	80	125	100	160	125	200	160
$I_r$	100	80	125	100	160	125	200	160
$I_m$	800 (fixed)	640 (fixed)	1250 (fixed)	800 (fixed)	1250 (fixed)	1250 (fixed)	$\leq 6 \times I_n$	1250 (fixed)

UPS rating	120 kW		150 kW	
	Input	Bypass	Input	Bypass
$I_{k_{Ph-PE}}$ (kA)	2.5	2	3	2.5
Breaker type	NSX250H TM250D (C25H3TM250)	NSX250H TM200 (C25H3TM200)	NSX400H Mic.L 2.3 (C40H32D400)	NSX250H TM250 (C25H3TM250)
$I_n/I_o$	250	200	280	250
$I_r$	250	200	280	250
$t_r$	–	–	–	–
$I_m/I_{sd}$	$\leq 5 \times I_n$	$\leq 6 \times I_n$	10	$\leq 5 \times I_n$
$t_{sd}$	–	–	–	–
$I_i$	–	–	–	–

UPS rating	20-60 kW		80 kW	100-150 kW
	Battery			
Breaker type	ComPacT NSX250S (C25S3TM250D)		ComPacT NSX630S DC (C63S3TM600D)	
$I_r$	175	225	420	
$I_m$	1250	1250	1500	



# Specifications for 440 V Marine Systems

**NOTE:** 440 V is only applicable for the marine UPS models.

## Input Specifications 440 V Marine Systems

UPS rating	20 kW	30 kW	40 kW	50 kW	60 kW	80 kW	100 kW	120 kW	150 kW
Connections	Input connections in single mains system: 3-wire (L1, L2, L3, PE) WYE or 4-wire (L1, L2, L3, N, PE) WYE Input connections in dual mains system: 3-wire (L1, L2, L3, PE) WYE								
Input voltage range (V)	374-506								
Frequency range (Hz)	40-70								
Nominal input current (A)	28	41	55	69	82	109	137	165	204
Maximum input current (A)	34	51	66	82	99	131	166	199	248
Input current limitation (A)	35	53	68	84	103	136	168	205	252
Input power factor	0.99 for load greater than 50% 0.95 for load greater than 25%								
Total harmonic distortion (THDI)	<5% at 100% load			<3% at 100% load	<5% at 100% load		<3% at 100% load	<5% at 100% load	<3% at 100% load
Minimum short circuit rating	Dependent on upstream protection. See section for ' <b>Recommended Upstream Protection 440 V Marine Systems</b> ' for details.								
Maximum short circuit rating	65 kA RMS								
Protection	Built-in backfeed protection and fuses								
Ramp-in	Programmable and adaptive 1-40 seconds								

**NOTE:** For a UPS with N+1 power module, the input power factor is 0.99 at 100% load and the total harmonic distortion (THDI) is <6% at full linear load (symmetrical).

## Bypass Specifications 440 V Marine Systems

UPS rating	20 kW	30 kW	40 kW	50 kW	60 kW	80 kW	100 kW	120 kW	150 kW
Connections	3-wire (L1, L2, L3, PE) WYE or 4-wire (L1, L2, L3, N, PE) WYE								
Bypass voltage range (V)	396-484								
Frequency range (Hz)	50/60 ± 1, 50/60 ± 3, 50/60 ± 10 (user selectable)								
Nominal bypass current (A)	27	40	54	68	81	108	134	162	202
Nominal neutral current (A) <sup>13</sup>	45	67	92	116	138	183	228	228	228
Minimum short circuit rating	Dependent on upstream protection. See section for ' <b>Recommended Upstream Protection 440 V Marine Systems</b> ' for details.								
Maximum short circuit rating	65 kA RMS								
Protection	Built-in backfeed protection and fuses Internal fuse specifications: Rated 400 A, prearcing 33 kA <sup>2</sup> s							Built-in backfeed protection and fuses Internal fuse specifications: Rated 550 A, prearcing 52 kA <sup>2</sup> s	

13. Harmonic currents in neutral are only considered to be 1.73 x nominal up till 100 kW. Above 100 kW only resistive load is considered.

## Output Specifications 440 V Marine Systems

UPS rating	20 kW	30 kW	40 kW	50 kW	60 kW	80 kW	100 kW	120 kW	150 kW
Connections	3-wire (L1, L2, L3, PE) or 4-wire (L1, L2, L3, N, PE)								
Output voltage regulation	Symmetrical load $\pm 1\%$ Asymmetrical load $\pm 3\%$								
Overload capacity	150% for 1 minute (in normal operation) 125% for 10 minutes (in normal operation) 125% for 1 minute (in battery operation) 125% continuous (bypass operation) 1000% for 100 milliseconds (bypass operation)								
Dynamic load response	$\pm 5\%$ after 2 milliseconds $\pm 1\%$ after 50 milliseconds								
Output power factor	1								
Nominal output current (A)	26	39	52	66	79	105	131	157	197
Minimum short circuit rating <sup>14</sup>	Dependent on upstream protection. See section for ' <b>Recommended Upstream Protection 440 V Marine Systems</b> ' for details.								
Maximum short circuit rating <sup>15</sup>	65 kA RMS								
Inverter output short circuit capabilities	Varies with time. See graph and table values in Inverter Short Circuit Capabilities (Bypass not Available), page 17.								
Frequency regulation (Hz)	50/60 Hz bypass synchronized – 50/60 Hz $\pm 0.1\%$ free-running								
Synchronized slew rate (Hz/sec)	Programmable to 0.25, 0.5, 1, 2, 4, 6								
Total harmonic distortion (THDU)	<1% for linear load <5% for non-linear load								
Load crest factor	2.5								
Load power factor	From 0.7 leading to 0.7 lagging without any derating								

14. Minimum short circuit rating for output takes backfeeding energy through the bypass of parallel UPSs into consideration.  
15. Maximum short circuit rating for output takes backfeeding energy through the bypass of parallel UPSs into consideration.

# Battery Specifications 440 V Marine Systems



**HAZARD OF ELECTRIC SHOCK, EXPLOSION, OR ARC FLASH**

- Protection of the energy storage device: An overcurrent protective device must be located in close proximity to the energy storage device.
- Trip delay must be set to zero on all battery breakers.

**Failure to follow these instructions will result in death or serious injury.**

UPS rating	20 kW	30 kW	40 kW	50 kW	60 kW	80 kW	100 kW	120 kW	150 kW
Charging power in % of output power at 0-40% load <sup>16</sup>	80%								
Charging power in % of output power at 100% load	20%								
Maximum charging power (at 0-40% load) (kW) <sup>16</sup>	16	24	32	40	48	64	80	96	120
Maximum charging power (at 100% load) (kW)	4	6	8	10	12	16	20	24	30
Nominal battery voltage (VDC)	32-48 blocks: 384-576			40-48 blocks: 480-576	35-48 blocks: 420-576	32-48 blocks: 384-576	40-48 blocks: 480-576		
Nominal float voltage (VDC)	32-48 blocks: 436-654			40-48 blocks: 545-654	35-48 blocks: 477-654	32-48 blocks: 436-654	40-48 blocks: 545-654		
Maximum boost voltage (VDC)	720 for 48 blocks								
Temperature compensation (per cell)	-3.3mV/°C, for T ≥ 25 °C – 0mV/°C, for T < 25 °C								
End of discharge voltage (full load) (VDC)	32 blocks: 307			40 blocks: 384	35 blocks: 336	32 blocks: 307	40 blocks: 384		
Battery current at full load and nominal battery voltage (A) <sup>17</sup>	54	81	108	108	130	173	218	261	326
Battery current at full load and minimum battery voltage (A) <sup>17</sup>	68	101	135	135	162	216	270	325	406
Ripple current	< 5% C20 (5 minute runtime)								
Battery test	Manual/automatic (selectable)								
Maximum short circuit rating	10 kA								

16. Values based on 48 blocks.

17. Values based on 20-40 kW: 32 blocks; 50-150 kW: 40 blocks.

## Surge Protection Device (SPD)

**⚡⚡ DANGER**

**HAZARD OF ELECTRIC SHOCK, EXPLOSION, OR ARC FLASH**

This UPS is OVCII (Over Voltage Category Class II) compliant. This UPS must only be installed in an OVCII compliant environment.

- If the UPS is installed in an environment with an OVC rating higher than II, an SPD (surge protection device) must be installed upstream of the UPS to reduce the overvoltage category to OVCII.
- The SPD must include a status indicator to show the user if the SPD is operational or is no longer functioning according to design. The status indicator may be visual and/or audible and/or may have remote signalling and/or output contact capability in accordance with IEC 62040-1.

**Failure to follow these instructions will result in death or serious injury.**

## Surge Protection Device Requirements

Select a surge protection device that complies with the following requirements:

Class	Type 2
Rated voltage (Ur)	230/400 V, 277/480 V
Voltage protection level (Up)	< 2.5 kV
Short circuit rating (Iscrr) <sup>18</sup>	According to installation prospective short circuit level
Earthing system <sup>19</sup>	TN-S, TT, IT, TN-C
Poles	3P/4P depending on earthing configuration
Standards	IEC 61643-11 / UL 1449
Monitoring	Yes

18. Lower short circuit rating can be achieved with fuse protection.

19. Corner grounding not permitted.

# Recommended Cable Sizes 440 V Marine Systems

**⚡⚠ DANGER**

**HAZARD OF ELECTRIC SHOCK, EXPLOSION, OR ARC FLASH**

All wiring must comply with all applicable national and/or electrical codes. The maximum allowable cable size is 150 mm<sup>2</sup>.

**Failure to follow these instructions will result in death or serious injury.**

The maximum number of cable connections per busbar: Two on input/output/bypass busbars; Four on DC+/DC- busbars; Six on N/PE busbars.

**NOTE:** Overcurrent protection is to be provided by others.

Cable sizes in this manual are based on table B.52.3 and table B.52.5 of IEC 60364-5-52 with the following assertions:

- 90 °C conductors
- An ambient temperature of 30 °C
- Use of copper or aluminum conductors
- Installation method C

PE cable size is based on table 54.2 of IEC 60364-4-54.

If the ambient temperature is greater than 30 °C, larger conductors are to be selected in accordance with the correction factors of the IEC.

**NOTE:** Recommended cable sizes and maximum allowable cable size may vary for the auxiliary products. Not all auxiliary products support aluminum cables. Refer to the installation manual provided with the auxiliary product.

**NOTE:** The DC cable sizes given here are recommendations – Always follow the specific instructions in the battery solution documentation for DC cable sizes and DC PE cable sizes and ensure that the DC cable sizes match the battery breaker rating.

**NOTE:** Neutral conductor is sized to handle 1.73 times phase current in case of high harmonic content from non-linear loads. If non or less harmonic currents are expected, neutral conductor can be sized accordingly but not less than the phase conductor.

**NOTE:** 20-40 kW: DC cables are sized according to 32 battery blocks. 50-100 kW: DC cables are sized according to 40 battery blocks.

### Copper

UPS rating	20 kW	30 kW	40 kW	50 kW	60 kW	80 kW	100 kW	120 kW	150 kW
Input phases (mm <sup>2</sup> )	6	10	16	25	35	50	70	95	120
Input PE (mm <sup>2</sup> )	6	10	16	16	16	25	35	50	70
Bypass/output phases (mm <sup>2</sup> )	6	6	10	16	25	35	50	70	95
Bypass PE/output PE (mm <sup>2</sup> )	6	6	10	16	16	16	25	35	50
Neutral (mm <sup>2</sup> )	10	16	25	35	50	70	95	95	95
DC+/DC- (mm <sup>2</sup> )	10	25	35	35	50	70	95	95	2 x 70
DC PE (mm <sup>2</sup> )	10	16	16	16	25	35	50	50	70

### Aluminum

UPS rating	20 kW	30 kW	40 kW	50 kW	60 kW	80 kW	100 kW	120 kW	150 kW
Input phases (mm <sup>2</sup> )	6	16	25	35	50	70	95	120	150
Input PE (mm <sup>2</sup> )	6	16	16	16	25	35	50	70	95

**Aluminum (Continued)**

UPS rating	20 kW	30 kW	40 kW	50 kW	60 kW	80 kW	100 kW	120 kW	150 kW
Bypass/output phases (mm <sup>2</sup> )	6	10	16	25	35	50	70	95	150
Bypass PE/output PE (mm <sup>2</sup> )	6	10	16	16	16	25	35	50	95
Neutral (mm <sup>2</sup> )	10	25	35	50	70	95	2 x 70	2 x 70	2 x 70
DC+/DC- (mm <sup>2</sup> )	16	35	50	50	70	95	2 x 70	2 x 70	2 x 95
DC PE (mm <sup>2</sup> )	16	16	25	25	35	50	70	70	95

## Recommended Upstream Protection 440 V Marine Systems

### DANGER

#### HAZARD OF ELECTRIC SHOCK, EXPLOSION, OR ARC FLASH

- For parallel systems, instantaneous override (li) values must not be set higher than 1250 A. Place the label 885-92556 adjacent to the upstream circuit breaker to inform about the hazard.
- For UPS rating 20-120 kW: In parallel systems with three or more UPSs, a circuit breaker must be installed on the output of each UPS. The unit output breaker (UOB) instantaneous override (li) values must not be set higher than 1250 A.
- For UPS rating 150 kW: In parallel systems with two or more UPSs, a circuit breaker must be installed on the output of each UPS. The unit output breaker (UOB) instantaneous override (li) values must not be set higher than 1250 A.

**Failure to follow these instructions will result in death or serious injury.**

**NOTE:** For local directives which require 4-pole circuit breakers: If neutral conductor is expected to carry a high current, due to line-neutral non-linear load, the circuit breaker must be rated according to expected neutral current.

### NOTICE

#### RISK OF UNINTENTIONAL DEVICE OPERATION

If a residual current-operated protective device (RCD-B) is used upstream as ground fault protection, then the RCD-B shall be sized to not trip on the leakage current of this product, which can be up to 91 mA.

**Failure to follow these instructions can result in equipment damage.**

## Upstream Protection for IEC and Minimum Prospective Phase-To-Earth Short Circuit at the UPS Input/Bypass Terminals

### DANGER

#### HAZARD OF ELECTRIC SHOCK, EXPLOSION, OR ARC FLASH

The upstream overcurrent protective device (and its settings) must be sized to ensure a disconnecting time within 0.2 seconds for a minimum prospective phase-to-earth short circuit current calculated or measured at the input/bypass terminals of the UPS.

**Failure to follow these instructions will result in death or serious injury.**

Compliance is assured with the recommended breaker (and its settings) from the table below.

## Recommended Upstream Protection 440 V IEC Marine Systems

$I_{k_{PH-PE}}$  is the minimum prospective phase-to-earth short circuit current required at the input/bypass terminals of the UPS. The  $I_{k_{PH-PE}}$  in the table is based on the recommended protective device.



UPS rating	20 kW		30 kW		40 kW	
	Input	Bypass	Input	Bypass	Input	Bypass
<b>I<sub>kPh-PE</sub> (kA)</b>	<b>0.6</b>	<b>0.5</b>	<b>0.6</b>	<b>0.5</b>	<b>0.7</b>	<b>0.6</b>
Breaker type	NSX100H TM40D (C10H3TM040)	NSX100H TM32D (C10H3TM032)	NSX100H TM63D (C10H3TM063)	NSX100H TM50D (C10H3TM050)	NSX100H TM80D (C10H3TM080)	NSX100H TM63D (C10H3TM063)
I <sub>n</sub>	40	32	63	50	80	63
I <sub>r</sub>	40	32	63	50	80	63
I <sub>m</sub>	500 (fixed)	400 (fixed)	500 (fixed)	500 (fixed)	640 (fixed)	500 (fixed)

UPS rating	50 kW		60 kW		80 kW		100 kW	
	Input	Bypass	Input	Bypass	Input	Bypass	Input	Bypass
<b>I<sub>kPh-PE</sub> (kA)</b>	<b>0.8</b>	<b>0.7</b>	<b>1.5</b>	<b>0.8</b>	<b>1.6</b>	<b>1.5</b>	<b>2</b>	<b>1.6</b>
Breaker type	NSX100H TM100D (C10H3TM100)	NSX100H TM80D (C10H3TM080)	NSX160H TM125D (C16H3TM125)	NSX100H TM100D (C10H3TM100)	NSX160H TM160D (C16H3TM160)	NSX160H TM125D (C16H3TM125)	NSX250H TM200D (C25H3TM200)	NSX160H TM160D (C16H3TM160)
I <sub>n</sub>	100	80	125	100	160	125	200	160
I <sub>r</sub>	100	80	125	100	160	125	200	160
I <sub>m</sub>	800 (fixed)	640 (fixed)	1250 (fixed)	800 (fixed)	1250 (fixed)	1250 (fixed)	≤6 x I <sub>n</sub>	1250 (fixed)

UPS rating	120 kW		150 kW	
	Input	Bypass	Input	Bypass
<b>I<sub>kPh-PE</sub> (kA)</b>	<b>2.5</b>	<b>2</b>	<b>3</b>	<b>2.5</b>
Breaker type	NSX250H TM250D (C25H3TM250)	NSX250H TM200 (C25H3TM200)	NSX400H Mic.L 2.3 (C40H32D400)	NSX250H TM250 (C25H3TM250)
I <sub>n</sub> /I <sub>o</sub>	250	200	280	250
I <sub>r</sub>	250	200	280	250
t <sub>r</sub>	–	–	–	–
I <sub>m</sub> /I <sub>sd</sub>	≤5 x I <sub>n</sub>	≤6 x I <sub>n</sub>	10	≤5 x I <sub>n</sub>
t <sub>sd</sub>	–	–	–	–
I <sub>i</sub>	–	–	–	–

UPS rating	20-60 kW		80 kW	100-150 kW
	Battery			
Breaker type	ComPacT NSX250S (C25S3TM250D)		ComPacT NSX630S DC (C63S3TM600D)	
I <sub>r</sub>	175		225	420
I <sub>m</sub>	1250		1250	1500

## Recommended Bolt and Lug Sizes for IEC

Cable size mm <sup>2</sup>	Bolt size	Cable lug type
6	M8 x 25 mm	TLK6-8
10	M8 x 25 mm	TLK10-8
16	M8 x 25 mm	TLK16-8
25	M8 x 25 mm	TLK25-8
35	M8 x 25 mm	TLK35-8
50	M8 x 25 mm	TLK50-8
70	M8 x 25 mm	TLK70-8
95	M8 x 25 mm	TLK95-8
120	M8 x 25 mm	TLK120-8
150	M8 x 25 mm	TLK150-8

# Torque Specifications

Bolt size	Torque
M4	1.7 Nm
M5	2.2 Nm
M6	5 Nm
M8	17.5 Nm
M10	30 Nm
M12	50 Nm

## Physical

### UPS Shipping Weights and Dimensions

	Weight kg	Height mm	Width mm	Depth mm
20-50 kW UPS 400 V	235	1680	640	990
20-50 kW UPS with N+1 power module 400 V	250	1680	640	990
60 kW UPS 400 V	263	1680	640	990
60-100 kW UPS with N +1 power module 400 V*	250	1680	640	990
80-100 kW UPS 400 V	275	1680	640	990
120 kW UPS 400 V*	250	1680	640	990
150 kW UPS 400 V*	250	1680	640	990

**NOTE:** The UPS models marked with an \* in the table above are shipped with one power module preinstalled in the UPS and two power modules shipped separately.

### Power Module Shipping Weights and Dimensions

Commercial reference	Weight kg	Height mm	Width mm	Depth mm
GVPM20KD	48	330	580	780
GVPM50KD	62	330	580	780

### UPS Weights and Dimensions

	Weight kg	Height mm	Width mm	Depth mm
20-50 kW UPS 400 V	206	1485	521	847
20-50 kW UPS with N+1 power module 400 V	250	1485	521	847
60 kW UPS 400 V	238	1485	521	847
60-100 kW UPS with N +1 power module 400 V	290	1485	521	847
80-100 kW UPS 400 V	250	1485	521	847
120 kW UPS 400 V	278	1485	521	847
150 kW UPS 400 V	290	1485	521	847

## Clearance

**NOTE:** Clearance dimensions are published for airflow and service access only. Consult with the local safety codes and standards for additional requirements in your local area.

**NOTE:** The required minimum rear clearance is 150 mm (5.91 in).

### Front View of the UPS

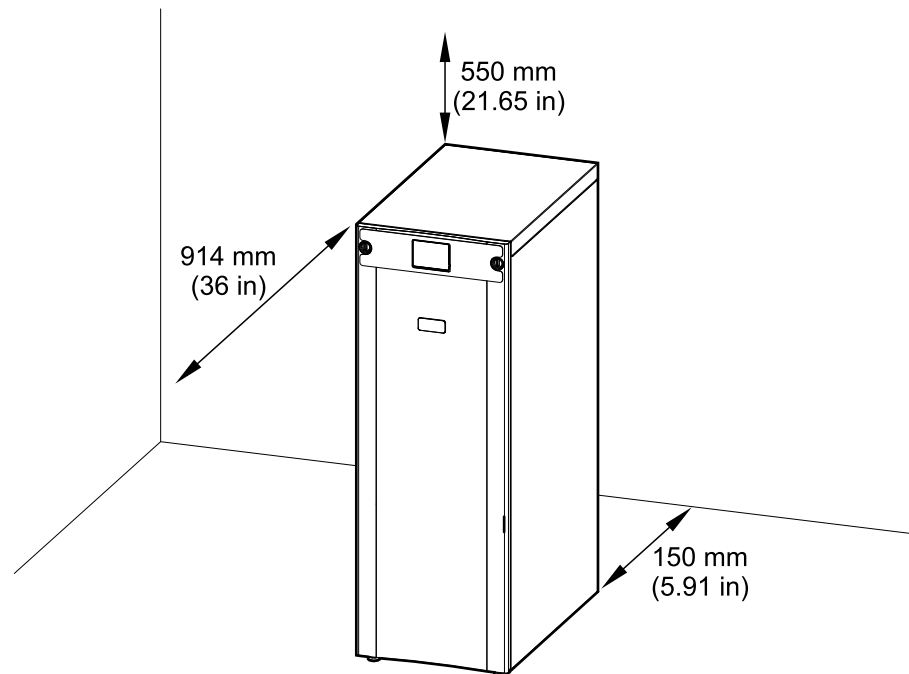

# Environment

	Operating	Storage
Temperature	0 °C to 50 °C with load derating above 40 °C. <sup>20</sup>	-15 °C to 40 °C for systems with batteries. -25 °C to 55 °C for systems without batteries.
Relative humidity	5-95% non-condensing	10-80% non-condensing
Elevation	Designed for operation in 0-3000 m elevation. Derating required from 1000-3000 m: Up to 1000 m: 1.000 Up to 1500 m : 0.975 Up to 2000 m: 0.950 Up to 2500 m: 0.925 Up to 3000 m: 0.900	
Audible noise one meter from unit	400 V: 60 dB at 70% load, 68 dB at 100% load	
Protection class	IP21	
Color	RAL 9003, gloss level 85%	

## Heat Dissipation for 400 V in BTU/hr

20 kW	Normal operation			ECO mode		
Voltage (V)	380	400	415	380	400	415
25% load	1138	1030	1063	551	565	573
50% load	1498	1406	1446	641	629	641
75% load	1925	1757	1813	730	697	706
100% load	2321	2170	2208	791	779	776

20 kW	eConversion			Battery operation		
Voltage (V)	380	400	415	380	400	415
25% load	777	900	835	1092	1092	1092
50% load	819	872	851	1467	1467	1467
75% load	847	897	887	1894	1894	1894
100% load	899	926	928	2320	2320	2320

30 kW	Normal operation			ECO mode		
Voltage (V)	380	400	415	380	400	415
25% load	1315	1211	1257	608	591	600
50% load	1925	1757	1813	730	697	706
75% load	2529	2385	2419	826	809	809
100% load	3357	3122	3192	952	925	939

30 kW	eConversion			Battery operation		
Voltage (V)	380	400	415	380	400	415
25% load	791	868	835	1280	1280	1280
50% load	847	897	887	1894	1894	1894
75% load	926	939	945	2610	2610	2610
100% load	1006	1038	1026	3378	3378	3378

20. For temperatures between 40 °C and 50 °C, derate the load power rating with 2.5% per °C.

40 kW	Normal operation			ECO mode		
Voltage (V)	380	400	415	380	400	415
25% load	1498	1406	1446	641	629	641
50% load	2321	2170	2208	791	779	776
75% load	3357	3122	3192	952	925	939
100% load	4577	4333	4285	1120	1094	1086

40 kW	eConversion			Battery operation		
Voltage (V)	380	400	415	380	400	415
25% load	819	872	852	1467	1467	1467
50% load	899	1268	928	2320	2320	2320
75% load	1006	1038	1026	3378	3378	3378
100% load	1123	1185	1144	4641	4641	4641

50 kW	Normal operation			ECO mode		
Voltage (V)	380	400	415	380	400	415
25% load	1726	1576	1619	689	669	668
50% load	2888	2624	2718	889	843	845
75% load	4294	3985	4026	1079	1059	1053
100% load	6268	5804	5673	1288	1247	1234

50 kW	eConversion			Battery operation		
Voltage (V)	380	400	415	380	400	415
25% load	834	846	867	1663	1663	1663
50% load	952	965	970	2815	2815	2815
75% load	1088	1109	1113	4223	4223	4223
100% load	1261	1253	1256	5971	5971	5971

60 kW	Normal operation			ECO mode		
Voltage (V)	380	400	415	380	400	415
25% load	2131	2131	2131	885	885	885
50% load	3382	3273	3273	1138	1138	1138
75% load	4909	4746	4746	1394	1394	1394
100% load	6982	6546	6328	1650	1650	1650

60 kW	eConversion			Battery operation		
Voltage (V)	380	400	415	380	400	415
25% load	991	1044	1097	2579	2579	2579
50% load	1243	1243	1347	3820	3820	3820
75% load	1394	1550	1394	5237	5237	5237
100% load	1858	1858	1650	6982	6982	6982

80 kW	Normal operation			ECO mode		
Voltage (V)	380	400	415	380	400	415
25% load	2711	2622	2626	997	992	972
50% load	4378	4177	4187	1331	1303	1279

80 kW	Normal operation			ECO mode		
Voltage (V)	380	400	415	380	400	415
75% load	6545	6150	6045	1702	1630	1605
100% load	8964	8394	8104	1928	1860	1802

80 kW	eConversion			Battery operation		
Voltage (V)	380	400	415	380	400	415
25% load	1328	1369	1382	2866	2866	2866
50% load	1497	1509	1537	4641	4641	4641
75% load	1768	1783	1763	6756	6756	6756
100% load	1962	1952	1931	9281	9281	9281

100 kW	Normal operation			ECO mode		
Voltage (V)	380	400	415	380	400	415
25% load	3129	2959	2988	1074	1064	1046
50% load	5438	5115	5090	1517	1497	1436
75% load	8179	7626	7466	1812	1761	1750
100% load	12004	11373	10752	1344	2269	2211

100 kW	eConversion			Battery operation		
Voltage (V)	380	400	415	380	400	415
25% load	1370	1402	1424	3242	3242	3242
50% load	1635	1624	1669	5630	5630	5630
75% load	1938	1921	1884	8445	8445	8445
100% load	2392	2266	2272	11942	11942	11942

120 kW	Normal operation			ECO mode		
Voltage (V)	380	400	415	380	400	415
25% load	3710	3710	3710	1347	1347	1347
50% load	6328	6328	6111	1858	1858	1858
75% load	9818	9492	9166	2475	2475	2475
100% load	14402	13964	13091	3300	2885	2885

120 kW	eConversion			Battery operation		
Voltage (V)	380	400	415	380	400	415
25% load	1663	1663	1663	NA	NA	NA
50% load	2067	2067	2067	NA	NA	NA
75% load	2475	2475	2475	NA	NA	NA
100% load	2885	2885	2885	NA	NA	NA

150 kW	Normal operation			ECO mode		
Voltage (V)	380	400	415	380	400	415
25% load	4638	4638	4638	1553	1422	1422
50% load	7910	7638	7638	2323	2063	2063
75% load	12273	11865	11457	3094	3094	2704
100% load	18552	16909	16364	4125	3606	3606



<b>150 kW</b>	<b>eConversion</b>			<b>Battery operation</b>		
<b>Voltage (V)</b>	<b>380</b>	<b>400</b>	<b>415</b>	<b>380</b>	<b>400</b>	<b>415</b>
25% load	1816	1816	1947	NA	NA	NA
50% load	2323	2323	2323	NA	NA	NA
75% load	3094	2704	2704	NA	NA	NA
100% load	4125	3606	3606	NA	NA	NA

# Drawings

**NOTE:** A comprehensive set of drawings is available on [www.se.com](http://www.se.com).

**NOTE:** These drawings are for reference ONLY – subject to change without notice.

# 20-50 kW 400 V UPS

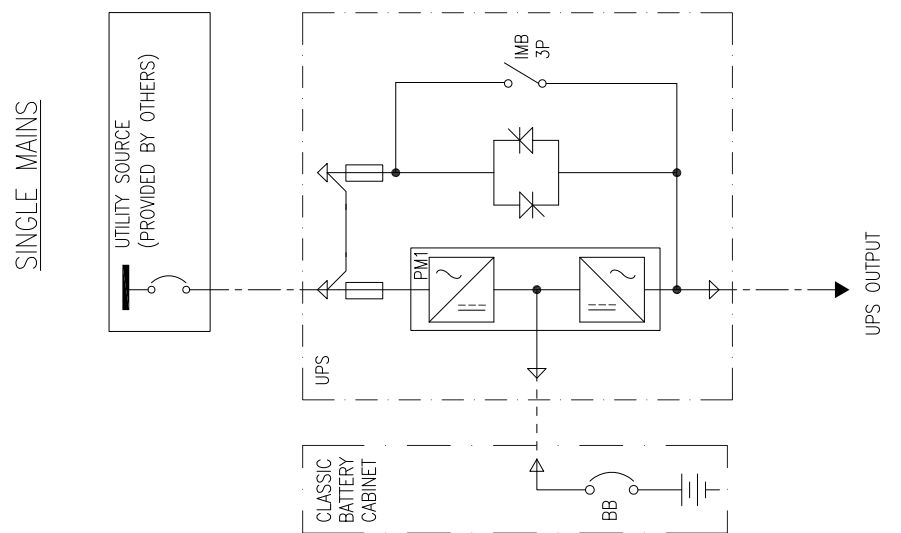
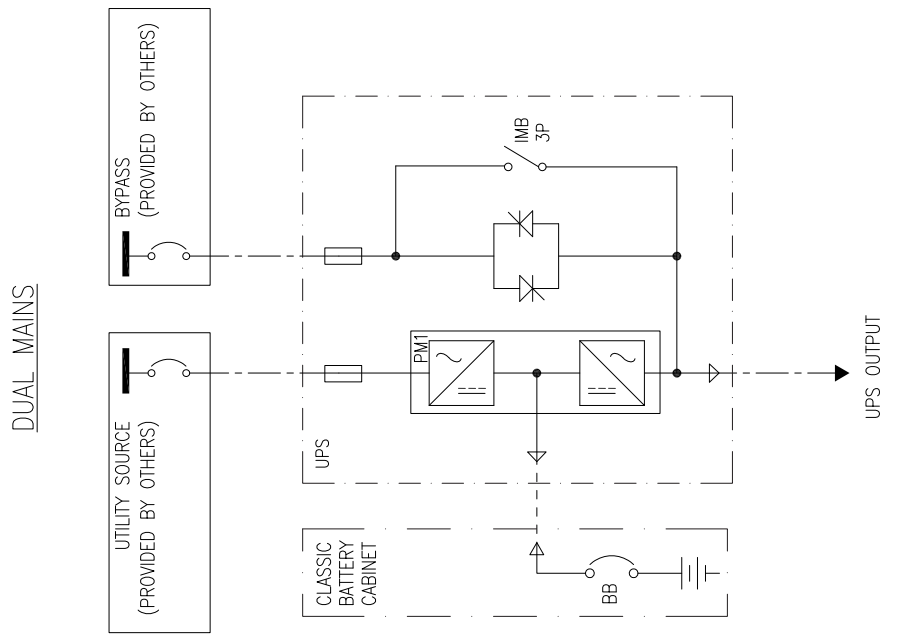

# 60-100 kW 400 V UPS

DUAL MAINS

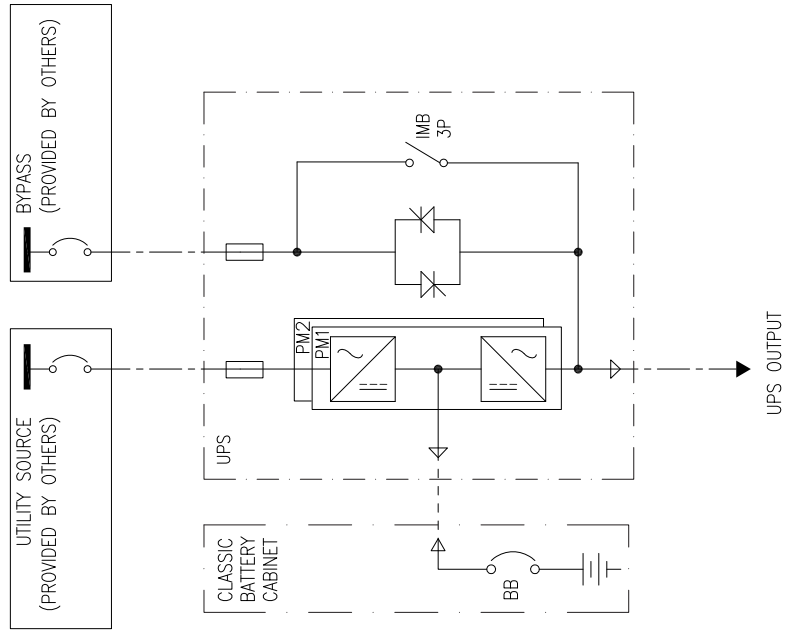

SINGLE MAINS

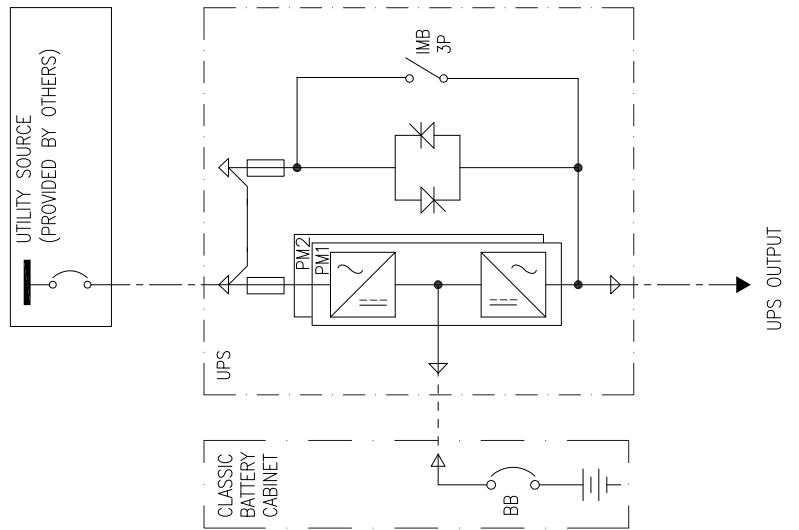

# 120-150 kW 400 V UPS

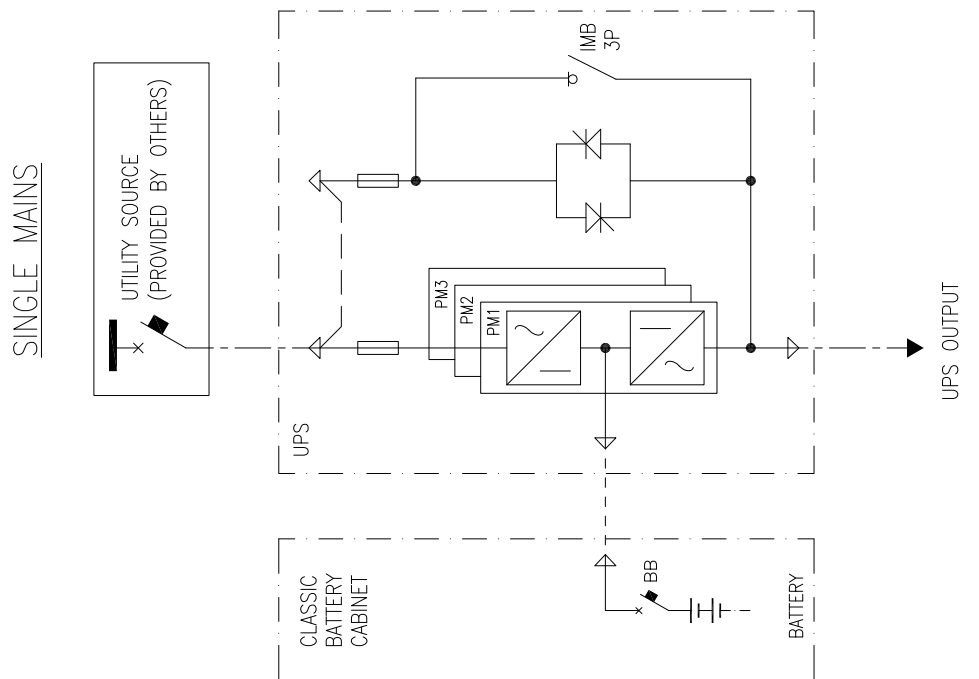
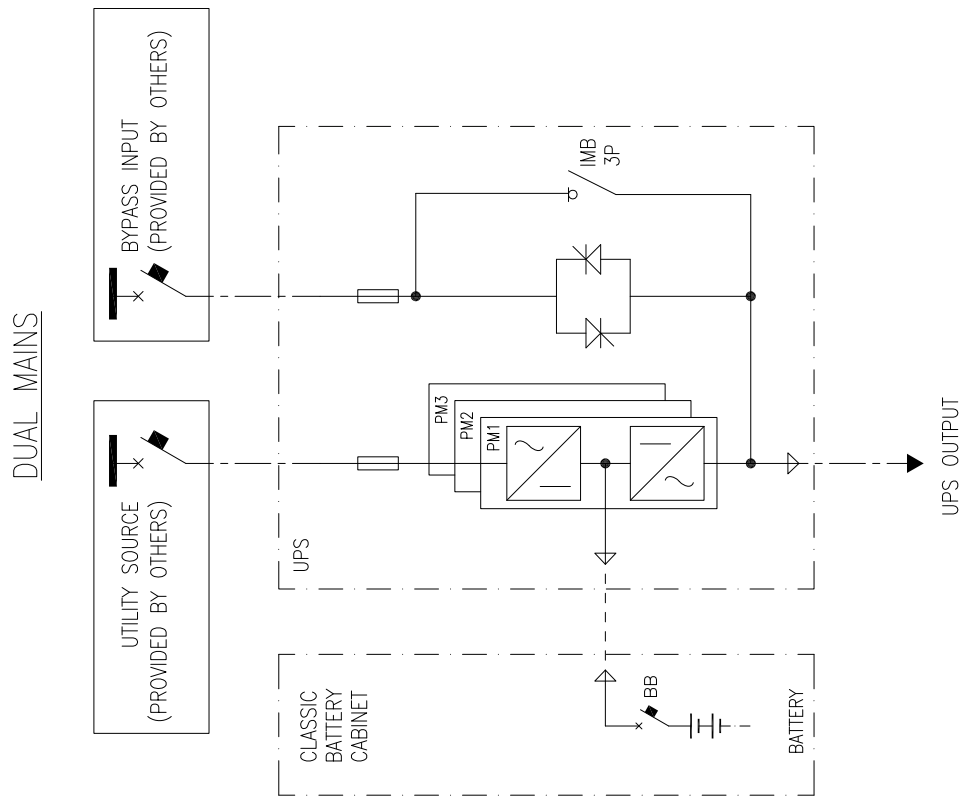

# Options

## Configuration Options

- Compact design, high density technology, and modular architecture
- Single or dual mains
- Up to 4+0 UPSs in parallel for capacity
- Up to 3+1 UPSs in parallel for redundancy
- Default rear or bottom cable entry
- ECO mode
- eConversion mode
- EcoStruxure IT compatible
- Generator compatible
- Touchscreen LCD
- Replacement of power module in any operation mode (Live Swap)<sup>21</sup>
- Halogen-free cables for marine-certified and scalable UPS models.
- Supported battery types: VRLA, Lithium-ion, and NiCd.

## Hardware Options

**NOTE:** All hardware options listed here may not be available in all regions.

### Power Module

- Power module 50 kW 400 V (GVPM50KD)
- Power module 20 kW 400 V (GVPM20KD)

### Galaxy Lithium-Ion Battery Cabinet

Battery cabinet including Lithium-Ion batteries and battery breaker.

- Galaxy Lithium-Ion battery cabinet with 13 battery modules (LIBSESMG13IEC)
- Galaxy Lithium-Ion battery cabinet with 16 battery modules (LIBSESMG16IEC)

### Modular Battery Cabinet

Modular battery cabinet including battery breaker.

- Modular battery cabinet for up to six smart modular battery strings (GVSMODBC6). Can be installed adjacent to the UPS with the use of optional installation kit GVSOPT030.
- Modular battery cabinet for up to nine smart modular battery strings (GVSMODBC9). Can only be installed remote to the UPS.

---

21. In all systems configured for Live Swap.

## Battery Modules

9 Ah smart high capacity battery modules for use with GVSMODBC6 and GVSMODBC9:

- Galaxy VS 9 Ah Smart High Capacity Battery Module (GVSBTHU)
- Galaxy VS 9 Ah Smart Modular High Capacity Battery String (GVSBTH4)

9 Ah smart long-life high capacity battery modules for use with GVSMODBC6 and GVSMODBC9:

- Galaxy VS 9 Ah Smart Long-Life High Capacity Battery Module (GVSBTHULL)
- Galaxy VS 9 Ah Smart Modular Long-Life High Capacity Battery String (GVSBTH4LL)

**NOTE:** Always use the same battery module type in the UPS system. Do not mix different battery module types.

## Classic Battery Cabinets

Classic battery cabinet including batteries and battery breaker.

- 710 mm wide, classic battery cabinet (GVSCBC7C, GVSCBC7D, GVSCBC7E)
- 1010 mm wide, classic battery cabinet (GVSCBC10A2, GVSCBC10B2)

## Empty Battery Cabinets

Empty battery cabinet for use with third party batteries. Battery breaker kit is required (sold separately).

- 700 mm wide empty classic battery cabinet (GVEBC7)
- 1100 mm wide empty classic battery cabinet (GVEBC11)

## Battery Breaker Box

Wall mounted battery breaker box for use with third party battery solutions.

- 20-80 kW battery breaker box (GVSBBC20K80H)
- 100-200 kW battery breaker box (GVSBBC100K200H)

## Battery Breaker Kit

Battery breaker kit for use with empty battery cabinets or third party battery solutions.

- 20-80 kW battery breaker kit (GVSBBC20K80H)
- 100-200 kW battery breaker kit (GVSBBC100K200H)

## Maintenance Bypass Panel

Maintenance bypass panel for complete isolation of the UPS during service operations. Only for single UPS or 1+1 parallel system for redundancy.

- 10-20 kW maintenance bypass panel (GVSBPSU10K20H)
- 20-60 kW maintenance bypass panel (GVSBPSU20K60H)

- 80-120 kW maintenance bypass panel (GVSBPSU80K120H)
- 150 kW maintenance bypass panel (GVSBPSU150KH)

## Parallel Maintenance Bypass Panel for Two UPSs

Maintenance bypass panel for complete isolation of two UPSs in a parallel system. 10-120 kW in 1+1 parallel system for redundancy, 20-240 kW in 2+0 parallel system for capacity.

- 10-30 kW maintenance bypass panel (GVSBPAR10K30H)
- 40-50 kW maintenance bypass panel (GVSBPAR40K50H)
- 60-120 kW maintenance bypass panel (GVSBPAR60K120H)

## Auxiliary Cabinets

- Empty auxiliary cabinet (GVEAC7)

## Remote Alarm Panel

- Remote alarm panel (GVSOPT036)

## Optional Installation Kits

- Seismic kit for UPS (GVSOPT002)
- Parallel kit for UPS (GVSOPT006)
- IP22 kit for UPS (GVSOPT026)
- Mounting skid kit for the UPS or GVSMODBC6 for marine or industrial installation (GVSOPT027)
- Cable kit for GVSMODBC6 installed adjacent to the UPS (GVSOPT030)
- IP52 kit for the UPS (GVSOPT033)
- IP52 kit for GVSMODBC6 (GVSOPT034)
- Live Swap kit for the UPS (GVSOPT038)

## Optional Network Management Card

- Network Management Card LCES2 with Modbus, Ethernet and AUX sensors (AP9644)

## Air Filter

- Air filter kit (GVSOPT001)

## Temperature Sensors

- Extra temperature sensor for second classic battery bank (0J-0M-1160). Not for use with modular battery cabinet solution.
- Temperature sensor for network management card (AP9335T)



- Temperature/humidity sensor for network management card (AP9335TH)

## Weights and Dimensions for Options

**NOTE:** Not all options listed here are available for all UPS models. Refer to the hardware options list for the relevant UPS model.

### Maintenance Bypass Panel Shipping Weights and Dimensions

Commercial reference	Weight kg	Height mm <sup>22</sup>	Width mm	Depth mm <sup>22</sup>
GVSBPUSU10K20H	20	260	530	590
GVSBPUSU20K60H	40	440	730	810
GVSBPUSU80K120H	55	490	840	1220
GVSBPUSU150KH	60	490	840	1220

### Maintenance Bypass Panel Weights and Dimensions

Commercial reference	Weight kg	Height mm	Width mm	Depth mm
GVSBPUSU10K20H	12	450	400	150
GVSBPUSU20K60H	25	600	550	220
GVSBPUSU80K120H	40	800	600	280
GVSBPUSU150KH	48	800	600	280

### Parallel Maintenance Bypass Panel Weights and Dimensions

Commercial reference	Weight kg	Height mm	Width mm	Depth mm
GVSBPAPAR10K30H	35	700	650	210
GVSBPAPAR40K50H	86	850	750	250
GVSBPAPAR60K120H	110	1000	900	280

### Parallel Maintenance Bypass Panel Shipping Weights and Dimensions

Commercial reference	Weight kg	Height mm <sup>22</sup>	Width mm	Depth mm <sup>22</sup>
GVSBPAPAR10K30H	56	500	800	1200
GVSBPAPAR40K50H	96	580	800	1200
GVSBPAPAR60K120H	120	500	1000	1200

### Battery Breaker Box Shipping Weights and Dimensions

Commercial reference	Weight kg	Height mm <sup>22</sup>	Width mm	Depth mm
GVSBBB20K80H	45	480	840	1220
GVSBBB100K200H	55	480	840	1220

<sup>22</sup> The product is packaged in a horizontal position, so the shipping height and depth dimensions differ from the product itself.

## Battery Breaker Box Weights and Dimensions

Commercial reference	Weight kg	Height mm	Width mm	Depth mm
GVSB20K80H	25	650	500	280
GVSB100K200H	35	800	500	280

## Classic Battery Cabinet Shipping Weights and Dimensions

Commercial reference	Weight kg	Height mm	Width mm	Depth mm
GVSCBC7C	920	1980	815	970
GVSCBC7D	589	1980	815	970
GVSCBC7E	810	1980	815	970
GVSCBC10A2	1300	1980	1130	970
GVSCBC10B2	1532	1980	1130	970

## Classic Battery Cabinet Weights and Dimensions

Commercial reference	Weight kg	Height mm	Width mm	Depth mm
GVSCBC7C	900	1900	710	845
GVSCBC7D	569	1900	710	845
GVSCBC7E	790	1900	710	845
GVSCBC10A2	1102	1900	1010	845
GVSCBC10B2	1368	1900	1010	845

## Empty Battery Cabinet Shipping Weight and Dimensions

Commercial reference	Weight kg	Height mm	Width mm	Depth mm
GVEBC7	205	2100	930	970
GVEBC11	250	2100	1330	970
GVEBC15	405	2120	1700	1000

## Empty Battery Cabinet Weight and Dimensions

Commercial reference	Weight kg	Height mm	Width mm	Depth mm
GVEBC7	190	1970	700	850
GVEBC11	230	1970	1100	850
GVEBC15	390	1970	1500	854

## Modular Battery Cabinet Shipping Weights and Dimensions

Commercial reference	Weight kg	Height mm	Width mm	Depth mm
GVSMODBC6	175	1664	635	990
GVSMODBC9	206	2082	755	1010

**NOTE:** The modular battery cabinet is shipped without battery strings installed.

## Modular Battery Cabinet Weights and Dimensions

Commercial reference	Weight kg	Height mm	Width mm	Depth mm
GVSMODBC6 – Empty – With six battery strings	145 913	1485	521	847
GVSMODBC9 – Empty – With nine battery strings	186 1338	1970	550	847

**NOTE:** One battery module weighs approximately 32 kg.

## Remote Alarm Panel Shipping Weights and Dimensions

Commercial reference	Weight kg	Height mm	Width mm	Depth mm
GVSOPT036	19	581	468	366

## Remote Alarm Panel Weights and Dimensions

Commercial reference	Weight kg	Height mm	Width mm	Depth mm
GVSOPT036	14	400	300	178

# Limited Factory Warranty

## One-Year Factory Warranty

The limited warranty provided by Schneider Electric in this Statement of Limited Factory Warranty applies only to products you purchase for your commercial or industrial use in the ordinary course of your business.

## Terms of Warranty

Schneider Electric warrants that the product shall be free from defects in materials and workmanship for a period of one year from the date of product start-up when start-up is performed by Schneider Electric-authorized service personnel and occurs within six months of the Schneider Electric shipment date. This warranty covers repairing or replacing any defective parts including on-site labor and travel. In the event that the product fails to meet the foregoing warranty criteria, the warranty covers repairing or replacing defective parts at the sole discretion of Schneider Electric for a period of one year from the shipment date. For Schneider Electric cooling solutions, this warranty does not cover circuit breaker resetting, loss of refrigerant, consumables, or preventive maintenance items. Repair or replacement of a defective product or part thereof does not extend the original warranty period. Any parts furnished under this warranty may be new or factory-remanufactured.

## Non-transferable Warranty

This warranty is extended to the first person, firm, association or corporation (herein referred to by "You" or "Your") for whom the Schneider Electric product specified herein has been purchased. This warranty is not transferable or assignable without the prior written permission of Schneider Electric.

## Assignment of Warranties

Schneider Electric will assign you any warranties which are made by manufacturers and suppliers of components of the Schneider Electric product and which are assignable. Any such warranties are assigned "AS IS" and Schneider Electric makes no representation as to the effectiveness or extent of such warranties, assumes no responsibility for any matters which may be warranted by such manufacturers or suppliers and extends no coverage under this Warranty to such components.

## Drawings, Descriptions

Schneider Electric warrants for the warranty period and on the terms of the warranty set forth herein that the Schneider Electric product will substantially conform to the descriptions contained in the Schneider Electric Official Published Specifications or any of the drawings certified and agreed to by contract with Schneider Electric if applicable thereto ("Specifications"). It is understood that the Specifications are not warranties of performance and not warranties of fitness for a particular purpose.

## Exclusions

Schneider Electric shall not be liable under the warranty if its testing and examination disclose that the alleged defect in the product does not exist or was caused by end user or any third person misuse, negligence, improper installation or testing. Further, Schneider Electric shall not be liable under the warranty for unauthorized attempts to repair or modify wrong or inadequate electrical voltage

or connection, inappropriate on-site operation conditions, corrosive atmosphere, repair, installation, start-up by non-Schneider Electric designated personnel, a change in location or operating use, exposure to the elements, Acts of God, fire, theft, or installation contrary to Schneider Electric recommendations or specifications or in any event if the Schneider Electric serial number has been altered, defaced, or removed, or any other cause beyond the range of the intended use.

THERE ARE NO WARRANTIES, EXPRESS OR IMPLIED, BY OPERATION OF LAW OR OTHERWISE, OF PRODUCTS SOLD, SERVICED OR FURNISHED UNDER THIS AGREEMENT OR IN CONNECTION HEREWITH. SCHNEIDER ELECTRIC DISCLAIMS ALL IMPLIED WARRANTIES OF MERCHANTABILITY, SATISFACTION AND FITNESS FOR A PARTICULAR PURPOSE. SCHNEIDER ELECTRIC EXPRESS WARRANTIES WILL NOT BE ENLARGED, DIMINISHED, OR AFFECTED BY AND NO OBLIGATION OR LIABILITY WILL ARISE OUT OF, SCHNEIDER ELECTRIC RENDERING OF TECHNICAL OR OTHER ADVICE OR SERVICE IN CONNECTION WITH THE PRODUCTS. THE FOREGOING WARRANTIES AND REMEDIES ARE EXCLUSIVE AND IN LIEU OF ALL OTHER WARRANTIES AND REMEDIES. THE WARRANTIES SET FORTH ABOVE CONSTITUTE SCHNEIDER ELECTRIC SOLE LIABILITY AND PURCHASER'S EXCLUSIVE REMEDY FOR ANY BREACH OF SUCH WARRANTIES. SCHNEIDER ELECTRIC WARRANTIES RUN ONLY TO PURCHASER AND ARE NOT EXTENDED TO ANY THIRD PARTIES.

IN NO EVENT SHALL SCHNEIDER ELECTRIC, ITS OFFICERS, DIRECTORS, AFFILIATES OR EMPLOYEES BE LIABLE FOR ANY FORM OF INDIRECT, SPECIAL, CONSEQUENTIAL OR PUNITIVE DAMAGES, ARISING OUT OF THE USE, SERVICE OR INSTALLATION, OF THE PRODUCTS, WHETHER SUCH DAMAGES ARISE IN CONTRACT OR TORT, IRRESPECTIVE OF FAULT, NEGLIGENCE OR STRICT LIABILITY OR WHETHER SCHNEIDER ELECTRIC HAS BEEN ADVISED IN ADVANCE OF THE POSSIBILITY OF SUCH DAMAGES, SPECIFICALLY, SCHNEIDER ELECTRIC IS NOT LIABLE FOR ANY COSTS, SUCH AS LOST PROFITS OR REVENUE, LOSS OF EQUIPMENT, LOSS OF USE OF EQUIPMENT, LOSS OF SOFTWARE, LOSS OF DATA, COSTS OF SUBSTITUANTS, CLAIMS BY THIRD PARTIES, OR OTHERWISE.

NO SALESMAN, EMPLOYEE OR AGENT OF SCHNEIDER ELECTRIC IS AUTHORIZED TO ADD TO OR VARY THE TERMS OF THIS WARRANTY. WARRANTY TERMS MAY BE MODIFIED, IF AT ALL, ONLY IN WRITING SIGNED BY AN SCHNEIDER ELECTRIC OFFICER AND LEGAL DEPARTMENT.

## Warranty Claims

Customers with warranty claims issues may access the SCHNEIDER ELECTRIC worldwide customer support network through the SCHNEIDER ELECTRIC web site: <http://www.schneider-electric.com>. Select your country from the country selection pull-down menu. Open the Support tab at the top of the web page to obtain contact information for customer support in your region.



Schneider Electric  
35 rue Joseph Monier  
92500 Rueil Malmaison  
France

+ 33 (0) 1 41 29 70 00



As standards, specifications, and design change from time to time,  
please ask for confirmation of the information given in this publication.

© 2019 – 2024 Schneider Electric. All rights reserved.

990-91141J-001