

PAS600L: 24 V_{DC}
(PAS600L-V2)
PAS600: 110-277 V_{AC}
(PAS600-V2)
PAS600P: Power over Ethernet (PoE)
(PAS600P-V2)

www.se.com/docs

EcoStruxure Panel Server

DOCA0172EN	DOCA0172DE
DOCA0172FR	DOCA0172IT
DOCA0172ES	DOCA0172PT

? → www.se.com/support

<p>Retain instruction sheet for future use. Visit our website at www.se.com/docs to download the documents listed above (user guides) and other documents.</p> <p>PLEASE NOTE</p> <ul style="list-style-type: none"> Electrical equipment should be installed, operated, serviced, and maintained only by qualified personnel. All pertinent state, regional, and local safety regulations must be observed when installing and using this product. No responsibility is assumed by Schneider Electric for any consequences arising out of the use of this material. 	<p>Instruction de service à conserver pour usage ultérieur. Visitez notre site web www.se.com/docs pour télécharger les documents listés ci-dessus (guide utilisateurs) et d'autres documents.</p> <p>REMARQUE IMPORTANTE</p> <ul style="list-style-type: none"> L'installation, l'utilisation, la réparation et la maintenance des équipements électriques doivent être assurées par du personnel qualifié uniquement. Toutes les réglementations locales, régionales et nationales pertinentes doivent être respectées lors de l'installation et de l'utilisation de ce produit. Schneider Electric décline toute responsabilité quant aux conséquences de l'utilisation de ce matériel. 	<p>Guarde la hoja de instrucciones para utilizarla en el futuro. Visite nuestra página web en www.se.com/docs para descargar los documentos enumerados anteriormente (manuales de usuario) así como otros documentos.</p> <p>TENGA EN CUENTA</p> <ul style="list-style-type: none"> La instalación, manejo, puesta en servicio y mantenimiento de equipos eléctricos deberán ser realizados sólo por personal cualificado. Al instalar y utilizar este producto es necesario tener en cuenta todas las regulaciones sobre seguridad correspondientes, ya sean regionales, locales o estatales. Schneider Electric no se hace responsable de ninguna de las consecuencias del uso de este material. 	<p>Bewahren Sie die Kurzanleitung als Referenz für den späteren Gebrauch auf. Besuchen Sie unsere Website unter www.se.com/docs um die oben aufgeführten Dokumente (Benutzerhandbücher) und weitere Dokumente herunterzuladen.</p> <p>BITTE BEACHTEN</p> <ul style="list-style-type: none"> Elektrische Geräte dürfen nur von Fachpersonal installiert, betrieben, bedient und gewartet werden. Bei der Montage und Verwendung dieses Produkts sind alle zutreffenden staatlichen, landesspezifischen, regionalen und lokalen Sicherheitsbestimmungen zu beachten. Schneider Electric haftet nicht für Schäden, die durch die Verwendung dieses Materials entstehen.
<p>Conservare questo foglio di istruzioni per un utilizzo futuro. Visitate il nostro sito web www.se.com/docs per scaricare i documenti elencati sopra (Guide utente) e altri documenti.</p> <p>NOTA</p> <ul style="list-style-type: none"> Manutenzione, riparazione, installazione e uso delle apparecchiature elettriche si devono affidare solo a personale qualificato. Durante l'installazione e l'uso di questo prodotto è necessario rispettare tutte le normative locali, nazionali o internazionali in materia di sicurezza. Schneider Electric non si assume alcuna responsabilità per qualsiasi conseguenza derivante dall'uso di questo materiale. 	<p>Guarde a folha de instruções para utilização futura. Visite o nosso site web em www.se.com/docs para transferir os documentos indicados acima (manuais de utilizador) e outros documentos.</p> <p>NOTA</p> <ul style="list-style-type: none"> A instalação, utilização e manutenção do equipamento eléctrico devem ser efectuadas exclusivamente por pessoal qualificado. Todos os regulamentos de segurança relevantes, sejam estatais, regionais ou locais, devem ser tomados em consideração quando instalar e utilizar este produto. A Schneider Electric não assume qualquer responsabilidade pelas consequências resultantes da utilização deste material. 	<p>Сохраните эту инструкцию для использования в будущем. Посетите наш веб-сайт www.se.com/docs чтобы загрузить перечисленные выше документы (руководства пользователя) и другие публикации.</p> <p>ОБРАТИТЕ ВНИМАНИЕ</p> <ul style="list-style-type: none"> Установка, эксплуатация, ремонт и обслуживание электрического оборудования может выполняться только квалифицированными электриками. Во время установки и использования данного продукта следует соблюдать все действующие государственные, региональные и местные правила безопасности. Компания Schneider Electric не несет никакой ответственности за любые возможные последствия использования данной документации. 	<p>请保管好此说明书以供将来使用。请访问网站 www.se.com/docs 以下载上述文件(用户指南)和其他文件。</p> <p>请注意</p> <ul style="list-style-type: none"> 电气设备的安装、操作、维修和维护工作仅限于合格人员执行。 在安装和使用本产品时，必须遵守国家、地区和当地的所有相关的安全法规。 Schneider Electric 不承担由于使用本资料所引起的任何后果。

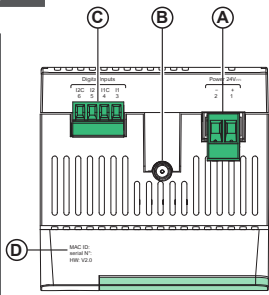

en

- A** Power supply terminal block (available in PAS600L and PAS600 only)
B IEE802.15.4 external antenna port
C Digital input terminal block (available in PAS600L only)
D MAC address, serial number and hardware version
E Panel Server status LED
F Restart button
 ● ≥ 10 s: Restart Panel Server
G QR code to product information
H RS-485 Modbus communication port
I Ethernet LED 1: Speed
J Ethernet LED 2: Activity
K Wi-Fi external antenna port
L Ethernet 1 communication port
M Ethernet 2 communication port (PoE port for PAS600P)
N Grounding connection

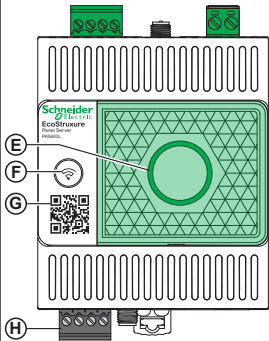

fr

- A** Bornier d'alimentation (disponible dans PAS600L et PAS600 uniquement)
B Port d'antenne externe IEEE 802.15.4
C Bornier d'entrée numérique (disponible dans PAS600L uniquement)
D Adresse MAC, numéro de série et version hardware
E Voyant d'état de Panel Server
F Bouton Redémarrer
 ● ≥ 10 s: Redémarrer Panel Server
G QR Code pour informations produit
H Port de communication Modbus RS-485
I Voyant Ethernet 1: Débit
J Voyant Ethernet 2: Activité
K Port d'antenne externe Wi-Fi
L Port de communication Ethernet 1
M Port de communication Ethernet 2 (Port PoE pour PAS600P)
N Connexion de mise à la terre

es

- A** Bloque de terminales de la fuente de alimentación (disponible únicamente en PAS600L y PAS600)
B Puerto de antena externa IEEE802.15.4
C Bloque de terminales de entrada digital (disponible únicamente en PAS600L)
D Dirección MAC, número de serie y versión de hardware
E Indicador LED de estado del Panel Server
F Botón de reinicio
 ● ≥ 10 s: Reiniciar el Panel Server
G Código QR de información de producto
H Puerto de comunicaciones Modbus RS-485
I Indicador LED de Ethernet 1: Velocidad
J Indicador LED de Ethernet 2: Actividad
K Puerto de antena externa de red Wi-Fi
L Puerto de comunicación Ethernet 1
M Puerto de comunicación Ethernet 2 (Puerto PoE en el caso de PAS600P)
N Conexión a tierra

de

- A** Klemmenleiste für Spannungsversorgung (verfügbar nur mit PAS600L und PAS600)
B IEE802.15.4-Anschluss für externe Antenne
C Klemmenleiste für Digitaleingänge (verfügbar nur mit PAS600L)
D MAC-Adresse, Seriennummer und Hardwareversion
E Status-LED des Panel Servers
F Neustarttaste
 ● ≥ 10 s: Panel Server neu starten
G QR-Code für Produktinformationen
H RS-485-Modbus-Kommunikationsport
I Ethernet-LED 1: Geschwindigkeit
J Ethernet-LED 2: Aktivität
K Port für externe WiFi-Antenne
L Ethernet-Kommunikationsport 1
M Ethernet-Kommunikationsport 2 (PoE-Port für PAS600P)
N Erdungsanschluss

it

- A** Morsettiera alimentazione (disponibile solo in PAS600L e PAS600)
B Porta per antenna esterna IEE802.15.4
C Morsettiera ingresso digitale (disponibile solo in PAS600L)
D Indirizzo MAC, numero di serie e versione hardware
E LED di stato Panel Server
F Pulsante Riavvio
 ● ≥ 10 s: Riavvia Panel Server
G Codice QR per informazioni prodotto
H Porta di comunicazione RS-485 Modbus
I LED 1 Ethernet: velocità
J LED 2 Ethernet: attività
K Porta antenna esterna Wi-Fi
L Porta di comunicazione Ethernet 1
M Porta di comunicazione Ethernet 2 (Porta PoE per PAS600P)
N Connessione di messa a terra

pt

- A** Bloco de terminais da fonte de alimentação (disponível apenas nos modelos PAS600L e PAS600)
B Porta da antena externa IEE802.15.4
C Borne de entrada digital (disponível apenas no PAS600L)
D Endereço MAC, número de série e versão de hardware
E LED de status do Panel Server
F Botão Reiniciar
 ● ≥ 10 s: reiniciar o Panel Server
G Código QR para informações sobre o produto
H Porta de comunicação Modbus RS-485
I LED Ethernet 1: velocidade
J LED Ethernet 2: atividade
K Porta de antena externa Wi-Fi
L Porta de comunicação Ethernet 1
M Porta de comunicação Ethernet 2 (Porta PoE para PAS600P)
N Ligaçãõ à terra

ru

- A** Клеммная колодка электропитания (доступна только для PAS600L и PAS600)
B Порт внешней антенны IEE802.15.4
C Клеммная коробка цифровых входов (доступна только в PAS600L)
D MAC-адрес, серийный номер и версия оборудования
E Светодиод состояния Panel Server
F Кнопка Restart
 ● ≥ 10 сек: перезапустить Panel Server
G QR-код информации об изделии
H Коммуникационный порт RS-485 Modbus
I Светодиод Ethernet 1: скорость
J Светодиод Ethernet 2: активность
K Разъем для внешней антенны Wi-Fi
L Коммуникационный порт Ethernet 1
M Коммуникационный порт Ethernet 2 (для PAS600P порт PoE)
N Подключение заземления

zh

- A** 电源端子块 仅 PAS600L 和 PAS600 中配备)
B IEE802.15.4 外部天线端口
C 数字量输入端子块 (仅 PAS600L 配备)
D MAC 地址、序列号和硬件版本
E Panel Server 状态 LED
F 重启按钮
 ● ≥ 10 秒: 重启 Panel Server
G 产品信息二维码
H RS-485 Modbus 通讯端口
I 以太网 LED 1: 速度
J 以太网 LED 2: 活动
K Wi-Fi 外部天线端口
L 以太网 1 通讯端口
M 以太网 2 通讯端口 (供 PAS600P 使用的 PoE 端口)
N 接地接口

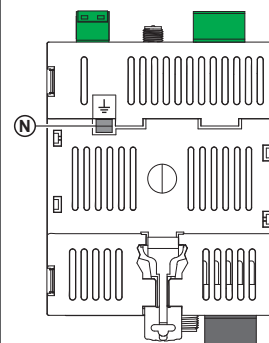
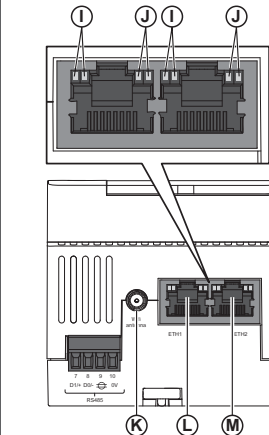

3 Dimensions / Dimensions / Dimensiones / Abmessungen / Misure d'ingombro / Dimensões / Размеры / 尺寸

mm
in.

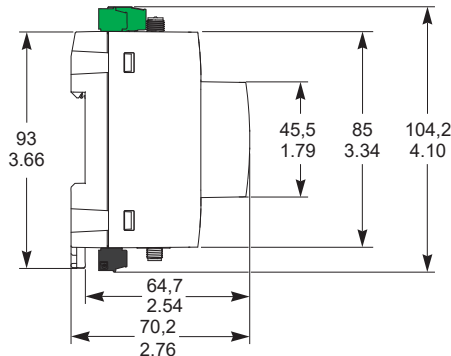
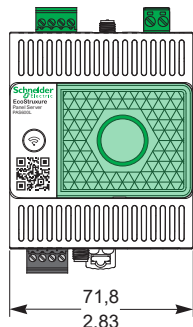

4 Installation / Installation / Instalación / Installation / Installazione / Instalação / Установка / 安装

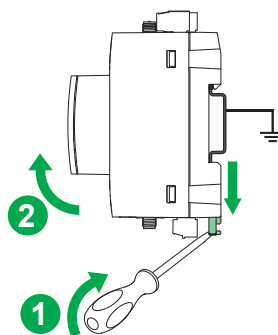
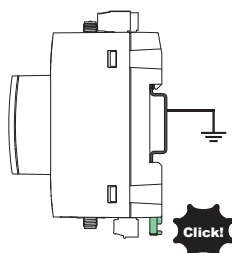
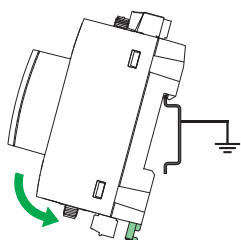

PLEASE NOTE

- For indoor use only.
- Not suitable for wet locations.
- Installation of the Panel Server on a vertical DIN rail is allowed if operating temperature remains between -25 °C to +50 °C (-13 °F to +122 °F).

NOTA

- Solo per uso interno.
- Non idoneo per luoghi umidi.
- L'installazione di Panel Server su una guida DIN verticale è consentita se la temperatura di esercizio rimane compresa tra -25°C a +50°C (da -13°F a +122°F).

REMARQUE IMPORTANTE

- Pour utilisation en intérieur uniquement.
- N'est pas adapté au milieux humides.
- L'installation du Panel Server sur un rail DIN vertical est autorisée si la température d'exploitation reste comprise entre -25 °C et +50 °C (-13 °F et +122 °F).

NOTA

- Apenas para uso interno.
- Não é adequado para locais molhados.
- A instalação do Panel Server numa calha DIN vertical é permitida se a temperatura de funcionamento permanecer entre -25 °C a +50 °C (da -13°F a +122°F).

TENGA EN CUENTA

- Solo para uso en interiores.
- No es adecuado para su uso en lugares húmedos.
- Se puede instalar Panel Server en un riel DIN vertical si la temperatura de funcionamiento permanece entre los -25 °C y los +50 °C (-13 °F y +122 °F).

ОБРАТИТЕ ВНИМАНИЕ

- Для использования только в закрытых помещениях.
- Не подходит для применения на влажных участках.
- Установка Panel Server на вертикальной DIN-рейке допускается, если рабочая температура находится в диапазоне между -25 °C до +50 °C (от -13 °F до +122 °F).

BITTE BEACHTEN

- Nur zum Gebrauch in Innenräumen.
- Nicht geeignet für feuchte Umgebungen.
- Der Panel Server kann auf einer vertikalen DIN-Schiene installiert werden, wenn die Betriebstemperatur zwischen -25 °C bis +50 °C (-13 °F bis +122 °F) bleibt.

请注意

- 仅在室内使用。
- 不适合潮湿场所。
- 如果工作温度保持在 -25 °C 至 +50 °C (-13 °F 至 +122 °F) 之间, 则允许在垂直 DIN 导轨上安装 Panel Server。



mm
in.

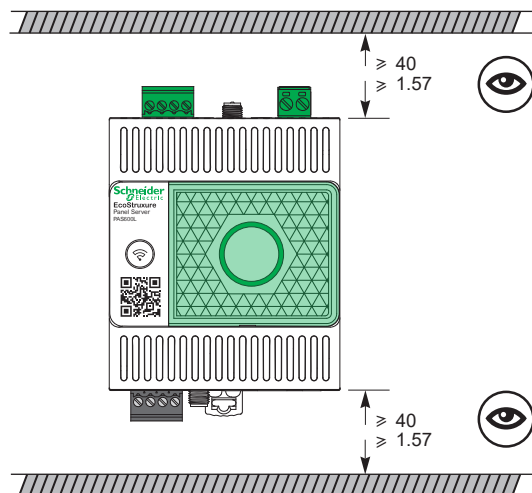

5.1 PAS600L/PAS600: Power Supply / Alimentation / Fuente de alimentación / Spannungsversorgung / Alimentatore / Fonte de alimentação / Источник питания / 电源

▲ ▲ DANGER / DANGER / PELIGRO / GEFAHR / PERICOLO / PERIGO / ОПАСНО / 危险**HAZARD OF ELECTRIC SHOCK, EXPLOSION OR ARC FLASH**

- PAS600L/PAS600 must be supplied by external power supply.
- PAS600L must be powered by 24 V_{DC}, UL/CSA approved class II power supply.
- PAS600L must be powered by 24 V_{DC}, galvanically isolated SELV power supply for non NEMA/UL countries.
- All cables wired to PAS600L/PAS600 must be connected to a single building earth.

Failure to follow these instructions will result in death or serious injury.

RISQUE D'ÉLECTROCUTION, D'EXPLOSION OU D'ÉCLAIR D'ARC ÉLECTRIQUE

- Les PAS600L/PAS600 nécessitent une alimentation externe.
- Les PAS600L nécessitent une alimentation 24 V_{DC} de classe II homologuée UL/CSA.
- Les PAS600L nécessitent une alimentation TBTS (très basse tension de sécurité) 24 V_{DC} isolée galvaniquement pour les pays non soumis aux homologations NEMA/UL.
- Tous les câbles raccordés aux PAS600L/PAS600 doivent être reliés à la terre d'un seul bâtiment.

Le fait de ne pas suivre ces instructions entrainera des blessures graves, voire mortelles.

PELIGRO DE DESCARGA ELÉCTRICA, EXPLOSIÓN O ARCO ELÉCTRICO

- Los modelos PAS600L/PAS600 solo pueden recibir alimentación de una fuente externa.
- El modelo PAS600L debe recibir alimentación de una fuente de 24 V_{DC} y clase II aprobada por UL/CSA.
- PAS600L debe tener una fuente de alimentación de muy baja tensión de seguridad (MBTS) con separación galvánica de 24 V_{DC} en los países en los que no se apliquen las normas de la asociación estadounidense de fabricantes eléctricos (NEMA) ni las normas de Underwriters Laboratories (UL).
- Todos los cables que se conecten a los modelos PAS600L/PAS600 deberán estar conectados a una misma toma de tierra del edificio.

El incumplimiento de estas instrucciones tendrá como resultado la muerte o lesiones graves.

GEFAHR VON ELEKTRISCHEM SCHLAG, EXPLOSION ODER LICHTBOGEN

- PAS600L/PAS600 müssen über eine externe Spannungsversorgung gespeist werden.
- Der PAS600L benötigt eine 24-V_{DC}-Speisung, Spannungsversorgung mit UL/CSA-Zulassung, Klasse II.
- In anderen als NEMA/UL-Ländern muss der PAS600L über eine galvanisch getrennte 24 V_{DC}-SELV-Spannungsversorgung gespeist werden.
- Alle an PAS600L/PAS600 angeschlossenen Kabel müssen mit derselben Gebäudeerde verbunden werden.

Eine Nichtbeachtung dieser Anweisungen hat Tod, schwere Verletzungen oder Schäden an der Ausrüstung zur Folge.

RISCHIO DI FOLGORAZIONE, ESPLOSIONI O ARCO ELETTRICO

- PAS600L/PAS600 deve essere alimentato dall'esterno.
- PAS600L deve essere alimentato a 24 V_{DC}, alimentazione di classe II con certificazione UL/CSA.
- PAS600L deve essere alimentato a 24 V_{DC}, alimentazione SELV isolata galvanicamente per paesi non NEMA/UL.
- Tutti i cavi collegati a PAS600L/PAS600 devono essere collegati a una singola terra dell'edificio.

Il mancato rispetto di queste istruzioni provocherà morte o gravi infortuni.

RISCO DE ELECTROCUSSÃO, DE EXPLOÇÃO, OU DE ARCO ELÉCTRICO

- PAS600L/PAS600 deve ser fornecido por uma fonte de alimentação externa.
- PAS600L deve ser alimentado por uma fonte de alimentação de classe II aprovada pela UL/CSA de 24 V_{DC}.
- PAS600L deve ser alimentado por uma fonte de alimentação SELV isolada galvanicamente de 24 V_{DC} para países não NEMA/UL.
- Todos os cabos conectados ao PAS600L/PAS600 devem ser conectados a um único edifício terra.

O não cumprimento destas instruções resultará em morte e lesões graves.

ОПАСНОСТЬ ПОРАЖЕНИЯ ЭЛЕКТРИЧЕСКИМ ТОКОМ, ВЗРЫВА ИЛИ ВСПЫШКИДУГИ

- Электропитание PAS600L/PAS600 должно осуществляться от внешнего источника.
- Электропитание PAS600L должно осуществляться от источника электропитания 24 V_{DC} постоянного тока, сертифицированного UL/CSA, класс II.
- В странах, где не действуют стандарты NEMA/UL, для питания 24 V_{DC} тока PAS600L должен использоваться источник питания безопасного сверхнизкого напряжения (SELV).
- Все кабели, подключенные к PAS600L/PAS600, должны быть подключены к единой системе заземления здания.





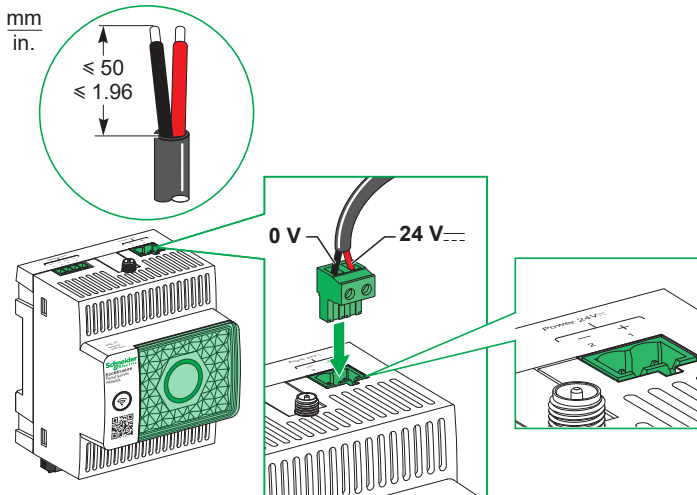
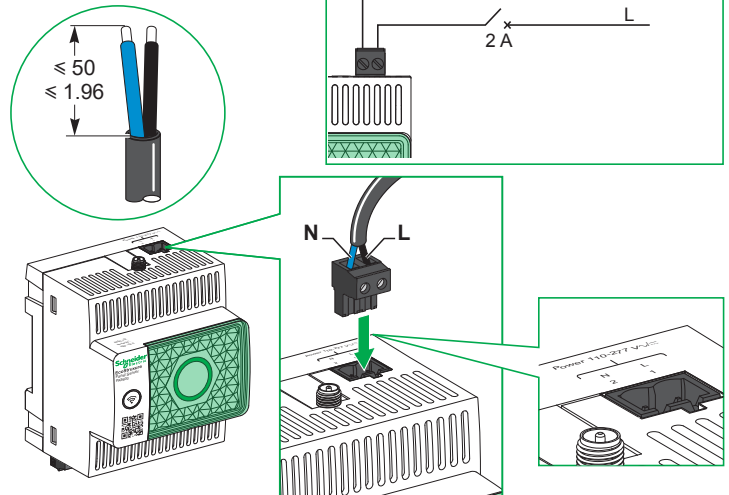

Несоблюдение данных инструкций приводит к смерти или серьезной травме.

电击、爆炸或弧闪的危险

- PAS600L/PAS600 必须由外部电源供电。
- PAS600L 必须由 24 V_{DC} UL/CSA II 类认证电源供电。
- 对于非 NEMA/UL 国家, PAS600L 必须由 24 V_{DC} 电隔离型 SELV 电源供电。
- 连接 PAS600L/PAS600 的所有电缆都必须连接到单一建筑接地点。

未按说明操作将导致人身伤亡等严重后果。

PAS600L (24 V_{DC})**PAS600 (110–277 V_{AC}/V_{DC})**

					
7 mm 0.27 in.	1,5–2,5 mm ² 16–14 AWG			0,6 N•m 5 lb-in.	3,5 mm 1/8 in.

5.2 Ethernet Connection / Raccordement Ethernet / Conexión Ethernet / Ethernet-Verbindung / Conessione Ethernet / Ligaçõ Ethernet / Подключение Ethernet / 以太网连接

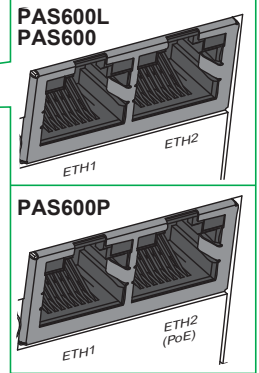
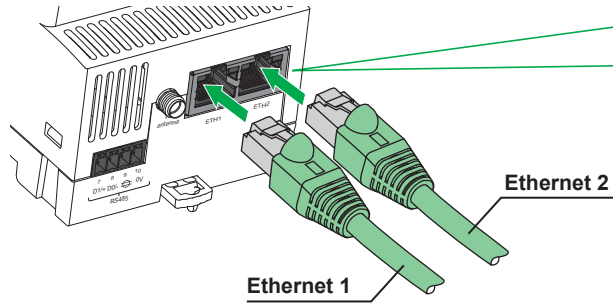
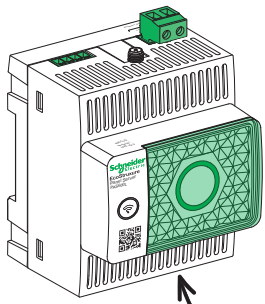

Note: PAS600P can be powered by Power over Ethernet (PoE).
Remarque: Le PAS600P peut être alimenté avec PoE (Power over Ethernet).
Nota: PAS600P se puede alimentar mediante Power over Ethernet (PoE).
Hinweis: PAS600P kann über PoE (Power over Ethernet) betrieben werden.
Nota: PAS600P può essere alimentato tramite Power over Ethernet (PoE).
Nota: o modelo PAS600P pode ser alimentado por Power over Ethernet (PoE).
Примечание: PAS600P может получать питание по сети Ethernet (Power over Ethernet, PoE).
注: PAS600P 可由 Ethernet (PoE) 供电

5.3 RS-485 Modbus Port / Port Modbus RS-485 / Puerto Modbus RS-485 / RS-485-Modbus-Port / Porta RS-485 Modbus / Porta Modbus RS-485 / Порт RS-485 Modbus / RS-485 Modbus 端口

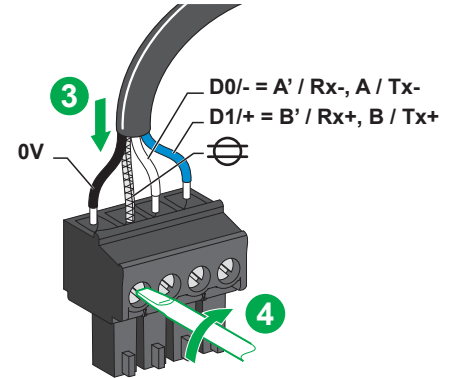
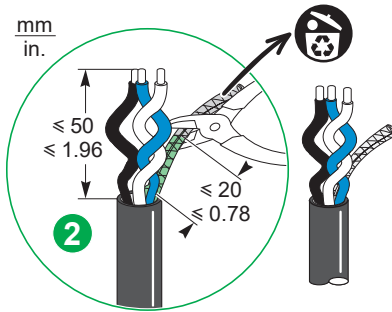
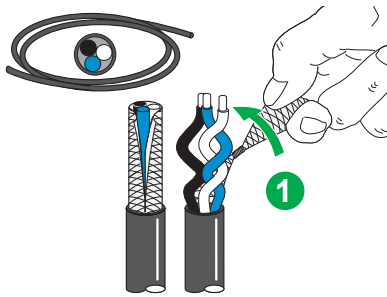

7 mm 0.27 in.	0,14–1,5 mm ² 26–16 AWG	≤ 50 mm ≤ 1.96 mm	≤ 20 mm ≤ 0.78 mm	0,25 N·m 2.21 lb-in.	2,5 mm 3/32 in.

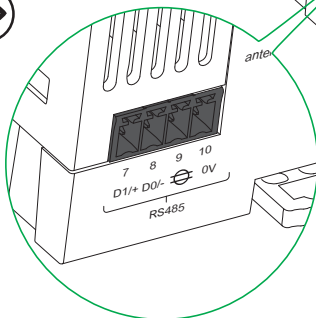
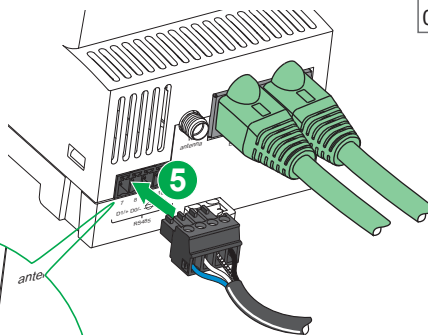
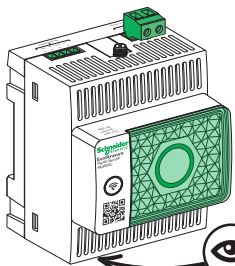

5.4 PAS600P: Ethernet Switch with Endspan PoE Ports / Commutateur Ethernet avec Ports PoE end-span / Conmutador Ethernet con Puertos PoE Endspan / Ethernet-Switch mit Endspan-PoE-Ports / Switch Ethernet con Porte PoE endspan / Comutador Ethernet com Portas PoE Endspan / Коммутатор Ethernet с портами Endspan PoE / 带有 Endspan PoE 端口的以太网交换机

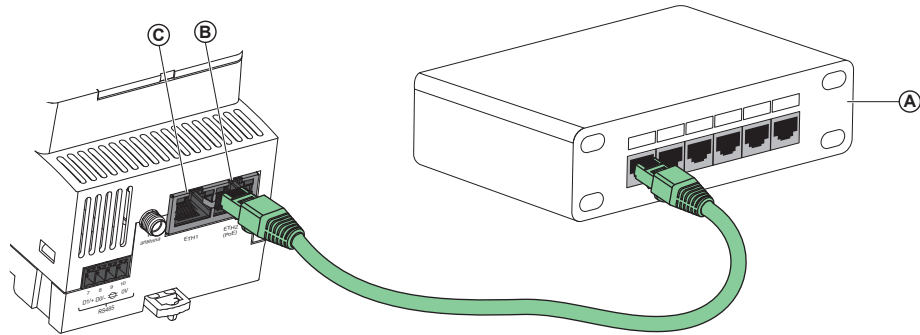
**en**

- A** Ethernet Switch with Endspan PoE ports
B Ethernet 2 (PoE) communication port
C Ethernet 1 communication port

fr

- A** Commutateur Ethernet avec ports PoE End-span
B Port de communication Ethernet 2 (PoE)
C Port de communication Ethernet 1

es

- A** Conmutador Ethernet con puertos PoE Endspan
B Puerto de comunicación Ethernet 2 (PoE)
C Puerto de comunicación Ethernet 1

de

- A** Ethernet-Switch mit Endspan-PoE-Ports
B Ethernet-Kommunikationsport 2 (PoE)
C Ethernet-Kommunikationsport 1

it

- A** Switch Ethernet con porte PoE Endspan
B Porta di comunicazione Ethernet 2
C Porta di comunicazione Ethernet 1

pt

- A** Comutador Ethernet com portas PoE Endspan
B Porta de comunicação Ethernet 2
C Porta de comunicação Ethernet 1

ru

- A** Коммутатор Ethernet с портами Endspan PoE
B Коммуникационный порт Ethernet 2
C Коммуникационный порт Ethernet 1

zh

- A** 带有 Endspan PoE 端口的以太网交换机
B 以太网 2 (PoE) 通讯端口
C 以太网 1 通讯端口

5.5 PAS600P: Ethernet Switch with Midspan PoE Ports / Commutateur Ethernet avec Ports PoE Midspan / Conmutador Ethernet con Puertos PoE Midspan / Ethernet-Switch mit Midspan-PoE-Ports / Switch Ethernet con Porte PoE midspan / Comutador Ethernet com Portas PoE Midspan / Коммутатор Ethernet с портами Midspan PoE / 带有 Midspan PoE 端口的以太网交换机

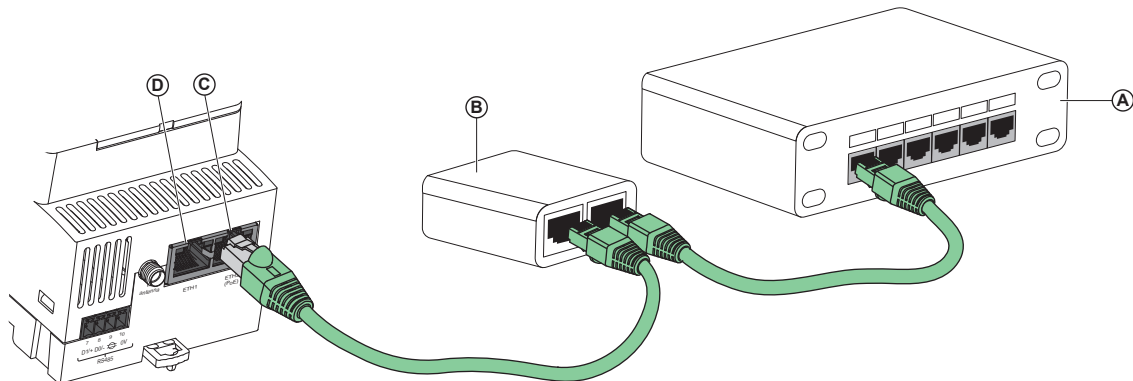
**en**

- A** Ethernet Switch
B Midspan PoE Injector
C Ethernet 2 (PoE) communication port
D Ethernet 1 communication port

fr

- A** Commutateur Ethernet
B Injecteur PoE Mid-span
C Port de communication Ethernet 2 (PoE)
D Port de communication Ethernet 1

es

- A** Conmutador Ethernet
B Inyector PoE Midspan
C Puerto de comunicación Ethernet 2 (PoE)
D Puerto de comunicación Ethernet 1

de

- A** Ethernet-Switch
B Midspan-PoE-Injektor
C Ethernet-Kommunikationsport (PoE)
D Ethernet-Kommunikationsport 1

it

- A** Switch Ethernet
B Iniettore Midspan PoE
C Porta di comunicazione Ethernet 2
D Porta di comunicazione Ethernet 1

pt

- A** Comutador Ethernet
B Injetor Midspan PoE
C Porta de comunicação Ethernet 2
D Porta de comunicação Ethernet 1

ru

- A** Коммутатор Ethernet
B Инжектор Midspan PoE
C Коммуникационный порт Ethernet 2
D Коммуникационный порт Ethernet 1

zh

- A** 以太网交换机
B Midspan PoE 注射器
C 以太网 2 (PoE) 通讯端口
D 以太网 1 通讯端口

5.6 PAS600L: Digital Inputs / Entrées numériques / Entradas digitales / Digitaleingänge / Ingressi digitali / Entradas digitais / Цифровые входы / 数字量输入

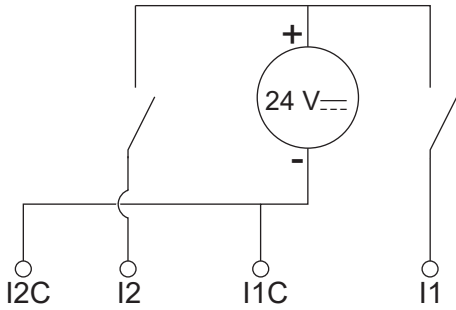

- en** **Note:** For digital input through dry contact, a 24 V_{DC} external power supply is required.
- fr** **Remarque:** Pour une entrée numérique via un contact sec, une alimentation externe 24 V_{DC} est requise.
- es** **Nota:** En el caso de una entrada digital por contacto seco, es necesaria una fuente de alimentación externa de 24 V_{DC}.
- de** **Hinweis:** Für Digitaleingänge über einen Trockenkontakt ist eine externe 24 V_{DC}-Spannungsversorgung erforderlich.
- it** **Nota:** per l'ingresso digitale attraverso contatto a secco, è richiesta un'alimentazione esterna da 24 V_{DC}.
- pt** **Nota:** para entrada digital através de contato seco, é necessária uma fonte de alimentação externa de 24 V_{DC}.
- ru** **Примечание:** для цифровых входов через беспотенциальный контакт, требуется внешний источник электропитания 24 V_{DC} постоянного тока.
- zh** **注:** 对于通过干触点实现的数字量输入, 需要使用 24 V_{DC} 外部电源。

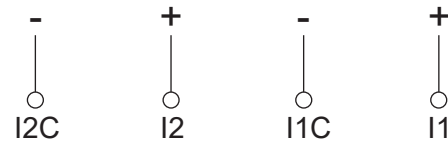

- en** **Note:** For digital input through potential contact, a 24 V_{DC} external power supply is not required. For example, connection to pulse output compliant to IEC62052-11.
- fr** **Remarque:** Pour une entrée numérique via un contact à potentiel, une alimentation externe 24 V_{DC} n'est pas nécessaire. Par exemple, raccordement à une sortie d'impulsions conforme à IEC62052-11.
- es** **Nota:** En el caso de una entrada digital por contacto con potencial, no es necesaria una fuente de alimentación externa de 24 V_{DC}. Por ejemplo, la conexión con la salida de pulsos compatible con IEC62052-11.
- de** **Hinweis:** Für Digitaleingänge über einen Potentialkontakt ist keine externe 24 V_{DC}-Spannungsversorgung erforderlich. Beispiel: Verbindung mit einem Impulsausgang gemäß IEC62052-11.
- it** **Nota:** per l'ingresso digitale attraverso contatto potenziale, non è richiesta un'alimentazione esterna da 24 V_{DC}. Ad esempio, connessione a uscita impulsi conforme a IEC62052-11.
- pt** **Nota:** para entrada digital através de contato em potencial, não é necessária uma fonte de alimentação externa de 24 V_{DC}. Por exemplo, conexão com saída de pulso compatível com IEC62052-11.
- ru** **Примечание:** для цифровых входов через контакт под напряжением, внешний источник электропитания 24 V_{DC} постоянного тока не требуется. Например, подключение к импульсному выходу в соответствии с МЭК 62052-11.
- zh** **注:** 对于通过电位触点实现的数字量输入, 不需要使用 24 V_{DC} 外部电源。比如, 根据 IEC62052-11 连接到脉冲输出。

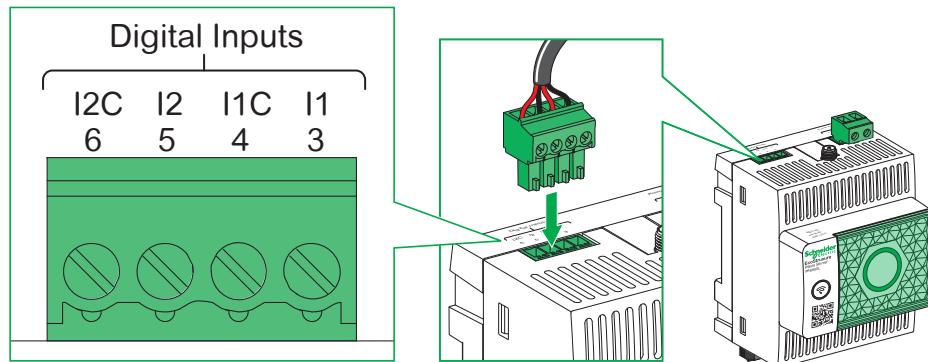

7 mm 0.27 in.	0,14–1,5 mm ² 26–16 AWG			0,25 N·m 2.21 lb-in.	2,5 mm 3/32 in.

6.1 Ethernet LEDs / Voyants Ethernet / Indicadores LED de Ethernet / Ethernet-LEDs / LED Ethernet / LEDs Ethernet / Светодиоды Ethernet / 以太网 LED

	①	②	③	④	⑤	⑥
en	No Ethernet communication		10 Mb Ethernet communication active		100 Mb Ethernet communication active	
fr	Pas de communication Ethernet		Communication Ethernet 10 Mb active		Communication Ethernet 100 Mb active	
es	No hay comunicación Ethernet		Comunicación Ethernet de 10 Mb activa		Comunicación Ethernet de 100 Mb activa	
de	Keine Ethernet-Kommunikation		10-Mbit/s-Ethernet-Kommunikation aktiv		100-Mbit/s-Ethernet-Kommunikation aktiv	
it	Nessuna comunicazione Ethernet		Comunicazione Ethernet 10 Mb attiva		Comunicazione Ethernet 100 Mb attiva	
pt	Sem comunicação Ethernet		Comunicação Ethernet de 10 Mb ativa		Comunicação Ethernet de 100 Mb ativa	
ru	Нет связи по Ethernet		Связь по каналу Ethernet 10 Мбит/с активна		Связь по каналу Ethernet 100 Мбит/с активна	
zh	无以太网通讯		已激活 10 Mb 以太网通讯		已激活 100 Mb 以太网通讯	

6.2 Panel Server Status LED / Voyant d'état de Panel Server / Indicador LED de estado del Panel Server / Status-LED des Panel Server / LED di stato Panel Server / LED de status do Panel Server / Светодиод состояния Panel Server / Panel Server 状态 LED

en	No power	Panel Server is powering on. System boots within 2 min.	Nominal status	Minor malfunction, connect to EPC to diagnose.	Major malfunction, Panel Server must be replaced.
fr	Aucune alimentation	Panel Server est en cours de mise sous tension. Initialisation du système dans 2 min.	Etat nominal	Dysfonctionnement mineur, accédez à EPC pour le diagnostic.	Dysfonctionnement majeur, remplacez Panel Server.
es	Sin alimentación	El Panel Server recibe alimentación. El sistema arrancará en 2 min.	Estado nominal	Fallo de funcionamiento leve. Realice la conexión a EPC para obtener el diagnóstico.	Fallo de funcionamiento grave. Es necesario sustituir el Panel Server.
de	Keine Spannung	Panel Server läuft hoch. System startet innerhalb von 2 Min.	Sollzustand	Behebbarer Funktionsstörung, Verbindung zur EPC für Diagnose herstellen.	Nicht behebbarer Funktionsstörung, der Panel Server muss ausgetauscht werden.
it	Assenza di alimentazione	Accensione Panel Server in corso. Il sistema si avvia entro 2 min.	Stato nominale	Malfunzionamento minore, collegare a EPC per la diagnostica.	Malfunzionamento grave, sostituire Panel Server.
pt	Sem energia	O Panel Server está sendo ligado. O sistema inicia em 2 minutos.	Status nominal	Mau funcionamento menor, conecte-se ao EPC para diagnosticar.	Mau funcionamento grave, o Panel Server deve ser substituído.
ru	Нет питания	Выполняется включение электропитания Panel Server. Система загружается в течение 2 мин.	Номинальное состояние	Незначительная неполадка, подключитесь к EPC для проведения диагностики.	Значительная неполадка, необходимо заменить Panel Server.
zh	未通电	正在开启 Panel Server。系统将在 2 分钟内启动。	正常状态	小故障，连接到 EPC 进行诊断。	大故障，必须更换 Panel Server。

EPC: EcoStruxure Power Commission software

7 Commissioning / Mise en service / Puesta en servicio / Inbetriebnahme / Messa in servizio / Comissionamento / Ввод в эксплуатацию / 调试

PLEASE NOTE Commissioning is a mandatory step for enabling Panel Server functions.	REMARQUE IMPORTANTE La mise en service est une étape obligatoire pour activer les fonctions de Panel Server.	TENGA EN CUENTA La puesta en marcha es un paso obligatorio para poder habilitar las funciones del Panel Server.	BITTE BEACHTEN Die Inbetriebnahme muss durchgeführt werden, um die Funktionen des Panel Server zu aktivieren.
NOTA La messa in servizio è un passaggio obbligatorio per attivare le funzioni di Panel Server.	NOTA A colocação em operação é uma etapa obrigatória para ativar as funções do Panel Server.	ОБРАТИТЕ ВНИМАНИЕ Ввод в эксплуатацию является обязательным этапом для включения функций Panel Server.	请注意 调试是启用 Panel Server 功能的必要步骤。

7.1 With EPC Software / Avec le logiciel EPC / Con el software de EPC / Mit der EPC-Software / Con software EPC / Com software EPC / С использованием ПО EPC / 使用 EPC 软件

- en Panel Server Commissioning with EcoStruxure Power Commission (EPC) software:**
1. Search for EcoStruxure Power Commission on your Schneider Electric country website
<https://www.se.com/ww/en/product-country-selector/?pageType=product-range&sourceId=62980>
 2. Download EcoStruxure Power Commission (EPC) software.
 3. Install EPC on your PC.
 4. Connect the PC to an Ethernet port of the Panel Server.
 5. Open EPC software.
 6. Follow the instructions. For more information, refer to the EPC Online Help.

- fr Mise en service du Panel Server avec le logiciel EcoStruxure Power Commission (EPC):**
1. Recherchez EcoStruxure Power Commission sur le site Web Schneider Electric de votre pays
<https://www.se.com/ww/en/product-country-selector/?pageType=product-range&sourceId=62980>
 2. Téléchargez le logiciel EcoStruxure Power Commission (EPC).
 3. Installez EPC sur votre PC.
 4. Connectez le PC à un port Ethernet du Panel Server.
 5. Ouvrez le logiciel EPC.
 6. Suivez les instructions. Pour plus d'informations, consultez l'aide en ligne d'EPC.

- es Puesta en marcha de Panel Server con el software EcoStruxure Power Commission (EPC):**
1. Busque EcoStruxure Power Commission en el sitio web de Schneider Electric de su país
<https://www.se.com/ww/en/product-country-selector/?pageType=product-range&sourceId=62980>
 2. Descargue el software EcoStruxure Power Commission (EPC).
 3. Instale EPC en su PC.
 4. Conecte el PC a un puerto Ethernet del Panel Server.
 5. Abra el software EPC.
 6. Siga las instrucciones. Para obtener más información, consulte la ayuda en línea de EPC.

- de Inbetriebnahme des Panel Servers mit der Software EcoStruxure Power Commission (EPC):**
1. Suchen Sie auf Ihrer landesspezifischen Website von Schneider Electric nach Ecostruxure Power Commission.
 2. Laden Sie die Software EcoStruxure Power Commission (EPC) herunter.
<https://www.se.com/ww/en/product-country-selector/?pageType=product-range&sourceId=62980>
 3. Installieren Sie EPC auf Ihrem PC.
 4. Verbinden Sie den PC mit einem Ethernet-Port des Panel Servers.
 5. Öffnen Sie die EPC-Software.
 6. Halten Sie sich an die Anweisungen. Weitere Informationen finden Sie in der Online-Hilfe von EPC.

- it Messa in servizio di Panel Server con software EcoStruxure Power Commission (EPC):**
1. Cercare EcoStruxure Power Commission nel sito Web nazionale di Schneider Electric
<https://www.se.com/ww/en/product-country-selector/?pageType=product-range&sourceId=62980>
 2. Scaricare il software EcoStruxure Power Commission (EPC).
 3. Installare EPC sul PC.
 4. Collegare il PC a una porta Ethernet di Panel Server.
 5. Aprire il software EPC.
 6. Seguire le istruzioni. Per ulteriori informazioni, consultare la guida in linea di EPC.

- pt Comissionamento do servidor de painel com software EcoStruxure Power Commission (EPC):**
1. Pesquise "EcoStruxure Power Commission" no Website Schneider Electric do seu país
<https://www.se.com/ww/en/product-country-selector/?pageType=product-range&sourceId=62980>
 2. Download do software EcoStruxure Power Commission (EPC).
 3. Instale o EPC no seu PC.
 4. Conecte o PC a uma porta Ethernet do Panel Server.
 5. Abra o software EPC.
 6. Siga as instruções. Para obter mais informações, consulte a Ajuda on-line do EPC.

- ru Ввод в эксплуатацию Panel Server с программным обеспечением EcoStruxure Power Commission (EPC):**
1. Выполните поиск Ecostruxure Power Commission на веб-сайте Schneider Electric в вашей стране
<https://www.se.com/ww/en/product-country-selector/?pageType=product-range&sourceId=62980>
 2. Загрузите ПО EcoStruxure Power Commission (EPC).
 3. Установите ПО EPC на своем ПК.
 4. Подключите ПК к порту Ethernet сервера Panel Server.
 5. Откройте ПО EPC.
 6. Следуйте указаниям. Дополнительную информацию см. в справке по EPC онлайн.

- zh 使用 EcoStruxure Power Commission (EPC) 软件调试 Panel Server:**
1. 请在 Schneider Electric 网站上搜索 "EcoStruxure Power Commission"
<https://www.se.com/ww/en/product-country-selector/?pageType=product-range&sourceId=62980>
 2. 下载 EcoStruxure Power Commission (EPC) 软件。
 3. 在您的 PC 上安装 EPC。
 4. 将 PC 连接到 Panel Server 的以太网端口。
 5. 打开 EPC 软件。
 6. 按照说明进行操作。有关更多信息，请参阅 EPC 在线帮助。

7.2 With EcoStruxure Panel Server Webpages / Avec les pages Web de EcoStruxure Panel Server / Con páginas web de EcoStruxure Panel Server / Über die Webseiten von Ecostruxure Panel Server / Con le pagine Web di EcoStruxure Panel Server / Com Páginas Web do Ecostruxure Panel Server / С веб-страницами EcoStruxure Panel Server / 使用 EcoStruxure Panel Server 网页

en Panel Server Commissioning with EcoStruxure Panel Server Webpages

The Panel Server supports Device Profile for Web Service (DPWS) that allows self-discovery of the Panel Server.

1. Disconnect the PC from the local area network and switch off Wi-Fi
2. Connect an Ethernet cable from the PC to the Panel Server
3. On the PC, launch the File Explorer and click Network
4. Wait until the EcoStruxure Panel Server icon displays in the list of devices in the network. It may take up to 2 minutes after the Panel Server is powered on.
5. Double-click the EcoStruxure Panel Server icon.
6. Follow the instructions available in the Panel Server user guide, EcoStruxure Panel Server webpages part, to pair/unpair wireless devices or add/remove Modbus devices.

fr Mise en service du Panel Server avec les pages Web EcoStruxure Panel Server

Panel Server prend en charge le protocole DPWS (Device Profile for Web Service) qui permet la détection automatique du Panel Server.

1. Déconnectez le PC du réseau local et coupez le Wi-Fi
2. Connectez un câble Ethernet entre le PC et le Panel Server
3. Sur le PC, lancez l'Explorateur de fichiers et cliquez sur Réseau
4. Attendez que l'icône Ecostruxure Panel Server s'affiche dans la liste des équipements participant au réseau. Cela peut prendre jusqu'à 2 minutes après la mise sous tension du Panel Server.
5. Double-cliquez sur l'icône Ecostruxure Panel Server.
6. Suivez les instructions disponibles dans le guide d'utilisation du Panel Server (partie Pages Web d'EcoStruxure Panel Server) pour appairier/désappairier des appareils sans fil ou ajouter/supprimer des appareils Modbus.

es Panel Server Commissioning con páginas web de EcoStruxure Panel Server

Panel Server admite el perfil de dispositivos para servicios web (DPWS) que permite la detección automática de Panel Server.

1. Desconecte el equipo de la red de área local y apague la red wifi
2. Conecte el equipo a Panel Server con un cable Ethernet
3. En el equipo, inicie el Explorador de archivos y haga clic en "Red"
4. Espere a que el icono de EcoStruxure Panel Server aparezca en la lista de dispositivos de la red. Puede tardar hasta dos minutos desde que se inicia Panel Server.
5. Haga doble clic en el icono de EcoStruxure Panel Server.
6. Siga las instrucciones disponibles en la guía de usuario de Panel Server, parte de las páginas web de EcoStruxure Panel Server, para emparejar/desemparejar dispositivos inalámbricos o agregar/quitar dispositivos Modbus.

de Inbetriebnahme des Panel Server über die Webseiten von Ecostruxure Panel Server

Der Panel Server unterstützt den Geräteprofil-Webdienst (DPWS: Device Profile for Web Service), der die automatische Erkennung des Panel Server ermöglicht.

1. Trennen Sie den PC vom lokalen Netzwerk und schalten Sie das WLAN ab.
2. Verbinden Sie den PC über ein Ethernet-Kabel mit dem Panel Server.
3. Starten Sie auf dem PC den Datei-Explorer und klicken Sie auf „Netzwerk“.
4. Warten Sie, bis das Symbol für Ecostruxure Panel Server in der Geräteliste im Netzwerk angezeigt wird. Es kann bis zu 2 Minuten nach dem Einschalten des Panel Server dauern.
5. Doppelklicken Sie auf das Symbol von Ecostruxure Panel Server.
6. Befolgen Sie die Anweisungen im Panel Server-Benutzerhandbuch im Abschnitt zu den EcoStruxure Panel Server-Webseiten, um Wireless-Geräte zu koppeln bzw. zu entkoppeln oder Modbus-Geräte hinzuzufügen bzw. zu entfernen.

it Messa in servizio di Panel Server con le pagine Web di EcoStruxure Panel Server

Panel Server supporta DPWS (Device Profile for Web Service) che consente l'individuazione automatica di Panel Server.

1. Scollegare il PC dalla LAN e spegnere il Wi-Fi
2. Collegare un cavo Ethernet dal PC a Panel Server
3. Sul PC, avviare Esplora file e fare clic su Rete
4. Attendere che l'icona EcoStruxure Panel Server venga visualizzata nell'elenco dei dispositivi nella rete. Possono essere necessari fino a 2 minuti dopo l'accensione di Panel Server.
5. Fare doppio clic sull'icona EcoStruxure Panel Server.
6. Seguire le istruzioni disponibili nella guida utente di Panel Server, sezione relativa alle pagine Web di EcoStruxure Panel Server, per abbinare/disabbinare dispositivi wireless o aggiungere/rimuovere dispositivi Modbus.

pt Colocação em funcionamento com as páginas Web do Ecostruxure Panel Server

O Panel Server suporta o Perfil de Dispositivo para Serviço Web (DPWS) que permite a deteção automática do Panel Server.

1. Desligue o computador da rede local e desligue a Wi-Fi
2. Ligue um cabo Ethernet do PC ao Panel Server
3. No PC, inicie o Explorador de ficheiros e clique em Rede
4. Aguarde até o ícone Ecostruxure Panel Server seja apresentado na lista de dispositivos na rede. Pode demorar até 2 minutos depois do Panel Server ser ligado.
5. Clique duas vezes no ícone Ecostruxure Panel Server.
6. Siga as instruções disponíveis no manual de utilizador do Panel Server, na parte de páginas Web do EcoStruxure Panel Server, para emparelhar/desemparelhar dispositivos sem fios ou adicionar/remover dispositivos Modbus.

ru Ввод Panel Server в эксплуатацию с помощью веб-страниц EcoStruxure Panel Server

Panel Server поддерживает профиль устройства для веб-службы (DPWS), который обеспечивает автообнаружение Panel Server.

1. Отсоедините компьютер от локальной сети и выключите Wi-Fi
2. Подключите Ethernet-кабель от ПК к Panel Server
3. На ПК запустите Проводник и нажмите «Сеть»
4. Дождитесь, пока в списке устройств в сети не появится значок «EcoStruxure Panel Server». После включения питания Panel Server может потребоваться до 2 минут.
5. Дважды щелкните значок «EcoStruxure Panel Server».
6. Порядок сопряжения/разъединения беспроводных устройств или добавления/удаления устройств Modbus см. в инструкциях, приведенных в руководстве пользователя Panel Server, на веб-страницах EcoStruxure Panel Server.

zh 使用 EcoStruxure Panel Server 网页进行 Panel Server 调试

Panel Server 支持允许自动发现 Panel Server 的 Web 服务设备配置文件 (DPWS)。

1. 断开 PC 与局域网的连接，并关闭 Wi-Fi
2. 将 PC 的 Ethernet 电缆连接至 Panel Server
3. 在 PC 上，启动文件资源管理器，然后单击“网络”
4. 等待 EcoStruxure Panel Server 图标显示在网络中的设备列表中。Panel Server 通电后，可能最多需要 2 分钟。
5. 双击 Ecostruxure Panel Server 图标。
6. 按照“Panel Server 用户指南 EcoStruxure Panel Server 网页部分”中的说明，配对/取消配对无线设备或添加/删除 Modbus 设备。

en

Communication

- 2 10/100 BASE-T Ethernet RJ45 ports, DPWS ready DHCP client IPv4, IPv6
- RS-485 Modbus port
- Ethernet 2 IEEE802.3af (802.3at Type1)

Input characteristics

- Digital inputs: Type1

Power supply

- PAS600L: 24 V_{DC} (±10 %)
- PAS600P: Power over Ethernet powered device
- PAS600: 110–277 V_{AC} (±10 %)
- Frequency rating:
 - PAS600: 50–60 Hz (±5 Hz)
- Overvoltage Category III
- Power consumption:
 - PAS600L: < 3.5 W (maximum)
 - PAS600: < 3.5 W (12 VA) (maximum)
 - PAS600P: < 3.5 W (maximum)
- Power input for PAS600P
 - Power over Ethernet: Class 0
 - Operating Input Range: 37–57 V_{DC}
 - Rating: < 3.5 W (72 mA) 48 V_{DC} typical

Environment

- Operating temperature: -25 °C to +70 °C (-13 °F to +158 °F)
- Storage temperature: -40 °C to +85 °C (-40 °F to +185 °F)
- Altitude: 2000 m (6500 ft)
- Humidity: 5–95 % relative humidity (without condensation) at 55 °C (131 °F)
- Pollution degree:
 - PAS600L: 3
 - PAS600P: 2
 - PAS600: 2

Mechanical characteristics

- Connectors: IP20
- Other faces: IP30
- Front face nose: IP40

fr

Communication

- 2 ports RJ45 Ethernet BASE-T 10/100, client DHCP IPv4, IPv6 prêt pour DPWS
- Port Modbus RS-485
- Ethernet 2 IEEE 802.3af (802.3at Type 1)

Caractéristiques des entrées

- Entrées numériques: Type1

Alimentation

- PAS600L: 24 V_{DC} (±10 %)
- PAS600P: appareil alimenté avec PoE
- PAS600: 110–277 V_{AC} (±10 %)
- Fréquence:
 - PAS600: 50–60 Hz (±5 Hz)
- Catégorie III de surtension
- Puissance consommée:
 - PAS600L: < 3.5 W (maximum)
 - PAS600: < 3.5 W (12 VA) (maximum)
 - PAS600P: < 3.5 W (maximum)
- Alimentation d'entrée du PAS600P
 - Power over Ethernet: Class 0
 - Plage d'entrée de fonctionnement: 37–57 V_{DC}
 - Calibre: <3,5 W (72 mA) 48 V_{DC} typique

Environnement

- Température d'exploitation : -25 °C à +70 °C (-13 °F à +158 °F)
- Température de stockage : -40 °C à +85 °C (-40 °F à +185 °F)
- Altitude: 2000 m (6500 pi.)
- Humidité: 5 à 95 % d'humidité relative (sans condensation) à 55 °C (131 °F)
- Degré de pollution:
 - PAS600L: 3
 - PAS600P: 2
 - PAS600: 2

Caractéristiques mécaniques

- Connecteurs: IP20
- Autres faces: IP30
- Nez en face avant: IP40

es

Comunicación

- 2 puertos RJ45 Ethernet 10/100 BASE-T, cliente DHCP preparado para DPWS IPv4, IPv6
- Puerto Modbus RS-485
- Ethernet 2 IEEE802.3af (802.3at tipo 1)

Características de entradas

- Entradas digitales: Tipo 1

Fuente de alimentación

- PAS600L: 24 V_{DC} (±10 %)
- PAS600P: Dispositivo alimentado mediante Power over Ethernet
- PAS600: De 110 a 277 V_{AC} (±10 %)
- Frecuencia nominal:
 - PAS600: De 50 a 60 Hz (±5 Hz)
- Categoría de sobretensión III
- Consumo de alimentación:
 - PAS600L: < 3.5 W (máximo)
 - PAS600: < 3.5 W (12 VA) (máximo)
 - PAS600P: < 3.5 W (máximo)
- Entrada de alimentación para PAS600P
 - Power over Ethernet: clase 0
 - Intervalo de entrada de funcionamiento: 37–57 V_{DC}
 - Características nominales: < 3,5 W (72 mA) 48 V_{DC} típica

Entorno

- Temperatura de funcionamiento: de -25 °C a +70 °C (de -13 °F a +158 °F)
- Temperatura de almacenamiento: de -40 °C a +85 °C (de -40 °F a +185 °F)
- Altitud: 2000 m (6500 pies)
- Humedad: De 5 a 95 % de humedad relativa (sin condensación) a 55 °C (131 °F)
- Grado de contaminación:
 - PAS600L: 3
 - PAS600P: 2
 - PAS600: 2

Características mecánicas

- Conectores: IP20
- Otras caras: IP30
- Protuberancia de la cara frontal: IP40

de

Kommunikation

- 2 Ports 10/100 BASE-T Ethernet RJ45, DPWS-fähiger DHCP-Client IPv4, IPv6
- RS-485-Modbus-Port
- Ethernet 2 IEEE802.3af (802.3at Typ 1)

Eingangseigenschaften

- Digitaleingänge: Typ 1

Spannungsversorgung

- PAS600L: 24 V_{DC} (±10 %)
- PAS600P: PoE-betriebenes Gerät (Power over Ethernet)
- PAS600: 110–277 V_{AC} (±10 %)
- Frequenzbereich:
 - PAS600: 50–60 Hz (±5 Hz)
- Überspannungskategorie III
- Stromverbrauch:
 - PAS600L: < 3.5 W (max.)
 - PAS600: < 3.5 W (12 VA) (max.)
 - PAS600P: < 3.5 W (max.)
- Leistungseingang für PAS600P
 - Power over Ethernet: Klasse 0
 - Betriebseingangsbereich: 37–57 V_{DC}
 - Nennleistung: < 3,5 W (72 mA), 48 V_{DC} typisch

Umgebung

- Betriebstemperatur: -25 °C bis +70 °C (-13 °F bis +158 °F)
- Lagertemperatur: -40 °C bis +85 °C (-40 °F bis +185 °F)
- Höhe: 2000 m (6500 ft)
- Feuchtigkeit: 5–95 % relative Luftfeuchtigkeit (ohne Kondensation) bei 55 °C (131 °F)
- Verschmutzungsgrad:
 - PAS600L: 3
 - PAS600P: 2
 - PAS600: 2

Mechanische Eigenschaften

- Anschlüsse: IP20
- Andere Schnittstellen: IP30
- Frontseitiger Nasenanschluss: IP40

it

Comunicazione

- 2 porte RJ45 Ethernet 10/100 BASE-T, client IPv4, IPv6 DHCP compatibile con DPWS
- Porta RS-485 Modbus
- Ethernet 2 IEEE802.3af (802.3at Tipo 1)

Caratteristiche ingresso

- Ingressi digitali: tipo 1

Alimentazione

- PAS600L: 24 V_{DC} (±10 %)
- PAS600P: Dispositivo alimentato tramite Power over Ethernet
- PAS600: 110–277 V_{AC}/V_{DC} (±10 %)
- Frequenza nominale:
 - PAS600: 50–60 Hz (±5 Hz)
- Categoria sovratensione III
- Assorbimento:
 - PAS600L: < 3.5 W (max)
 - PAS600: < 3.5 W (12 VA) (max)
 - PAS600P: < 3.5 W (max)
- Ingresso alimentazione per PAS600P
 - Power over Ethernet: classe 0
 - Campo ingresso operativo: 37–57 V_{DC}
 - Valore nominale: < 3,5 W (72 mA) 48 V_{DC} tipico

Ambiente

- Temperatura di funzionamento: da -25 °C a +70 °C (da -13 °F a +158 °F)
- Temperatura di stoccaggio: da -40 °C a +85 °C (da -40 °F a +185 °F)
- Altitudine: 2000 m (6500 ft)
- Umidità: 5–95 % umidità relativa (senza condensa) a 55 °C (131 °F)
- Grado di inquinamento:
 - PAS600L: 3
 - PAS600P: 2
 - PAS600: 2

Caratteristiche meccaniche

- Connettori: IP20
- Altri lati: IP30
- Sporgenza anteriore: IP40

pt

Comunicação

- 2 portas 10/100 BASE-T Ethernet RJ45, cliente DHCP pronto para DPWS IPv4, IPv6
- Porta Modbus RS-485
- Ethernet 2 IEEE802.3af (802.3at tipo 1)

Características de entrada

- Entradas digitais: Tipo 1

Fonte de alimentação

- PAS600L: 24 V_{DC} (±10 %)
- PAS600P: Ligar dispositivo ativado por Ethernet powered device
- PAS600: 110–277 V_{AC}/V_{DC} (±10 %)
- Classificação de frequência:
 - PAS600: 50–60 Hz (±5 Hz)
- Categoria III de sobretensão
- Consumo de energia:
 - PAS600L: < 3.5 W (máximo)
 - PAS600: < 3.5 W (12 VA) (máximo)
 - PAS600P: < 3.5 W (máximo)
- Entrada de alimentação do PAS600P
 - Power over Ethernet: classe 0
 - Gama de entrada de funcionamento: 37–57 V_{DC}
 - Potência: < 3,5 W (72 mA) 48 V_{DC} típica

Ambiente

- Temperatura de operação: -25 °C a +70 °C (-13 °F a +158 °F)
- Temperatura de armazenamento: -40 °C a +85 °C (-40 °F a +185 °F)
- Altitude: 2000 m (6500 pés)
- Umidade: 5–95% de umidade relativa (sem condensação) a 55 °C (131 °F)
- Grau de poluição:
 - PAS600L: 3
 - PAS600P: 2
 - PAS600: 2

Características mecânicas

- Conectores: IP20
- Outras faces: IP30
- Nariz frontal: IP40

ru

Связь

- 2 порта 10/100 BASE-T Ethernet RJ45, DHCP-клиент с поддержкой DPWS IPv4, IPv6
- Порт RS-485 Modbus
- Ethernet 2 IEEE802.3af (802.3at тип 1)

Характеристики входов

- Цифровые входы: тип 1

Источник питания

- PAS600L: 24 V_{DC} (±10 %)
- PAS600P: Устройство с питанием по сети Ethernet (Power over Ethernet)
- PAS600: 110–277 V_{AC}/V_{DC} (±10 %)
- Номинальная частота:
 - PAS600: 50–60 Гц (±5 Гц)
- Категория перенапряжения III
- Потребление энергии:
 - PAS600L: < 3.5 Вт (максимум)
 - PAS600: < 3.5 Вт (12 ВА) (максимум)
 - PAS600P: < 3.5 Вт (максимум)
- Вход питания для PAS600P
 - Power over Ethernet: класс 0
 - Рабочий диапазон на входе: 37–57 V_{DC}
 - Номинальная мощность: < 3,5 Вт (72 мА), 48 V_{DC} типовая

Окружение

- Рабочая температура: от -25 °C до +70 °C (от -13 до +158 °F)
- Температура хранения: от -40 °C до +85 °C (от -40 до +185 °F)
- Высота над уровнем моря: 2000 м (6500 футов)
- Относительная влажность: 5–95 % (без конденсации) при 55 °C (131 °F)
- Степень загрязнения:
 - PAS600L: 3
 - PAS600P: 2
 - PAS600: 2

Механические характеристики

- Соединители: IP20
- Другие лицевые поверхности: IP30
- Передняя торцевая лицевая поверхность: IP40

zh

通讯

- 2个 10/100 BASE-T 以太网 RJ45 端口 - 支持 DPWS 的 DHCP 客户端 IPv4、IPv6 端口
- RS-485 Modbus 端口
- Ethernet 2 IEEE802.3af (802.3at 类型1)

输入特性

- 数字量输入: 类型 1

电源

- PAS600L: 24 V_{DC} (±10 %)
- PAS600P: 以太网供电型设备
- PAS600: 110–277 V_{AC}/V_{DC} (±10 %)
- 额定频率:
 - PAS600: 50–60 Hz (±5 Hz)
- III 类过电压
- 功率消耗:
 - PAS600L: < 3.5 W (最大)
 - PAS600: < 3.5 W (12 VA) (最大)
 - PAS600P: < 3.5 W (最大)
- PAS600P 的电源输入
 - 以太网供电: 0 类
 - 工作输入电压范围: 37–57 V_{DC}
 - 额定值: < 3.5 W (72 mA) 48 V_{DC} 典型

环境

- 工作温度: -25 °C 至 +70 °C (-13 °F 至 +158 °F)
- 存储温度: -40 °C 至 +85 °C (-40 °F 至 +185 °F)
- 海拔: 2000 米 (6500 英尺)
- 湿度: 55 °C (131 °F) 温度条件下为 5–95% 相对湿度 (无冷凝)
- 污染等级:
 - PAS600L: 3
 - PAS600P: 2
 - PAS600: 2

机械特性

- 连接器: IP20
- 其他表面: IP30
- 正面鼻端: IP40

Radio Frequency Compliance Statements / Déclarations de conformité concernant les radiofréquences / Declaraciones de conformidad de radiofrecuencia / Konformitätserklärungen für Funkanlagen / Dichiarazioni sulla conformità alla radiofrequenza / Declarações de conformidade com rádio frequência / Заявление о соответствии требованиям по радиочастотам / 射频合规声明

Europe / Europe / Europa / Europa / Europa / Europa

en EU Declaration of Conformity

Hereby, Schneider Electric Industries SAS, declares that the Panel Server is in compliance with the essential requirements and other relevant provisions of RED Directive 2014/53/EU.

The EU declaration of conformity ECDPS20042001 can be downloaded on www.se.com/docs.

- Operating frequency for Wi-Fi is 2.4 GHz and 5 GHz, for others is 2.4 GHz
- Maximum radio-frequency power transmitted:
 - Wi-Fi: ≤ 100 mW
 - IEEE 802.15.4: ≤ 10 mW

fr Déclaration de conformité UE

Par le présent document, Schneider Electric Industries SAS déclare que le Panel Server est conforme aux exigences essentielles et aux autres dispositions pertinentes de la directive RED 2014/53/UE.

La déclaration de conformité européenne ECDPS20042001 est disponible en téléchargement sur le site www.se.com/docs.

- Fréquence pour le Wi-Fi : 2,4 GHz et 5 GHz; 2,4 GHz pour les autres réseaux
- Puissance maximum d'émission de radiofréquences:
 - Wi-Fi: ≤ 100 mW
 - IEEE 802.15.4: ≤ 10 mW

es Declaración conforme a la UE

Por la presente, Schneider Electric Industries SAS declara que el Panel Server cumple los requisitos esenciales y otras disposiciones pertinentes de la Directiva RED 2014/53/UE sobre la comercialización de equipos radioeléctricos.

La declaración UE de conformidad ECDPS20042001 se puede descargar de www.se.com/docs.

- La frecuencia de funcionamiento para Wi-Fi es de 2,4 GHz y 5 GHz, para el resto es de 2,4 GHz
- Potencia máxima de radiofrecuencia transmitida:
 - Wi-Fi: ≤ 100 mW
 - IEEE 802.15.4: ≤ 10 mW

de EU-Konformitätserklärung

Schneider Electric Industries SAS erklärt hiermit, dass der Panel Server den grundlegenden Anforderungen und anderen relevanten Bestimmungen der RED-Richtlinie 2014/53/EU für Funkanlagen entspricht.

Die EU-Konformitätserklärung ECDPS20042001 kann von folgender Website heruntergeladen werden: www.se.com/docs.

- Betriebsfrequenz für Wi-Fi = 2,4 GHz und 5 GHz, für andere = 2,4 GHz
- Max. übertragene Hochfrequenzleistung:
 - Wi-Fi: ≤ 100 mW
 - IEEE 802.15.4: ≤ 10 mW

it Dichiarazione di conformità UE

Di seguito, Schneider Electric Industries SAS, dichiara che il Panel Server è conforme con i requisiti essenziali e altre disposizioni relative della Direttiva RED 2014/53/EU.

La dichiarazione di conformità EU ECDPS20042001 può essere scaricata da www.se.com/docs.

- La frequenza operativa per Wi-Fi è 2,4 GHz e 5 GHz, per altri è 2,4 GHz
- Potenza radiofrequenza massima trasmessa:
 - Wi-Fi: ≤ 100 mW
 - IEEE 802.15.4: ≤ 10 mW

pt Declaração de conformidade da UE

Por meio deste, a Schneider Electric Industries SAS declara que o Panel Server está em conformidade com os requisitos essenciais e outras determinações relevantes da Diretiva RED 2014/53/EU.

A declaração UE de conformidade ECDPS20042001 pode ser baixada em www.se.com/docs.

- A frequência de funcionamento de Wi-Fi é de 2,4 GHz e de 5 GHz, para outros é de 2,4 GHz
- Potência de radiofrequência máxima transmitida:
 - Wi-Fi: ≤ 100 mW
 - IEEE 802.15.4: ≤ 10 mW

United Kingdom

UK Declaration of Conformity

Hereby, Schneider Electric Industries SAS, declares that the Panel Server is in compliance with the essential requirements and other relevant provisions of RED Directive UK SI 2017 No. 1206.

The UK declaration of conformity UK_PS20042001 can be downloaded on www.se.com/docs.

- Operating frequency for Wi-Fi is 2.4 GHz and 5 GHz, for others is 2.4 GHz
- Maximum radio-frequency power transmitted:
 - Wi-Fi: ≤ 100 mW
 - IEEE 802.15.4: ≤ 10 mW

USA

Federal Communication Commission Interference Statement:

This device complies with Part 15 of the FCC Rules. Operation is subject to the following two conditions:

- This device may not cause harmful interference, and
- This device must accept any interference received, including interference that may cause undesired operation.

Note: This equipment has been tested and found to comply with the limits for a Class A digital device, pursuant to part 15 of the FCC Rules. These limits are designed to provide reasonable protection against harmful interference when the equipment is operated in a commercial environment. This equipment generates, uses, and can radiate radiofrequency energy and, if not installed and used in accordance with the instruction manual, may cause harmful interference to radio communications. Operation of this equipment in a residential area is likely to cause harmful interference in which case the user will be required to correct the interference at his own expense.

FCC Caution:

Any changes or modifications not expressly approved by the party responsible for compliance could void the user's authority to operate this equipment.

This transmitter must not be co-located or operating in conjunction with any other antenna or transmitter.

Operations in the 5.15-5.25 GHz band are restricted to indoor usage only.

Radiation Exposure Statement:

This equipment complies with FCC radiation exposure limits set forth for an uncontrolled environment.

This equipment should be installed and operated with minimum distance 20 cm between the radiator and your body.

Note: The country code selection is for non-US model only and is not available to all US model. Per FCC regulation, all Wi-Fi product marketed in US must be fixed to US operation channels only.

Radio Frequency Compliance Statements / Déclarations de conformité concernant les radiofréquences / Declaraciones de conformidad de radiofrecuencia / Konformitätserklärungen für Funkanlagen / Dichiarazioni sulla conformità alla radiofrequenza / Declarações de conformidade com rádio frequência / Заявление о соответствии требованиям по радиочастотам / 射频合规声明

Canada

Industry Canada Statement:

This device complies with ISED's licence-exempt RSSs. Operation is subject to the following two conditions:

- This device may not cause harmful interference, and
- This device must accept any interference received, including interference that may cause undesired operation.

Le présent appareil est conforme aux CNR d'ISED applicables aux appareils radio exempts de licence. L'exploitation est autorisée aux deux conditions suivantes:

- le dispositif ne doit pas produire de brouillage préjudiciable, et
- ce dispositif doit accepter tout brouillage reçu, y compris un brouillage susceptible de provoquer un fonctionnement indésirable.

Caution:

- The device for operation in the band 5150-5250 MHz is only for indoor use to reduce the potential for harmful interference to co-channel mobile satellite systems;
- For devices with detachable antenna(s), the maximum antenna gain permitted for devices in the band 5725-5850 MHz shall be such that the equipment still complies with the e.i.r.p. limits as appropriate; (detachable antenna only)
- Where applicable, antenna type(s), antenna models(s), and worst-case tilt angle(s) necessary to remain compliant with the e.i.r.p. elevation mask requirement set forth in section 6.2.2.3 shall be clearly indicated.

Avertissement:

- les dispositifs fonctionnant dans la bande 5150-5250 MHz sont réservés uniquement pour une utilisation à l'intérieur afin de réduire les risques de brouillage préjudiciable aux systèmes de satellites mobiles utilisant les mêmes canaux;
- pour les dispositifs munis d'antennes amovibles, le gain maximal d'antenne permis (pour les dispositifs utilisant la bande de 5 725 à 5 850 MHz) doit être conforme à la limite de la p.i.r.e. spécifiée, selon le cas; (detachable antenna only)
- lorsqu'il y a lieu, les types d'antennes (s'il y en a plusieurs), les numéros de modèle de l'antenne et les pires angles d'inclinaison nécessaires pour rester conforme à l'exigence de la p.i.r.e. applicable au masque d'élévation, énoncée à la section 6.2.2.3, doivent être clairement indiqués.

Detachable Antenna Usage:

This radio transmitter [IC: 21522- UPSA] has been approved by Innovation, Science and Economic Development Canada to operate with the antenna types listed below, with the maximum permissible gain indicated. Antenna types not included in this list that have a gain greater than the maximum gain indicated for any type listed are strictly prohibited for use with this device.

Le présent émetteur radio [IC: 21522- UPSA] a été approuvé par Innovation, Sciences et Développement économique Canada pour fonctionner avec les types d'antenne énumérés ci-dessous et ayant un gain admissible maximal. Les types d'antenne non inclus dans cette liste, et dont le gain est supérieur au gain maximal indiqué pour tout type figurant sur la liste, sont strictement interdits pour l'exploitation de l'émetteur.

Brand	Model	Antenna Type	Max Gain (dBi)		Impedance (Ω)
			2.4G	5G	
Schneider Electric	PASA-ANT1	Dipole antenna	2.54 dBi	3.88 dBi	50 Ω

Radiation Exposure Statement:

This equipment complies with ISED radiation exposure limits set forth for an uncontrolled environment. This equipment should be installed and operated with greater than 20 cm between the radiator and your body.

Déclaration d'exposition aux radiations:

Cet équipement est conforme aux limites d'exposition aux rayonnements ISED établies pour un environnement non contrôlé. Cet équipement doit être installé et utilisé à plus de 20 cm entre le radiateur et votre corps.

产品中有毒有害物质或元素的名称及含量
Contents of Toxic or Hazardous Substances or Elements

部件名称 Part Name	有毒有害物质或元素 Toxic or hazardous Substances and Elements																	
	PAS600L						PAS600						PAS600P					
	铅 (Pb)	汞 (Hg)	镉 (Cd)	六价铬 (Cr ⁶⁺)	多溴联苯 (PBB)	多溴二苯醚 (PBDE)	铅 (Pb)	汞 (Hg)	镉 (Cd)	六价铬 (Cr ⁶⁺)	多溴联苯 (PBB)	多溴二苯醚 (PBDE)	铅 (Pb)	汞 (Hg)	镉 (Cd)	六价铬 (Cr ⁶⁺)	多溴联苯 (PBB)	多溴二苯醚 (PBDE)
金属部件 Metal Parts	X	○	○	○	○	○	X	○	○	○	○	○	X	○	○	○	○	○
电子部件 Electronic Parts	X	○	○	○	○	○	X	○	○	○	○	○	X	○	○	○	○	○
塑料部件 Plastic Parts	○	○	○	○	○	○	○	○	○	○	○	○	○	○	○	○	○	○
触点 Contacts	○	○	○	○	○	○	○	○	○	○	○	○	○	○	○	○	○	○
电缆和布线附件 Cables and cabling accessories	○	○	○	○	○	○	○	○	○	○	○	○	○	○	○	○	○	○

○ : 表示该有毒有害物质在该部件所有均质材料中的含量均在 SJ/T11363-2006 标准规定的限量要求以下。

Indicates that this toxic or hazardous substance contained in all of the homogeneous materials for this part is below the limit requirement in SJ/T11363-2006.

X : 表示该有毒有害物质至少在该部件的某一均质材料中的含量超出 SJ/T11363-2006 标准规定的限量要求。

Indicates that this toxic or hazardous substance contained in at least one of the homogeneous materials used for this part is above the limit requirement in SJ/T11363-2006.

对销售之日的所售产品,本表显示,施耐德电气供应链的电子信息产品可能包含这些物质。注意:在所售产品中可能会也可能不会含有所有所列的部件。

Note: The products on sale may or may not contain all the parts/components listed here.

