



Industrial Automation systems

# EcoStruxure™ Automation Expert

Software-defined Automation

Software version v24.0

# Quick access to product information

## Get technical information about your product

**References**

**Modicon TM3**  
I/O expansion modules for Modicon controllers  
Analog I/O modules

References	Modicon TM3 analog input modules	Number and type of channels	Output range	Resolution	Input terminal block (V)	Reference	Weight (kg)
TM3AI1H	4 voltage/current inputs	-10...+10 VDC 0...+10 VDC 0...20 mA / 0...20 mA	10 000 cr	0.001%	TM3AI1H	0.150	
			10 000 cr	0.002%	TM3AI1H	0.150	
TM3AI2H	4 voltage/current inputs	-10...+10 VDC 0...+10 VDC 0...20 mA / 0...20 mA	12 000 cr	0.001%	TM3AI2H	0.200	
			11 000 cr	0.002%	TM3AI2H	0.200	
TM3AI3H	4 voltage/current inputs	Thermocouples (J, K, R, S, E, T, N, E, C) Semiconductor probes (PT100, PT500, NI100, NI200, NI300) 0...+10 VDC 0...20 mA / 0...20 mA	10 000 cr	0.001%	TM3AI3H	0.150	
			10 000 cr	0.002%	TM3AI3H	0.150	
TM3DI1H	4 differential temperature inputs	Thermocouples (J, K, R, S, E, T, N, E, C) RTD (Pt100, Pt500, NI100, NI200, NI300) 0...+10 VDC 0...20 mA / 0...20 mA	10 000 cr	0.001%	TM3DI1H	0.150	
			10 000 cr	0.002%	TM3DI1H	0.150	
TM3DI2H	4 differential temperature inputs	Thermocouples (J, K, R, S, E, T, N, E, C) RTD (Pt100, Pt500, NI100, NI200, NI300) 0...+10 VDC 0...20 mA / 0...20 mA	10 000 cr	0.001%	TM3DI2H	0.200	
			10 000 cr	0.002%	TM3DI2H	0.200	

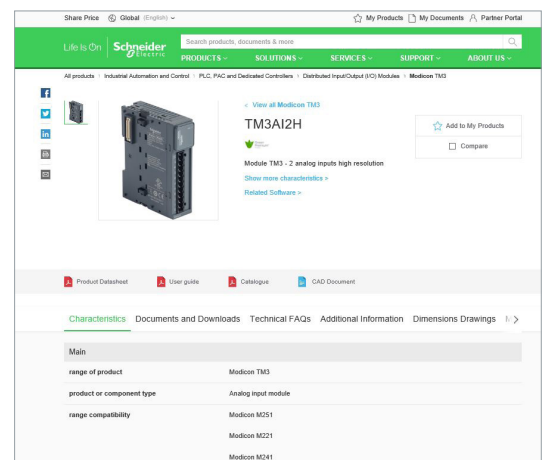

Each commercial reference presented in a catalog contains a hyperlink. Click on it to obtain the technical information of the product:

- Characteristics, Dimensions and drawings, Mounting and clearance, Connections and schemas, Performance curves
- Product image, Instruction sheet, User guide, Product certifications, End of life manual

## Find your catalog

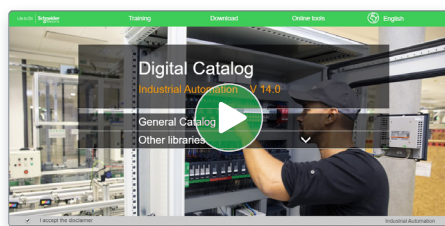

- > With just 3 clicks, you can access the Industrial Automation and Control catalogs, in both English and French
- > Consult digital automation catalogs at [Digi-Cat Online](#)

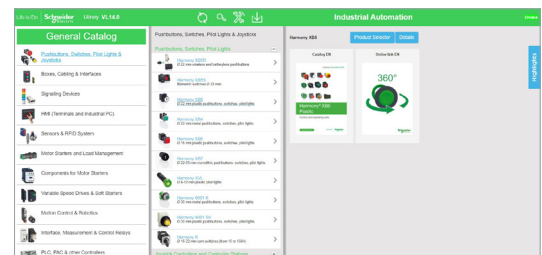

- Up-to-date catalogs
- Embedded product selectors, 360° pictures
- Optimized search by commercial references

## Select your training



- > Find the right [Training](#) for your needs on our Global website
- > Locate the training center with the selector tool, using this [link](#)

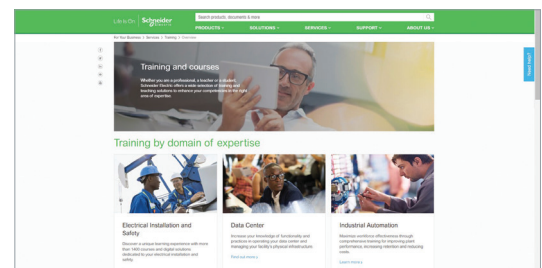

Life Is On

Schneider Electric

# General contents

## EcoStruxure™ Automation Expert

### ■ General presentation

- EcoStruxure Automation Expert..... [page 2](#)
- Feature overview ..... [page 3](#)

### ■ Presentation

- Software
  - EcoStruxure Automation Expert engineering ..... [page 4](#)
  - EcoStruxure Automation Expert - HMI ..... [page 5](#)
  - EcoStruxure Automation Expert - Archive ..... [page 5](#)
  - EcoStruxure Automation Expert - AVEVA System Platform integration..... [page 5](#)
  - EcoStruxure Automation Expert - Libraries ..... [page 5](#)
  - System requirements..... [page 9](#)
- Hardware
  - Software dPAC ..... [page 10](#)
  - Edge Controller..... [page 11](#)
  - Altivar and Modicon dPAC ..... [page 11](#)
  - Selection Guide ..... [page 14](#)
  - Architecture ..... [page 17](#)
- Licenses
  - EcoStruxure Automation Expert – Perpetual licensing ..... [page 20](#)
  - EcoStruxure Automation Expert – Subscription-based licensing ..... [page 21](#)
  - EcoStruxure Automation Expert Licensing – Architecture ..... [page 21](#)

### ■ Compatibility

- List of X80 hardware compatible with Modicon M580 dPAC ..... [page 28](#)
- List of TM3 hardware compatible with ModiconM251 dPAC and M262 dPAC..... [page 30](#)
- Altivar hardware and Altivar ATV dPAC compatibility ..... [page 31](#)

### ■ References

- Modicon M580 dPAC ..... [page 32](#)
- Modicon M251 dPAC ..... [page 36](#)
- Modicon M262 dPAC ..... [page 37](#)
- Altivar ATV dPAC ..... [page 38](#)

### ■ Services..... [page 40](#)

### ■ Product reference index..... [page 42](#)

### EcoStruxure™ Automation Expert

EcoStruxure Automation Expert is a software-defined industrial automation system, a new category of industrial automation that leverages innovative technology to enable industrial operators to realize a step-change improvement over traditional process control systems and deliver significant advancement in productivity, quality, flexibility, and security throughout the entire lifecycle of industrial assets.

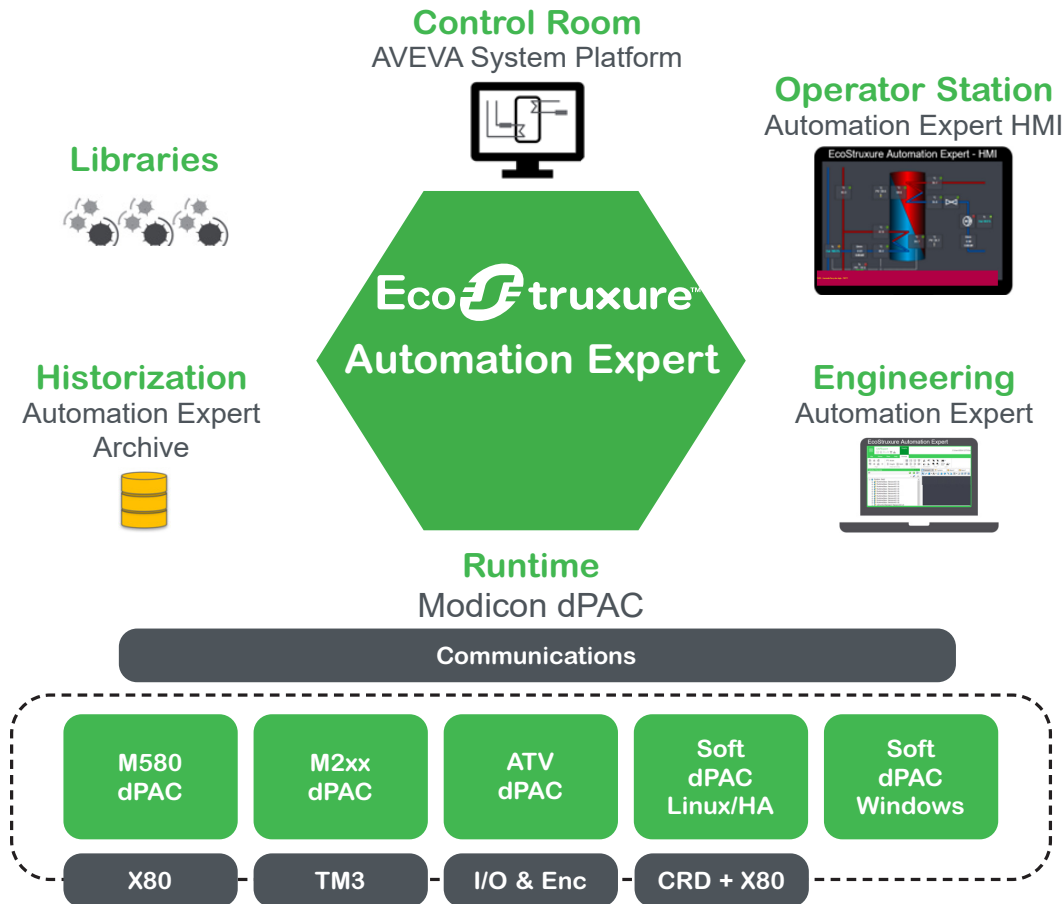

EcoStruxure Automation Expert consists of a suite of integrated hardware and software solutions:

- > EcoStruxure Automation Expert build time - engineering, monitoring, and management environment
- > Distributed Programmable Automation Controller (dPAC) platforms with the UniversalAutomation.org Shared Source Runtime engine:
  - ATV dPAC for Altivar
  - Modicon M251 dPAC/TM3 I/O
  - Modicon M262 dPAC/TM3 I/O
  - Modicon M580 dPAC/X80 I/O
- > Plus, innovative new software-based controllers:
  - Soft dPAC for Linux™, for standalone and high availability configurations
  - Soft dPAC for Windows™, for standalone configurations
- > EcoStruxure Automation Expert - HMI, a fully integrated, object-oriented industrial visualization solution
- > EcoStruxure Automation Expert - Archive, a centralized solution for the historization of process data, alarms, and trends
- > Schneider Electric Libraries, a comprehensive set of hardware-independent libraries, ranging from basic functions up to segment solutions
- > Asset Link for Bulk Engineering to extract data from engineering tools for automated application generation
- > Asset Link for AVEVA OMI to create application objects (AppObjects) in the AVEVA System Platform in an automated workflow

*Note: UniversalAutomation.org is an independent, non-for-profit association managing the implementation of an industrial automation shared source runtime execution engine, based on the IEC 61499 standard that is an object-oriented further development of IEC 61131 with the cyclical execution model of IEC 61131 replaced by an event-based model. This new level of shared technology provides the basis for an ecosystem of portable, interoperable, "plug and produce" solutions and creates an entirely new category within industrial automation.*



### Feature overview

EcoStruxure Automation Expert represents a new approach to designing, building, operating, and maintaining industrial automation systems that offers a unique technology mix to define a new category of integrated automation systems.



#### Complexity mastered

Systems, devices, services, and assets are natively represented as ready-to-use software objects called composite automation types (CATs) that encapsulate internal behaviour and simplify functional interfaces. An object-oriented approach promotes code reuse, standardization on best practice, and helps manage complexity while providing the fundamental building blocks for the creation of state-of-the-art cyber-physical systems. CAT objects follow a type/instance relation and can be combined to create new objects that encapsulate:

- Control logic
- HMI/SCADA visualization
- I/O and device communications
- Simulation and test rigging
- Documentation



#### Decoupling the application from implementation

EcoStruxure Automation Expert addresses full automation system engineering and extends the best features of classic PLC and DCS control approaches to a new generation of automation system that completely decouples the application design from runtime deployment, enabling automation professionals to focus on these tasks independently in their project lifecycle. Applications are portable, reusable, and interoperable across runtime platforms, meaning deployment decisions are made just in time and on the fly, enabling exceptional system agility.



#### Efficient engineering

EcoStruxure Automation Expert build time provides a single, modular engineering environment for all tasks for engineering, monitoring, and managing the complete automation system including hardware and software, control, and visualization. It automates low value engineering and integration tasks, reducing engineering effort and sources of error by Asset Link to perform digital engineering. Complex functions can be encapsulated into manageable objects, enabling non-technical users to understand and manage complex systems. Cross communications are transparent and implicit regardless of physical location, requiring zero engineering consideration.



#### Common runtime environment

Through the implementation of the shared source Runtime engine provided by universalautomation.org across hardware and software platforms, exceptional re-usability, scalability, and architectural flexibility are now available. Application portability provides cost savings through the decoupling of the lifecycles of software and hardware systems.

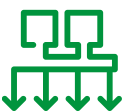

#### Simple system orchestration

EcoStruxure Automation Expert was designed with the complete lifecycle of an automation system in mind, with functions to facilitate management and monitoring of multiple assets and devices at scale. With a single user environment covering the entire system scope including third-party devices, orchestration of complex, heterogeneous systems becomes simpler.

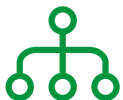

#### Native IT integration

Modern automation systems generate increased value when coupled with business information and hence wider IT ecosystems. EcoStruxure Automation Expert provides an expandable platform for Industry 4.0 solutions with support for high-level programming, modular systems design, and open standards. Thanks to event-driven execution and object-oriented design, EcoStruxure Automation Expert applies to IT programming language standards.



#### Cybersecurity

EcoStruxure Automation Expert includes robust support for cybersecurity including credential management and secure communications. User and device credentials are managed by the EcoStruxure Automation Expert build time environment, and secure communications are available between controllers, HMI, SCADA, and third-party devices.

### EcoStruxure Automation Expert Software

The EcoStruxure Automation Expert software offer includes:

- The EcoStruxure Automation Expert engineering environment, with add-ons for integration of AVEVA Engineering and AVEVA System Platform software
- EcoStruxure Automation Expert HMI Runtime
- EcoStruxure Automation Expert Archive
- Asset-oriented application libraries

### EcoStruxure Automation Expert engineering

EcoStruxure Automation Expert is an asset-based, fully-integrated engineering environment that allows portable, IEC 61499-standard-based automation systems to be managed within a single environment. EcoStruxure Automation Expert provides the capability to:

- Design and manage asset-based applications using object libraries based on multifaceted models (asset logic, operating modes, HMI symbols and faceplates (including alarms and trends), I/O interface, and asset documentation)
- Design the process based on asset-oriented objects with single line connections
- Create rich process displays to monitor and control the process from the control room or line terminal by dragging and dropping asset-based objects
- Manage a single solution independently of the number of controllers and HMI stations
- Design the application solution independently of the hardware configuration
- Test and simulate the control and HMI for the whole solution
- Create and modify procedural automation CATs based on S88 state model with graphical editor
- Support multi-user change management through SVN client integration
- Design, configure, and manage network and device topologies
- Flexibly deploy applications to multiple hardware or software platforms based on a common runtime
- Automatically discover and diagnose compatible runtime devices
- Automate bulk generation of asset instances from AVEVA Engineering or DEXPI files
- Automate bulk generation of asset instances for AVEVA System Platform
- Embedded AVEVA industrial graphic editor in EcoStruxure Automation Expert build time to create new AVEVA industrial graphics or to reuse graphics from existing applications
- Secure the automation system by managing authentication with encrypted communication and security certificates at solution and devices level

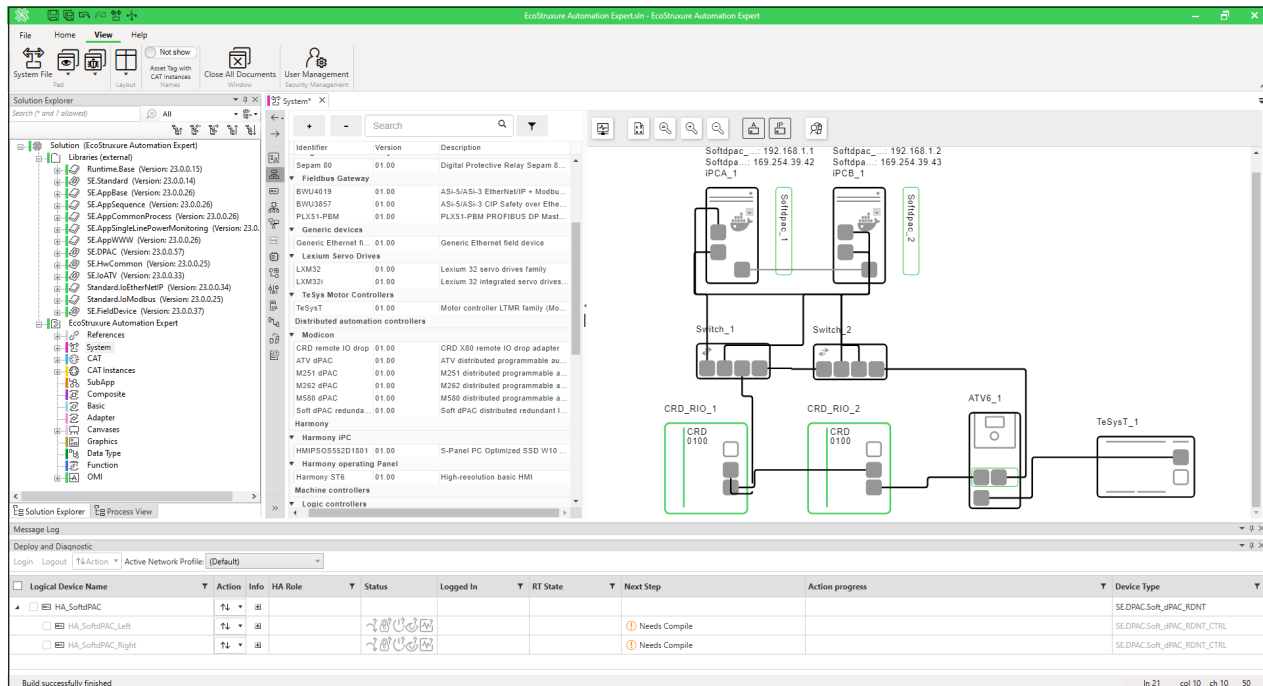

EcoStruxure Automation Expert V24.0 build time

### EcoStruxure Automation Expert Software

#### EcoStruxure Automation Expert – HMI

EcoStruxure Automation Expert HMI is a tightly integrated human-machine interface designed for EcoStruxure Automation Expert applications. Its features include:

- Compatibility with Windows™ OS/Linux™ OS hardware or Schneider Electric Harmony ST6
- Seamless management of controller and HMI communication
- Support for single/multi operator stations with cloning
- User management for access control
- Multi-language application
- Monitoring of runtime connections

The EcoStruxure Automation Expert HMI Client for Window™/Linux™ operating system can be installed on various hardware such as Workstations, Industrial PCs, and Edge Boxes, provided they meet the minimum system requirements. It ensures high-performance, seamless management of controller and HMI communication.

Furthermore, the EcoStruxure Automation Expert HMI Client for Harmony ST6 is compatible with HMIST6200, HMIST6400, HMIST6500, HMIST6600, HMIST6700, HMISTM6400, and HMISTM6200 touch panel screens. It offers seamless management of controller and automatic HMI communication, particularly ideal for a small number of assets.

#### EcoStruxure Automation Expert – Archive

EcoStruxure Automation Expert Archive operates as a highly integrated local data historian, providing minimal engineering effort historization and retrieval of live process data, alarms, and events within Automation Expert HMI and the capability to integrate with larger enterprise data storage systems by Structured Query Language (SQL). It is compatible with Windows 10, Windows 11, and Linux operating system.

#### EcoStruxure Automation Expert – AVEVA System Platform integration

EcoStruxure Automation Expert includes native support for System Platform - AVEVA's real-time operations control platform for supervisory, HMI, SCADA, and IIoT applications. EcoStruxure Automation Expert is capable of auto-generating OPC UA-based secure communications between platforms and generate AVEVA System Platform-compatible graphics for clean integration. Furthermore, it now embeds the AVEVA Industrial Graphics editor so that users no longer need to move from EcoStruxure Automation Expert buildtime to AVEVA buildtime, providing unprecedented integration.

Automation Expert version	Library compatible version	Platform version for Asset Link	Version for Asset Link and AVEVA Industrial Graphics
V23.0	AVEVA System Platform 2020 R2 SP1	AVEVA System Platform 2020 R2 SP1 or later	No AVEVA Industrial Graphics support
V23.1	AVEVA System Platform 2023	AVEVA System Platform 2020 R2 SP1 or later (New Galaxy creation is possible only with Library compatible version)*	AVEVA System Platform 2023 or later
V24.0	AVEVA System Platform 2023 or R2 SP1	AVEVA System Platform 2020 R2 SP1 or later (New Galaxy creation is possible only with AVEVA System Platform 2023 R2 SP1)*	AVEVA System Platform 2023 or later (New Galaxy creation is possible only with AVEVA System Platform 2023 R2 SP1)*

\*Only Select Existing Galaxy from the configurator is possible if Library compatible version is not available with the user.

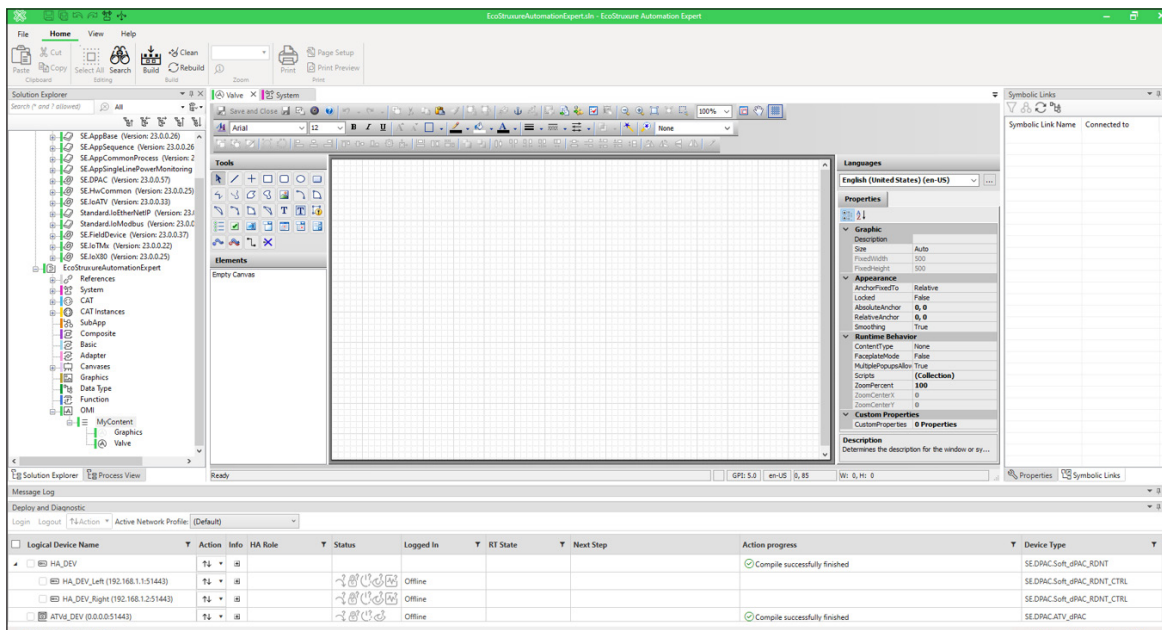

Embedded AVEVA industrial graphic editor in EcoStruxure Automation Expert build time

### EcoStruxure Automation Expert Software (continued)

#### EcoStruxure Automation Expert – Libraries

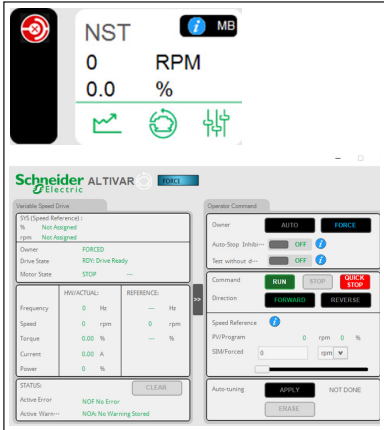

Example of HWCAT symbol and faceplate on EcoStruxure Automation Expert HMI

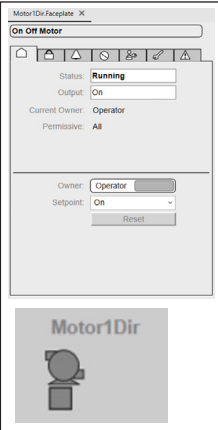

Example of Application CAT symbol and faceplate on AVEVA OMI

EcoStruxure Automation Expert includes a set of application libraries with generic process and control modules such as motors / valves and segment-based libraries with equipment modules that include multiple facets – logic, Automation Expert HMI, AVEVA System Platform template, and documentation within a single package to minimize the engineering time.

EcoStruxure Automation Expert also includes a hardware library for easier integration of the most common Schneider Electric and Technical Partner’s field devices through Modbus TCP / Ethernet IP that provides the mapping, HMI, and documentation to be used in the application. With version 24.0 release, the free libraries included are:

- Field Device
- Base and common process
- Sequence management and Phase Management
- Liquid food
- Water & Wastewater (including desalination)
- Single line power monitoring
- Conveying

These libraries include HMI objects that are compatible with Windows and Linux Ubuntu native HMI runtime, including the Harmony HMIST6xxx and HMISTM6xxx panels.

Additionally, Universal Automation vendors provide specific hardware libraries to deploy EcoStruxure Automation Expert applications to their offer.

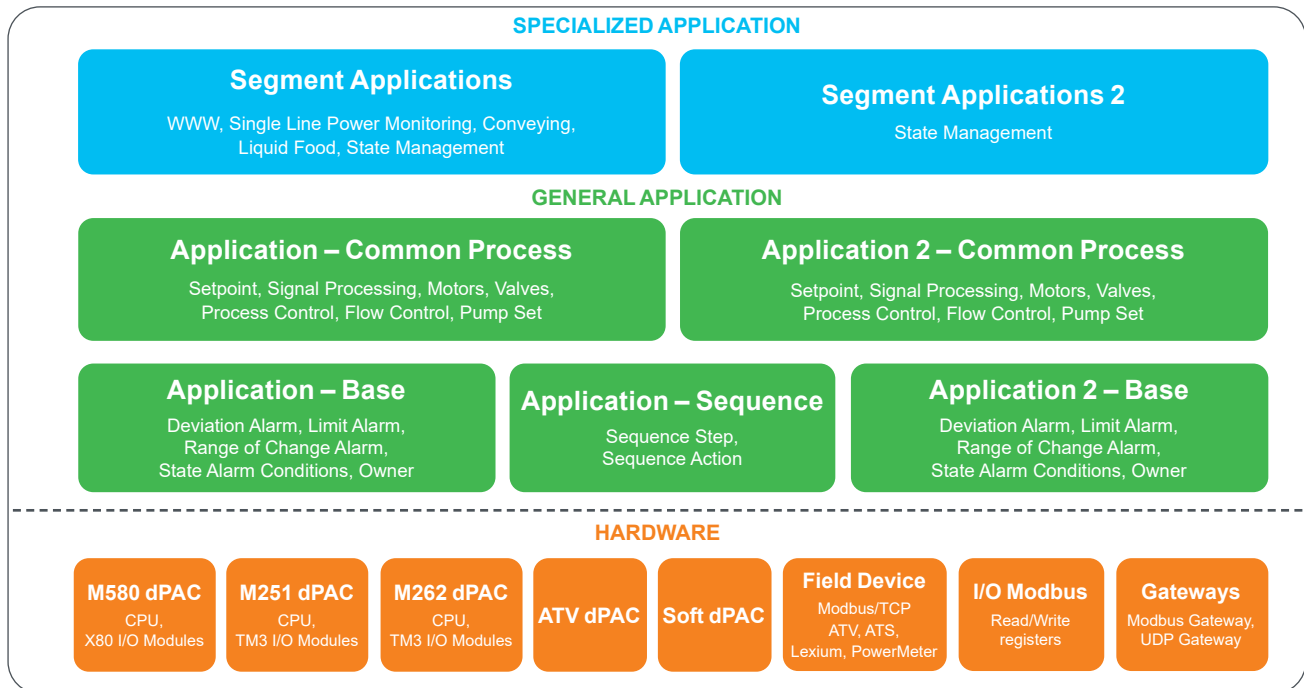

With this release the library updates include:

- Elementary blocks with easier customization covering basic application functions like alarms, conditions, owners, and signal conditioning that are used by other application CATs – SE.App2Base.
- Library of application CATs with easier customization to address common process assets or functions like digital I/O, analog I/O, motors, valves, and flowcontrol. There are multiple layers of each object available which can be used and customized for various application purposes – SE.App2CommonProcess.
- State management functionality for generic application (State Manager) as well as ISA-88 based application (Phase Manager). Phase Manager also includes a phase logical interface that accepts commands from external batching interfaces such as AVEVA Batch Management and returns the phase manager status – SE.App2StateManagement.

### EcoStruxure Automation Expert Software (continued)

#### EcoStruxure Automation Expert – Libraries (continued)

#### EcoStruxure Automation Expert libraries

Library name	Short description	Extended description
Runtime.Base	Standard blocks	This library contains the basic function blocks to be used for: <ul style="list-style-type: none"> <li>■ Runtime management</li> <li>■ Arithmetic functions</li> <li>■ Logic functions</li> <li>■ Format conversion</li> <li>■ Event management</li> <li>■ etc.</li> </ul>
SE.AppBase	Elementary block of the application	Library of application CATs covering basic application functions like alarms, conditions, owners, and signal conditioning that are used by other application CATs like the ones from SE.AppCommonProcess
SE.App2Base	Elementary blocks of the application	SE.AppBase objects are redesigned to make customization easier. These objects will be used by other redesigned libraries.
SE.AppSequence	Sequence control	This library has a set of application CATs that allows you to create sequential control algorithms with steps and transitions to command control modules. This library works with both SE.AppCommonProcess and SE.App2CommonProcess.
SE.AppCommonProcess	Common process applications	Library of application CATs to address common process assets or functions like digital I/O, analog I/O, motors, valves, flow control, etc. These types of object can be used in any industrial application as well as in process control in manufacturing applications
SE.App2CommonProcess	Common process application	SE.AppCommonProcess objects are redesigned to make customization easier. There are multiple layers of each object available, which can be used and customized for various application purposes.
SE.AppConveying	Conveying	Library of application CATs to address common equipment such as conveyors, sorters, transfer tables, and turntables, typically used in logistic hubs and distribution centers
SE.AppLiquidFood	Liquid and Food	This library has an application CAT to control the seats of mixproof valves used in Liquid and Food applications
SE.SingleLinePowerMonitoring	Low and medium power monitoring	This library includes templates with common functions for electrical objects such as busbars, sources, infeeds, and loads that can be connected to energy management hardware CATs
SE.AppStateManagement	State management	This library is used to monitor and manage interface states of the machine: <ul style="list-style-type: none"> <li>■ receiving control commands and providing machine information</li> <li>■ managing acting state sequence and transitions</li> </ul>
SE.App2StateManagement	State management	This library is used to provide state management functionality for generic application (State Manager) as well as ISA-88 based application (Phase Manager). Phase Manager also includes a phase logical interface that accepts commands from external batching interfaces such as AVEVA Batch Management and returns the Phase Manager status.
SE.AppProcedure	Procedure control	This library is used to monitor and manage phases based on ISA-88 associated with sequences in coordination with sequence control blocks from <b>SE.AppSequence</b> . It also includes a phase logical interface that accepts commands from external batching interfaces such as AVEVA Batch Management and returns the phase manager status.
SE.AppWWW	Waste and wastewater	This library contains blocks used to monitor and manage control sequences like aeration and dual media filter for Water and Wastewater applications
SE.DPAC	dPAC hardware controllers	Library containing the dPAC device types
AVEVA.IndustrialGraphicsLibrary	Industrial graphics library	Industrial Graphics are vector-based graphics that can be scaled, animated, embedded into application objects, and deployed. The library contains common industrial equipment. You can modify graphics or add graphics to the library by creating new graphics using the Industrial Graphic Editor.
SE.EAEPortal	AVEVA System Platform Device type	The AVEVA System Platform device type is required by Asset Link for establishing communication and creating the application objects automatically in AVEVA System Platform
SE.FieldDevice	Field device hardware CATs	This library has ready-to-use hardware CATs for motor control, energy management, machine safety, and weighing from Schneider Electric, allowing dPAC communication with these devices by Modbus TCP or Ethernet IP depending on the device
SE.HwCommon	Common hardware CAT functions	Library of functions used by the various hardware CAT libraries
SE.IoATV	Variable speed drive I/O services for ATV dPAC	Library of hardware CATs for Altivar I/O (local and modules) used for the Altivar dPAC module hardware configuration

### EcoStruxure Automation Expert Software (continued)

#### EcoStruxure Automation Expert – Libraries (continued)

#### EcoStruxure Automation Expert libraries (continued)

Library name	Short description	Extended description
<b>SE.IoNet</b>	UDP gateway	Library of hardware CATs to enable UDP communication
<b>SE.IoTMx</b>	TM I/O services for M251d/M262d	Library of hardware CATs for TMp I/O modules used for M251d and M262d hardware configuration
<b>SE.IoX80</b>	X80 I/O services for M580d	Library of hardware CATs for X80 I/O modules used for M580d hardware configuration
<b>SE.ModbusGateway</b>	Standard Modbus gateway	Library of hardware CATs to enable Modbus TCP communication with import of data description file
<b>SE.Standard</b>	EcoStruxure Automation Expert HMI device type	Library with EcoStruxure Automation Expert HMI device type
<b>Standard.IoEtherNetIP</b>	Standard Ethernet IP scanner functions	Library of hardware CATs used for EIP scanner configuration (Implicit use by the EcoStruxure Automation Expert system when using the EIP scanner and also to add custom EIP connections)
<b>Standard.IoModbus</b>	Standard Modbus functions	Library of hardware CATs to enable Modbus client communication
<b>Standard.IoModbusSlave</b>	Standard Modbus server functions	Library of hardware CATs to enable Modbus server communication
<b>Standard.OPCUAClient</b>	Standard OPC UA client functions	Functions to enable OPC UA client connection, monitor, read, and write data

#### Definitions:

- CAT object: A composite automation type (CAT) function block includes objects with multiple facets:
  - Logic to define its operating modes
  - I/O interfaces to exchange data/events with its environment
  - Symbols/faceplates for control and monitoring in the HMI
  - Documentation that is implicitly part of the project online help
- Application CAT: representing application assets or functions
- Hardware CAT: representing hardware devices that can be added to the hardware configuration, for device monitoring and control



### EcoStruxure Automation Expert Software (continued)

#### System requirements

#### Windows – Engineering, HMI, and Archive

System requirements	Minimum			Performance		
	Engineering	HMI	Archive	Engineering	HMI	Archive
Processor	1 GHz			2 GHz or higher		
RAM <sup>(1)</sup>	2 GB	2 GB	2 GB	4 GB	4 GB	4 GB
Hard disk free space <sup>(1)</sup>	1 GB	1 GB	1 GB	10 GB	10 GB	10 GB
Display resolution	1280x1024			1920x1080 or higher		
Pointing device	Mouse or compatible					
Network access	One Ethernet interface					
Operating system	Microsoft Windows 10 Professional (64-bit) Version 1903 and later, Microsoft Windows 11 Professional Version 21H2 and later, and Microsoft Server Version 2019 (1809 and later)					
.NET framework	.NET 4.8			.NET 4.8 or higher		

<sup>(1)</sup> Requirement is indicated for each software package. More than one software package can be installed on the same device. In this case, you need to add the respective RAM and hard disk free space requirements together. For example, if you install the HMI and Archive software packages on the same device, the minimum RAM required is 4 GB (2 GB + 2 GB).

**EcoStruxure Automation Expert Distributed Programmable Automation Controller (dPAC) Platforms**

EcoStruxure Automation Expert consists of several hardware components working together to create a complete automation system.

**Soft dPAC**

Soft dPAC is an edge computing controller designed to execute an application and interact with field devices. This hardware-agnostic controller is versatile, capable of installation on various hardware such as servers, workstations, industrial PCs, or microcomputers, provided they meet the necessary hardware and software requirements.

Soft dPAC supports both Linux™ and Windows™ operating systems:

- The Linux SoftdPAC is ideal for real-time control when installed in conjunction with a Linux real-time patch.
- The Windows SoftdPAC is best suited for non-critical applications that do not demand real-time control.

In a Linux environment, multiple instances of Soft dPAC can be seamlessly installed on a single host machine, allowing tasks like line expansions to be completed without disrupting ongoing processes. This capability minimizes downtime, thereby enhancing productivity and profitability.

For Windows, one Soft dPAC instance can be installed per host machine.

**High Availability Soft dPAC**

High Availability Soft dPAC (HA Soft dPAC) represents a software-based high availability industrial automation system meticulously engineered to operate in a redundant configuration, offering resilience against hardware failures and ensuring continuous operations. This capability effectively minimizes process downtime, making it ideal for demanding applications where uninterrupted process flows are critical.

The integration of the high-availability system with EcoStruxure Automation Expert software plays a pivotal role in enhancing productivity by significantly reducing process downtime.

High Availability Soft dPAC is compatible with the following hardware:

- Schneider Electric Harmony P6 iPC
- ASRock™ iEP-5000G Series Industrial IoT Controller
- For compatibility with other iPC, please contact your Schneider Electric representative for additional information.

Moreover, High Availability Soft dPAC seamlessly integrates with Modicon X80 IOs using the BMECRD0100 Remote I/O module, ensuring comprehensive compatibility and functionality within industrial automation setups.

**Essential Edge Controller**

Essential Edge Controller is part of the Harmony iPC range and runs at the Edge of EcoStruxure. Essential Edge Controller provides customers the flexibility and versatility in products to be used in control and compute applications and helps to enhance the customer's experience by reducing the time to market and improving the cybersecurity of the solution.

Product reference: **HMIBX1A0NDA**

Essential Edge Controller is a versatile and open-to-application edge terminal running Linux Operating software. It is a simple edge device, capable of bringing solid values for and beyond industrial use cases.

- Pre-installed EcoStruxure Automation Expert Soft dPAC, HMI for immediate deployment
- Capability to run third-party applications on the same hardware

The Essential Edge controller has no embedded I/O; it supports Remote I/O on Modicon TM3, X80 expansion modules with up to 32 devices connected via Modbus TCP/IP or Ethernet IP communication.

**Performance Edge Controller**

Performance Edge Controller is part of the Harmony iPC range and runs at the Edge of EcoStruxure. A cutting-edge iPC-based Edge controller with more performance, designed to revolutionize industrial automation. Equipped with pre-installed Soft dPAC, HMI, and Archive, this powerhouse of a controller offers seamless integration and unparalleled flexibility. With the ability to install third-party applications on the same hardware, it empowers you to customize and expand functionality to suit your specific needs.

Performance Edge Controller operates on the robust and secure Linux operating system, helps to provide a stable and efficient platform for industrial automation. Linux OS contributes to maintaining consistent performance, enhanced security, and seamless integration with a wide range of industrial applications.

Product Reference: **HMIP6CTO**

It is a configure-to-order product, where the user can choose the processor type (Celeron / i3), Memory size, and accessories.

The Performance Edge controller has no embedded I/O; it supports Remote I/O on Modicon TM3, X80 expansion modules with up to 200 devices connected via Modbus TCP/IP or Ethernet IP communication.

This innovative Performance Edge controller is an all-in-one solution, streamlining operations and maximizing efficiency.

*NOTE: Please contact your Schneider Electric representative for additional information.*



HMIBX1A0NDA



HMIP6CTO

### EcoStruxure Automation Expert Distributed Programmable Automation Controller (dPAC) Platforms (continued)

#### HA Edge Controller

Designed for high availability applications, this HA Edge controller running on Linux OS helps to maintain a continuous operation, offering a platform for critical industrial processes. Whether in manufacturing, energy management, or process automation, the versatility of our controller combined with Linux OS opens a world of possibilities, improving seamless and efficient operations in demanding industrial environments.

Product Reference: **HMIP6CTO**

It is a configure-to-order product, where the user can choose the processor type (Celeron / i3), Memory size, and accessories.

- Pre-installed EcoStruxure Automation Expert HA soft dPAC for immediate deployment
- Robust performance for diverse industrial applications

The HA Edge controller has no embedded I/O; it supports Remote I/O on Modicon X80 expansion modules with up to 200 devices connected via Modbus TCP/IP communication.

*NOTE: Please contact your Schneider Electric representative for additional information.*



BMED581020

#### Modicon M580 dPAC

A high-performance, rugged distributed field controller based on the widely successful Modicon M580 ePAC platform with up to 64 MB ECC RAM for programs and data. The Modicon M580 dPAC supports the robust, high-performance Modicon X80 I/O catalog<sup>(1)</sup> and is available in standard and conformal coated versions.

Product references:

- **BMED581020: Modicon M580 dPAC (standard)**
- **BMED581020C: Modicon M580 dPAC (conformal coated)**

**BMED581020** and **BMED581020C** controllers support:

- Up to 1,024 discrete I/O channels<sup>(2)</sup>
- Up to 256 analog I/O channels<sup>(2)</sup>
- Up to 4 racks of local I/O



TM251MDESE

#### Modicon M251 dPAC

A cost-optimized, low-footprint distributed controller based on the machine-specialized Modicon M251 Logic Controller platform. The Modicon M251 dPAC provides a single Ethernet port for fieldbus, switched dual Ethernet ports for peer communications, and supports the field-proven TM3 I/O system<sup>(1)</sup>.

Product reference:

- **TM251MDESE: Modicon M251 dPAC**

The **TM251MDESE** controller has no embedded I/O; it supports Modicon TM3 I/O expansion modules:

- Up to 448 discrete I/O channels<sup>(2)</sup>
- Up to 112 analog I/O channels<sup>(2)</sup>
- Up to 14 Modicon TM3 expansion modules (7 local modules + 7 remote modules) with Modicon TM3 bus expansion modules (transmitter module and receiver module)

It is possible to control up to 4 TeSys U and TeSys D motor starters by connecting a **TM3XTYS4** TM3 module to the Modicon M251 dPAC.



TM262L01MDESE8T

#### Modicon M262 dPAC

This is the controller for performance machines. It is powered with a non-isolated 24 V DC power supply, has a built-in overload protection, embeds a dual-core processor and a 256 MB memory capacity and supports RSTP protocol.

Product reference:

- **TM262L01MDESE8T: Modicon M262 dPAC**

The **TM262L01MDESE8T** controller has no embedded I/O; it supports Modicon TM3 I/O expansion modules:

- Up to 448 discrete I/O channels<sup>(2)</sup>
- Up to 112 analog I/O channels<sup>(2)</sup>
- Up to 14 Modicon TM3 expansion modules (7 local modules + 7 remote modules) with Modicon TM3 bus expansion modules (transmitter module and receiver module)

It is possible to control up to 4 TeSys U and TeSys D motor starters by connecting a **TM3XTYS4** TM3 module to the Modicon M262 dPAC.

<sup>(1)</sup> Expert/specialist modules are not supported in this release. Please refer to the compatibility list on [page 28](#).

<sup>(2)</sup> These values are theoretical limits; the device limits are highly dependent on the event load of the user application.



Altivar Process drives slots



VW3A3530D

### EcoStruxure Automation Expert Distributed Programmable Automation Controller (dPAC) Platforms (continued)

#### Altivar ATV dPAC module

The ATV dPAC module is part of the EcoStruxure Automation Expert distributed controller solution platform, with 12 MB memory for programs and data. It is intended to be used as a slide-in option for ATV600, ATV900, and ATV340 variable speed drive (VSD) families<sup>(1)</sup>. The Altivar ATV dPAC module is powered by the drive and provides dual Ethernet sockets for connection to peer controllers, distributed I/O, or remote secondary devices.

Product references:

- **VW3A3530D**: Altivar ATV dPAC module
- **VW3A1111**: Graphic display terminal

The **VW3A3530D** dedicated controller has no embedded I/O. However, all standard I/O on the respective Altivar Process and Altivar Machine drives can be used and extended with I/O modules:

- Up to 23 discrete I/O
- Up to 7 analog I/O
- Encoder interfaces (ATV900 and ATV340)

It is possible to control up to 8 Modbus TCP devices, such as Altivar drives and soft starters, TeSys motor starters, remote I/O using a TM3BCEIP bus coupler, PowerLogic meters, or Harmony Hub wireless sensors.

For more information about the input/output capability, refer to [Altivar dPAC Module VW3A3530D user guide](#).







<sup>(1)</sup> For details, please refer to the compatibility table on [page 31](#).

EcoStruxure Automation Expert Distributed Programmable Automation Controller (dPAC) Platforms (continued)								
Information Technology (IT)/Operational Technology (OT) Communication Protocols								
Platform		Soft dPAC High Availability (Linux)	Simplex Soft dPAC (Linux)	Simplex Soft dPAC (Windows OS)	M580 dPAC	M262 dPAC	M251 dPAC	ATV dPAC
OPCUA	Client	-	✓	-	-	-	-	✓
	Server	✓	✓	✓	✓	✓	✓	✓
MQTT	Pub/Sub	-	✓	✓	-	-	-	-
Modbus TCP	Client	✓	✓	✓	✓	✓	✓	✓
	Server	-	✓	✓	✓	✓	✓	✓
Modbus RTU	Client	-	-	-	-	✓	✓	-
	Server	-	-	-	-	✓	✓	-
EtherNet/IP	Scanner (Client)	-	✓	-	✓	✓	✓	-
PROFIBUS DP	Client	Through Modbus TCP third party gateway	Through Modbus TCP third party gateway	Through Modbus TCP third party gateway	Through Modbus TCP third party gateway	Through Modbus TCP third party gateway	Through Modbus TCP third party gateway	Through Modbus TCP third party gateway
ASi-5 / ASi-3		Through Modbus TCP third party gateway	Through Modbus TCP third party gateway	Through Modbus TCP third party gateway	Through Modbus TCP third party gateway	Through Modbus TCP third party gateway	Through Modbus TCP third party gateway	Through Modbus TCP third party gateway
HART		✓	✓	-	-	-	-	-
Open TCP/IP		-	✓	✓	✓	✓	✓	✓

## EcoStruxure Automation Expert Distributed Programmable Automation Controller (dPAC) Platforms

### Selection guide

EcoStruxure Automation Expert consists of several hardware components working together to create a complete automation system.

		High Availability Soft dPAC	Simplex Soft dPAC (Linux OS)	Simplex Soft dPAC (Windows OS)	Modicon M580 dPAC	Modicon M262 dPAC	Modicon M251 dPAC	Altivar dPAC
								
<b>Applications</b>	Type Specification	Virtualized device For critical applications	Virtualized device For real time applications	Virtualized device For non-real time applications	Embedded device For robust process application	Embedded device For performance modular machines	Embedded device For small modular machines	Embedded device For distributed or Variable Speed Drive centric applications, including mini modular machines
<b>Max Application size (Mbytes)</b>		Scalable <sup>(10)</sup>	Scalable <sup>(10)</sup>	Scalable <sup>(10)</sup>	100MB	100MB	20MB	12MB
<b>Communication fieldbus and network performance</b>	Embedded	OPCUA Server (20000 variables) Modbus TCP Client (60 devices) <sup>(7)</sup>	OPCUA Server (20000 variables) OPCUA Client EtherNet/IP (32 devices @20ms RPI) <sup>(7)</sup> Modbus TCP Client (60 devices) <sup>(7)</sup> Modbus TCP Server (800 variables) <sup>(7)</sup>	OPCUA Server (20000 variables) Modbus TCP Client (60 devices) <sup>(7)</sup> Modbus TCP Server (800 variables) <sup>(7)</sup>	OPCUA Server (5000 variables) EtherNet/IP (16 devices @20ms RPI) <sup>(7)</sup> Modbus TCP Client (16 devices) <sup>(7)</sup> Modbus TCP Server (800 variables) <sup>(7)</sup>	OPCUA Server (5000 variables) EtherNet/IP (16 devices @20ms RPI) <sup>(7)</sup> Modbus TCP Client (16 devices) <sup>(7)</sup> Modbus TCP Server (800 variables) <sup>(7)</sup> Modbus RTU 56kbps	OPCUA Server (1000 variables) EtherNet/IP (8 devices @20ms RPI) <sup>(7)</sup> Modbus TCP Client (16 devices) <sup>(7)</sup> Modbus TCP Server (800 variables) <sup>(7)</sup> Modbus RTU 56kbps	OPCUA Server (200 variables) OPCUA Client Modbus TCP Client (8 devices) <sup>(7)</sup> Modbus TCP Server (50 variables) <sup>(7)</sup>
	Optional	Profibus DP through Modbus TCP third party gateway	Asi-5/Asi-3 through Modbus TCP third party gateway Profibus DP through Modbus TCP third party gateway	Asi-5/Asi-3 through Modbus TCP third party gateway Profibus DP through Modbus TCP third party gateway	Asi-5/Asi-3 through Modbus TCP third party gateway Profibus DP through Modbus TCP third party gateway	Asi-5/Asi-3 through Modbus TCP third party gateway Profibus DP through Modbus TCP third party gateway	Asi-5/Asi-3 through Modbus TCP third party gateway Profibus DP through Modbus TCP third party gateway	–
	Connectivity services	–	MQTT Pub/Sub	MQTT Pub/Sub	Open TCP/IP MQTT Pub/Sub	Open TCP/IP	Open TCP/IP	Open TCP/IP
<b>I/O</b>	Discrete I/O channels	1750 <sup>(3)</sup>	1750 <sup>(3)</sup>	–	352 <sup>(2)</sup>	112 <sup>(2)</sup>	112 <sup>(2)</sup>	Up to 23 (depending on drive reference)
	Analog I/O channels	1750 <sup>(3)</sup>	1750 <sup>(3)</sup>	–	72	112	112	Up to 7 (depending on drive reference)
<b>Compatible expansion I/O module ranges<sup>(5)</sup></b>	Extension I/O	–	–	–	4 Modicon X80 backplane	14 Modicon TM3	14 Modicon TM3	–
	Remote I/O	16 Modicon X80 backplane <sup>(4)</sup>	16 Modicon X80 backplane <sup>(4)</sup>	–	–	–	–	–
<b>References</b>		<b>Hardware agnostic<sup>(8)</sup></b>	<b>Hardware agnostic<sup>(8)</sup></b>	<b>Hardware agnostic<sup>(9)</sup></b>	<b>BMED581020 / BMED581020C</b>	<b>TM262L01MDESE8T</b>	<b>TM251MDESE</b>	<b>VW3A3530D<sup>(6)</sup> / VW3A1111<sup>(7)</sup></b>

(1) Recommended limit

(2) Typical architecture – I/O can increase or decrease depending on the I/O scan rate or change rate, and the auxiliary application load with connected devices, such as Modbus.

(3) I/O count can increase or decrease depending on the CPU version used on the host iPC, I/O scan rate or change rate, and the auxiliary application load with connected devices, such as Modbus. The host iPC processor speed greatly affects the performance capabilities of the controller. The performance limits can be increased when using more powerful iPC processors, such as the Intel i5/i7 offerings.

(4) BMECRD0100: Ethernet Remote I/O drop adapter for Automation Expert High Availability

(5) Consult the [DIA3ED2140109EN](#) and [DIA6ED2131203EN](#) catalog for additional information on the I/O compatibility.

(6) Altivar ATV dPAC module

(7) Graphic display terminal for Altivar ATV340

(8) Reference value based on the Harmony P6 Celeron (2 cores)

(9) Minimum requirements available in the section Windows – Software dPAC (page 13).

(10) Maximum application size can increase or decrease depending on the CPU version on the host iPC.



#### EcoStruxure Automation Expert Distributed Programmable Automation Controller (dPAC) Platforms (continued)

##### System requirements

##### Linux – Software dPAC

System requirements	Minimum	Performance	Required for RT control
OS	Debian 10.3, Ubuntu 18.04 and 20.04, or Raspbian 32- or 64-bit		Ubuntu 20.04 with low-latency patch or other distribution with PREEMPT-RT patch
Docker	Docker 19.03.8 and above		
CPU	X86/ARM 1 GHz or higher	Multi-core X86/ARM 1 GHz or higher	Dedicated cores
RAM	256 MB	1 GB	
HDD/SSD	16 GB	32 GB	
Network interface	At least one Network Interface Card (NIC)	Two NICs to isolate control and device networks	One NIC per container for RT fieldbuses
Time synchronization	NTPv4 client	NTPv4 client support with monotonic and drift compensation	

##### Linux – Software dPAC, High Availability<sup>(1)</sup>

System requirements	Description	Note
Processor	PC Celeron 4305UE, 2 Core, 2 Threads	Need Multi-core X86 processor. ARM is not supported for v24.0
RAM	SO-DIMM RAM 4 GB	Minimum 4GB. ECC support is optional.
Memory	M.2 SSD Standard Endurance 128 GB	128 GB is not required. However, it is the lowest that was tested.
Network interface	RJ45 GbE Ethernet NIC	Three NICs are needed for redundant network configuration. <ul style="list-style-type: none"> <li>• One 1 GB speed NIC for interlink connection</li> <li>• Two 100MB for device network</li> </ul>
Operating system	Linux	Ubuntu 20.04 (Harmony P6)/22.04 (ASRock) tested

(1) A set of 2 manageable switches compatible with RSTP and having at least 6 physical ports is also needed.

##### Windows – Software dPAC

System requirements	Minimum	Performance
Processor	1 GHz	2 GHz or higher
RAM <sup>(1)</sup>	2 GB	4 GB
Hard disk free space <sup>(1)</sup>	1 GB	10 GB
Display resolution	1280x1024	1920x1080 or higher
Pointing device	Mouse or compatible	
Network interface	One Ethernet interface	
Operating system	Microsoft Windows 10 Professional (64-bit) Version 1903 and later, Microsoft Windows 11 Professional Version 21H2 and later, and Microsoft Server Version 2019 (1809 and later)	
.NET framework	.NET 4.8	.NET 4.8 or higher

(1) Requirement is indicated for each software package. More than one software package can be installed on the same device. In this case, you need to add the respective RAM and hard disk free space requirements together. For example, if you install the HMI and Archive software packages on the same device, the minimum RAM required is 4 GB (2 GB + 2 GB).

### Types of standard architectures

EcoStruxure Automation Expert breaks the dependency between the application software and the hardware platform it runs. Together with its distribution capabilities, EcoStruxure Automation Expert is a unique automation solution to be used in any kind of architecture, from small machines up to complex process architecture.

### Example of Soft dPAC standard architecture

The EcoStruxure Automation Expert architecture for small machines increases engineering efficiency by using the Automatically generated network transparent communications between controller and HMI objects with many-to-many connectivity and communication protocol for field devices.

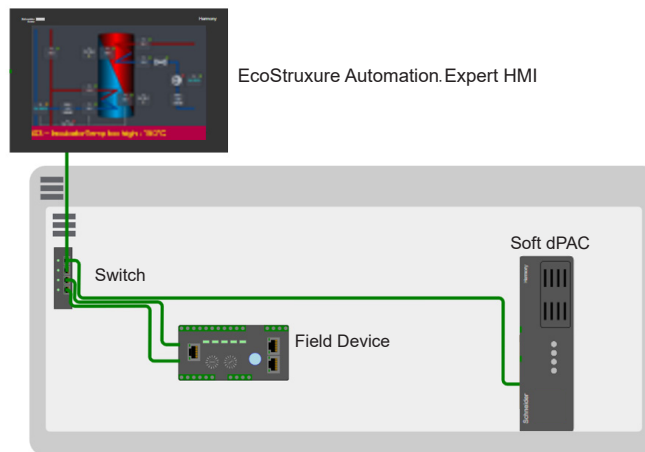

### Example of distributed standard architecture

The openness and scalability of the EcoStruxure Automation Expert makes it ready for IT/OT with connectivity AI model by HTTP and apps & analytics in an architecture with distributed controllers.

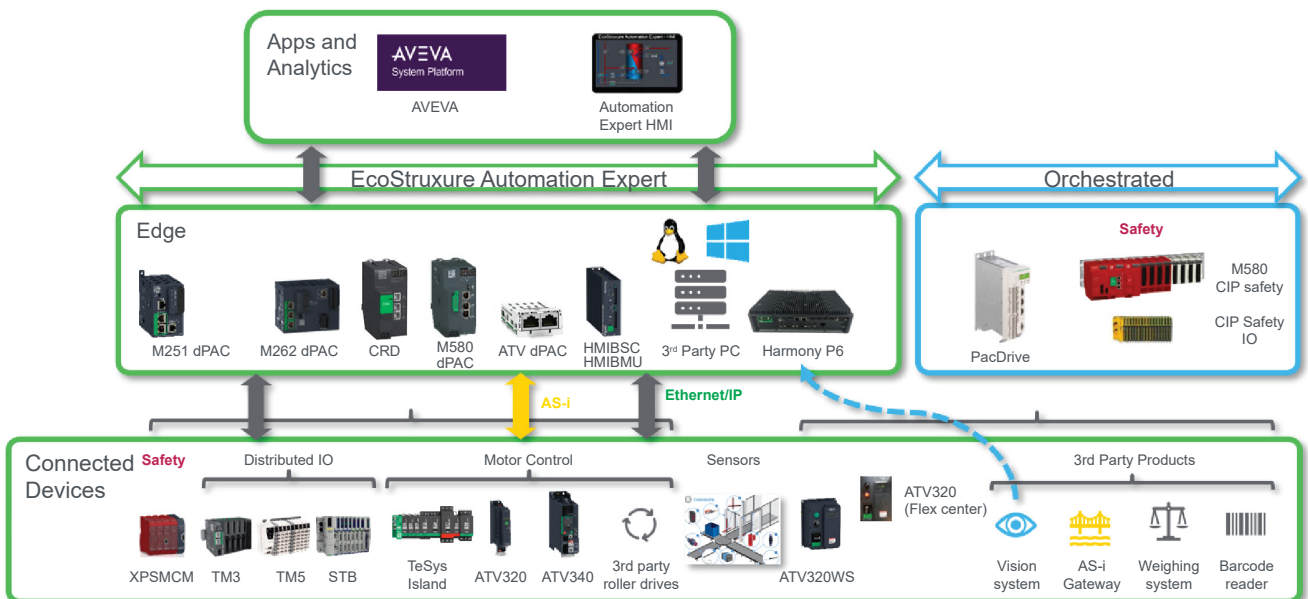

### Example of complex standard architecture

The complex architecture below illustrates the extensive possibilities of distributed application for the EcoStruxure Automation Expert solution among the different dPACs. This example is focused on a combination of Modicon M580d and Altivar ATVd dPACs.

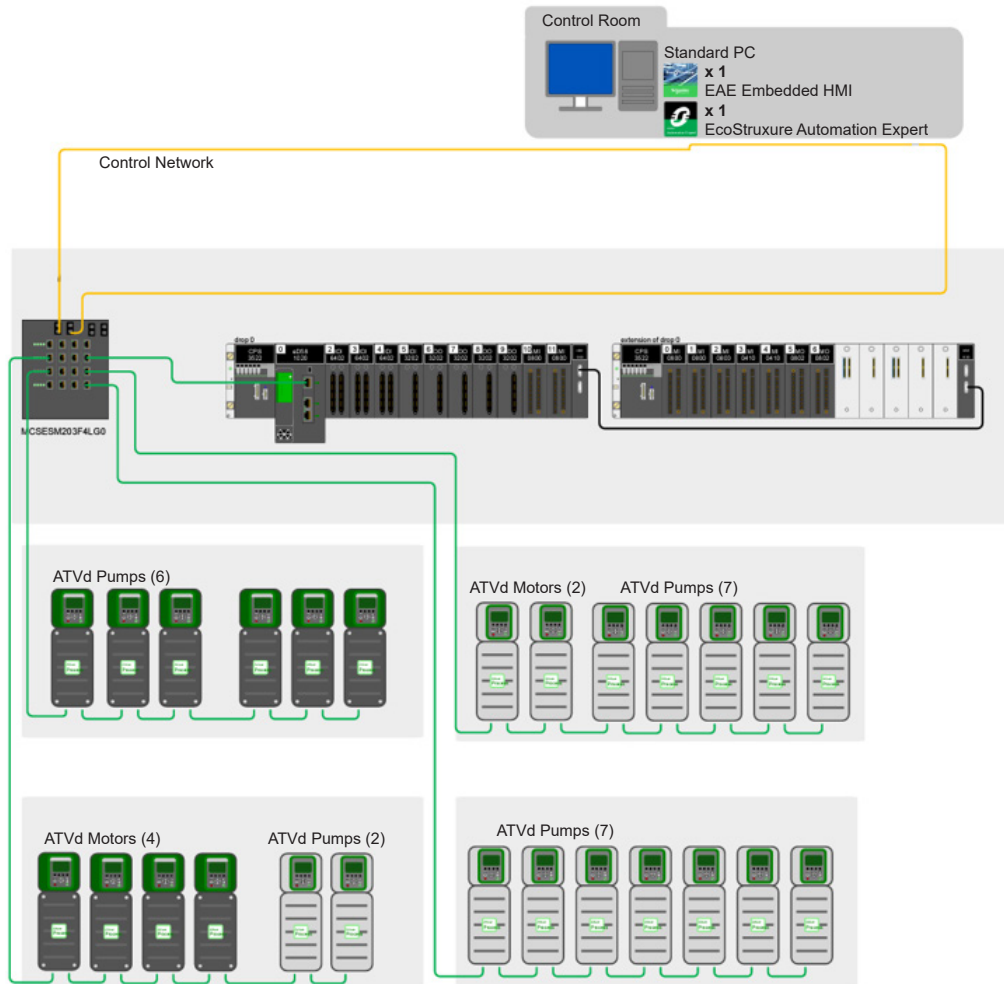

### Types of high-availability architectures

The EcoStruxure Automation Expert high-availability system is used for more demanding applications in terms of the availability of the control/command system where no interruption of the process can be tolerated. The high-availability system with EcoStruxure Automation Expert software helps increase productivity by minimizing process downtime.

#### High-availability Soft dPAC based on Ethernet RIO architecture

The high-availability configuration comprises two identical iPCs (industrial computers), each hosting a High-Availability Soft dPAC, and configured to run in a Pair where one instance (a Partner) is driving the process while the other Partner is ready to take over control, if the first one stops working.

The two Partners check each other's availability by communicating over two links:

- A dedicated cable (the HA Interlink), and
- The device network, which also carries commands and diagnostics.

In a high-availability Soft dPAC topology based on an Ethernet RIO architecture, devices are hardwired on remote I/O over Ethernet by BMECRD1020 (RIO drop adapter for Modicon X80 I/Os modules). This high-availability system is used for sensitive processes that require a bumpless I/O control takeover time.

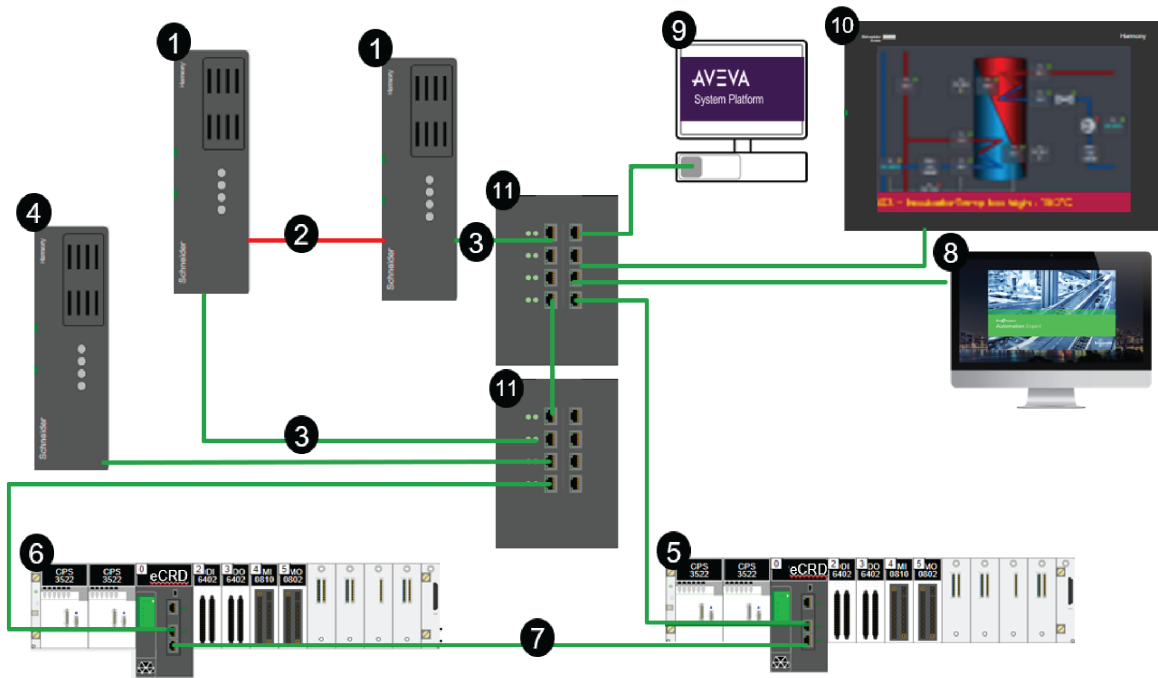

1. Linux-based iPC pair, each hosting an instance of High Availability Soft dPAC
2. HA Interlink: 1GB/s Network Interface Card (NIC)/connection
3. Redundant network: 100MB/s with NIC bonding
4. Linux-based standalone iPC, hosting an instance of non-redundant Soft dPAC
5. Non-redundant Modicon X80 I/O drop with BMECRD0100 RIO drop adapter and redundant power supplies
6. Non-redundant Modicon X80 I/O drop with BMECRD0100 RIO drop adapter and redundant power supplies
7. Remote I/O RSTP - enabled ring network
8. Workstation running EcoStruxure Automation Expert build time, RSTP configuration software
9. Workstation running AVEVA System Platform (ASP), AVEVA Operation Management Interface (OMI), and AVEVA historian. Communication is over OPC UA
10. Workstation running EcoStruxure Automation Expert Runtime HMI
11. Managed switches, for example, Modicon switch

### Components of a high-availability system

#### High-Availability Soft dPAC pair

At the heart of a high-availability architecture are two iPCS - Preferred Primary and Non-Preferred Primary, with identical hardware configurations, based on Linux software connected via a high-speed (1 Gbps) communication link. The Preferred Primary device executes the application program and controls the I/Os located in Modicon X80 drops. The Non-Preferred Primary remains in the background. In the event of a detected error affecting the Primary device, the Standby system switches over automatically, changing over the execution of the application program and control of the I/O to the Standby device with an up-to-date data context. Once the changeover is complete, the Standby device becomes the Primary device while the former Primary device is being cleared from the detected error: when clearance is done, the device reconnects to the standby system and acts as the Standby device. The changeover from Primary to Standby is performed smoothly at the outputs and is completely transparent to the process.

#### Modicon X80 Redundant power supplies and compatible backplanes

For high-availability applications, two BMXCPS●●02 redundant power supplies can be used on the same rack to increase the availability of power supply. They are supported by 6-slot BMEXBP0602 backplane and 10-slot BMEXBP1002 backplane equipped with dual slots marked CPS1 and CPS2. On CPS1 slot, the power supply is initially set as Primary and on CPS2 slot, as Standby. When power stops being supplied in accordance with expected rate, they switch roles so that power can be continuously delivered. See Modicon X80 modules catalog for more details.

#### Example of complex high-availability architecture

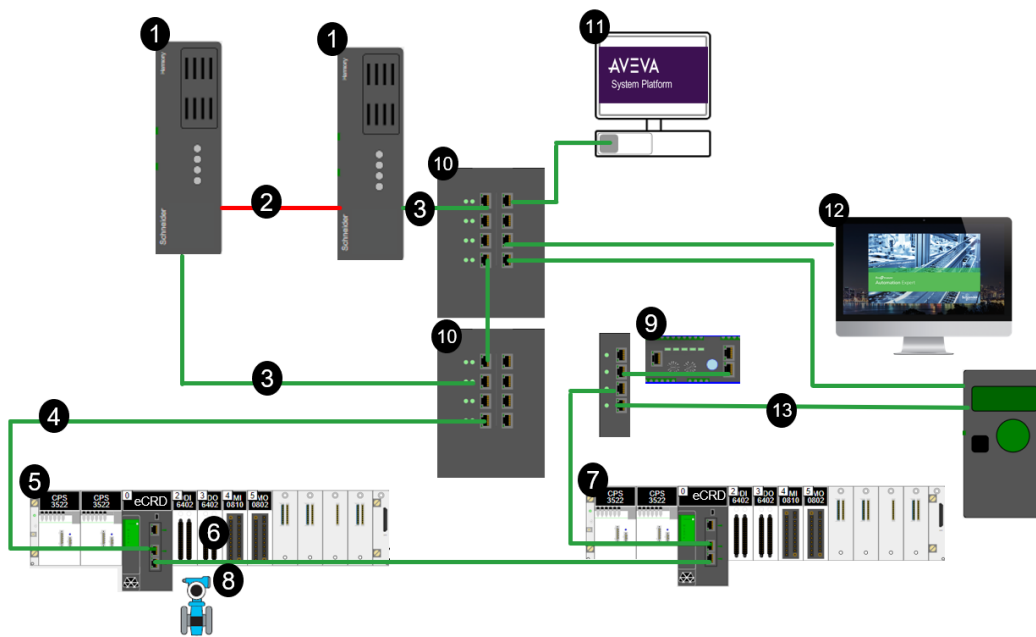

The complex architecture illustrates the extensive possibilities of the High-Availability Soft dPAC in terms of cross-communication, RIO and DIO networks:

1. Linux-based iPC pair, each hosting an instance of High Availability Soft dPAC
2. HA Interlink: 1GB/s NIC/connection
3. Redundant network: 100MB/s with NIC bonding
4. Remote I/O RSTP enabled ring network
5. Non-redundant X80 I/O drop with:
  - BMECRD0100 RIO drop adapter
  - Redundant power supplies on the main backplane
  - Extended main backplane
6. Distributed I/O connected to field devices (sensors, actuators)
7. Non-redundant Modicon X80 I/O drop with BMECRD0100 RIO drop adapter
8. BMEAHI0812/BMEAHO0412 Hart I/O modules
9. Modbus TCP devices in an Intelligent power and motor control center (including PM5500 power meter series and MasterPact MTZ) connected to TeSysT motor controllers and Altivar processors
10. Managed switches
11. Workstation running AVEVA System Platform (ASP), AVEVA Operation Management Interface (OMI), and AVEVA historian  
Communication is over OPC UA
12. Workstation running EcoStruxure Automation Expert Runtime HMI
13. Cross-communication with Altivar ATVdPAC for motor control

### EcoStruxure Automation Expert – Perpetual licensing

The EcoStruxure Automation Expert offer provides a simplified approach to the software licensing model. The offer has two categories of licenses – **Build** and **Run**.

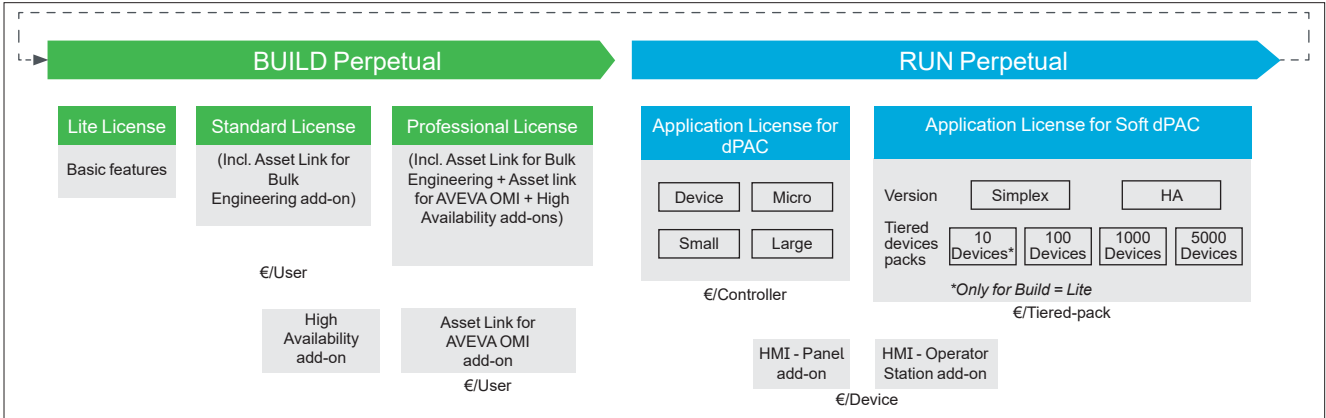

### EcoStruxure Automation Expert – Build license

The **Build** software requires a license per seat to create Automation Expert based applications. The **Build** engineering license provides the capability to create, configure, and manage UAO runtime control applications, HMI, archive, and network/device topologies.

The **Build** licenses can be perpetual or subscription-based<sup>(1)</sup> and are available in four types:

- **Trial**: The engineering software includes a full function demo mode for 42 days unlicensed.
- **Lite**: A basic set of features is included to focus on machine and small process applications. This license allows the use of machine controller platforms and restricted process control platforms. The limitations of this type of license will be included in future release version 24.1.
- **Standard**: A basic set of features included and can be extended by buying add on licenses to extend functionalities. The add ons that are available with EcoStruxure Automation Expert Standard licenses are:
  - Asset Link for AVEVA OMI
  - High Availability Engineering
  - Asset Link for Bulk Engineering is already included in the Standard engineering license v24.0
- **Professional**: This type of license includes all currently available features. Any new features available in future releases within the first year following the activation date will be included for the software updates.

Each commercial license provides:

- The capability to design, develop, simulate with HMI, and commission a complete system
- Collaborative engineering (SVN client) plugin
- Physical topology editor
- Free software updates, within the first 12 months from the activation date
- Support desk from 9 am to 5pm
- Access to private communities on exchange.se.com for p2p support, libraries, project samples, training material, TVDAs, and so on.

(1) For more information, refer to EcoStruxure Automation Expert – Subscription-based licensing

### Build license compatibility

Supported platforms	Lite	Standard	Professional
Soft dPAC	1 Max	✓	✓
Soft dPAC High Availability	1 Max	✓	✓
ATV dPAC	✓	✓	✓
M251 dPAC	✓	✓	✓
M262 dPAC	✓	✓	✓
M580 dPAC	1 Max	✓	✓
<b>Add-ons (per seat)</b>			
Asset Link for Bulk Engineering	–	✓	✓
Asset Link for AVEVA OMI	–	Optional	✓
High Availability Engineering	Optional	Optional	✓



### EcoStruxure Automation Expert – Perpetual licensing (continued)

#### Engineering license references

The **Build** engineering licenses are available in different types: Lite, Standard, or Professional. Standard and Professional licenses can be perpetual or subscription-based<sup>(1)</sup> and are currently offered for single seat use only.

Reference	Description
<a href="#">EALBTEP24</a>	Lite Engineering License
<a href="#">EALBTC</a>	Standard Engineering License
<a href="#">EALBFC</a>	Professional Engineering License
<a href="#">EALUAOC</a>	Engineering license for UAO vendor

The standard engineering license includes the "Asset Link for Bulk Engineering" add-on and allows for the addition of the following add-ons:

Reference	Description
<a href="#">EALBATC</a>	Add-on for Asset Link for AVEVA OMI
<a href="#">EALBAHC</a>	Add-on for High Availability

### EcoStruxure Automation Expert – Perpetual licensing (continued)

#### EcoStruxure Automation Expert – Run licenses

In addition to the **Build** engineering license that is required to create EcoStruxure Automation Expert applications, for the operation and maintenance of the application, each hardware should have a **Run** license.

The **Run** licenses will be based on the control type of Schneider Electric dPAC controllers and the number of devices connected for the Soft dPAC PC-based control.

The **Run** application licenses are available in perpetual and subscription-based model. For more information, refer to EcoStruxure Automation Expert – Subscription-based licensing.

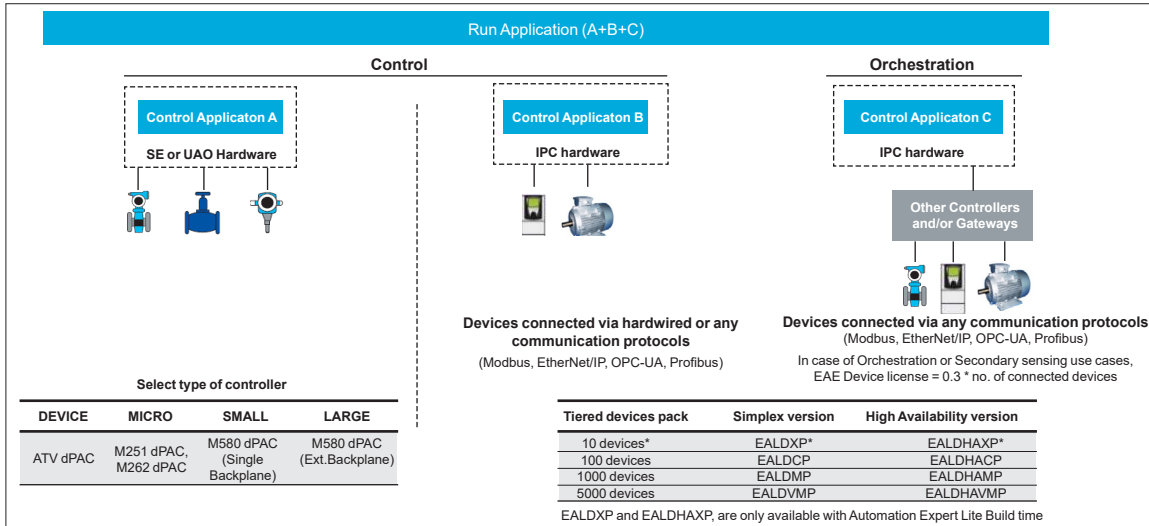

For exact calculation of the number of devices and controller type for the application license, a software license configurator for EcoStruxure Automation Expert is available on our [website](#).

#### Run license compatibility

Available Licenses	Lite	Standard	Professional
Device	✓	✓	✓
Micro	✓	✓	✓
Small	✓	✓	✓
Large	✓	✓	✓
10 Pack	✓	-	-
100 Pack	-	✓	✓
1000 Pack	-	✓	✓
5000 Pack	-	✓	✓

The available application licenses for dPAC controllers are:

Reference	Description
<a href="#">EALADP</a>	Application license for one dPAC runtime instance, DEVICE
<a href="#">EALANP</a>	Application license for one dPAC runtime instance, NANO
<a href="#">EALAMP</a>	Application license for one dPAC runtime instance, MICRO
<a href="#">EALASP</a>	Application license for one dPAC runtime instance, SMALL
<a href="#">EALALP</a>	Application license for one dPAC runtime instance, LARGE

### EcoStruxure Automation Expert – Perpetual Licensing (continued)

The Automation Expert HMI license includes rights to both HMI and Archive runtimes. All runtime licenses are perpetual. Different license types are required depending on the platform on which the runtime is installed, as per the following table:

#### EcoStruxure Automation Expert – HMI license

Automation Expert Runtime	Platform	License type
HMI <sup>(1)</sup>	Harmony ST6 HMI range	1 license per HMI runtime instance
HMI <sup>(1)</sup>	PC-type HMI (Windows 10/Linux)	1 license per HMI runtime instance

(1) Each license includes both Automation Expert HMI and Automation Expert Archive runtime rights.

The Automation Expert HMI Runtime licenses are:

Reference	Description
<a href="#">EALH1P</a>	Automation Expert HMI Runtime - Panel (ST6)
<a href="#">EALH2P</a>	Automation Expert HMI Runtime - Operator (iPC)

For exact calculation of the number of devices and controller type for the application license, a software license configurator for Automation Expert is available on [se.com](http://se.com).

#### Run application license references

Reference	Description
<a href="#">EALDXP<sup>(1)</sup></a>	Application Standard 10 Devices
<a href="#">EALDCP</a>	Application Standard 100 Devices
<a href="#">EALDMP</a>	Application Standard 1000 Devices
<a href="#">EALDVMP</a>	Application Standard 5000 Devices
<a href="#">EALDHAXP<sup>(1)</sup></a>	Application High Availability 10 Devices
<a href="#">EALDHACP</a>	Application High Availability 100 Devices
<a href="#">EALDHAMP</a>	Application High Availability 1000 Devices
<a href="#">EALDHAVMP</a>	Application High Availability 5000 Devices

(1) Only available with Automation Expert Lite build time.

Download the HMIBMI, HMIBMO,  
and HMIP6 ranges catalog

Catalog | May 2022



Harmony iPC

Industrial PC, Edge Box and Display

Libra OS | Schneider Electric

**EcoStruxure Automation Expert – Subscription-based licensing**

To provide customers with more business and economic model flexibility and reduced obsolescence risk, both **Build** and **Run** licenses are available under a subscription-based model consisting of 1-year termed subscriptions. The subscription-based licenses model is available for project business with end-users.

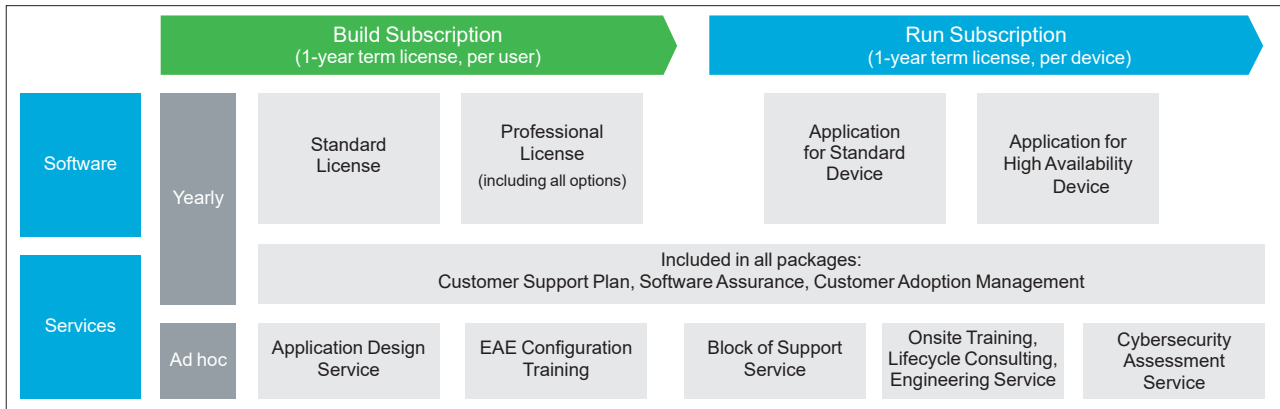

Each commercial license provides:

- The capability to design, develop, simulate with HMI, and commission a complete system
- Collaborative engineering (SVN client) plugin
- Physical topology editor
- Free software updates
- Support desk from 9 am to 5pm
- Access to private communities on exchange.se.com for p2p support, libraries, project samples, training material, TVDAs, and so on.

**Build subscription-based licenses**

The Build subscription-based licenses are available in three different types:

- **Trial:** The engineering software includes a full function demo mode for 42 days unlicensed.
- **Standard:** A basic set of features equivalent to Standard perpetual-based license.
- **Professional:** this version includes all available features, including:
  - Asset Link for AVEVA OMI
  - High Availability Engineering

The **Build** subscription-based licenses are offered for single-seat use only. A license is needed per user.

Reference	Description
<a href="#">EALBTS1</a>	Build - Standard Engineering Yearly
<a href="#">EALBTS2</a>	Build - Professional Engineering Yearly

**Run subscription-based licenses**

The **Run** subscription-based licenses are available in two different types:

- **Standard:** for simplex applications.
- **High Availability:** for high availability applications.

The **Run** subscription-based licenses are sized per device. A license is needed per device. To know how to measure the number of devices of your application, refer to the EcoStruxure Automation Expert – Perpetual Licensing.

Reference	Description
<a href="#">EALOMD1</a>	Run - Standard Device Yearly
<a href="#">EALOMD2</a>	Run – High Availability Device Yearly

Please contact your Schneider Electric representative for additional information.

In addition to the advantages included in Perpetual licenses, subscription-based licenses include:

- Access to upcoming software releases and features in the scope of your license
- Customer adoption support plan, with a Trusted Advisor that will support you to reduce your time to value with each new release and its features, recommend the appropriate evolutions, and support you on license lifecycle and renewal process.

**EcoStruxure Automation Expert Licensing – Architecture**  
Example of single high-availability architecture

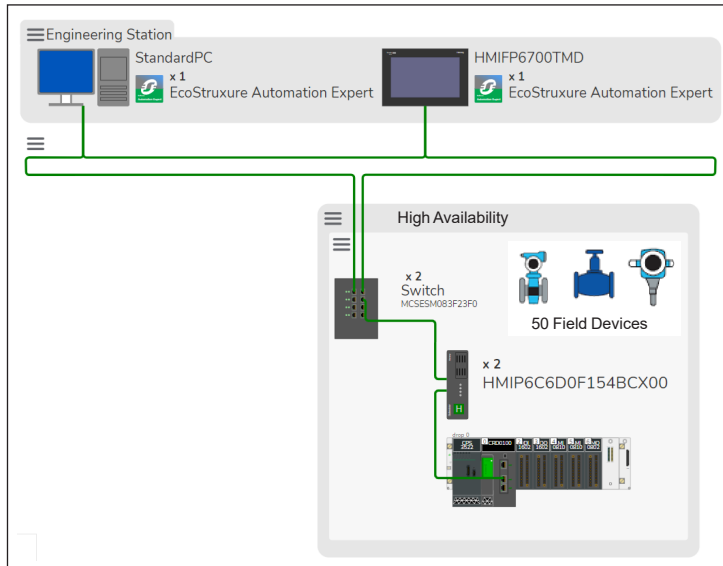

**Build license**

Reference	Description	No. of Seats
<a href="#">EALBTEP24</a>	Lite Engineering License	1
Reference	Description	No. of Licenses
<a href="#">EALBAHC</a>	Add-on for High Availability	1

**Run license**

**Unit 1 - High Availability Control 50 devices**

Reference	Description	No. of Licenses
<a href="#">EALBAHC</a>	Application High Availability 10 Devices	5
Reference	Description	No. of Licenses
<a href="#">EALH2P</a>	Automation Expert HMI Runtime Operator	1

**EcoStruxure Automation Expert Licensing – Architecture**  
Example of complex high-availability architecture

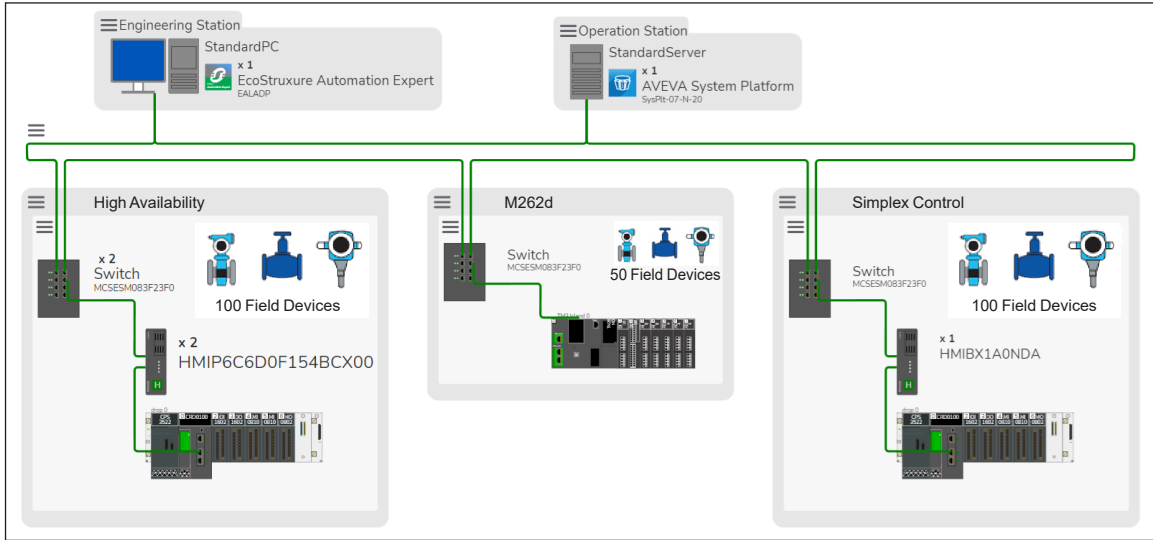

**Build license**

Reference	Description	No. of Seats
EALBFC	Professional Engineering License	1

**Run license**

**Unit 1 – High Availability Control 100 devices**

Reference	Description	No. of Seats
EALDHACP	Application High Availability 100 Devices	1

**Unit 2 – 1 M262d Control 50 devices**

Reference	Description	No. of Licenses
EALAMP	Application license for one dPAC runtime instance, MICRO	1

**Unit 3 – Simplex Control 100 devices**

Reference	Description	No. of Licenses
EALDCP	Application Standard 100 Devices	1



List of Modicon X80 hardware compatible with Modicon M580 dPAC, Modicon CRD for Simplex/High Availability Soft dPAC (Linux OS)

Type	Reference	Description	Compatibility with Modicon M580 dPAC	Compatibility with Modicon CRD for Simplex/High Availability Soft dPAC (Linux OS)
Rack	<a href="#">BMEXBP0400</a>	4-slot Ethernet backplane	Yes	Yes
Rack	<a href="#">BMEXBP0400H</a>	Ruggedized 4-slot Ethernet backplane	Yes	Yes
Rack	<a href="#">BMEXBP0602</a>	6-slot Ethernet backplane redundant PS	Yes	Yes
Rack	<a href="#">BMEXBP0602H</a>	Ruggedized 6-slot Ethernet backplane redundant PS	Yes	Yes
Rack	<a href="#">BMEXBP0800</a>	8-slot Ethernet backplane	Yes	Yes
Rack	<a href="#">BMEXBP0800H</a>	Ruggedized 8-slot Ethernet backplane	Yes	Yes
Rack	<a href="#">BMEXBP1002</a>	10-slot Ethernet backplane redundant PS	Yes	Yes
Rack	<a href="#">BMEXBP1002H</a>	Ruggedized 10-slot Ethernet backplane redundant PS	Yes	Yes
Rack	<a href="#">BMEXBP1200</a>	12-slot Ethernet backplane	Yes	Yes
Rack	<a href="#">BMEXBP1200H</a>	Ruggedized 12-slot Ethernet backplane	Yes	Yes
Rack	<a href="#">BMXXBC008K</a>	Backplane extension cable 0.8 m/2.6 ft	Yes	Yes
Rack	<a href="#">BMXXBC015K</a>	Backplane extension cable 1.5 m/4.9 ft	Yes	Yes
Rack	<a href="#">BMXXBC030K</a>	Backplane extension cable 3 m/9.8 ft	Yes	Yes
Rack	<a href="#">BMXXBC050K</a>	Backplane extension cable 5 m/16.4 ft	Yes	Yes
Rack	<a href="#">BMXXBC120K</a>	Backplane extension cable 12 m/39 ft	Yes	Yes
Rack	<a href="#">BMXXBE1000</a>	Standard backplane extender	Yes	Yes
Rack	<a href="#">BMXXBE1000H</a>	Ruggedized standard backplane extender	Yes	Yes
Rack	<a href="#">BMXXBE2005</a>	Backplane extender kit	Yes	Yes
Rack	<a href="#">BMXXBP0400</a>	4-slot backplane	Yes	Yes
Rack	<a href="#">BMXXBP0400H</a>	Ruggedized 4-slot backplane	Yes	Yes
Rack	<a href="#">BMXXBP0600</a>	6-slot backplane	Yes	Yes
Rack	<a href="#">BMXXBP0600H</a>	Ruggedized 6-slot backplane	Yes	Yes
Rack	<a href="#">BMXXBP0800</a>	8-slot backplane	Yes	Yes
Rack	<a href="#">BMXXBP0800H</a>	Ruggedized 8-slot backplane	Yes	Yes
Rack	<a href="#">BMXXBP1200</a>	12-slot backplane	Yes	Yes
Rack	<a href="#">BMXXBP1200H</a>	Ruggedized 12-slot backplane	Yes	Yes
SD card	<a href="#">BMXRMS004GPF</a>	Optional M580 SD card 4 GB	Yes	No
Analog I/O	<a href="#">BMXAMI0410</a>	4 voltage/current isolated high-speed analog inputs	Yes	Yes
Analog I/O	<a href="#">BMXAMI0410H</a>	Ruggedized 4 voltage/current isolated high-level analog inputs	Yes	No
Analog I/O	<a href="#">BMXAMI0800</a>	8 voltage/current non-isolated fast analog inputs	Yes	No
Analog I/O	<a href="#">BMXAMI0810</a>	8 voltage/current isolated fast analog inputs	Yes	Yes
Analog I/O	<a href="#">BMXAMI0810H</a>	Ruggedized 8 voltage/current isolated fast analog inputs	Yes	Yes
Analog I/O	<a href="#">BMXAMO0410</a>	4 voltage/current isolated analog outputs	Yes	Yes
Analog I/O	<a href="#">BMXAMO0410H</a>	Ruggedized 4 voltage/current isolated analog outputs	Yes	Yes
Analog I/O	<a href="#">BMXAMO0802</a>	8 current non-isolated analog outputs	Yes	Yes
Analog I/O	<a href="#">BMXAMM0600</a>	4 analog inputs - 2 analog outputs	Yes	No
Analog I/O	<a href="#">BMXAMM0600H</a>	Ruggedized 4 analog inputs - 2 analog outputs	Yes	No
Analog I/O	<a href="#">BMXAMO0210</a>	2 isolated analog outputs	Yes	No
Analog I/O	<a href="#">BMXAMO0210H</a>	Ruggedized 2 voltage/current isolated analog outputs	Yes	No
Analog I/O	<a href="#">BMXART0814</a>	8 isolated TC/RTD inputs	Yes	Yes
Analog I/O	<a href="#">BMXART0814H</a>	Ruggedized 8 isolated TC/RTD inputs	Yes	Yes
Analog I/O	<a href="#">BMEAHI0812</a>	8 current isolated analog inputs, HART	No	Yes
Analog I/O	<a href="#">BMEAHO0412</a>	4 current isolated high-level analog outputs, HART	No	Yes
Power	<a href="#">BMXCPS2000</a>	Standard AC power supply	Yes	Yes
Power	<a href="#">BMXCPS2010</a>	Standard isolated DC power supply	Yes	Yes
Power	<a href="#">BMXCPS3020</a>	High-power isolated 24 to 48 V DC power supply	Yes	Yes
Power	<a href="#">BMXCPS3020H</a>	Ruggedized high-power isolated 24 to 48 V DC power supply	Yes	Yes
Power	<a href="#">BMXCPS3500</a>	High-power AC power supply	Yes	Yes
Power	<a href="#">BMXCPS3500H</a>	Ruggedized high-power AC power supply	Yes	Yes
Power	<a href="#">BMXCPS3522</a>	Redundant 125 V DC power supply	Yes	Yes
Power	<a href="#">BMXCPS3540T</a>	High-power 125 V DC power supply	Yes	Yes
Power	<a href="#">BMXCPS4002</a>	Redundant AC power supply	Yes	Yes
Power	<a href="#">BMXCPS4022</a>	Redundant 24 to 48 V DC power supply	Yes	Yes
Discrete I/O	<a href="#">BMXDDI1602</a>	16x 24 V DC sink discrete inputs	Yes	Yes
Discrete I/O	<a href="#">BMXDDI1602H</a>	Ruggedized 16x 24 V DC sink discrete inputs	Yes	Yes
Discrete I/O	<a href="#">BMXDDI3202K</a>	32x 24 V DC sink discrete inputs	Yes	No
Discrete I/O	<a href="#">BMXDDI6402K</a>	64x 24 V DC sink discrete inputs	Yes	Yes
Discrete I/O	<a href="#">BMXDDM16025</a>	8x 24 V DC discrete inputs, 8x discrete relay outputs	Yes	No
Discrete I/O	<a href="#">BMXDDM16025H</a>	Ruggedized 8x 24 V DC discrete inputs, 8x discrete relay outputs	Yes	No
Discrete I/O	<a href="#">BMXDDO1602</a>	16 transistor source 0.5 A discrete outputs	Yes	Yes

<b>List of Modicon X80 hardware compatible with Modicon M580 dPAC, Modicon CRD for Simplex/High Availability Soft dPAC (Linux OS)</b>				
Type	Reference	Description	Compatibility with Modicon M580 dPAC	Compatibility with Modicon CRD for Simplex/High Availability Soft dPAC (Linux OS)
Discrete I/O	<a href="#">BMXDDO1602H</a>	Ruggedized 16 transistor source 0.5A discrete outputs	Yes	Yes
Discrete I/O	<a href="#">BMXDDO6402K</a>	64 transistor source 0.1 A discrete outputs	Yes	Yes
Discrete I/O	<a href="#">BMXDRA0815</a>	8 isolated relay outputs	Yes	No
Discrete I/O	<a href="#">BMXDRA0815H</a>	Ruggedized 8 isolated relay outputs	Yes	No
Discrete I/O	<a href="#">BMXDRA1605</a>	16 discrete relay outputs	Yes	No
Discrete I/O	<a href="#">BMXDRA1605H</a>	Ruggedized 16 discrete relay outputs	Yes	No
Discrete I/O	<a href="#">BMXDAI0814</a>	8x 100...120 V AC isolated inputs	Yes	No
Discrete I/O	<a href="#">BMXDAI1604</a>	16x 100...120 V AC capacitive inputs	Yes	No
Discrete I/O	<a href="#">BMXDAI1604H</a>	Ruggedized 16x 100...120 V AC capacitive inputs	Yes	No
Discrete I/O	<a href="#">BMXDAO1605</a>	16x 100...240 V AC triac outputs	Yes	No
Discrete I/O	<a href="#">BMXDAO1605H</a>	Ruggedized 16x 100...240 V AC triac outputs	Yes	No
Discrete I/O	<a href="#">BMXDDM16022</a>	8 inputs - 24 V DC - 8 outputs - solid state	Yes	No
Discrete I/O	<a href="#">BMXDDM16022H</a>	8 inputs - 24 V DC - 8 outputs - solid state- severe environment	Yes	No
Discrete I/O	<a href="#">BMXDDM3202K</a>	16x 24 V DC inputs - 16x solid state outputs	Yes	No
Other	<a href="#">BMXNRP0200</a>	Fiber converter MM/LC 2-channel, 100 m/328 ft	Yes	No
Other	<a href="#">BMXNRP0201</a>	Fiber converter SM/LC 2-channel, 100 m/328 ft	Yes	No
Expert	<a href="#">BMXEHC0800</a>	8 high-speed counter channels	Yes	No
Expert	<a href="#">BMXEHC0800H</a>	Ruggedized 8 high-speed counter channels	Yes	No
Expert	<a href="#">BMXEAE0300</a>	3-channel SSI encoder interface module	Yes	No
Expert	<a href="#">BMXEAE0300H</a>	Ruggedized 3-channel SSI encoder interface module	Yes	No

List of TM3 hardware compatible with Modicon M251 dPAC and M262 dPAC

Type	Reference	Description
Discrete I/O	<a href="#">TM3DI16/TM3DI16G</a>	16 discrete inputs
Discrete I/O	<a href="#">TM3DI32K</a>	32 discrete inputs, HE10 connection
Discrete I/O	<a href="#">TM3DI8/TM3DI8A/TM3DI8G</a>	8 discrete inputs
Discrete I/O	<a href="#">TM3DQ8T/TM3DQ8TG</a>	8x 0.5 A transistor source discrete outputs
Discrete I/O	<a href="#">TM3DQ16T/TM3DQ16TG</a>	16x 0.5 A transistor source discrete outputs
Discrete I/O	<a href="#">TM3DQ16R/TM3DQ16RG</a>	16x 2 A discrete relay outputs
Discrete I/O	<a href="#">TM3DQ32TK</a>	32x 0.1 A transistor source discrete outputs, HE10 connection
Discrete I/O	<a href="#">TM3DQ8U/TM3DQ8UG</a>	8x 0.3 A transistor sink discrete outputs
Discrete I/O	<a href="#">TM3DQ16U/TM3DQ16UG</a>	16x 0.3 A transistor sink discrete outputs
Discrete I/O	<a href="#">TM3DQ32UK</a>	32x 0.4 A transistor sink discrete outputs, HE10 connection
Analog I/O	<a href="#">TM3AI2H/TM3AI2HG</a>	2 high-resolution analog inputs, +10 V, 0-10 V, 0-20 mA, 4-20 mA, 16-bit, 1 ms
Analog I/O	<a href="#">TM3AI4/TM3AI4G</a>	4 analog inputs, +10 V, 0-10 V, 0-20 mA, 4-20 mA, 12-bit, 1 ms
Analog I/O	<a href="#">TM3AI8/TM3AI8G</a>	8 analog inputs, +10 V, 0-10 V, 0-20 mA, 4-20 mA, 12-bit, 1 ms
Analog I/O	<a href="#">TM3AQ2/TM3AQ2G</a>	2 analog outputs, +10 V, 0-10 V, 0-20 mA, 4-20 mA, 12-bit, 1 ms
Analog I/O	<a href="#">TM3AQ4/TM3AQ4G</a>	4 analog outputs, +10 V, 0-10 V, 0-20 mA, 4-20 mA, 12-bit, 1 ms
Safety I/O	<a href="#">TM3SAC5R/TM3SAC5RG</a>	CAT3 Safety, 1 function, max. PL d/SIL3, 3 outputs 6 A relays
Safety I/O	<a href="#">TM3SAF5R/TM3SAF5RG</a>	CAT4 Safety, 1 function, max. PL e/SIL3, 3 outputs 6 A relays
Safety I/O	<a href="#">TM3SAFL5R/TM3SAFL5RG</a>	CAT3 Safety, 2 functions, max. PL d/SIL3, 3 outputs 6 A relays
Safety I/O	<a href="#">TM3SAK6R/TM3SAK6RG</a>	CAT4 Safety, 3 functions, max. PL e/SIL3, 3 outputs 6 A relays
Mixed analog I/O	<a href="#">TM3AM6/TM3AM6G</a>	4 analog outputs, 2 analog inputs, +10 V, 0-10 V, 0-20 mA, 4-20 mA, 12-bit, 1 ms
Thermocouple mixed	<a href="#">TM3TM3/TM3TM3G</a>	2 temperature inputs + 1 analog output TC (J, K, R, S, B, T, N, E, C, L) RTD (NI100, NI1000, PT100, PT1000) (+10 V, 0-10 V) (0-20 mA, 4-20 mA) 16-bit, 100 ms
Thermocouple input	<a href="#">TM3TI4/TM3TI4G</a>	4 temperature inputs TC (J, K, R, S, B, T, N, E, C, L) RTD (NI100, NI1000, PT100, PT1000), (+10 V, 0-10 V) (0-20 mA, 4-20 mA) 16-bit, 100 ms
Thermocouple input	<a href="#">TM3TI8T/TM3TI8TG</a>	8 temperature inputs, NTC, PTC, and TC (J, K, R, S, B, T, N, E, C, L), 16-bit 100 ms
Relay I/O	<a href="#">TM3DM8R/TM3DM8RG</a>	8x 2 A relay outputs
Relay I/O	<a href="#">TM3DM24R/TM3DM24RG</a>	24x 2 A relay outputs
Relay I/O	<a href="#">TM3DQ8R/TM3DQ8RG</a>	8x 2 A relays outputs
Other	<a href="#">TM3XREC1</a>	TM3 remote receiver module
Other	<a href="#">TM3XTRA1</a>	TM3 remote transmitter module
Other	<a href="#">TM3XTYS4</a>	TM3 parallel interface for 4 Tesys motor starters
Expert	<a href="#">TM3XHSC202/TM3XHSC202G</a>	High-speed counting, 2 HSC channels, 10 inputs, 8 outputs

List of Altivar hardware compatible with Altivar ATV dPAC			
Type	Reference	Description	Compatible
Drive	ATV340●●●N4	Altivar Machine drives	Yes
Drive	ATV340●●●N4E ≤ D22	Altivar Machine drives	No
Drive	ATV340●●●N4E ≥ D30	Altivar Machine drives	Yes
Drive	ATV630●●●●● ATV630●●●●●F	Altivar Process drives	Yes
Drive	ATV650●●●●● ATV650●●●●●E ATV650●●●●●F	Altivar Process drives	Yes
Drive	ATV930●●●●● ATV930●●●●●C ATV930●●●●●F	Altivar Process drives	Yes
Drive	ATV950●●●●● ATV950●●●●●E ATV950●●●●●F	Altivar Process drives	Yes
Drive	ATV660●●●●● ATV680●●●●●	Altivar Process drive systems	Yes
Drive	ATV960●●●●● ATV980●●●●●	Altivar Process drive systems	Yes
Drive	ATV99●●●●●	Altivar Process drive systems	Yes
Drive	ATV6A0●●●●● ATV6B0●●●●●	Altivar Process Modular drives	Yes
Drive	ATV9A0●●●●● ATV9B0●●●●●	Altivar Process Modular drives	Yes
Drive	ATV6L0●●●●● ATV9L0●●●●●	Altivar Process liquid-cooled drives	Yes
Other	VW3A1111	Graphic display terminal	Yes
Other	VW3A1112	Door mounting kit	Yes
Mixed I/O	VW3A3203	Extended I/O module - 6 digital inputs/ 2 digital outputs/2 analog inputs	Yes
Mixed I/O	VW3A3204	Extended relay module - 3 relay outputs	Yes
Encoder	VW3A3420	Digital encoder interface module for Altivar 340 and Altivar 9●● variable speed drives	Yes
Encoder	VW3A3422	Analog encoder interface module for Altivar 340 and Altivar 9●● variable speed drives	Yes
Encoder	VW3A3423	Resolver interface module for Altivar 340 and Altivar 9●● variable speed drives	Yes
Encoder	VW3A3424	HTL encoder interface module for Altivar 340 and Altivar 9●● variable speed drives	Yes



BMED581020

Modicon M580 dPAC				
Local I/O capacity	Communication ports	Service ports	Reference	Weight kg/lb
Up to 1024 discrete I/O	2	1	<a href="#">BMED581020</a>	0.848/
Up to 256 analog I/O			<a href="#">BMED581020C</a>	1.872
64 MB integrated memory				

**Standards and certifications**

The Modicon M580 dPAC automation platform has been developed to comply with the principal national and international standards concerning electronic equipment for industrial automation systems.

- Requirements specific to programmable controllers: functional characteristics, immunity, resistance, etc.: IEC/EN 61131-2 and IEC/EN/UL/CSA 61010-2-201
- Requirements specific to power utility automation systems: IEC/EN 61000-6-5, IEC/EN 61850-3 (with installation restrictions)
- Requirements specific to railway applications: EN 50155/IEC 60571 (with installation restrictions)
- Ex areas:
  - For USA and Canada: Hazardous location class I, division 2, groups A, B, C, and D
  - For other countries: CE ATEX (2014/34/EU) or IECEx in defined atmosphere Zone 2 (gas) and/or Zone 22 (dust)
- Merchant navy requirements of the major international organizations: unified in IACS (International Association of Classification Societies)
- Compliance with European Directives for CE marking:
  - Low voltage: 2014/35/EU
  - Electromagnetic compatibility: 2014/30/EU
  - Machinery: 2006/42/EC

Up-to-date information on which certifications have been obtained is available on our [website](#).

Modicon M580 dPACs are considered as open equipment and are designed for use in industrial environments, in pollution degree 2, overvoltage category II (IEC 60664-1), and in low-voltage installations, where the main power branch is protected on both wires by devices such as fuses or circuit breakers limiting the current to 15 A for North America and 16 A for the rest of the world.

**Characteristics**

**Service conditions and recommendations relating to the environment**

		Modicon M580 dPAC automation platform	Modicon M580 dPAC harsh I/O platform
<b>Temperature</b>	Operation	0...60 °C/32...140 °F	-25...+70 °C/-13...158 °F
	Storage	-40...85 °C/-40...185 °F	-40...85 °C/-40...185 °F
<b>Relative humidity</b> (without condensation)	Cyclical humidity	5...95% up to 55 °C/131 °F	5...95% up to 55 °C/131 °F
	Continuous humidity	5...93% up to 55 °C/131 °F	5...93% up to 60 °C/140 °F
<b>Altitude</b>	Operation	0...2,000 m/0...6,562 ft (full specification: temperature and isolation) 2,000...5,000 m/6,562...16,404 ft (temperature derating: approx. 1 °C/400 m (33.8 °F/1,312 ft), isolation 150 V/1,000 m (3,281 ft)) For accurate temperature derating calculation, refer to IEC 61131-2 Ed 4.0 Annex A	

**Modicon X80 I/O power supply modules**

		BMXCPS2010	BMXCPS3020 BMXCPS3020H	BMXCPS3540T	BMXCPS2000	BMXCPS3500 BMXCPS3500H BMXCPS4002
<b>Supply voltage</b>	Nominal voltage	24 V $\overline{\text{---}}$	24...48 V $\overline{\text{---}}$	125 V $\overline{\text{---}}$	100...240 V $\sim$	100...240 V $\sim$
	Limit voltages	18...31.2 V $\overline{\text{---}}$	18...62.4 V $\overline{\text{---}}$	100...150 V $\overline{\text{---}}$	85...264 V $\sim$	85...264 V $\sim$
	Nominal frequencies	–	–	–	50/60 Hz	50/60 Hz
	Limit frequencies	–	–	–	47/63 Hz	47/63 Hz

#### Protective treatment of the Modicon M580 dPAC automation platform

The Modicon M580 dPAC platform meets the requirements of "TC" treatment (treatment for all climates).

For installations in industrial production workshops or environments corresponding to "TH" treatment (treatment for hot and humid environments), Modicon M580 dPAC must be embedded in enclosures with minimum IP54 protection.

The Modicon M580 dPAC platform offers **protection to IP20 level** and **protection against access to terminals** (enclosed equipment) (1). They can therefore be installed without an enclosure in reserved-access areas that do not exceed **pollution level 2** (control room with no dust-producing machine or activity). Pollution level 2 does not take account of more severe environmental conditions: air pollution by dust, smoke, corrosive or radioactive particles, vapors or salts, molds, insects, etc.

(1) In cases where a slot is not occupied by a module, a **BMXXEM010** protective cover must be installed.

(CE): Tests required by European directives (CE) and based on IEC/EN 61131-2 standards.

#### Environment tests

##### Immunity to LF interference (CE) (1)

Name of test	Standards	Levels
Voltage and frequency variations	IEC/EN 61131-2; IEC/EN 61000-6-2; IEC 61000-4-11	0.85...1.10 Un - 0.94...1.04 Fn; 4 steps t = 30 min
	IACS E10; IEC 61000-4-11	0.80 Un...0.90 Fn; 1.20 Un...1.10 Fn; t = 1.5 s/5 s
Direct voltage variations	IEC/EN 61131-2; IEC 61000-4-29; IACS E10 (PLC not connected to charging battery)	0.85...1.2 Un + ripple: 5% peak; 2 steps t = 30 min
Third harmonic	IEC/EN 61131-2	H3 (10% Un), 0°/180°; 2 steps t = 5 min
Voltage interruptions	IEC/EN 61131-2; IEC/EN 61000-6-2; IEC 61000-4-11; IEC 61000-4-29; IACS E10	Power supply immunity: ■ 10 ms for ~ and --- PS2 (20 ms DS criteria) ■ Check operating mode for longer interruptions up to 5 s, 85% Un ■ For IACS, 3 times 30 s in 5 min, 85% Un
	IEC/EN 61131-2; IEC/EN 61000-6-2; IEC 61000-4-11	For ~ PS2: ■ 20% Un, t0: ½ period ■ 40% Un, cycle 10/12 ■ 70% Un, cycle 25/30 ■ 0% Un, cycle 250/300
Voltage shut-down and start-up	IEC/EN 61131-2	■ Un...0...Un; t = Un/60 s ■ Umin...0...Umin; t = Umin/5 s ■ Umin...0.9 Udl...Umin; t = Umin/60 s
Magnetic field	IEC/EN 61131-2; IEC 61000-4-8 (for MV power stations: IEC 61000-6-5; IEC 61850-3)	Power frequency: 50/60 Hz, 100 A/m continuous ...1,000 A/m; t = 3 s; 3 axes
	IEC 61000-4-10	Oscillatory: 100 kHz...1 MHz, 100 A/m; t = 9 s; 3 axes
Conducted common mode disturbances range 0 Hz ...150 kHz	IEC 61000-4-16 (for MV power stations: IEC 61000-6-5; IEC 61850-3)	For remote systems: ■ 50/60 Hz and ---, 300 V, t = 1 s ■ 50/60 Hz and ---, 30 V, t = 1 min ■ 5 Hz...150 kHz, sweep 3 V...30 ■ For ~: 10 V ■ For ---: 10 V cont. or 100 V, t = 1 s

Where:

- PS1 applies to PLC supplied by battery, PS2 applies to PLC energized from ~ or --- supplies
- Un: nominal voltage; Fn: nominal frequency; Udl: detection level with power on

(1) Devices must be installed, wired, and maintained in accordance with the instructions provided in the manual "Grounding and Electromagnetic Compatibility of PLC Systems".

(2) These tests are performed without an enclosure, with devices fixed on a metal grid and wired as per the recommendations in the manual "Grounding and Electromagnetic Compatibility of PLC systems".

(CE): Tests required by European directives (CE) and based on IEC/EN 61131-2 standards.



BMECRD0100

#### Modicon CRD, I/O bus over Ethernet for Simplex/High Availability Soft dPAC (Linux OS)

RSTP Communication ports	Service ports	Reference	Weight kg/lb
2	1	BMECRD0100 BMECRD0100C	0.848/ 1.872

#### Standards and certifications

The Modicon CRD platform has been developed to comply with the principal national and international standards concerning electronic equipment for industrial automation systems.

- Requirements specific to programmable controllers: functional characteristics, immunity, resistance, etc.: IEC/EN 61131-2 and IEC/EN/UL/CSA 61010-2-201
- Requirements specific to power utility automation systems: IEC/EN 61000-6-5, IEC/EN 61850-3 (with installation restrictions)
- Requirements specific to railway applications: EN 50155/IEC 60571 (with installation restrictions)
- Ex areas:
  - For USA and Canada: Hazardous location class I, division 2, groups A, B, C, and D
  - For other countries: CE ATEX (2014/34/EU) or IECEx in defined atmosphere Zone 2 (gas) and/or Zone 22 (dust)
- Merchant navy requirements of the major international organizations: unified in IACS (International Association of Classification Societies)
- Compliance with European Directives for CE marking:
  - Low voltage: 2014/35/EU
  - Electromagnetic compatibility: 2014/30/EU
  - Machinery: 2006/42/EC

Up-to-date information on which certifications have been obtained is available on our [website](#).

Modicon CRD is considered as open equipment and are designed for use in industrial environments, in pollution degree 2, overvoltage category II (IEC 60664-1), and in low-voltage installations, where the main power branch is protected on both wires by devices such as fuses or circuit breakers limiting the current to 15 A for North America and 16 A for the rest of the world.

#### Characteristics

##### Service conditions and recommendations relating to the environment

		Modicon CRD automation platform	Modicon CRD harsh I/O platform
<b>Temperature</b>	Operation	0...60 °C/32...140 °F	-25...+70 °C/-13...158 °F
	Storage	-40...85 °C/-40...185 °F	-40...85 °C/-40...185 °F
<b>Relative humidity</b> (without condensation)	Cyclical humidity	5...95% up to 55 °C/131 °F	5...95% up to 55 °C/131 °F
	Continuous humidity	5...93% up to 55 °C/131 °F	5...93% up to 60 °C/140 °F
<b>Altitude</b>	Operation	0...2,000 m/0...6,562 ft (full specification: temperature and isolation) 2,000...5,000 m/6,562...16,404 ft (temperature derating: approx. 1 °C/400 m (33.8 °F/1,312 ft), isolation 150 V/1,000 m (3,281 ft)) For accurate temperature derating calculation, refer to IEC 61131-2 Ed 4.0 Annex A	

		Modicon X80 I/O power supply modules				
		BMXCPS2010	BMXCPS3020 BMXCPS3020H	BMXCPS3540T	BMXCPS2000	BMXCPS3500 BMXCPS3500H BMXCPS4002 BMXCPS4002S BMXCPS4002H
<b>Supply voltage</b>	Nominal voltage	24 V $\overline{\text{---}}$	24...48 V $\overline{\text{---}}$	125 V $\overline{\text{---}}$	100...240 V $\sim$	100...240 V $\sim$
	Limit voltages	18...31.2 V $\overline{\text{---}}$	18...62.4 V $\overline{\text{---}}$	100...150 V $\overline{\text{---}}$	85...264 V $\sim$	85...264 V $\sim$
	Nominal frequencies	–	–	–	50/60 Hz	50/60 Hz
	Limit frequencies	–	–	–	47/63 Hz	47/63 Hz



**Protective treatment of the Modicon CRD automation platform**

The Modicon CRD platform meets the requirements of "TC" treatment (treatment for all climates).

For installations in industrial production workshops or environments corresponding to "TH" treatment (treatment for hot and humid environments), Modicon CRD must be embedded in enclosures with minimum IP54 protection.

The Modicon CRD platform offers **protection to IP20 level** and **protection against access to terminals** (enclosed equipment) (1). They can therefore be installed without an enclosure in reserved-access areas that do not exceed **pollution level 2** (control room with no dust-producing machine or activity). Pollution level 2 does not take account of more severe environmental conditions: air pollution by dust, smoke, corrosive or radioactive particles, vapors or salts, molds, insects, etc.

(1) In cases where a slot is not occupied by a module, a **BMXXEM010** protective cover must be installed.

(CE): Tests required by European directives (CE) and based on IEC/EN 61131-2 standards.

**Environment tests**

**Immunity to LF interference (CE) (1)**

Name of test	Standards	Levels
Voltage and frequency variations	IEC/EN 61131-2; IEC/EN 61000-6-2; IEC 61000-4-11	0.85...1.10 Un - 0.94...1.04 Fn; 4 steps t = 30 min
	IACS E10; IEC 61000-4-11	0.80 Un...0.90 Fn; 1.20 Un...1.10 Fn; t = 1.5 s/5 s
Direct voltage variations	IEC/EN 61131-2; IEC 61000-4-29; IACS E10 (PLC not connected to charging battery)	0.85...1.2 Un + ripple: 5% peak; 2 steps t = 30 min
Third harmonic	IEC/EN 61131-2	H3 (10% Un), 0°/180°; 2 steps t = 5 min
Voltage interruptions	IEC/EN 61131-2; IEC/EN 61000-6-2; IEC 61000-4-11; IEC 61000-4-29; IACS E10	Power supply immunity: ■ 10 ms for ~ and --- PS2 (20 ms DS criteria) ■ Check operating mode for longer interruptions up to 5 s, 85% Un ■ For IACS, 3 times 30 s in 5 min, 85% Un
	IEC/EN 61131-2; IEC/EN 61000-6-2; IEC 61000-4-11	For ~ PS2: ■ 20% Un, t0: ½ period ■ 40% Un, cycle 10/12 ■ 70% Un, cycle 25/30 ■ 0% Un, cycle 250/300
Voltage shut-down and start-up	IEC/EN 61131-2	■ Un...0...Un; t = Un/60 s ■ Umin...0...Umin; t = Umin/5 s ■ Umin...0.9 Udl...Umin; t = Umin/60 s
Magnetic field	IEC/EN 61131-2; IEC 61000-4-8 (for MV power stations: IEC 61000-6-5; IEC 61850-3)	Power frequency: 50/60 Hz, 100 A/m continuous ...1,000 A/m; t = 3 s; 3 axes
	IEC 61000-4-10	Oscillatory: 100 kHz...1 MHz, 100 A/m; t = 9 s; 3 axes
Conducted common mode disturbances range 0 Hz ...150 kHz	IEC 61000-4-16 (for MV power stations: IEC 61000-6-5; IEC 61850-3)	For remote systems: ■ 50/60 Hz and ---, 300 V, t = 1 s ■ 50/60 Hz and ---, 30 V, t = 1 min ■ 5 Hz...150 kHz, sweep 3 V...30 ■ For ~: 10 V ■ For ---: 10 V cont. or 100 V, t = 1 s

Where:

- PS1 applies to PLC supplied by battery, PS2 applies to PLC energized from ~ or --- supplies
- Un: nominal voltage; Fn: nominal frequency; Udl: detection level with power on

(1) Devices must be installed, wired, and maintained in accordance with the instructions provided in the manual "Grounding and Electromagnetic Compatibility of PLC Systems".

(2) These tests are performed without an enclosure, with devices fixed on a metal grid and wired as per the recommendations in the manual "Grounding and Electromagnetic Compatibility of PLC systems".

(CE): Tests required by European directives (CE) and based on IEC/EN 61131-2 standards.



TM251MDESE

Modicon M251 dPAC				
Local I/O capacity	Device ports	Service ports	Reference	Weight kg/lb
No embedded I/O, supporting Modicon TM3 I/O expansion modules	2	1	<a href="#">TM251MDESE</a>	0.848/ 1.872

**Standards and certifications**

- Standards
  - IEC/EN 61131-2 (Edition 2 2007)
  - UL508
  - ANSI/ISA 12.12.01-2007
  - CSA C22.2 No. 213 and No. 142
- Certifications
  - C€
  - cULus Listing Mark
  - RCM
  - Achilles
  - UKCA

**Environmental characteristics**

**Service conditions and recommendations relating to the environment**

<b>Temperature</b>	Operation	Vertical installation: -10...35 °C/14...122 °F Horizontal installation: -10...55 °C/14...131 °F
	Storage	-40...70 °C/-40...158 °F
<b>Relative humidity (without condensation)</b>	Operation	10...95%
	Storage	
<b>Altitude</b>	Operation	0...2,000 m/0...6,562 ft: complete specification for temperature and exposure
	Storage	0...3,000 m (0...9,842 ft)
<b>Immunity to mechanical stress</b>	1131	<ul style="list-style-type: none"> <li>■ Rail mounting:                             <ul style="list-style-type: none"> <li><input type="checkbox"/> 5...8.4 Hz (amplitude 3.5 mm/0.138 in.)</li> <li><input type="checkbox"/> 8.4...150 Hz (acceleration 1 g)</li> </ul> </li> <li>■ Panel mounting:                             <ul style="list-style-type: none"> <li><input type="checkbox"/> 8.7...150 Hz (acceleration 3 g)</li> </ul> </li> </ul>
	Merchant Navy	2...13.2 Hz (amplitude 1.0 mm/0.039 in.) 13.2...100 Hz (acceleration 0.7 g)

**Supply charecteristics**

<b>Power supply</b>		24 V ☐
<b>Voltage limit</b>	Including ripple	19.2...28.8 V ☐
<b>Immunity to micro-cuts</b>	Class PS-2	10 ms
<b>Max. consumption</b>		45 W



Modicon M262 dPAC module

Modicon M262 dPAC				
Local I/O capacity	Device ports	Service ports	Reference	Weight kg/lb
No embedded I/O, supporting Modicon TM3 I/O expansion modules	2	1	<a href="#">TM262L01MDESE8T</a>	0.655/ 1.444

#### Standards and certifications

- Standards
  - IEC/EN 61131-2 (Edition 2 2007)
  - UL 61010-1, 61010-2-201
  - ANSI/ISA 12.12.01-2007
  - CSA C22.2 No. 213, No. 61010-1, No. 61010-2-201
- Certifications
  - CE
  - cULus, cULus HazLoc Class I Division 2 CSA 22-2 No 213
  - RCM
  - Achilles
  - KC
  - EAC

#### Environmental characteristics

##### Service conditions and recommendations relating to the environment

<b>Temperature</b>	Operation	Vertical installation: -20...50 °C/-4...122 °F Horizontal installation: -20...60 °C/-4...140 °F Flat mounting: -20...45 °C/-4...113 °F
	Storage	-40...85 °C/-40...185 °F
<b>Relative humidity</b> (without condensation)	Operation	5...95%
	Storage	
<b>Altitude</b>	Operation	0...2,000 m/0...6,562 ft
	Storage	0...3,000 m (0...9,842 ft)
<b>Immunity to mechanical stress</b>		3.5 mm at 2...8.4 Hz 1 gn at 8.4...200 Hz

#### Supply characteristics

<b>Power supply</b>	24 V $\overline{\text{---}}$ (-15...20%)
<b>Voltage limit</b>	20.4...28.8 V $\overline{\text{---}}$
<b>Immunity to micro-cuts</b>	0.01 ms
<b>Max. consumption</b>	82 W



VW3A3530D

Altivar ATV dPAC				
ATV dPAC module				
Local I/O capacity	Device ports	Service ports	Reference	Weight kg/lb
Supporting Altivar Drives I/O embedded, expansion and encoder modules: <ul style="list-style-type: none"> <li>■ Up to 23 discrete I/O</li> <li>■ Up to 7 analog I/O</li> <li>■ 12 MB integrated memory</li> </ul>	2	–	VW3A3530D	0.020/ 0.044

**Standards and certifications**

Depending on the specific drive type used for ATV dPAC integration, the standards and certifications must be checked in the corresponding ATV340/600/900 manual.

- Standards
  - EN/IEC 61800-3
  - EN/IEC 61800-5-1
  - IEC 61000-3-12
  - IEC 60721-3
  - IEC 61508
  - SEMI F47-0706
  - UL508C and UL61800-5-1
  - RoHS-2 according to EU directive 2002/95/EC
  - REACH according to EU regulation 1907/2006
- Certifications
  - CE
  - UL
  - CSA
  - RCM
  - EAC
  - ATEX
  - DNV-GL

**Environmental characteristics**

Altivar Process and Altivar Machine drives are designed to operate in a variety of environments, including harsh environments. The conditions stated below are general data and must be verified with the respective ATV600, ATV900, and ATV340 manuals for the specific drive type used.

**Service conditions and recommendations relating to the environment**

<b>Temperature</b>	Operation	As standard: -15...50 °C/+5...122 °F With derating: -15...60 °C/+5...140 °F
	Storage and transport	-40...70 °C/-40...158 °F
<b>Relative humidity</b> (without condensation)	Operation	5...95%
	Storage	
<b>Altitude</b>	Operation	<ul style="list-style-type: none"> <li>■ 0...1,000 m/0...3,281 ft without derating</li> <li>■ 1,000...4,800 m/3,281...15,700 ft with derating of 1% per 100 m/328 ft</li> </ul>
		Protection of drives
<b>Withstand to harsh environment</b>		<ul style="list-style-type: none"> <li>■ Chemical class 3C3 conforming to IEC/EN 60721-3-3</li> <li>■ Mechanical class 3S3 conforming to IEC/EN 60721-3-3</li> <li>■ Printed circuit boards with protective coating</li> </ul>

**Environmental characteristics**

Compliance with electromagnetic compatibility requirements has been incorporated into the design of Altivar Process and Altivar Machine drives. They are CE marked according to the European EMC directive (2014/30/EU).

*Note: Depending on the specific drive type used for ATV dPAC integration, the EMC compliance values must be checked in the corresponding ATV340/600/900 manual.*



VW3A1111

Graphic display terminal			
Description	Reference	Weight kg/lb	
To be used with ATV340 (ATV600 and ATV900 are equipped with the graphic display terminal as standard) Display 240 x 160 pixels, 8 lines Real-time clock with 10-year backup battery, to keep time when the drive is powered off Protection IP65 To be procured separately for ATV340 (delivered as standard with ATV600 and ATV900)	VW3A1111	0.020/ 0.044	



VW3A1112

Remote mounting kit			
Description	Reference	Weight kg/lb	
Remote mounting kit For remote mounting of graphic display terminal, suitable for ATV340, ATV600, and ATV900 families Protection IP65	VW3A1112	0.020/ 0.044	



VW3A1104R10

Remote mounting cordset			
Description	Length (m/ft)	Reference	Weight kg/lb
Remote mounting cordset Equipped with 2 RJ45 connectors for connection of the graphic display terminal to the drive	1/ 3.28	VW3A1104R10	0.050/ 0.110
	3/ 9.84	VW3A1104R30	0.150/ 0.331
	5/ 16.4	VW3A1104R50	0.250/ 0.551
	10/ 32.8	VW3A1104R100	0.500/ 1.102



TCSXCNAMUM3P

Connector cable			
Description	Length (m/ft)	Reference	Weight kg/lb
USB/Mini B USB cable for connecting the display terminal to a PC	—	TCSXCNAMUM3P	—

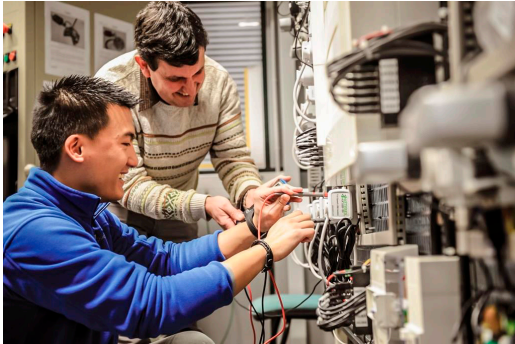

Schneider Electric offers lifecycle services for your industrial automation systems based on EcoStruxure Automation Expert. Our lifecycle services include field and digital services. We believe, with our advanced processes and tools, we are your trusted expert in field and digital services to help you achieve greater functional safety, efficiency, sustainability, and resilience in your plant operations.

We offer services that are designed to address your needs as you plan, install, operate, and optimize your industrial automation systems based on EcoStruxure Automation Expert. These include:

- Consulting services
- Maintenance and support services
- Training Services
- Migration Services

For more information, visit our [Industrial Automation Services page](#).

## Consulting services

Consulting services are about bringing our expertise to help find solutions to some of your key operational challenges. Be it about maximizing the business value from your digital transformation initiatives, identifying improvement opportunities in your industrial automation system lifecycle management plans, or improving your cybersecurity posture and compliance, we can help. Take a look at some of our consulting offerings:

### Security consulting

Our cybersecurity consultants will help you assess and review your EcoStruxure Automation Expert systems to detect gaps, identify risks, uncover any security malpractices, assess your staff's security competencies, provide emergency response services, and more. For more information, visit our [Cybersecurity Services page](#).

### IA lifecycle consulting

Audits performed by our service team provide insights and recommendations to help improve the maintenance plans of industrial automation assets. This service helps identify potential risks to the reliability and maintainability of these assets and plan mitigation actions. Watch the video to learn more about our [IA Lifecycle Consulting Service](#).

## Maintenance and support services

Our maintenance and support offerings help you quickly restore your operations in the event of an unplanned downtime incident. They can also help reduce the risk of occurrence and the associated costs. Take a look at some of our maintenance and support offerings:

### Extended warranty

The extended warranty offer gives you the option to extend the warranty of selected Schneider Electric hardware by up to three years.

*Note: Please contact your Customer Care Center for offer availability.*

### Spare parts, exchanges, and repairs

These solutions help you to respond, in the most optimal manner, to requests for spare parts for your EcoStruxure Automation Expert system based on Schneider Electric hardware. Services include:

- Parts management service:
  - Onsite or shared spares inventory, managed by us, to help ensure parts availability, while optimizing costs.
- Repair:
  - Product repairs performed onsite when possible, or at our repair centers.
- Exchange:
  - A refurbished product is provided in exchange for a product returned with a detected fault.

*Note: Availability of these services may vary depending on the applicable Schneider Electric hardware. Please contact your Customer Care Center for offer availability.*

## Maintenance and support services (continued)

### Maintenance and support contracts

Our Support and Maintenance Service Offers, are a simplified and modular annual support services agreements, designed to provide you with the right level of flexibility and confidence to meet your support and maintenance needs for your industrial automation systems based on EcoStruxure Automation Expert.

Available as Advantage Service Plan (ASP) for Automation Control or as Customer FIRST (CF) Program for Automation Control, they offer a pre-packaged set of services relevant to operating & maintaining an EcoStruxure Automation Expert Systems. For further customization, a set of optional services are available.

The following table provides a snapshot of the plan:

Included Services	Support Levels	
	ASP	CF
	Essential	Primary
<b>Core Support and Services</b>		
Priority Technical Support Access – NBH <sup>(a)</sup>	SLA <sup>(b)</sup>	SLA <sup>(b)</sup>
mySchneider Portal Access – <i>Premium support</i>	Yes	Yes
Software Version Update <sup>(c)</sup>	Yes	Yes
<b>Optional services<sup>(d)</sup></b>		
24/7 Priority Technical Support – Phone		
Block of Support Hours		

(a) Normal Business Hours

(b) Service Level Agreement

(c) Excludes labor and hardware

(d) Subject to local availability

With the enhancements to EcoStruxure Automation Expert V24.0 licensing system, we will progressively offer a more digital experience for customers seeking to maintain the currency of their EcoStruxure Automation Expert software. With this experience, customers with our support and maintenance service offers, will be able to update, in a self-service mode, their EcoStruxure Automation Expert software installation, as and when installations are ready. Please contact your Customer Care Center for offer availability.

## Training services

Our training services are designed for users to take maximum advantage of our industrial automation systems based on EcoStruxure Automation Expert. Our training catalog includes courses on:

- Automation fundamentals
- IEC 61499 concepts
- EcoStruxure Automation Expert engineering and configuration

For more information, please visit our [Learning Services Home Page](#) or send us an [email](#).

## Modernization and migration services

Over the years, we have been involved in migrating many major automation systems to Schneider Electric. Our migration services, based on this expertise and complemented by a set of dedicated tools, helps to minimize the risks and costs involved in such upgrades to an open EcoStruxure Automation Expert-based system. The available set of tools and services are outlined below:

### Tools and services

Source platforms		Tools and services		
		Reverse engineering	Application conversion service	Wiring systems for Modicon X80
Schneider Electric	Modicon Premium	Yes	2023	Yes
Rockwell Automation	SLC 500	Yes	Yes	Yes
	PLC-5	Yes	Yes	Yes
	ControlLogix	Yes	2023	–

In addition to the above, we can also offer project-specific solutions. Please contact your local service teams for more information.



A					
ATV340D11N4	31	ATV650D11N4E	31	ATV680C13T4X1	31
ATV340D11N4E	31	ATV650D15N4	31	ATV680C16Q4X1	31
ATV340D15N4	31	ATV650D15N4E	31	ATV680C16T4X1	31
ATV340D15N4E	31	ATV650D18N4	31	ATV680C20Q4X1	31
ATV340D18N4	31	ATV650D18N4E	31	ATV680C20T4X1	31
ATV340D18N4E	31	ATV650D22N4	31	ATV680C25Q4X1	31
ATV340D22N4	31	ATV650D22N4E	31	ATV680C25T4X1	31
ATV340D22N4E	31	ATV650D30N4	31	ATV680C31Q4X1	31
ATV340D30N4E	31	ATV650D30N4E	31	ATV680C31T4X1	31
ATV340D37N4E	31	ATV650D37N4	31	ATV680C35Q4X1	31
ATV340D45N4E	31	ATV650D37N4E	31	ATV680C35T4X1	31
ATV340D55N4E	31	ATV650D45N4	31	ATV680C40Q4X1	31
ATV340D75N4E	31	ATV650D45N4E	31	ATV680C40T4X1	31
ATV340U07N4	31	ATV650D55N4	31	ATV680C45Q4X1	31
ATV340U07N4E	31	ATV650D55N4E	31	ATV680C45T4X1	31
ATV340U15N4	31	ATV650D75N4	31	ATV680C50Q4X1	31
ATV340U15N4E	31	ATV650D75N4E	31	ATV680C50T4X1	31
ATV340U22N4	31	ATV650D90N4	31	ATV680C56Q4X1	31
ATV340U22N4E	31	ATV650D90N4E	31	ATV680C56T4X1	31
ATV340U30N4	31	ATV650U07N4	31	ATV680C63Q4X1	31
ATV340U30N4E	31	ATV650U07N4E	31	ATV680C63T4X1	31
ATV340U40N4	31	ATV650U15N4	31	ATV680C71Q4X1	31
ATV340U40N4E	31	ATV650U15N4E	31	ATV680C71T4X1	31
ATV340U55N4	31	ATV650U22N4	31	ATV680C80Q4X1	31
ATV340U55N4E	31	ATV650U22N4E	31	ATV680C80T4X1	31
ATV340U75N4	31	ATV650U30N4	31	ATV6A0C11N6	31
ATV340U75N4E	31	ATV650U30N4E	31	ATV6A0C11Q4	31
ATV630C11N4	31	ATV650U40N4	31	ATV6A0C11Q6	31
ATV630C11N4F	31	ATV650U40N4E	31	ATV6A0C11R4	31
ATV630C13N4	31	ATV650U55N4	31	ATV6A0C11S6	31
ATV630C13N4F	31	ATV650U55N4E	31	ATV6A0C11T4	31
ATV630C16N4	31	ATV650U75N4	31	ATV6A0C11T6	31
ATV630C16N4F	31	ATV650U75N4E	31	ATV6A0C13N6	31
ATV630C20N4F	31	ATV660C11Q4X1	31	ATV6A0C13Q4	31
ATV630C22N4	31	ATV660C11T4X1	31	ATV6A0C13Q6	31
ATV630C25N4	31	ATV660C13Q4X1	31	ATV6A0C13R4	31
ATV630C25N4F	31	ATV660C13T4X1	31	ATV6A0C13S6	31
ATV630C31N4	31	ATV660C16Q4X1	31	ATV6A0C13T4	31
ATV630C31N4F	31	ATV660C16T4X1	31	ATV6A0C13T6	31
ATV630D11N4	31	ATV660C20Q4X1	31	ATV6A0C16N6	31
ATV630D15N4	31	ATV660C20T4X1	31	ATV6A0C16Q4	31
ATV630D18N4	31	ATV660C25Q4X1	31	ATV6A0C16Q6	31
ATV630D22N4	31	ATV660C25T4X1	31	ATV6A0C16R4	31
ATV630D30N4	31	ATV660C31Q4X1	31	ATV6A0C16S6	31
ATV630D37N4	31	ATV660C31T4X1	31	ATV6A0C16T4	31
ATV630D45N4	31	ATV660C35Q4X1	31	ATV6A0C16T6	31
ATV630D55N4	31	ATV660C35T4X1	31	ATV6A0C20N6	31
ATV630D75N4	31	ATV660C40Q4X1	31	ATV6A0C20Q4	31
ATV630D90N4	31	ATV660C40T4X1	31	ATV6A0C20Q6	31
ATV630U07N4	31	ATV660C45Q4X1	31	ATV6A0C20R4	31
ATV630U15N4	31	ATV660C45T4X1	31	ATV6A0C20S6	31
ATV630U22N4	31	ATV660C50Q4X1	31	ATV6A0C20T4	31
ATV630U30N4	31	ATV660C50T4X1	31	ATV6A0C20T6	31
ATV630U40N4	31	ATV660C56Q4X1	31	ATV6A0C25N6	31
ATV630U55N4	31	ATV660C56T4X1	31	ATV6A0C25Q4	31
ATV630U75N4	31	ATV660C63Q4X1	31	ATV6A0C25Q6	31
ATV650C11N4F	31	ATV660C63T4X1	31	ATV6A0C25R4	31
ATV650C13N4F	31	ATV660C71Q4X1	31	ATV6A0C25T4	31
ATV650C16N4F	31	ATV660C71T4X1	31	ATV6A0C25T6	31
ATV650C20N4F	31	ATV660C80Q4X1	31	ATV6A0C31N6	31
ATV650C25N4F	31	ATV660C80T4X1	31	ATV6A0C31Q4	31
ATV650C31N4F	31	ATV680C11Q4X1	31	ATV6A0C31Q6	31
ATV650D11N4	31	ATV680C11T4X1	31	ATV6A0C31R4	31
		ATV680C13Q4X1	31	ATV6A0C31T4	31

ATV6B0C20N6	31	ATV6L0C13R4	31	ATV6L0M14T6	31	ATV950D15N4E	31
ATV6B0C20Q4	31	ATV6L0C13T4	31	ATV6L0M15Q4	31	ATV950D18N4	31
ATV6B0C20Q6	31	ATV6L0C16Q4	31	ATV6L0M15R4	31	ATV950D18N4E	31
ATV6B0C20R4	31	ATV6L0C16R4	31	ATV6L0M15T4	31	ATV950D22N4	31
ATV6B0C20T4	31	ATV6L0C16T4	31	ATV6L0M16N6	31	ATV950D22N4E	31
ATV6B0C20T6	31	ATV6L0C20N6	31	ATV6L0M16Q6	31	ATV950D30N4	31
ATV6B0C25N6	31	ATV6L0C20Q4	31	ATV6L0M16T6	31	ATV950D30N4E	31
ATV6B0C25Q4	31	ATV6L0C20Q6	31	ATV6L0M18N6	31	ATV950D37N4	31
ATV6B0C25Q6	31	ATV6L0C20R4	31	ATV6L0M18Q4	31	ATV950D37N4E	31
ATV6B0C25R4	31	ATV6L0C20T4	31	ATV6L0M18Q6	31	ATV950D45N4	31
ATV6B0C25T4	31	ATV6L0C20T6	31	ATV6L0M18R4	31	ATV950D45N4E	31
ATV6B0C25T6	31	ATV6L0C25Q4	31	ATV6L0M18T4	31	ATV950D55N4	31
ATV6B0C31N6	31	ATV6L0C25R4	31	ATV6L0M18T6	31	ATV950D55N4E	31
ATV6B0C31Q4	31	ATV6L0C25T4	31	ATV6L0M22N6	31	ATV950D75N4	31
ATV6B0C31Q6	31	ATV6L0C28N6	31	ATV6L0M22Q6	31	ATV950D75N4E	31
ATV6B0C31R4	31	ATV6L0C28Q6	31	ATV6L0M22T6	31	ATV950D90N4	31
ATV6B0C31T4	31	ATV6L0C28T6	31	ATV6L0M26N6	31	ATV950D90N4E	31
ATV6B0C31T6	31	ATV6L0C31N6	31	ATV6L0M26Q6	31	ATV950U07N4	31
ATV6B0C35Q4	31	ATV6L0C31Q4	31	ATV6L0M26T6	31	ATV950U07N4E	31
ATV6B0C35R4	31	ATV6L0C31Q6	31	ATV930C11N4	31	ATV950U15N4	31
ATV6B0C35T4	31	ATV6L0C31R4	31	ATV930C11N4C	31	ATV950U15N4E	31
ATV6B0C40N6	31	ATV6L0C31T4	31	ATV930C11N4F	31	ATV950U22N4	31
ATV6B0C40Q4	31	ATV6L0C31T6	31	ATV930C13N4	31	ATV950U22N4E	31
ATV6B0C40Q6	31	ATV6L0C40N6	31	ATV930C13N4C	31	ATV950U30N4	31
ATV6B0C40R4	31	ATV6L0C40Q4	31	ATV930C13N4F	31	ATV950U30N4E	31
ATV6B0C40T4	31	ATV6L0C40Q6	31	ATV930C16N4	31	ATV950U40N4	31
ATV6B0C40T6	31	ATV6L0C40R4	31	ATV930C16N4C	31	ATV950U40N4E	31
ATV6B0C45Q4	31	ATV6L0C40T4	31	ATV930C16N4F	31	ATV950U55N4	31
ATV6B0C45R4	31	ATV6L0C40T6	31	ATV930C20N4F	31	ATV950U55N4E	31
ATV6B0C45T4	31	ATV6L0C45N6	31	ATV930C22N4	31	ATV950U75N4	31
ATV6B0C50N6	31	ATV6L0C45Q6	31	ATV930C22N4C	31	ATV950U75N4E	31
ATV6B0C50Q4	31	ATV6L0C45T6	31	ATV930C25N4C	31	ATV960C11Q4X1	31
ATV6B0C50Q6	31	ATV6L0C50Q4	31	ATV930C25N4F	31	ATV960C11T4X1	31
ATV6B0C50R4	31	ATV6L0C50R4	31	ATV930C31N4C	31	ATV960C13Q4X1	31
ATV6B0C50T4	31	ATV6L0C50T4	31	ATV930C31N4F	31	ATV960C13T4X1	31
ATV6B0C50T6	31	ATV6L0C56N6	31	ATV930D11N4	31	ATV960C16Q4X1	31
ATV6B0C56Q4	31	ATV6L0C56Q6	31	ATV930D15N4	31	ATV960C16T4X1	31
ATV6B0C56R4	31	ATV6L0C56T6	31	ATV930D18N4	31	ATV960C20Q4X1	31
ATV6B0C56T4	31	ATV6L0C63Q4	31	ATV930D22N4	31	ATV960C20T4X1	31
ATV6B0C63N6	31	ATV6L0C63R4	31	ATV930D30N4	31	ATV960C25Q4X1	31
ATV6B0C63Q4	31	ATV6L0C63T4	31	ATV930D37N4	31	ATV960C25T4X1	31
ATV6B0C63Q6	31	ATV6L0C71N6	31	ATV930D45N4	31	ATV960C31Q4X1	31
ATV6B0C63R4	31	ATV6L0C71Q6	31	ATV930D55N4	31	ATV960C31T4X1	31
ATV6B0C63T4	31	ATV6L0C71T6	31	ATV930D55N4C	31	ATV960C35Q4X1	31
ATV6B0C63T6	31	ATV6L0C80Q4	31	ATV930D75N4	31	ATV960C35T4X1	31
ATV6B0C71Q4	31	ATV6L0C80R4	31	ATV930D75N4C	31	ATV960C40Q4X1	31
ATV6B0C71R4	31	ATV6L0C80T4	31	ATV930D90N4	31	ATV960C40T4X1	31
ATV6B0C71T4	31	ATV6L0C90N6	31	ATV930D90N4C	31	ATV960C45Q4X1	31
ATV6B0C80N6	31	ATV6L0C90Q4	31	ATV930U07N4	31	ATV960C45T4X1	31
ATV6B0C80Q4	31	ATV6L0C90Q6	31	ATV930U15N4	31	ATV960C50Q4X1	31
ATV6B0C80Q6	31	ATV6L0C90R4	31	ATV930U22N4	31	ATV960C50T4X1	31
ATV6B0C80R4	31	ATV6L0C90T4	31	ATV930U30N4	31	ATV960C56Q4X1	31
ATV6B0C80T4	31	ATV6L0C90T6	31	ATV930U40N4	31	ATV960C56T4X1	31
ATV6B0C80T6	31	ATV6L0M10Q4	31	ATV930U55N4	31	ATV960C63Q4X1	31
ATV6B0M10N6	31	ATV6L0M10R4	31	ATV930U75N4	31	ATV960C63T4X1	31
ATV6B0M10Q4	31	ATV6L0M10T4	31	ATV950C11N4F	31	ATV960C71Q4X1	31
ATV6B0M10Q6	31	ATV6L0M12N6	31	ATV950C13N4F	31	ATV960C71T4X1	31
ATV6B0M10R4	31	ATV6L0M12Q4	31	ATV950C16N4F	31	ATV960C80Q4X1	31
ATV6B0M10T4	31	ATV6L0M12Q6	31	ATV950C20N4F	31	ATV960C80T4X1	31
ATV6B0M10T6	31	ATV6L0M12R4	31	ATV950C25N4F	31	ATV980C11Q4X1	31
ATV6B0M12N6	31	ATV6L0M12T4	31	ATV950C31N4F	31	ATV980C11T4X1	31
ATV6B0M12Q6	31	ATV6L0M12T6	31	ATV950D11N4	31	ATV980C13Q4X1	31
ATV6B0M12T6	31	ATV6L0M14N6	31	ATV950D11N4E	31	ATV980C13T4X1	31
ATV6L0C13Q4	31	ATV6L0M14Q6	31	ATV950D15N4	31	ATV980C16Q4X1	31

ATV980C16T4X1	31	ATV9A0C35R4	31	ATV9B0C20Q6	31	ATV9L0C16Q4	31
ATV980C20Q4X1	31	ATV9A0C35T4	31	ATV9B0C20R4	31	ATV9L0C16R4	31
ATV980C20T4X1	31	ATV9A0C40N6	31	ATV9B0C20T4	31	ATV9L0C16T4	31
ATV980C25Q4X1	31	ATV9A0C40Q4	31	ATV9B0C20T6	31	ATV9L0C20N6	31
ATV980C25T4X1	31	ATV9A0C40Q6	31	ATV9B0C25N6	31	ATV9L0C20Q4	31
ATV980C31Q4X1	31	ATV9A0C40R4	31	ATV9B0C25Q4	31	ATV9L0C20Q6	31
ATV980C31T4X1	31	ATV9A0C40T4	31	ATV9B0C25Q6	31	ATV9L0C20R4	31
ATV980C35Q4X1	31	ATV9A0C40T6	31	ATV9B0C25R4	31	ATV9L0C20T4	31
ATV980C35T4X1	31	ATV9A0C45Q4	31	ATV9B0C25T4	31	ATV9L0C20T6	31
ATV980C40Q4X1	31	ATV9A0C45R4	31	ATV9B0C25T6	31	ATV9L0C25Q4	31
ATV980C40T4X1	31	ATV9A0C45T4	31	ATV9B0C31N6	31	ATV9L0C25R4	31
ATV980C45Q4X1	31	ATV9A0C50N6	31	ATV9B0C31Q4	31	ATV9L0C25T4	31
ATV980C45T4X1	31	ATV9A0C50Q4	31	ATV9B0C31Q6	31	ATV9L0C28N6	31
ATV980C50Q4X1	31	ATV9A0C50Q6	31	ATV9B0C31R4	31	ATV9L0C28Q6	31
ATV980C50T4X1	31	ATV9A0C50R4	31	ATV9B0C31T4	31	ATV9L0C28T6	31
ATV980C56Q4X1	31	ATV9A0C50T4	31	ATV9B0C31T6	31	ATV9L0C31N6	31
ATV980C56T4X1	31	ATV9A0C50T6	31	ATV9B0C35Q4	31	ATV9L0C31Q4	31
ATV980C63Q4X1	31	ATV9A0C56Q4	31	ATV9B0C35R4	31	ATV9L0C31Q6	31
ATV980C63T4X1	31	ATV9A0C56R4	31	ATV9B0C35T4	31	ATV9L0C31R4	31
ATV980C71Q4X1	31	ATV9A0C56T4	31	ATV9B0C40N6	31	ATV9L0C31T4	31
ATV980C71T4X1	31	ATV9A0C63N6	31	ATV9B0C40Q4	31	ATV9L0C31T6	31
ATV980C80Q4X1	31	ATV9A0C63Q4	31	ATV9B0C40Q6	31	ATV9L0C40N6	31
ATV980C80T4X1	31	ATV9A0C63Q6	31	ATV9B0C40R4	31	ATV9L0C40Q4	31
ATV9A0C11N6	31	ATV9A0C63R4	31	ATV9B0C40T4	31	ATV9L0C40Q6	31
ATV9A0C11Q4	31	ATV9A0C63T4	31	ATV9B0C40T6	31	ATV9L0C40R4	31
ATV9A0C11Q6	31	ATV9A0C63T6	31	ATV9B0C45Q4	31	ATV9L0C40T4	31
ATV9A0C11R4	31	ATV9A0C71Q4	31	ATV9B0C45R4	31	ATV9L0C40T6	31
ATV9A0C11S6	31	ATV9A0C71R4	31	ATV9B0C45T4	31	ATV9L0C45N6	31
ATV9A0C11T4	31	ATV9A0C71T4	31	ATV9B0C50N6	31	ATV9L0C45Q6	31
ATV9A0C11T6	31	ATV9A0C80N6	31	ATV9B0C50Q4	31	ATV9L0C45T6	31
ATV9A0C13N6	31	ATV9A0C80Q4	31	ATV9B0C50Q6	31	ATV9L0C50Q4	31
ATV9A0C13Q4	31	ATV9A0C80Q6	31	ATV9B0C50R4	31	ATV9L0C50R4	31
ATV9A0C13Q6	31	ATV9A0C80R4	31	ATV9B0C50T4	31	ATV9L0C50T4	31
ATV9A0C13R4	31	ATV9A0C80T4	31	ATV9B0C50T6	31	ATV9L0C56N6	31
ATV9A0C13S6	31	ATV9A0C80T6	31	ATV9B0C56Q4	31	ATV9L0C56Q6	31
ATV9A0C13T4	31	ATV9A0M10N6	31	ATV9B0C56R4	31	ATV9L0C56T6	31
ATV9A0C13T6	31	ATV9A0M10Q4	31	ATV9B0C56T4	31	ATV9L0C63Q4	31
ATV9A0C16N6	31	ATV9A0M10Q6	31	ATV9B0C63N6	31	ATV9L0C63R4	31
ATV9A0C16Q4	31	ATV9A0M10R4	31	ATV9B0C63Q4	31	ATV9L0C63T4	31
ATV9A0C16Q6	31	ATV9A0M10T4	31	ATV9B0C63Q6	31	ATV9L0C71N6	31
ATV9A0C16R4	31	ATV9A0M10T6	31	ATV9B0C63R4	31	ATV9L0C71Q6	31
ATV9A0C16S6	31	ATV9A0M12N6	31	ATV9B0C63T4	31	ATV9L0C71T6	31
ATV9A0C16T4	31	ATV9A0M12Q6	31	ATV9B0C63T6	31	ATV9L0C80Q4	31
ATV9A0C16T6	31	ATV9A0M12T6	31	ATV9B0C71Q4	31	ATV9L0C80R4	31
ATV9A0C20N6	31	ATV9B0C11N6	31	ATV9B0C71R4	31	ATV9L0C80T4	31
ATV9A0C20Q4	31	ATV9B0C11Q4	31	ATV9B0C71T4	31	ATV9L0C90N6	31
ATV9A0C20Q6	31	ATV9B0C11Q6	31	ATV9B0C80N6	31	ATV9L0C90Q4	31
ATV9A0C20R4	31	ATV9B0C11R4	31	ATV9B0C80Q4	31	ATV9L0C90Q6	31
ATV9A0C20S6	31	ATV9B0C11T4	31	ATV9B0C80Q6	31	ATV9L0C90R4	31
ATV9A0C20T4	31	ATV9B0C11T6	31	ATV9B0C80R4	31	ATV9L0C90T4	31
ATV9A0C20T6	31	ATV9B0C13N6	31	ATV9B0C80T4	31	ATV9L0C90T6	31
ATV9A0C25N6	31	ATV9B0C13Q4	31	ATV9B0C80T6	31	ATV9L0M10Q4	31
ATV9A0C25Q4	31	ATV9B0C13Q6	31	ATV9B0M10N6	31	ATV9L0M10R4	31
ATV9A0C25Q6	31	ATV9B0C13R4	31	ATV9B0M10Q4	31	ATV9L0M10T4	31
ATV9A0C25R4	31	ATV9B0C13T4	31	ATV9B0M10Q6	31	ATV9L0M12N6	31
ATV9A0C25T4	31	ATV9B0C13T6	31	ATV9B0M10R4	31	ATV9L0M12Q4	31
ATV9A0C25T6	31	ATV9B0C16N6	31	ATV9B0M10T4	31	ATV9L0M12Q6	31
ATV9A0C31N6	31	ATV9B0C16Q4	31	ATV9B0M10T6	31	ATV9L0M12R4	31
ATV9A0C31Q4	31	ATV9B0C16Q6	31	ATV9B0M12N6	31	ATV9L0M12T4	31
ATV9A0C31Q6	31	ATV9B0C16R4	31	ATV9B0M12Q6	31	ATV9L0M12T6	31
ATV9A0C31R4	31	ATV9B0C16T4	31	ATV9B0M12T6	31	ATV9L0M14N6	31
ATV9A0C31T4	31	ATV9B0C16T6	31	ATV9L0C13Q4	31	ATV9L0M14Q6	31
ATV9A0C31T6	31	ATV9B0C20N6	31	ATV9L0C13R4	31	ATV9L0M14T6	31
ATV9A0C35Q4	31	ATV9B0C20Q4	31	ATV9L0C13T4	31	ATV9L0M15Q4	31

ATV9L0M15R4	31	BMXDDI1602H	28	EALOMD1	25	TM3XTRA1	30
ATV9L0M15T4	31	BMXDDI3202K	28	EALOMD2	25	TM3XTYS4	30
ATV9L0M16N6	31	BMXDDI6402K	28	EALUAOC	22	<b>V</b>	
ATV9L0M16Q6	31	BMXDDM16022	29	<b>H</b>		VW3A1104R10	39
ATV9L0M16T6	31	BMXDDM16022H	29	HMIBX1A0NDA	10	VW3A1104R100	39
ATV9L0M18N6	31	BMXDDM16025	28	HMISTM6200	5	VW3A1104R30	39
ATV9L0M18Q4	31	BMXDDM16025H	28	HMISTM6400	5	VW3A1104R50	39
ATV9L0M18Q6	31	BMXDDM3202K	29	<b>T</b>		VW3A1111	31
ATV9L0M18R4	31	BMXDDO1602	28	TCSXCNAMUM3P	39		39
ATV9L0M18T4	31	BMXDDO1602H	29	TM251MDESE	36	VW3A1112	31
ATV9L0M18T6	31	BMXDDO6402K	29	TM262L01MDESE8T	37		39
ATV9L0M22N6	31	BMXDRA0815	29	TM3AG2G	30	VW3A3203	31
ATV9L0M22Q6	31	BMXDRA0815H	29	TM3AI2H	30	VW3A3204	31
ATV9L0M22T6	31	BMXDRA1605	29	TM3AI2HG	30	VW3A3420	31
ATV9L0M26N6	31	BMXDRA1605H	29	TM3AI4	30	VW3A3422	31
ATV9L0M26Q6	31	BMXEAE0300	29	TM3AI4G	30	VW3A3423	31
ATV9L0M26T6	31	BMXEAE0300H	29	TM3AI8	30	VW3A3424	31
<b>B</b>		BMXEHC0800	29	TM3AI8G	30	VW3A3530D	38
BMEAH10812	28	BMXEHC0800H	29	TM3AM6	30		
BMEAH00412	28	BMXNRP0200	29	TM3AM6G	30		
BMECRD0100	34	BMXNRP0201	29	TM3AQ2	30		
BMECRD0100C	34	BMXRMS004GPF	28	TM3AQ4	30		
BMED581020	32	BMXXBC008K	28	TM3AQ4G	30		
BMED581020C	32	BMXXBC015K	28	TM3DI16	30		
BMEXBP0400	28	BMXXBC030K	28	TM3DI16G	30		
BMEXBP0400H	28	BMXXBC050K	28	TM3DI32K	30		
BMEXBP0602	28	BMXXBC120K	28	TM3DI8	30		
BMEXBP0602H	28	BMXXBE1000	28	TM3DI8A	30		
BMEXBP0800	28	BMXXBE1000H	28	TM3DI8G	30		
BMEXBP0800H	28	BMXXBE2005	28	TM3DM24R	30		
BMEXBP1002	28	BMXXBP0400	28	TM3DM24RG	30		
BMEXBP1002H	28	BMXXBP0400H	28	TM3DM8R	30		
BMEXBP1200	28	BMXXBP0600	28	TM3DM8RG	30		
BMEXBP1200H	28	BMXXBP0600H	28	TM3DQ16R	30		
BMXAMI0410	28	BMXXBP0800	28	TM3DQ16RG	30		
BMXAMI0410H	28	BMXXBP0800H	28	TM3DQ16T	30		
BMXAMI0800	28	BMXXBP1200	28	TM3DQ16TG	30		
BMXAMI0810	28	BMXXBP1200H	28	TM3DQ16U	30		
BMXAMI0810H	28	<b>E</b>		TM3DQ16UG	30		
BMXAMM0600	28	EALADP	23	TM3DQ32TK	30		
BMXAMM0600H	28	EALALP	23	TM3DQ32UK	30		
BMXAMO0210	28	EALAMP	23	TM3DQ8R	30		
BMXAMO0210H	28		27	TM3DQ8RG	30		
BMXAMO0410	28	EALANP	23	TM3DQ8T	30		
BMXAMO0410H	28	EALASP	23	TM3DQ8TG	30		
BMXAMO0802	28	EALBAHC	22	TM3DQ8U	30		
BMXART0814	28	EALBATC	22	TM3DQ8UG	30		
BMXART0814H	28	EALBFC	22	TM3SAC5R	30		
BMXCPS2000	28	EALBTC	22	TM3SAC5RG	30		
BMXCPS2010	28	EALBTEP24	22	TM3SAF5R	30		
BMXCPS3020	28	EALBTS1	25	TM3SAF5RG	30		
BMXCPS3020H	28	EALBTS2	25	TM3SAFL5R	30		
BMXCPS3500	28	EALDCP	24	TM3SAFL5RG	30		
BMXCPS3500H	28		27	TM3SAK6R	30		
BMXCPS3522	28	EALDHACP	24	TM3SAK6RG	30		
BMXCPS3540T	28		27	TM3TI4	30		
BMXCPS4002	28	EALDHAMP	24	TM3TI4G	30		
BMXCPS4022	28	EALDHAVMP	24	TM3TI8T	30		
BMXDAI0814	29	EALDHAXP	24	TM3TI8TG	30		
BMXDAI1604	29	EALDMP	24	TM3TM3	30		
BMXDAI1604H	29	EALDVMP	24	TM3TM3G			
BMXDAO1605	29	EALDXP	24	TM3XHSC202	30		
BMXDAO1605H	29	EALH1P	24	TM3XHSC202G	30		
BMXDDI1602	28	EALH2P	24	TM3XREC1	30		
			26				



# mySchneider, your personalized digital experience

Access an all-in-one customized online experience and benefit from tailored business services, resources, and tools to efficiently support your business operations.

- **Efficiency:** In just a few clicks, find all the information and support you need to get the job done.
- **Simplicity:** Use a single login to access all business services, in one place, available 24/7. You no longer need to log in to multiple platforms.
- **Personalization:** Benefit from content, tools, and business services tailored to your activity, and customize your landing page based on your preferences.

## Watch the How-to Videos



### Order management

- > [Select Products and Add to Cart](#)
- > [Check for Products' Price and Availability](#)
- > [Order Products with Generic Commercial References](#)



### Product information

- > [Find a Product Data Sheet and Related Documents](#)
- > [Select Products and Add to Cart](#)
- > [Stay Up to Date on the Status of My Products](#)



### Support

- > [Get Quicker Answers Thanks to Online Support](#)

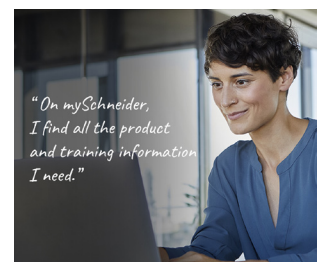

### Training

- > [Access Trainings Dedicated to My Activity](#)

[Create your account](#)

Life Is 

**Schneider**  
Electric

# Legal information

The information provided in this Catalog contains description of Schneider Electric products, solutions and services ("Offer") with technical specifications and technical characteristics of the performance of the corresponding Offer.

The content of this document is subject to revision at any time without notice due to continued progress in methodology, design and manufacturing.

To the extent permitted by applicable law, no responsibility or liability is assumed by Schneider Electric and its subsidiaries for any type of damages arising out of or in connection with (i) informational content of this Catalog not conforming with or exceeding the technical specifications, or (ii) any error contained in this Catalog, or (iii) any use, decision, act or omission made or taken on basis of or in reliance on any information contained or referred to in this Catalog.

SCHNEIDER ELECTRIC MAKES NO WARRANTY OR REPRESENTATION OF ANY KIND, WHETHER EXPRESS OR IMPLIED, AS TO WHETHER THIS CATALOG OR ANY INFORMATION CONTAINED THEREIN SUCH AS PRODUCTS AND SERVICES WILL MEET REQUIREMENTS, EXPECTATIONS OR PURPOSE OF ANY PERSON MAKING USE THEREOF.

Schneider Electric brand and any trademarks of Schneider Electric and its subsidiaries referred to in this Catalog are property of Schneider Electric or its subsidiaries. All other brands are trademarks of their respective owners.

This Catalog and its content are protected under applicable copyright laws and provided for informative use only. No part of this Catalog may be reproduced or transmitted in any form or by any means (electronic, mechanical, photocopying, recording, or otherwise), for any purpose, without the prior written permission of Schneider Electric.

Copyright, intellectual, and all other proprietary rights in the content of this Catalog (including but not limited to software, audio, video, text, and photographs) rests with Schneider Electric or its licensors. All rights in such content not expressly granted herein are reserved. No rights of any kind are licensed or assigned or shall otherwise pass to persons accessing this information.

Life Is On



Learn more about our products at  
[www.se.com](http://www.se.com)

The information provided in this documentation contains general descriptions and/or technical characteristics of the performance of the products contained herein. This documentation is not intended as a substitute for and is not to be used for determining suitability or reliability of these products for specific user applications. It is the duty of any such user or integrator to perform the appropriate and complete risk analysis, evaluation and testing of the products with respect to the relevant specific application or use thereof. Neither Schneider Electric nor any of its affiliates or subsidiaries shall be responsible or liable for misuse of the information contained herein.

Design: Schneider Electric  
Photos: Schneider Electric

**Schneider Electric Industries SAS**

Head Office  
35, rue Joseph Monier - CS 30323  
F-92500 Rueil-Malmaison Cedex  
France

DIA3ED2201101EN  
July 2024 - V8.0