

Installation and Operation Back-UPS™ Pro 700

Inventory

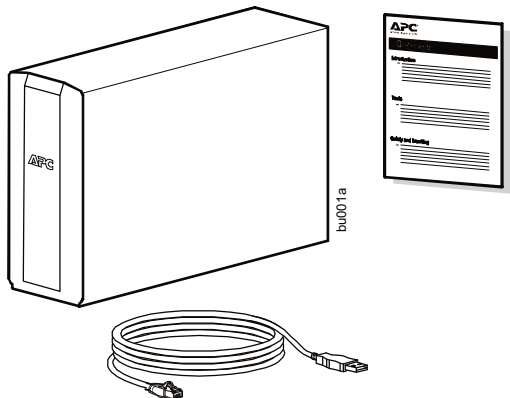

Safety and General Information



Inspect the package contents upon receipt. Notify the carrier and dealer if there is any damage.

Read the Safety Guide supplied with this unit before installing the UPS.

- This UPS is intended for indoor use only.
- Do not operate this UPS in direct sunlight, in contact with fluids, or where there is excessive dust or humidity.
- Be sure the air vents on the UPS are not blocked. Allow adequate space for proper ventilation.
- The battery typically lasts for three to five years. Environmental factors impact battery life. Elevated ambient temperatures, poor quality AC power, and frequent short duration discharges will shorten battery life.
- Connect the UPS power cable directly to a wall outlet. Do not use surge protectors or extension cords.

Connect the Battery

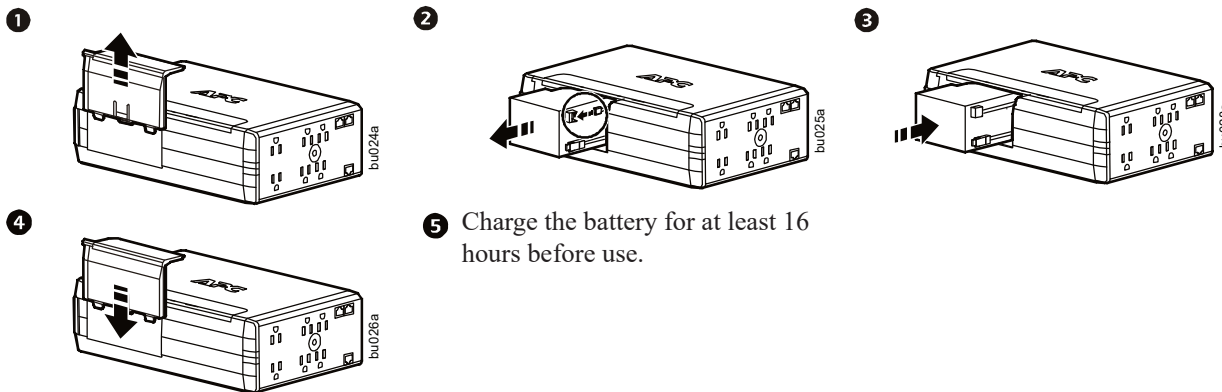

Install PowerChute™ Personal Edition Software

1. Connect the supplied USB software interface cable to the data port, and the other end to a computer with access to the internet.
2. Go to www.apc.com/pcpe
3. Select PowerChute Personal Edition. Then select the appropriate operating system and follow the instructions to download the software.
4. APC PowerChute is compatible with a window operating system only. Visit <http://www.apc.com/wp/?um=300> for OS compatibility list.

Connect the Equipment

Battery Backup and Surge Protected outlets

When the Back-UPS is receiving input power, the Surge Protection only outlets and the Battery Backup with Surge Protection outlets will supply power to connected equipment. During a power outage or other AC problems, only the Battery Backup outlets receive power for a limited time from the Back-UPS.

Connect equipment such as printers, fax machines, scanners, or other peripherals that do not need battery backup power to the Surge Protection Only outlets. These outlets provide full-time protection from surges even if the Back-UPS is switched OFF.

Master and Controlled outlets

To conserve electricity, when the device connected to Master Outlet goes into Sleep or Standby mode, or turns Off, the Controlled device(s) will shut down as well, saving electricity.

Connect a master device, such as a desktop computer or audio/visual receiver to the Master outlet. Connect peripheral devices such as a printer, speakers, or a scanner to the Controlled outlets.

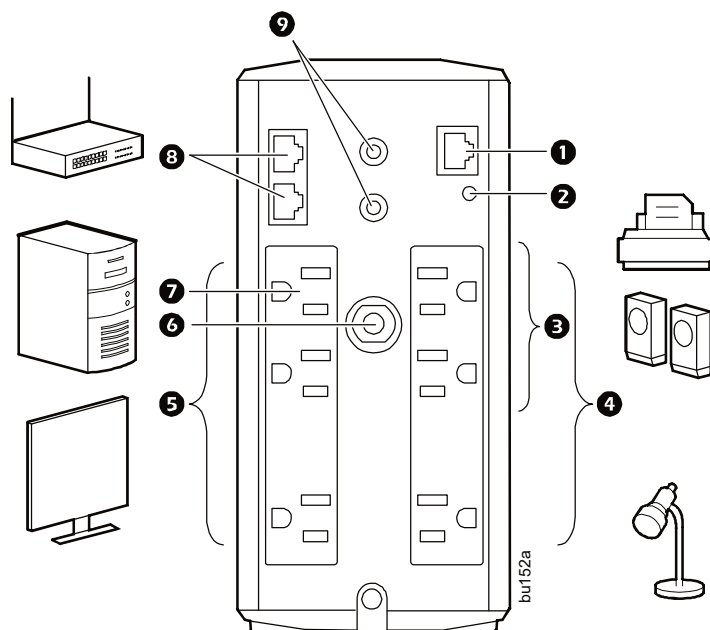

1 USB and Serial Data port	To use PowerChute Personal Edition, connect the supplied USB software cable or optional serial cable (not included).
2 Building Wiring Fault indicator	If this indicator is illuminated, there is a problem with the wiring in the building. Contact an electrician immediately and do not use the Back-UPS.
3 Controlled by the Master outlets	These outlets will disconnect from AC power if the Power Saving Feature is activated and the Master device goes into Sleep or Standby mode.
4 Surge Protected outlets	These outlets provide full-time surge protection, even when the unit is turned off. During a power outage these outlets will disconnect from AC power. Connect equipment such as printers and scanners that do not require battery backup protection.
5 Battery Backup outlets with Surge Protection	During a power outage or other AC problems, these outlets provide power from battery. Connect critical equipment such as desktop computer, computer monitor, modem or other data sensitive devices into these outlets.
6 Circuit breaker	Use to reset the system after an overload or short circuit.
7 Master outlet	Connect the master device to this outlet, in most scenarios, this will be the main computer.
8 Gigabit Ethernet surge-protected ports	Use an Ethernet cable to connect a cable modem to the IN port, and connect a computer to the OUT port.
9 Co-axial ports with surge protection	Use a coaxial cable to connect a cable modem or other equipment to the IN jack, and connect a computer or other device to the OUT jack.

Operation

Power-Saving Function



Power-saving outlets can be used to automatically reduce energy consumption. Just plug your computer into the Master outlet, and when it is turned OFF or goes into “sleep” or “standby” mode, any peripherals plugged into the Controlled outlets like speakers, scanners or printers, will also shut off automatically, eliminating needless electricity waste.

Notes: Devices that provide network services (such as routers, modems, or wireless printers) should not be plugged into the Controlled outlets. The Back-UPS Pro ships with this Power-Saving feature DISABLED. If you wish to use this feature, follow the instructions below:

Enable the Power-Saving function. Press and hold MUTE and DISPLAY simultaneously for two seconds. The Back-UPS will beep to indicate that the feature is enabled. The leaf icon on the display will illuminate.

Disable the Power-Saving function. Press and hold MUTE and DISPLAY simultaneously for two seconds. The Back-UPS will beep to indicate that the feature is disabled. The leaf icon on the display will extinguish.

Setting the threshold. The amount of power used by a device in Sleep or Standby mode varies between devices. It may be necessary to adjust the threshold at which the Master outlet signals the Controlled outlets to shut down.

1. Ensure a master device is connected to the Master outlet. Put that device into Sleep or Standby mode, or turn it OFF.
2. Press DISPLAY and MUTE simultaneously and hold for six seconds, until the leaf icon flashes three times and the Back-UPS beeps three times.
3. The Back-UPS will now recognize the threshold level of the Master device and save it as the new threshold setting.

Power-Saving Display

The display interface can be configured to be continuously illuminated, or to save energy, it can be configured to extinguish after a period of inactivity.

1. Full Time Mode: Press and hold DISPLAY for two seconds. The display will illuminate and the Back-UPS will beep to confirm the Full-Time mode.
2. Power-Saving Mode: Press and hold DISPLAY for two seconds. The display will darken and the Back-UPS will beep to confirm the Power-Saving mode. While in Power-Saving Mode, the display will illuminate if a button is pressed, it then darkens after 60 seconds of no activity.

Unit sensitivity

In situations where the Back-UPS or connected equipment appears too sensitive to input voltage, it may be necessary to adjust the transfer voltage. Adjust the sensitivity of the Back-UPS to control when it will switch to battery power; the higher the sensitivity, the more often the Back-UPS will switch to battery power.

1. Ensure the Back-UPS is connected to AC power, but is OFF.
2. Press and hold the POWER button for six seconds. The LOAD CAPACITY bar will flash on and off, indicating that the Back-UPS is in programming mode.
3. Press POWER again to rotate through the menu options. Stop at selected sensitivity. The Back-UPS will beep to confirm the selection.

Generator Sensitivity



Low sensitivity

78-144 Vac

Input voltage is extremely low or high. (Not recommended for computer loads.)

Default



Medium sensitivity (Default)

88-141 Vac

The Back-UPS frequently switches to battery power.

Sensitive Loads



High sensitivity

88-137 Vac

The connected equipment is sensitive to voltage fluctuations.

Front Panel Buttons and Display Interface

Use the three buttons on the front panel of the Back-UPS and the display interface to configure the Back-UPS.

Front panel

- ① Mute button
- ② Power On/Off button
- ③ Display button
- ④ Display interface

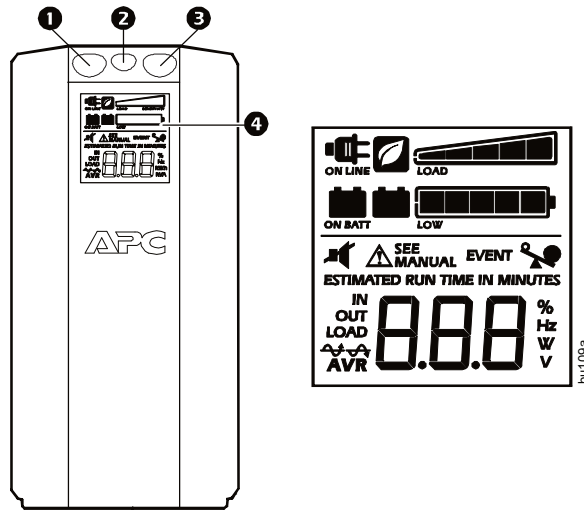

On Line: The Back-UPS is supplying conditioned AC power to connected equipment



Power-Saving: Master and Controlled outlets are enabled, saving power when the master device goes into sleep or standby mode



Load Capacity: The load is indicated by the number of sections illuminated, one to five. Each bar represents 20% of the load.



Battery Charge: The battery charge level is indicated by the number of sections illuminated. When all five blocks are illuminated, the Back-UPS is at full charge. When one block is filled, the Back-UPS is near the end of its battery capacity, the indicator will flash and the Back-UPS will beep continuously.



Overload: The power demand from the load has exceeded the capacity of the Back-UPS.



Event: The event counter shows the number of events that occurred that caused the Back-UPS to switch to on-battery operation.



Automatic Voltage Regulation: The Back-UPS can compensate for high or low input voltage.



When illuminated, the Back-UPS is compensating for low input voltage.



When illuminated, the Back-UPS is compensating for high input voltage.



Input voltage.



Output voltage.



System Faults: The system has a fault. The fault number will illuminate on the display interface. See "System Faults" on page 5.



Mute: If the line through the speaker icon is illuminated, the audible alarm has been turned off.



Replace Battery: The battery is not connected or is nearing the end of its useful life. Replace the battery.



On Battery: The Back-UPS is supplying battery backup power to the connected equipment, it will beep four times every 30 seconds.

Warnings and System Faults



Audible Warnings

Four Beeps Every 30 Seconds	Back-UPS is running on battery. You should consider saving any work in progress.
Continuous Beeping	Low battery condition and battery run-time is very low. Promptly save any work in progress, exit all open applications, and shut down the operating system.
Continuous tone	Battery Backup outputs are overloaded.
Chirps for 1 Minute every 5 hours	Battery fails the automatic diagnostic test and should be replaced.

Warning Icons

If these icons are illuminated...

This may be the problem.

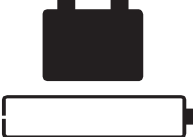
	The Back-UPS is operating on AC power, but is overloaded. Disconnect one of the items connected to the Back-UPS. If the Overload icon stops flashing, the Back-UPS is no longer overloaded and will continue to operate normally.
	The Back-UPS is operating on battery power, but is overloaded. Disconnect one of the items connected to the Back-UPS. If the Overload icon stops flashing, the Back-UPS is no longer overloaded and will continue to operate normally.
	The Back-UPS is operating on AC power, but the battery is not functioning properly. Contact Schneider Electric IT (SEIT) Customer Service to order a replacement battery. See "Replace Battery" on page 8.
	The Back-UPS is operating on battery power and the battery power is getting low. Shut down all connected equipment to avoid losing an unsaved data. When possible, connect the Back-UPS to AC power to recharge the battery.





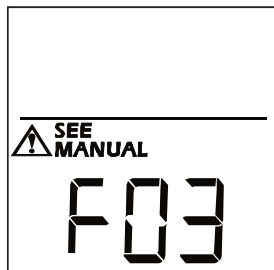







System Faults

The Back-UPS will display these fault messages.



F01 On-Battery Overload	Turn the Back-UPS off. Disconnect non-essential equipment from the Battery Backup outlets and the turn Back-UPS on.
F02 On-Battery Output Short	Turn the Back-UPS off. Disconnect non-essential equipment from the Battery Backup outlets and the turn Back-UPS on.
F03 On-Battery Xcap Overload	Faults F03-F09 cannot be corrected by the user, contact SEIT Technical Support for assistance.
F04 Clamp Short	
F05 Charge Fault	
F06 Relay Welding	
F07 Temperature	
F08 Fan Fault	
F09 Internal Fault	

Function Button Quick Reference

Function	Button	Timing (seconds)	UPS Status	Description
Power				
Power On		0.2	Off	Press POWER to start receiving input AC power. If AC input power is not available, the Back-UPS will run on battery power.
Power Off		2	On	The Back-UPS is not receiving input AC power, but is providing surge protection.
Display				
Status Inquiry		0.2	On	Verify the status or condition of the Back-UPS. The LCD will illuminate for 60 seconds.
Full-Time/Power-Saving mode		2	On	The LCD will illuminate and the Back-UPS will beep to confirm the Full-Time mode. The LCD will darken and the Back-UPS will beep to confirm the Power-Saving mode. While in Power-Saving Mode, the LCD will illuminate if a button is pressed, then darkens after 60 seconds of no activity.
Mute				
Event Specific		0.2	On	Disable any audible alarms caused by an event.
General Status Enable/Disable		2	On	Enable or disable the audible alarms. The Mute icon will illuminate and the Back-UPS will beep one time. The Mute function will not activate unless the Back-UPS is operating on battery power.
Sensitivity				
Sensitivity		6	Off	The Load Capacity icon will blink, indicating that the Back-UPS is in programming mode. Use the POWER button to scroll through Low, Medium, and High, stop at selected sensitivity. The Back-UPS will beep to confirm selection. See Configuration for details.
Master/Controlled outlet Enable/Disable		2	On	The leaf icon will darken indicating that the Master Outlet feature is disabled or illuminate to indicate the Master Outlet feature is enabled. The Back-UPS will beep once.
Master/Enable Threshold Calibration		6	On	While calibrating the threshold setting, the device connected to the Master Outlet should be turned off or placed in Standby or Sleep mode. Upon completion, Power-Saving icon will flash 3 and beep 3 times.
Self-Test (manual)				
Self-Test (manual)		6	On	The Back-UPS will perform a test of the internal battery. Note: This will happen automatically when the Back-UPS is turned ON.
Event Reset				
Event Reset		0.2	On	When the Event screen is visible, press and hold DISPLAY, then press POWER, to clear the AC failure event counter.
Fault Reset				
Fault Reset		2	Fault	After a fault has been identified, press POWER to remove the visual indication and return to standby status.

Troubleshooting

Problem	Possible Cause	Corrective Action
Back-UPS will not switch on.	The Back-UPS is not connected to AC power.	Ensure that the Back-UPS is securely connected to an AC outlet.
	The circuit breaker has been tripped.	Disconnect non-essential equipment from the Back-UPS. Reset the circuit breaker. Re-connect equipment one item at a time. If the circuit breaker is tripped again, disconnect the device that caused the trip.
	The internal battery is not connected.	Connect the battery.
	The AC input voltage is out of range.	Adjust the transfer voltage and sensitivity range.
The Back-UPS does not provide power during a AC power outage.	Ensure that essential equipment is not plugged into a SURGE ONLY outlet.	Disconnect equipment from the SURGE ONLY outlet and re-connect to a Battery Backup outlet.
The Back-UPS is operating on battery power, while connected to AC power.	The plug has partially pulled out of the wall outlet, the wall outlet is no longer receiving AC power, or the circuit breaker has been tripped.	Ensure that the plug is fully inserted into the wall outlet. Ensure that the wall outlet is receiving AC power by checking it with another device.
	The Back-UPS is performing an automatic self test.	No action is necessary.
	The AC input voltage is out of range, the frequency is out of range, or the waveform is distorted.	Adjust the transfer voltage and sensitivity range.
The Back-UPS does not provide the expected amount of backup time.	Battery Backup outlets may be fully or improperly loaded.	Disconnect non-essential equipment from the Battery Backup outlets and connect the equipment to SURGE ONLY outlets.
	The battery was recently discharged due to a power outage and has not fully recharged.	Charge the battery cartridge for 16 hours.
	The battery has reached the end of its useful life.	Replace the battery.
The REPLACE BATTERY indicator is illuminated.	The battery has reached the end of its useful life.	Replace the battery.
The OVERLOAD indicator is illuminated.	The equipment connected to the Back-UPS is drawing more power than the Back-UPS can provide.	Disconnect non-essential equipment from the Battery Backup outlets and connect the equipment to SURGE ONLY outlets.
The SYSTEM FAULT indicator is illuminated, all the front panel indicators are flashing.	There is an internal fault.	Determine which internal fault message is displayed by matching the number displayed on the LCD with the corresponding Fault Message (see System Faults) and contact SEIT Technical Support.
Power is not supplied to some outlets.	Power to the Controlled outlets has intentionally been turned off.	Confirm that the correct peripherals are connected to Controlled outlets. If this feature is not desired, disable the Power-Saving Master and Controlled outlets.
The Controlled outlets are not supplying power, even though the Master device is not in sleep mode.	The Master Outlet threshold may be incorrectly set.	Adjust the threshold when the Master outlet signals the Controlled outlets to shut down.

Specifications

Model	BR700G
VA	700 VA
Maximum Load	420 W
Nominal Input Voltage	120 V
Online Input Voltage Range	Default Setting: 88 - 141 V Low Sensitivity Setting: 78 V - 144 V High Sensitivity Setting: 88 V - 137 V
Automatic Voltage Regulation	(94-107) +11.5% (126-133) -11.5%
Frequency Range	50/60 Hz ± 1 Hz
On-battery Waveshape	Step-approximated sine-wave
Typical Recharge Time	8 hours
Transfer Time	10 ms, maximum
Operating Temperature	0° to 40°C (32° to 104°F)
Storage Temperature	-15° to 45°C (5° to 113°F)
Unit Dimensions	19 × 9.1 × 31 cm (7.48 × 3.58 × 12.2 in)
Unit Weight	7.15 kg (15.8 lbs)
Dataline Surge Protection	10/100/1000BASE-T
Interface	Serial, USB
On-Battery Runtime	Go to: www.apc.com
EMI Classification	cTUVus, FCC, NOM
Approvals	cTUVus, FCC, NOM

Service

If the unit requires service, do not return it to the dealer. Follow these steps:

1. Review the *Troubleshooting* section of the manual to eliminate common problems.
2. If the problem persists, contact Schneider Electric IT (SEIT) Customer Support through the APC by Schneider Electric Web site, www.apc.com.
 - a. Note the model number and serial number and the date of purchase. The model and serial numbers are located on the rear panel of the unit and are available through the LCD display on select models.
 - b. Call SEIT Customer Support and a technician will attempt to solve the problem over the phone. If this is not possible, the technician will issue a Returned Material Authorization Number (RMA#).
 - c. If the unit is under warranty, the repairs are free.
 - d. Service procedures and returns may vary internationally. Refer to the APC by Schneider Electric Web site for country specific instructions.
3. Pack the unit in the original packaging whenever possible to avoid damage in transit. Never use foam beads for packaging. Damage sustained in transit is not covered under warranty.
4. **Always DISCONNECT THE UPS BATTERIES before shipping. The United States Department of Transportation (DOT), and the International Air Transport Association (IATA) regulations require that UPS batteries be disconnected before shipping.** The internal batteries may remain in the UPS.
5. Write the RMA# provided by Customer Support on the outside of the package.
6. Return the unit by insured, pre-paid carrier to the address provided by Customer Support.

Replace Battery



Deliver the used battery to a recycling facility.

Replace the used battery with an APC by Schneider Electric approved battery. Replacement batteries can be ordered through the APC by Schneider Electric Web site, www.apc.com. Battery replacement part for Back-UPS Pro BR700G is **APCRBC17**.

Warranty

The standard warranty is three (3) years from the date of purchase. Schneider Electric IT (SEIT) standard procedure is to replace the original unit with a factory reconditioned unit. Customers who must have the original unit back due to the assignment of asset tags and set depreciation schedules must declare such a need at first contact with an SEIT Technical Support representative. SEIT will ship the replacement unit once the defective unit has been received by the repair department, or cross ship upon the receipt of a valid credit card number. The customer pays for shipping the unit to SEIT. SEIT pays ground freight transportation costs to ship the replacement unit to the customer.

APC by Schneider Electric IT Customer Support Worldwide

For country specific customer support, go to the APC by Schneider Electric Web site, www.apc.com.



Select models are ENERGY STAR® qualified. For more information go to www.apc.com/site/recycle/index.cfm/energy-efficiency/energy-star

Customer support and warranty information is available at the APC by Schneider Electric Web site, www.apc.com.