

Terminal Blocks

Fuseholders and Power Distribution Blocks

Catalog
 9080CT9603R12/17
2017
 Class 9080

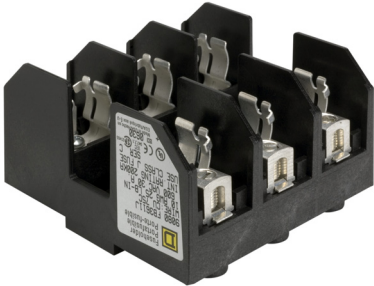



CONTENTS



Description	Page
Enclosed Power Distribution Blocks	4
9080LBA Power Distribution Blocks	10
9080LBA and LBC Power Distribution Blocks	14
9080FB Fuseholders	16
Dimensions	20
Short-Circuit Current Ratings	28
Stranded Wire Applications	37
Wire Classes	38
Index of Catalog Numbers	47



by Schneider Electric

Family	Description
	<p>Schneider Electric™ NSYEB Enclosed Power Distribution Blocks</p> <p>NSYEB power distribution blocks are enclosed IEC versions of our NEMA 9080 power distribution blocks, which are finger safe from the front according to IP20, and available with copper or aluminum lugs. They have Short-Circuit Current Ratings (SCCR) up to 100 kA with fuses. They are one-pole modular units with an interlocking dovetail feature that enables ganging of the blocks to create multi-pole configurations according to application requirements. Most are UL Listed (some are UL component recognized), CSA approved, and RoHS compliant. CE marking ensures acceptance throughout the European community. The UL Listed blocks meet feeder circuit spacing requirements.</p>
 <p>Class 9080 Type LB</p>	<p>Square D™ 9080 Open Power Distribution Blocks</p> <p>Available in a wide variety of sizes, these NEMA open power distribution blocks are available in one, two, and three pole versions with either aluminum or copper lugs. Many blocks have been tested to achieve SCCR up to 100 kA. They are UL component recognized, CSA approved, RoHS compliant, and CE marked. A selection of covers completes this family.</p>
 <p>Class 9080 Type FB</p>	<p>Square D 9080 FB Fuse Holders</p> <p>This family of NEMA fuse holders will accept types H, R, CC, M, and J fuses up to 200 amperes. Both 250 V and 600 V versions are available. Types H, R, J, and CC are UL Listed. Type M fuse holders are UL component recognized. They are all CSA approved, CE marked, and RoHS compliant.</p>

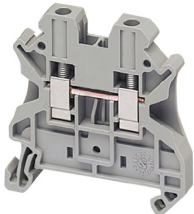
NOTE: The product lines listed below are not shown in this catalog. Please refer to the referenced catalog included with each family.

Family	Description
 <p>NSYTR</p>	<p>Schneider Electric Linergy™ Terminal Blocks</p> <p>Depending on the application, there are several types of IEC terminal blocks:</p> <ul style="list-style-type: none"> • Screw technology terminal blocks are suitable for the majority of connection applications due to their wide range of functions and connection possibilities. • Spring technology requires no maintenance and helps provide a separation of mechanical and electrical functions. • Push-in terminal blocks reduce wiring time and eliminate the need for regular re-tightening. • The hybrid offer is a combination of screw terminal and Insulation Displacement Connection (IDC). <p>These blocks are UL component recognized, CSA approved, CE marked, and RoHS compliant.</p> <p>Refer to catalog 9080CT1301</p>
 <p>Class 9080 Type G</p>	<p>Square D 9080 Terminal Blocks</p> <p>This family of NEMA blocks and accessories offers features such as a large variety of colors, high density to save space in applications, multiple mounting methods such as 35 mm DIN rail, 9080GH (3/4") track, or direct panel mounting. They are UL component recognized, CSA approved, RoHS compliant, and CE marked.</p> <p>Refer to Catalog 9080CT9601.</p>
	<p>Circuit Protectors</p> <p>There are two families of circuit protectors. The Square D 9080 Type GCB thermal magnetic product line is available from 0.1–15 A. The Schneider Electric GB2 IEC thermal magnetic products are available from 0.5–12 A. Both product lines are UL component recognized, CSA approved, RoHS compliant, and CE marked.</p> <p>Refer to Catalog 9080CT9601 or Catalog 9080CT9602.</p>

Terminal Blocks

Enclosed Power Distribution Blocks











Without the use of additional shields, these Schneider Electric IEC power distribution blocks are designed to prevent contact with live connectors from the front according to IP20. The blocks are available with aluminum or copper terminals and have high fault SCCR up to 100 kA with an assortment of fuses. They are designed to meet a variety of load distribution or splicing applications.

Specifications:

- Up to 760 A
- 600 V AC/DC
- Multiple wire ratings
- 35 mm DIN rail or panel mounting options

Standards:









- UL Listed or UL Component Recognized.
- UL Listed blocks meet feeder circuit spacing requirements.
- CSA Certified
- CE Approved
- RoHS Compliant
- IP20 from the front
- Flammability UL 94 V-0

		
Maximum Voltage Rating	600	600
Current Rating, Cu Wire	115	115
Current Rating, Al Wire	N/A	N/A
Mounting	35 mm DIN Rail or Panel	35 mm DIN Rail or Panel
SCCR with Fuses	Up to 100 kA, see page 29.	Up to 65 kA, see page 29.
Wire Range Limited to wire class. See "Wire Classes - Enclosed Power Distribution Blocks" beginning on page 38.	Line Cu: (1) 14–2 AWG (2.5–35 mm ²)	Line Cu: (1) 14–2 AWG (2.5–35 mm ²)
	Load Cu: (1) 14–2 AWG (2.5–35 mm ²)	Load Cu: (4) 14–10 AWG (2.5–6 mm ²)
Lugs Suitable for Use with	75 °C Conductors	75 °C Conductors
Tightening Torque lb-in (N•m)	Line Cu: 3–2 AWG (35 mm ²): 50 (5.6) Cu: 6–4 AWG (16–25 mm ²): 45 (5.1) Cu: 8 AWG (10 mm ²): 40 (4.5) Cu: 14–10 AWG (2.5–6 mm ²): 35 (4.0)	Line Cu: 3–2 AWG (35 mm ²): 50 (5.6) Cu: 6–4 AWG (16–25 mm ²): 45 (5.1) Cu: 8 AWG (10 mm ²): 40 (4.5) Cu: 14–10 AWG (2.5–6 mm ²): 35 (4.0)
	Load Cu: 3–2 AWG (35 mm ²): 50 (5.6) Cu: 6–4 AWG (16–25 mm ²): 45 (5.1) Cu: 8 AWG (10 mm ²): 40 (4.5) Cu: 14–10 AWG (2.5–6 mm ²): 35 (4.0)	Load Cu: 14–10 AWG (2.5–6 mm ²): 35 (4.0)
Wire Strip Length in. (mm)	Line: 5/8 (16); Load 5/8 (16)	Line: 5/8 (16); Load top: 7/16 (11); Load bottom 11/16 (17)
Terminal Screw Drive, Line Side	5/32 Hex	5/32 Hex
Terminal Screw Drive, Load Side	5/32 Hex	5/64 Hex
Lug Material	Tin Plated Aluminum	Tin Plated Aluminum
Base Material	Thermoplastic	Thermoplastic
Terminal Set Screw Material	Nickel Plated Steel	Nickel Plated Steel
Connector Mounting Screw	Zinc Plated Steel	Zinc Plated Steel
Temperature Rating	-40 to 257 °F (-40 to 125 °C)	-40 to 257 °F (-40 to 125 °C)
Certifications	 UL E323110 QPQS  CSA File 70361 Class 6228-01  RoHS Compliant  CE Marked	 UL E323110 QPQS  CSA File 70361 Class 6228-01  RoHS Compliant  CE Marked
Flammability Rating	UL94V-0	UL94V-0
Block Catalog Number	NSYEBAD11611	NSYEBAD11614
Terminal Plug (for plugging unused openings)	N/A	N/A
Block Dimensions (D) x (H) x (W)	4.14 x 1.71 x 0.75 in. (105.2 x 43.5 x 19.0 mm)	4.14 x 1.71 x 0.75 in. (105.2 x 43.5 x 19.0 mm)











Terminal Plug

Terminal Blocks Enclosed Power Distribution Blocks









				
Maximum Voltage Rating	600	600	600	600
Current Rating, Cu Wire	200	200	200	200
Current Rating, Al Wire	155	155	N/A	N/A
Mounting	35 mm DIN Rail	Panel	35 mm DIN Rail	Panel
SCCR with Fuses	Up to 100 kA, see page 29.		Up to 100 kA, see page 29.	
Wire Range Limited to wire class. See "Wire Classes - Enclosed Power Distribution Blocks" beginning on page 38.	Line Cu: (1) 14 AWG-3/0 (2.5-70 mm ²) Al: (1) 6 AWG-3/0		Line Cu: (1) 14 AWG-3/0 (2.5-70 mm ²)	
	Load Cu: (1) 14 AWG-3/0 (2.5-70 mm ²) Al: (1) 6 AWG-3/0		Load Cu: (1) 14 AWG-3/0 (2.5-70 mm ²)	
Lugs Suitable for Use with	75 °C Conductors		90 °C Conductors	
Tightening Torque lb-in (N•m)	Line Cu: 8 AWG-3/0 (10-70 mm ²): 180 (20.3) Cu: 14-10 AWG (2.5-6 mm ²): 50 (5.6) Al: 6 AWG-3/0: 180 (20.3)		Line Cu: 8 AWG-3/0 (10-70 mm ²): 180 (20.3) Cu: 14-10 AWG (2.5-6 mm ²): 50 (5.6)	
	Load Cu: 8 AWG-3/0 (10-70 mm ²): 180 (20.3) Cu: 14-10 AWG (2.5-6 mm ²): 50 (5.6) Al: 6 AWG-3/0: 180 (20.3)		Load Cu: 8 AWG-3/0 (10-70 mm ²): 180 (20.3) Cu: 14-10 AWG (2.5-6 mm ²): 50 (5.6)	
Wire Strip Length in. (mm)	Line: 7/8 (18); Load: 7/8 (18)			
Terminal Screw Drive, Line Side	6 mm Hex		6 mm Hex	
Terminal Screw Drive, Load Side	6 mm Hex		6 mm Hex	
Lug Material	Tin Plated Aluminum		Tin Plated Copper	
Base Material	Thermoplastic		Thermoplastic	
Terminal Set Screw Material	Zinc Plated Steel		Zinc Plated Steel	
Connector Mounting Screw	Zinc Plated Steel		Zinc Plated Steel	
Temperature Rating	-40 to 257 °F (-40 to 125 °C)		-40 to 257 °F (-40 to 125 °C)	
Certifications	 UL E323110 QPQS  CSA File 70361 Class 6228-01  RoHS Compliant  Marked			
Flammability Rating	UL94V-0		UL94V-0	
Block Catalog Number	NSYEBAD12611	NSYEBAP12611	NSYEBAD12611	NSYEBAP12611
Terminal Plug	N/A	N/A	N/A	N/A
Block Dimensions	3.61 x 2.71 x 1.11 in.	3.61 x 2.71 x 1.11 in.	3.61 x 2.71 x 1.11 in.	3.61 x 2.71 x 1.11 in.
(D) x (H) x (W)	(91.7 x 68.9 x 28.2 mm)	(91.7 x 68.9 x 28.2 mm)	(91.7 x 68.9 x 28.2 mm)	(91.7 x 68.9 x 28.2 mm)

Terminal Blocks

Enclosed Power Distribution Blocks







				
Maximum Voltage Rating	600	600	600	600
Current Rating, Cu Wire	200	200	200	200
Current Rating, Al Wire	155	155	N/A	N/A
Mounting	35 mm DIN Rail	Panel	35 mm DIN Rail	Panel
SCCR with Fuses	Up to 100 kA, see page 29.		Up to 100 kA, see page 29.	
Wire Range Limited to wire class. See "Wire Classes - Enclosed Power Distribution Blocks" beginning on page 38.	Line Cu: (1) 14 AWG–3/0 (2.5–70 mm ²) Al: (1) 6 AWG–3/0 Load Cu: (4) 14–2 AWG (2.5–35 mm ²) Al: (4) 6–2 AWG		Line Cu: (1) 14 AWG–3/0 (2.5–70 mm ²) Load Cu: (4) 14–2 AWG (2.5–35 mm ²)	
Lugs Suitable for Use with	75 °C Conductors		90 °C Conductors	
Tightening Torque lb-in (N•m)	Line Cu: 8 AWG–3/0 (10–70 mm ²): 180 (20.3) Cu: 14–10 AWG (2.5–6 mm ²): 50 (5.6) Al: 6 AWG–3/0: 180 (20.3) Load Cu: 8–2 AWG (10–35 mm ²): 50 (5.6) Cu: 14–10 AWG (2.5–6 mm ²): 40 (4.5) Al: 6–2 AWG: 50 (5.6)		Line Cu: 8 AWG–3/0 (10–70 mm ²): 180 (20.3) Cu: 14–10 AWG (2.5–6 mm ²): 50 (5.6) Load Cu: 8–2 AWG (10–35 mm ²): 50 (5.6) Cu: 14–10 AWG (2.5–6 mm ²): 40 (4.5)	
Wire Strip Length in. (mm)	Line: 7/8 (18); Load: 11/16 (17)			
Terminal Screw Drive, Line Side	6 mm Hex		6 mm Hex	
Terminal Screw Drive, Load Side	5 mm Hex		5 mm Hex	
Lug Material	Tin Plated Aluminum		Tin Plated Copper	
Base Material	Thermoplastic		Thermoplastic	
Terminal Set Screw Material	Zinc Plated Steel		Zinc Plated Steel	
Connector Mounting Screw	Zinc Plated Steel		Zinc Plated Steel	
Temperature Rating	-40 to 257 °F (-40 to 125 °C)		-40 to 257 °F (-40 to 125 °C)	
Certifications	 UL E323110 QPQS  CSA File 70361 Class 6228-01  RoHS Compliant  CE Marked			
Flammability Rating	UL94V-0		UL94V-0	
Block Catalog Number	NSYEBAD12614	NSYEBAP12614	NSYEBAD12614	NSYEBAD12614
Terminal Plug	N/A	N/A	N/A	N/A
Block Dimensions (D) x (H) x (W)	3.61 x 2.71 x 1.11 in. (91.7 x 68.9 x 28.2 mm)	3.61 x 2.71 x 1.11 in. (91.7 x 68.9 x 28.2 mm)	3.61 x 2.71 x 1.11 in. (91.7 x 68.9 x 28.2 mm)	3.61 x 2.71 x 1.11 in. (91.7 x 68.9 x 28.2 mm)

Terminal Blocks Enclosed Power Distribution Blocks





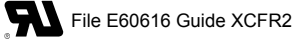
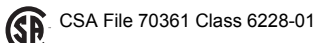
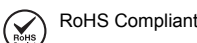

				
Maximum Voltage Rating	600	600	600	600
Current Rating, Cu Wire	335	335	335	335
Current Rating, Al Wire	270	270	N/A	N/A
Mounting	35 mm DIN Rail	Panel	35 mm DIN Rail	Panel
SCCR with Fuses	Up to 10 kA, see page 29.	Up to 100 kA, see page 29.	Up to 10 kA, see page 29.	Up to 100 kA, see page 29.
Wire Range Limited to wire class. See “Wire Classes - Enclosed Power Distribution Blocks” beginning on page 38.	Line Cu: (1) 6 AWG–400 kcmil (16–185 mm ²) Cu: (1) 14–3/0 AWG (2.5–70 mm ²) Al: (1) 6 AWG–400 kcmil Al: (1) 6–3/0 AWG		Line Cu: (1) 6 AWG–400 kcmil (16–185 mm ²) Cu: (1) 14–3/0 AWG (2.5–70 mm ²)	
	Load Cu: (8) 14–2 AWG (2.5–35 mm ²) Al: (8) 6–2 AWG		Load Cu: (8) 14–2 AWG (2.5–35 mm ²)	
Lugs Suitable for Use with	75 °C Conductors		75 °C Conductors	
Tightening Torque lb-in (N•m)	Line Cu: 2/0–400 kcmil (70–185 mm ²): 375 (42.2) Cu: 6–1/0 (16–50 mm ²): 275 (31) Al: 2/0–400 kcmil: 375 (42.2) Al: 6–1/0: 275 (31)		Line Cu: 2/0–400 kcmil (70–185 mm ²): 375 (42.2) Cu: 6–1/0 (16–50 mm ²): 275 (31)	
	Cu: 1–3/0 (35–75 mm ²): 120 (13.5) Cu: 6–2 AWG (16–25 mm ²): 80 (9) Cu: 14–8 AWG (2.5–10 mm ²): 40 (4.5) Al: 1–3/0: 120 (13.5) Al: 6–2 AWG: 80 (9)		Cu: 1–3/0 (35–75 mm ²): 120 (13.5) Cu: 6–2 AWG (16–25 mm ²): 80 (9) Cu: 14–8 AWG (2.5–10 mm ²): 40 (4.5)	
	Load Cu: 6–2 AWG (16–35 mm ²): 80 (9) Cu: 14–8 AWG (2.5–10 mm ²): 40 (4.5) Al: 6–2 AWG: 80 (9)		Load Cu: 6–2 AWG (16–35 mm ²): 80 (9) Cu: 14–8 AWG (2.5–10 mm ²): 40 (4.5)	
Wire Strip Length in. (mm)	Line: 1-7/16 (36) and 1 (25); Load: 5/8 (16)			
Terminal Screw Drive, Line Side	8 mm and 6 mm Hex		8 mm and 6 mm Hex	
Terminal Screw Drive, Load Side	5 mm Hex		5 mm Hex	
Lug Material	Tin Plated Aluminum		Tin Plated Copper	
Base Material	Thermoplastic		Thermoplastic	
Line Side Terminal Set Screw Material	8 mm Hex, Tin Plated Aluminum 5 mm Hex, Zinc Plated Steel		8 mm Hex, Tin Plated Aluminum 5 mm Hex, Zinc Plated Steel	
Load Side Terminal Set Screw Material	Zinc Plated Steel		Zinc Plated Steel	
Connector Mounting Screw	Zinc Plated Steel		Zinc Plated Steel	
Temperature Rating	-40 to 257 °F (-40 to 125 °C)		-40 to 257 °F (-40 to 125 °C)	
Certifications	 File E60616 Guide XCFR2  CSA File 70361 Class 6228-01  RoHS Compliant  CE Marked			
Flammability Rating	UL94V-0		UL94V-0	
Block Catalog Number	NSYEBAD13618	NSYEBAP13618	NSYEBCD13618	NSYEBP13618
Terminal Plug (for plugging unused openings. See page 4 for photograph.)	NSYEBP2 (2 AWG)	NSYEBP2 (2 AWG)	NSYEBP2 (2 AWG)	NSYEBP2 (2 AWG)
	NSYEBP20 (2/0 AWG)	NSYEBP20 (2/0 AWG)	NSYEBP20 (2/0 AWG)	NSYEBP20 (2/0 AWG)
	NSYEBP400 (400 kcmil)	NSYEBP400 (400 kcmil)	NSYEBP400 (400 kcmil)	NSYEBP400 (400 kcmil)
Block Dimensions (D) x (H) x (W)	4.72 x 3.14 x 2.27 in. (114.5 x 79.8 x 57.6 mm)	4.39 x 3.14 x 2.27 in. (111.4 x 79.8 x 57.6 mm)	4.72 x 3.14 x 2.27 in. (114.5 x 79.8 x 57.6 mm)	4.39 x 3.14 x 2.27 in. (111.4 x 79.8 x 57.6 mm)

Terminal Blocks

Enclosed Power Distribution Blocks









				
Maximum Voltage Rating	600	600	600	600
Current Rating, Cu Wire	510	510	510	510
Current Rating, Al Wire	410	410	N/A	N/A
Mounting	35 mm DIN Rail	Panel	35 mm DIN Rail	Panel
SCCR with Fuses	Up to 10 kA, see page 29.	Up to 100 kA, see page 29.	Up to 10 kA, see page 29.	Up to 100 kA, see page 29.
Wire Range Limited to wire class. See “Wire Classes - Enclosed Power Distribution Blocks” beginning on page 38.	Line Cu: (2) 6 AWG–250 kcmil (16–120 mm ²) Al: (2) 6 AWG–250 kcmil		Line Cu: (2) 6 AWG–250 kcmil (16–120 mm ²)	
	Load Cu: (2) 6 AWG–250 kcmil (16–120 mm ²) Al: (2) 6 AWG–250 kcmil		Load Cu: (2) 6 AWG–250 kcmil (16–120 mm ²)	
Lugs Suitable for Use with	75 °C Conductors		75 °C Conductors	
Tightening Torque lb-in (N•m)	Line Cu: 1 AWG–250 kcmil (50–120 mm ²): 275 (31.0) Cu: 6–2 AWG (16–35 mm ²): 120 (13.5) Al: 1 AWG–250 kcmil: 275 (31.0) Al: 6–2 AWG: 120 (13.5)		Line Cu: 1 AWG–250 kcmil (50–120 mm ²): 275 (31.0) Cu: 6–2 AWG (16–35 mm ²): 120 (13.5)	
	Load Cu: 1 AWG–250 kcmil (50–120 mm ²): 275 (31.0) Cu: 6–2 AWG (16–35 mm ²): 120 (13.5) Al: 1 AWG–250 kcmil: 275 (31.0) Al: 6–2 AWG: 120 (13.5)		Load Cu: 1 AWG–250 kcmil (50–120 mm ²): 275 (31.0) Cu: 6–2 AWG (16–35 mm ²): 120 (13.5)	
Wire Strip Length in. (mm)	Line: 1-3/8 (35); Load: 1-3/8 (35)			
Terminal Screw Drive, Line Side	8 mm Hex		8 mm Hex	
Terminal Screw Drive, Load Side	8 mm Hex		8 mm Hex	
Lug Material	Tin Plated Aluminum		Tin Plated Copper	
Base Material	Thermoplastic		Thermoplastic	
Terminal Set Screw Material	Tin Plated Aluminum		Tin Plated Aluminum	
Connector Mounting Screw	Zinc Plated Steel		Zinc Plated Steel	
Temperature Rating	-40 to 257 °F (-40 to 125 °C)		-40 to 257 °F (-40 to 125 °C)	
Certifications			  	
Flammability Rating	UL94V-0		UL94V-0	
Block Catalog Number	NSYEBAD25622	NSYEBAP25622	NSYEBCD25622	NSYEBCP25622
Terminal Plug (for plugging unused openings. See page 4 for photograph.)	NSYEBP250 (250 kcmil)	NSYEBP250 (250 kcmil)	NSYEBP250 (250 kcmil)	NSYEBP250 (250 kcmil)
Block Dimensions (D) x (H) x (W)	4.72 x 3.14 x 2.27 in. (114.5 x 79.8 x 57.6 mm)	4.39 x 3.14 x 2.27 in. (111.4 x 79.8 x 57.6 mm)	4.72 x 3.14 x 2.27 in. (114.5 x 79.8 x 57.6 mm)	4.39 x 3.14 x 2.27 in. (111.4 x 79.8 x 57.6 mm)

Terminal Blocks Enclosed Power Distribution Blocks

			
Maximum Voltage Rating	600	600	600
Current Rating, Cu Wire	760	760	760
Current Rating, Al Wire	620	620	N/A
Mounting	Panel	Panel	Panel
SCCR with Fuses	Up to 100 kA, see page 29.	Up to 100 kA, see page 29.	Up to 100 kA, see page 29.
Wire Range Limited to wire class. See "Wire Classes - Enclosed Power Distribution Blocks" beginning on page 33.	Line Cu: (2) 4 AWG–500 kcmil (25–240 mm ²) Al: (2) 4 AWG–500 kcmil	Line Cu: (2) 4 AWG–500 kcmil (25–240 mm ²) Al: (2) 4 AWG–500 kcmil	Line Cu: (2) 4 AWG–500 kcmil (25–240 mm ²)
	Load Cu: (2) 4 AWG–500 kcmil (25–240 mm ²) Al: (2) 4 AWG–500 kcmil	Load Cu: (8) 14–2/0 AWG (2.5–50 mm ²) Al: (8) 6–2/0 AWG	Load Cu: (8) 14–2/0 AWG (2.5–50 mm ²)
Lugs Suitable for Use with	75 °C Conductors	75 °C Conductors	90 °C Conductors
Tightening Torque lb-in (N•m)	Line Cu: 4 AWG–500 kcmil (25–240 mm ²): 375 (42.4) Al: 4 AWG–500 kcmil: 375 (42.4)	Line Cu: 4 AWG–500 kcmil (25–240 mm ²): 375 (42.4) Al: 4 AWG–500 kcmil: 375 (42.4)	Line Cu: 4 AWG–500 kcmil (25–240 mm ²): 375 (42.4)
	Load Cu: 4 AWG–500 kcmil (25–240 mm ²): 375 (42.4) Al: 4 AWG–500 kcmil: 375 (42.4)	Load Cu: 6–2/0 AWG (16–50 mm ²): 120 (13.6) Cu: 8 AWG (10 mm ²): 40 (4.5) Cu: 14–10 AWG (2.5–6): 35 (4.0) Al: 6–2/0 AWG: 120 (13.6)	Load Cu: 6–2/0 AWG (16–50 mm ²): 120 (13.6) Cu: 8 AWG (10 mm ²): 40 (4.5) Cu: 14–10 AWG (2.5–6): 35 (4.0)
Wire Strip Length in. (mm)	Line: 1-1/2 (38); Load 1-1/2 (38)	Line: 1-3/8 (35); Load top: 7/8 (22); Load bottom: 1-3/8 (35)	
Terminal Screw Drive, Line Side	8 mm Hex	8 mm Hex	8 mm Hex
Terminal Screw Drive, Load Side	8 mm Hex	5 mm Hex	5 mm Hex
Lug Material	Tin Plated Aluminum	Tin Plated Aluminum	Tin Plated Copper
Base Material	Thermoplastic	Thermoplastic	Thermoplastic
Terminal Set Screw Material	Tin Plated Aluminum	Tin Plated Aluminum	Line Side: Tin Plated Aluminum Load Side: Nickel Plated Steel
Connector Mounting Screw	Zinc Plated Steel	Zinc Plated Steel	Zinc Plated Steel
Temperature Rating	-40 to 257 °F (-40 to 125 °C)	-40 to 257 °F (-40 to 125 °C)	-40 to 257 °F (-40 to 125 °C)
Certifications	 UL E323110 QPQS	 CSA File 70361 Class 6228-01	 RoHS Compliant  Marked
Flammability Rating	UL94V-0	UL94V-0	UL94V-0
Block Catalog Number	NSYEBAP27622	NSYEBAP27628	NSYEBAP27628
Terminal Plug (for plugging unused openings. See page 4 for photograph.)	NSYEBP500 (500 kcmil)	NSYEBP500 (500 kcmil)	NSYEBP500 (500 kcmil)
Block Dimensions (D) x (H) x (W)	4.63 x 3.35 x 2.54 in. (117.5 x 85.1 x 64.6 mm)	4.63 x 3.35 x 2.54 in. (117.5 x 85.1 x 64.6 mm)	4.63 x 3.35 x 2.54 in. (117.5 x 85.1 x 64.6 mm)









Terminal Blocks

9080LBA Power Distribution Blocks Copper or Aluminum Wire

Class 9080	Miniature		Standard	
				
Maximum Voltage Rating	600	600	600	600
Service Class	C	C	C	C
Current Rating, Cu Wire	115 A	115 A	175 A	175 A
Current Rating, Al Wire	90 A	90 A	135 A	135 A
SCCR w/ Circuit Breakers	See page 30.	See page 30.	N/A	See page 30.
SCCR with Fuses	See page 32.	See page 32.	See page 32.	See page 32.
Wire Range Limited to wire class. See "Wire Classes-9080LB Open Power Distribution Blocks" beginning on page 40. Lugs Suitable for Use with 75 °C Conductors	Main (1) 14–2 AWG (2.5–35 mm ²) Branch (1) 14–2 AWG (2.5–35 mm ²)	Main (1) 14–2 AWG (2.5–35 mm ²) Branch (4) 18–10 AWG (1.0–6 mm ²)	Main (1) 14–2/0 AWG (2.5–70 mm ²) Branch (1) 14–2/0 AWG (2.5–70 mm ²)	Main (1) 14–2/0 AWG (2.5–70 mm ²) Branch (4) 14–4 AWG (2.5–16 mm ²)
Tightening Torque lb-in (N·m)	Main 3–2 AWG (35 mm ²): 50 (5.6) 6–4 AWG (16–25 mm ²): 45 (5.1) 8 AWG (10 mm ²): 40 (4.5) 14–10 AWG (2.5–6 mm ²): 35 (4.0) Branch 3–2 AWG (35 mm ²): 50 (5.6) 6–4 AWG (16–25 mm ²): 45 (5.1) 8 AWG (10 mm ²): 40 (4.5) 14–10 AWG (2.5–6 mm ²): 35 (4.0)	Main 3–2 AWG (35 mm ²): 50 (5.6) 6–4 AWG (16–25 mm ²): 45 (5.1) 8 AWG (10 mm ²): 40 (4.5) 14–10 AWG (2.5–6 mm ²): 35 (4.0) Branch 18–10 AWG (1.0–6 mm ²): 7 (0.8)	Main 6–2/0 AWG (16–70 mm ²): 120 (13.5) 8 AWG (10 mm ²): 40 (4.5) 14–10 AWG (2.5–6 mm ²): 35 (4.0) Branch 6–2/0 AWG (16–70 mm ²): 120 (13.5) 8 AWG (10 mm ²): 40 (4.5) 4–10 AWG (2.5–6 mm ²): 35 (4.0)	Main 6–2/0 AWG (16–70 mm ²): 120 (13.5) 8 AWG (10 mm ²): 40 (4.5) 14–10 AWG (2.5–6 mm ²): 35 (4.0) Branch 14–4 AWG (2.5–16 mm ²): 35 (4.0)
Lug Material	Tin Plated High Conductive Al	Tin Plated High Conductive Al	Tin Plated High Conductive Al	Tin Plated High Conductive Al
Base Material	High Impact Thermoplastic	High Impact Thermoplastic	General Purpose Phenolic	General Purpose Phenolic
Temperature Rating	–40 to +266 °F (–40 to +130 °C)		–40 to +302 °F (–40 to +150 °C)	
Certifications	 File E60616 Guide XCFR2	 File 70361 Class 6228-01	 RoHS Compliant	 Marked
Flammability Rating	UL94V-0	UL94V-0	UL94V-0	UL94V-0
One Pole Blocks				
Block Catalog Number	9080LBA161101	9080LBA161104	9080LBA162101	9080LBA162104
Clear Plastic Covers	9080LB11	9080LB11	9080LB21	9080LB21
Block Dimensions (D) x (H) x (W)	1.62 x 2.29 x 0.85 in. (41.20 x 58.1 x 21.46 mm)	1.62 x 2.29 x 0.85 in. (41.20 x 58.1 x 21.46 mm)	1.78 x 2.88 x 1.13 in. (45.2 x 73.0 x 28.5 mm)	1.78 x 2.88 x 1.13 in. (45.2 x 73.0 x 28.5 mm)
Two Pole Blocks				
Block Catalog Number	N/A	9080LBA261104	9080LBA262101	9080LBA262104
Clear Plastic Covers	N/A	9080LB12	9080LB22	9080LB22
Block Dimensions (D) x (H) x (W)	N/A	1.62 x 2.29 x 1.48 in. (41.20 x 58.1 x 37.59 mm)	1.78 x 2.88 x 1.94 in. (45.2 x 73.0 x 49.2 mm)	1.78 x 2.88 x 1.94 in. (45.2 x 73.0 x 49.2 mm)
Three Pole Blocks				
Block Catalog Number	9080LBA361101	9080LBA361104	9080LBA362101	9080LBA362104
Clear Plastic Covers	9080LB13	9080LB13	9080LB23	9080LB23
Block Dimensions (D) x (H) x (W)	1.62 x 2.29 x 2.12 in. (41.20 x 58.1 x 53.72 mm)	1.62 x 2.29 x 2.12 in. (41.20 x 58.1 x 53.72 mm)	1.78 x 2.88 x 2.75 in. (45.2 x 73.0 x 69.9 mm)	1.78 x 2.88 x 2.75 in. (45.2 x 73.0 x 69.9 mm)









Terminal Blocks

9080LBA Power Distribution Blocks Copper or Aluminum Wire

Class 9080	Standard			
				
Maximum Voltage Rating	600	600	600	600
Service Class	C	C	C	C
Current Rating, Cu Wire	310 A	335 A	335 A	350 A
Current Rating, Al Wire	250 A	270 A	270 A	270 A
SCCR w/Circuit Breakers	N/A	See page 30.	See page 30.	See page 30.
SCCR with Fuses	N/A	See page 32.	See page 32.	See page 32.
Wire Range Limited to wire class. See "Wire Classes-9080LB Open Power Distribution Blocks" beginning on page 40. Lugs Suitable for Use with 75 °C Conductors	Main (1) #6-350 MCM (16-150 mm ²) Branch (1) #6-350 MCM (16-150 mm ²)	Main (1) #6-400 MCM (16-185 mm ²) Branch (4) 14-2 AWG (2.5-25 mm ²)	Main (1) #6-500 MCM (16-240 mm ²) Branch (6) 14-2 AWG (2.5-25 mm ²)	Main (2) #14-2/0 AWG (2.5-50 mm ²) Branch (6) 14-4 AWG (2.5-16 mm ²)
Tightening Torque lb-in (N·m)	Main #6-350 MCM (16-150 mm ²): 275 (31.0) Branch #6-350 MCM (16-150 mm ²): 275 (31.0)	Main #6-400 MCM (16-185 mm ²): 275 (31.0) Branch 3-2 AWG (35 mm ²): 50 (5.6) 6-4 AWG (16-25 mm ²): 45 (5.1) 8 AWG (10 mm ²): 40 (4.5) 14-10 AWG (2.5-6 mm ²): 35 (4.0)	Main #6-400 MCM (16-185 mm ²): 275 (31.0) Branch 3-2 AWG (35 mm ²): 50 (5.6) 6-4 AWG (10-25 mm ²): 45 (5.1) 8 AWG (10 mm ²): 40 (4.5) 14-10 AWG (2.5-6 mm ²): 35 (4.0)	Main 6-2/0 AWG (16-50 mm ²): 120 (13.5) 8 AWG (10 mm ²): 40 (4.5) 14-10 AWG (2.5-6 mm ²): 35 (4.0) Branch 14-4 AWG (2.5-16 mm ²): 35 (4.0)
Lug Material	Tin Plated High Conductive Al	Tin Plated High Conductive Al	Tin Plated High Conductive Al	Tin Plated High Conductive Al
Base Material	General Purpose Phenolic	General Purpose Phenolic	General Purpose Phenolic	General Purpose Phenolic
Temperature Rating	-40 to +302 °F -40 to +150 °C	-40 to +302 °F (-40 to +150 °C)	-40 to +302 °F (-40 to +150 °C)	-40 to +302 °F (-40 to +150 °C)
Certifications	 File E60616 Guide XCFR2	 File 70361 Class 6228-01	 RoHS Compliant	 Marked
Flammability Rating	UL94V-0	UL94V-0	UL94V-0	UL94V-0
One Pole Blocks				
Block Catalog Number	9080LBA163101	9080LBA163104	9080LBA163106	9080LBA163206
Clear Plastic Covers	9080LB31	9080LB31	9080LB31	9080LB31
Block Dimensions (D) x (H) x (W)	2.61 x 4.00 x 1.92 in. (66.2 x 102.0 x 48.7 mm)	2.61 x 4.00 x 1.92 in. (66.2 x 102.0 x 48.7 mm)	2.61 x 4.00 x 1.92 in. (66.2 x 102.0 x 48.7 mm)	2.61 x 4.00 x 1.92 in. (66.2 x 102.0 x 48.7 mm)
Two Pole Blocks				
Block Catalog Number	9080LBA263101	9080LBA263104	9080LBA263106	9080LBA263206
Clear Plastic Covers	9080LB32	9080LB32	9080LB32	9080LB32
Block Dimensions (D) x (H) x (W)	2.61 x 4.00 x 3.47 in. (66.2 x 102.0 x 88.1 mm)	2.61 x 4.00 x 3.47 in. (66.2 x 102.0 x 88.1 mm)	2.61 x 4.00 x 3.47 in. (66.2 x 102.0 x 88.1 mm)	2.61 x 4.00 x 3.47 in. (66.2 x 102.0 x 88.1 mm)
Three Pole Blocks				
Block Catalog Number	9080LBA363101	9080LBA363104	9080LBA363106	9080LBA363206
Clear Plastic Covers	9080LB33	9080LB33	9080LB33	9080LB33
Block Dimensions (D) x (H) x (W)	2.61 x 4.00 x 5.00 in. (66.2 x 102.0 x 127.0 mm)	2.61 x 4.00 x 5.00 in. (66.2 x 102.0 x 127.0 mm)	2.61 x 4.00 x 5.00 in. (66.2 x 102.0 x 127.0 mm)	2.61 x 4.00 x 5.00 in. (66.2 x 102.0 x 127.0 mm)









Terminal Blocks

9080LBA Power Distribution Blocks Copper or Aluminum Wire

Class 9080	Standard			
				
Maximum Voltage Rating	600	600	600	600
Service Class	C	C	C	C
Current Rating, Cu Wire	420 A	335 A	380 A	380 A
Current Rating, Al Wire	340 A	270 A	310 A	310 A
SCCR w/Circuit Breakers	N/A	See page 30.	See page 30.	See page 30.
SCCR with Fuses	See page 32.	See page 32.	See page 32.	See page 32.
Wire Range Limited to wire class. See "Wire Classes-9080LB Open Power Distribution Blocks" beginning on page 40. Lugs Suitable for Use with 75° C Conductors	Main (1) #4-600 MCM (25-300 mm ²) Branch (1) #4-600 MCM (25-300 mm ²)	Main (1) #6-400 MCM (16-185 mm ²) Branch (8) 14-2 AWG (2.5-25 mm ²)	Main (1) #4-500 MCM (25-240 mm ²) Branch (6) #14-2/0 AWG (2.5-50 mm ²)	Main (1) #4-500 MCM (25-240 mm ²) Branch (12) 14-2 AWG (2.5-25 mm ²)
Tightening Torque lb-in (N·m)	Main #4-600 MCM (25-300 mm ²): 500 (56.5) Branch #4-600 MCM (25-300 mm ²): 500 (56.5)	Main #6-400 MCM (16-185 mm ²): 275 (31.0) Branch 3-2 AWG (35 mm ²): 50 (5.6) 6-4 AWG (16-25 mm ²): 45 (5.1) 8 AWG (10 mm ²): 40 (4.5) 14-10 AWG (2.5-6 mm ²): 35 (4.0)	Main #4-500 MCM (25-240 mm ²): 375 (42.3) Branch 6-2/0 AWG (16-50 mm ²): 120 (13.5) 8 (10 mm ²): 40 (4.5) 14-10 AWG (2.5-6 mm ²): 35 (4.0)	Main #4-500 MCM (25-240 mm ²): 375 (42.3) Branch 3-2 AWG (35 mm ²): 50 (5.6) 6-4 AWG (16-25 mm ²): 45 (5.1) 8 AWG (10 mm ²): 40 (4.5) 14-10 AWG (2.5-6 mm ²): 35 (4.0)
Lug Material	Tin Plated High Conductive Al	Tin Plated High Conductive Al	Tin Plated High Conductive Al	Tin Plated High Conductive Al
Base Material	General Purpose Phenolic	General Purpose Phenolic	General Purpose Phenolic	General Purpose Phenolic
Temperature Rating	-40 to +302 °F (-40 to +150 °C)	-40 to +302 °F (-40 to +150 °C)	-40 to +302 °F (-40 to +150 °C)	-40 to +302 °F (-40 to +150 °C)
Certifications	 File E60616 Guide XCFR2	 File 70361 Class 6228-01	 RoHS Compliant	 Marked
Flammability Rating	UL94V-0	UL94V-0	UL94V-0	UL94V-0
One Pole Blocks				
Block Catalog Number	9080LBA164101	9080LBA164108	9080LBA165106	9080LBA165112
Clear Plastic Covers	9080LB41	9080LB41	9080LB51	9080LB51
Block Dimensions (D) x (H) x (W)	3.16 x 4.75 x 2.25 in. (60.2 x 121.0 x 56.7 mm)	3.16 x 4.75 x 2.25 in. (60.2 x 121.0 x 56.7 mm)	3.12 x 5.50 x 3.17 in. (79.2 x 140.0 x 80.4 mm)	3.12 x 5.50 x 3.17 in. (79.2 x 140.0 x 80.4 mm)
Two Pole Blocks				
Block Catalog Number	N/A	9080LBA264108	9080LBA265106	9080LBA265112
Clear Plastic Covers	N/A	9080LB42	9080LB52	9080LB52
Block Dimensions (D) x (H) x (W)	N/A	3.16 x 4.75 x 4.12 in. (60.2 x 121.0 x 105.0 mm)	3.12 x 5.50 x 5.88 in. (79.2 x 140.0 x 149.0 mm)	3.12 x 5.50 x 5.88 in. (79.2 x 140.0 x 149.0 mm)
Three Pole Blocks				
Block Catalog Number	9080LBA364101	9080LBA364108	9080LBA365106	9080LBA365112
Clear Plastic Covers	9080LB43	9080LB43	9080LB53	9080LB53
Block Dimensions (D) x (H) x (W)	3.16 x 4.75 x 6.00 in. (60.2 x 121.0 x 152.0 mm)	3.16 x 4.75 x 6.00 in. (60.2 x 121.0 x 152.0 mm)	3.12 x 5.50 x 8.54 in. (79.2 x 140.0 x 217.0 mm)	3.12 x 5.50 x 8.54 in. (79.2 x 140.0 x 217.0 mm)









Terminal Blocks

9080LBA Power Distribution Blocks Copper or Aluminum Wire

Class 9080	Standard			
				
Maximum Voltage Rating	600	600	600	600
Service Class	C	C	C	C
Current Rating, Cu Wire	620 A	760 A	760 A	760 A
Current Rating, Al Wire	500 A	620 A	620 A	620 A
SCCR w/Circuit Breakers	N/A	N/A	N/A	N/A
SCCR with Fuses	See page 32.	See page 32.	See page 32.	See page 32.
Wire Range Limited to wire class. See "Wire Classes-9080LB Open Power Distribution Blocks" beginning on page 40. Lugs Suitable for Use with 75° C Conductors	Main (2) #4-350 MCM (25-150 mm ²) Branch (2) #4-350 MCM (25-150 mm ²)	Main (2) #4-500 MCM (25-240 mm ²) Branch (2) #4-500 MCM (25-240 mm ²)	Main (2) #4-500 MCM (25-240 mm ²) Branch (8) 14-2/0 AWG (2.5-50 mm ²)	Main (2) #4-500 MCM (25-240 mm ²) Branch (12) 14-4 AWG (2.5-16 mm ²)
Tightening Torque lb-in (N•m)	Main #6-350 MCM (16-150 mm ²): 275 (31.0) Branch #6-350 MCM (16-150 mm ²): 275 (31.0)	Main #4-500 MCM (25-240 mm ²): 375 (42.3) Branch #4-500 MCM (25-240 mm ²): 375 (42.3)	Main #4-500 MCM (25-240 mm ²): 375 (42.3) Branch 6-2/0 AWG (16-50 mm ²): 120 (13.5) 8 AWG (10 mm ²): 40 (4.5) 14-10 AWG (2.5-6 mm ²): 35 (4.0)	Main #4-500 MCM (25-240 mm ²): 375 (42.3) Branch 14-4 AWG (2.5-16 mm ²): 35 (4.0)
Lug Material	Tin Plated High Conductive Al	Tin Plated High Conductive Al	Tin Plated High Conductive Al	Tin Plated High Conductive Al
Base Material	General Purpose Phenolic	General Purpose Phenolic	General Purpose Phenolic	General Purpose Phenolic
Temperature Rating	-40 to +302 °F (-40 to +150 °C)	-40 to +302 °F (-40 to +150 °C)	-40 to +302 °F (-40 to +150 °C)	-40 to +302 °F (-40 to +150 °C)
Certifications	 File E60616 Guide XCFR2  File 70361 Class 6228-01  RoHS Compliant  Marked			
Flammability Rating	UL94V-0	UL94V-0	UL94V-0	UL94V-0
One Pole Blocks				
Block Catalog Number	9080LBA165202	9080LBA1652021	9080LBA165208	9080LBA165212
Clear Plastic Covers	9080LB51	9080LB51	9080LB51	9080LB51
Block Dimensions (D) x (H) x (W)	3.12 x 5.50 x 3.17 in. (79.2 x 140.0 x 80.4 mm)	3.12 x 5.50 x 3.17 in. (79.2 x 140.0 x 80.4 mm)	3.12 x 5.50 x 3.17 in. (79.2 x 140.0 x 80.4 mm)	3.12 x 5.50 x 3.17 in. (79.2 x 140.0 x 80.4 mm)
Two Pole Blocks				
Block Catalog Number	9080LBA265202	9080LBA2652021	9080LBA265208	9080LBA265212
Clear Plastic Covers	9080LB52	9080LB52	9080LB52	9080LB52
Block Dimensions (D) x (H) x (W)	3.12 x 5.50 x 5.88 in. (79.2 x 140.0 x 149.0 mm)	3.12 x 5.50 x 5.88 in. (79.2 x 140.0 x 149.0 mm)	3.12 x 5.50 x 5.88 in. (79.2 x 140.0 x 149.0 mm)	3.12 x 5.50 x 5.88 in. (79.2 x 140.0 x 149.0 mm)
Three Pole Blocks				
Block Catalog Number	9080LBA365202	9080LBA3652021	9080LBA365208	9080LBA365212
Clear Plastic Covers	9080LB53	9080LB53	9080LB53	9080LB53
Block Dimensions (D) x (H) x (W)	3.12 x 5.50 x 8.54 in. (79.2 x 140.0 x 217.0 mm)	3.12 x 5.50 x 8.54 in. (79.2 x 140.0 x 217.0 mm)	3.12 x 5.50 x 8.54 in. (79.2 x 140.0 x 217.0 mm)	3.12 x 5.50 x 8.54 in. (79.2 x 140.0 x 217.0 mm)









Terminal Blocks

9080LBA and 9080LBC Power Distribution Blocks Copper Wire Only or Aluminum/Copper Wire

Class 9080	Standard			
				
Maximum Voltage Rating	600	600	600	600
Service Class	C	C	C	C
Current Rating, Cu Wire	175 A	150 A	175 A	255 A
Current Rating, Al Wire	135 A	N/A	N/A	N/A
SCCR w/Circuit Breakers	See page 30.	See page 30.	See page 30.	N/A
SCCR with Fuses	See page 32.	N/A	See page 32.	N/A
Wire Range Limited to wire class. See "Wire Classes-9080LB Open Power Distribution Blocks" beginning on page 40. Lugs Suitable for Use with 75° C Conductors	Main (1) 14-2/0 AWG (2.5-50 mm ²) Branch (6) 14-4 AWG (2.5-16 mm ²)	Main (1) 18-1/0 AWG (1.0-50 mm ²) Branch (1) 18-1/0 AWG (1.0-50 mm ²)	Main (1) 14-2/0 AWG (2.5-50 mm ²) Branch (4) 14-4 AWG (2.5-16 mm ²)	Main (1) #6-250 MCM (16-120 mm ²) Branch (1) #6-250 MCM (16-120 mm ²)
Tightening Torque lb-in (N•m)	Main 6-2/0 AWG (16-50 mm ²): 120 (13.5) 8 AWG (10 mm ²): 40 (4.5) 14-10 AWG (2.5-6 mm ²): 35 (4.0) Branch 14-4 AWG (2.5-16 mm ²): 35 (4.0)	Main 3-1/0 AWG (35-50 mm ²): 50 (5.6) 6-4 AWG (16-25 mm ²): 45 (5.1) 8 AWG (10 mm ²): 40 (4.5) 18-10 AWG (1.0-6 mm ²): 35 (4.0) Branch 3-1/0 AWG (35-50 mm ²): 50 (5.6) 6-4 AWG (16-25 mm ²): 45 (5.1) 8 AWG (10 mm ²): 40 (4.5) 18-10 AWG (1.0-6 mm ²): 35 (4.0)	Main 6-2/0 AWG (16-50 mm ²): 120 (13.5) 8 AWG (10 mm ²): 40 (4.5) 14-10 AWG (2.5-6 mm ²): 35 (4.0) Branch 14-4 AWG (2.5-16 mm ²): 35 (4.0)	Main #6-250 MCM (16-120 mm ²): 375 (42.3) Branch #6-250 MCM (16-120 mm ²): 375 (42.3)
Lug Material	Tin Plated High Conductive Al	Tin Plated High Conductive Cu	Tin Plated High Conductive Cu	Tin Plated High Conductive Cu
Base Material	General Purpose Phenolic	General Purpose Phenolic	General Purpose Phenolic	General Purpose Phenolic
Temperature Rating	-40 to +302 °F (-40 to +150 °C)		-40 to +302 °F (-40 to +150 °C)	
Certifications	 File E60616 Guide XCFR2	 File 70361 Class 6228-01	 RoHS Compliant	 Marked
Flammability Rating	UL94V-0	UL94V-0	UL94V-0	UL94V-0
One Pole Blocks				
Block Catalog Number	N/A	9080LBC162101	9080LBC162104	9080LBC163101
Clear Plastic Covers	N/A	9080LB21	9080LB21	9080LB31
Block Dimensions (D) x (H) x (W)	N/A	1.78 x 2.88 x 1.13 in. (45.2 x 73.0 x 28.5 mm)	1.78 x 2.88 x 1.13 in. (45.2 x 73.0 x 28.5 mm)	2.61 x 4.00 x 1.92 in. (66.2 x 102.0 x 48.7 mm)
Two Pole Blocks				
Block Catalog Number	N/A	N/A	9080LBC262104	N/A
Clear Plastic Covers	N/A	N/A	9080LB22	N/A
Block Dimensions (D) x (H) x (W)	N/A	N/A	1.78 x 2.88 x 1.94 in. (45.2 x 73.2 x 49.3 mm)	N/A
Three Pole Blocks				
Block Catalog Number	9080LBA362106	9080LBC362101	9080LBC362104	9080LBC363101
Clear Plastic Covers	N/A	9080LB23	9080LB23	9080LB33
Block Dimensions (D) x (H) x (W)	2.10 x 2.90 x 5.37 in. (53.4 x 73.7 x 136.4 mm)	1.78 x 2.88 x 2.75 in. (45.2 x 73.0 x 69.9 mm)	1.78 x 2.88 x 2.75 in. (45.2 x 73.0 x 69.9 mm)	2.61 x 4.00 x 5.00 in. (66.2 x 102.0 x 127.0 mm)
 DIN 3 (35 mm) Track Adapter	9080FBDIN3	N/A	N/A	N/A

Terminal Blocks

9080LBC Power Distribution Blocks Copper Wire Only









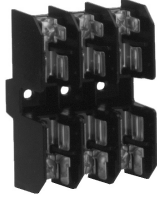
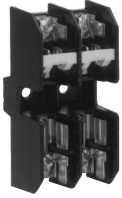

Class 9080	Standard			
				
Maximum Voltage Rating	600	600	600	600
Service Class	C	C	C	C
Current Rating, Cu Wire	380 A	350 A	760 A	760 A
Current Rating, Al Wire	N/A	N/A	N/A	N/A
SCCR w/Circuit Breakers	N/A	See page 30.	N/A	N/A
SCCR with Fuses	See page 32.	See page 32.	See page 32.	See page 32.
Wire Range Limited to wire class. See "Wire Classes-9080LB Open Power Distribution Blocks" beginning on page 40. Lugs Suitable for Use with 75° C Conductors	Main (1) #4-500 MCM (25-240 mm ²) Branch (6) 14-2 AWG (2.5-25 mm ²)	Main (2) 14-2/0 AWG (2.5-50 mm ²) Branch (6) 14-4 AWG (2.5-16 mm ²)	Main (2) #4-500 MCM (25-240 mm ²) Branch (8) 14-2/0 AWG (2.5-50 mm ²)	Main (2) #4-500 MCM (25-240 mm ²) Branch (12) 14-2 AWG (2.5-25 mm ²)
Tightening Torque lb-in (N•m)	Main #4-500 MCM (25-240 mm ²): 375 (42.3) Branch 3-2 AWG (35 mm ²): 50 (5.6) 6-4 AWG (16-25 mm ²): 45 (5.1) 8 AWG (10 mm ²): 40 (4.5) 14-10 AWG (2.5-6 mm ²): 35 (4.0)	Main 6-2/0 AWG (16-50 mm ²): 120 (13.5) 8 AWG (10 mm ²): 40 (4.5) 14-10 AWG (2.5-6 mm ²): 35 (4.0) Branch 14-4 AWG (2.5-16 mm ²): 35 (4.0)	Main #4-500 MCM (25-240 mm ²): 375 (42.3) Branch 6-2/0 AWG (16-50 mm ²): 120 (13.5) 8 AWG (10 mm ²): 40 (4.5) 14-10 AWG (2.5-6 mm ²): 35 (4.0)	Main #4-500 MCM (25-240 mm ²): 375 (42.3) Branch 3-2 AWG (35 mm ²): 50 (5.6) 6-4 AWG (16-25 mm ²): 45 (5.1) 8 AWG (10 mm ²): 40 (4.5) 14-10 AWG (2.5-6 mm ²): 35 (4.0)
Lug Material	Tin Plated High Conductive Cu	Tin Plated High Conductive Cu	Tin Plated High Conductive Cu	Tin Plated High Conductive Cu
Base Material	General Purpose Phenolic	General Purpose Phenolic	General Purpose Phenolic	General Purpose Phenolic
Temperature Rating	-40 to +302 °F (-40 to +150 °C)	-40 to +302 °F (-40 to +150 °C)	-40 to +302 °F (-40 to +150 °C)	-40 to +302 °F (-40 to +150 °C)
Certifications	 File E60616 Guide XCFR2	 File 70361 Class 6228-01	 RoHS Compliant	 Marked
Flammability Rating	UL94V-0	UL94V-0	UL94V-0	UL94V-0
One Pole Blocks				
Block Catalog Number	9080LBC163106	9080LBC163206	9080LBC165208	9080LBC165212
Clear Plastic Covers	9080LB31	9080LB31	9080LB51	9080LB51
Block Dimensions (D) x (H) x (W)	2.61 x 4.00 x 1.92 in. (66.2 x 102.0 x 48.7 mm)	2.61 x 4.00 x 1.92 in. (66.2 x 102.0 x 48.7 mm)	3.12 x 5.50 x 3.17 in. (79.2 x 140.0 x 80.5 mm)	3.12 x 5.50 x 3.17 in. (79.2 x 140.0 x 80.5 mm)
Two Pole Blocks				
Block Catalog Number	9080LBC263106	9080LBC263206	N/A	N/A
Clear Plastic Covers	9080LB32	9080LB32	N/A	N/A
Block Dimensions (D) x (H) x (W)	2.61 x 4.00 x 3.47 in. (66.2 x 102.0 x 88.1 mm)	2.61 x 4.00 x 3.47 in. (66.2 x 102.0 x 88.1 mm)	N/A	N/A
Three Pole Blocks				
Block Catalog Number	9080LBC363106	9080LBC363206	9080LBC365208	9080LBC365212
Clear Plastic Covers	N/A	9080LB33	9080LB53	9080LB53
Block Dimensions (D) x (H) x (W)	2.61 x 4.00 x 5.00 in. (66.2 x 102.0 x 127.0 mm)	2.61 x 4.00 x 5.00 in. (66.2 x 102.0 x 127.0 mm)	3.12 x 5.50 x 8.54 in. (79.2 x 140.0 x 217.0 mm)	3.12 x 5.50 x 8.54 in. (79.2 x 140.0 x 217.0 mm)

Terminal Blocks

9080FB Fuseholders 30 A Rated

Class 9080	Class H Fuses		Class R Fuses	
				
Maximum Voltage Rating	250	600	250	600
Wire Range Lugs Suitable for Use with 75° C Conductors	14–10 AWG (2.5-4 mm ²)	14–10 AWG (2.5-4 mm ²)	14–10 AWG (2.5-4 mm ²)	14–10 AWG (2.5-4 mm ²)
Wire Type	Solid or Stranded Copper Wire	Solid or Stranded Copper Wire	Solid or Stranded Copper Wire	Solid or Stranded Copper Wire
Lug Termination	Pressure Wire Connector	Pressure Wire Connector	Pressure Wire Connector	Pressure Wire Connector
Clip Material	Copper Alloy Tin Plated	Copper Alloy Tin Plated	Copper Alloy Tin Plated	Copper Alloy Tin Plated
Clip Type	Reinforced	Reinforced	Reinforced	Reinforced
Base Material	High Impact Thermoplastic	General Purpose Phenolic	High Impact Thermoplastic	General Purpose Phenolic
Tightening Torque lb-in (N·m)	25 (2.8)	25 (2.8)	25 (2.8)	25 (2.8)
Temperature Rating	-40 to +257 °F (-40 to +125 °C)	-40 to +302 °F (-40 to +150 °C)	-40 to +257 °F (-40 to +125 °C)	-40 to +302 °F (-40 to +150 °C)
Fuse Size (Dia. x Length)	9/16" x 2"	13/16" x 5"	9/16" x 2"	13/16" x 5"
AIC Rating in accordance with UL512	10,000	10,000	200,000	200,000
Certifications	 File E40747 Guide IZLT  File 70360/ Class 6225-01  RoHS Compliant  Marked			
Flammability Rating	UL94V-0	UL94V-0	UL94V-0	UL94V-0
One Pole Blocks				
Catalog Number	9080FB1211	N/A	9080FB1211R	N/A
Dimensions (D) x (H) x (W)	1.38 x 3.00 x 1.12 in. (35.1 x 76.2 x 28.4 mm)	1.69 x 6.25 x 1.63 in. (42.9 x 159.0 x 41.4 mm)	1.38 x 3.00 x 1.12 in. (35.1 x 76.2 x 28.4 mm)	N/A
Two Pole Blocks				
Catalog Number	9080FB2211	9080FB2611	9080FB2211R	N/A
Dimensions (D) x (H) x (W)	1.38 x 3.00 x 1.91 in. (35.1 x 76.2 x 48.5 mm)	1.69 x 6.25 x 2.94 in. (42.9 x 159.0 x 74.7 mm)	1.38 x 3.00 x 1.91 in. (35.1 x 76.2 x 48.5 mm)	N/A
Three Pole Blocks				
Catalog Number	9080FB3211	9080FB3611	9080FB3211R	9080FB3611R
Dimensions (D) x (H) x (W)	1.38 x 3.00 x 2.95 in. (35.1 x 76.2 x 74.9 mm)	1.69 x 6.25 x 4.25 in. (42.9 x 159.0 x 108.0 mm)	1.38 x 3.00 x 2.95 in. (35.1 x 76.2 x 74.9 mm)	1.69 x 6.25 x 4.25 in. (42.9 x 159.0 x 108.0 mm)
 DIN 3 (35 mm) Track Adapter	9080FBDIN3	N/A	9080FBDIN3	N/A

Terminal Blocks 9080FB Fuseholders 30 A Rated





Class 9080	Class M Fuses	Class CC Fuses
		
Maximum Voltage Rating	600	600
Wire Range Lugs Suitable for Use with 75° C Conductors	14–10 AWG (2.5–4 mm ²)	14–10 AWG (2.5–4 mm ²)
Wire Type	Solid or Stranded Copper Wire	Solid or Stranded Copper Wire
Lug Termination	Pressure Wire Connector	Pressure Wire Connector
Clip Material	Copper Alloy Tin Plated	Copper Alloy Tin Plated
Clip Type	Standard	Standard
Base Material	High Impact Thermoplastic	High Impact Thermoplastic
Tightening Torque lb-in (N•m)	25 (2.8)	25 (2.8)
Temperature Rating	-40 to +257 °F (-40 to +125 °C)	-40 to +257 °F (-40 to +125 °C)
Fuse Size (Dia. x Length)	13/32" x 1 1/2"	13/32" x 1 1/2"
AIC Rating in accordance with UL512	100,000	200,000
Certifications	 File E40747 / Guide IZLT2  File 70360 Class 6225-01  RoHS Compliant  CE Marked	 File E40747 / Guide IZLT  File 70360 Class 6225-01  RoHS Compliant  CE Marked
Flammability Rating	UL94V-0	UL94V-0
One Pole Blocks		
Catalog Number	9080FB1611M	9080FB1611CC
Dimensions (D) x (H) x (W)	1.29 x 3.13 x 0.85 in. (32.8 x 79.5 x 21.6 mm)	1.29 x 3.13 x 0.85 in. (32.8 x 79.5 x 21.6 mm)
Two Pole Blocks		
Catalog Number	9080FB2611M	9080FB2611CC
Dimensions (D) x (H) x (W)	1.29 x 3.13 x 1.60 in. (32.8 x 79.5 x 40.6 mm)	1.29 x 3.13 x 1.60 in. (32.8 x 79.5 x 40.6 mm)
Three Pole Blocks		
Catalog Number	9080FB3611M	9080FB3611CC
Dimensions (D) x (H) x (W)	1.29 x 3.13 x 2.35 in. (32.8 x 79.5 x 59.7 mm)	1.29 x 3.13 x 2.35 in. (32.8 x 79.5 x 59.7 mm)
	9080FBDIN3	9080FBDIN3
DIN 3 (35 mm) Track Adapter		

Terminal Blocks

9080FB Fuseholders 60 A Rated

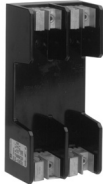
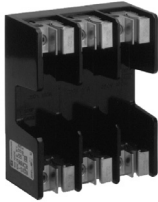
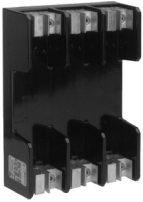
Class 9080	Class R Fuses		Class J Fuses
			
Maximum Voltage Rating	250	600	600
Wire Range Lugs Suitable for Use with 75° C Conductors	14–2 AWG (2.5–25 mm ²)	14–2 AWG (2.5–25 mm ²)	14–2 AWG (2.5–25 mm ²)
Wire Type	Solid or Stranded Copper or Aluminum Wire	Solid or Stranded Copper or Aluminum Wire	Solid or Stranded Copper or Aluminum Wire
Lug Termination	Box Lug Connector	Box Lug Connector	Box Lug Connector
Clip Material	Copper Alloy Tin Plated	Copper Alloy Tin Plated	Copper Alloy Tin Plated
Clip Type	Reinforced	Reinforced	Reinforced
Base Material	High Impact Thermoplastic	General Purpose Phenolic	High Impact Thermoplastic
Tightening Torque lb-in (N•m)	3–2 AWG (25–35 mm ²): 50 (5.6) 6–4 AWG (16–25 mm ²): 45 (5.1) 8 AWG (10 mm ²): 40 (4.5) 14–10 AWG (2.5–6 mm ²): 35 (4.0)	3–2 AWG (25–35 mm ²): 50 (5.6) 6–4 AWG (16–25 mm ²): 45 (5.1) 8 AWG (10 mm ²): 40 (4.5) 14–10 AWG (2.5–6 mm ²): 35 (4.0)	3–2 AWG (25–35 mm ²): 50 (5.6) 6–4 AWG (16–25 mm ²): 45 (5.1) 8 AWG (10 mm ²): 40 (4.5) 14–10 AWG (2.5–6 mm ²): 35 (4.0)
Temperature Rating	-40 to +257 °F (-40 to +125 °C)	-40 to +302 °F (-40 to +150 °C)	-40 to +257 °F (-40 to +125 °C)
Fuse Size (Dia. x Length)	13/16" x 3"	1 1/16" x 5 1/2"	1 1/16" x 2 3/8"
AIC Rating in accordance with UL512	200,000	200,000	200,000
Certifications	 File E40747 Guide IZLT	 File 70360 Class 6225-01	 RoHS Compliant  Marked
Flammability Rating	UL94V-0	UL94V-0	UL94V-0
One Pole Blocks			
Catalog Number	9080FB1221R	N/A	N/A
Dimensions (D) x (H) x (W)	2.01 x 4.83 x 1.48 in. (51.1 x 123.0 x 37.7 mm)	N/A	N/A
Two Pole Blocks			
Catalog Number	9080FB2221R	N/A	N/A
Dimensions (D) x (H) x (W)	2.01 x 4.83 x 2.86 in. (51.1 x 123.0 x 72.7 mm)	N/A	2.09 x 4.07 x 3.20 in. (53.0 x 103.0 x 81.2 mm)
Three Pole Blocks			
Catalog Number	N/A	9080FB3621R	9080FB3621J
Dimensions (D) x (H) x (W)	N/A	2.19 x 6.75 x 5.08 in. (55.6 x 171.4 x 129.0 mm)	2.09 x 4.07 x 4.72 in. (53.0 x 103.0 x 120.0 mm)

Terminal Blocks 9080FB Fuseholders 100 A Rated

Class 9080	Class H Fuses	Class R Fuses	
			
Maximum Voltage Rating	600	250	600
Current Rating	100	100	100
Wire Range Lugs Suitable for Use with 75° C Conductors	6–2/0 AWG (16–50 mm ²)	6–2/0 AWG (16–50 mm ²)	6–2/0 AWG (16–50 mm ²)
Wire Type	Solid or Stranded Cu or Al Wire	Solid or Stranded Cu or Al Wire	Solid or Stranded Cu or Al Wire
Lug Termination	Box Lug Connector	Box Lug Connector	Box Lug Connector
Clip Material	One piece Aluminum w/ Stainless Steel Spring	One piece Aluminum w/ Copper Spring Tin Plated	One piece Aluminum w/ Copper Spring Tin Plated
Clip Type	Reinforced	Reinforced	Reinforced
Base Material	General Purpose Phenolic	General Purpose Phenolic	General Purpose Phenolic
Tightening Torque lb-in (N•m)	120 (13.6)	120 (13.6)	120 (13.6)
Temperature Rating	-40 to +302 °F (-40 to +150 °C)	-40 to +302 °F (-40 to +150 °C)	-40 to +302 °F (-40 to +150 °C)
Fuse Size (Dia. x Length)	1" x 7 7/8"	1" x 5 7/8"	1" x 7 7/8"
AIC Rating in accordance with UL512	10,000	20,000	20,000
Certifications	 File E40747 Guide IZLT	 File 70360 Class 6225-01	 RoHS Compliant  Marked
Flammability Rating	UL94V-0	UL94V-0	UL94V-0
One Pole Blocks			
Catalog Number	N/A	9080FB1231R	N/A
Dimensions (D) x (H) x (W)	N/A	2.44 x 6.12 x 1.93 in. (62.0 x 155.5 x 49.0 mm)	N/A
Two Pole Blocks			
Catalog Number	N/A	N/A	N/A
Dimensions (D) x (H) x (W)	N/A	N/A	N/A
Three Pole Blocks			
Catalog Number	9080FB3631	N/A	9080FB3631R
Dimensions (D) x (H) x (W)	2.60 x 8.12 x 5.73 in. (66.0 x 206.2 x 145.5 mm)	N/A	2.60 x 8.12 x 5.73 in. (66.0 x 206.2 x 145.5 mm)

Terminal Blocks

Enclosed Power Distribution Blocks Approximate Dimensions

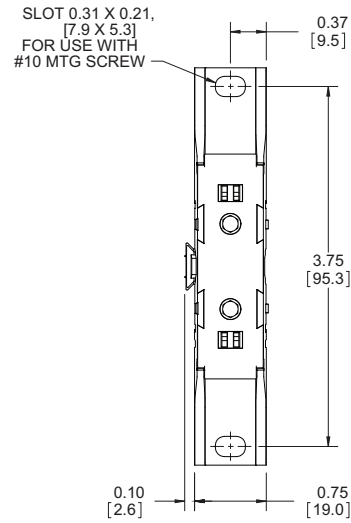
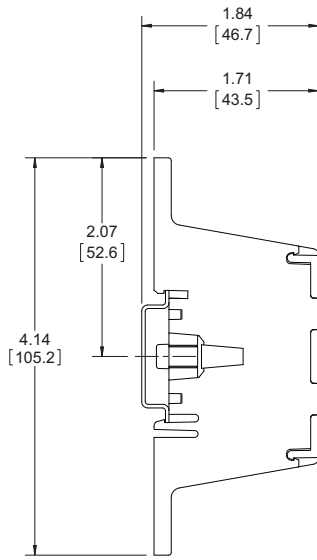

Dimensions: $\frac{\text{in.}}{[\text{mm}]}$

NSYEBAD11611, NSYEBAD11614

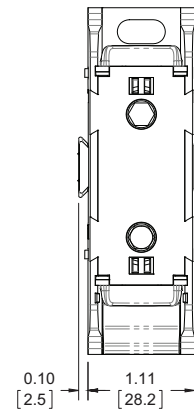
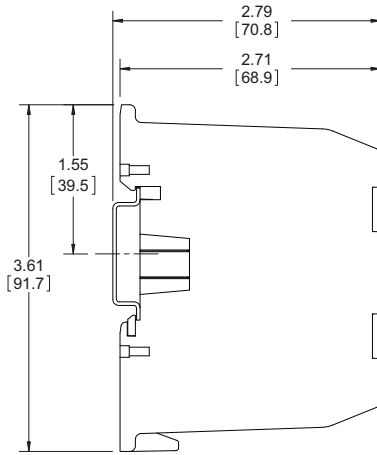

Dimensions: $\frac{\text{in.}}{[\text{mm}]}$

NSYEBAD12611, NSYEBAP12611, NSYEBAD12614, NSYEBAP12614, NSYEBAD12614, NSYEBAP12614, NSYEBAD12614, NSYEBAP12614

Terminal Blocks

Enclosed Power Distribution Blocks Approximate Dimensions

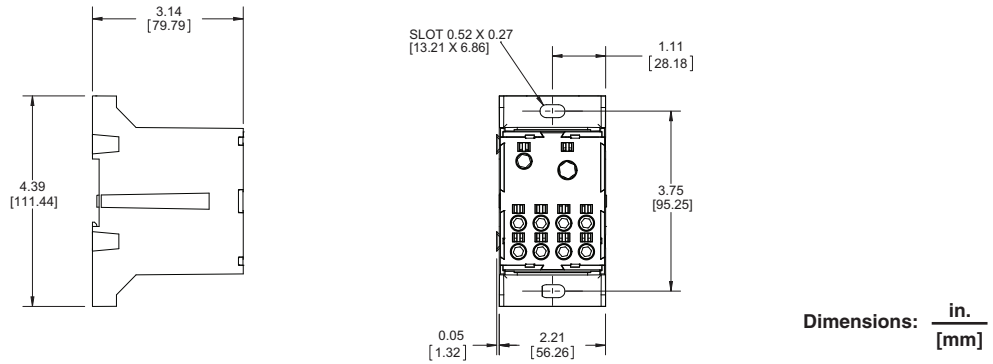

NSYEBAD13618, NSYEBAP13618, NSYEBAD25622, NSYEBAP25622, NSYEBBCD13618, NSYEBBCD25622, NSYEBBCP13618, NSYEBBCP25622

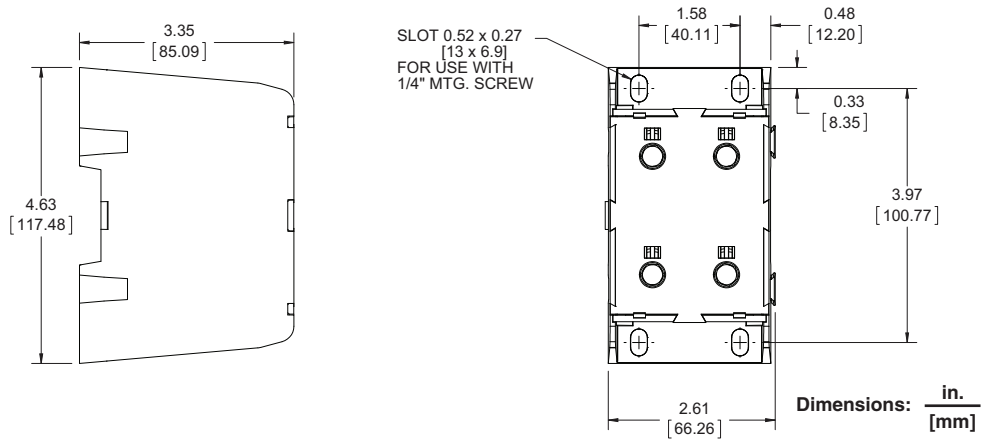

NSYEBAP27622, NSYEBAP27628, NSYEBBCP27628

Terminal Blocks

9080LBA and 9080LBC Power Distribution Blocks Approximate Dimensions

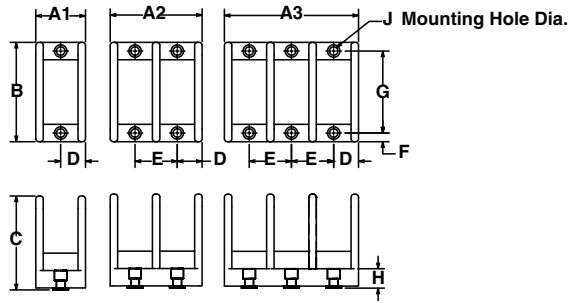

One-pole	Two-poles	Three-poles	A1	A2	A3	B	C	D	E	F	G	H	J
LBA161101	N/A	LBA361101	0.85 (21.46)	1.48 (37.59)	2.12 (53.72)	2.29 (58.1)	1.62 (41.20)	0.38 (9.7)	0.64 (16.2)	0.18 (4.5)	1.93 (49.1)	0.32 (8.1)	0.201 (5.11)
LBA161104	LBA261104	LBA361104	1.13 (28.5)	1.94 (49.2)	2.75 (69.9)	2.88 (73.0)	1.78 (45.2)	0.56 (14.0)	0.81 (21.0)	0.31 (7.9)	2.25 (57.2)	0.24 (6.0)	0.205 (5.21)
LBA162101	LBA262101	LBA362101											
LBA162104	LBA262104	LBA362104											
LBC162101	N/A	LBC362101	1.92 (48.7)	3.47 (88.1)	5.00 (127.0)	4.00 (102.0)	2.61 (66.2)	0.97 (25.0)	1.53 (38.9)	0.31 (7.9)	3.38 (85.7)	0.40 (10.0)	0.203 (5.16)
LBC162104	LBC262104	LBC362104											
LBA163101	LBA263101	LBA363101											
LBA163104	LBA263104	LBA363104	1.92 (48.7)	3.47 (88.1)	5.00 (127.0)	4.00 (102.0)	2.61 (66.2)	0.97 (25.0)	1.53 (38.9)	0.31 (7.9)	3.38 (85.7)	0.40 (10.0)	0.203 (5.16)
LBA163106	LBA263106	LBA363106											
LBA163206	LBA263206	LBA363206											
LBC163101	N/A	LBC363101	1.92 (48.7)	3.47 (88.1)	5.00 (127.0)	4.00 (102.0)	2.61 (66.2)	0.97 (25.0)	1.53 (38.9)	0.31 (7.9)	3.38 (85.7)	0.40 (10.0)	0.203 (5.16)
LBC163106	LBC263106	LBC363106											
LBC163206	LBC263206	LBC363206											
LBA164101	N/A	LBA364101	2.25 (56.7)	4.12 (105.0)	6.00 (152.0)	4.75 (121.0)	3.16 (80.2)	1.12 (28.5)	1.88 (47.7)	0.31 (7.9)	4.16 (106.0)	0.53 (13.0)	0.200 (5.08)
LBA164108	LBA264108	LBA364108	3.17 (80.4)	5.88 (149.0)	8.54 (217.0)	5.50 (140.0)	3.12 (79.2)	1.58 (40.2)	2.69 (68.2)	0.38 (9.5)	4.75 (121.0)	0.50 (13.0)	0.265 (6.73)
LBA165202	LBA265202	LBA365202											
LBA1652021	LBA2652021	LBA3652021											
LBA165106	LBA265106	LBA365106	3.17 (80.4)	5.88 (149.0)	8.54 (217.0)	5.50 (140.0)	3.12 (79.2)	1.58 (40.2)	2.69 (68.2)	0.38 (9.5)	4.75 (121.0)	0.50 (13.0)	0.265 (6.73)
LBA165112	LBA265112	LBA365112											
LBA165212	LBA265212	LBA365212											
LBC165208	N/A	LBC365208	3.17 (80.4)	5.88 (149.0)	8.54 (217.0)	5.50 (140.0)	3.12 (79.2)	1.58 (40.2)	2.69 (68.2)	0.38 (9.5)	4.75 (121.0)	0.50 (13.0)	0.265 (6.73)
LBC165212	N/A	LBC365212											

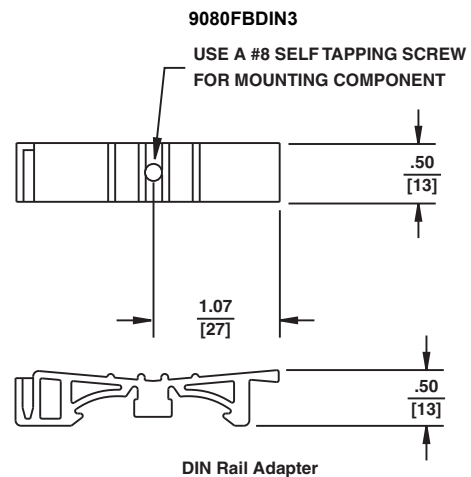
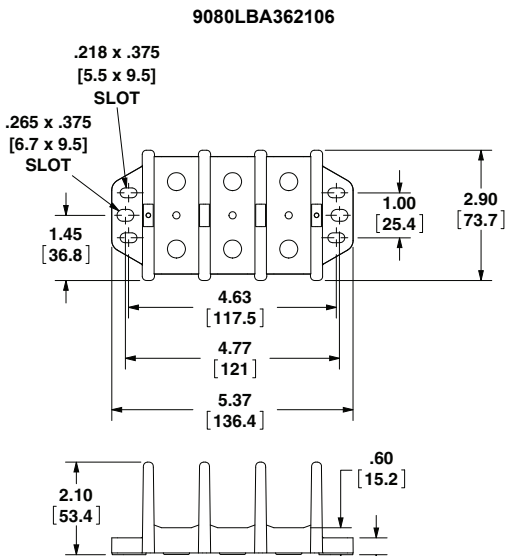

Dimensions: $\frac{\text{in.}}{[\text{mm}]}$

Terminal Blocks

9080FB Fuseholder Approximate Dimensions 250 V, 30 and 60 A

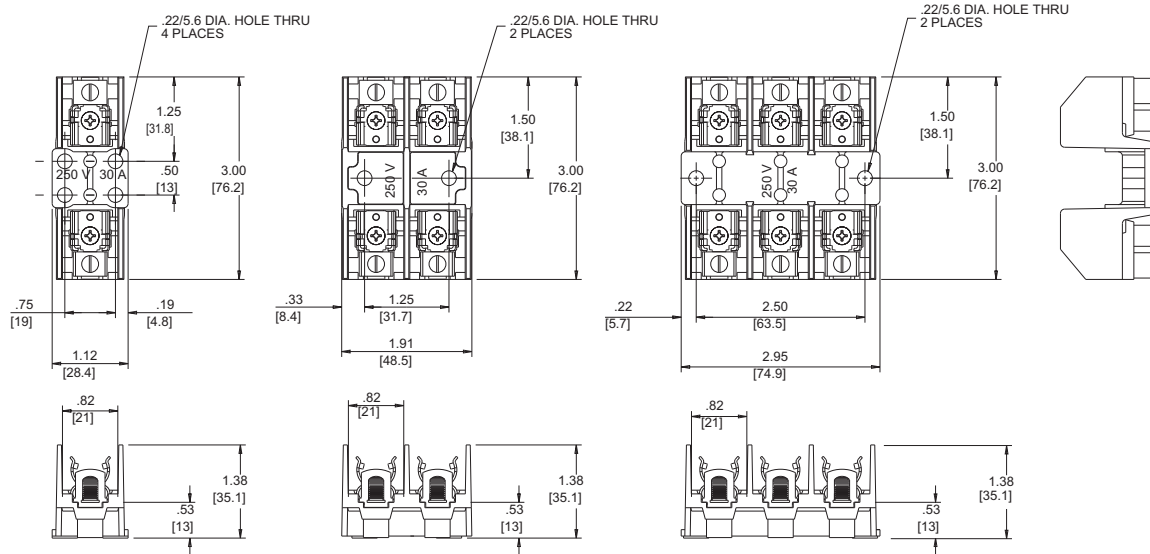

FB1211
FB1211R

FB2211
FB2211R

FB3211
FB3211R

Dimensions: $\frac{\text{in.}}{[\text{mm}]}$

30 A, 250 V 9080FB Fuseholders

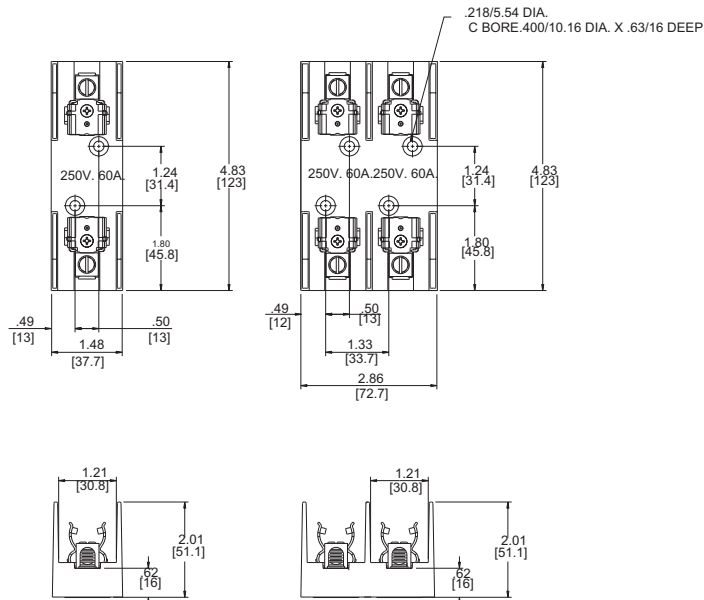

FB1221R

FB2221R

Dimensions: $\frac{\text{in.}}{[\text{mm}]}$

60 A, 250 V 9080FB Fuseholders

Terminal Blocks
9080FB Fuseholder Approximate Dimensions 250 V, 100 A

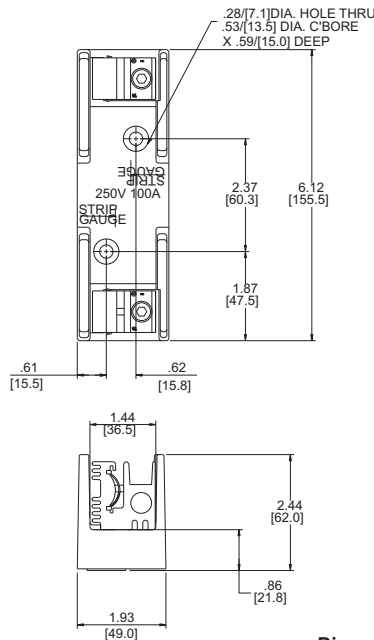

FB1231R

Dimensions: $\frac{\text{in.}}{[\text{mm}]}$

100 A, 250 V 9080FB Fuseholders

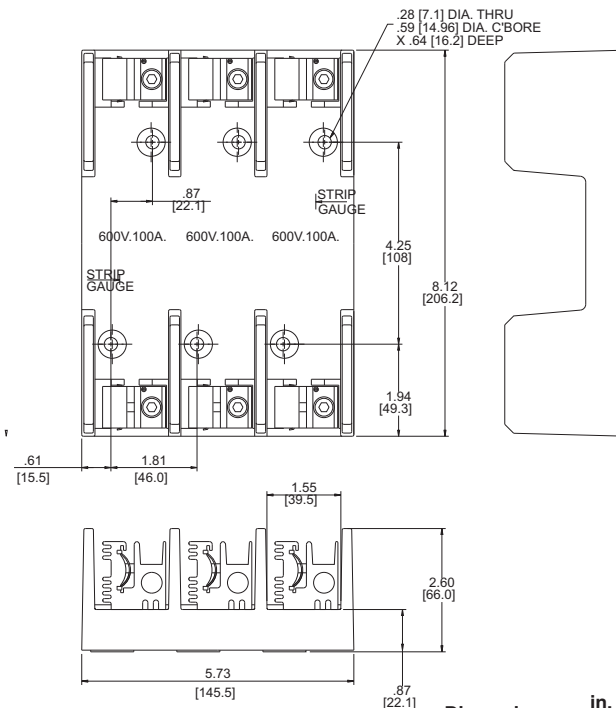

FB3631, FB3631R

Dimensions: $\frac{\text{in.}}{[\text{mm}]}$

100 A, 250 V 9080FB Fuseholders

Terminal Blocks

9080FB Fuseholder Approximate Dimensions 600 V, 30 A

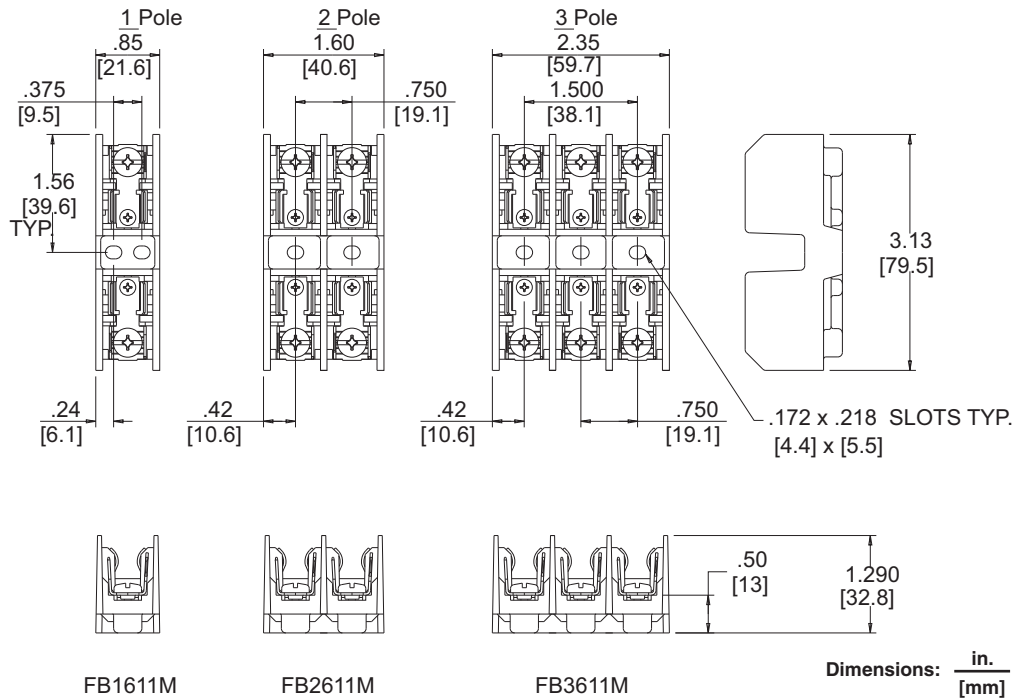

30 A, 600 V 9080FB Fuseholders

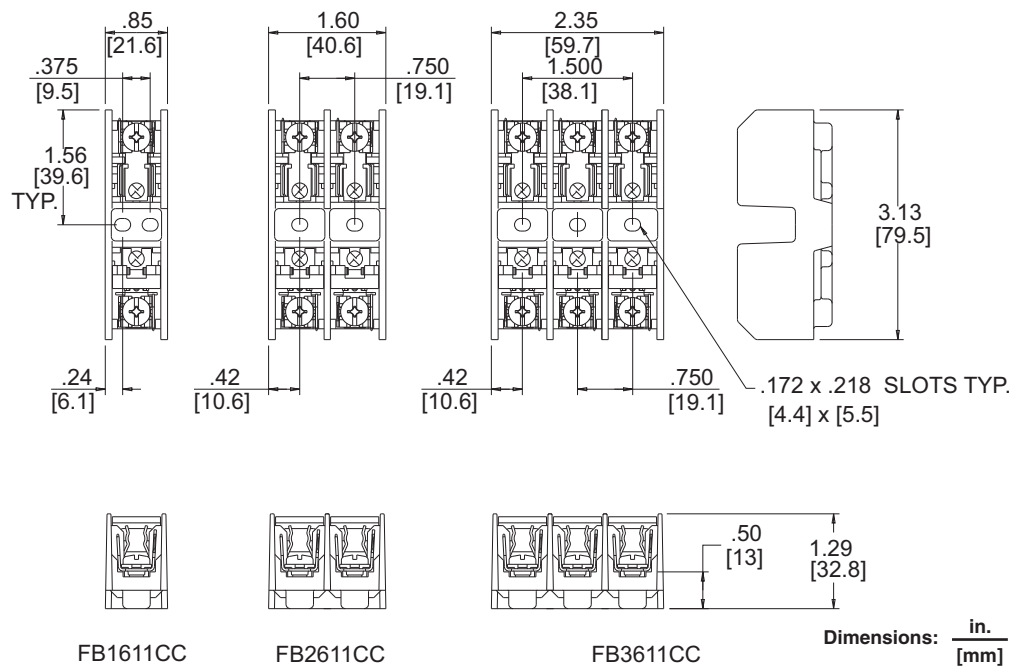

30 A, 600 V 9080FB Fuseholders

Terminal Blocks

9080FB Fuseholders Approximate Dimensions 600 V, 30 A and 60 A

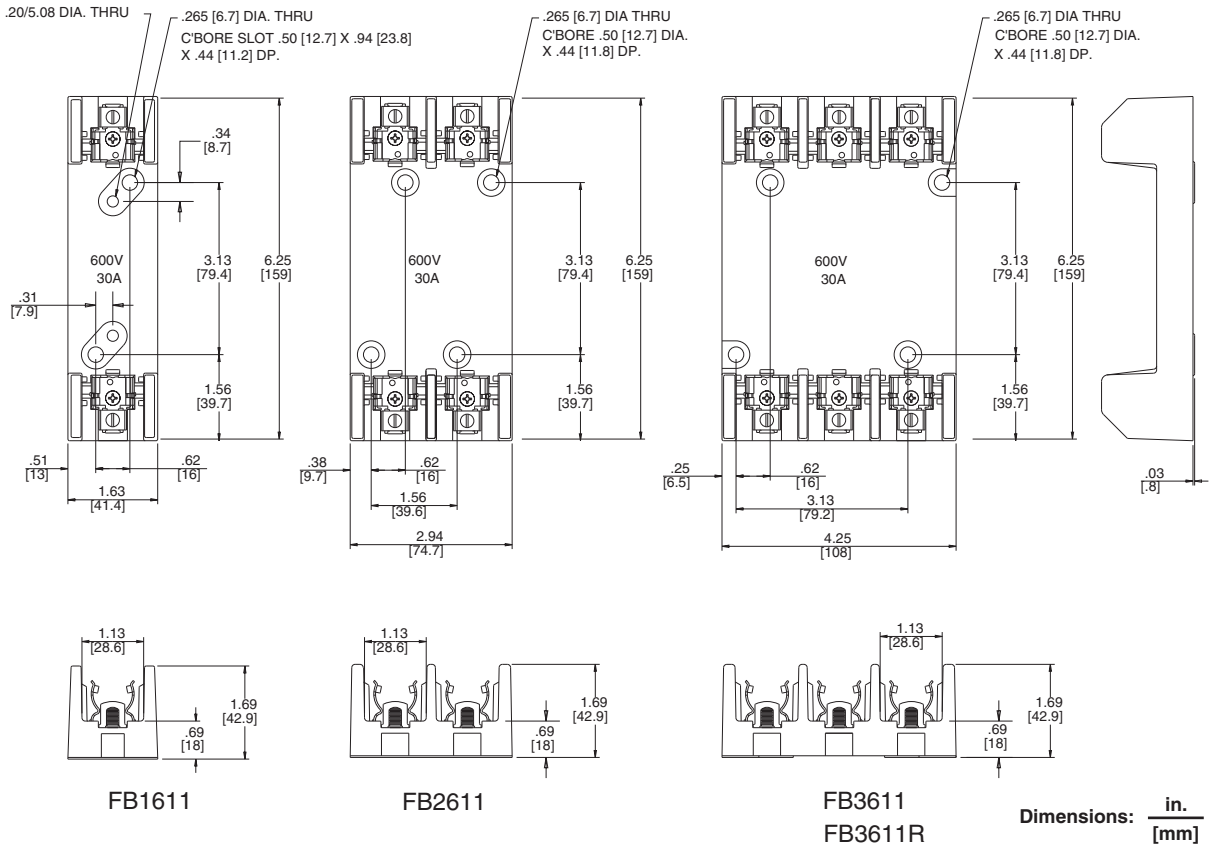

30 A, 600 V 9080FB Fuseholders

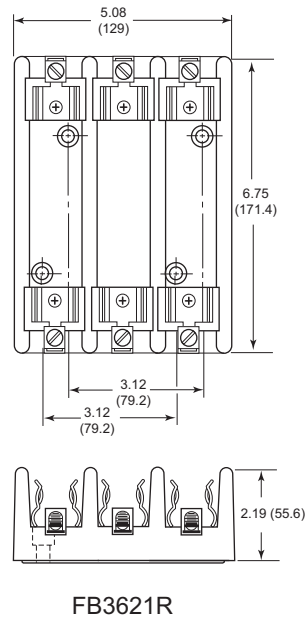

60 A, 600 V 9080FB Fuseholders

Terminal Blocks

9080FB Fuseholders Approximate Dimensions 600 V, 60 A

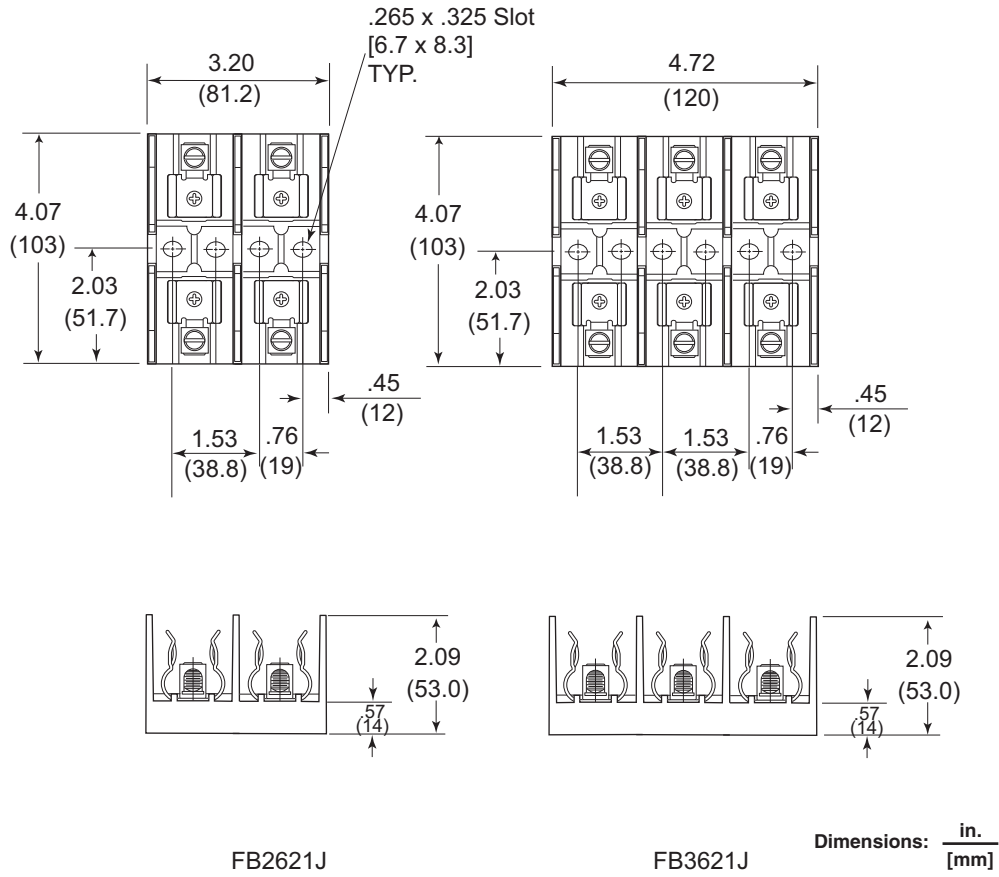

60 A, 600 V 9080FB Fuseholders

Terminal Blocks

Short-Circuit Current Ratings

Short-Circuit Current Ratings with Combination of Enclosed Power Distribution Blocks and Circuit Breakers

Wire Type (Class)	Catalog Number	Suitable Conductors kcmil/AWG (mm ²) CU		Overcurrent Protection Circuit Breaker Required			SCCR, RMS Sym. A	Volts Max.
		Line	Load	Mfr	Type	Max. A		
B, C	NSYEBAD11611	4-2 (16-25)	10-2 (6-25)	Square D	JDL36250	250	18 kA	480
					JGL36250	250	35 kA	
					JJL36250	250	65 kA	
					JLL36250	250	65 kA	
		12-2 (4-25)	12-2 (4-25)	Square D	HDL36150	150	18 kA	
					HGL36150	150	35 kA	
					HJL36150	150	65 kA	
					HLL36150	150	65 kA	
		12-2 (4-25)	12-2 (4-25)	Square D	BDL36125	125	18kA	
					BGL36125	125	35kA	
					BJL36125	125	65kA	
B, C	NSYEBAD11614	4-2 (16-25)	10 (6)	Square D	JDL36250	250	18 kA	480
					JGL36250	250	35 kA	
					JJL36250	250	65 kA	
					JLL36250	250	65 kA	
		10-2 (6-25)	10 (6)	Square D	HDL36150	150	18 kA	
					HGL36150	150	35 kA	
					HJL36150	150	65 kA	
					HLL36150	150	65 kA	
		12-2 (4-25)	12-10 (4-6)	Square D	BDL36125	125	18 kA	
					BGL36125	125	35 kA	
					BJL36125	125	65 kA	
B, C	NSYEBAD12611 NSYEBAP12611 NSYEBAD12611 NSYEBAD12611	4-3/0 (16-70)	8-3/0 (10-70)	Square D	JDL36250	250	18 kA	480
					JGL36250	250	35 kA	
					JJL36250	250	65 kA	
					JLL36250	250	65 kA	
B, C	NSYEBAD12614 NSYEBAP12614 NSYEBAD12614 NSYEBAD12614	4-3/0 (16-70)	10-2 (6-25)	Square D	JDL36250	250	18 kA	480
					JGL36250	250	35 kA	
					JJL36250	250	65 kA	
					JLL36250	250	65 kA	

Terminal Blocks Short-Circuit Current Ratings

Enclosed Power Distribution Blocks Short-Circuit Current Ratings with Fuses

Wire Type (Class)	Catalog Number	Suitable Copper Conductors Range AWG (mm ²)		Fuse Type / Amperage						SCCR
		Line	Load	J	T	RK1	RK5	G	CC	
B, C	NSYEBAD11611	14-2 (2.5-25)	14-2 (2.5-25)	175	225	100	—	—	—	100 kA
G, H, I, K		14-4 (2.5-16)	14-4 (2.5-16)	175	225	100	—	—	—	100 kA
[1]		14-2 (2.5-25)	14-2 (2.5-25)	NONE						10 kA
B, C	NSYEBAD11614	10-2 (6-25)	14-10 (2.5-4)	125	200	100	—	—	—	65 kA
G, H, I, K		10-4 (6-16)	14-10 (2.5-4)	125	200	100	—	—	—	65 kA
[1]		14-2 (2.5-25)	14-10 (2.5-4)	NONE						10 kA
B, C	NSYEBAD12611	8-3/0 (10-70)	8-3/0 (10-70)	225	225	200	60	60	30	100 kA
G, H, I	NSYEBAP12611	8-2/0 (10-50)	8-2/0 (10-50)	300	300	200	100	60	30	100 kA
[1]	NSYEBAD12611 NSYEBAP12611 NSYEBBCD12611 NSYEBBCP12611	14-3/0 (2.5-70)	14-3/0 (2.5-70)	NONE						10 kA
B, C	NSYEBAD12614 NSYEBAP12614 NSYEBBCD12614 NSYEBBCP12614	8-3/0 (10-70)	8-2 (10-25)	225	225	200	60	60	30	100 kA
B, C		8-3/0 (10-70)	12-8 (4-10)	100	110	100	30	60	30	100 kA
G, H, I		8-2/0 (10-50)	8-4 (10-16)	225	225	200	60	60	30	100 kA
G, H, I		8-2/0 (10-50)	12-8 (4-10)	100	110	100	30	60	30	100 kA
[1]		14-3/0 (2.5-70)	14-2 (2.5-25)	NONE						10 kA
[1]	NSYEBAD13618 NSYEBBCD13618	6-400 (16-185) and 14-3/0 (2.5-70)	14-2 (2.5-25)	NONE						10 kA
B, C	NSYEBAP13618 NSYEBBCP13618	3/0-400 (70-185)	8-2 (10-25)	400	400	400	200	60	30	100 kA
B, C		6-400 (16-185)	10-2 (6-25)	200	200	200	100	60	30	100 kA
G, H, I		6-400 (16-185)	10-2 (6-25)	300	300	200	100	60	30	100 kA
[1]		6-400 (16-185) and 14-3/0 (2.5-70)	14-2 (2.5-25)	NONE						10 kA
[1]	NSYEBAD25622 NSYEBBCD25622	6-250 (16-120)	6-250 (16-120)	NONE						10 kA
B, C	NSYEBAP25622 NSYEBBCP25622	1/0-250 (50-120)	1/0-250 (50-120)	600	600	—	—	—	—	50 kA
B, C		1/0-250 (50-120)	1/0-250 (50-120)	400	400	400	200	60	30	100 kA
B, C		6-250 (16-120)	6-250 (16-120)	400	400	400	100	60	30	100 kA
G, H, I		1/0-250 (50-120)	1/0-250 (50-120)	300	300	200	100	60	30	100 kA
[1]		6-250 (16-120)	6-250 (16-120)	NONE						10 kA
B, C	NSYEBAP27622	4-500 (25-240)	4-500 (25-240)	600	600	600	200	60	30	100 kA
G, H, I		2-350 (35-150)	2-350 (35-150)	600	600	600	200	60	30	100 kA
[1]		4-500 (25-240)	4-500 (25-240)	NONE						10 kA
B, C	NSYEBAP27628	250-500 (120-240)	4-2/0 (25-50)	600	600	400	200	60	30	100 kA
B, C	NSYEBBCP27628	250-500 (120-240)	4-2/0 (25-50)	600	600	600	200	60	30	100 kA
B, C	NSYEBAP27628 NSYEBBCP27628	4-500 (25-240)	10-2/0 (6-50)	350	350	200	100	60	30	100 kA
G, H, I		250-350 (120-150)	4-1 (25-35)	600	600	600	200	60	30	100 kA
G, H, I		4-350 (25-150)	8-1 (10-35)	350	350	200	100	60	30	100 kA
[1]	4-500 (25-240)	10-2/0 (6-50)	NONE						10 kA	

¹ Any UL approved wire sizes that are not approved for higher SCCR will default to 10 kA.

Terminal Blocks

Short-Circuit Current Ratings

9080LBA and 9080LBC Power Distribution Blocks Short-Circuit Current Ratings with Circuit Breakers

Catalog Number	Suitable Conductors MCM/AWG (mm ²) Cu		Overcurrent Protection Circuit Breaker Required			SCCR, RMS Sym. A	Volts Max
	Line	Load	Mfr.	Type	Max A		
9080LBA161101 9080LBA361101	6-2 (16-25)	6-2 (16-25)	Square D	JDL36250	250	18 kA	480
				JGL36250	250	35 kA	
				JJL36250	250	65 kA	
				JLL36250	250	65 kA	
	10-8 (6)	10-8 (6)	Square D	HDL36100	100	18 kA	
				HGL36100	100	35 kA	
				HJL36100	100	65 kA	
				HLL36100	100	65 kA	
9080LBA161104 9080LBA261104 9080LBA361104	6-2 (16-25)	(4) 10 (6)	Square D	JDL36250	250	18 kA	480
				JGL36250	250	35 kA	
				JJL36250	250	65 kA	
				JLL36250	250	65 kA	
	10-8 (6)	(4) 14 (2.5)	Square D	HDL36100	100	18 kA	
				HGL36100	100	35 kA	
				HJL36100	100	65 kA	
				HLL36100	100	65 kA	
9080LBA162104 9080LBA262104 9080LBA362104	10-2/0 (6-50)	(4) 10-4 (6-16)	Square D	JDL36250	250	18 kA	480
				JGL36250	250	35 kA	
				JJL36250	250	65 kA	
				JLL36250	250	65 kA	
9080LBA362106	6-2/0 (16-50)	(6) 10-4 (6-16)	Square D	JDL36250	250	18 kA	480
				JGL36250	250	35 kA	
				JJL36250	250	65 kA	
				JLL36250	250	65 kA	
9080LBA163104 9080LBA263104 9080LBA363104	4-2/0 (25-50)	(4) 8-2 (10-25)	Square D	JDL36250	250	18 kA	480
				JGL36250	250	35 kA	
				JJL36250	250	65 kA	
				JLL36250	250	65 kA	
9080LBA163106 9080LBA263106 9080LBA363106	6-2/0 (16-50)	(6) 10-2 (6-25)	Square D	JDL36250	250	18 kA	480
				JGL36250	250	35 kA	480
				JJL36250	250	65 kA	480
				JLL36250	250	65 kA	480
	6-350 (16-150)	10-2 (6-25)	Square D	JJL36250	600	25 kA	600
				JLL36250	250	65 kA	480
6-400 (16-185)	8-4 (10-16)	Square D	LJL36600	600	65 kA	480	
			LJL36600	600	25 kA	600	
9080LBA163206 9080LBA263206 9080LBA363206	(2) 8-1/0 (10-50)	(6) 10-4 (6-16)	Square D	JDL36250	250	18 kA	480
				JGL36250	250	35 kA	
				JJL36250	250	65 kA	
				JLL36250	250	65 kA	

Terminal Blocks UL Short-Circuit Current Ratings

9080LBA and 9080LBC Power Distribution Blocks Short-Circuit Current Ratings with Circuit Breakers *(continued)*

Catalog Number	Suitable Conductors MCM/AWG (mm ²) Cu		Overcurrent Protection Circuit Breaker Required			SCCR, RMS Sym. A	Volts Max
	Line	Load	Mfr.	Type	Max A		
9080LBA164108 9080LBA264108 9080LBA364108	6-2/0 (16-50)	(6) 10-2 (6-25)	Square D	JDL36250	250	18 kA	480
JGL36250				250	35 kA		
JLL36250				250	65 kA		
JLL36250				250	65 kA		
	6-400 (16-185)	8-2 (10-25)	Square D	LJL36600	600	65 kA	600
9080LBA165106 9080LBA265106 9080LBA365106	4-2/0 (25-50)	(6) 8 (10)	Square D	JDL36250	250	18 kA	480
JGL36250				250	35 kA		
JLL36250				250	65 kA		
JLL36250				250	65 kA		
9080LBA165208 9080LBA265208 9080LBA365208	4-500 (25-240)	6-2/0 (16-50)	Square D	LJL36600	600	65 kA	480
						25 kA	600
9080LBA165112 9080LBA265112 9080LBA365112	4-2/0 (25-50)	(12) 8-2 (10-25)	Square D	JDL36250	250	18 kA	480
JGL36250				250	35 kA		
JLL36250				250	65 kA		
JLL36250				250	65 kA		
9080LBC162101 9080LBC362101	8-1/0 (10-50)	8-1/0 (10-50)	Square D	JDL36250	250	18 kA	480
JGL36250				250	35 kA		
JLL36250				250	65 kA		
JLL36250				250	65 kA		
9080LBC162104 9080LBC262104 9080LBC362104	8-2/0 (10-50)	(4) 8-4 (10-16)	Square D	JDL36250	250	18 kA	480
JGL36250				250	35 kA		
JLL36250				250	65 kA		
JLL36250				250	65 kA		
9080LBC163106 9080LBC263106 9080LBC363106	(1) 4-2/0 (25-50)	(6) 8-2 (10-25)	Square D	JDL36250	250	18 kA	480
JGL36250				250	35 kA	480	
JLL36250				250	65 kA	480	
JLL36250				250	65 kA	480	
9080LBC163206 9080LBC263206 9080LBC363206	(2) 2-2/0 (35-50)	(6) 8-4 (10-16)	Square D	JDL36175	175	18 kA	480
JGL36250				250	35 kA		
JLL36250				250	65 kA		
JLL36250				250	65 kA		
	(2) 6-4 (16)	(6) 12-10 (4)	Square D	JDL36250	250	18 kA	480
JGL36175				175	35 kA		
JLL36175				175	65 kA		
JLL36175				175	65 kA		

Terminal Blocks

UL Short-Circuit Current Ratings

9080LBA and 9080LBC Power Distribution Blocks Short-Circuit Current Ratings with Fuses

Catalog Numbers			Suitable Conductors kcmil/AWG (mm ²)		Fuse Type / Amperage						SCCR
1-Pole	2-Pole	3-Pole	Line	Load	J	T	RK1	RK5	G	CC	
9080LBA161101	—	9080LBA361101	6-2 (10-25)	6-2 (10-25)	200	200	200	100	60	30	100 kA
			10-2 (6-25)	10-2 (6-25)	100	100	100	30	60	30	100 kA
			10-2 (6-25)	10-2 (6-25)	125	125	60	30	60	30	65 kA
			10-4 (6-16) (class G,H,I,K)	10-4 (6-16) (class G,H,I,K)	150	150	100	30	60	30	100 kA
			14-2 (2.5-25)	14-2 (2.5-25)	NONE						10 kA
9080LBA161104	9080LBA261104	9080LBA361104	6-2 (16-25)	10 (6)	200	200	200	60	60	30	100 kA
			10-2 (6-25)	14-10 (2.5-4)	150	150	100	30	60	30	100 kA
			12-2 (4-25)	14-10 (2.5-4)	60	60	30	—	50	30	100 kA
			10-4 (6-16) (class G,H,I,K)	14-10 (2.5-4) (class G,H,I,K)	150	150	100	30	60	30	100 kA
			14-2 (2.5-25)	14-10 (2.5-4)	NONE						10 kA
9080LBA162101	9080LBA262101	9080LBA362101	6-2/0 (16-50)	6-2/0 (16-50)	300	300	200	100	60	30	65 kA
			6-1 (16-35) (class G,H,I,K)	6-1 (16-35) (class G,H,I,K)	300	300	200	100	60	30	65 kA
			14-2/0 (2.5-50)	14-2/0 (2.5-50)	NONE						10 kA
9080LBA162104	9080LBA262104	9080LBA362104	6-2/0 (16-50)	10-4 (6-16)	200	200	200	100	60	30	100 kA
			6-2/0 (16-50)	14-4 (2.5-16)	150	150	100	30	60	30	100 kA
			6-1 (16-35) (class G,H,I,K)	12-6 (4-10) (class G,H,I,K)	150	150	100	30	60	30	100 kA
			14-2/0 (2.5-50)	14-4 (2.5-16)	NONE						10 kA
—	—	9080LBA362106	6-2/0 (16-50)	10-4 (6-16)	200	200	200	100	60	30	100 kA
			10-2/0 (6-50)	14-4 (2.5-16)	60	60	60	30	—	30	100 kA
			6-1 (16-35) (class G,H,I,K)	10-6 (6-10) (class G,H,I,K)	150	150	100	30	60	30	100 kA
			10-1 (6-35) (class G,H,I)	14-6 (2.5-10) (class G,H,I)	60	60	60	30	—	30	100 kA
			14-2/0 (2.5-50)	14-4 (2.5-16)	NONE						10 kA
9080LBA163101	9080LBA263101	9080LBA363101	1/0-350 (70-150)	1/0-350 (70-150)	400	400	400	100	60	30	100 kA
			6-350 (16-150)	6-350 (16-150)	300	300	200	100	60	30	100 kA
			1/0-250 (70-120) (class G,H,I,K)	1/0-250 (70-120) (class G,H,I,K)	300	300	200	100	60	30	100 kA
			6-350 (16-150)	6-350 (16-150)	NONE						10 kA
9080LBA163104	9080LBA263104	9080LBA363104	3/0-400 (95-185)	6-2 (16-25)	400	400	400	100	60	30	100 kA
			6-400 (16-185)	10-2 (6-25)	300	300	200	100	60	30	100 kA
			1/0-250 (70-120) (class G,H,I,K)	10-4 (6-16) (class G,H,I,K)	150	150	100	30	60	30	100 kA
			6-400 (16-185)	14-2 (2.5-25)	NONE						10 kA

Terminal Blocks UL Short-Circuit Current Ratings

9080LBA and 9080LBC Power Distribution Blocks Short-Circuit Current Ratings with Fuses *(continued)*

Catalog Numbers			Suitable Conductors kcmil/AWG (mm ²)		Fuse Type / Amperage						SCCR
1-Pole	2-Pole	3-Pole	Line	Load	J	T	RK1	RK5	G	CC	
9080LBA163106	9080LBA263106	9080LBA363106	3/0-400 (95-185)	8-2 (10-25)	500	500	400	200	60	30	100 kA
			6-400 (16-185)	10-2 (6-25)	350	350	200	100	60	30	100 kA
			1/0-250 (70-120) (class G,H,I,K)	10-4 (6-16) (class G,H,I,K)	150	150	100	30	60	30	100 kA
			6-400 (16-185)	14-2 (2.5-25)	NONE						10 kA
9080LBA163206	9080LBA263206	9080LBA363206	2-2/0 (35-50)	8-4 (10-16)	400	400	400	100	60	30	100 kA
			6-2/0 (16-50)	8-4 (10-16)	350	350	200	100	60	30	100 kA
			6-2/0 (16-50)	10-4 (6-16)	250	250	200	60	60	30	100 kA
			(1) 6 (16)	(2) 12 (4)	225	225	100	60	60	30	100 kA
			6-1 (16-35) (class G,H,I,K)	8-6 (10) (class G,H,I,K)	150	150	100	30	60	30	100 kA
			14-2/0 (2.5-50)	14-4 (2.5-16)	NONE						10 kA
9080LBA164101	—	9080LBA364101	2-600 (35-300)	2-600 (35-300)	600	600	—	—	—	—	50 kA
			2-600 (35-300)	2-600 (35-300)	400	400	400	200	60	30	100 kA
			2-350 (35-150) (class G,H,I,K)	2-350 (35-150) (class G,H,I,K)	400	400	400	200	60	30	100 kA
			2-600 (35-300)	2-600 (35-300)	NONE						10 kA
9080LBA164108	9080LBA264108	9080LBA364108	3/0-400 (95-185)	8-2 (10-25)	400	400	400	200	60	30	100 kA
			6-400 (16-185)	10-2 (6-25)	200	200	200	100	60	30	100 kA
			1/0-250 (70-120) (class G,H,I,K)	14-4 (2.5-16) (class G,H,I,K)	150	150	100	30	60	30	100 kA
			6-400 (16-185)	14-2 (2.5-25)	NONE						10 kA
9080LBA165202	9080LBA265202	9080LBA365202	4-350 (25-150)	4-350 (25-150)	450	450	400	200	60	30	100 kA
			4-350 (25-150)	4-350 (25-150)	600	600	—	—	—	—	50 kA
			2-250 (35-120) (class G,H,I,K)	2-250 (35-120) (class G,H,I,K)	600	600	—	—	—	—	50 kA
			2-250 (35-120) (class G,H,I,K)	2-250 (35-120) (class G,H,I,K)	450	450	400	200	60	30	100 kA
			4-350 (25-150)	4-350 (25-150)	NONE						10 kA

Terminal Blocks

UL Short-Circuit Current Ratings

9080LBA and 9080LBC Power Distribution Blocks Short-Circuit Current Ratings with Fuses *(continued)*

Catalog Numbers			Suitable Conductors kcmil/AWG (mm ²)		Fuse Type / Amperage						SCCR
1-Pole	2-Pole	3-Pole	Line	Load	J	T	RK1	RK5	G	CC	
9080LBA1652021	9080LBA2652021	9080LBA3652021	4-500 (25-240)	4-500 (25-240)	500	500	400	200	60	30	100 kA
			2-350 (35-150) (class G,H,I,K)	2-350 (35-150) (class G,H,I,K)	500	500	400	200	60	30	100 kA
			4-500 (25-240)	4-500 (25-240)	NONE						10 kA
9080LBA165106	9080LBA265106	9080LBA365106	3/0-500 (95-240)	6-2/0 (16-50)	400	400	400	100	60	30	100 kA
			4-500 (25-240)	10-2/0 (6-50)	200	200	200	100	60	30	100 kA
			2-350 (35-150) (class G,H,I,K)	6-1 (16-35) (class G,H,I,K)	400	400	400	100	60	30	100 kA
			2-350 (35-150) (class G,H,I,K)	10-1 (6-35) (class G,H,I,K)	250	250	200	100	60	30	100 kA
			4-500 (25-240)	14-2/0 (2.5-50)	NONE						10 kA
9080LBA165112	9080LBA265112	9080LBA365112	3/0-500 (95-240)	6-2 (16-25)	400	400	400	200	60	30	100 kA
			4-500 (25-240)	10-2 (6-25)	250	250	200	100	60	30	100 kA
			2-350 (35-150) (class G,H,I,K)	6-4 (16) (class G,H,I,K)	400	400	400	200	60	30	100 kA
			2-350 (35-150) (class G,H,I,K)	10-4 (6-16) (class G,H,I,K)	250	250	200	200	60	20	100 kA
			4-500 (25-240)	14-2 (2.5-25)	NONE						10 kA
9080LBA165208	9080LBA265208	9080LBA365208	250-500 (150-240)	4-2/0 (25-50)	600	600	400	200	60	30	100 kA
			4-500 (25-240)	10-2/0 (6-50)	350	350	200	100	60	30	100 kA
			250-350 (150) (class G,H,I,K)	4-1 (25-35) (class G,H,I,K)	600	600	400	200	60	30	100 kA
			4-350 (25-150) (class G,H,I,K)	10-6 (6-10) (class G,H,I,K)	350	350	200	100	60	30	100 kA
			4-500 (25-240)	14-2/0 (2.5-50)	NONE						10 kA
9080LBA165212	9080LBA265212	9080LBA365212	250-500 (150-240)	8-4 (10-16)	400	400	200	100	60	30	100 kA
			4-500 (25-240)	10-4 (6-16)	350	350	200	100	60	30	100 kA
			250-350 (150) (class G,H,I,K)	8-6 (10) (class G,H,I,K)	400	400	200	100	60	30	100 kA
			4-350 (25-150) (class G,H,I,K)	10-6 (6-10) (class G,H,I,K)	350	350	200	100	60	30	100 kA
			4-500 (25-240)	14-4 (2.5-16)	NONE						10 kA

Terminal Blocks UL Short-Circuit Current Ratings

9080LBA and 9080LBC Power Distribution Blocks Short-Circuit Current Ratings with Fuses *(continued)*

Catalog Numbers			Suitable Conductors kcmil/AWG (mm ²)		Fuse Type / Amperage						SCCR
1-Pole	2-Pole	3-Pole	Line	Load	J	T	RK1	RK5	G	CC	
9080LBC162101	—	9080LBC362101	6-1/0 (16-50)	6-1/0 (16-50)	175	175	100	60	60	30	100 kA
			6-1 (16-35) (class G,H,I,K)	6-1 (16-35) (class G,H,I,K)	175	175	100	60	60	30	100 kA
			14-1/0 (2.5-50)	14-1/0 (2.5-50)	NONE						10 kA
9080LBC162104	9080LBC262104	9080LBC362104	6-2/0 (10-50)	10-4 (6-16)	200	200	200	100	60	30	100 kA
			10-2/0 (6-50)	14-4 (2.5-16)	150	150	100	30	60	30	100 kA
			6-1 (16-35) (class G,H,I,K)	12-6 (4-10) (class G,H,I,K)	150	150	100	30	60	30	100 kA
			14-2/0 (2.5-50)	14-4 (2.5-16)	NONE						10 kA
9080LBC163101	—	9080LBC363101	6-250 (16-120)	6-250 (16-120)	300	300	200	100	60	30	100 kA
			1/0-250 (70-120) (class G,H,I,K)	1/0-250 (70-120) (class G,H,I,K)	300	300	200	100	60	30	100 kA
			6-250 (16-120)	6-250 (16-120)	NONE						10kA
9080LBC163106	9080LBC263106	9080LBC363106	3/0-500 (95-240)	8-2 (10-25)	400	400	400	200	60	30	100 kA
			4-500 (25-240)	10-2 (6-25)	300	300	200	100	60	30	100 kA
			1/0-250 (70-120) (class G,H,I,K)	10-4 (6-16) (class G,H,I,K)	150	150	100	30	60	30	100 kA
			4-500 (25-240)	14-4 (2.5-16)	NONE						10 kA
9080LBC163206	9080LBC263206	9080LBC363206	2-2/0 (35-50)	8-4 (10-16)	400	400	400	100	60	30	100 kA
			6-2/0 (16-50)	8-4 (10-16)	350	350	200	100	60	30	100 kA
			10-4 (6-16) (class G,H,I,K)	14-10 (2.5-4) (class G,H,I,K)	150	150	100	30	60	30	100 kA
			14-2/0 (2.5-50)	14-4 (2.5-16)	NONE						10 kA
9080LBC165208	—	9080LBC365208	250-500 (150-240)	4-2/0 (25-50)	500	500	400	200	60	30	100 kA
			4-500 (25-240)	6-2/0 (16-50)	450	450	400	200	60	30	100 kA
			250-350 (150) (class G,H,I,K)	4-1 (25-35) (class G,H,I,K)	500	500	400	200	60	30	100 kA
			2-350 (35-150) (class G,H,I,K)	6-1 (16-35) (class G,H,I,K)	450	450	400	200	60	30	100 kA
			4-500 (25-240)	14-2/0 (2.5-50)	NONE						10 kA

Terminal Blocks

UL Short-Circuit Current Ratings

9080LBA and 9080LBC Power Distribution Blocks Short-Circuit Current Ratings with Fuses *(continued)*

Catalog Numbers			Suitable Conductors kcmil/AWG (mm ²)		Fuse Type / Amperage						SCCR
1-Pole	2-Pole	3-Pole	Line	Load	J	T	RK1	RK5	G	CC	
9080LBC165212	—	9080LBC365212	4-500 (25-240)	10-2 (6-25)	400	400	400	200	60	30	100 kA
			250-500 (150-240)	8-2 (10-25)	600	600	—	—	—	—	50 kA
			2-350 (35-150) (class G,H,I,K)	10-4 (6-16) (class G,H,I,K)	400	400	400	200	60	30	100 kA
			250-350 (150) (class G,H,I,K)	8-4 (10-16) (class G,H,I,K)	600	600	—	—	—	—	50 kA
			4-500 (25-240)	14-2 (2.5-25)	NONE						10 kA

Expanded Wire Usage

Historically, the terminals on Schneider Electric's power distribution blocks have only been evaluated for use with rigid Class B and C wire. Our open and enclosed power distribution blocks have now been evaluated for use with flexible stranded wire classes according to UL 486A-B and include more wire classes.

Stranded Wire Characteristics and Usage

Stranded wire is composed of a number of small gauge wire bundled or wrapped together to form a larger conductor. The more individual wire strands in a wire bundle, the more flexible, kink-resistant, break-resistant, and strong it is. It is capable of carrying more amperage (more surface area), less likely to get damaged in a pull, easier to handle, and weighs less than solid wire. Stranded wire tends to be a better conductor than solid wire because the individual wires collectively comprise a greater surface area.

Solid Wire Characteristics and Usage

The benefits of solid wire are cost, simplicity, and durability. It is a single, thick strand of wire and is therefore resistant to damage. For applications which require a great deal of movement, vibration, or require to be bent into complex shapes solid wire is undesirable because it lacks the strength and flexibility to endure reshaping and motion.

Stranded Wire Applications

- Robotics
- Automotive
- Circuit Boards
- Electronics

Conclusion

Long-term durability must be weighed against choosing wire type based on cost. Solid wire costs less than stranded wire, but stranded wire will last longer in applications where motion or frequent alterations to the wiring may occur.

Torque values for stranded wire classes are included in the following tables.

Terminal Blocks

Wire Classes

Wire Classes—Enclosed Power Distribution Blocks

Catalog No.	No. of Terminals	AWG (mm ²) Line & Load Side (Cu Stranded)	Torque lb-in (N•m)	Wires / Terminal	Class	IP20 Protection AWG (mm ²)
NSYEBAD11611	1	3–2 (35)	50 (5.6)	1	B, C	14–2 (2.5–25)
		6–4 (16–25)	45 (5.1)	1	B, C, G, H, I (DLO)	
		8 (10)	40 (4.5)	1	B, C, G, H, I (DLO)	
		14–10 (2.5–6)	35 (4.0)	1	B, C, G, H, I (DLO)	
Catalog No.	No. of Terminals	AWG (mm ²) Line Side (Cu Stranded)	Torque lb-in (N•m)	Wires / Terminal	Class	IP20 Protection AWG (mm ²)
NSYEBAD11614	1	3–2 (35)	50 (5.6)	1	B, C	14–2 (2.5–25)
		6–4 (16–25)	45 (5.1)	1	B, C, G, H, I (DLO)	
		8 (10)	40 (4.5)	1	B, C, G, H, I (DLO)	
		14–10 (2.5–6)	35 (4.0)	1	B, C, G, H, I (DLO)	
Catalog No.	No. of Terminals	AWG (mm ²) Load Side (Cu Stranded)	Torque lb-in (N•m)	Wires / Terminal	Class	IP20 Protection AWG (mm ²)
NSYEBAD11614	4	14–10 (2.5–6)	7 (0.80)	1	B, C, G, H, I (DLO)	14–10 (2.5–4)
Catalog No.	No. of Terminals	AWG (mm ²) Line & Load Side (Cu Stranded)	Torque lb-in (N•m)	Wires / Terminal	Class	IP20 Protection AWG (mm ²)
NSYEBAD12611 NSYEBAP12611 NSYEBAD12611 NSYEBBCP12611	1	3/0 (70)	180 (20.3)	1	B, C	2–3/0 (35–70)
		2–2/0 (25–50)	180 (20.3)	1	B, C, G, H, I (DLO)	
		4 (16)	180 (20.3)	1	B, C, G, H, I (DLO)	
		4 (16)	180 (20.3)	1 to 2	B, C	
		8–6 (10)	180 (20.3)	1 to 2	B, C, G, H, I (DLO)	
		14–10 (2.5–6)	50 (5.6)	1 to 2	B, C, G, H, I (DLO)	
Catalog No.	No. of Terminals	AWG (mm ²) Line Side (Cu Stranded)	Torque lb-in (N•m)	Wires / Terminal	Class	IP20 Protection AWG (mm ²)
NSYEBAD12614 NSYEBAP12614 NSYEBAD12614 NSYEBBCP12614	1	3/0 (70)	180 (20.3)	1	B, C	2–3/0 (35–70)
		2–2/0 (25–50)	180 (20.3)	1	B, C, G, H, I (DLO)	
		4 (16)	180 (20.3)	1	B, C, G, H, I (DLO)	
		4 (16)	180 (20.3)	1 to 2	B, C	
		8–6 (10)	180 (20.3)	1 to 2	B, C, G, H, I (DLO)	
		14–10 (2.5–6)	50 (5.6)	1 to 2	B, C, G, H, I (DLO)	
Catalog No.	No. of Terminals	AWG (mm ²) Load Side (Cu Stranded)	Torque lb-in (N•m)	Wires / Terminal	Class	IP20 Protection AWG (mm ²)
NSYEBAD12614 NSYEBAP12614 NSYEBAD12614 NSYEBBCP12614	4	2 (35)	50 (5.6)	1	B, C	14–2 (2.5–25)
		6–4 (16–25)	50 (5.6)	1	B, C, G, H, I (DLO)	
		8 (10)	50 (5.6)	1 to 2	B, C, G, H, I (DLO)	
		10 (6)	40 (4.5)	1 to 2	B, C, G, H, I (DLO)	
		14–12 (2.5–4)	40 (4.5)	1 to 4	B, C, G, H, I (DLO)	

Wire Classes—Enclosed Power Distribution Blocks (continued)

Catalog No.	No. of Terminal	AWG (mm ²) Line Side (Cu Stranded)	Torque lb-in (N•m)	Wires / Terminal	Class	IP20 Protection AWG (mm ²)
NSYEBAD13618 NSYEBAP13618 NSYEBAD13618 NSYEBAD13618	1	2/0–400 (70–185)	375 (42.2)	1	B, C, G, H, I (DLO)	300–400 (150–185)
		2–1/0 (35–50)	275 (31.0)	1	B, C, G, H, I (DLO)	
		6–4 (16)	275 (31.0)	1	B, C	
	1	3/0 (70)	120 (13.5)	1	B, C	4–3/0 (25–70)
		1–2/0 (35–50)	120 (13.5)	1	B, C, G, H, I (DLO)	
		6–2 (10–25)	80 (9.0)	1	B, C, G, H, I (DLO)	
		8 (10)	40 (4.5)	1	B, C, G, H, I (DLO)	
		14–10 (2.5–6)	40 (4.5)	1	B, C, I (DLO)	
Catalog No.	No. of Terminals	AWG (mm ²) Load Side (Cu Stranded)	Torque lb-in (N•m)	Wires / Terminal	Class	IP20 Protection AWG (mm ²)
NSYEBAD13618 NSYEBAP13618 NSYEBAD13618 NSYEBAD13618	8	4–2 (25–35)	80 (9.0)	1	B, C, G, H, I (DLO)	12–2 (4–25)
		6 (16)	80 (9.0)	1–2	B, C, G, H, I (DLO)	
		8 (10)	40 (4.5)	1–2	B, C, G, H, I (DLO)	
		14–10 (2.5–6)	40 (4.5)	1–4	B, C, I (DLO)	
Catalog No.	No. of Terminals	AWG (mm ²) Line & Load Side (Cu Stranded)	Torque lb-in (N•m)	Wires / Terminal	Class	IP20 Protection AWG (mm ²)
NSYEBAD25622 NSYEBAD25622 NSYEBAD25622 NSYEBAD25622	2	1–250 (50–120)	275 (31.1)	1	B, C, G, H, I (DLO)	4/0–250 (120)
		2 (35)	120 (13.5)	1	B, C, G, H, I (DLO)	
		6–4 (16–25)	120 (13.5)	1	B,C	
Catalog No.	No. of Terminals	AWG Line & Load Side (Cu Stranded)	Torque lb-in (N•m)	Wires / Terminal	Class	IP20 Protection AWG (mm ²)
NSYEBAD27622	2	4–500 (25–240)	375 (42.4)	1	B,C	4/0–500 (120–240)
		2–350 (35–150)	375 (42.4)	1	B, C, G, H, I (DLO)	
Catalog No.	No. of Terminals	AWG (mm ²) Line Side (Cu Stranded)	Torque lb-in (N•m)	Wires / Terminal	Class	IP20 Protection AWG (mm ²)
NSYEBAD27628 NSYEBAD27628	2	4–500 (25–240)	375 (42.4)	1	B,C	4/0–500 (120–240)
		4–350 (25–150)	375 (42.4)	1	B, C, G, H, I (DLO)	
Catalog No.	No. of Terminals	AWG (mm ²) Load Side (Cu Stranded)	Torque lb-in (N•m)	Wires / Terminal	Class	IP20 Protection AWG (mm ²)
NSYEBAD27628 NSYEBAD27628	8	6–2/0 (16–50)	120 (13.6)	1	B,C	10–2/0 (6–50)
		6–1 (16–35)	120 (13.6)	1	B, C, G, H, I (DLO)	
		8 (10)	40 (4.5)	1	B, C, G, H, I (DLO)	
		14–10 (2.5–6)	35 (4)	1	B, C, I (DLO)	

¹ Multiple wire rating applies to Class I only. Classes B and C are rated for one wire per terminal.

Terminal Blocks

Wire Classes

Wire Classes—9080LB Open Power Distribution Blocks

Catalog No.	AWG (mm ²) Load Side (Cu Stranded)	Torque lb-in (N•m)	Wires / Terminal	Class
9080LBA161101 9080LBA361101	2 (25)	50 (5.6)	1	B, C
	6–4 (16)	45 (5.1)	1	B, C, G, H, I (DLO)
	8 (10)	40 (4.5)	1	B, C, G, H, I (DLO)
	14–10 (2.5–6)	35 (4.0)	1	B, C, I (DLO)

Catalog No.	AWG (mm ²) Load Side (Cu Stranded)	Torque lb-in (N•m)	Wires / Terminal	Class
9080LBA161101 9080LBA361101	2 (25)	50 (5.6)	1	B, C
	6–4 (16)	45 (5.1)	1	B, C, G, H, I (DLO)
	8 (10)	40 (4.5)	1–2 ^[1]	B, C, G, H, I (DLO)
	14–10 (2.5–6)	35 (4.0)	1–2 ^[1]	B, C, I (DLO)

Catalog No.	AWG (mm ²) Line Side (Cu Stranded)	Torque lb-in (N•m)	Wires / Terminal	Class
9080LBA161104 9080LBA261104 9080LBA361104	2 (25)	50 (5.6)	1	B, C
	6–4 (16)	45 (5.1)	1	B, C, G, H, I (DLO)
	8 (10)	40 (4.5)	1	B, C, G, H, I (DLO)
	14–10 (2.5–6)	35 (4.0)	1	B, C, I, (DLO)

Catalog No.	AWG (mm ²) Load Side (Cu Stranded)	Torque lb-in (N•m)	Wires / Terminal	Class
9080LBA161104 9080LBA261104 9080LBA361104	12–10 (2.5–6)	7 (.8)	1	B, C, I (DLO)
	14 (2.5)	7 (.8)	1–2 ^[1]	B, C, I (DLO)
	18–16 (1.0–1.5)	7 (.8)	1	B,C

Catalog No.	AWG (mm ²) Line & Load Side (Cu Stranded)	Torque lb-in (N•m)	Wires / Terminal	Class
9080LBA162101 9080LBA262101 9080LBA362101	1/0–2/0 (50–70)	120 (13.6)	1	B, C
	6–1 (16–35)	120 (13.6)	1	B, C, G, H, I (DLO)
	8 (10)	40 (4.5)	1	B, C, G, H, I (DLO)
	14–10 (2.5–6)	35 (4)	1	B, C, I, (DLO)

Catalog No.	AWG (mm ²) Line Side (Cu Stranded)	Torque lb-in (N•m)	Wires / Terminal	Class
9080LBA162104 9080LBA262104 9080LBA362104	1/0–2/0 (50–70)	120 (13.6)	1	B, C
	4–1 (25–50)	120 (13.6)	1	B, C, G, H, I (DLO)
	6 (16)	120 (13.6)	1	B, C, I (DLO)
	8 (10)	40 (4.5)	1	B, C
	14–10 (2.5–6)	35 (4)	1	B, C

¹ Multiple wire rating applies to Class B and C.

² Multiple wire rating applies to Class B, C, and I.

Terminal Blocks Wire Classes

Wire Classes–9080LB Open Power Distribution Blocks *(continued)*

Catalog No.	AWG (mm ²) Load Side (Cu Stranded)	Torque lb-in (N•m)	Wires / Terminal	Class
9080LBA162104	4 (25)	35 (4)	1	B, C
9080LBA262104	6 (16)	35 (4)	1	B, C, I (DLO)
9080LBA362104	8 (10)	35 (4)	1	B, C
	14–10 (2.5–6)	35 (4)	1–2 [1]	B, C

Catalog No.	AWG (mm ²) Line & Load Side (Cu Stranded)	Torque lb-in (N•m)	Wires / Terminal	Class
9080LBA163101	300–350 (150)	275 (31.1)	1	B, C
9080LBA263101	2–250 (35–120)	275 (31.1)	1	B, C, G, H, I (DLO)
9080LBA363101	6–4 (16–25)	275 (31.1)	1	B,C

Catalog No.	AWG (mm ²) Line Side (Cu Stranded)	Torque lb-in (N•m)	Wires / Terminal	Class
9080LBA163104	350–400 (150–185)	275 (31.1)	1	B, C
9080LBA263104	2–300 (25–150)	275 (31.1)	1	B, C, G, H, I (DLO)
9080LBA363104	6–4 (16–25)	275 (31.1)	1	B,C

Catalog No.	AWG (mm ²) Load Side (Cu Stranded)	Torque lb-in (N•m)	Wires / Terminal	Class
9080LBA163104	2 (35)	50 (5.6)	1	B, C
9080LBA263104	6–4 (16–25)	45 (5.1)	1	B, C, G, H, I (DLO)
9080LBA363104	8 (10)	40 (4.5)	1–2 [2]	B, C, G, H, I (DLO)
	10 (6)	35 (4)	1–2	B, C, I (DLO)
	14–12 (2.5–4)	35 (4)	1–2	I (DLO)
	14–12 (2.5–4)	35 (4)	1–4	B, C

Catalog No.	AWG (mm ²) Line Side (Cu Stranded)	Torque lb-in (N•m)	Wires / Terminal	Class
9080LBA163106	350–400 (185)	275 (31.1)	1	B, C
9080LBA263106	2–300 (35–150)	275 (31.1)	1	B, C, G, H, I (DLO)
9080LBA363106	6–4 (16–25)	275 (31.1)	1	B, C

Catalog No.	AWG (mm ²) Load Side (Cu Stranded)	Torque lb-in (N•m)	Wires / Terminal	Class
9080LBA163106	2 (35)	50 (5.6)	1	B, C
9080LBA263106	6–4 (16–25)	45 (5.1)	1	B, C, G, H, I (DLO)
9080LBA363106	8 (10)	40 (4.5)	1–2 [2]	B, C, G, H, I (DLO)
	10 (6)	35 (4)	1–2	B, C
	14–12 (2.5–4)	35 (4)	1–2	I (DLO)
	14–12 (2.5–4)	35 (4)	1–4	B, C

¹ Multiple wire rating applies to Class B, C, and I.

Terminal Blocks

Wire Classes

Wire Classes—9080LB Open Power Distribution Blocks (continued)

Catalog No.	AWG (mm ²) Line Side (Cu Stranded)	Torque lb-in (N•m)	Wires / Terminal	Class
9080LBA163206	1/0–2/0 (50–70)	120 (13.6)	1	B, C
9080LBA263206	6–1 (16–35)	120 (13.6)	1	B, C, G, H, I (DLO)
9080LBA363206	8 (10)	40 (4.5)	1	B, C, G, H, I (DLO)
	14–10 (2.5–6)	35 (4)	1	B, C, I (DLO)

Catalog No.	AWG (mm ²) Load Side (Cu Stranded)	Torque lb-in (N•m)	Wires / Terminal	Class
9080LBA163206	4 (25)	35 (4)	1	B, C
9080LBA263206	8–6 (10–16)	35 (4)	1	B, C, G, H, I (DLO)
9080LBA363206	10 (6)	35 (4)	1–2	B, C, I (DLO)
	14–12 (2.5–4)	35 (4)	1–2	I (DLO)
	14–12 (2.5–4)	35 (4)	1–4	B, C

Catalog No.	AWG (mm ²) Line & Load Side (Cu Stranded)	Torque lb-in (N•m)	Wires / Terminal	Class
9080LBA164101	400–600 (185–300)	500 (56.5)	1	B, C
9080LBA364101	2–350 (35–150)	500 (56.5)	1	B, C, G, H, I (DLO)
	4 (25)	500 (56.5)	1	B, C

Catalog No.	AWG (mm ²) Line Side (Cu Stranded)	Torque lb-in (N•m)	Wires / Terminal	Class
9080LBA164108	350–400 (185)	275 (31.1)	1	B, C
9080LBA264108	2–300 (35–150)	275 (31.1)	1	B, C, G, H, I (DLO)
9080LBA364108	6–4 (16–25)	275 (31.1)	1	B, C

Catalog No.	AWG (mm ²) Load Side (Cu Stranded)	Torque lb-in (N•m)	Wires / Terminal	Class
9080LBA164108	2 (35)	50 (5.6)	1	B, C
9080LBA264108	6–4 (16–25)	45 (5.1)	1	B, C, G, H, I (DLO)
9080LBA364108	8 (10)	40 (4.5)	1–2 [1]	B, C, G, H, I (DLO)
	10 (6)	35 (4)	1–2 [1]	B, C, I (DLO)
	14–12 (2.5–4)	35 (4)	1–2	I (DLO)
	14–12 (2.5–4)	35 (4)	1–4	B, C

Catalog No.	AWG (mm ²) Line Side (Cu Stranded)	Torque lb-in (N•m)	Wires / Terminal	Class
9080LBA165106	500 (240)	375 (42.4)	1	B, C
9080LBA265106	2–400 (35–185)	375 (42.4)	1	B, C, G, H, I (DLO)
9080LBA365106	4 (25)	375 (42.4)	1	B, C

¹ Multiple wire rating applies to Class B, C, and I.

Wire Classes–9080LB Open Power Distribution Blocks *(continued)*

Catalog No.	AWG (mm ²) Load Side (Cu Stranded)	Torque lb-in (N•m)	Wires / Terminal	Class
9080LBA165106	1/0–2/0 (50–70)	120 (13.6)	1	B, C
9080LBA265106	6–1 (16–35)	120 (13.6)	1	B, C, G, H, I (DLO)
9080LBA365106	8 (10)	40 (4.5)	1	B, C, G, H, I (DLO)
	14–10 (2.5–6)	35 (4)	1	B, C, I (DLO)

Catalog No.	AWG (mm ²) Line Side (Cu Stranded)	Torque lb-in (N•m)	Wires / Terminal	Class
9080LBA165112	500 (240)	375 (42.4)	1	B, C
9080LBA265112	2–400 (35–185)	375 (42.4)	1	B, C, G, H, I (DLO)
9080LBA365112	4 (25)	375 (42.4)	1	B, C

Catalog No.	AWG (mm ²) Load Side (Cu Stranded)	Torque lb-in (N•m)	Wires / Terminal	Class
9080LBA165112	2 (35)	50 (5.6)	1	B, C
9080LBA265112	6–4 (16–25)	45 (5.1)	1	B, C, G, H, I (DLO)
9080LBA365112	8 (10)	40 (4.5)	1–2 [1]	B, C, G, H, I (DLO)
	10 (6)	35 (4)	1–2	B, C, I (DLO)
	14–12 (2.5–4)	35 (4)	1–2	I (DLO)
	14–12 (2.5–4)	35 (4)	1–4	B, C

Catalog No.	AWG (mm ²) Line & Load Side (Cu Stranded)	Torque lb-in (N•m)	Wires / Terminal	Class
9080LBA165202	300–350 (150)	275 (31.1)	1	B, C
9080LBA265202	2–250 (35–120)	275 (31.1)	1	B, C, G, H, I (DLO)
9080LBA365202	4 (25)	275 (31.1)	1	B, C

Catalog No.	AWG (mm ²) Line & Load Side (Cu Stranded)	Torque lb-in (N•m)	Wires / Terminal	Class
9080LBA1652021	500 (240)	375 (42.4)	1	B, C
9080LBA2652021	2–400 (35–185)	375 (42.4)	1	B, C, G, H, I (DLO)
9080LBA3652021	4 (25)	375 (42.4)	1	B, C

Catalog No.	AWG (mm ²) Line Side (Cu Stranded)	Torque lb-in (N•m)	Wires / Terminal	Class
9080LBA165208	500 (240)	375 (42.4)	1	B, C
9080LBA265208	2–400 (35–185)	375 (42.4)	1	B, C, G, H, I (DLO)
9080LBA365208	6–4 (16–25)	375 (42.4)	1	B, C

Terminal Blocks

Wire Classes

Wire Classes—9080LB Open Power Distribution Blocks *(continued)*

Catalog No.	AWG (mm ²) Line Side (Cu Stranded)	Torque lb-in (N•m)	Wires / Terminal	Class
9080LBA165212	500 (240)	375 (42.4)	1	B, C
9080LBA265212	400 (185)	375 (42.4)	1	B, C, G, H
9080LBA365212	2–350 (35–150)	375 (42.4)	1	B, C, G, H, I (DLO)
	6–4 (16–25)	375 (42.4)	1	B, C

Catalog No.	AWG (mm ²) Load Side (Cu Stranded)	Torque lb-in (N•m)	Wires / Terminal	Class
9080LBA165212	4 (25)	35 (4)	1	B, C
9080LBA265212	8–6 (10–16)	35 (4)	1	B, C, G, H, I (DLO)
9080LBA365212	10 (6)	35 (4)	1–2	B, C, I (DLO)
	14–12 (2.5–4)	35 (4)	1–2	I (DLO)
	14–12 (2.5–4)	35 (4)	1–4	B, C

Catalog No.	AWG (mm ²) Line Side (Cu Stranded)	Torque lb-in (N•m)	Wires / Terminal	Class
9080LBA362106	1/0–2/0 (50–70)	120 (13.6)	1	B, C
	6–1 (16–35)	120 (13.6)	1	B, C, G, H, I (DLO)
	8 (10)	40 (4.5)	1	B, C, G, H, I (DLO)
	14–10 (2.5–6)	35 (4)	1	B, C, I (DLO)

Catalog No.	AWG (mm ²) Load Side (Cu Stranded)	Torque lb-in (N•m)	Wires / Terminal	Class
9080LBA362106	4 (25)	35 (4)	1	B, C
	8–6 (10–16)	35 (4)	1	B, C, G, H, I (DLO)
	10 (6)	35 (4)	1–2	B, C, I (DLO)
	14–12 (2.5–4)	35 (4)	1–2	I (DLO)
	14–12 (2.5–4)	35 (4)	1–4	B, C

Catalog No.	AWG (mm ²) Line Side (Cu Stranded)	Torque lb-in (N•m)	Wires / Terminal	Class
9080LBC162101	1/0–2/0 (50–70)	120 (13.6)	1	B, C
9080LBC362101	6–1 (16–35)	120 (13.6)	1	B, C, G, H, I (DLO)
	8 (10)	40 (4.5)	1	B, C, G, H, I (DLO)
	14–10 (2.5–6)	35 (4)	1	B, C, I (DLO)

Catalog No.	AWG (mm ²) Load Side (Cu Stranded)	Torque lb-in (N•m)	Wires / Terminal	Class
9080LBC162101	1/0–2/0 (50–70)	120 (13.6)	1	B, C
9080LBC362101	6–1 (16–35)	120 (13.6)	1	B, C, G, H, I (DLO)
	8 (10)	40 (4.5)	1	B, C, G, H, I (DLO)
	14–10 (2.5–6)	35 (4)	1	B, C, I (DLO)

¹ Multiple wire rating applies to Class B, C, and I.

Terminal Blocks Wire Classes

Wire Classes—9080LB Open Power Distribution Blocks (continued)

Catalog No.	AWG (mm ²) Line Side (Cu Stranded)	Torque lb-in (N•m)	Wires / Terminal	Class
9080LBC162104 9080LBC262104 9080LBC362104	1/0–2/0 (50–70)	120 (13.6)	1	B, C
	6–1 (16–35)	120 (13.6)	1	B, C, G, H, I (DLO)
	8 (10)	40 (4.5)	1	B, C, G, H, I (DLO)
	14–10 (2.5–6)	35 (4)	1	B, C, I (DLO)

Catalog No.	AWG (mm ²) Load Side (Cu Stranded)	Torque lb-in (N•m)	Wires / Terminal	Class
9080LBC162104 9080LBC262104 9080LBC362104	4 (25)	35 (4)	1	B, C
	8–6 (10–16)	35 (4)	1	B, C, G, H, I (DLO)
	14–10 (2.5–6)	35 (4)	1–4	B, C
	14–10 (2.5–6)	35 (4)	1–2	I (DLO)

Catalog No.	AWG (mm ²) Line & Load Side (Cu Stranded)	Torque lb-in (N•m)	Wires / Terminal	Class
9080LBC163101 9080LBC363101	250 (120)	375 (42.4)	1	B, C
	4/0 (95)	375 (42.4)	1	B, C, G, H
	2–3/0 (35–70)	375 (42.4)	1	B, C, G, H, I (DLO)
	6–4 (16–25)	375 (42.4)	1	B, C

Catalog No.	AWG (mm ²) Line Side (Cu Stranded)	Torque lb-in (N•m)	Wires / Terminal	Class
9080LBC163106 9080LBC263106 9080LBC363106	500 (240)	375 (42.4)	1	B, C
	2–400 (35–185)	375 (42.4)	1	B, C, G, H, I (DLO)
	4 (25)	375 (42.4)	1	B, C

Catalog No.	AWG (mm ²) Load Side (Cu Stranded)	Torque lb-in (N•m)	Wires / Terminal	Class
9080LBC163106 9080LBC263106 9080LBC363106	2 (35)	50 (5.6)	1	B, C
	6–4 (16–25)	45 (5.1)	1	B, C, G, H, I (DLO)
	8 (10)	40 (4.5)	1–2 [1]	B, C, G, H, I (DLO)
	10 (6)	35 (4)	1–2 [1]	B, C, I (DLO)
	14–12 (2.5–4)	35 (4)	1–2	I (DLO)
	14–12 (2.5–4)	35 (4)	1–4	B, C

Catalog No.	AWG (mm ²) Line Side (Cu Stranded)	Torque lb-in (N•m)	Wires / Terminal	Class
9080LBC163206 9080LBC263206 9080LBC363206	1/0–2/0 (50–70)	120 (13.6)	1	B, C
	6–1 (16–35)	120 (13.6)	1	B, C, G, H, I (DLO)
	8 (10)	40 (4.5)	1	B, C, G, H, I (DLO)
	14–10 (2.5–6)	35 (4)	1	B, C, I (DLO)

¹ Multiple wire rating applies to Class B, C, and I.

Terminal Blocks

Wire Classes

Wire Classes—9080LB Open Power Distribution Blocks *(continued)*

Catalog No.	AWG (mm ²) Load Side (Cu Stranded)	Torque lb-in (N•m)	Wires / Terminal	Class
9080LBC163206 9080LBC263206 9080LBC363206	4 (25)	35 (4)	1	B, C
	8–6 (10–16)	35 (4)	1	B, C, G, H, I (DLO)
	10 (6)	35 (4)	1–2	B, C, I (DLO)
	14–12 (2.5–4)	35 (4)	1–2	I (DLO)
	14–12 (2.5–4)	35 (4)	1–4	B, C
Catalog No.	AWG (mm ²) Line Side (Cu Stranded)	Torque lb-in (N•m)	Wires / Terminal	Class
9080LBC165208 9080LBC365208	500 kcmil (240)	375 (42.4)	1	B, C
	2–400 (35–185)	375 (42.4)	1	B, C, G, H, I (DLO)
	4 (25)	375 (42.4)	1	B, C
Catalog No.	AWG (mm ²) Load Side (Cu Stranded)	Torque lb-in (N•m)	Wires / Terminal	Class
9080LBC165208 9080LBC365208	1/0–2/0 (50–70)	120 (13.6)	1	B, C
	6–1 (16–35)	120 (13.6)	1	B, C, G, H, I (DLO)
	8 (10)	40 (4.5)	1	B, C, G, H, I (DLO)
	14–10 (2.5–6)	35 (4)	1	B, C, I (DLO)
Catalog No.	AWG (mm ²) Line Side (Cu Stranded)	Torque lb-in (N•m)	Wires / Terminal	Class
9080LBC165212 9080LBC365212	500 (240)	375 (42.4)	1	B, C
	2–400 (35–185)	375 (42.4)	1	B, C, G, H, I (DLO)
	4 (25)	375 (42.4)	1	B, C
Catalog No.	AWG (mm ²) Load Side (Cu Stranded)	Torque lb-in (N•m)	Wires / Terminal	Class
9080LBC165212 9080LBC365212	2 (35)	50 (5.6)	1	B, C
	6–4 (16–25)	45 (5.1)	1	B, C, G, H, I (DLO)
	8 (10)	40 (4.5)	1–2 [1]	B, C, G, H, I (DLO)
	10 (6)	35 (4)	1–2	B, C, I (DLO)
	14–12 (2.5–4)	35 (4)	1–2	I (DLO)
	14–12 (2.5–4)	35 (4)	1–4	B, C

INDEX OF CATALOG NUMBERS

Numerics							
		9080LBA165106	12, 31,	9080LBA364108	12, 31,	NSYEBAD25622	8, 29,
		34, 42, 43		33, 42		39	
9080FB1211	16	9080LBA165112	12, 31,	9080LBA365106	12, 31,	NSYEBAP12611	5, 28,
9080FB1211R	16	34, 43		34, 42, 43		29, 38	
9080FB1221R	18	9080LBA165202	13, 33,	9080LBA365112	12, 31,	NSYEBAP12614	6, 28,
9080FB1231R	19	43		34, 43		29, 38	
9080FB1611CC	17	9080LBA1652021	13, 34,	9080LBA365202	13, 33,	NSYEBAP13618	7, 29,
9080FB1611M	17	43		43		39	
9080FB2211	16	9080LBA165208	13, 31,	9080LBA3652021	13, 34,	NSYEBAP25622	8, 29,
9080FB2211R	16	34, 43		43		39	
9080FB2221R	18	9080LBA165212	13, 34,	9080LBA365208	13, 31,	NSYEBAP27622	9, 29,
9080FB2611	16	44		34, 43		39	
9080FB2611CC	17	9080LBA261104	10, 30,	9080LBA365212	13, 34,	NSYEBAP27628	9, 29,
9080FB2611M	17	32, 40		44		39	
9080FB3211	16	9080LBA262101	10, 32,	9080LBC162101	14, 31,	NSYEBAP27628	9, 29,
9080FB3211R	16	40		35, 44		NSYEBAP27628	9, 29,
9080FB3611	16	9080LBA262104	10, 30,	9080LBC162104	14, 31,	NSYEBAP27628	9, 29,
9080FB3611CC	17	32, 40, 41		35, 45		NSYEBAP27628	9, 29,
9080FB3611M	17	9080LBA263101	11, 32,	9080LBC163101	14, 35,	NSYEBAP27628	9, 29,
9080FB3611R	16	41		45		NSYEBAP27628	9, 29,
9080FB3621J	18	9080LBA263104	11, 30,	9080LBC163106	15, 35,	NSYEBAD25622	8, 29,
9080FB3621R	18	32, 41		45		39	
9080FB3631	19	9080LBA263106	11, 30,	9080LBC163206	15, 31,	NSYEBAD25622	8, 29,
9080FB3631R	19	31, 33, 41		35, 45, 46		NSYEBAD25622	8, 29,
9080FBDIN3	14, 16, 17	9080LBA263206	11, 30,	9080LBC165208	15, 35,	NSYEBAD25622	8, 29,
9080LB11	10	33, 42		46		NSYEBAD25622	8, 29,
9080LB12	10	9080LBA264108	12, 31,	9080LBC165212	15, 36,	NSYEBAD25622	8, 29,
9080LB13	10	33, 42		46		NSYEBAD25622	8, 29,
9080LB21	10, 14	9080LBA265106	12, 31,	9080LBC262104	14, 31,	NSYEBAD25622	8, 29,
9080LB22	10, 14	34, 42, 43		35, 45		NSYEBAD25622	8, 29,
9080LB23	10, 14	9080LBA265112	12, 31,	9080LBC263106	15, 35,	NSYEBAD25622	8, 29,
9080LB31	11, 14, 15	34, 43		45		NSYEBAD25622	8, 29,
9080LB32	11, 15	9080LBA265202	13, 33,	9080LBC263206	15, 31,	NSYEBAD25622	8, 29,
9080LB33	11, 14, 15	43		35, 45, 46		NSYEBAD25622	8, 29,
9080LB41	12	9080LBA2652021	13, 34,	9080LBC362101	14, 31,	NSYEBAD25622	8, 29,
9080LB42	12	43		35, 44		NSYEBAD25622	8, 29,
9080LB43	12	9080LBA265208	13, 31,	9080LBC362104	14, 31,	NSYEBAD25622	8, 29,
9080LB51	12, 13, 15	34, 43		35, 45		NSYEBAD25622	8, 29,
9080LB52	12, 13	9080LBA265212	13, 34,	9080LBC363101	14, 35,	NSYEBAD25622	8, 29,
9080LB53	12, 13, 15	44		45		NSYEBAD25622	8, 29,
9080LBA161101	10, 30,	9080LBA361101	10, 30,	9080LBC363106	15, 35,	NSYEBAD25622	8, 29,
32, 40		32, 40		45		NSYEBAD25622	8, 29,
9080LBA161104	10, 30,	9080LBA361104	10, 30,	9080LBC363206	15, 31,	NSYEBAD25622	8, 29,
32, 40		32, 40		35, 45, 46		NSYEBAD25622	8, 29,
9080LBA162101	10, 32,	9080LBA362101	10, 32,	9080LBC365208	15, 35,	NSYEBAD25622	8, 29,
40		40		46		NSYEBAD25622	8, 29,
9080LBA162104	10, 30,	9080LBA362104	10, 30,	9080LBC365212	15, 36,	NSYEBAD25622	8, 29,
32, 40, 41		32, 40, 41		46		NSYEBAD25622	8, 29,
9080LBA163101	11, 32,	9080LBA362106	14, 30,				
41		32, 44					
9080LBA163104	11, 30,	9080LBA363101	11, 32,				
32, 41		41					
9080LBA163106	11, 30,	9080LBA363104	11, 30,	N			
31, 33, 41		32, 41		NSYEBAD11611	4, 28,		
9080LBA163206	11, 30,	9080LBA363106	11, 30,	29, 38			
33, 42		31, 33, 41		NSYEBAD11614	4, 28,		
9080LBA164101	12, 33,	9080LBA363206	11, 30,	29, 38			
42		33, 42		NSYEBAD12611	5, 28,		
9080LBA164108	12, 31,	9080LBA364101	12, 33,	29, 38			
33, 42		42		NSYEBAD12614	6, 28,		
				29, 38			
				NSYEBAD13618	7, 29,		
				39			

Schneider Electric USA, Inc.
800 Federal Street
Andover, MA 01810 USA
888-778-2733
www.schneider-electric.us

Schneider Electric, Linergy, and Square D are trademarks and the property of Schneider Electric SE, its subsidiaries, and affiliated companies. All other trademarks are the property of their respective owners.
9080CT9603R12/17 Replaces 9080CT9603R10/16, 11/2016
© 1993–2017 Schneider Electric All Rights Reserved