

ABL-6RP●●●●

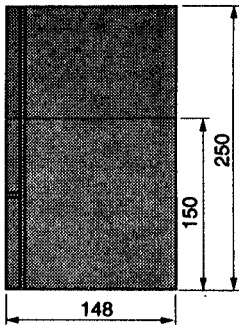

ABL-6RP1202
ABL-6RP2402
ABL-6RP2403

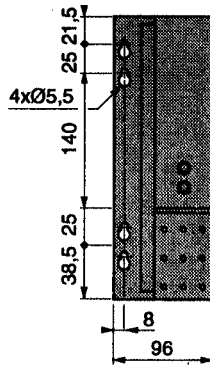
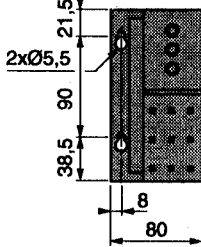

ABL-6RP2406
ABL-6RP2412
ABL-6RP4806

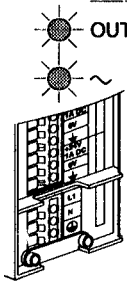

OUT (1-2)

OK

○ OUT (1-2)

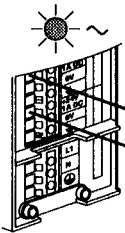

$I > 1,15 I_n$

○ OUT (1-2)

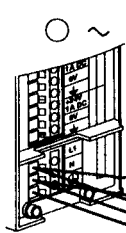

$V < 90 V \sim$



90 - 275 V

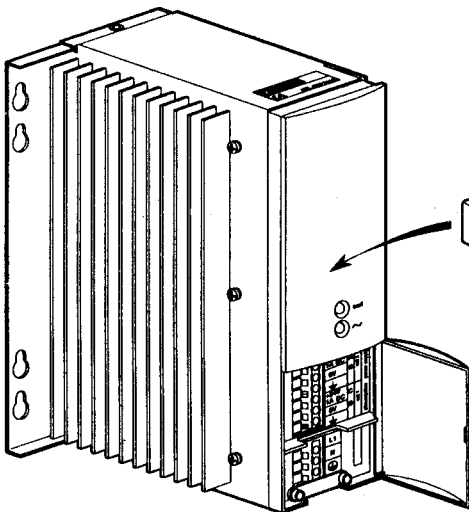

AR1-SB3

AB1Rø/Gø

Ø 3,5					
mm ²	AWG	mm ²	AWG	C	(Nm)
0,2	24	0,2	24	0,6	
2,5	14	4	12		

ABL-6RP1202
 ABL-6RP2402

