



**SEMITOP<sup>®</sup> 3**

## 3-phase bridge rectifier+ series thyristor

### SK 80 DTA

Preliminary Data

### Features

- Compact design
- One screw mounting
- Heat transfer and isolation through direct copper bonded aluminium oxide ceramic (DBC)
- Glass passivated thyristor chips
- Reverse voltage up to 1600 V
- High surge currents

### Typical Applications\*

- Soft starters
- Light control
- Temperature control

$V_{RSM}$ V	$V_{RRM}, V_{DRM}$ V	$I_D = 81$ A ( $T_s = 80$ °C)
900	800	SK 80 DTA 08
1300	1200	SK 80 DTA 12
1700	1600	SK 80 DTA 16

**Characteristics**  $T_s = 25$  °C unless otherwise specified

Symbol	Conditions	Values	Units
$I_D$	$T_s = 80$ °C; Ind. load	81	A
$I_{TAV}$	sin. 180°; $T_s = 25$ (80) °C per thyristor	113 (65)	A
$I_{FAV}$	sin. 180°; $T_s = 25$ (80) °C per diode	65 (45)	A
$I_{TSM}/I_{FSM}$	$T_{vj} = 25$ (125) °C; 10 ms	2000 (1800)	A
$I^2t$	$T_{vj} = 25$ (125) °C; 8,3 ... 10 ms	20000 (16200)	A <sup>2</sup> s
$T_{stg}$		-40,...+125	°C
$T_{solder}$	terminals, 10 s	260	°C

Thyristor			
$(dv/dt)_{cr}$	$T_{vj} = 125$ °C	1000	V/μs
$(di/dt)_{cr}$	$T_{vj} = 125$ °C; $f = f$ Hz	50	A/μs
$t_q$	$T_{vj} = 125$ °C; typ.	120	μs
$I_H$	$T_{vj} = 25$ °C; typ. / max.	100 / 200	mA
$I_L$	$T_{vj} = 25$ °C; $R_G = 33$ Ω; typ. / max.	200 / 500	mA
$V_T$	$T_{vj} = 25$ °C; ( $I_T = 300$ A); max.	1,85	V
$V_{T(TO)}$	$T_{vj} = 125$ °C	max. 0,9	V
$r_T$	$T_{vj} = 125$ °C	max. 3,5	mΩ
$I_{DD}; I_{RD}$	$T_{vj} = 125$ °C; $V_{DD} = V_{DRM}; V_{RD} = V_{RRM}$	max. 20	mA
$R_{th(j-s)}$	Cont. per thyristor	0,45	K/W
$T_{vj}$		- 40 ... + 125	°C
$V_{GT}$	$T_{vj} = 25$ °C; d.c.	2	V
$I_{GT}$	$T_{vj} = 25$ °C; d.c.	100	mA
$V_{GD}$	$T_{vj} = 125$ °C; d.c.	0,25	V
$I_{GD}$	$T_{vj} = 125$ °C; d.c.	5	mA

Diode			
$V_F$	$T_{vj} = 25$ °C; ( $I_F = 75$ A); max.	1,45	V
$V_{(TO)}$	$T_{vj} = 125$ °C	0,8	V
$r_T$	$T_{vj} = 125$ °C	4,5	mΩ
$I_{RD}$	$T_{vj} = 125$ °C; $V_{RD} = V_{RRM}$	2	mA
$R_{th(j-s)}$	per diode	1	K/W
$T_{vj}$		-40...+150	°C

Mechanical data			
$V_{isol}$	a. c. 50 Hz; r.m.s.; 1 s / 1 min	3000 (2500)	V
$M_1$	mounting torque	2,5	Nm
w		30	g
Case	SEMITOP <sup>®</sup> 3	T 45	

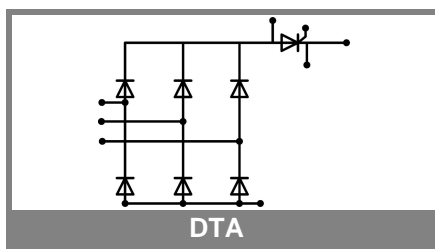

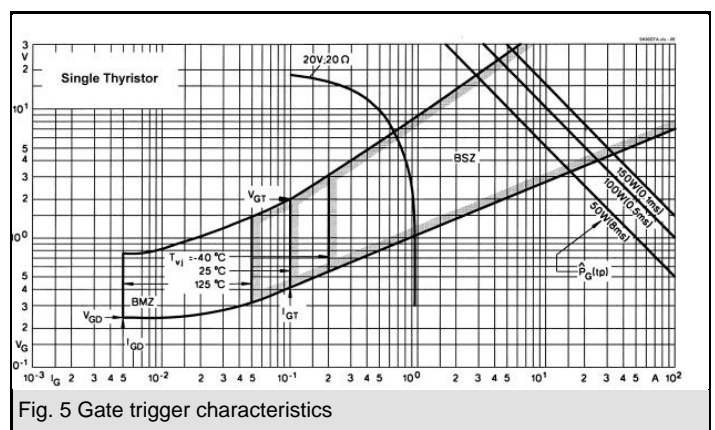
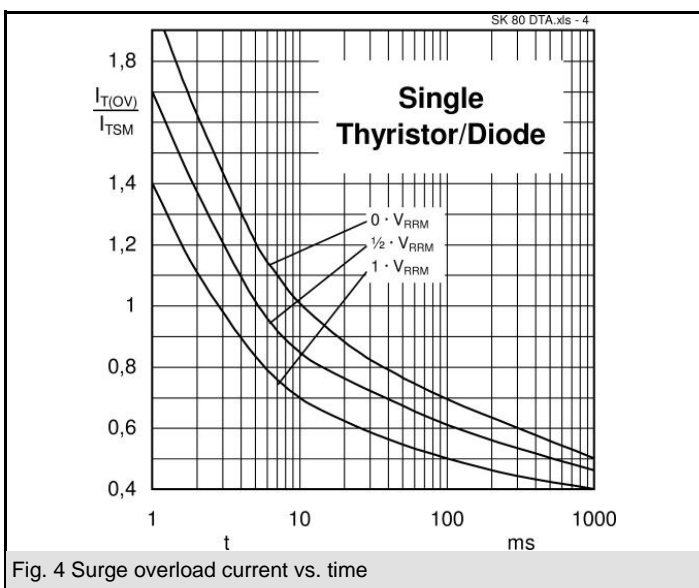
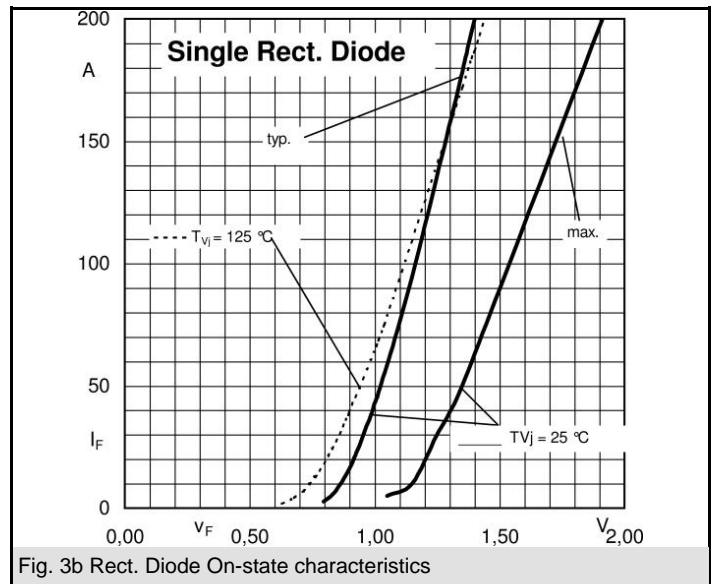
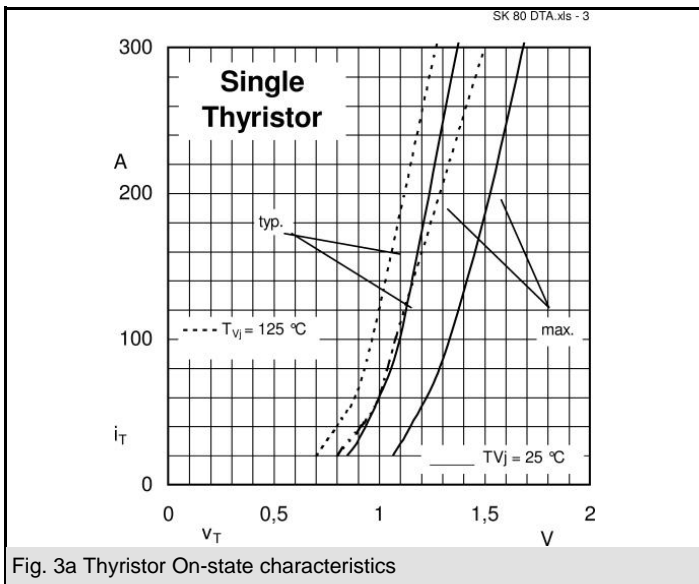
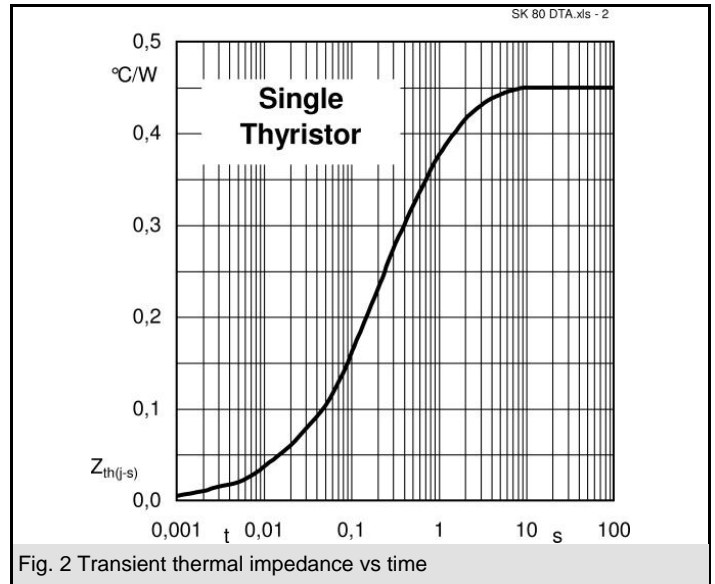
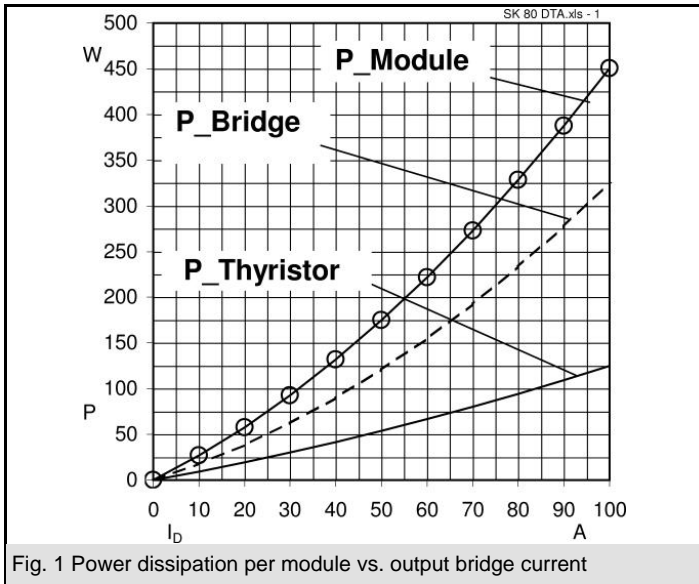

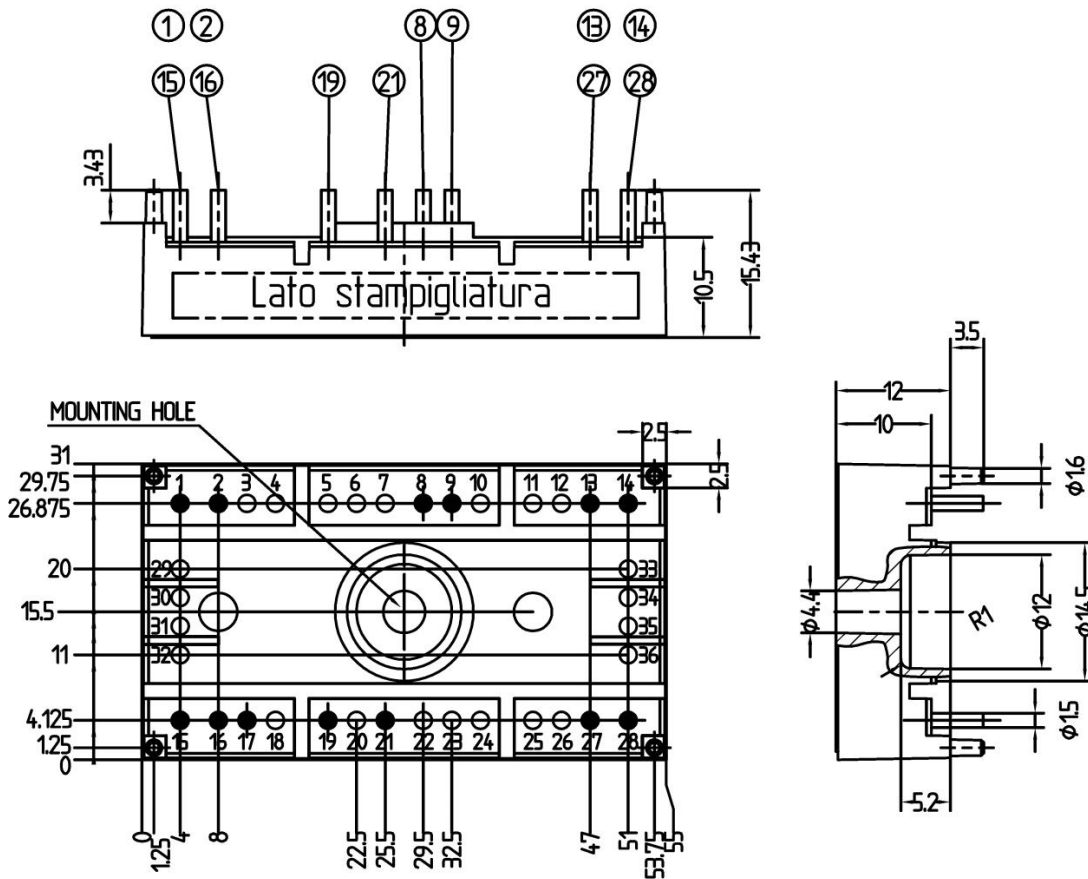

SUGGESTED HOLEDIAMETER FOR THE SOLDER PINS AND THE MOUNTING PINS IN THE PCB: 2 mm

Case T45 (Suggested hole diameter, in the PCB, for solder pins and plastic mounting pins: 2mm)

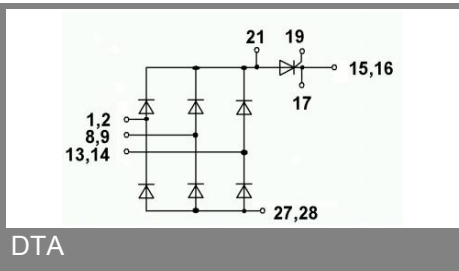

DTA

This is an electrostatic discharge sensitive device (ESDS), international standard IEC 60747-1, Chapter IX.

\* The specifications of our components may not be considered as an assurance of component characteristics. Components have to be tested for the respective application. Adjustments may be necessary. The use of SEMIKRON products in life support appliances and systems is subject to prior specification and written approval by SEMIKRON. We therefore strongly recommend prior consultation of our personal.