

Piezo valves VEMP

FESTO



Key features



Innovative

- Piezo technology
- Very low power consumption
- High precision

Versatile

- When combined with pressure sensor and control electronics it can be used as a proportional pressure regulator
- When combined with a flow sensor and control electronics it can be used as a proportional flow control valve

Reliable

- No self-heating
- Long service life

Easy to mount

- Can be mounted on a terminal strip
- Small installation space
- Light weight

Key features

Mode of operation

Description

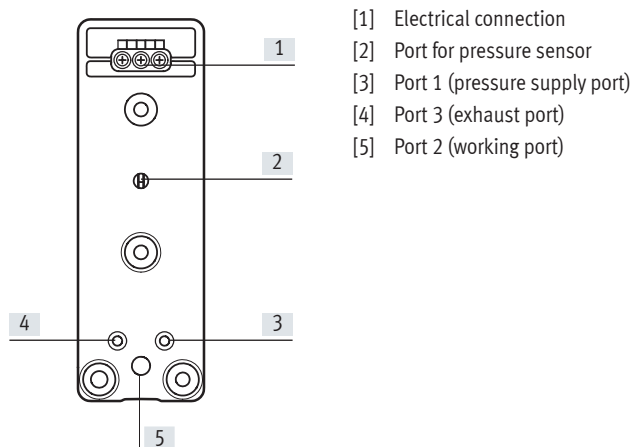

The VEMP is a proportional 3/3-way valve in which a split piezo actuator (piezo actuator 1 and 2) is controlled electrically. The valve also has a connection for a pressure sensor.

When combined with a pressure sensor and control electronics, the 3/3-way proportional valve can be used as a proportional pressure regulator.

Alternatively, the flow can also be controlled using a closed loop circuit by integrating a flow sensor in the output line (operation as 2/2-way valve).

In the normal position, the valve is closed. The working and pressure sensor ports are connected and always open, regardless of the switching status.

The two piezo actuators can only be actuated separately; if they are activated simultaneously, safe and reliable operation cannot be ensured.

Control response

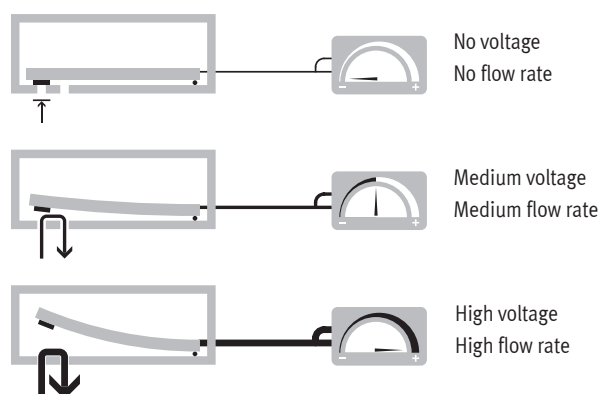

The piezo actuators are actuated using variable voltage to give proportional control.

The piezo valve VEMP exhibits the typical hysteresis behaviour of a proportional valve. Linear behaviour can be achieved by combining control electronics with a flow sensor.

This allows either the pressure or flow rate to be controlled, depending on the design.

The pressure or flow behaviour is controlled by integrating a sensor in the output line of the closed-loop control circuit.

Operation as a proportional 3/3-way valve

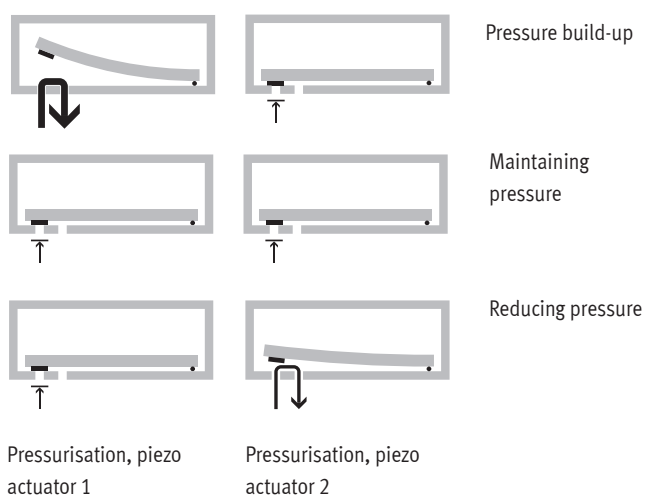

The piezo actuators installed in the valve VEMP proportionally regulate both the pressure and flow rate for pressurisation and ensure proportional exhausting.

Exhausting:
 During exhausting, piezo actuator 2 opens, enabling flow from port 2 (working port) to port 3 (exhaust). At the same time, piezo actuator 1 closes port 1 (pressure supply port).

Pressurisation:
 During pressurisation, piezo actuator 1 opens, enabling flow from port 1 (pressure supply port) to port 2 (working port). At the same time, piezo actuator 2 closes port 3 (exhaust).

Key features

Mode of operation

Operation as a proportional 2/2-way valve

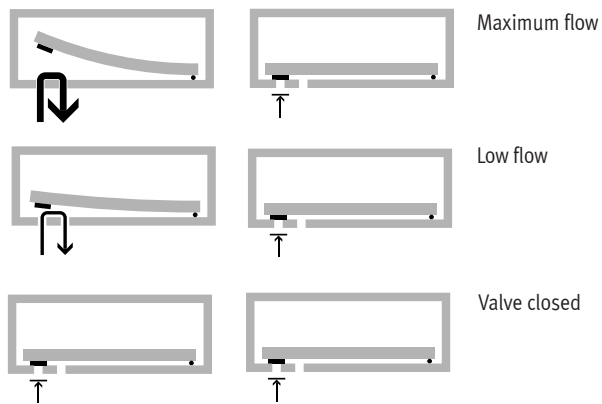

When used as a proportional 2/2-way valve, only piezo actuator 2 (exhaust) is switched; piezo actuator 1 (pressure supply port) must be electrically connected to earth (GND).

The flow behaviour is controlled by integrating a sensor in the supply or output line of the closed-loop control circuit.

Flow takes place from port 2 (working port) to port 3 (exhaust). When used as a 2/2-way valve, port 1 (pressure supply port) is not used, and must be closed.

Exhausting, piezo actuator 2 Exhausting, piezo actuator 1

Low energy consumption

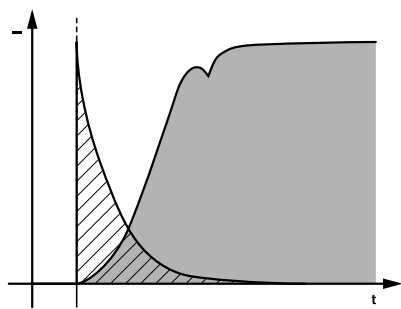

Compared with solenoid valves, proportional valves with piezo technology require virtually no energy to maintain an active state thanks to their capacitive principle. The piezo valve operates like a capacitor: it needs current only at the start in order to charge the piezoceramics.

No further energy is needed to maintain its state. The valves therefore generate no heat. They consume up to 95% less energy than solenoid valves, which permanently require an electrical current

Peripherals overview

Example: VEMP with sub-base

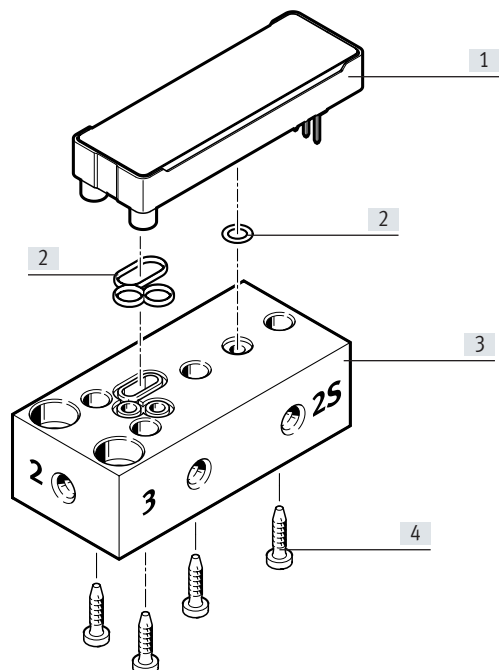

Designation		→ Page/Internet
[1]	Piezo valve VEMP	14
[2]	Assortment of seals	14
[3]	Sub-base	14
[4]	Screw set	14

Product range overview

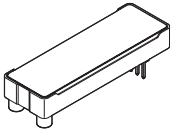
Function	Description	Nominal width	Flow rate [l/min]	Operating pressure [bar]	Operating voltage		
					0 ... 310 V	0 ... 250 V	
Sub-base valve		3/3-way valve, normally closed, monostable					
		Flange	1.3 mm	19/20	0 ... 1.1	–	■
		3/3-way valve, normally closed, monostable					
		Flange	1.3 mm	28/30	0 ... 1.7	■	–
		3/3-way valve, normally closed, monostable					
		Flange	1.6 mm	18/19	0 ... 0.7	■	–
		3/3-way valve, normally closed, monostable					
		Flange	1.6 mm	28/27	0 ... 1.1	■	–

Type codes

001	Series	
VEMP	Piezo valve	
002	Directional control valve type	
B	Sub-base valve	
003	Design principle	
S	Bending actuator	
004	Valve function	
3	3/3-way valve, normally closed	
005	Nominal width [mm]	
1.3	1.3	
1.6	1.6	

006	Pressure range [bar]	
D5	0 ... 0.5	
D7	0 ... 1	
D19	0 ... 1.7	
007	Pneumatic connection	
F	Flange/sub-base	
008	Nominal operating voltage	
22	250 V DC	
28	310 V DC	
009	Electrical connection	
T1	Pin	
010	Package unit quantity	
	Standard	
P30	30	

Data sheet

-  - Flow rate
19 ... 29 l/min

-  - Voltage
0 ... 250 V DC
0 ... 310 V DC

-  - Operating pressure
0 ... 1.7 bar

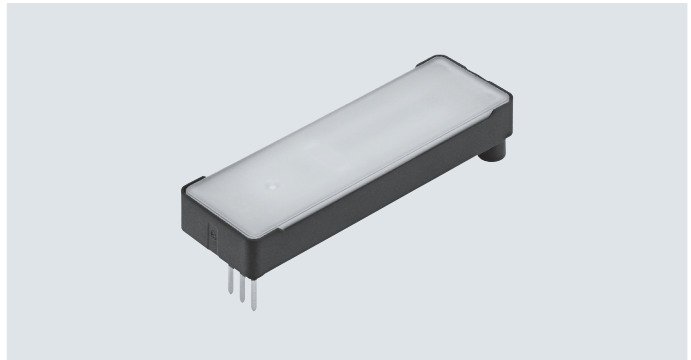

General technical data

	VEMP-BS-3-13-D7-...	VEMP-BS-3-13-D19-...	VEMP-BS-3-16-D5-...	VEMP-BS-3-16-D7-...
Valve function	3/3-way valve, monostable	3/3-way valve or 2/2-way valve, monostable	3/3-way valve, monostable	3/3-way valve, monostable
Normal position	Closed			
Standard nominal flow rate 1 → 2	[l/min] 19	28	18	27
Standard nominal flow rate 2 → 3	[l/min] 20	29	19	28
Dimensions W x L x H	[mm] 17.2 x 52.1 x 7.2			
Nominal width	[mm] 1.3	1.3	1.6	1.6
Grid dimension	[mm] 17.2			
Pneumatic connection 1, 2, 3	Flange			
Actuation type	Electrical			
Type of mounting	On manifold rail			
Mounting position	Any			
Flow direction	1 → 2 and 2 → 3			
Product weight	[g] 8			
Special characteristics	Oxygen-compatible to DIN EN 1797			

Electrical data

	VEMP-BS-3-13-D7-...	VEMP-BS-3-13-D19-...	VEMP-BS-3-16-D5-...	VEMP-BS-3-16-D7-...
Nominal operating voltage	[V DC] 250	310	310	310
Operating voltage range	[V DC] 0 ... 250	0 ... 310	0 ... 310	0 ... 310
Max. electrical power consumption	[mW] 1			
Max. current consumption	[mA] 5			
Max. switching frequency	[Hz] 5			
Degree of protection	Depending on the manifold block			

Data sheet

Operating and environmental conditions		VEMP-BS-3-13-D7-...	VEMP-BS-3-13-D19-...	VEMP-BS-3-16-D5-...	VEMP-BS-3-16-D7-...
Operating pressure	[bar]	0 ... 1.1	0 ... 1.7	0 ... 0.7	0 ... 1.1
Nominal operating pressure	[bar]	1	1.7	0.5	1
Operating medium		<ul style="list-style-type: none"> Compressed air to ISO 8573-1:2010 [6:3:4] Inert gases Air Oxygen Nitrogen 			
Note on the operating/pilot medium		Operation with lubricated medium not possible			
Air quality	[μm]	≤ 5			
Ambient temperature	[$^{\circ}\text{C}$]	-20 ... 70			
Temperature of medium	[$^{\circ}\text{C}$]	-20 ... 60			
Corrosion resistance class CRC		2 ¹⁾			

1) Corrosion resistance class CRC 2 to Festo standard FN 940070

Moderate corrosion stress. Indoor applications in which condensation can occur. External visible parts with primarily decorative surface requirements which are in direct contact with a normal industrial environment.

Safety characteristics	
CE marking (see declaration of conformity)	To EU Low Voltage Directive ¹⁾
Shock resistance	Shock test with severity level 2, to EN 60068-2-27
Vibration resistance	Transport application test with severity level 2, to EN 60068-2-6

1) For information about the area of use, see the EC declaration of conformity at: www.festo.com/sp → Certificates.

If the devices are subject to usage restrictions in residential, commercial or light-industrial environments, further measures for the reduction of the emitted interference may be necessary.

Materials	
Seals	EPDM
Housing	Reinforced PA
Cover	Reinforced PA
Note on materials	RoHS-compliant

Design

Circuit symbol

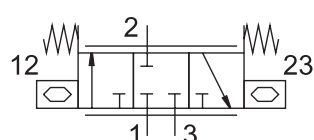

• 3/3-way valve, normally closed

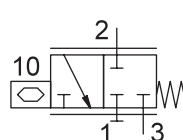

• 2/2-way valve, normally closed

Note on risk assessment when used in medical equipment

The product has no redundancy and no error detection. Malfunctions must be detected by measures in the customer product if required.

Pin allocation		Pin	Function
		1	GND
		2	Pressurising
		3	Exhausting

Data sheet

VEMP-BS-3-13-D7-F-22T1, 1.3 mm nominal width

Flow plotted against operating pressure at 250 V

Flow plotted against voltage at room temperature, operating pressure 1 bar

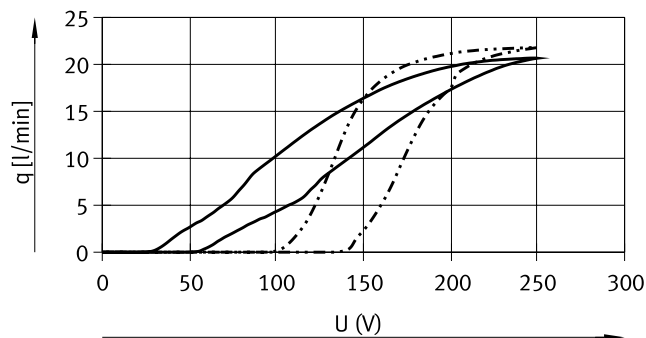
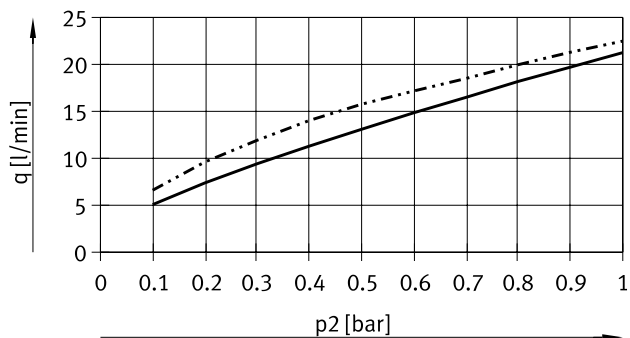

— Flow rate 1 → 2
 - - - Flow rate 2 → 3

— Flow rate 1 → 2
 - - - Flow rate 2 → 3

VEMP-BS-3-13-D19-F-28T1, 1.3 mm nominal width

Flow plotted against operating pressure at 310 V

Flow plotted against voltage at room temperature, operating pressure 1.7 bar

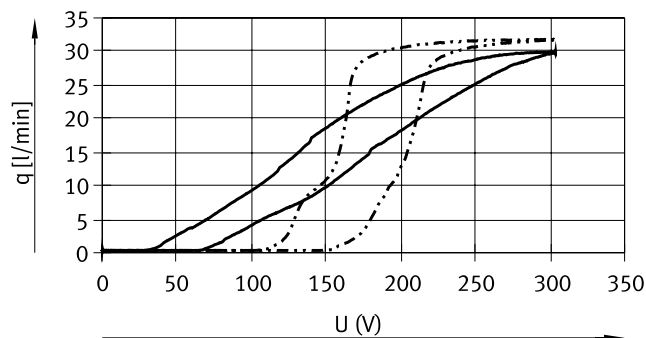
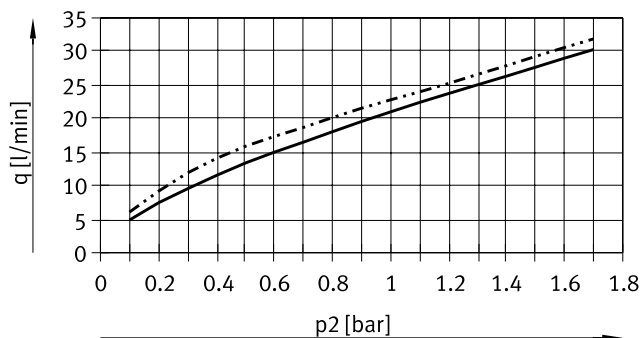

— Flow rate 1 → 2
 - - - Flow rate 2 → 3

— Flow rate 1 → 2
 - - - Flow rate 2 → 3

Data sheet

VEMP-BS-3-16-D5-F-28T1, 1.6 mm nominal width

Flow plotted against operating pressure at 310 V

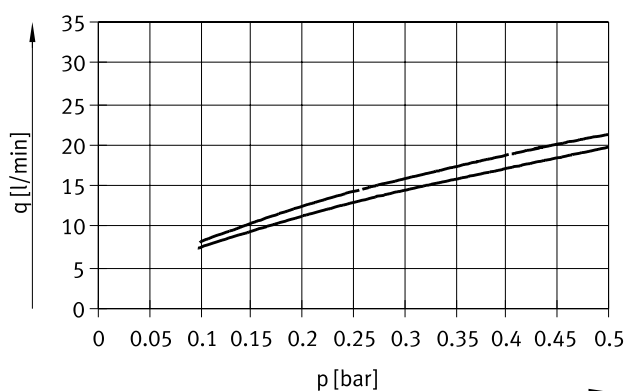

— Flow rate 1 → 2
 - - - Flow rate 2 → 3

Flow plotted against voltage at room temperature, operating pressure 0.5 bar

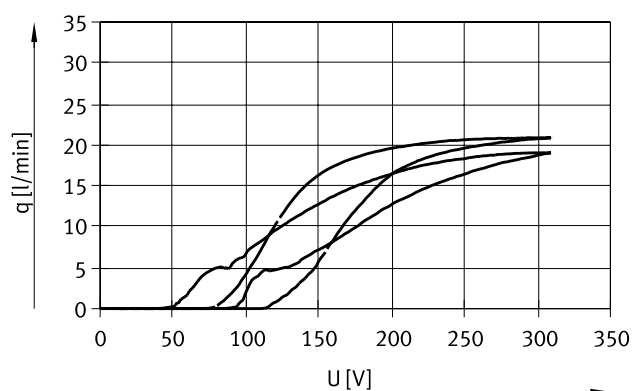

— Flow rate 1 → 2
 - - - Flow rate 2 → 3

VEMP-BS-3-16-D7-F-28T1, 1.6 mm nominal width

Flow plotted against operating pressure at 310 V

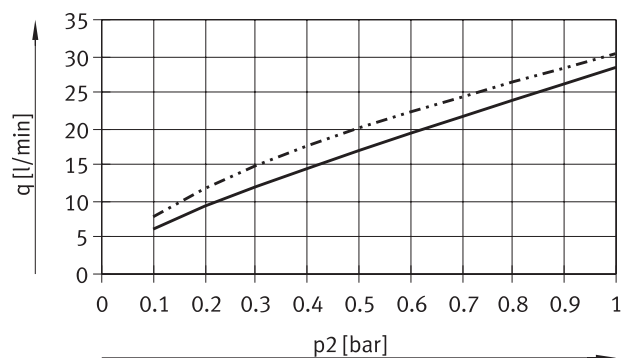

— Flow rate 1 → 2
 - - - Flow rate 2 → 3

Flow plotted against voltage at room temperature, operating pressure 1 bar

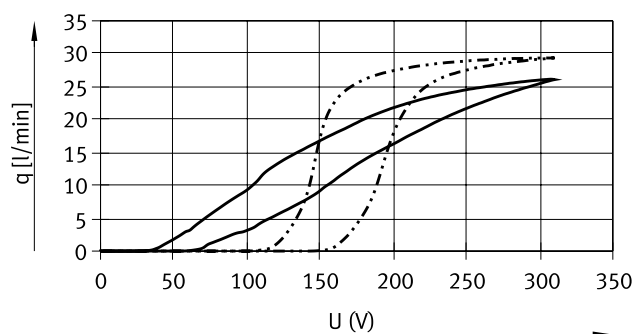

— Flow rate 1 → 2
 - - - Flow rate 2 → 3

Data sheet

Dimensions

Download CAD data → www.festo.com

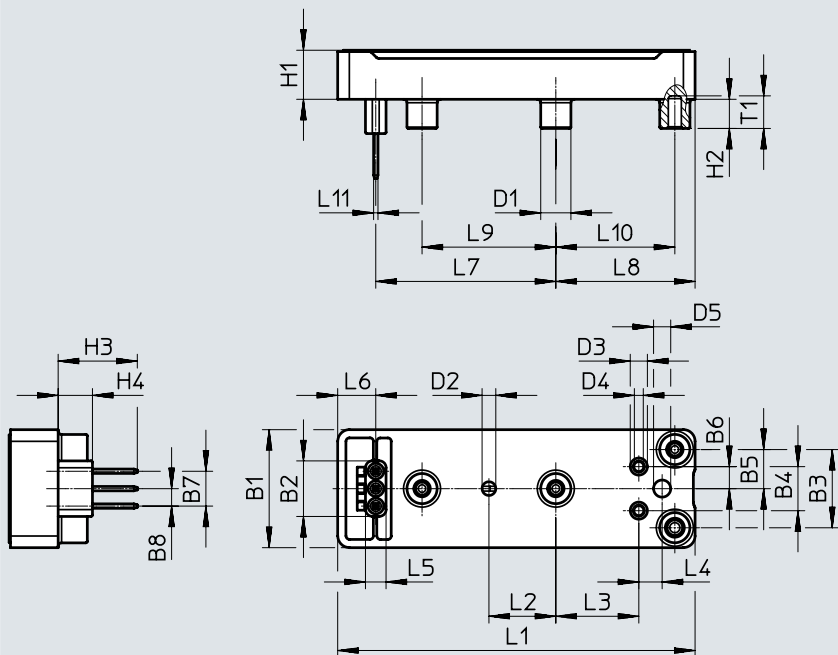

Type	B1	B2	B3	B4	B5	B6	B7	B8	D1 ∅	D2 ∅	D3 ∅	D4 ∅	D5 ∅
VEMP	17.2	8.1	11.4	6.4	5.7	3.2	5.1	2.5	4.4	2	2.5	1.3/1.6	2.5

Type	H1	H2	H3	H4	L1	L2	L3	L4	L5	L6	L7	L8	L9	L10	L11	T1
VEMP	7.2	4.3	11.6	5	52.1	9.8	12.1	3.4	3	5.6	26.3	20.3	19.5	17.4	0.6	4.8

Data sheet

Dimensions

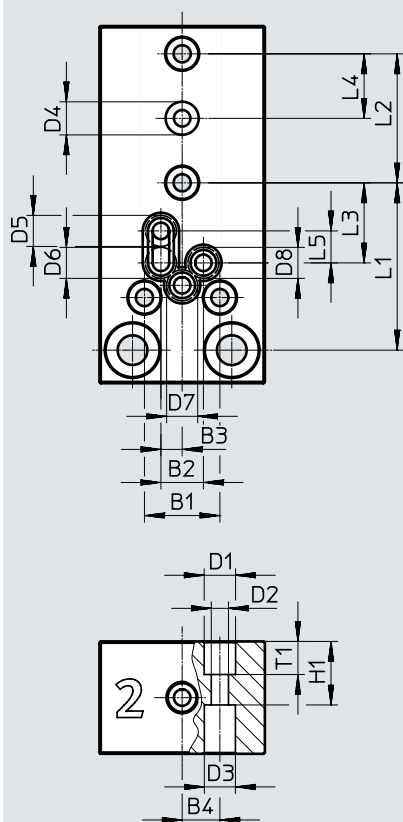

Download CAD data → www.festo.com

Example of manifold rail, seal

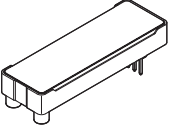
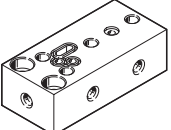

B1	B2	B3	B4	D1 ∅	D2 ∅	D3 ∅	D4 ∅	D5 ∅	D6 ∅	D7 ∅	D8 ∅	H1	L1	L2	L3	L4	L5	T1
11.4	6.4	3.2	5.7	4.8	2.6	4.7	5	4.7	4.7	4.7	4.7	9.6	25.3	19.5	12.1	9.8	4.8	5

Accessories

Ordering data	Description	Nominal width [mm]	Operating pressure [bar]	Part no.	Type
Sub-base valve					
	3/3-way valve (piezo valve), monostable, normally closed	1.3	0 ... 1.1	8064292	VEMP-BS-3-13-D7-F-22T1
				8064293	VEMP-BS-3-13-D7-F-22T1-P30
			0 ... 1.7	8065734	VEMP-BS-3-13-D19-F-28T1
			8065735	VEMP-BS-3-13-D19-F-28T1-P30	
		1.6	0 ... 0.7	8065738	VEMP-BS-3-16-D5-F-28T1
				8065739	VEMP-BS-3-16-D5-F-28T1-P30
0 ... 1.1	8064294		VEMP-BS-3-16-D7-F-28T1		
	8064295	VEMP-BS-3-16-D7-F-28T1-P30			
Sub-base					
	For 3/3-way valve, with 4 pneumatic connections M5 (pressure supply port, exhaust, working port, sensor connection). The sensor connection is connected to the working port.			8068637	VABS-P12-S-M5-P3
Assortment of seals					
	For 30 valves, comprising seal (30 units) and O-ring for sensor connection (30 units)			8065525	VABD-P12-S-P30
Screw set					
	120 screws for 30 valves (4 screws per valve VEMP)			8065526	VAME-P12-MK

Festo - Your Partner in Automation



1 Festo Inc.
5300 Explorer Drive
Mississauga, ON L4W 5G4
Canada

Festo Customer Interaction Center
Tel: 1 877 463 3786
Fax: 1 877 393 3786
Email: customer.service.ca@festo.com



2 Festo Pneumatic
Av. Ceylán 3,
Col. Tequesquináhuac
54020 Tlalnepantla,
Estado de México

Multinational Contact Center
01 800 337 8669
ventas.mexico@festo.com



3 Festo Corporation
1377 Motor Parkway
Suite 310
Islandia, NY 11749

Festo Customer Interaction Center
1 800 993 3786
1 800 963 3786
customer.service.us@festo.com



4 Regional Service Center
7777 Columbia Road
Mason, OH 45040

Connect with us



www.festo.com/socialmedia



www.festo.com

Subject to change