

## Solenoid valves VUVS/Valve manifold assembly VTUS

**FESTO**



Festo Core Range  
Solves the majority of your automation tasks

With the Festo Core Range, we have selected the most important products and functions from our broad product catalogue, and added the quickest delivery.

Worldwide: Quickest delivery – wherever, whenever  
Simply good: Expected high Festo quality  
Fast: Easy and fast to select

The Core Range offers you the best value for your automation tasks.

Just look  
for the  
star!

## Key features

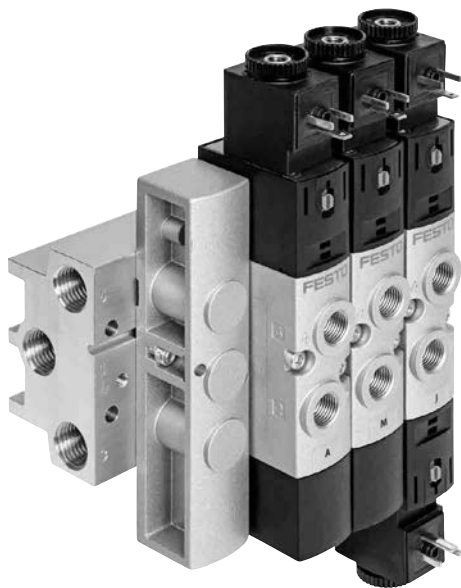

### Innovative

- A reliable, robust valve with a long service life
- Design principle:
  - Piston spool with sealing ring (VUVS-LK)
  - Poppet seat, soft-sealing (VUVS-LT)
  - Piston spool with sealing cartridge (VUVS-L)
- Flow rate up to 1800 l/min with VUVS-LK and VUVS-LT
- Flow rate up to 2300 l/min with VUVS-L
- Wide range of valve functions

### Flexible

- Operating voltage can be easily altered by changing the solenoid coil (VUVS-L and VUVS-LT)
- In-line valves can be used as individual valves or manifold valves
- Variable pressure zones
- Wide range of mounting options

### Reliable

- Ergonomic and safe operation
- Reliable servicing thanks to valves that can be replaced quickly and easily

### Easy to install

- Pre-assembled units on rails
- Individual valves assembled ready for installation
- Common supply manifolds for mounting on one or both sides
- Secure mounting on wall or H-rail

### Ordering data – Product options

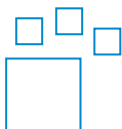

Configurable product  
This product and all its product options can be ordered using the configurator.

The configurator can be found under Products on the DVD or at  
→ [www.festo.com/catalogue/...](http://www.festo.com/catalogue/...)

Part no.	Type
576516	VUVS-20
8022014	VUVS-25
8022017	VUVS-30
577304	VTUS-20
8022016	VTUS-25
8022019	VTUS-30

## Key features

## Solenoid valves VUVS

In-line valve VUVS-LK as individual valve (piston spool valve)

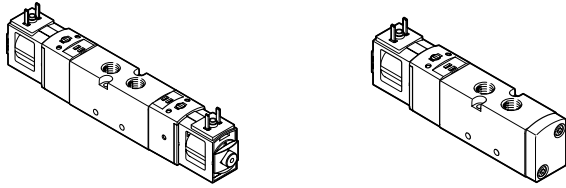

In-line valve VUVS-LT as individual valve (poppet seat valve)

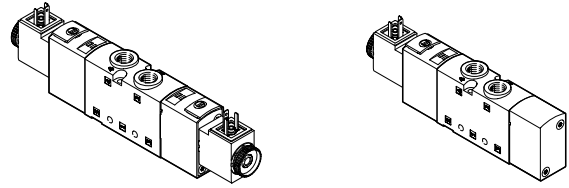

In-line valve VUVS-L as individual valve (piston spool valve)

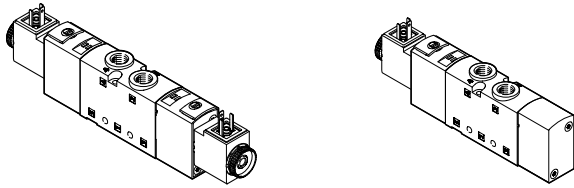

In-line valves are designed to be used without pneumatic linking. All pneumatic connections are on the valve and can be equipped with fittings/tubing.

By using a special seal set, the in-line valves can also be mounted on a manifold rail (pneumatic linking) as semi in-line valves.

Valve manifold assembly VTUS

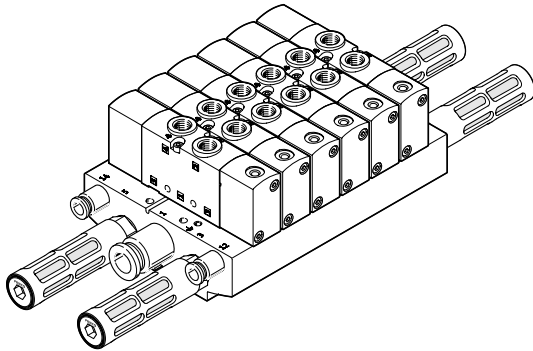

## Equipment options

VUVS-LK

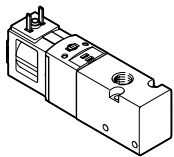

- 3/2- and 5/2-way valves, with solenoid coil
- Size 20 (21 mm), size 25 (26.5 mm) and size 30 (31 mm)

Valve functions

- 3/2-way valve, normal position open, single solenoid:
- Internal pilot air supply
  - Reset via: pneumatic spring
  - Flow direction not reversible

- 5/2-way single solenoid valve:
- Internal pilot air supply
  - Reset via: pneumatic spring
  - Flow direction not reversible

- 5/2-way double solenoid valve:
- Internal pilot air supply
  - Flow direction not reversible

## Key features

### Equipment options

VUVS-LT

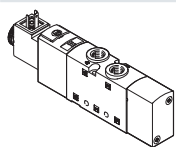

- 3/2-, 2x 3/2- and 5/2-way valves, with or without solenoid coil
- Size 20 (21 mm), size 25 (26.5 mm) and size 30 (31 mm)

### Valve functions

3/2-way valve, normal position open, single solenoid:

- Internal/external pilot air supply
- Reset via: mechanical spring
- Flow direction not reversible

3/2-way valve, normal position closed, single solenoid:

- Internal/external pilot air supply
- Reset via: mechanical spring
- Flow direction not reversible

2x 3/2-way valve, normal position open, single solenoid:

- Internal/external pilot air supply
- Reset via: mechanical spring
- Flow direction not reversible

2x 3/2-way valve, normal position closed, single solenoid:

- Internal/external pilot air supply
- Reset via: mechanical spring
- Flow direction not reversible

2x 3/2-way valve, 1x normally open, 1x normally closed, single solenoid:

- Internal/external pilot air supply
- Reset via: mechanical spring
- Flow direction not reversible

5/2-way single solenoid valve:

- Internal/external pilot air supply
- Reset via: mechanical spring
- Flow direction not reversible

5/2-way double solenoid valve:

- Internal/external pilot air supply
- Flow direction not reversible

## Key features

## Equipment options

## VUVS-L

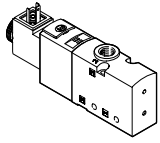

- 3/2-, 5/2- and 5/3-way valves, with or without solenoid coil
- Size 20 (21 mm), size 25 (26.5 mm) and size 30 (31 mm)

## Valve functions

3/2-way valve, normal position open, single solenoid:

- Internal/external pilot air supply
- Reset via pneumatic/mechanical spring
- Flow direction can be reversed in the case of external pilot air supply

3/2-way valve, normal position closed, single solenoid:

- Internal/external pilot air supply
- Reset via pneumatic/mechanical spring
- Flow direction can be reversed in the case of external pilot air supply

5/2-way single solenoid valve:

- Internal/external pilot air supply
- Reset via pneumatic/mechanical spring
- Flow direction can be reversed in the case of external pilot air supply

5/2-way double solenoid valve:

- Internal/external pilot air supply
- Flow direction can be reversed in the case of external pilot air supply

5/3-way valve, mid-position exhausted, pressurised or closed:

- Internal/external pilot air supply
- Reset via: mechanical spring
- Flow direction can be reversed in the case of external pilot air supply

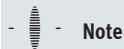

## Note

The operating voltage of valves VUVS-L and VUVS-LT can be varied by changing the solenoid coil on the armature tube.

## Key features

- A maximum of 16 valve positions can be configured in the standard version (for VUVS-L variant only)
- A maximum of 12 valve positions can be configured in the compact version (maximum of 10 valve positions for VUVS-LK variant)
- Valve positions 2 ... 10 can be configured in increments of 1, valve positions 10 ... 16 in increments of 2
- Manifold block with a maximum of 10 valve positions
- Extension module with 2 valve positions
- Common supply manifold with a maximum of 10 valve positions
- Creation of pressure zones (maximum 9 pressure zones in the case of a valve manifold assembly with 16 valve positions)

## Design

## Valve replacement

Each valve is attached to the manifold block using two screws. The appropriate seal is mounted on the valve.

This means that the valves can be easily replaced.

## Extension

Valve positions covered with cover plates can be replaced with valves at a later date. The dimensions, mounting points and existing pneumatic installation remain unchanged.

Extension modules with two valve positions are available for the standard manifold block. A manifold block can be extended with a maximum of three extension modules.

## Key features

### Standard manifold block

For 3/2-way valves

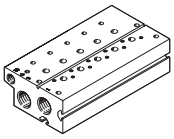

- Connection  
Size 20: G3/8  
Size 25: G1/2  
Size 30: G3/4
- For valves with external pilot air supply
- Maximum 10 valve positions

For 5/2- and 5/3-way valves

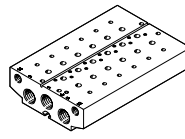

- Connection  
Size 20: G3/8  
Size 25: G1/2  
Size 30: G3/4
- For valves with external pilot air supply
- Maximum 10 valve positions

### Manifold block extension module, for standard manifold block

For 3/2-way valves

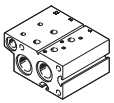

- Connection  
Size 20: G3/8  
Size 25: G1/2  
Size 30: G3/4
- Maximum two valve positions

For 5/2- and 5/3-way valves

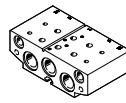

- Connection  
Size 20: G3/8  
Size 25: G1/2  
Size 30: G3/4
- Maximum two valve positions

### Compact manifold block

For 3/2-way valves

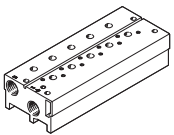

- Connection  
Size 20: G1/4  
Size 25: G3/8  
Size 30: G1/2
- Maximum 10 valve positions

For 5/2- and 5/3-way valves

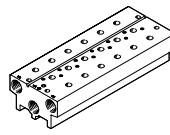

- Connection  
Size 20: G1/4  
Size 25: G3/8  
Size 30: G1/2
- Maximum 10 valve positions

### Common supply manifold

Mounting on both sides

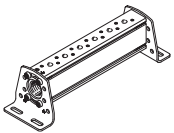

- Connection  
Size 20: G3/8  
Size 25: G1/2  
Size 30: G3/4
- Maximum 10 valve positions

Mounting on one side

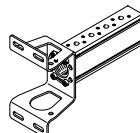

- Connection  
Size 20: G3/8  
Size 25: G1/2  
Size 30: G3/4
- Maximum 4 valve positions

### Cover plate for vacant position

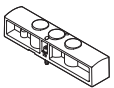

For covering vacant valve positions

### Supply plate

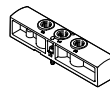

For additional air supply and exhaust via a valve position

### Separator for pressure zones



For creating pressure zones (maximum 9 pressure zones permitted)

### Note

A filter must be installed upstream of valves operated in vacuum mode. This prevents any foreign matter in the intake air getting into the valve (e.g. when operating a suction cup).

## Key features – Pneumatics

### Creating pressure zones and separating exhaust air

Compressed air is supplied and exhausted via the manifold block/common supply manifold and via supply plates.

The position of the supply plates and duct separations can be freely selected with the VTUS.

A pressure zone is created by isolating the internal ducts between the valve positions with an appropriate separator.

The separator can be used in the following ducts:

- Duct 1
- Duct 3
- Duct 5



#### Note

- Use a separator if the exhaust air pressures are high
- Use at least one supply plate/supply for each pressure zone
- Pressure zone separation is not possible in ducts 12 and 14 (pilot air supply)

Duct separation	Description	
	<p>The pressure zones can be freely configured with the VTUS. The following duct separations are possible:</p>	
	<ul style="list-style-type: none"> <li>• Duct 1 closed</li> </ul>	
	<ul style="list-style-type: none"> <li>• Duct 1/3/5 closed</li> </ul>	
	<ul style="list-style-type: none"> <li>• Duct 3/5 closed</li> </ul>	
	<p>The number of pressure zones with the VTUS is limited by the number of valve positions on the manifold block/common supply manifold. Note that each supply plate occupies one valve position. There must always be at least two valve positions between two separators. In the case of a maximum extension of 16 valve positions, a maximum of 9 pressure zones can be created.</p>	

Key features – Pneumatics, VUVS-LK

**Size 20 – Standard nominal flow rate  $q_{nN}$ , with several valves  $n$  connected in parallel**

For 3/2-way valves

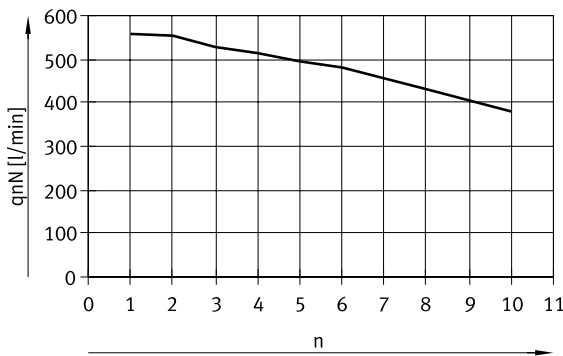

— Standard nominal flow rate per valve on compact manifold rail

For 5/2-way valves

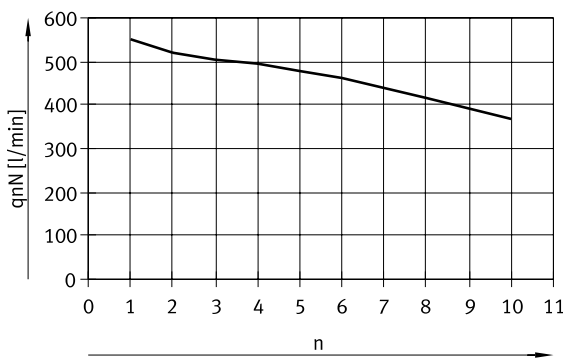

— Standard nominal flow rate per valve on compact manifold rail

**Size 25 – Standard nominal flow rate  $q_{nN}$ , with several valves  $n$  connected in parallel**

For 3/2-way valves

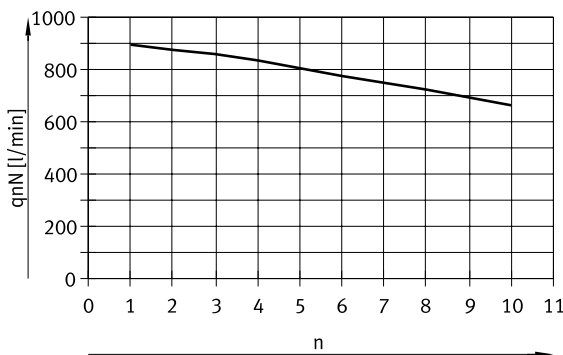

— Standard nominal flow rate per valve on compact manifold rail

For 5/2-way valves

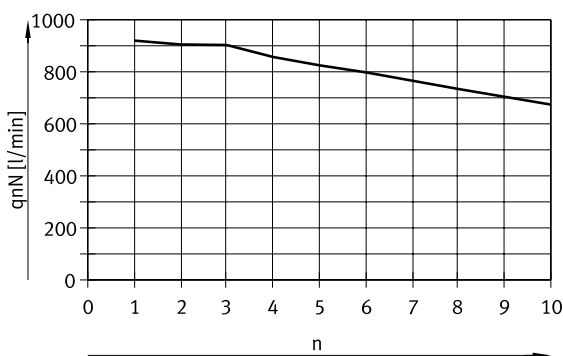

— Standard nominal flow rate per valve on compact manifold rail



Key features – Pneumatics, VUVS-LT

Size 20 – Standard nominal flow rate  $q_{nN}$ , with several valves  $n$  connected in parallel

For 3/2-way valves

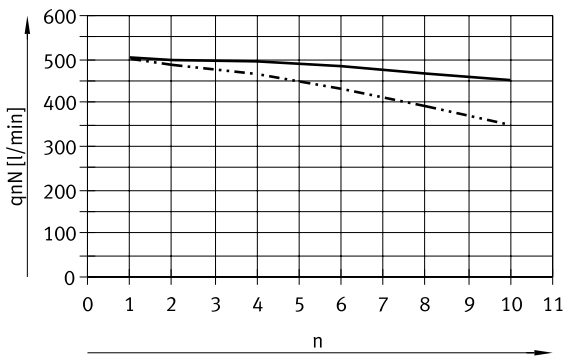

- Standard nominal flow rate per valve on standard manifold rail
- - - Standard nominal flow rate per valve on compact manifold rail

For 5/2-way valves, flow direction 1 → 2

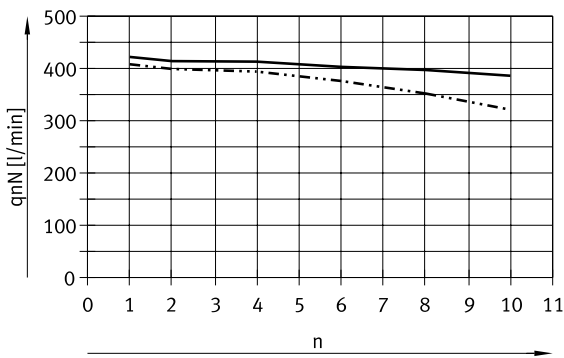

- Standard nominal flow rate per valve on standard manifold rail
- - - Standard nominal flow rate per valve on compact manifold rail

For 5/2-way valves, flow direction 1 → 4

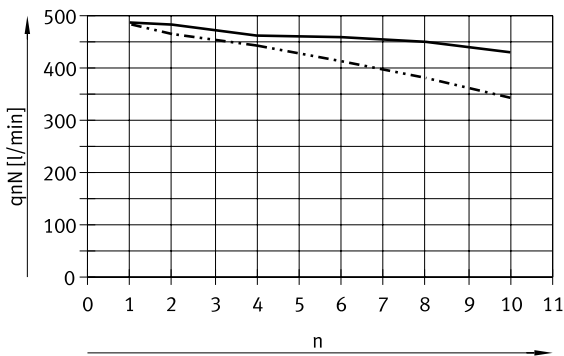

- Standard nominal flow rate per valve on standard manifold rail
- - - Standard nominal flow rate per valve on compact manifold rail

## Key features – Pneumatics, VUVS-LT

### Size 20 – Standard nominal flow rate $q_{nN}$ , with several valves $n$ connected in parallel

For 2x 3/2-way valves

One valve function per valve position in open switching position

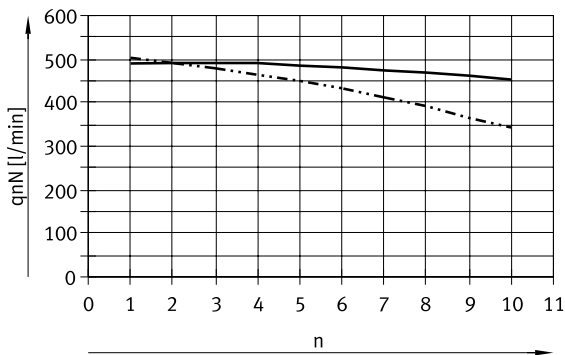

- Standard nominal flow rate per valve on standard manifold rail
- - - Standard nominal flow rate per valve on compact manifold rail

For 2x 3/2-way valves

Both valve functions per valve position simultaneously in open switching position

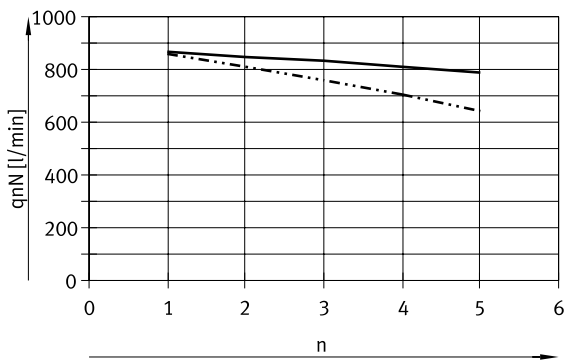

- Standard nominal flow rate per valve on standard manifold rail
- - - Standard nominal flow rate per valve on compact manifold rail

Key features – Pneumatics, VUVS-LT

Size 25 – Standard nominal flow rate  $q_{nN}$ , with several valves  $n$  connected in parallel

For 3/2-way valves

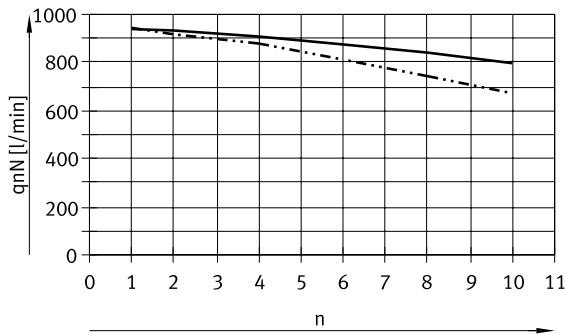

- Standard nominal flow rate per valve on standard manifold rail
- - - Standard nominal flow rate per valve on compact manifold rail

For 5/2-way valves, flow direction 1 → 2

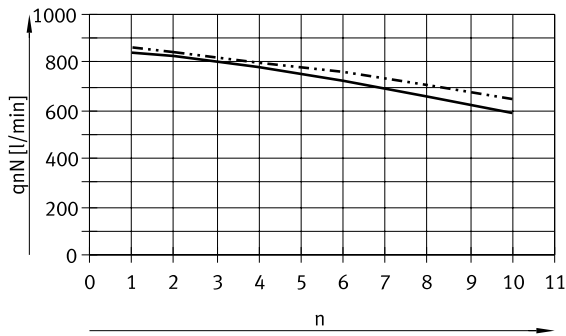

- Standard nominal flow rate per valve on standard manifold rail
- - - Standard nominal flow rate per valve on compact manifold rail

For 5/2-way valves, flow direction 1 → 4

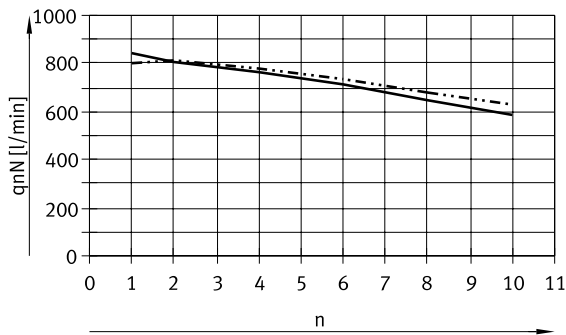

- Standard nominal flow rate per valve on standard manifold rail
- - - Standard nominal flow rate per valve on compact manifold rail

## Key features – Pneumatics, VUVS-LT

### Size 25 – Standard nominal flow rate $q_{nN}$ , with several valves $n$ connected in parallel

For 2x 3/2-way valves

One valve function per valve position in open switching position

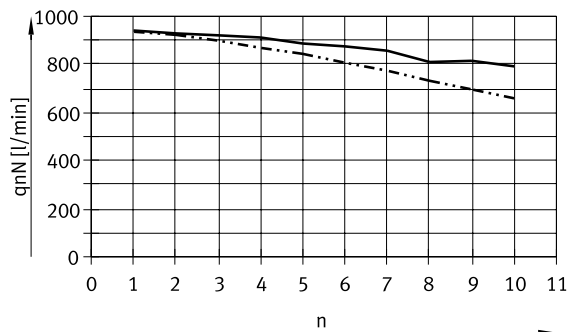

- Standard nominal flow rate per valve on standard manifold rail
- - - Standard nominal flow rate per valve on compact manifold rail

For 2x 3/2-way valves

Both valve functions per valve position simultaneously in open switching position

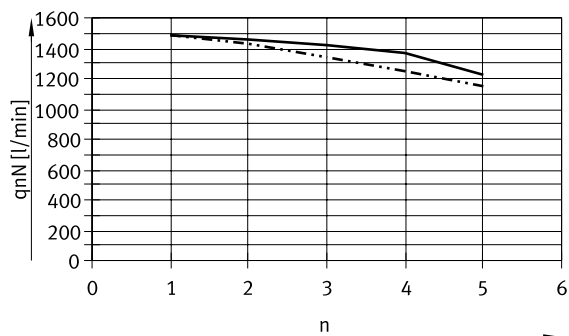

- Standard nominal flow rate per valve on standard manifold rail
- - - Standard nominal flow rate per valve on compact manifold rail

## Key features – Pneumatics, VUVS-LT

### Size 30 – Standard nominal flow rate $q_{nN}$ , with several valves $n$ connected in parallel

For 3/2-way valves

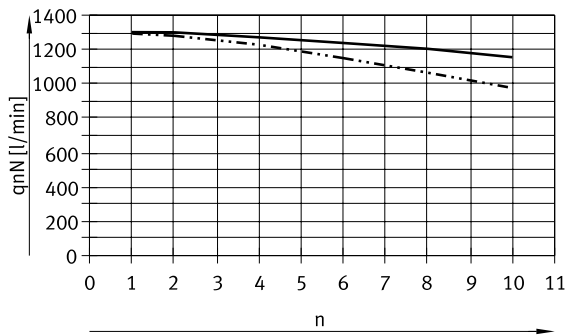

- Standard nominal flow rate per valve on standard manifold rail
- - - Standard nominal flow rate per valve on compact manifold rail

For 5/2-way valves, flow direction 1 → 2

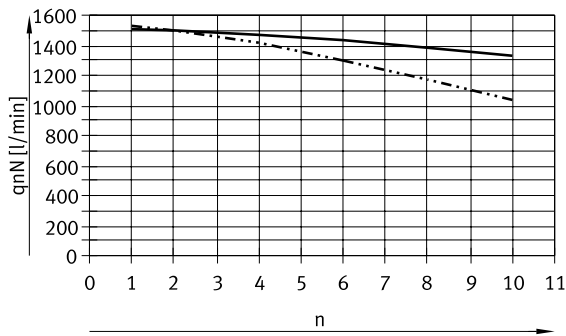

- Standard nominal flow rate per valve on standard manifold rail
- - - Standard nominal flow rate per valve on compact manifold rail

For 5/2-way valves, flow direction 1 → 4

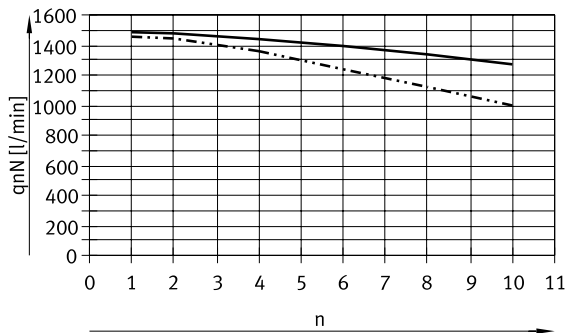

- Standard nominal flow rate per valve on standard manifold rail
- - - Standard nominal flow rate per valve on compact manifold rail

## Key features – Pneumatics, VUVS-LT

### Size 30 – Standard nominal flow rate $q_{nN}$ , with several valves $n$ connected in parallel

For 2x 3/2-way valves

One valve function per valve position in open switching position

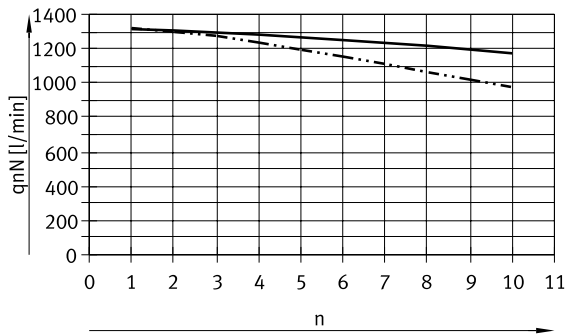

- Standard nominal flow rate per valve on standard manifold rail
- - - Standard nominal flow rate per valve on compact manifold rail

For 2x 3/2-way valves

Both valve functions per valve position simultaneously in open switching position

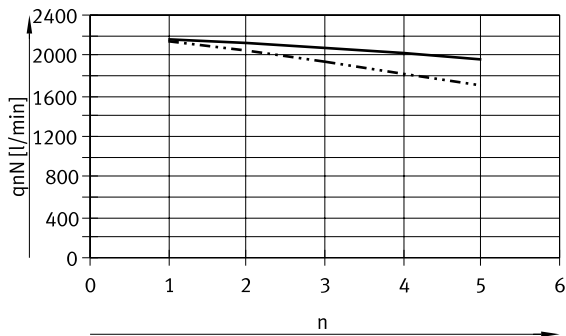

- Standard nominal flow rate per valve on standard manifold rail
- - - Standard nominal flow rate per valve on compact manifold rail

## Key features – Pneumatics, VUVS-L

### Size 20 – Standard nominal flow rate $q_{nN}$ , with several valves $n$ connected in parallel

For 3/2-way valves

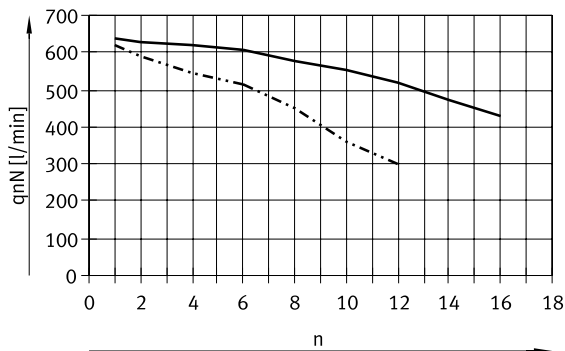

- Standard nominal flow rate per valve on standard manifold rail
- · - · Standard nominal flow rate per valve on compact manifold rail

For 5/2- and 5/3-way valves

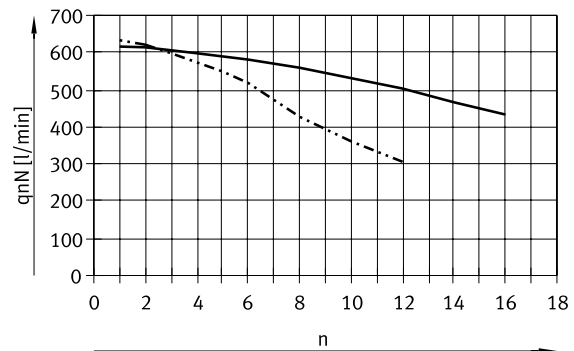

- Standard nominal flow rate per valve on standard manifold rail
- · - · Standard nominal flow rate per valve on compact manifold rail

### Size 25 – Standard nominal flow rate $q_{nN}$ , with several valves $n$ connected in parallel

For 3/2-way valves

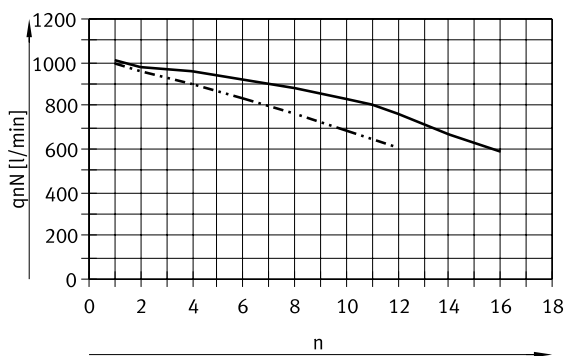

- Standard nominal flow rate per valve on standard manifold rail
- · - · Standard nominal flow rate per valve on compact manifold rail

For 5/2- and 5/3-way valves

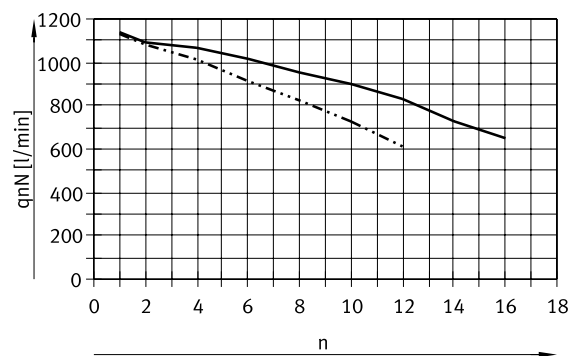

- Standard nominal flow rate per valve on standard manifold rail
- · - · Standard nominal flow rate per valve on compact manifold rail

Key features – Pneumatics, VUVS-L

**Size 30 – Standard nominal flow rate  $q_{nN}$ , with several valves  $n$  connected in parallel**

For 3/2-way valves

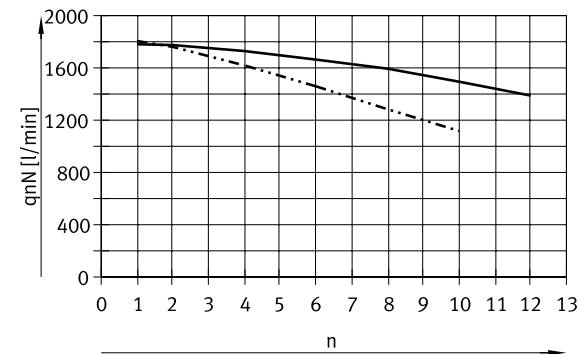

- Standard nominal flow rate per valve on standard manifold rail
- - - Standard nominal flow rate per valve on compact manifold rail

For 5/2- and 5/3-way valves

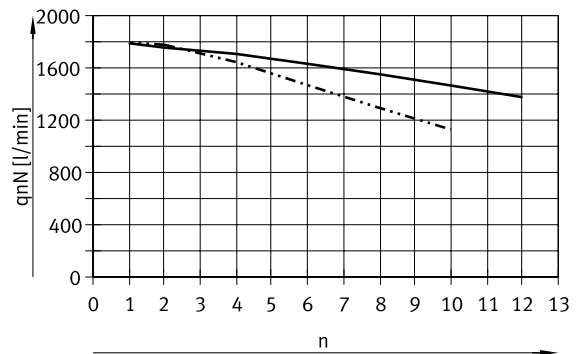

- Standard nominal flow rate per valve on standard manifold rail
- - - Standard nominal flow rate per valve on compact manifold rail



## Key features – Pneumatics, VUVS-LT

### Size 20 – Pilot pressure $p_2$ as a function of working pressure $p_1$ with external pilot air supply

For 3/2-way valves

for 5/2-way single solenoid valves

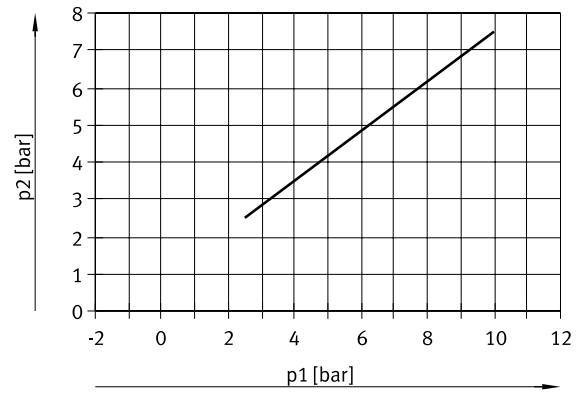
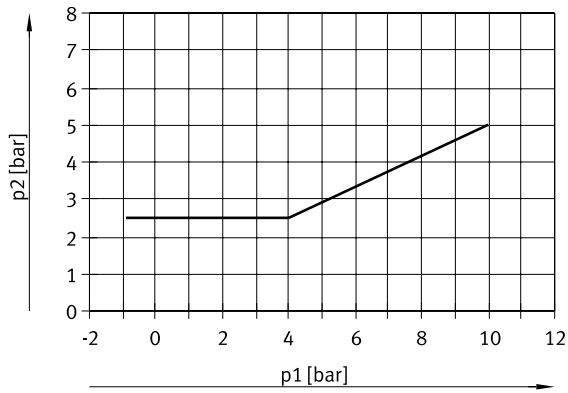

for 5/2-way double solenoid valves

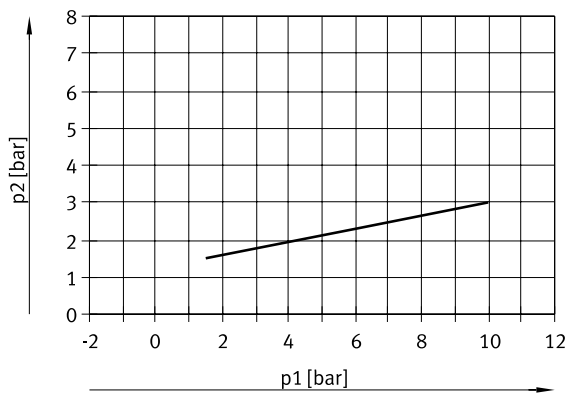

Key features – Pneumatics, VUVS-LT

Size 25 – Pilot pressure  $p_2$  as a function of working pressure  $p_1$  with external pilot air supply

For 3/2-way valves

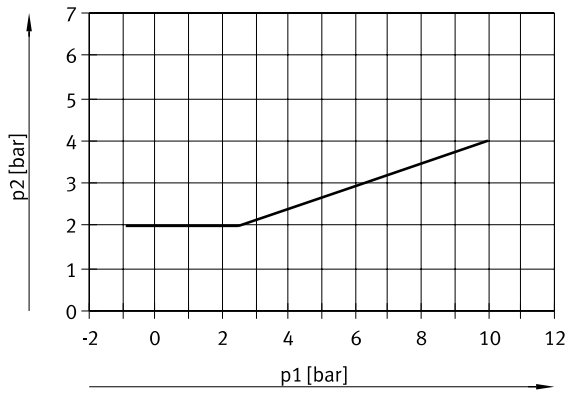

for 5/2-way single solenoid valves

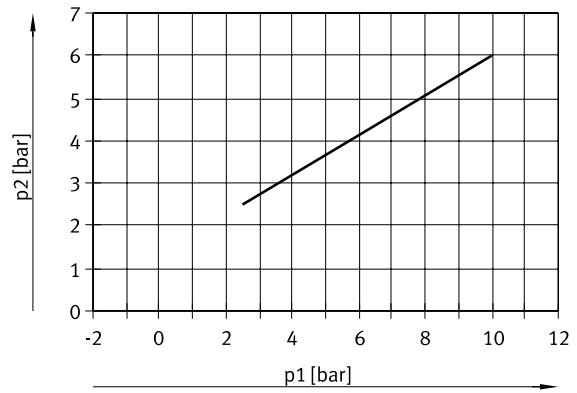

for 5/2-way double solenoid valves

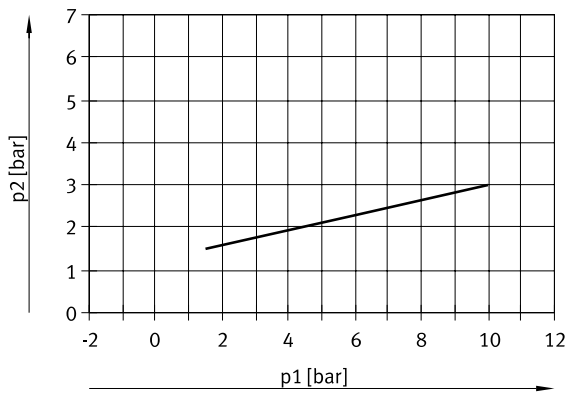

## Key features – Pneumatics, VUVS-LT

### Size 30 – Pilot pressure $p_2$ as a function of working pressure $p_1$ with external pilot air supply

For 3/2-way valves

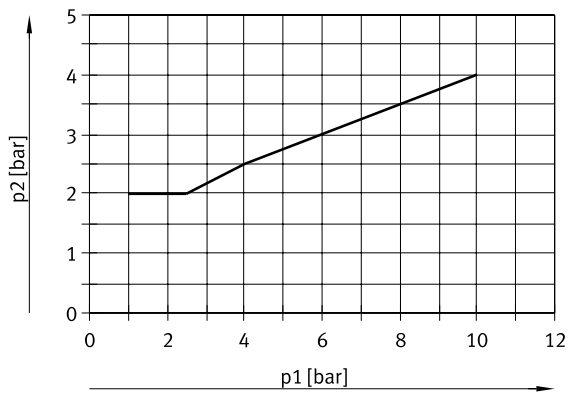

for 5/2-way single solenoid valves

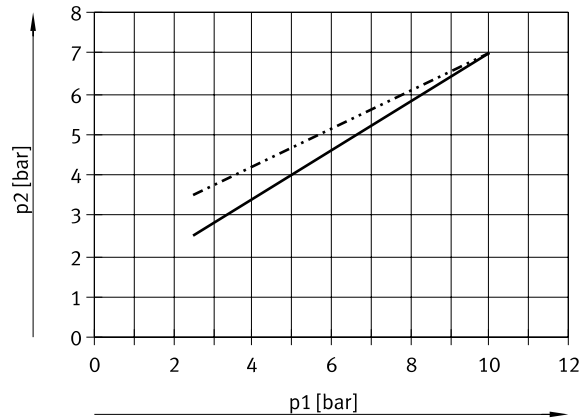

for 5/2-way double solenoid valves

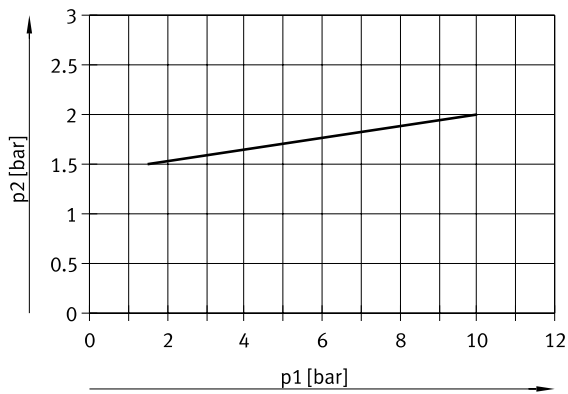

- VUVS-LT30-M52-MZD (0-60°C)
- · - · - · VUVS-LT30-M52-MZD (-10-0°C)

## Key features – Pneumatics

### Mounting – Valve manifold assembly VTUS

Sturdy manifold assembly thanks to:

- Four through-holes for wall mounting
- H-rail mounting

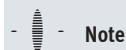

**Note**

Use the thread M4/M5 provided on the manifold block for earthing the valve manifold assembly.

### Wall mounting

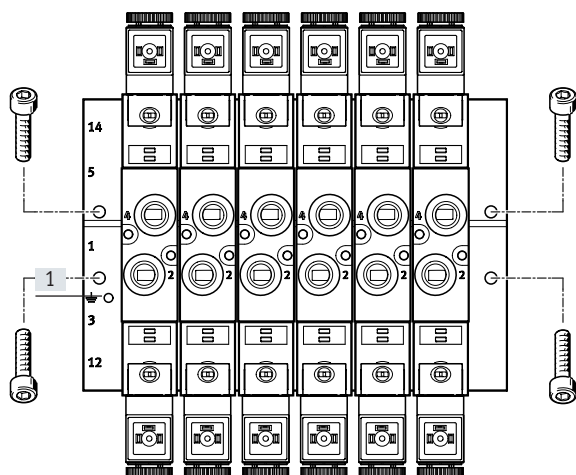

Sturdy wall mounting of the manifold block using four through-holes.

[1] Earth terminal

### H-rail mounting

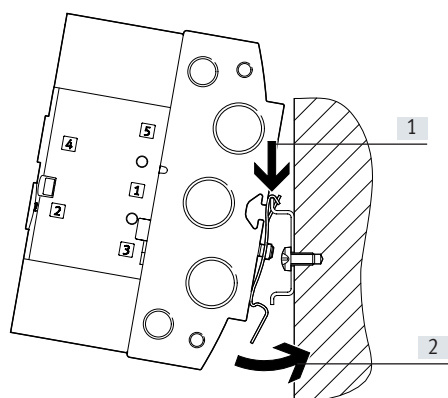

[1] Arrow A  
[2] Arrow B

The H-rail mounting VAME-T-M... consists of two mounting clips. These are screwed to the manifold block on the left and right.

The valve manifold assembly VTUS is then lowered onto the H-rail from above (arrow A) and clipped into the H-rail at the bottom (arrow B).

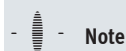

**Note**

- Note the max. tightening torque of the screws for H-rail mounting
- Only horizontal H-rail mounting is permissible
- Mounting only permissible on H-rail TH 35 to EN 60715
- Vibration/shock loads are not permissible with H-rail mounting
- Further note on assembly → Assembly instructions for H-rail mounting VAME-T-M...

## Key features – Mounting

**Mounting – Individual valve VUVS**

## Wall mounting

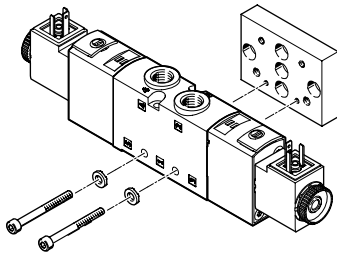

For mounting individual valves on a flat surface, e.g. aluminium profile systems.

The solenoid valves are provided with two through-holes for attaching to the wall mounting VAME-B10-20-W.

The relevant screw set is included when the wall mounting VAME-B10-20-W is ordered.

## Mounting on a stand

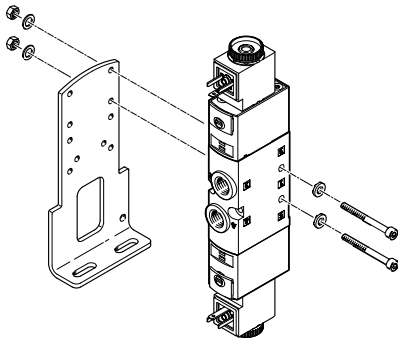

For mounting individual valves on a flat surface, e.g. aluminium profile systems.

The solenoid valves are provided with two through-holes for attaching to the foot mounting VAME-B10-...-A.

The relevant screw set is included when the foot mounting VAME-B10-...-A is ordered.

## Cylinder mounting

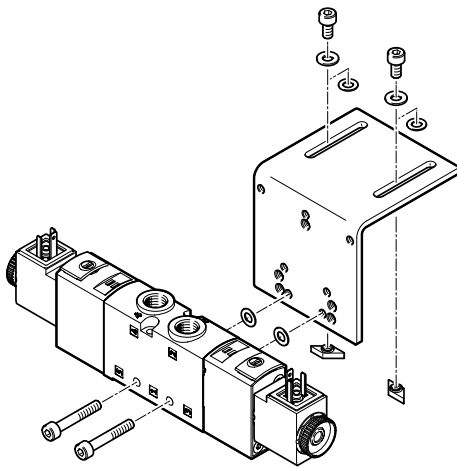

For mounting individual valves directly on a drive.

The solenoid valves are provided with two through-holes for attaching to the cylinder mounting DAVM-MW-V1...-V. Mounting is only possible on the side on which the pneumatic connections are located.

The relevant screw set is included when the cylinder mounting DAVM-MW-V1...-V is ordered.

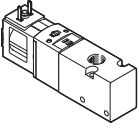
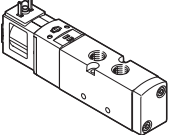
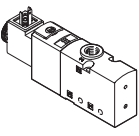
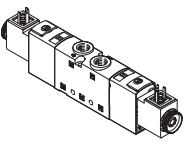
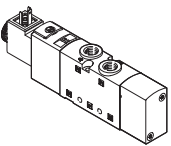

Product range overview

Valve	Size	Working port	Order code for valves and flow rate [l/min]										→ Page/ Internet	
			M32C	M32U	T32C	T32U	T32H	M52	B52	P53C	P53U	P53E		
<b>3/2-way valve VUVS-LK</b>														
	20	G1/8	■ 550	-	-	-	-	-	-	-	-	-	-	58
	25	G1/4	■ 1000	-	-	-	-	-	-	-	-	-	-	68
	30	G3/8	■ 1600	-	-	-	-	-	-	-	-	-	-	78
<b>5/2-way valve VUVS-LK</b>														
	20	G1/8	-	-	-	-	-	-	■ 550	■ 550	-	-	-	58
	25	G1/4	-	-	-	-	-	-	■ 1000	■ 1000	-	-	-	68
	30	G3/8	-	-	-	-	-	-	■ 1600	■ 1600	-	-	-	78
<b>3/2-way valve VUVS-LT</b>														
	20	G1/8	■ 600	■ 600	-	-	-	-	-	-	-	-	-	88
	25	G1/4	■ 1000	■ 1000	-	-	-	-	-	-	-	-	-	100
	30	G3/8	■ 1600	■ 1600	-	-	-	-	-	-	-	-	-	125
<b>2x 3/2-way valve VUVS-LT</b>														
	20	G1/8	-	-	■ 600	■ 600	■ 600	-	-	-	-	-	-	88
	25	G1/4	-	-	■ 1000	■ 1000	■ 1000	-	-	-	-	-	-	100
	30	G3/8	-	-	■ 1600	■ 1600	■ 1600	-	-	-	-	-	-	126
<b>5/2-way valve VUVS-LT</b>														
	20	G1/8	-	-	-	-	-	-	■ 500	■ 500	-	-	-	88
	25	G1/4	-	-	-	-	-	-	■ 1000	■ 1000	-	-	-	100
	30	G3/8	-	-	-	-	-	-	■ 1800	■ 1800	-	-	-	127

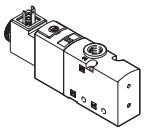
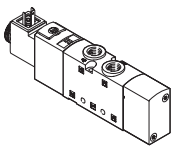
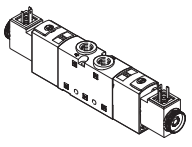
## Product range overview

Valve	Size	Working port	Order code for valves and flow rate [l/min]										→ Page/ Internet	
			M32C	M32U	T32C	T32U	T32H	M52	B52	P53C	P53U	P53E		
<b>3/2-way valve VUVS-L</b>														
	20	G1/8	■ 700	■ 700	-	-	-	-	-	-	-	-	-	132
	25	G1/4	■ 1000	■ 1000	-	-	-	-	-	-	-	-	-	147
	30	G3/8	■ 2300	■ 2300	-	-	-	-	-	-	-	-	-	165
<b>5/2-way valve VUVS-L</b>														
	20	G1/8	-	-	-	-	-	-	■ 700	■ 700	-	-	-	132
	25	G1/4	-	-	-	-	-	-	■ 1300	■ 1300	-	-	-	147
	30	G3/8	-	-	-	-	-	-	■ 2300	■ 2300	-	-	-	165
<b>5/3-way valve VUVS-L</b>														
	20	G1/8	-	-	-	-	-	-	-	-	■ 700	■ 600	■ 600	132
	25	G1/4	-	-	-	-	-	-	-	-	■ 1200	■ 1000	■ 1000	147
	30	G3/8	-	-	-	-	-	-	-	-	■ 2000	■ 1600	■ 1600	165

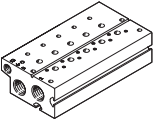
## Product range overview

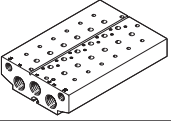
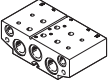
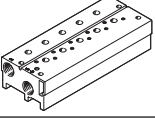
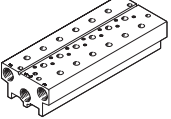
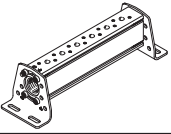
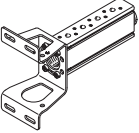
Design	Size	Description	→ Page/ Internet
<b>Manifold block for 3/2-way valves, standard</b>			
	20	VABM-B10-20E-G38- ... P3	Connection G3/8 183
	25	VABM-B10-25E-G12- ... P3	Connection G1/2 196
	30	VABM-B10-30E-G34- ... P3	Connection G3/4 209
<b>Manifold block extension module for 3/2-way valves, standard</b>			
	20	VABM-B10-20EEE-G38- ... P3	Connection G3/8 183
	25	VABM-B10-25EEE-G12- ... P3	Connection G1/2 196
	30	VABM-B10-30EEE-G34- ... P3	Connection G3/4 209
<b>Manifold block for 5/2- and 5/3-way valves, standard</b>			
	20	VABM-B10-20E-G38- ...	Connection G3/8 183
	25	VABM-B10-25E-G12- ...	Connection G1/2 196
	30	VABM-B10-30E-G34- ...	Connection G3/4 209
<b>Manifold block extension module for 5/2- and 5/3-way valves, standard</b>			
	20	VABM-B10-20EEE-G38- ...	Connection G3/8 183
	25	VABM-B10-25EEE-G12- ...	Connection G1/2 196
	30	VABM-B10-30EEE-G34- ...	Connection G3/4 209
<b>Manifold block for 3/2-way valves, compact</b>			
	20	VABM-B10-20S-G14- ... P3	Connection G1/4 183
	25	VABM-B10-25S-G38- ... P3	Connection G3/8 196
	30	VABM-B10-30S-G12- ... P3	Connection G1/2 209
<b>Manifold block for 5/2- and 5/3-way valves, compact</b>			
	20	VABM-B10-20S-G14- ...	Connection G1/4 183
	25	VABM-B10-25S-G38- ...	Connection G3/8 196
	30	VABM-B10-30S-G12- ...	Connection G1/2 209
<b>Common supply manifold, for mounting on both sides</b>			
	20	VABM-B10-20-G38- ... P53	Connection G3/8 183
	25	VABM-B10-25-G12- ... P53	Connection G1/2 196
	30	VABM-B10-30-G34- ... P53	Connection G3/4 209
<b>Common supply manifold, for mounting on one side</b>			
	20	VABM-B10-20-G38- ... P53-E	Connection G3/8 183
	25	VABM-B10-25-G12- ... P53-E	Connection G1/2 196
	30	VABM-B10-30-G34- ... P53-E	Connection G3/4 209

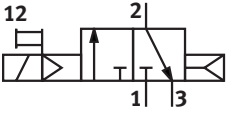
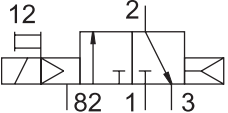
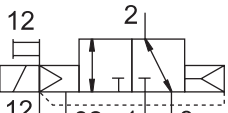
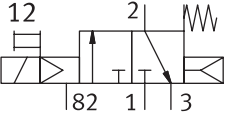
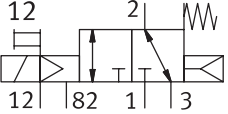
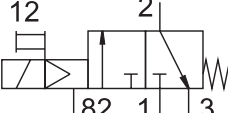
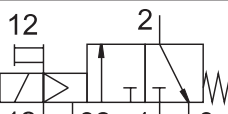
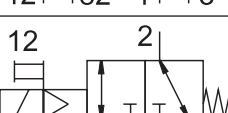

Overview of valve functions

Valve	Order code for valves	Description	VUVS-LK			VUVS-LT			VUVS-L		
			Size			Size			Size		
			20	25	30	20	25	30	20	25	30
<b>3/2-way valve, normally closed, pneumatic spring</b>											
	M32CA	Internal pilot air supply, not reversible	■	■	■	-	-	-	-	-	-
		Internal pilot air supply, not reversible	-	-	-	-	-	-	■	■	■
		External pilot air supply, reversible	-	-	-	-	-	-	■	■	■
<b>3/2-way valve, normally closed, pneumatic/mechanical spring</b>											
	M32C-M	<ul style="list-style-type: none"> <li>Internal pilot air supply, not reversible</li> <li>Reset via: mechanical spring, supported internally by pneumatic spring</li> </ul>	-	-	-	-	-	-	■	-	-
		<ul style="list-style-type: none"> <li>External pilot air supply, reversible</li> <li>Reset via: mechanical spring, supported internally by pneumatic spring</li> </ul>	-	-	-	-	-	-	■	-	-
<b>3/2-way valve, normally closed, mechanical spring</b>											
	M32C-M	Internal pilot air supply, not reversible	-	-	-	■	■	■	-	■	■
		External pilot air supply, not reversible	-	-	-	■	■	■	-	-	-
		External pilot air supply, reversible	-	-	-	-	-	-	-	■	■



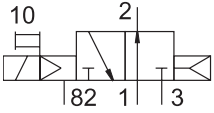
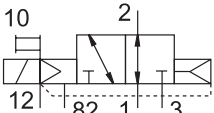
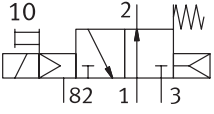
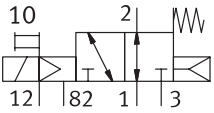
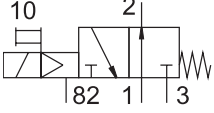
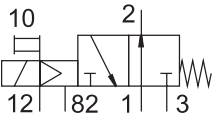
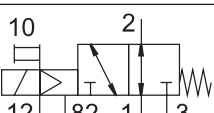



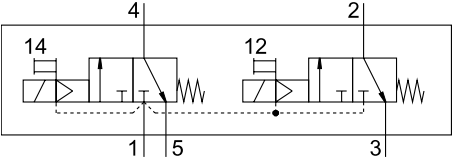
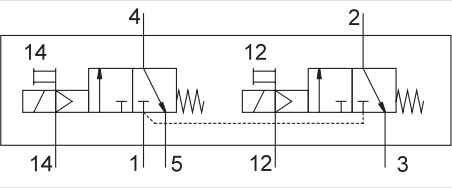
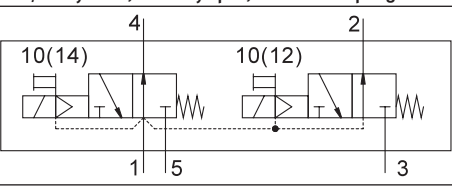
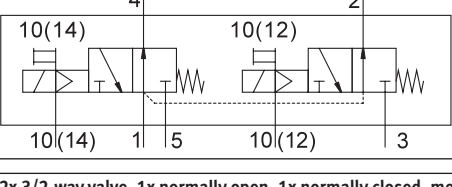
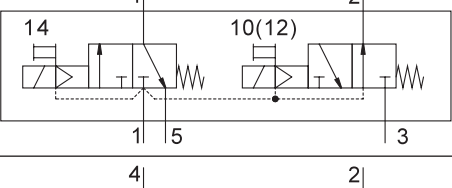
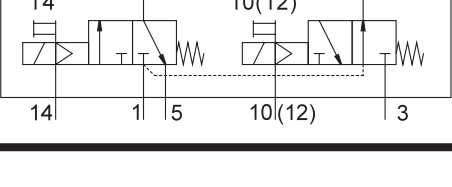

Overview of valve functions

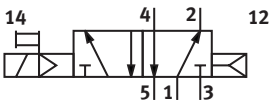
Valve	Order code for valves	Description	VUVS-LK			VUVS-LT			VUVS-L		
			Size			Size			Size		
			20	25	30	20	25	30	20	25	30
<b>3/2-way valve, normally open, pneumatic spring</b>											
	M32U-A	Internal pilot air supply, not reversible	-	-	-	-	-	-	■	■	■
		External pilot air supply, reversible	-	-	-	-	-	-	■	■	■
<b>3/2-way valve, normally open, pneumatic/mechanical spring</b>											
	M32U-M	<ul style="list-style-type: none"> <li>External pilot air supply, reversible</li> <li>Reset via: mechanical spring, supported internally by pneumatic spring</li> </ul>	-	-	-	-	-	-	■	-	-
		<ul style="list-style-type: none"> <li>External pilot air supply, reversible</li> <li>Reset via: mechanical spring, supported internally by pneumatic spring</li> </ul>	-	-	-	-	-	-	■	-	-
<b>3/2-way valve, normally open, mechanical spring</b>											
	M32U-M	Internal pilot air supply, not reversible	-	-	-	■	■	■	-	■	■
		External pilot air supply, not reversible	-	-	-	■	■	■	-	-	-
		External pilot air supply, reversible	-	-	-	-	-	-	-	■	■

Overview of valve functions

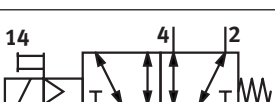
Valve	Order code for valves	Description	VUVS-LK			VUVS-LT			VUVS-L		
			Size			Size			Size		
			20	25	30	20	25	30	20	25	30
	T32C	Internal pilot air supply, not reversible	-	-	-	■	■	■	-	-	-
	T32C	External pilot air supply, not reversible	-	-	-	■	■	■	-	-	-
<b>2x 3/2-way valve, normally open, mechanical spring</b>											
	T32U	Internal pilot air supply, not reversible	-	-	-	■	■	■	-	-	-
	T32U	External pilot air supply, not reversible	-	-	-	■	■	■	-	-	-
<b>2x 3/2-way valve, 1x normally open, 1x normally closed, mechanical spring</b>											
	T32H	Internal pilot air supply, not reversible	-	-	-	■	■	■	-	-	-
	T32H	External pilot air supply, not reversible	-	-	-	■	■	■	-	-	-

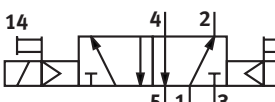
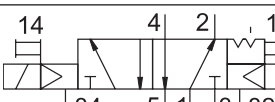
Overview of valve functions

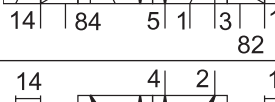
Valve	Order code for valves	Description	VUVS-LK			VUVS-LT			VUVS-L		
			Size			Size			Size		
			20	25	30	20	25	30	20	25	30
	M52	Internal pilot air supply, not reversible	■	■	■	-	-	-	-	-	-
		Internal pilot air supply, not reversible	-	-	-	-	-	-	■	■	■
		External pilot air supply, reversible	-	-	-	-	-	-	■	■	■
<b>5/2-way single solenoid valve, mechanical spring</b>											
	M52	Internal pilot air supply, not reversible	-	-	-	■	■	■	■	■	■
		External pilot air supply, reversible	-	-	-	-	-	-	■	■	■
		External pilot air supply, not reversible	-	-	-	■	■	■	-	-	-
<b>5/2-way double solenoid valve</b>											
	B52	Internal pilot air supply, not reversible	■	■	■	-	-	-	-	-	-
		<ul style="list-style-type: none"> <li>Internal pilot air supply, not reversible</li> <li>Holding the switching position: via latch</li> </ul>	-	-	-	-	■	-	-	-	-
		Internal pilot air supply, not reversible	-	-	-	■	-	■	■	■	■
		<ul style="list-style-type: none"> <li>External pilot air supply, not reversible</li> <li>Holding the switching position: via latch</li> </ul>	-	-	-	■	■	■	-	-	-
		External pilot air supply, reversible	-	-	-	-	-	-	■	■	■

## Overview of valve functions

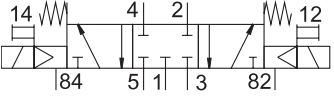
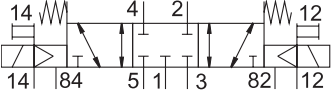
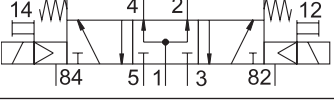
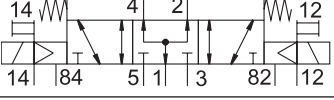
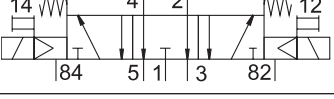
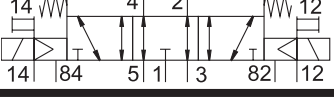
Valve	Order code for valves	Description	VUVS-L		
			Size		
			20	25	30
<b>5/3-way valve, mechanical spring, closed</b>					
	P53C	Internal pilot air supply, not reversible	■	■	■
		External pilot air supply, reversible	■	■	■
<b>5/3-way valve, mechanical spring, pressurised</b>					
	P53U	Internal pilot air supply, not reversible	■	■	■
		External pilot air supply, reversible	■	■	■
<b>5/3-way valve, mechanical spring, exhausted</b>					
	P53E	Internal pilot air supply, not reversible	■	■	■
		External pilot air supply, reversible	■	■	■

## Peripherals overview VUVS-LK

### Manifold block for 3/2-way valves

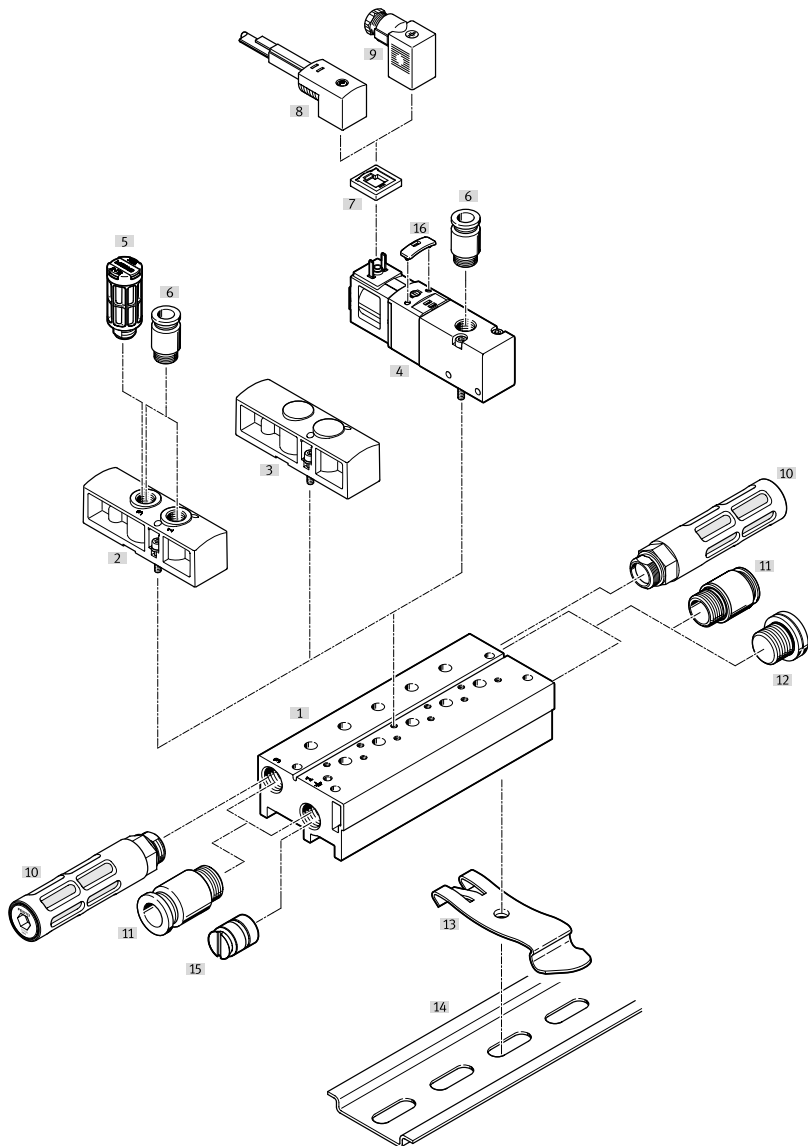

## Peripherals overview VUVS-LK

Designation	Description	→ Page/Internet
[1] Compact manifold block	For 3/2-way valves, no port for external pilot air supply	191
[2] Supply plate	For additional air supply and exhaust via a valve position	193
[3] Cover plate	For covering unused valve positions	193
[4] Solenoid valve	3/2-way valve, with solenoid coil	57
[5] Silencer	For port 3, exhaust	195
[6] Push-in fitting	For ports 1 and 3, supply and exhaust ports with supply plate, for port 2, working port, on the valve	194
[7] Illuminating seal	For indicating the switching status	66
[8] Plug socket with cable	For solenoid valves VUVS	66
[9] Plug socket	For solenoid valves VUVS	66
[10] Silencer	For port 3, exhaust	195
[11] Push-in fitting	For ports 1 and 3, supply and exhaust ports	194
[12] Blanking plug	For ports 1 and 3, supply and exhaust ports	195
[13] H-rail mounting	For H-rail mounting	195
[14] H-rail	–	–
[15] Separator	For creating pressure zones in ports 1 and 3	195
[16] Cover cap	For manual override, non-detenting or covered	76

## Peripherals overview VUVS-LK

### Manifold block for 5/2-way valves

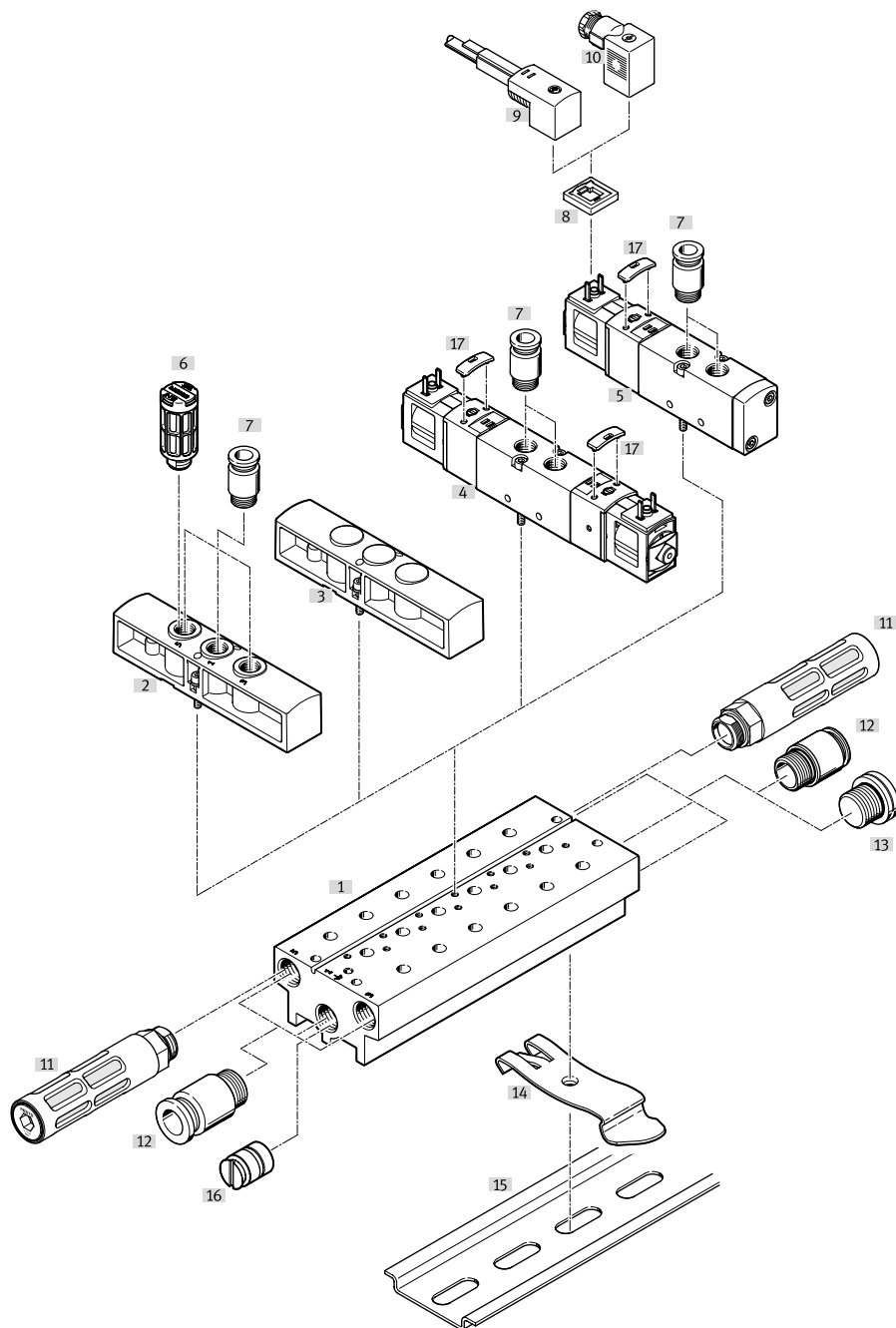

Designation	Description	→ Page/Internet
[1] Compact manifold block	For 5/2-way valves, no port for external pilot air supply	191
[2] Supply plate	For additional air supply and exhaust via a valve position	193
[3] Cover plate	For covering unused valve positions	193
[4] Solenoid valve	5/2-way double solenoid valve, with solenoid coil	57
[5] Solenoid valve	5/2-way single solenoid valve, with solenoid coil	57
[6] Silencer	For ports 3 and 5, exhaust	195
[7] Push-in fitting	For ports 1, 3 and 5, supply and exhaust ports with supply plate, for ports 2 and 4, working port, on the valve	194
[8] Illuminating seal	For indicating the switching status	66



## Peripherals overview VUVS-LK

Designation	Description	→ Page/Internet
[9] Plug socket with cable	For solenoid valves VUVS	66
[10] Plug socket	For solenoid valves VUVS	66
[11] Silencer	For ports 3 and 5, exhaust	195
[12] Push-in fitting	For ports 1, 3 and 5, supply and exhaust ports	194
[13] Blanking plug	For ports 1, 3 and 5, supply and exhaust ports	195
[14] H-rail mounting	For H-rail mounting	195
[15] H-rail	–	–
[16] Separator	For creating pressure zones in ports 1, 3 and 5	195
[17] Cover cap	For manual override, non-detenting or covered	76

## Peripherals overview VUVS-LK

### Common supply manifold for mounting on both sides

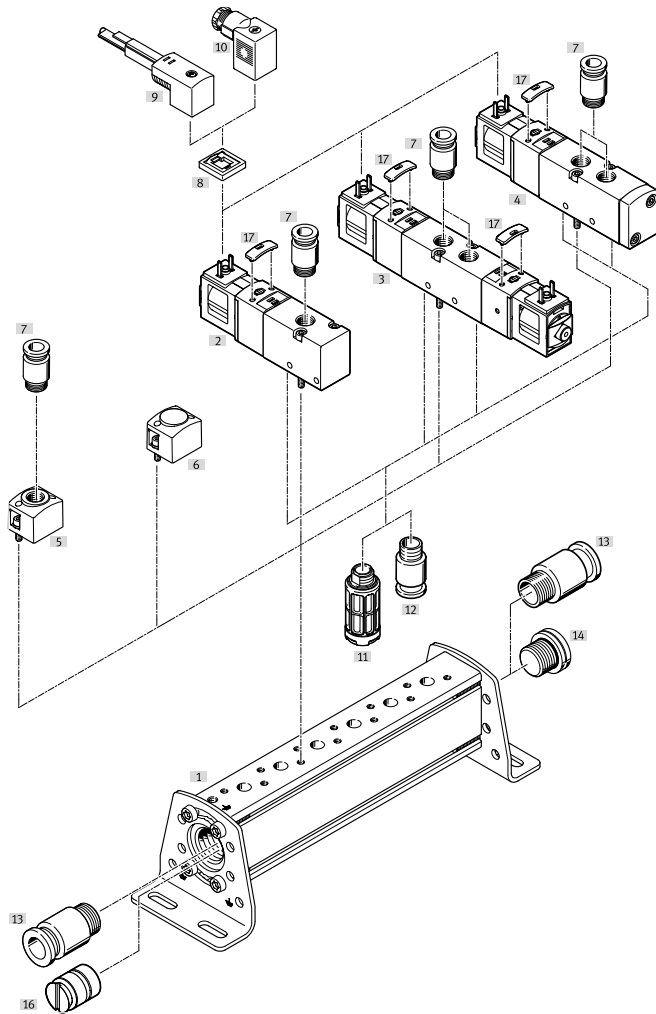

Designation	Description	→ Page/Internet
[1] Common supply manifold	–	192
[2] Solenoid valve	3/2-way valve, with solenoid coil	57
[3] Solenoid valve	5/3-way valve and 5/2-way double solenoid valve, with solenoid coil 2x 3/2-way valve, with solenoid coil	57
[4] Solenoid valve	5/2-way single solenoid valve, with solenoid coil	57
[5] Supply plate	For additional air supply via a valve position	193
[6] Cover plate	For covering unused valve positions	193
[7] Push-in fitting	For port 1, working port	194
[8] Illuminating seal	For indicating the switching status	66
[9] Plug socket with cable	For solenoid valves VUVS	66
[10] Plug socket	For solenoid valves VUVS	66
[11] Silencer	For ports 3 and 5, exhaust, on the valve	195
[12] Push-in fitting	For ports 3 and 5, exhaust, on the valve	194
[13] Push-in fitting	For port 1, supply port	194
[14] Blanking plug	For port 1, supply port	195
[16] Separator	For creating pressure zones	195
[17] Cover cap	For manual override, non-detenting or covered	76

## Peripherals overview VUVS-LK

## Common supply manifold for mounting on one side

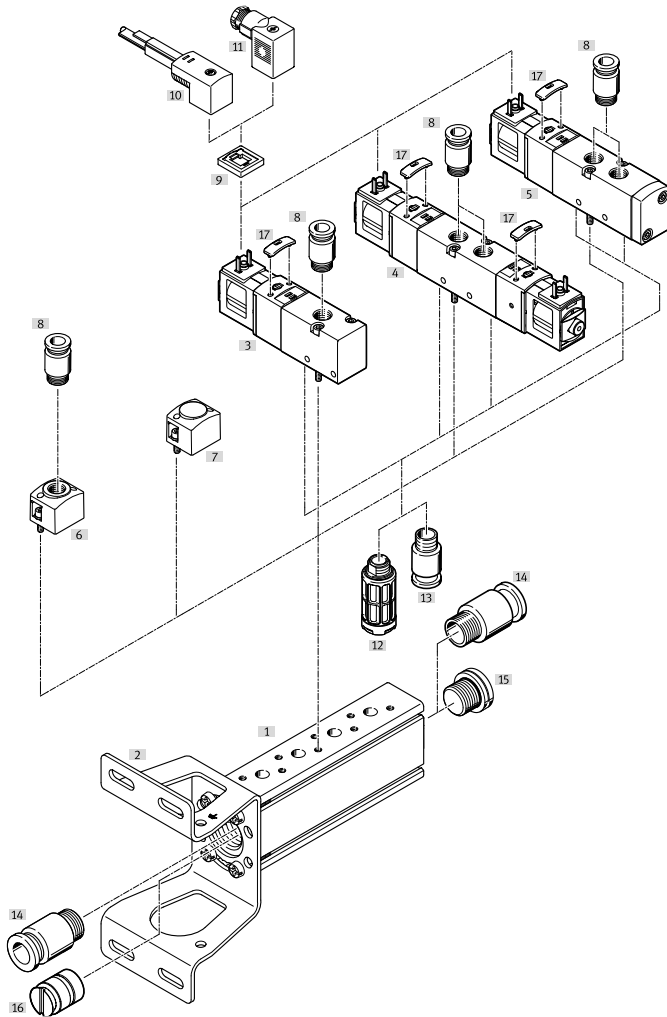

Designation	Description	→ Page/Internet
[1] Common supply manifold	–	192
[2] Mounting bracket	–	–
[3] Solenoid valve	3/2-way valve, with solenoid coil	65
[4] Solenoid valve	5/2-way double solenoid valve, with solenoid coil	57
[5] Solenoid valve	5/2-way single solenoid valve, with solenoid coil	57
[6] Supply plate	For additional air supply via a valve position	193
[7] Cover plate	For covering unused valve positions	193
[8] Push-in fitting	For port 1, supply port For ports 2 and 4, working port	194
[9] Illuminating seal	For indicating the switching status	66
[10] Plug socket with cable	For solenoid valves VUVS	66
[11] Plug socket	For solenoid valves VUVS	66
[12] Silencer	For ports 3 and 5, exhaust, on the valve	195
[13] Push-in fitting	For ports 3 and 5, on the valve	194
[14] Push-in fitting	For port 1, supply port	194
[15] Blanking plug	For port 1, supply port	195
[16] Separator	For creating pressure zones	195
[17] Cover cap	For manual override, non-detenting or covered	76

Peripherals overview VUVS-LT, VUVS-L

Manifold block for 3/2-way valves

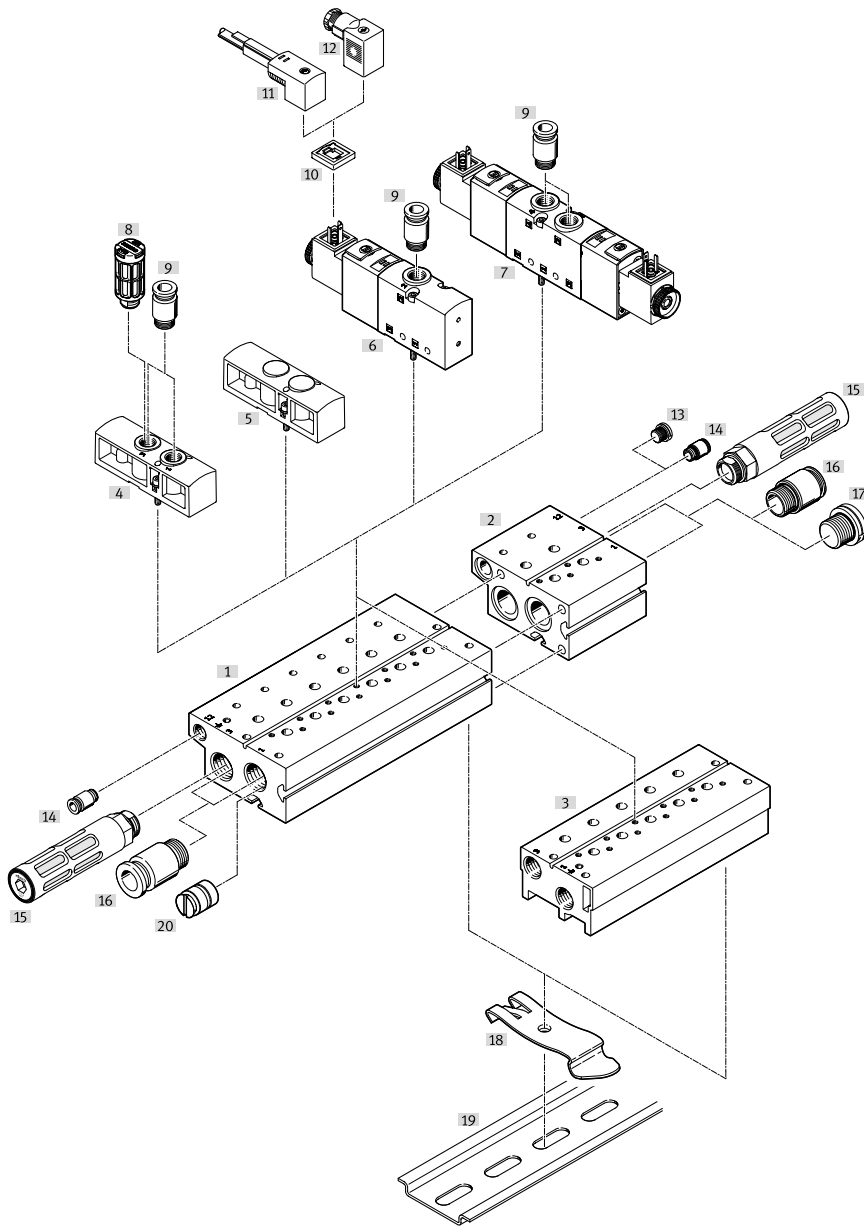

Designation	Description	→ Page/Internet
[1] Standard manifold block	For 3/2-way valves, with port 10/12 for external pilot air supply	191
[2] Extension module	For standard manifold block, with port 10/12 for external pilot air supply	191
[3] Compact manifold block	For 3/2-way valves, no port for external pilot air supply	191
[4] Supply plate	For additional air supply and exhaust via a valve position	193
[5] Cover plate	For covering unused valve positions	193
[6] Solenoid valve	3/2-way valve, with solenoid coil	57
[7] Solenoid valve	2x 3/2-way valve, with solenoid coil	57
[8] Silencer	For port 3, exhaust	195
[9] Push-in fitting	For ports 1 and 3, supply and exhaust ports with supply plate, for port 2, working port, on the valve	194
[10] Illuminating seal	For indicating the switching status	144
[11] Plug socket with cable	For solenoid valves VUVS	144
[12] Plug socket	For solenoid valves VUVS	144
[13] Blanking plug	For port 10/12, external pilot air supply, for standard manifold block only	195
[14] Push-in fitting	For port 10/12, external pilot air supply, for standard manifold block only	194

## Peripherals overview VUVS-LT, VUVS-L

Designation	Description	→ Page/Internet
[15] Silencer	For port 3, exhaust	195
[16] Push-in fitting	For ports 1 and 3, supply and exhaust ports	194
[17] Blanking plug	For ports 1 and 3, supply and exhaust ports	195
[18] H-rail mounting	For H-rail mounting	195
[19] H-rail	–	–
[20] Separator	For creating pressure zones in ports 1 and 3	195

Peripherals overview VUVS-LT, VUVS-L

Manifold block for 5/2 and 5/3-way valves

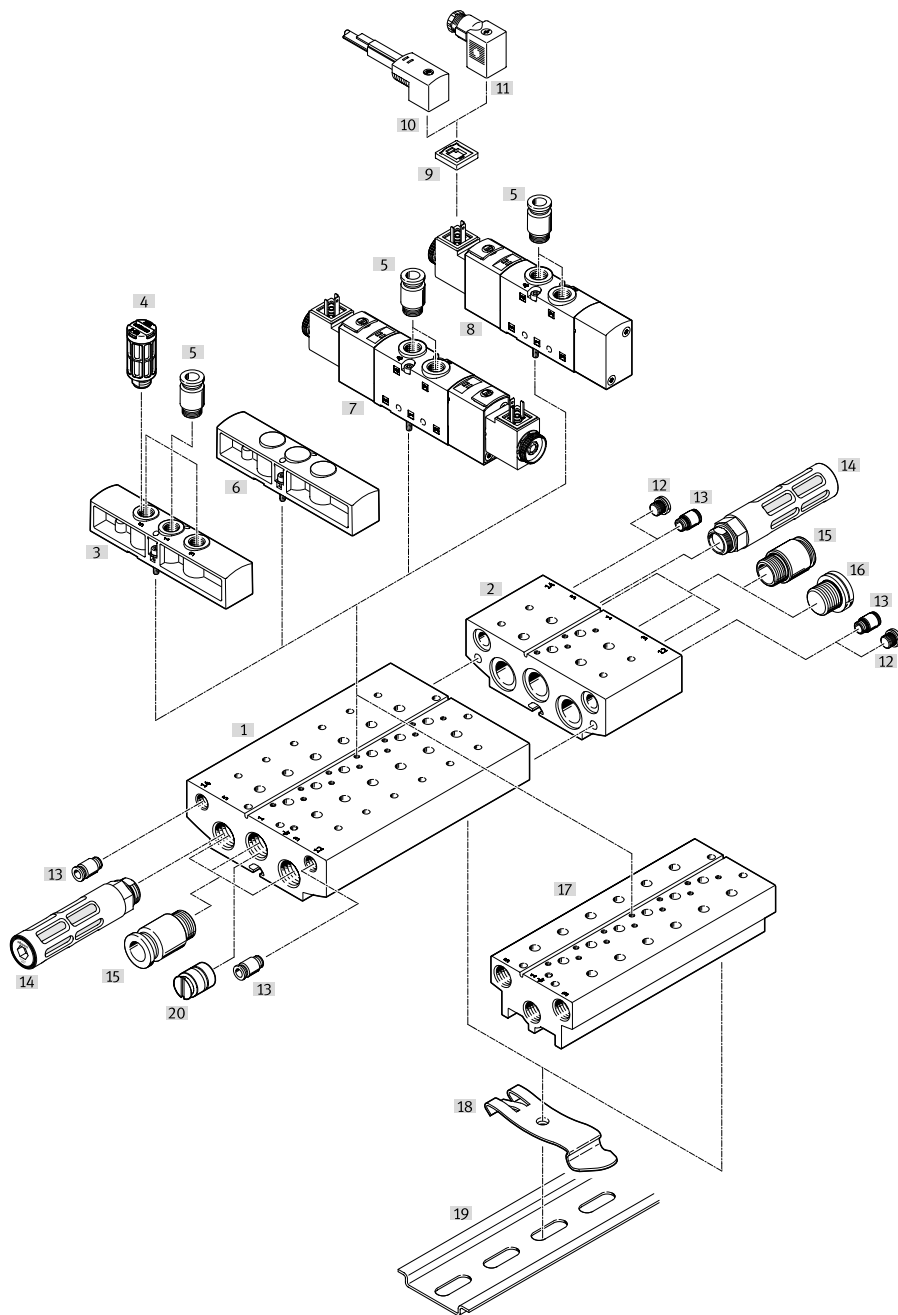

Designation	Description	→ Page/Internet
[1] Standard manifold block	For 5/2- and 5/3-way valves, with ports 12 and 14 for external pilot air supply	191
[2] Extension module	For standard manifold block, with ports 12 and 14 for external pilot air supply	191
[3] Supply plate	For additional air supply and exhaust via a valve position	193
[4] Silencer	For ports 3 and 5, exhaust	195
[5] Push-in fitting	For ports 1, 3 and 5, supply and exhaust ports with supply plate, for ports 2 and 4, working port, on the valve	194
[6] Cover plate	For covering unused valve positions	193
[7] Solenoid valve	5/3-way valve and 5/2-way double solenoid valve, with solenoid coil	57
[8] Solenoid valve	5/2-way single solenoid valve, with solenoid coil	57
[9] Illuminating seal	For indicating the switching status	144
[10] Plug socket with cable	For solenoid valves VUVS	144
[11] Plug socket	For solenoid valves VUVS	144
[12] Blanking plug	For ports 12 and 14, external pilot air supply, for standard manifold block only	195

## Peripherals overview VUVS-LT, VUVS-L

Designation	Description	→ Page/Internet
[13] Push-in fitting	For ports 12 and 14, external pilot air supply, for standard manifold block only	194
[14] Silencer	For ports 3 and 5, exhaust	195
[15] Push-in fitting	For ports 1, 3 and 5, supply and exhaust ports	194
[16] Blanking plug	For ports 1, 3 and 5, supply and exhaust ports	195
[17] Compact manifold block	For 5/2- and 5/3-way valves, no port for external pilot air supply	191
[18] H-rail mounting	For H-rail mounting	195
[19] H-rail	–	–
[20] Separator	For creating pressure zones in ports 1, 3 and 5	195

Peripherals overview VUVS-LT, VUVS-L

Common supply manifold for mounting on both sides

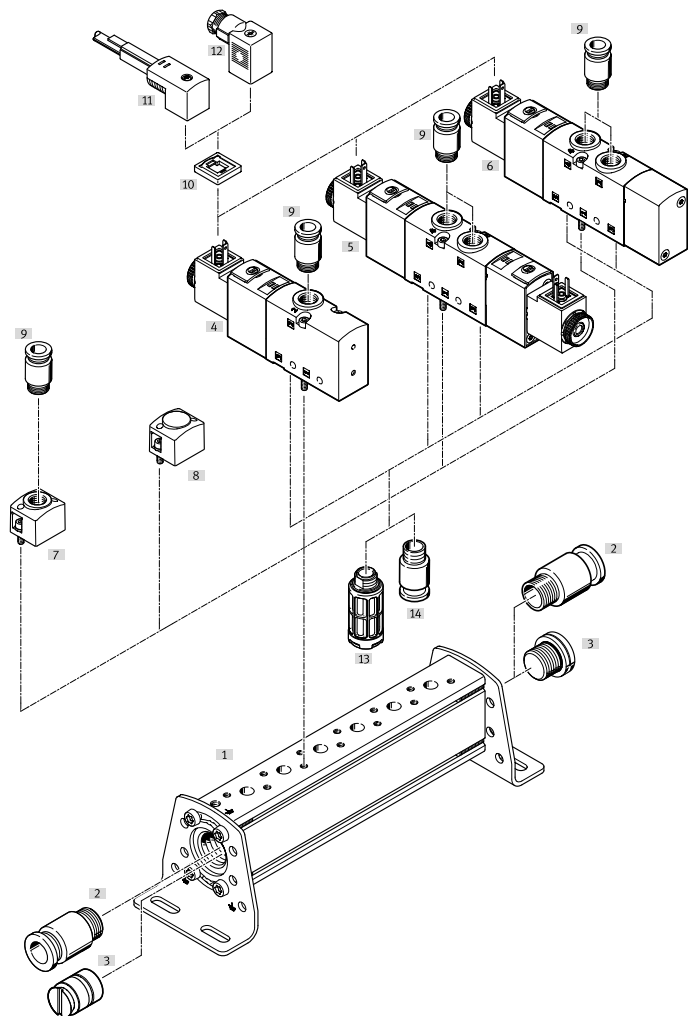

Designation	Description	→ Page/Internet
[1] Common supply manifold	–	192
[2] Push-in fitting	For port 1, supply port	194
[3] Separator	For creating pressure zones	
[4] Solenoid valve	3/2-way valve, with solenoid coil	57
[5] Solenoid valve	5/3-way valve and 5/2-way double solenoid valve, with solenoid coil 2x 3/2-way valve, with solenoid coil	57
[6] Solenoid valve	5/2-way single solenoid valve, with solenoid coil	57
[7] Supply plate	For additional air supply via a valve position	193
[8] Cover plate	For covering unused valve positions	193
[9] Push-in fitting	For port 1 For ports 2, 4, working port	194
[10] Illuminating seal	For indicating the switching status	144
[11] Plug socket with cable	For solenoid valves VUVS	144
[12] Plug socket	For solenoid valves VUVS	144
[13] Silencer	For ports 3 and 5, exhaust, on the valve	195
[14] Push-in fitting	For ports 3 and 5, exhaust, on the valve	194



## Peripherals overview VUVS-LT, VUVS-L

## Common supply manifold for mounting on one side

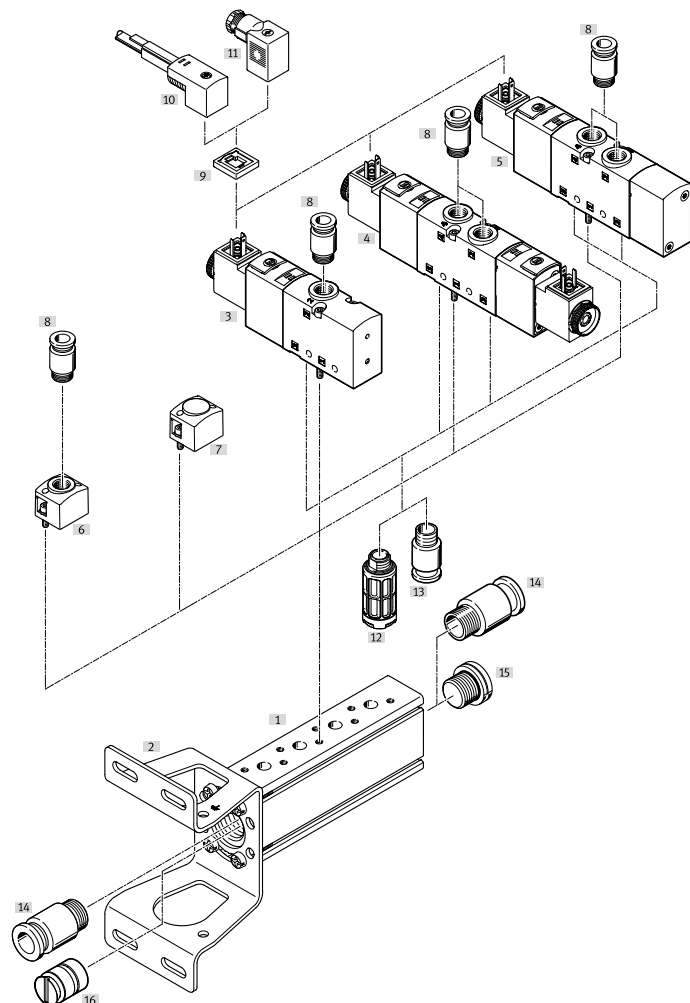

Designation	Description	→ Page/Internet
[1] Common supply manifold	–	192
[2] Mounting bracket	–	–
[3] Solenoid valve	3/2-way valve, with solenoid coil	57
[4] Solenoid valve	5/3-way valve and 5/2-way double solenoid valve, with solenoid coil 2x 3/2-way valve, with solenoid coil	57
[5] Solenoid valve	5/2-way single solenoid valve, with solenoid coil	57
[6] Supply plate	For additional air supply via a valve position	193
[7] Cover plate	For covering unused valve positions	193
[8] Push-in fitting	For port 1, supply port For ports 2 and 4, working port	194
[9] Illuminating seal	For indicating the switching status	144
[10] Plug socket with cable	For solenoid valves VUVS	144
[11] Plug socket	For solenoid valves VUVS	144
[12] Silencer	For ports 3 and 5, exhaust, on the valve	195
[13] Push-in fitting	For ports 3 and 5, on the valve	194
[14] Push-in fitting	For port 1, supply port	194
[15] Blanking plug	For port 1, supply port	195
[16] Separator	For creating pressure zones	195

Technical data – Valve manifold assembly

-  Flow rate
- Size 20:  
up to 700 l/min
- Size 25:  
up to 1300 l/min
- Size 30  
up to 2300 l/min

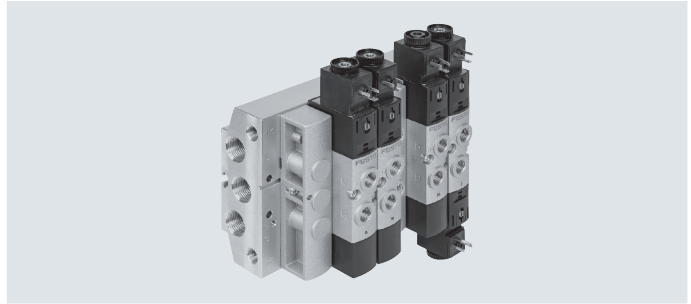

General technical data		20	25	30
Size		20	25	30
Valve manifold design		Fixed grid		
Valve width	[mm]	21	26.5	31
Valve design	VUVS-L	Piston spool with sealing cartridge		
	VUVS-LT	Poppet seat		
	VUVS-LK	Piston spool with sealing ring		
Electrical control		Individual connection		
Reset method for valves	VUVS-L	Pneumatic or mechanical spring		
	VUVS-LT	Mechanical spring		
	VUVS-LK	Pneumatic spring		
Pilot air supply		Internal or external		
Flow direction	VUVS-L	Reversible with limitations		
	VUVS-LT	Non-reversible		
	VUVS-LK	Non-reversible		
Suitable for vacuum	VUVS-L	Yes, with external pilot air supply		No
	VUVS-LT	Yes, with external pilot air supply (not for valves M52/B52)		
	VUVS-LK	No		
Overlap	VUVS-L	Positive overlap		
	VUVS-LT	Negative overlap		
	VUVS-LK	Positive overlap		
Sealing principle		Soft		
Max. no. of valve positions		16 (a maximum of 18 valve positions with extension for standard manifold block)		
Max. number of pressure zones		9		
Exhaust air function		Can be throttled		
Actuation type		Electric		
Nominal operating voltage	[V DC]	12, 24		
	[V AC]	24, 110, 120, 230, 240		
Standard nominal flow rate qnN	[l/min]	500 ... 700	1000 ... 1300	1600 ... 2300
Pilot air connection	Standard manifold block	12/14	G1/8	G1/8
	Compact manifold block	12/14	On the valve	On the valve
	Common supply manifold	12/14	On the valve	On the valve
Pilot exhaust air port	82/84	M5		
Mounting position		Any		
Degree of protection		IP65, IP67		
		With plug socket, to IEC 60529		
Permissible voltage fluctuations	[%]	± 10		

## Technical data – Valve manifold assembly

Materials		
Seals	VUVS-L	HNBR, NBR
	VUVS-LT	HNBR, NBR, TPE-U(PU)
	VUVS-LK	HNBR, NBR
Note on materials	RoHS-compliant	

ATEX	
ATEX category for gas	II 3G
Type of ignition protection for gas	Ex ec IIC T4 Gc X
ATEX category for dust	II 3D
Type of ignition protection for dust	Ex tc IIIC T115°C Dc X
Explosion-proof ambient temperature [°C]	-10 ≤ Ta ≤ +50
CE marking (see declaration of conformity) <sup>1)</sup>	To EU Explosion Protection Directive (ATEX)
UKCA marking (see declaration of conformity) <sup>1)</sup>	To UK EX instructions
Explosion protection certification outside the EU	EPL Dc (GB)
	EPL Gc (GB)

- 1) For information about the area of use, see the EC declaration of conformity at: [www.festo.com/catalogue/...](http://www.festo.com/catalogue/...) → Support/Downloads.  
If the devices are subject to usage restrictions in residential, commercial or light-industrial environments, further measures for the reduction of the emitted interference may be necessary.

Operating and environmental conditions		
Valve design	Piston spool	Poppet seat
Operating medium	Compressed air to ISO 8573-1:2010 [7:4:4]	
Pilot medium	Compressed air to ISO 8573-1:2010 [7:4:4]	
Note on operating/pilot medium	Lubricated operation possible (in which case lubricated operation will always be required)	
Operating pressure [MPa]	-0.09 ... +1	-0.09 ... +1 (M32, T32) +0.15 ... +1 (B52) +0.25 ... +1 (M52)
	[bar]	-0.9 ... +10 (M32, T32) +1.5 ... +10 (B52) +2.5 ... +10 (M52)
With internal pilot air [MPa]	+0.15 ... +1 +0.25 ... +1 (M32...-A, M32...-M, M52-A)	+0.15 ... +1 (B52) +0.25 ... +1 (M52, M32, T32)
	[bar]	+1.5 ... +10 (B52) +2.5 ... +10 (M52, M32, T32)
Pilot pressure [MPa]	+0.15 ...+1 (B52) +0.25 ...+1	+0.15 ...+1 (B52) +0.25 ...+1 (M52, M32, T32)
	[bar]	+1.5 ...+10 (B52) +2.5 ...+10 (M52, M32, T32)
Ambient temperature [°C]	-10 ... +60	-5 ... +60 (M32, T32) -10 ... +60 (B52, M52)
	Temperature of medium [°C]	-5 ... +60 (M32, T32) -10 ... +60 (B52, M52)
Certification	c UL us - Recognized (OL)	
Corrosion resistance class CRC <sup>1)</sup>	2	

- 1) Corrosion resistance class CRC 2 to Festo standard FN 940070  
Moderate corrosion stress. Indoor applications in which condensation can occur. External visible parts with primarily decorative surface requirements which are in direct contact with a normal industrial environment.

Technical data – Valve manifold assembly

Dimensions – Valve manifold assembly

Download CAD data → [www.festo.com](http://www.festo.com)

With 3/2-way valves, standard manifold block

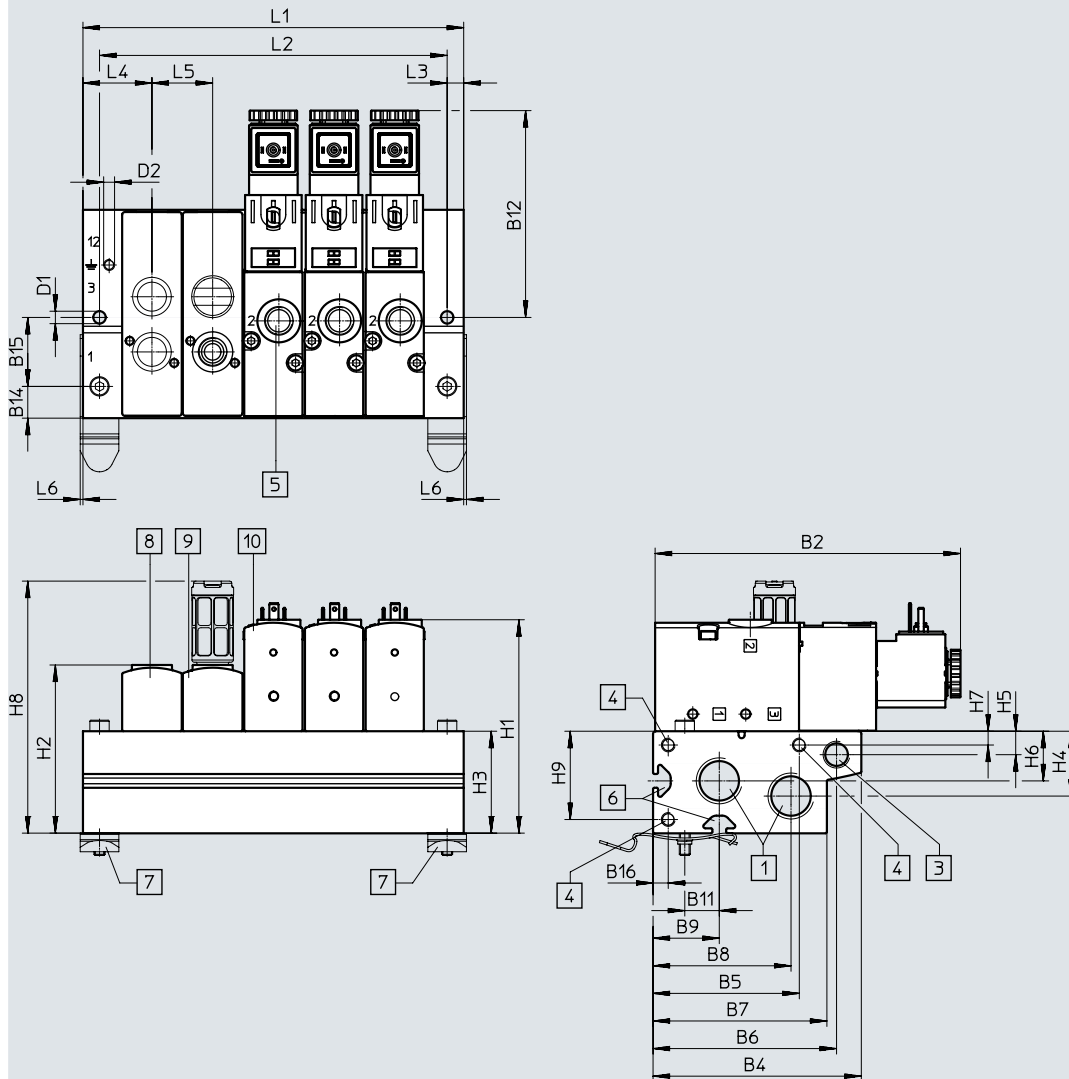

- |   |   |   |   |
|---|---|---|---|
| <p>[1] Port 1 and 3<br/>(on both sides):<br/>G3/8 for VTUS-20<br/>G1/2 for VTUS-25<br/>G3/4 for VTUS-30</p> | <p>[4] Thread for extension module:<br/>M5x15.5 for VTUS-20<br/>M5x18 for VTUS-25 and<br/>VTUS-30</p> | <p>[6] Profile slot IPM-05 system 5 for<br/>VTUS-20 and VTUS-25, profile<br/>slot IPM-08 system 8 for<br/>VTUS-30</p> <p>[7] H-rail mounting VAME-T-M4 for<br/>VTUS-20<br/>VAME-T-M5 for VTUS-25<br/>VAME-T-M6 for VTUS-30</p> <p>[8] Cover plate</p> | <p>[9] Supply plate,<br/>port 1 and 3:<br/>G1/8 for VTUS-20<br/>G1/4 for VTUS-25<br/>G3/8 for VTUS-30</p> <p>[10] 3/2-way valve</p> |
| <p>[3] Port 12 (on both sides): G1/8<br/>for VTUS-20, VTUS-25 and<br/>VTUS-30</p>                           | <p>[5] Port 2:<br/>G1/8 for VTUS-20<br/>G1/4 for VTUS-25<br/>G3/8 for VTUS-30</p>                     |   |   |

## Technical data – Valve manifold assembly

Type	B2	B4	B5	B6	B7	B8	B9	B11	B12	B14	B15	B16
VTUS-20	110.7	75.5	53	66.5	63	50	24	12.5	75	11.5	25	5.5
VTUS-25	129.2	93	67.5	80.5	78	62	30	16	84.2	14	32	6
VTUS-30	144.9	108.2	79	93.2	94.7	75.7	36.2	19	91.2	17.2	38	6.5

Type	D1 ø	D2	H1	H2	H3	H4	H5	H6	H7	H8	H9	L3	L4	L5	L6
VTUS-20	4.5	M4x6.5	77.4	61	37	23.5	8.5	18	5	91.4	32	6	25	22	1
VTUS-25	4.5	M4x9	95.5	71	45	25	9	22	5	123.4	39	6	29.8	27.5	1
VTUS-30	4.5	M5x11	118	91	61	35	9	28.5	6.5	170.1	54.5	7.5	34	32	–

Type	Valve positions	2	3	4	5	6	7	8	9	10
VTUS-20	L1	72	94	116	138	160	182	204	226	248
	L2	60	82	104	126	148	170	192	214	236
VTUS-25	L1	87	114.5	142	169.5	197	224.5	252	279.5	307
	L2	75	102.5	130	157.5	185	212.5	240	267.5	295
VTUS-30	L1	100	132	164	196	228	260	292	324	356
	L2	85	117	149	181	213	245	277	309	341

Technical data – Valve manifold assembly

Dimensions – Valve manifold assembly

Download CAD data → [www.festo.com](http://www.festo.com)

With 3/2-way valves, compact manifold block

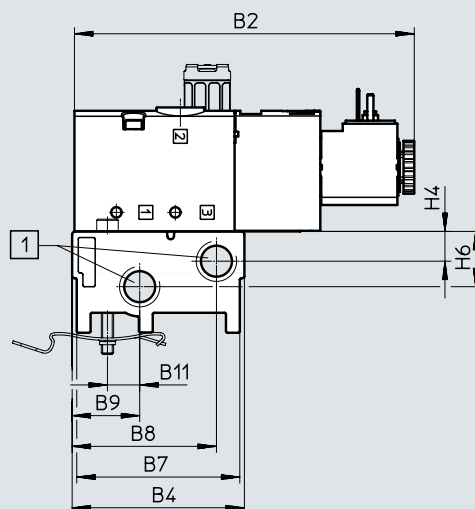
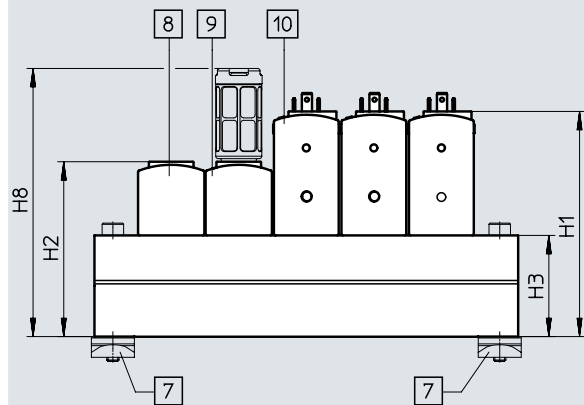
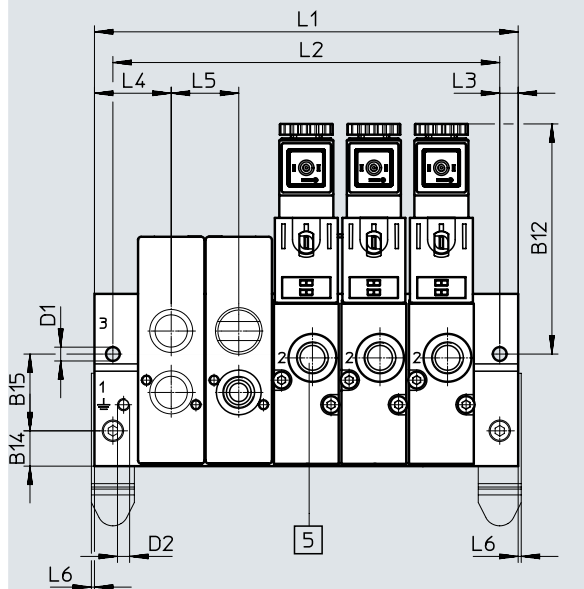

[1] Port 1 and 3  
(on both sides):  
G1/4 for VTUS-20  
G3/8 for VTUS-25  
G1/2 for VTUS-30

[5] Port 2:  
G1/8 for VTUS-20  
G1/4 for VTUS-25  
G3/8 for VTUS-30

[7] H-rail mounting VAME-T-M4 for  
VTUS-20  
VAME-T-M5 for VTUS-25  
VAME-T-M6 for VTUS-30  
[8] Cover plate

[9] Supply plate,  
port 1 and 3:  
G1/8 for VTUS-20  
G1/4 for VTUS-25  
G3/8 for VTUS-30  
[10] 3/2-way valve

## Technical data – Valve manifold assembly

Type	B2	B4	B7	B8	B9	B11	B12	B14	B15
VTUS-20	110.7	56.1	53.1	47	22	10.5	75	11.5	25
VTUS-25	129.2	70.3	67.3	58.8	30	16	84	14	32
VTUS-30	144.9	83	80	69.4	36	19	91.2	17	38

Type	D1 ø	D2	H1	H2	H3	H4	H6	H8	L3	L4	L5	L6
VTUS-20	4.5	M4x6.5	73.4	57	33	9.7	18	87.4	6	25	22	1
VTUS-25	5.5	M4x9	84.5	60	34	13.5	20	112.4	6	29.8	27.5	1
VTUS-30	6.3	M5x11	99.5	72.5	42.5	17.5	26	151.6	7.5	34	32	–

Type	Valve positions	2	3	4	5	6	7	8	9	10
VTUS-20	L1	72	94	116	138	160	182	204	226	248
	L2	60	82	104	126	148	170	192	214	236
VTUS-25	L1	87	114.5	142	169.5	197	224.5	252	279.5	307
	L2	75	102.5	130	157.5	185	212.5	240	267.5	295
VTUS-30	L1	100	132	164	196	228	260	292	324	356
	L2	85	117	149	181	213	245	277	309	341

Technical data – Valve manifold assembly

Dimensions – Valve manifold assembly

Download CAD data → [www.festo.com](http://www.festo.com)

With 5/2-, 5/3-, and 2x 3/2-way valves, standard manifold block

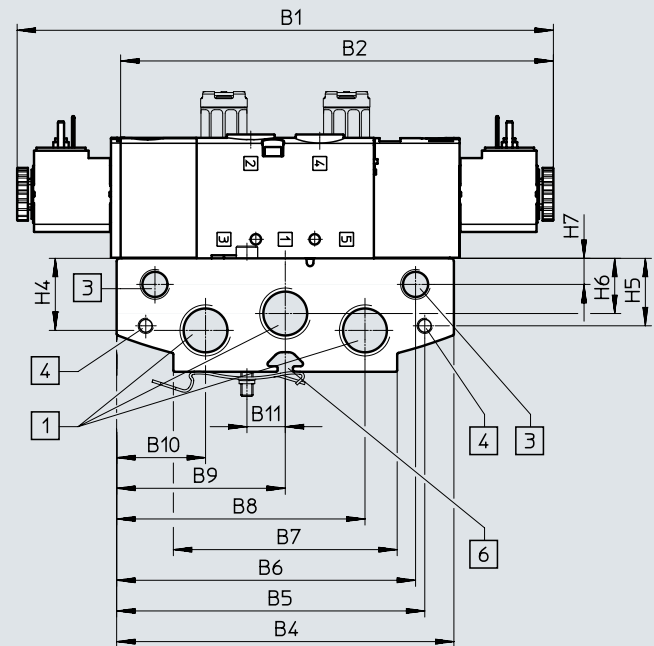
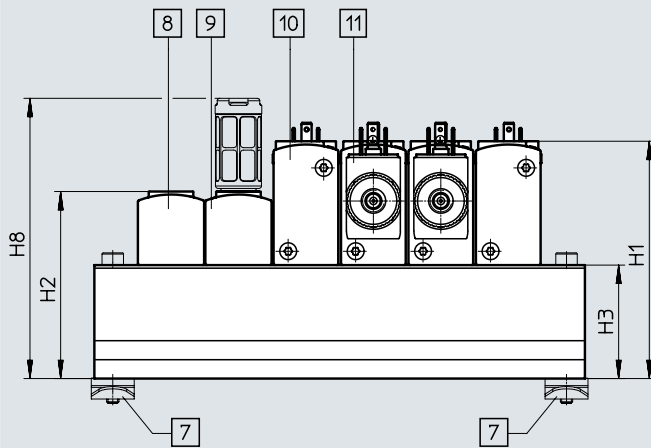
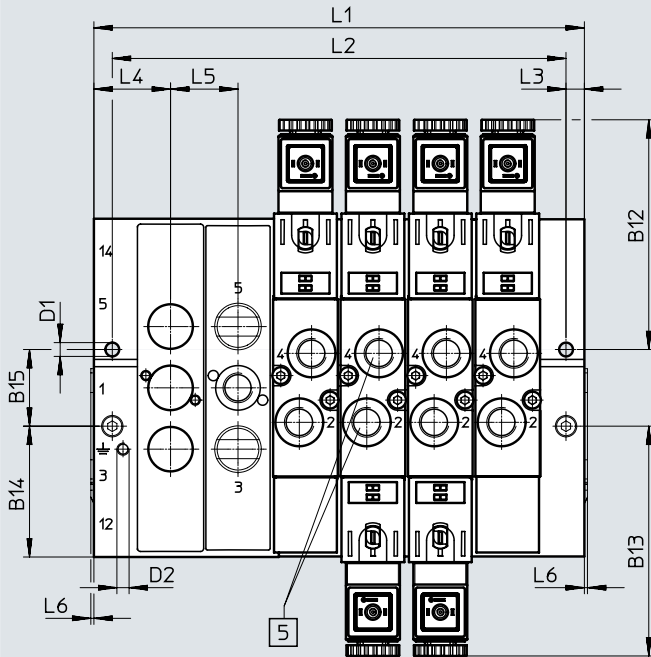

- |   |   |  |  |
|---|---|--|--|
| <p>[1] Port 1, 3 and 5<br/>(on both sides):<br/>G3/8 for VTUS-20<br/>G1/2 for VTUS-25<br/>G3/4 for VTUS-30</p> <p>[3] Port 12 and 14<br/>(on both sides):<br/>G1/8 for VTUS-20, VTUS-25 and<br/>VTUS-30</p> | <p>[4] Thread for extension module:<br/>M5x15.5 for VTUS-20<br/>M5x18 for VTUS-25 and<br/>VTUS-30</p> <p>[5] Port 2 and 4:<br/>G1/8 for VTUS-20<br/>G1/4 for VTUS-25<br/>G3/8 for VTUS-30</p> <p>[6] Profile slot IPM-05 system 5</p> | <p>[7] H-rail mounting VAME-T-M4 for<br/>VTUS-20<br/>VAME-T-M5 for VTUS-25<br/>VAME-T-M6 for VTUS-30</p> <p>[8] Cover plate</p> <p>[9] Supply plate.<br/>Port 1, 3 and 5:<br/>G1/8 for VTUS-20<br/>G1/4 for VTUS-25<br/>G3/8 for VTUS-30</p> | <p>[10] 5/2-way single solenoid valve</p> <p>[11] 5/2-way double solenoid valve<br/>or 5/3-way valve or 2x 3/2-way<br/>valve</p> |
|---|---|--|--|



## Technical data – Valve manifold assembly

Type	B1	B2	B4	B5	B6	B7	B8	B9	B10	B11	B12	B13	B14	B15
VTUS-20	174.9	141.2	110	100.5	97.5	73	81	55	29	12.5	75	75	42.5	25
VTUS-25	200.3	162.2	126	119	113.5	80	95	63	31	16	84.2	84.2	47	32
VTUS-30	220.3	180.7	144	137	129	104	111.5	72	32.5	19	91.2	91.2	38	25

Type	D1 ø	D2	H1	H2	H3	H4	H5	H6	H7	H8	L3	L4	L5	L6
VTUS-20	4.5	M4x6.5	77.4	61	37	23.5	22	18	8.5	91.4	6	25	22	1
VTUS-25	5.5	M4x9	95.5	71	45	25	22	22	9	123.4	6	29.8	27.5	1
VTUS-30	6.3	M5x11	118	91	61	35	22	28.5	9	170.1	7.5	34	32	–

Type	Valve positions	2	3	4	5	6	7	8	9	10
VTUS-20	L1	72	94	116	138	160	182	204	226	248
	L2	60	82	104	126	148	170	192	214	236
VTUS-25	L1	87	114.5	142	169.5	197	224.5	252	279.5	307
	L2	75	102.5	130	157.5	185	212.5	240	267.5	295
VTUS-30	L1	100	132	164	196	228	260	292	324	356
	L2	85	117	149	181	213	245	277	309	341

Technical data – Valve manifold assembly

Dimensions – Valve manifold assembly

Download CAD data → [www.festo.com](http://www.festo.com)

with 5/2-, 5/3-, and 2x 3/2-way valve, compact manifold block

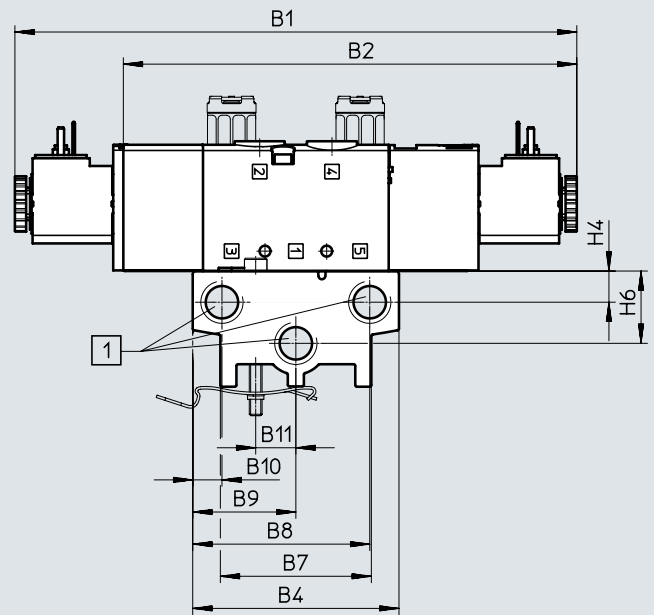
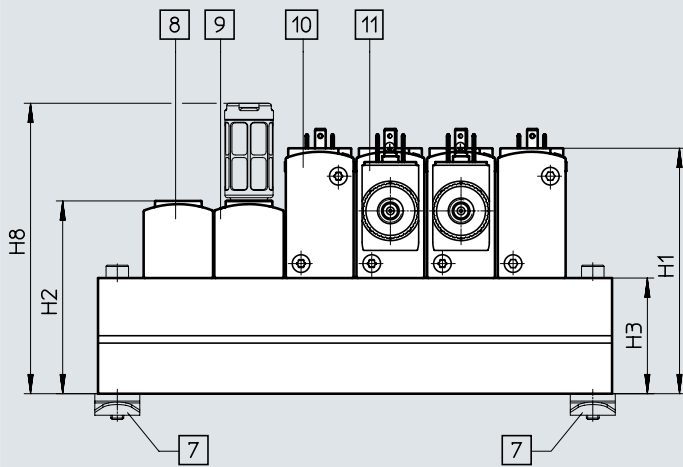
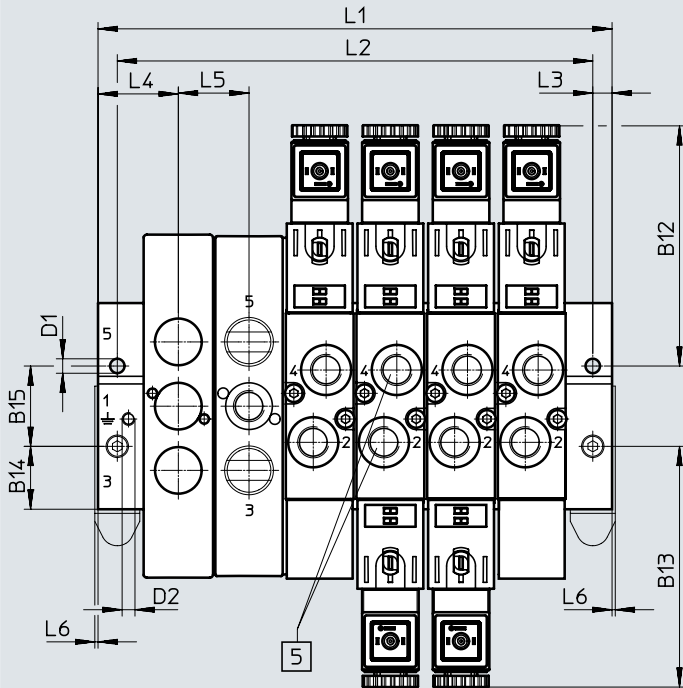

- |  |   |   |  |
|--|---|---|--|
| [1] Port 1, 3 and 5:<br>G1/4 for VTUS-20<br>G3/8 for VTUS-25<br>G1/2 for VTUS-30 | [7] H-rail mounting VAME-T-M4 for VTUS-20<br>VAME-T-M5 for VTUS-25<br>VAME-T-M6 for VTUS-30 | [9] Supply plate,<br>port 1, 3 and 5:<br>G1/8 for VTUS-20<br>G1/4 for VTUS-25<br>G3/8 for VTUS-30 | [10] 5/2-way single solenoid valve<br>[11] 5/2-way double solenoid valve<br>or 5/3-way valve or 2x 3/2-way valve |
| [5] Port 2 and 4:<br>G1/8 for VTUS-20<br>G1/4 for VTUS-25<br>G3/8 for VTUS-30    | [8] Cover plate   |   |  |

## Technical data – Valve manifold assembly

Type	B1	B2	B4	B7	B8	B9	B10	B11	B12	B13	B14	B15
VTUS-20	174.9	141.2	64.2	47	55.1	32.1	9.1	12.5	75	75	19.6	25
VTUS-25	200.3	162.2	80.5	61.5	69	40.3	11.5	16	84.2	84.2	24.3	32
VTUS-30	220.3	180.7	94	77	80.4	47	13.6	19	91.2	91.2	28	38

Type	D1 ø	D2	H1	H2	H3	H4	H6	H8	L3	L4	L5	L6
VTUS-20	4.5	M4x6.5	76.4	60	36	9.7	22.5	90.4	6	25	22	1
VTUS-25	5.5	M4x9	84.5	60	34	13.5	20	112.4	6	29.8	27.5	1
VTUS-30	6.3	M5x11	99.5	72.5	42.5	17.5	26	151.6	7.5	34	32	–

Type	Valve positions	2	3	4	5	6	7	8	9	10
VTUS-20	L1	72	94	116	138	160	182	204	226	248
	L2	60	82	104	126	148	170	192	214	236
VTUS-25	L1	87	114.5	142	169.5	197	224.5	252	279.5	307
	L2	75	102.5	130	157.5	185	212.5	240	267.5	295
VTUS-30	L1	100	132	164	196	228	260	292	324	356
	L2	85	117	149	181	213	245	277	309	341

Technical data – Valve manifold assembly

Dimensions – Common supply manifold

Download CAD data → [www.festo.com](http://www.festo.com)

Mounting on both sides

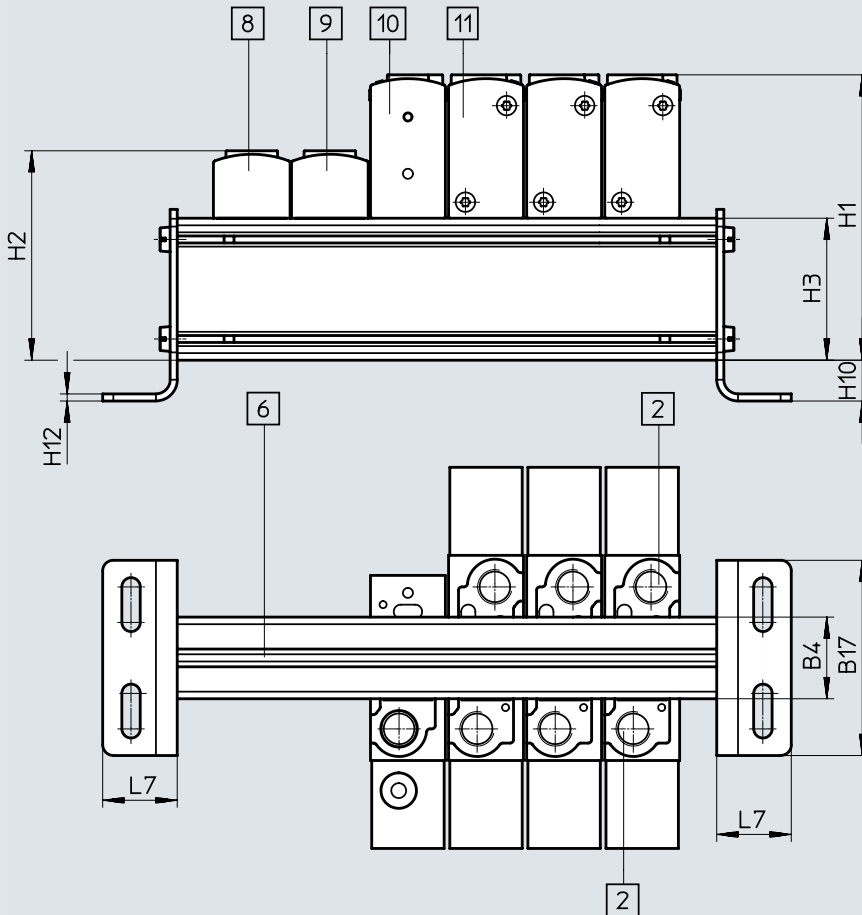

- |   |   |  |  |
|---|---|--|--|
| <p>[2] Port 3 and 5:<br/>G1/8 for VTUS-20<br/>G1/4 for VTUS-25<br/>G3/4 for VTUS-30</p> | <p>[3] Port 12/14:<br/>M5 for VTUS-20<br/>M5 for VTUS-25<br/>G1/8 for VTUS-30</p> <p>[6] Profile slot IPM-05 system 5</p> | <p>[8] Cover plate</p> <p>[9] Supply plate,<br/>port 1:<br/>G1/8 for VTUS-20<br/>G1/4 for VTUS-25<br/>G3/8 for VTUS-30</p> | <p>[10] 3/2-way valve</p> <p>[11] 5/2-way single solenoid valve</p> <p>[12] 5/2-way double solenoid valve<br/>or 5/3-way valve or 2x 3/2-way valve</p> |
|---|---|--|--|

Type	B4	B17	H1	H2	H3	H10	H11	H12	L7
VTUS-20	23	55	80.4	59	40	11.5	6.3	2	21
VTUS-25	28.7	75	102.5	78	52	18	6.7	2	24
VTUS-30	34	85	122	95	65	17.5	6.7	2.5	26

Technical data – Valve manifold assembly

Dimensions – Common supply manifold

Download CAD data → [www.festo.com](http://www.festo.com)

Mounting on both sides

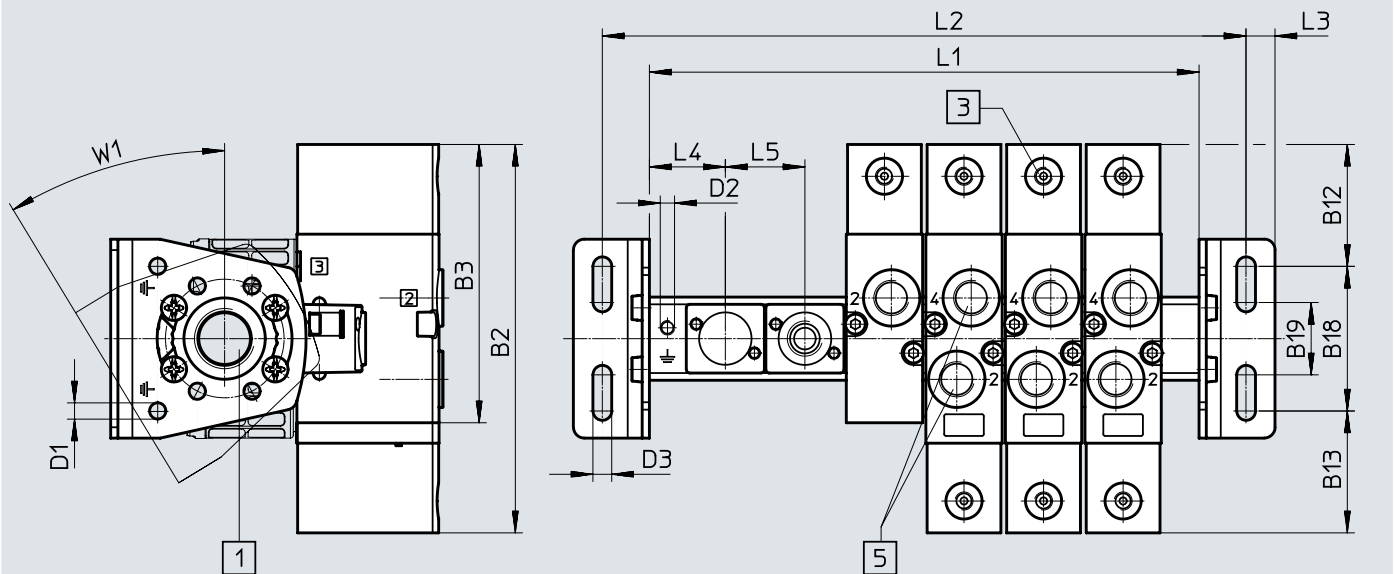

- [1] Port 1 (on both sides):  
 G3/8 for VTUS-20  
 G1/2 for VTUS-25  
 G3/4 for VTUS-30

- [5] Port 2 and 4:  
 G1/8 for VTUS-20  
 G1/4 for VTUS-25  
 G3/8 for VTUS-30

 **Note**  
 Mounting bracket can be adjusted through  $\pm 30^\circ$ .

Technical data – Valve manifold assembly

Type	B1	B2	B3	B12	B13	B18	B19
VTUS-20	174.9	141.2	110.7	67.5	67.5	40	20
VTUS-25	200.3	162.2	129.2	70.2	70.2	60	35
VTUS-30	220.3	180.7	144.9	77.7	77.7	65	35

Type	D1 ø	D2	D3 ø	L3	L4	L5	W1
VTUS-20	4.5	M4x6.5	5.2	8	21	22	30°
VTUS-25	4.5	M4x9	6.6	8	29.8	27.5	30°
VTUS-30	5.5	M5x11	8.6	9	34	32	30°

Type	Valve positions	2	3	4	5	6	7	8	9	10
VTUS-20	L1	64	86	108	130	152	174	196	218	240
	L2	90	112	134	156	178	200	222	244	266
VTUS-25	L1	87	114.5	142	169.5	197	224.5	252	279.5	307
	L2	119	146.5	174	201.5	229	256.5	284	311.5	339
VTUS-30	L1	100	132	164	196	228	260	292	324	356
	L2	134	166	198	230	262	294	326	358	390

Technical data – Valve manifold assembly

Dimensions – Common supply manifold

Download CAD data → [www.festo.com](http://www.festo.com)

Mounting on one side

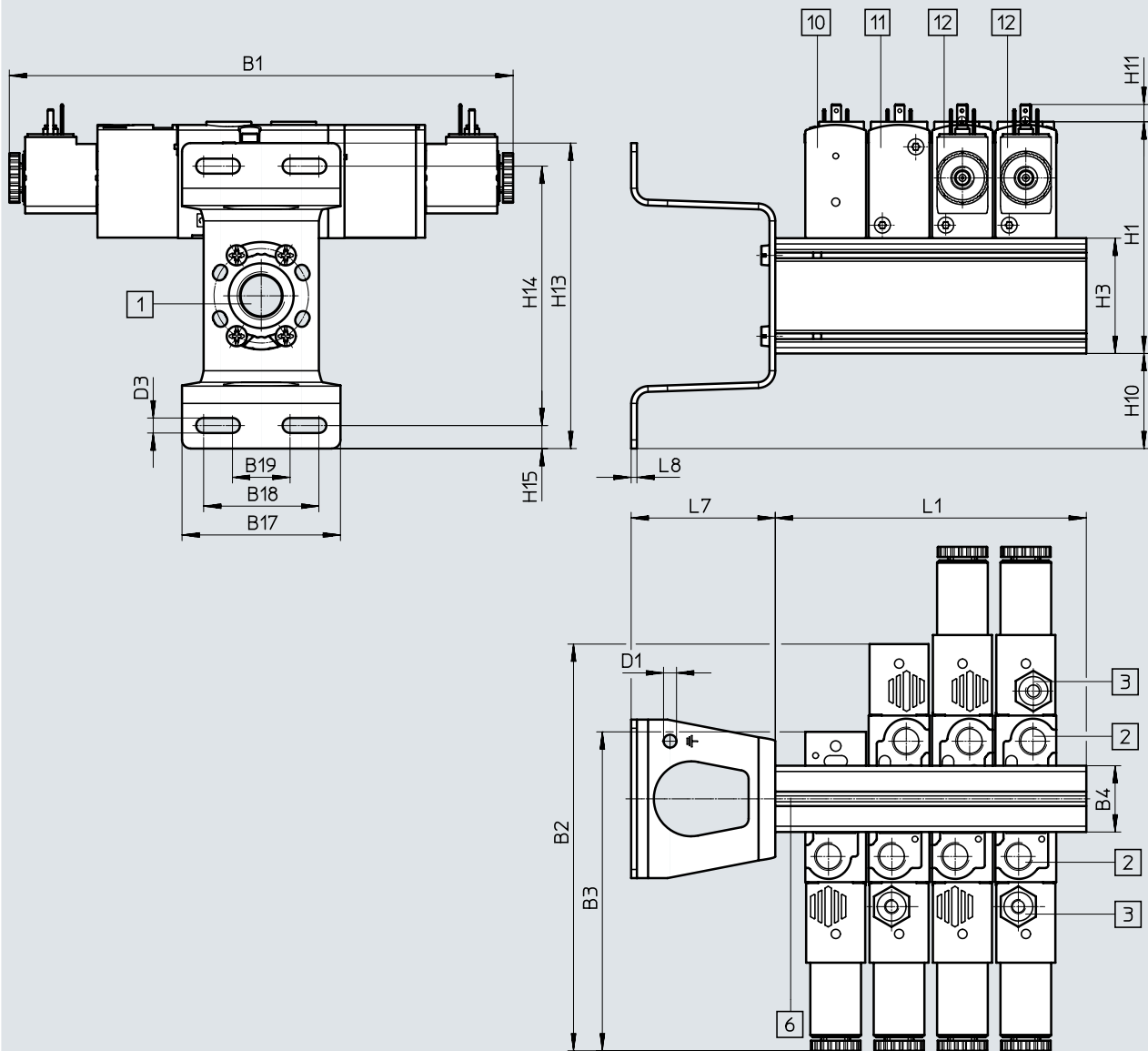

[1] Port 1 (at both sides): G3/8 for VTUS-20

G1/2 for VTUS-25  
G3/4 for VTUS-30

[2] Port 3 and 5:

G1/8 for VTUS-20  
G1/4 for VTUS-25

G3/8 for VTUS-30

[3] Port 12 and 14:

M5 for VTUS-20 and VTUS-25

G1/8 for VTUS-30

[6] Profile slot IPM-05 system 5

[10] 3/2-way valve

[11] 5/2-way single solenoid valve

[12] 5/2-way double solenoid valve or 5/3-way valve or 2x 3/2-way valve



**Note**

Mounting bracket can be adjusted through ±30°.

Technical data – Valve manifold assembly

Type	B1	B2	B4	B17	B18	B19
VTUS-20	174.9	110.7	23	55	40	20
VTUS-25	200.3	129.2	28.7	80	60	35
VTUS-30	220.3	144.9	34	85	65	35

Type	D1 ø	D3 ø	H1	H3	H10	H11	H13	H14	H15	L7	L8
VTUS-20	4.5	5.2	80.4	40	33	6.3	106	90	8	50	2
VTUS-25	4.5	6.6	102.5	52	38	6.7	128	112	8	64	2
VTUS-30	5.5	8.6	122	65	38	6.7	146	128	9	74	2.5

Type	Valve positions	2	3	4
VTUS-20	L1	64	86	108
VTUS-25	L1	87	114.5	142
VTUS-30	L1	100	132	164



## Type codes – Solenoid valves

<b>001</b>	<b>Series</b>	
<b>VUVS</b>	Solenoid valve, universal	
<b>002</b>	<b>Directional control valve type</b>	
<b>L</b>	In-line valve	
<b>003</b>	<b>Design principle</b>	
	Piston spool	
<b>K</b>	Piston spool with sealing ring	
<b>T</b>	Poppet valve	
<b>004</b>	<b>Size</b>	
<b>20</b>	Size 20	
<b>25</b>	Size 25	
<b>30</b>	Size 30	
<b>005</b>	<b>Valve function</b>	
<b>M32U</b>	3/2-way valve, normally open	
<b>M32C</b>	3/2-way valve, normally closed	
<b>T32U</b>	2x3/2-way valve, normally open	
<b>T32C</b>	2x3/2-way valve, normally closed	
<b>T32H</b>	2x3/2-way valve, 1x normally closed, 1x normally open	
<b>M52</b>	5/2-way valve, single solenoid/monostable	
<b>B52</b>	5/2-way valve, double solenoid/bistable	
<b>P53U</b>	5/3-way valve, mid-position pressurised	
<b>P53E</b>	5/3-way valve, mid-position exhausted	
<b>P53C</b>	5/3-way valve, mid-position closed	
<b>006</b>	<b>Reset method for monostable/single solenoid valves</b>	
	None	
<b>A</b>	Pneumatic spring	
<b>M</b>	Mechanical spring	
<b>007</b>	<b>Pilot air</b>	
	Internal	
<b>Z</b>	External	
<b>008</b>	<b>Manual override</b>	
<b>D</b>	Non-detenting, detenting	
<b>H</b>	Non-detenting	
<b>S</b>	Covered	
<b>009</b>	<b>Pneumatic connection</b>	
<b>G18</b>	G1/8	
<b>G14</b>	G1/4	
<b>G38</b>	G3/8	
<b>N18</b>	1/8 NPT	
<b>N14</b>	1/4 NPT	
<b>N38</b>	3/8 NPT	
<b>Q4</b>	Push-in connector 4 mm	
<b>Q6</b>	Push-in connector 6 mm	
<b>Q8</b>	Push-in connector 8 mm	
<b>Q10</b>	Push-in connector 10 mm	
<b>Q12</b>	Push-in connector 12 mm	
<b>T532</b>	Push-in connector 5/32"	
<b>T14</b>	Push-in connector 1/4"	
<b>T38</b>	Push-in connector 3/8"	
<b>T516</b>	Push-in connector 5/16"	
<b>T12</b>	Push-in connector 1/2"	

<b>010</b>	<b>Exhaust</b>	
	No fitting	
<b>QN</b>	With fitting	
<b>U1</b>	Silencer with metallic housing	
<b>U3</b>	Silencer with polymer housing	
<b>U5</b>	Sintered silencer, long	

<b>011</b>	<b>Valve pilot control interface</b>	
<b>F7</b>	With armature tube 8 mm, short	
<b>F8</b>	With armature tube 8 mm, long	
	Standard	

<b>012</b>	<b>Nominal operating voltage</b>	
	None	
<b>1</b>	24 V DC	
<b>5</b>	12 V DC	
<b>1A</b>	24 V AC/50-60 Hz	
<b>16B</b>	120 V AC/60 Hz and 110V AC/50-60 Hz	
<b>3A</b>	230 V AC/50-60 Hz	
<b>3W</b>	230 V AC/240 V AC/50-60 Hz	

<b>013</b>	<b>Electrical connection</b>	
	None	
<b>A1</b>	Connection pattern type A, to EN 175 301	
<b>B2</b>	Connection pattern type B, industry standard	
<b>C1</b>	Connection pattern type C, to EN 175 301	



<b>014</b>	<b>Degree of protection, electrical system</b>	
	Standard	
<b>S8</b>	IP67	

<b>015</b>	<b>EU certification</b>	
	None	
<b>EX2</b>	II 3GD	

<b>016</b>	<b>Electrical valve accessories</b>	
<b>G</b>	Connector socket, without LED	
	None	
<b>GS</b>	Connector socket, with protective circuit	

<b>017</b>	<b>Version</b>	
	Expanded properties	
<b>S</b>	Focused properties	

## Technical data

-  - Flow rate  
up to 550 l/min
-  - Valve width  
21 mm
-  - Voltage  
24 V DC

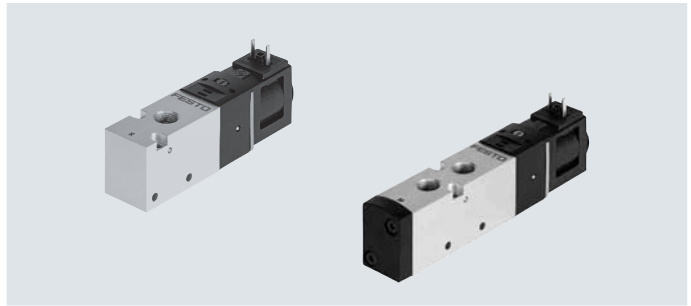

General technical data			
Valve function		3/2-way valve	5/2-way valve
Order code for valves		M32C	M52 B52
Valve width	[mm]	21	
Nominal width	Diameter [mm]	5.2	
Design		Piston spool	
Flow direction		Non-reversible	
Pilot air supply		Internal	
Type of control		Piloted	
Manual override		Non-detenting, detenting	
Overlap		Positive overlap	
Sealing principle		Soft	
Type of mounting		Optionally via through-hole or on manifold rail	
Standard nominal flow rate q <sub>nN</sub>	[l/min]	550	550
Actuation type		Electric	
Mounting position		Any	
Exhaust air function		Can be throttled	
Connection for venting hole		Not ducted	
b value		0.38	
c value	[l/sbar]	2.66	
Pneumatic connection	1, 2, 3 4, 5	G1/8 -	G1/8 G1/8

Technical data – 3/2-way valves		
Order code for valves		M32C
Normal position		Closed
Stable position		Monostable
Reset method		Pneumatic spring
Switching times in [ms]	On	16
	Off	20
	Change over	-
Product weight with solenoid coil	[g]	120
Product weight with solenoid coil and plug socket	[g]	133

## Technical data

Technical data – 5/2-way valves			
Order code for valves		M52	B52
Normal position		–	–
Stable position		Monostable	Bistable
Reset method		Pneumatic spring	–
Switching times in [ms]	On	17	–
	Off	22	–
	Change over	–	10
Product weight with solenoid coil	[g]	145	200
Product weight with solenoid coil and plug socket	[g]	158	226

Safety data		
Max. positive test pulse with logic 0	[is]	2700
Max. negative test pulse with logic 1	[is]	1100
Shock resistance	Shock test with severity level 1 to FN 942017-5 and EN 60068-2-27	
Vibration resistance	Transport application test with severity level 2 to FN 942017-4 and EN 60068-2-6	

Operating and environmental conditions				
Order code for valves		M32C	M52	B52
Operating medium		Compressed air to ISO 8573-1:2010 [7:4:4]		
Pilot medium		Compressed air to ISO 8573-1:2010 [7:4:4]		
Note on operating/pilot medium		Lubricated operation possible (in which case lubricated operation will always be required)		
Operating pressure	[MPa]	0.15 ... 0.8	0.15 ... 0.8	0.15 ... 0.8
	[bar]	1.5 ... 8	1.5 ... 8	1.5 ... 8
Ambient temperature	[°C]	–5 ... +50		
Temperature of medium	[°C]	–5 ... +50		
Corrosion resistance class CRC <sup>1)</sup>		1		

1) Corrosion resistance class CRC 1 to Festo standard FN 940070

Low corrosion stress. Dry indoor application or transport and storage protection. Also applies to parts behind coverings, in the non-visible interior area, and parts which are covered in the application (e.g. drive trunnions).

Electrical data		
Electrical connection	Plug type C to EN 175301-803	
Operating voltage	[V DC]	24
Permissible voltage fluctuations	[%]	±10
Power	[W]	2.6
Duty cycle	[%]	100
Degree of protection to EN 60529	IP65 with plug socket	

Materials	
Housing	Wrought aluminium alloy
Seals	HNBR, NBR
Piston spool	Wrought aluminium alloy
Note on materials	RoHS-compliant
	Contains paint-wetting impairment substances

## Technical data

### Dimensions

Download CAD data → [www.festo.com](http://www.festo.com)

3/2-way valves, with solenoid coil

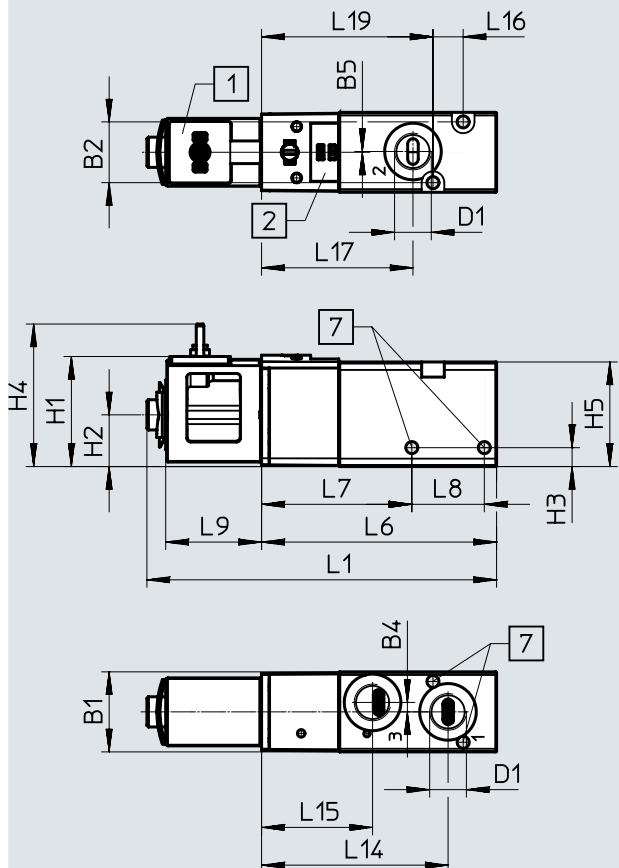

[1] Solenoid coil interface type C

[2] Space for inscription label

[3] For screw M3

[4] For screw M4

Type	B1	B2	B4	B5	D1	H1	H2	H3	H4	H5
VUVS-LK20-M32C-AD-G18-1C1-S	21.2	16.1	2.5	0.2	G1/8	29.2	13.7	4.5	37.8	27.7

Type	L1	L6	L7	L8	L9	L14	L15	L16	L17	L19
VUVS-LK20-M32C-AD-G18-1C1-S	92.7	62.3	39.4	20	25.4	49.4	29.4	8	40.1	45.4

## Technical data

### Dimensions

Download CAD data → [www.festo.com](http://www.festo.com)

5/2-way single solenoid valves, with solenoid coil

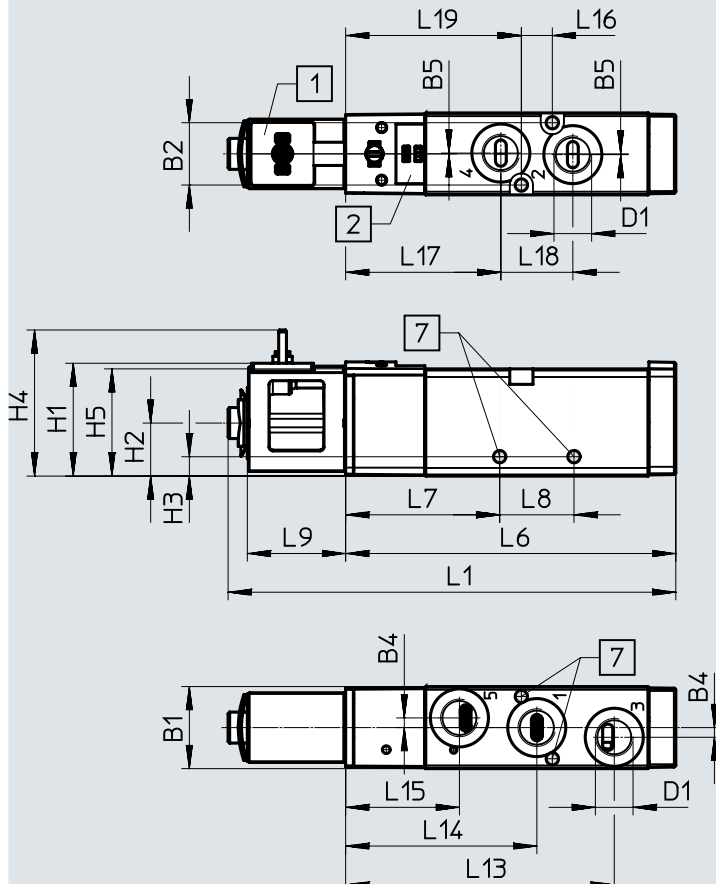

[1] Solenoid coil interface type C

[2] Space for inscription label

[3] For screw M3

[4] For screw M4

Type	B1	B2	B4	B5	D1	H1	H2	H3	H4	H5
VUVS-LK20-M52-AD-G18-1C1-S	21.2	16.2	2.5	0.2	G1/8	29.2	13.7	4.5	37.8	27.7

Type	L1	L6	L7	L8	L9	L13	L14	L15	L16	L17	L18	L19
VUVS-LK20-M52-AD-G18-1C1-S	115.7	85.3	39.4	20	25.4	69.4	49.4	29.4	8	40.1	18.6	45.4

## Technical data

### Dimensions

Download CAD data → [www.festo.com](http://www.festo.com)

5/2-way double solenoid valves, with solenoid coil

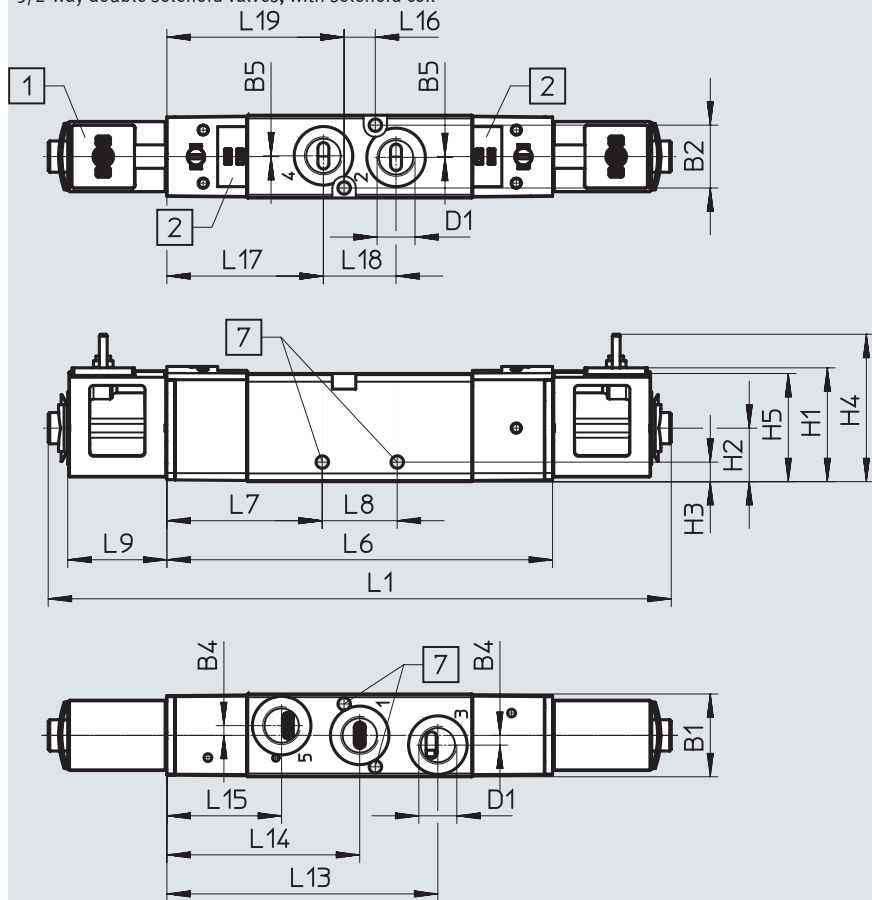

[1] Solenoid coil interface type C

[2] Space for inscription label

[3] For screw M3

[4] For screw M4

Type	B1	B2	B4	B5	D1	H1	H2	H3	H4	H5
VUVS-LK20-B52-D-G18-1C1-S	21.2	16.1	2.5	0.2	G1/8	29.2	13.7	4.5	37.8	27.7

Type	L1	L6	L7	L8	L9	L13
VUVS-LK20-B52-D-G18-1C1-S	159.7	98.8	39.4	20	25.4	69.4

Type	L14	L15	L16	L17	L18	L19
VUVS-LK20-B52-D-G18-1C1-S	49.4	29.4	8	40.1	18.6	45.4

Accessories

Dimensions

Download CAD data → [www.festo.com](http://www.festo.com)

Foot mounting

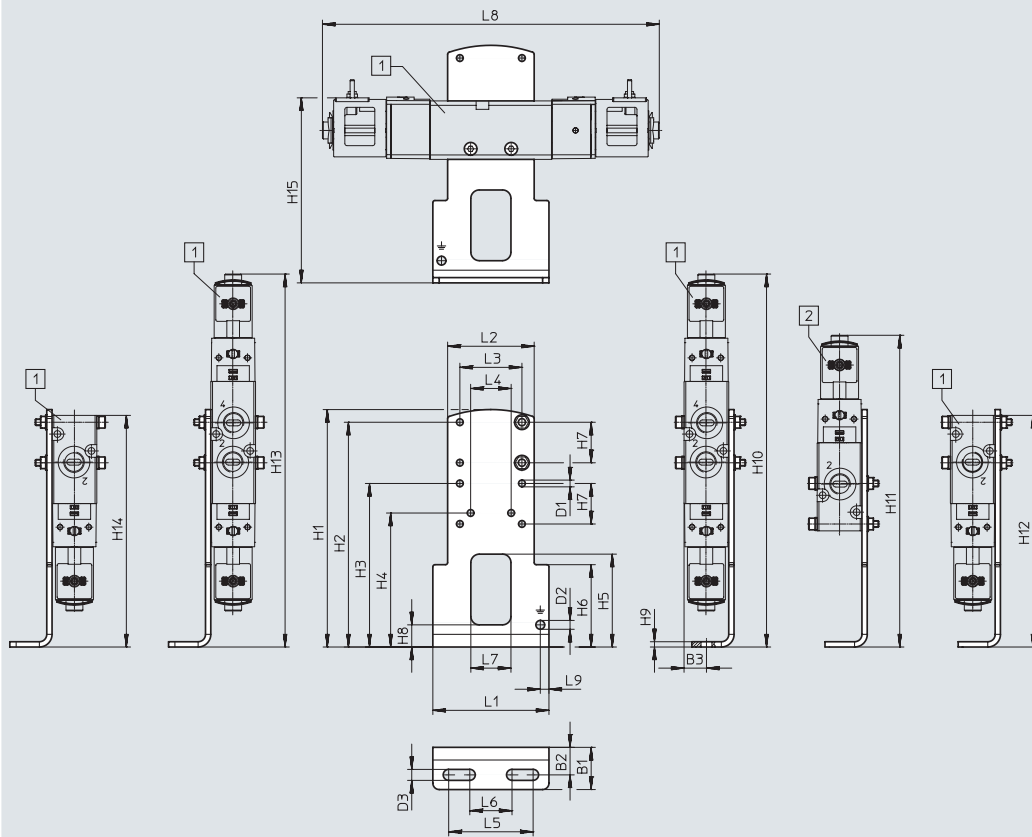

[1] VUVS-LK20-B52,  
VUVS-LK20-M52,  
VUVS-LK20-M32

[2] VUVS-LK20-M52,  
VUVS-LK20-M32

Type		B1	B2	B3	D1 ∅	D2 ∅	D3	H1	H2	H3	H4
VAME-B10-20-A	VUVS-LK20-B52	20	13.1	10.6	3.2	4.2	5.2	112.5	106.5	77.5	63.5
	VUVS-LK20-M52										
	VUVS-LK20-M32										

Type		H5	H6	H7	H8	H9	H10	H11	H12	H13	H14
VAME-B10-20-A	VUVS-LK20-B52	44	39	19.2	10.5	2.5	176.7	–	176.7	176.7	176.7
	VUVS-LK20-M52							147.7	132.8	132.8	
	VUVS-LK20-M32								109.8	109.8	

Type		H15	L1	L2	L3	L4	L5	L6	L7	L8	L9
VAME-B10-20-A	VUVS-LK20-B52	87.7	55	41	29.4	19.2	40	20	19	174.9	4.1
	VUVS-LK20-M52									141.2	
	VUVS-LK20-M32									110.7	

Accessories

Dimensions

Download CAD data → [www.festo.com](http://www.festo.com)

Wall mounting

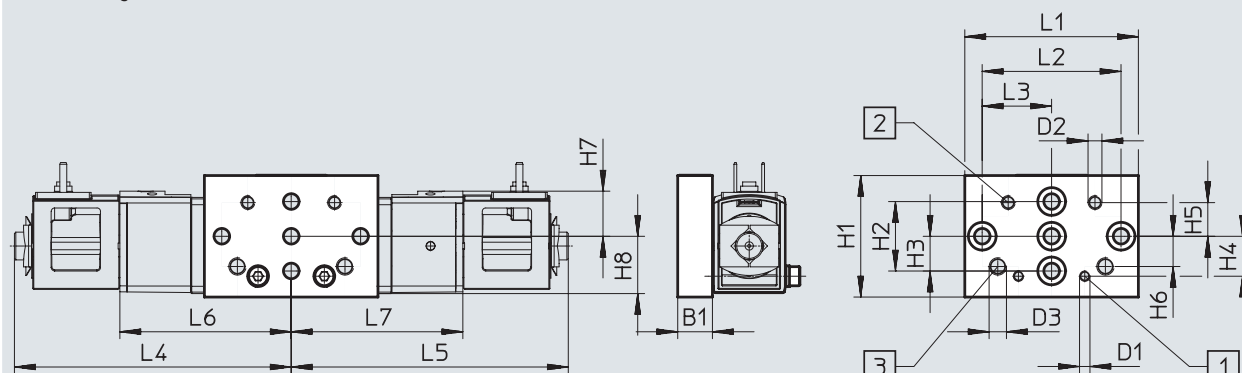

[1] Mounting hole for size 20

[2] Mounting hole for size 25

[3] Mounting hole for size 30



Type		B1	D1	D2	D3	H1	H2	H3	H4	H5	H6
VAME-B10-20-W	VUVS-LK20-B52	10	M3	M4	M5	35	20	10	11.5	9.7	8.7
	VUVS-LK20-M52										
	VUVS-LK20-M32										

Type		H7	H8	L1	L2	L3	L4	L5	L6	L7
VAME-B10-20-W	VUVS-LK20-B52	13	16.5	50	40	20	79.8	79.8	49.4	49.4
	VUVS-LK20-M52									
	VUVS-LK20-M32									





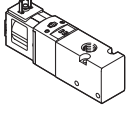
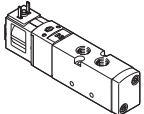
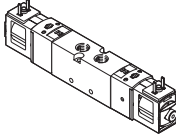

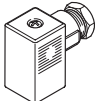
## Accessories

## ★ Core product range

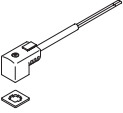

Ordering data						
		Code	Valve function	Part no.	Type	
<b>3/2-way valve with solenoid coil (24 V DC)</b>						
	<b>Single solenoid, normally closed, type C</b>					
	M32C-A	Reset via pneumatic spring, internal pilot air supply, flow direction not reversible	★ 8043213	VUVS-LK20-M32C-AD-G18-1C1-S		
<b>5/2-way valve with solenoid coil (24 V DC)</b>						
	<b>Single solenoid, type C</b>					
	M52-A	Reset via pneumatic spring, internal pilot air supply, flow direction not reversible	★ 8043214	VUVS-LK20-M52-AD-G18-1C1-S		
	<b>Double solenoid, type C</b>					
	B52	Internal pilot air supply, flow direction not reversible	★ 8043215	VUVS-LK20-B52-D-G18-1C1-S		
<b>Ordering data</b>						
		Description		Part no.	Type	
<b>Cover cap</b>						
	For manual override, non-detenting or covered			8049538	VAMC-B10-20-CH2-S	
<b>Plug socket</b>						
	<b>Plug pattern type C, to DIN EN 175301-803</b>					
	3-pin, screw terminal	Cable connector M12	0 ... 250 V AC/DC	IP65	539712	MSSD-EB-M12
		Cable connector Pg7			★ 151687	MSSD-EB
	4-pin, insulation displacement connector	Cable connector M14	0 ... 250 V AC/DC	IP67	192745	MSSD-EB-S-M14

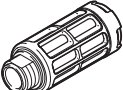
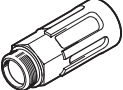
## Accessories

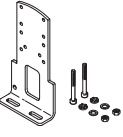
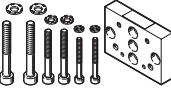
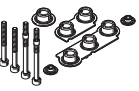

Ordering data		Description	Part no.	Type		
<b>Plug socket with cable</b>						
	<b>Plug pattern type C, to DIN EN 175301-803</b>					
	Angled socket, 3-pin Cable, open end, 3-wire	24 V DC	LED	2.5 m	★ 151688	KMEB-1-24-2.5-LED
				5 m	151689	KMEB-1-24-5-LED
				10 m	193457	KMEB-1-24-10-LED
<b>Illuminating seal</b>						
	Plug pattern type C, to DIN EN 175301-803	24 V DC		151717	MEB-LD-12-24DC	
Ordering data		Description	Part no.	Type	PU <sup>1)</sup>	
<b>Push-in fitting with internal hex</b>						
	Connecting thread G1/8 for tubing O.D.		4 mm	★ 186106	QS-G1/8-4-I	10
				133008	QS-G1/8-4-I-100	100
			6 mm	★ 186107	QS-G1/8-6-I	10
				133009	QS-G1/8-6-I-100	100
			8 mm	★ 186109	QS-G1/8-8-I	10
				133010	QS-G1/8-8-I-100	100
<b>Angled push-in fitting with external hex</b>						
	Connecting thread G1/8 for tubing O.D.		4 mm	★ 186116	QSL-G1/8-4	10
				132048	QSL-G1/8-4-100	100
			6 mm	★ 186117	QSL-G1/8-6	10
				132049	QSL-G1/8-6-100	100
			8 mm	★ 186119	QSL-G1/8-8	10
				132050	QSL-G1/8-8-50	50
<b>Angled push-in fitting, long, with external hex</b>						
	Connecting thread G1/8 for tubing O.D.		4 mm	186127	QSL-G1/8-4	10
				133015	QSL-G1/8-4-100	100
			6 mm	186128	QSL-G1/8-6	10
				133016	QSL-G1/8-6-100	100
			8 mm	186130	QSL-G1/8-8	10
				133017	QSL-G1/8-8-100	100
<b>Silencer</b>						
	With connecting thread G, polymer design	G1/8		★ 2307	U-1/8	1
				534222	U-1/8-50	50
	With connecting thread G, metal design	G1/8		6841	U-1/8-B	1

1) Packaging unit

## Accessories

Ordering data	Description	Weight [g]	Part no.	Type
<b>Foot mounting</b>				
	With screw set for attaching the valve to the foot mounting	97	576412	VAME-B10-20-A
<b>Wall mounting</b>				
	With screw set for attaching the valve to the wall mounting	53	576413	VAME-B10-20-W
<b>Assortment of spare parts</b>				
	Set comprising seals and screws	10	8026203	VAME-B10-20-MK
<b>Screw set</b>				
	For mounting valves VUVS-LK on common supply manifolds, comprising 2 screws M3x30	4.5	8069876	VAME-B10-20-S
<b>Inscription label</b>				
	40 pieces in frame	-	565306	ASLR-C-E4

## Technical data

-  - Flow rate  
up to 1000 l/min
-  - Valve width  
26.5 mm
-  - Voltage  
24 V DC

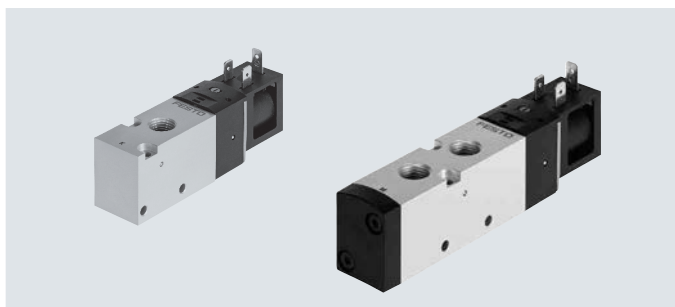

General technical data			
Valve function		3/2-way valve	5/2-way valve
Order code for valves		M32C	M52 B52
Valve width	[mm]	26.5	
Nominal width	Diameter [mm]	6.7	
Design		Piston spool	
Flow direction		Non-reversible	
Pilot air supply		Internal	
Type of control		Piloted	
Manual override		Non-detenting, detenting	
Overlap		Positive overlap	
Sealing principle		Soft	
Type of mounting		Optionally via through-hole or on manifold rail	
Standard nominal flow rate q <sub>N</sub>	[l/min]	1000	1000
Actuation type		Electric	
Mounting position		Any	
Exhaust air function		Can be throttled	
Connection for venting hole		Not ducted	
b value		0.45	
c value	[l/sbar]	3.86	
Pneumatic connection	1, 2, 3 4, 5	G1/4 -	G1/4 G1/4

Technical data – 3/2-way valves		
Order code for valves		M32C
Normal position		Closed
Stable position		Monostable
Reset method		Pneumatic spring
Switching times in [ms]	On	16
	Off	20
	Change over	-
Product weight with solenoid coil	[g]	200
Product weight with solenoid coil and plug socket	[g]	224

## Technical data

Technical data – 5/2-way valves			
Order code for valves		M52	B52
Normal position		–	–
Stable position		Monostable	Bistable
Reset method		Pneumatic spring	–
Switching times in [ms]	On	20	–
	Off	22	–
	Change over	–	12
Product weight with solenoid coil	[g]	250	320
Product weight with solenoid coil and plug socket	[g]	274	368

Safety data		
Max. positive test pulse with logic 0	[is]	2500
Max. negative test pulse with logic 1	[is]	1100
Shock resistance	Shock test with severity level 1 to FN 942017-5 and EN 60068-2-27	
Vibration resistance	Transport application test with severity level 2 to FN 942017-4 and EN 60068-2-6	

Operating and environmental conditions				
Order code for valves		M32C	M52	B52
Operating medium		Compressed air to ISO 8573-1:2010 [7:4:4]		
Pilot medium		Compressed air to ISO 8573-1:2010 [7:4:4]		
Note on operating/pilot medium		Lubricated operation possible (in which case lubricated operation will always be required)		
Operating pressure	[MPa]	0.15 ... 0.8	0.15 ... 0.8	0.15 ... 0.8
	[bar]	1.5 ... 8	1.5 ... 8	1.5 ... 8
Ambient temperature	[°C]	–5 ... +50		
Temperature of medium	[°C]	–5 ... +50		
Corrosion resistance class CRC <sup>1)</sup>		1		

1) Corrosion resistance class CRC 1 to Festo standard FN 940070

Low corrosion stress. Dry indoor application or transport and storage protection. Also applies to parts behind coverings, in the non-visible interior area, and parts which are covered in the application (e.g. drive trunnions).

Electrical data		
Electrical connection	Plug type B to industry standard (11 mm)	
Operating voltage	[V DC]	24
Permissible voltage fluctuations	[%]	10
Power	[W]	3.3
Duty cycle	[%]	100
Degree of protection to EN 60529	IP65 with plug socket	

Materials	
Housing	Wrought aluminium alloy
Seals	HNBR, NBR
Piston spool	Wrought aluminium alloy
Note on materials	RoHS-compliant
	Contains paint-wetting impairment substances

## Technical data

### Dimensions

Download CAD data → [www.festo.com](http://www.festo.com)

3/2-way valves, with solenoid coil

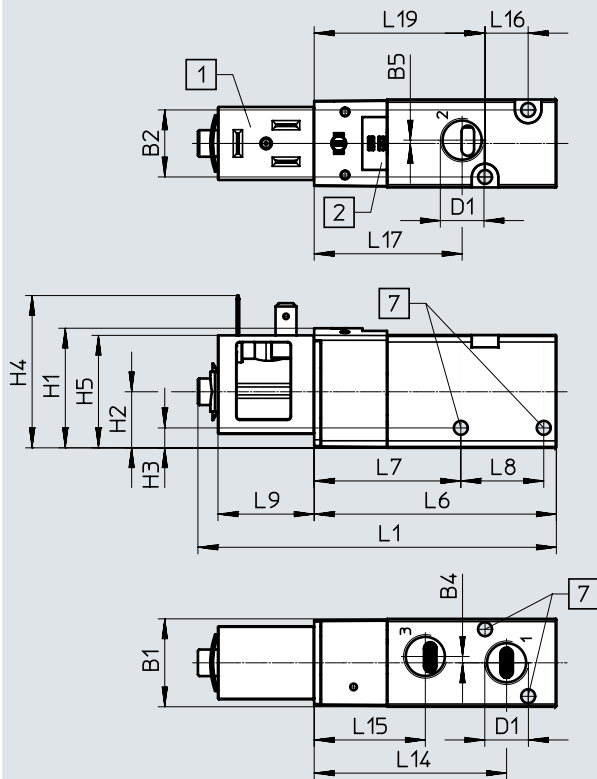

[1] Solenoid coil interface type B

[2] Space for inscription label

[7] For screw M4

Type	B1	B2	B4	B5	D1	H1	H2	H3	H4	H5
VUVS-LK25-M32C-AD-G14-1B2-S	26.5	20.2	1.9	1	G1/4	36.1	16.9	6	45.9	33.9

Type	L1	L6	L7	L8	L9	L14	L15	L16	L17	L19
VUVS-LK25-M32C-AD-G14-1B2-S	109.2	74.1	44.2	25	29	58	33.5	13	44.6	51.5

## Technical data

### Dimensions

Download CAD data → [www.festo.com](http://www.festo.com)

5/2-way single solenoid valves, with solenoid coil

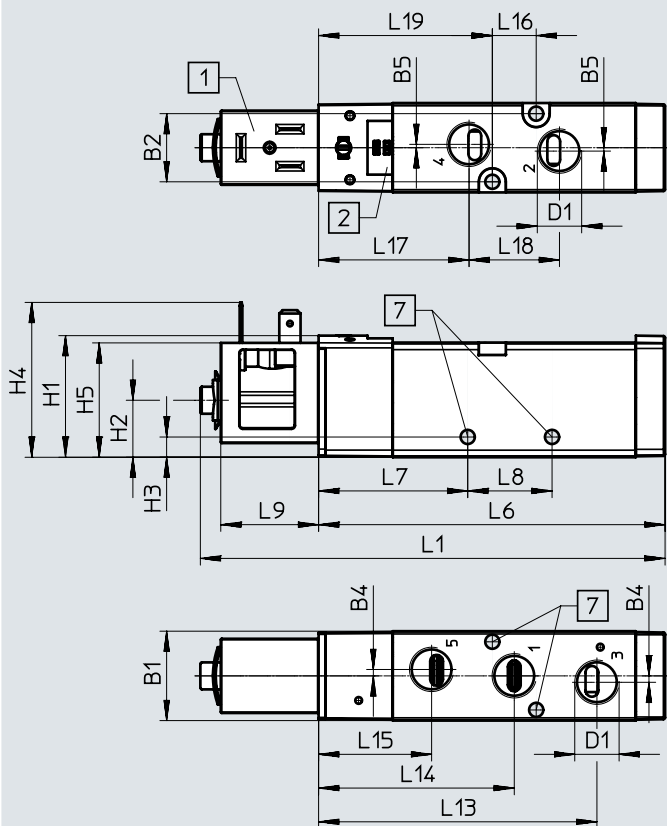

[1] Solenoid coil interface type B

[2] Space for inscription label

[7] For screw M4

Type	B1	B2	B4	B5	D1	H1	H2	H3	H4	H5
VUVS-LK25-M52-AD-G14-1B2-S	26.5	20.2	1.9	1	G1/4	36.1	16.9	6	45.9	33.9

Type	L1	L6	L7	L8	L9	L13	L14	L15	L16	L17	L18	L19
VUVS-LK25-M52-AD-G14-1B2-S	137.8	102.7	44.2	25	29	82.5	58	33.5	13	44.6	26.8	51.5

## Technical data

### Dimensions

Download CAD data → [www.festo.com](http://www.festo.com)

5/2-way double solenoid valves, with solenoid coil

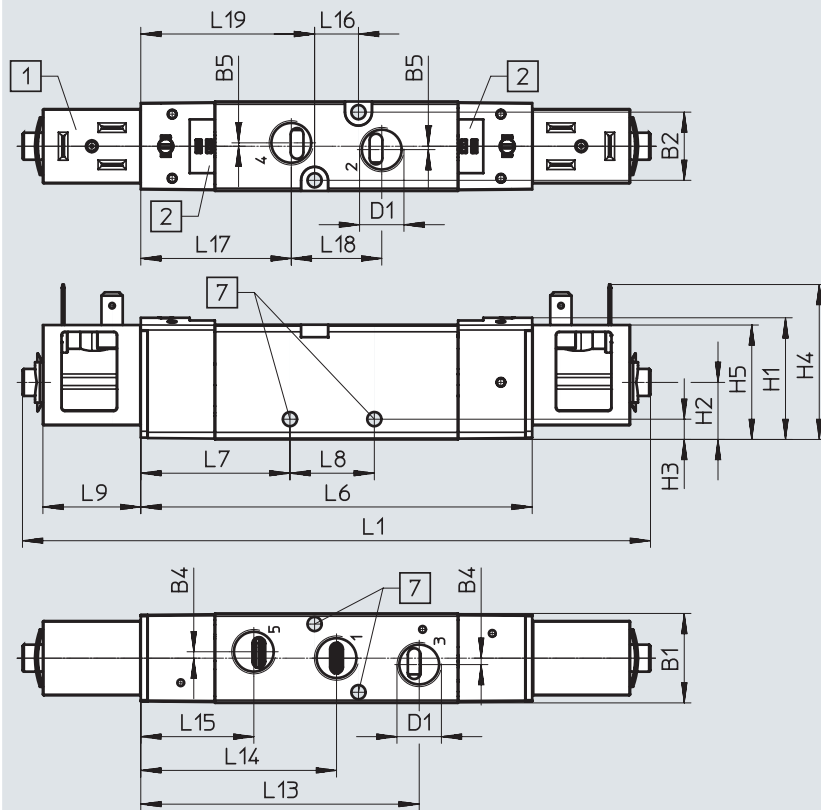

[1] Solenoid coil interface type B

[2] Space for inscription label

[7] For screw M4

Type	B1	B2	B4	B5	D1	H1	H2	H3	H4	H5
VUVS-LK25-B52-D-G14-1B2-S	26.5	20.2	1.9	1	G1/4	36.1	16.9	6	45.9	33.9

Type	L1	L6	L7	L8	L9	L13	L14	L15	L16	L17	L18	L19
VUVS-LK25-B52-D-G14-1B2-S	186.1	116	44.2	25	29	82.5	58	33.5	13	44.6	26.8	51.5



Accessories

Dimensions

Download CAD data → [www.festo.com](http://www.festo.com)

Foot mounting

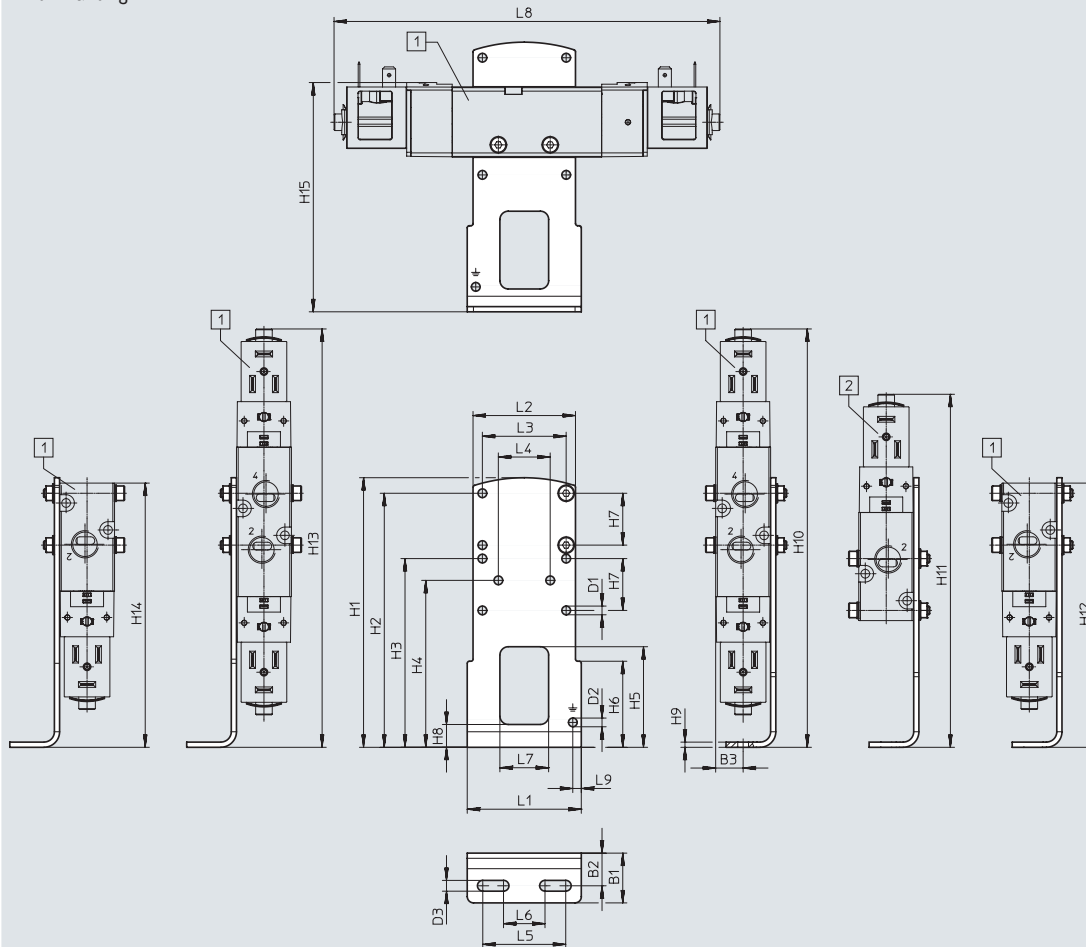

[1] VUVS-LK25-B52,  
VUVS-LK25-M52,  
VUVS-LK25-M32

[2] VUVS-LK25-M52,  
VUVS-LK25-M32

Type		B1	B2	B3	D1 ∅	D2 ∅	D3	H1	H2	H3	H4
VAME-B10-25-A	VUVS-LK25-B52	24	15.8	13.3	4.2	4.2	5.2	130	122.5	91	80.5
	VUVS-LK25-M52										
	VUVS-LK25-M32										

Type		H5	H6	H7	H8	H9	H10	H11	H12	H13	H14
VAME-B10-25-A	VUVS-LK25-B52	48.5	41.5	25	11	2.5	201.8	–	204.4	201.8	204.4
	VUVS-LK25-M52							170.3	156		156
	VUVS-LK25-M32								127.4		127.4

Type		H15	L1	L2	L3	L4	L5	L6	L7	L8	L9
VAME-B10-25-A	VUVS-LK25-B52	110.6	55	49.4	40.4	25	40	20	23.5	186.1	4.1
	VUVS-LK25-M52									137.8	
	VUVS-LK25-M32									109.2	

Accessories

Dimensions

Download CAD data → [www.festo.com](http://www.festo.com)

Wall mounting

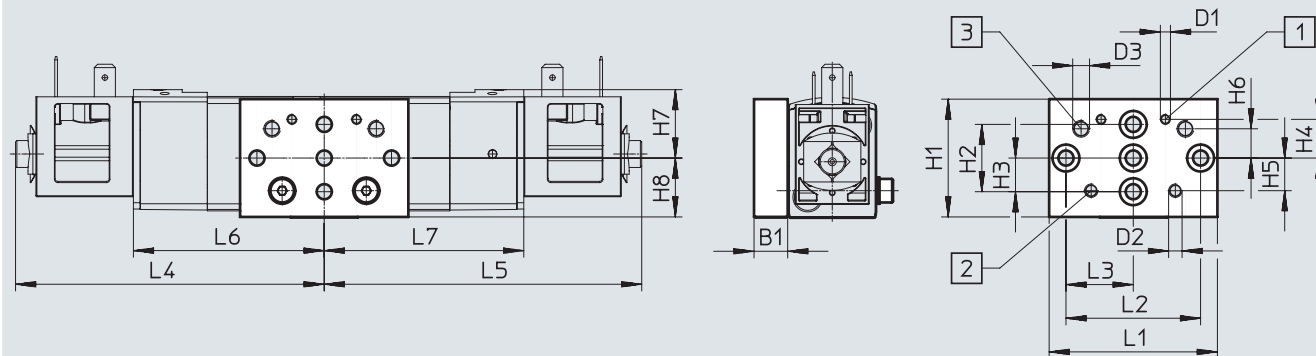

[1] Mounting hole for size 20

[2] Mounting hole for size 25

[3] Mounting hole for size 30

Type		B1	D1	D2	D3	H1	H2	H3	H4	H5	H6
VAME-B10-20-W	VUVS-LK25-B52	10	M3	M4	M5	35	20	10	11.5	9.7	8.7
	VUVS-LK25-M52										
	VUVS-LK25-M32										



Type		H7	H8	L1	L2	L3	L4	L5	L6	L7
VAME-B10-20-W	VUVS-LK25-B52	20.4	17.5	50	40	20	93.1	93.1	56.7	59.3
	VUVS-LK25-M52							44.7		-
	VUVS-LK25-M32							15		-



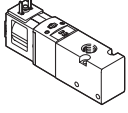
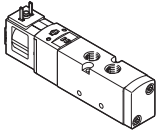
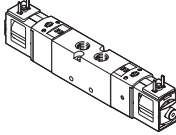

## Accessories

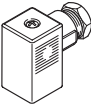
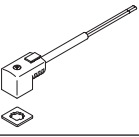
## ★ Core product range

Ordering data				
	Code	Valve function	Part no.	Type
<b>3/2-way valve with solenoid coil (24 V DC)</b>				
	<b>Single solenoid, normally closed, type B</b>			
	M32C-A	Reset via pneumatic spring, internal pilot air supply, flow direction not reversible	★ 8043217	VUVS-LK25-M32C-AD-G14-1B2-S
<b>5/2-way valve with solenoid coil (24 V DC)</b>				
	<b>Single solenoid, type B</b>			
	M52-A	Reset via pneumatic spring, internal pilot air supply, flow direction not reversible	★ 8043218	VUVS-LK25-M52-AD-G14-1B2-S
	<b>Double solenoid, type B</b>			
	B52	Internal pilot air supply, flow direction not reversible	★ 8043219	VUVS-LK25-B52-D-G14-1B2-S

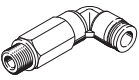

## Accessories

Ordering data		Description	Part no.	Type		
<b>Cover cap</b>						
	For manual override, non-detenting or covered		8049539	VAMC-B10-25-CH2-S		
<b>Plug socket</b>						
	<b>Plug pattern type B, industry standard</b>					
	3-pin, screw terminal	Cable connector M16	0 ... 250 V AC/DC	IP65	539710	MSSD-F-M16
		Cable connector Pg9			★ 34431	MSSD-F
3-pin, insulation displacement connector	–	0 ... 250 V AC/DC	IP67	192746	MSSD-FS-M16	
<b>Plug socket with cable</b>						
	<b>Plug pattern type B, industry standard</b>					
	Angled socket, 3-pin Cable, open end, 3-wire	24 V DC	LED	2.5 m	★ 30935	KMF-1-24DC-2,5-LED
				5 m	30937	KMF-1-24DC-5-LED
				10 m	193458	KMF-1-24-10-LED
<b>Illuminating seal</b>						
	Plug pattern type B, industry standard		24 V DC	19143	MF-LD-12-24DC	

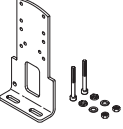
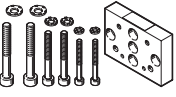
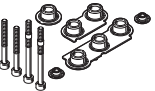

Ordering data		Description	Part no.	Type	PU <sup>1)</sup>	
<b>Push-in fitting with internal hex</b>						
	Connecting thread G1/4 for tubing O.D.		6 mm	★ 186108	QS-G1/4-6-I	10
			8 mm	★ 186110	QS-G1/4-8-I	10
			10 mm	★ 186112	QS-G1/4-10-I	10
<b>Angled push-in fitting with external hex</b>						
	Connecting thread G1/4 for tubing O.D.		6 mm	★ 186118	QSL-G1/4-6	10
				132051	QSL-G1/4-6-100	100
			8 mm	★ 186120	QSL-G1/4-8	10
				132052	QSL-G1/4-8-50	50
			10 mm	★ 186122	QSL-G1/4-10	10
132053	QSL-G1/4-10-50	50				
<b>Angled push-in fitting, long, with external hex</b>						
	Connecting thread G1/4 for tubing O.D.		6 mm	186129	QSL-G1/4-6	10
			8 mm	186131	QSL-G1/4-8	10
			10 mm	186133	QSL-G1/4-10	10
<b>Silencer</b>						
	With connecting thread G, polymer design		G1/4	★ 2316	U-1/4	1
				534223	U-1/4-20	20
	With connecting thread G, metal design		G1/4	6842	U-1/4-B	1

1) Packaging unit

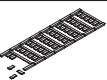
## Accessories

Ordering data	Description	Weight [g]	Part no.	Type
<b>Foot mounting</b>				
	With screw set for attaching the valve to the foot mounting	130	<b>2293485</b>	<b>VAME-B10-25-A</b>
<b>Wall mounting</b>				
	With screw set for attaching the valve to the wall mounting	53	<b>576413</b>	<b>VAME-B10-20-W</b>
<b>Assortment of spare parts</b>				
	Set comprising seals and screws	12	<b>8035636</b>	<b>VAME-B10-25-MK</b>
<b>Screw set</b>				
	For mounting valves VUVS-LK on common supply manifolds, comprising 2 screws M4x40	9.6	<b>8068789</b>	<b>VAME-B10-25-S</b>
<b>Inscription label</b>				
	40 pieces in frame	-	<b>565306</b>	<b>ASLR-C-E4</b>

## Technical data

-  - Flow rate  
up to 1600 l/min
-  - Valve width  
31 mm
-  - Voltage  
24 V DC

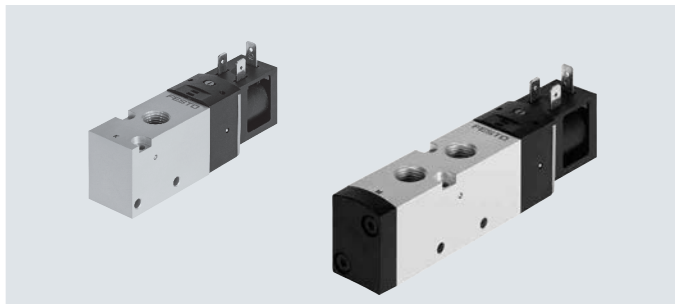

General technical data			
Valve function		3/2-way valve	5/2-way valve
Order code for valves		M32C	M52 B52
Valve width	[mm]	31	
Nominal width	Diameter [mm]	8.1	
Design		Piston spool	
Flow direction		Non-reversible	
Pilot air supply		Internal	
Type of control		Piloted	
Manual override		Non-detenting, detenting	
Overlap		Positive overlap	
Sealing principle		Soft	
Type of mounting		Optionally via through-hole or on manifold rail	
Standard nominal flow rate q <sub>N</sub>	[l/min]	1600	1600
Actuation type		Electric	
Mounting position		Any	
Exhaust air function		Can be throttled	
Connection for venting hole		Not ducted	
b value		0.37	
c value	[l/sbar]	7.03	
Pneumatic connection	1, 2, 3 4, 5	G3/8 -	G3/8 G3/8

Technical data – 3/2-way valves		
Order code for valves		M32C
Normal position		Closed
Stable position		Monostable
Reset method		Pneumatic spring
Switching times in [ms]	On	16
	Off	20
	Change over	-
Product weight with solenoid coil	[g]	250
Product weight with solenoid coil and plug socket	[g]	274

## Technical data

Technical data – 5/2-way valves			
Order code for valves		M52	B52
Normal position		–	–
Stable position		Monostable	Bistable
Reset method		Pneumatic spring	–
Switching times in [ms]	On	16	–
	Off	21	–
	Change over	–	10
Product weight with solenoid coil	[g]	315	392
Product weight with solenoid coil and plug socket	[g]	339	416

Safety data		
Max. positive test pulse with logic 0	[is]	2500
Max. negative test pulse with logic 1	[is]	1100
Shock resistance	Shock test with severity level 1 to FN 942017-5 and EN 60068-2-27	
Vibration resistance	Transport application test with severity level 2 to FN 942017-4 and EN 60068-2-6	

Operating and environmental conditions				
Order code for valves		M32C	M52	B52
Operating medium		Compressed air to ISO 8573-1:2010 [7:4:4]		
Pilot medium		Compressed air to ISO 8573-1:2010 [7:4:4]		
Note on operating/pilot medium		Lubricated operation possible (in which case lubricated operation will always be required)		
Operating pressure	[MPa]	0.15 ... 0.8	0.15 ... 0.8	0.15 ... 0.8
	[bar]	1.5 ... 8	1.5 ... 8	1.5 ... 8
Ambient temperature	[°C]	–5 ... +50		
Temperature of medium	[°C]	–5 ... +50		
Corrosion resistance class CRC <sup>1)</sup>		1		

1) Corrosion resistance class CRC 1 to Festo standard FN 940070

Low corrosion stress. Dry indoor application or transport and storage protection. Also applies to parts behind coverings, in the non-visible interior area, and parts which are covered in the application (e.g. drive trunnions).

Electrical data	
Electrical connection	Plug type B to industry standard (11 mm)
Operating voltage	[V DC] 24
Permissible voltage fluctuations	[%] 10
Power	[W] 3.3
Duty cycle	[%] 100
Degree of protection to EN 60529	IP65 with plug socket

Materials	
Housing	Wrought aluminium alloy
Seals	HNBR, NBR
Piston spool	Wrought aluminium alloy
Note on materials	RoHS-compliant
	Contains paint-wetting impairment substances

## Technical data

### Dimensions

Download CAD data → [www.festo.com](http://www.festo.com)

3/2-way valves, with solenoid coil

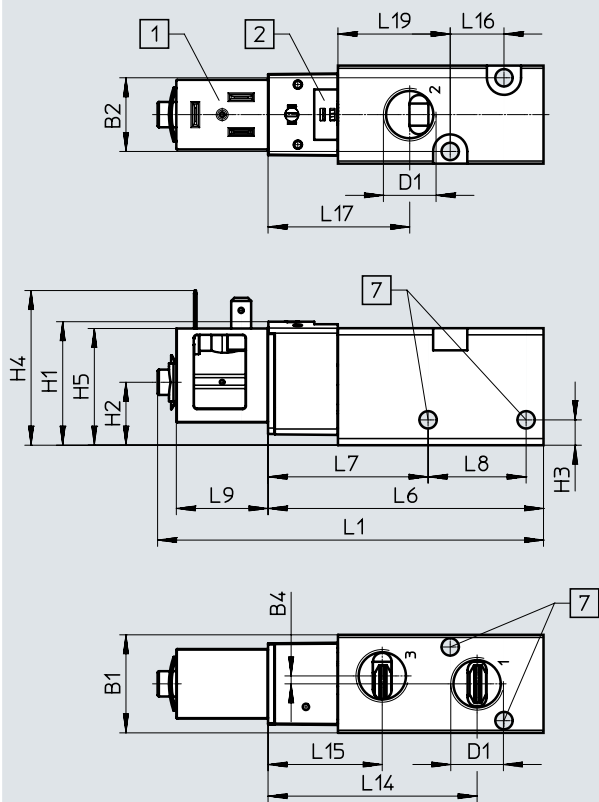

[1] Solenoid coil interface type B

[2] Space for inscription label

[7] For screw M5

Type	B1	B2	B4	D1	H1	H2	H3	H4	H5
VUVS-LK30-M32C-AD-G38-1B2-S	31	23.3	2.5	G3/8	39.1	19.9	8	48.9	36.9

Type	L1	L6	L7	L8	L9	L14	L15	L16	L17	L19
VUVS-LK30-M32C-AD-G38-1B2-S	122.1	87.1	50.6	31	29	66.1	36.1	17	44.8	57.6



## Technical data

### Dimensions

Download CAD data → [www.festo.com](http://www.festo.com)

5/2-way single solenoid valves, with solenoid coil

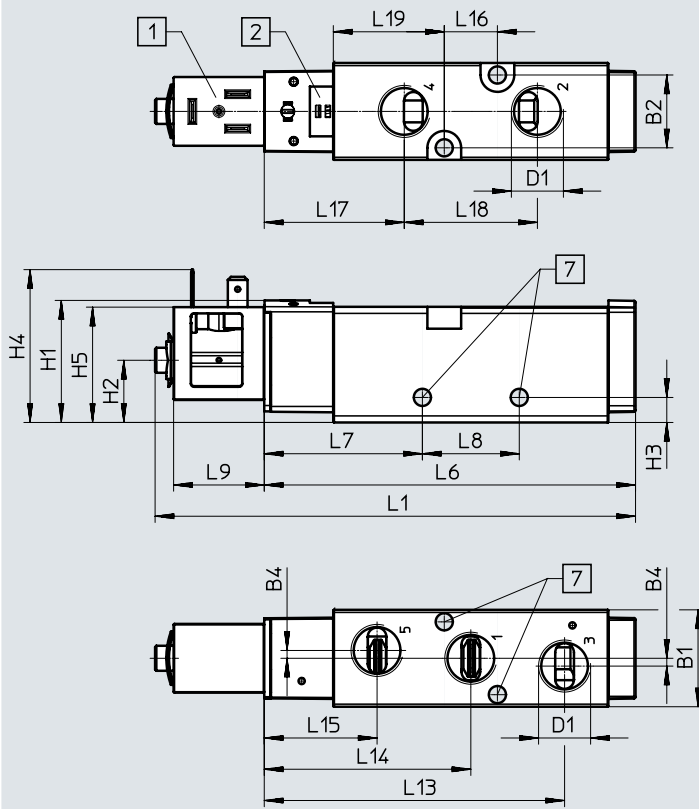

[1] Solenoid coil interface type B

[2] Space for inscription label

[7] For screw M5

Type	B1	B2	B4	D1	H1	H2	H3	H4	H5
VUVS-LK30-M52-AD-G38-1B2-S	31	23.3	2.5	G3/8	39.1	19.9	8	48.9	36.9

Type	L1	L6	L7	L8	L9	L13	L14	L15	L16	L17	L18	L19
VUVS-LK30-M52-AD-G38-1B2-S	153.8	118.8	50.6	31	29	96.1	66.1	36.1	17	44.8	42.6	57.6

## Technical data

### Dimensions

Download CAD data → [www.festo.com](http://www.festo.com)

5/2-way double solenoid valves, with solenoid coil

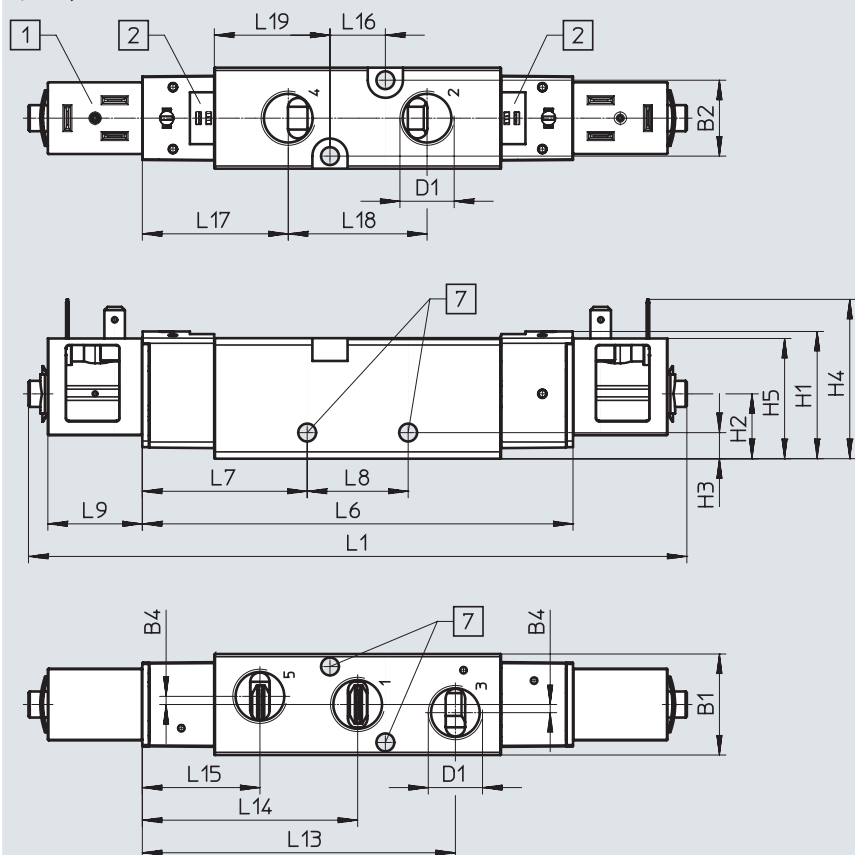

[1] Solenoid coil interface type B

[2] Space for inscription label

[7] For screw M5

Type	B1	B2	B4	D1	H1	H2	H3	H4	H5
VUVS-LK30-B52-D-G38-1B2-S	31	23.3	2.5	G3/8	39.1	19.9	8	48.9	36.9

Type	L1	L6	L7	L8	L9	L13	L14	L15	L16	L17	L18	L19
VUVS-LK30-B52-D-G38-1B2-S	202.1	132.2	50.6	31	29	96.1	66.1	36.1	17	44.8	42.6	57.6

Accessories

Dimensions

Download CAD data → [www.festo.com](http://www.festo.com)

Foot mounting

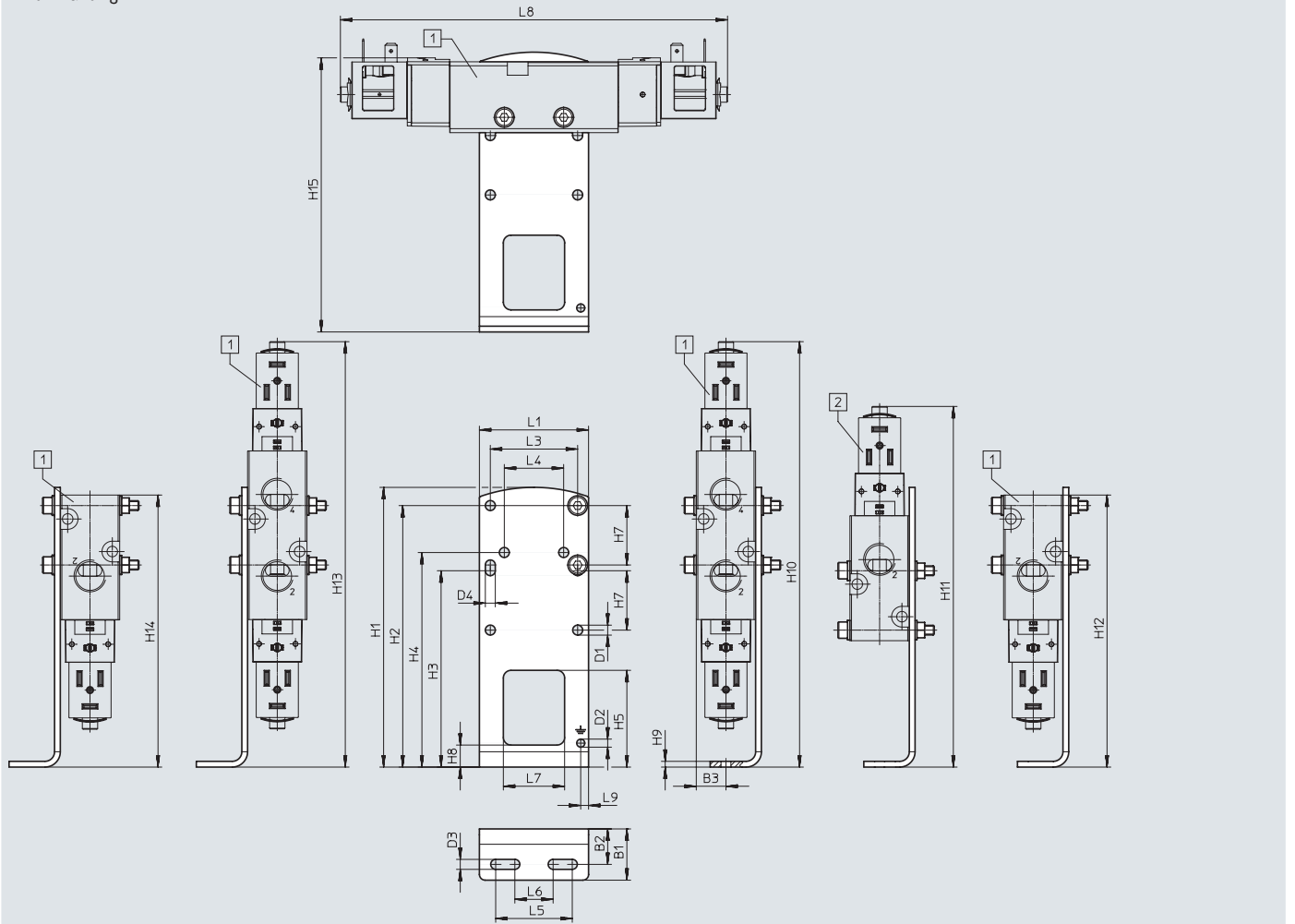

[1] VUVS-LK30-B52,  
VUVS-LK30-M52,  
VUVS-LK30-M32

[2] VUVS-LK30-M52,  
VUVS-LK30-M32

Type		B1	B2	B3	D1 ∅	D2 ∅	D3	D4	H1	H2	H3
VAME-B10-30-A	VUVS-LK30-B52	26.8	18.5	15.5	5.2	4.2	5.2	5.2	146	136.5	102.5
	VUVS-LK30-M52										
	VUVS-LK30-M32										

Type		H4	H5	H7	H8	H9	H10	H11	H12	H13	H14
VAME-B10-30-A	VUVS-LK30-B52	112	50.5	31	11.5	3	222	-	222.1	222	222.1
	VUVS-LK30-M52							188	173.8		173.8
	VUVS-LK30-M32								142.1		142.1

Type		H15	L1	L3	L4	L5	L6	L7	L8	L9
VAME-B10-30-A	VUVS-LK30-B52	143.1	57	45.6	31	40	20	32	202.1	4.1
	VUVS-LK30-M52								153.8	
	VUVS-LK30-M32								122.1	

Accessories

Dimensions Download CAD data → [www.festo.com](http://www.festo.com)

Wall mounting

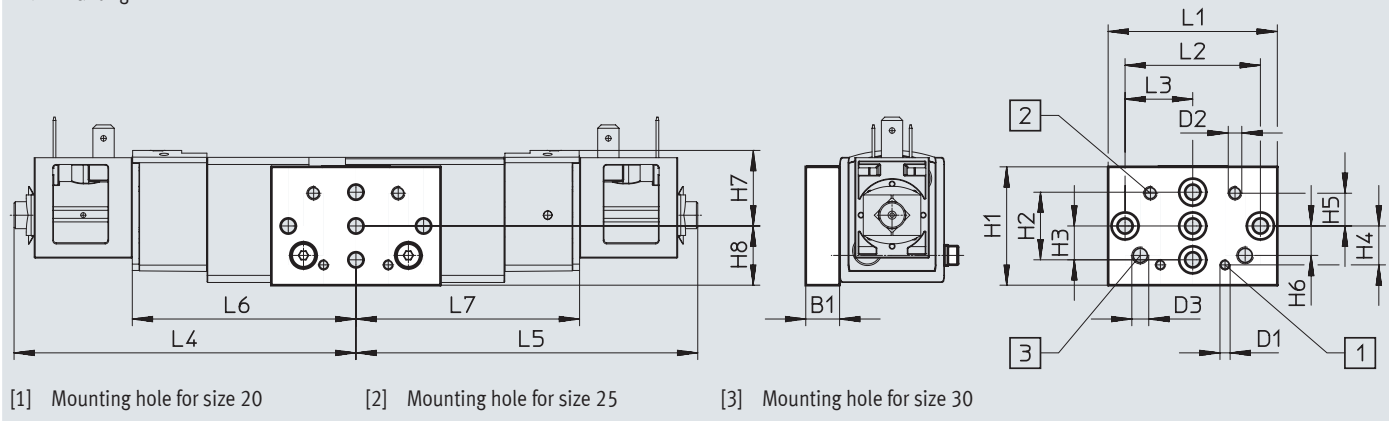





Type		B1	D1	D2	D3	H1	H2	H3	H4	H5	H6
VAME-B10-20-W	VUVS-LK30-B52	10	M3	M4	M5	35	20	10	11.5	9.7	8.7
	VUVS-LK30-M52										
	VUVS-LK30-M32										

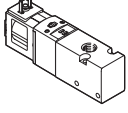
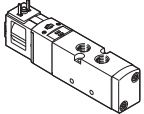
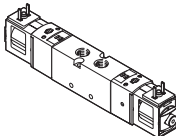

Type		H7	H8	L1	L2	L3	L4	L5	L6	L7
VAME-B10-20-W	VUVS-LK30-B52	22.4	17.5	50	40	20	101.1	101.1	66.1	66.1
	VUVS-LK30-M52							52.7		-
	VUVS-LK30-M32							21		-

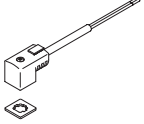
## Accessories

## ★ Core product range

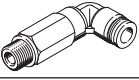
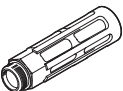

Ordering data		Code	Valve function	Part no.	Type	
<b>3/2-way valve with solenoid coil (24 V DC)</b>						
	<b>Single solenoid, normally closed, type B</b>					
	M32C-A	Reset via pneumatic spring, internal pilot air supply, flow direction not reversible	★ 8049880	VUVS-LK30-M32C-AD-G38-1B2-S		
<b>5/2-way valve with solenoid coil (24 V DC)</b>						
	<b>Single solenoid, type B</b>					
	M52-A	Reset via pneumatic spring, internal pilot air supply, flow direction not reversible	★ 8049881	VUVS-LK30-M52-AD-G38-1B2-S		
	<b>Double solenoid, type B</b>					
	B52	Internal pilot air supply, flow direction not reversible	★ 8049882	VUVS-LK30-B52-D-G38-1B2-S		
Ordering data		Description	Part no.	Type		
<b>Cover cap</b>						
	For manual override, non-detenting or covered		8049539	VAMC-B10-25-CH2-S		
<b>Plug socket</b>						
	<b>Plug pattern type B, industry standard</b>					
	3-pin, screw terminal	Cable connector M16	0 ... 250 V AC/DC	IP65	539710	MSSD-F-M16
		Cable connector Pg9			★ 34431	MSSD-F
3-pin, insulation displacement connector	–	0 ... 250 V AC/DC	IP67	192746	MSSD-F-S-M16	
<b>Plug socket with cable</b>						
	<b>Plug pattern type B, industry standard</b>					
	Angled socket, 3-pin Cable, open end, 3-wire	24 V DC	LED	2.5 m	★ 30935	KMF-1-24DC-2,5-LED
				5 m	30937	KMF-1-24DC-5-LED
				10 m	193458	KMF-1-24-10-LED
<b>Illuminating seal</b>						
	Plug pattern type B, industry standard		24 V DC	19143	MF-LD-12-24DC	

## Accessories

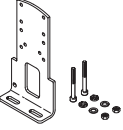
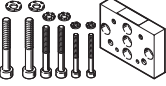
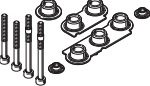

Ordering data	Description		Part no.	Type	PU <sup>1)</sup>
<b>Push-in fitting with internal hex</b>					
	Connecting thread G3/8 for tubing O.D.	6 mm	★ 186111	QS-G3/8-8-I	10
		8 mm	★ 186113	QS-G3/8-10-I	10
		10 mm	★ 186114	QS-G3/8-12-I	10
<b>Angled push-in fitting with external hex</b>					
	Connecting thread G3/8 for tubing O.D.	8 mm	★ 186121	QSL-G3/8-8	10
			132055	QSL-G3/8-8-50	50
		10 mm	★ 186123	QSL-G3/8-10	10
			132056	QSL-G3/8-10-20	20
<b>Angled push-in fitting, long, with external hex</b>					
	Connecting thread G3/8 for tubing O.D.	8 mm	186132	QSL-G3/8-8	10
		10 mm	186134	QSL-G3/8-10	10
<b>Silencer</b>					
	With connecting thread G, metal design	G3/8	6843	U-3/8-B	1

1) Packaging unit

## Accessories

Ordering data	Description	Weight [g]	Part no.	Type
<b>Foot mounting</b>				
	With screw set for attaching the valve to the foot mounting	239	8026337	VAME-B10-30-A
<b>Wall mounting</b>				
	With screw set for attaching the valve to the wall mounting	53	576413	VAME-B10-20-W
<b>Assortment of spare parts</b>				
	Set comprising seals and screws	22	8035637	VAME-B10-30-MK
<b>Screw set</b>				
	For mounting valves VUVS-LK on common supply manifolds, comprising 2 screws M5x40	15.5	8068790	VAME-B10-30-S
<b>Inscription label</b>				
	40 pieces in frame	-	565306	ASLR-C-E4

## Technical data

-  - Flow rate  
up to 600 l/min
-  - Valve width  
21 mm
-  - Voltage  
24 V DC

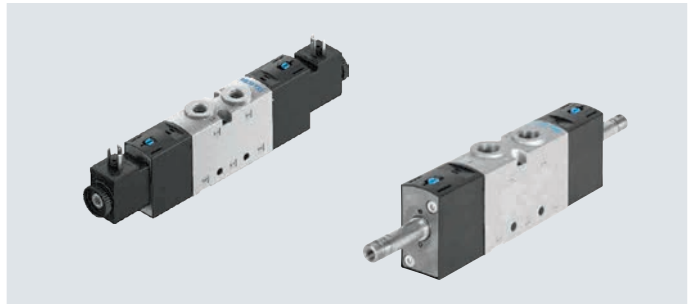

General technical data		3/2-way valve					5/2-way valve	
Valve function								
Order code for valves		M32C	M32U	T32C	T32U	T32H	M52	B52
Valve width	[mm]	21						
Nominal width	Diameter [mm]	5.2	5.2	5.2	5.2	5.2	5	5
Design		Poppet seat						
Flow direction		Non-reversible						
Pilot air supply		Internal or external						
Type of control		Piloted						
Manual override		Non-detenting, detenting						
Overlap		Negative overlap						
Sealing principle		Soft						
Type of mounting		Optionally via through-hole or on manifold rail						
Standard nominal flow rate q <sub>N</sub>	[l/min]	600					500	
Actuation type		Electric						
Mounting position		Any						
Exhaust air function		Can be throttled						
Connection for venting hole		Not ducted						
b value		0.39	0.29	0.39	0.29	0.34	0.31	0.27
c value		2.3	2.3	2.3	2.3	2.3	2.1	2.1
Pneumatic connection	1, 2, 3 4, 5	G1/8 -	G1/8 -	G1/8 G1/8	G1/8 G1/8	G1/8 G1/8	G1/8 G1/8	G1/8 G1/8
Pilot air port 12, 14		M5	M5	M5	M5	M5	M5	M5
Pilot exhaust air connection 82, 84		M5	M5	M5	M5	M5	M5	M5
Corrosion resistance <sup>1)</sup>		2						

1) Corrosion resistance class CRC 2 to Festo standard FN 940070  
Moderate corrosion stress. Indoor applications in which condensation can occur. External visible parts with primarily decorative surface requirements which are in direct contact with a normal industrial environment.

ATEX	
Type	VUVS-LT-...-EX2
ATEX category for gas	II 3G
Type of ignition protection for gas	Ex ec IICT4 Gc X
ATEX category for dust	II 3D
Type of ignition protection for dust	Ex tc IIIC T115°C Dc X
Explosion-proof ambient temperature [°C]	-10°C ≤ Ta ≤ +60°C
CE marking (see declaration of conformity) <sup>1)</sup>	To EU Explosion Protection Directive (ATEX)
UKCA marking (see declaration of conformity) <sup>1)</sup>	To UK EX instructions
Explosion protection certification outside the EU	EPL Dc (GB) EPL Gc (GB)

1) For information about the area of use, see the EC declaration of conformity at: [www.festo.com/catalogue/...](http://www.festo.com/catalogue/...) → Support/Downloads.  
If the devices are subject to usage restrictions in residential, commercial or light-industrial environments, further measures for the reduction of the emitted interference may be necessary.



## Technical data

Technical data		M32C	M32U	T32C	T32U	T32H	M52	B52
Order code for valves		M32C	M32U	T32C	T32U	T32H	M52	B52
Normal position		Closed	Open	2x closed	2x open	1x open/ 1x closed	–	–
Stable position		Monostable	Monostable	Monostable	Monostable	Monostable	Monostable	Bistable
Reset method		Mechanical spring		Mechanical spring			Mechanical spring	–
Switching times in [ms]	On	9	10	9	9	9	15	–
	Off	23	24	25	23	23	19	–
	Change over	–	–	–	–	–	–	8
Product weight without solenoid coil	[g]	112	112	180	180	180	167	181
Product weight with solenoid coil	[g]	146	146	245	245	245	200	248

Safety data		
Max. positive test pulse with logic 0	[s]	1900
Max. negative test pulse with logic 1	[s]	2700
Shock resistance		Shock test with severity level 2 to FN 942017-5 and EN 60068-2-27
Vibration resistance		Transport application test with severity level 2 to FN 942017-4 and EN 60068-2-6

Operating and environmental conditions		M32C	M32U	T32C	T32U	T32H	M52	B52
Order code for valves		M32C	M32U	T32C	T32U	T32H	M52	B52
Operating medium		Compressed air to ISO 8573-1:2010 [7:4:4]						
Pilot medium		Compressed air to ISO 8573-1:2010 [7:4:4]						
Note on operating/pilot medium		Lubricated operation possible (in which case lubricated operation will always be required)						
Operating pressure with internal pilot air supply	[MPa]	0.25 ... 1				0.3 ... 1		0.15 ... 1
	[bar]	2.5 ... 10				3 ... 10		1.5 ... 10
Operating pressure with external pilot air supply	[MPa]	–0.09 ... 1				0.25 ... 1		0.15 ... 1
	[bar]	–0.9 ... 10				2.5 ... 10		1.5 ... 10
Pilot pressure	[MPa]	0.25 ... 1				0.25 ... 1		0.15 ... 1
	[bar]	2.5 ... 10				2.5 ... 10		1.5 ... 10
Ambient temperature	[°C]	–5 ... +60				–10 ... +60		
Temperature of medium	[°C]	–10 ... +60				–10 ... +60		
Certification		c UL us - Recognized (OL)						

Electrical data		With solenoid coil	Without solenoid coil
Electrical connection		Plug type C to EN 175301-803	
Operating voltage	[V DC]	24	Via solenoid coil → Internet: vacf
Permissible voltage fluctuations	[%]	10	
Power	[W]	2.6	
Duty cycle	[%]	100	
Degree of protection to IEC 60529		IP65 with plug socket to IEC60529	

Materials	
Housing	Die-cast aluminium (painted)
Seals	HNBR, NBR, TPE-U(PU)
Screws	Galvanised steel
Note on materials	RoHS-compliant

Technical data

Dimensions

Download CAD data → [www.festo.com](http://www.festo.com)

3/2-way valves, with solenoid coil

3/2-way valves, without solenoid coil

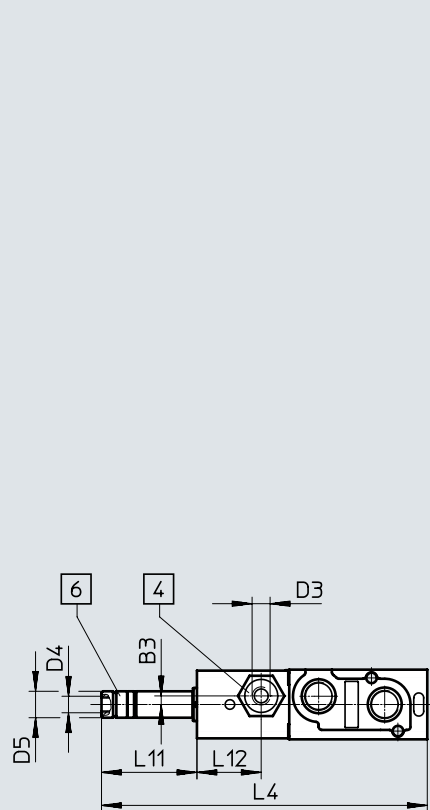
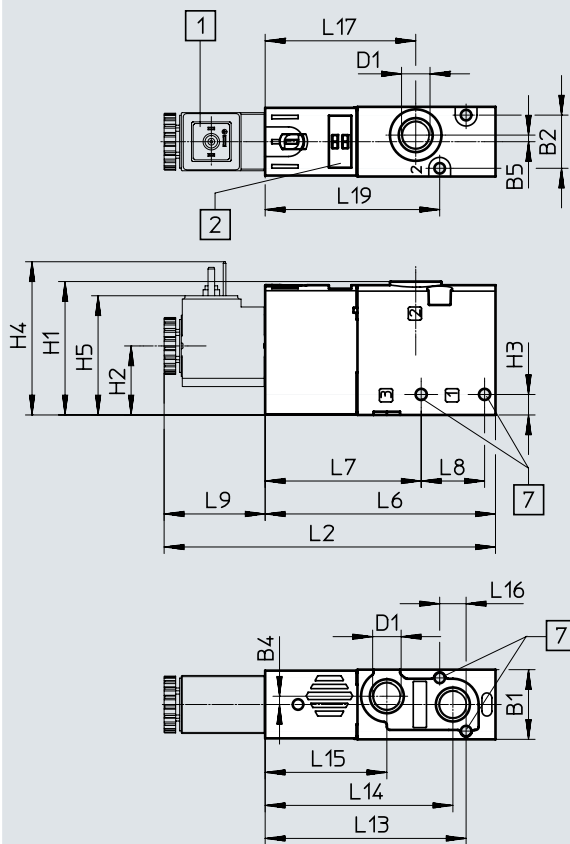

- [1] Solenoid coil interface type C
- [2] Space for inscription label
- [4] Port 10/12 for pilot air supply
- [6] Port 82 for pilot exhaust air
- [7] For screw M3

Type	B1	B2	B3	B4	B5	D1	D3	D4	D5 ∅	H1	H2	H3	H4	H5
VUVS-LT20-M32...MD-G18-...	21.1	16.1	-	2.5	2	G1/8	-	M5	8	40.4	20.9	6.2	46.7	36.4
VUVS-LT20-M32...MZD-G18-...			2.6				M5							

Type	L2	L4	L6	L7	L8	L9	L11	L12	L13	L14	L15	L16	L17	L19
VUVS-LT20-M32...MD-G18-...	100.4	98.8	69.8	47.3	19.2	30.6	29	-	60.9	56.9	36.9	8	45.6	52.9
VUVS-LT20-M32...MZD-G18-...								19.5						

Technical data

Dimensions

Download CAD data → [www.festo.com](http://www.festo.com)

5/2-way single solenoid valves, with solenoid coil

5/2-way single solenoid valves, without solenoid coil

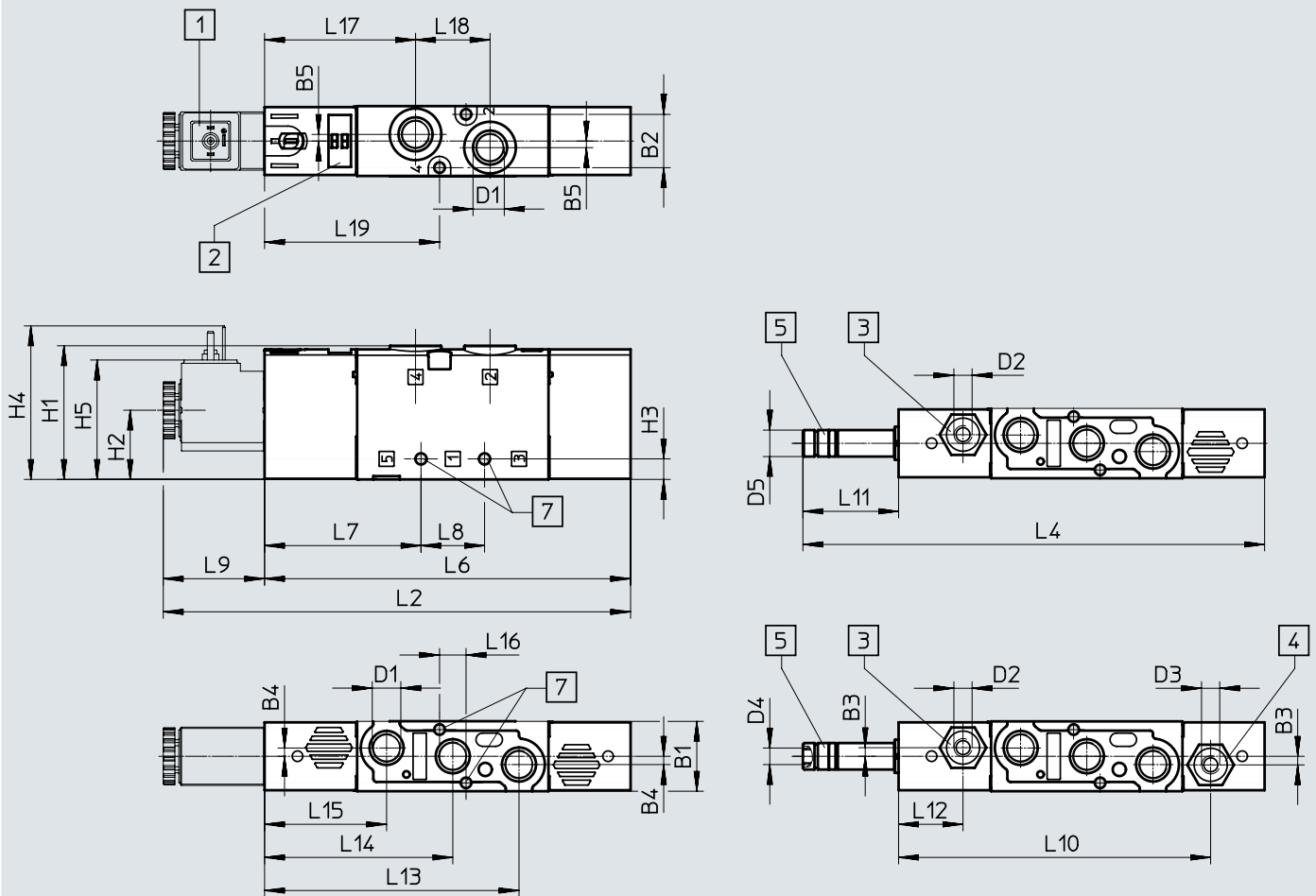

- [1] Solenoid coil for interface type C
- [2] Space for inscription label
- [3] Port 14 for pilot air supply
- [4] Port 12 for pilot air supply (pneumatic spring)
- [5] Port 84 for pilot exhaust air
- [6] For screw M3
- [7] For screw M4

Type	B1	B2	B3	B4	B5	D1	D2	D3	D4	D5 ∅	H1	H2	H3	H4	H5
VUVS-LT20-M52-...MD-G18-...	21.1	16.1	-	2.5	2	G1/8	-	-	M5	8	40.4	20.9	5.8	46.7	36.4
VUVS-LT20-M52-...MZD-G18-...			2.6				M5	M5							

Type	L2	L4	L6	L7	L8	L9	L10	L11	L12	L13	L14	L15	L16	L17	L18	L19	L20
VUVS-LT20-M52-...MD-G18-...	141.2	139.6	110.6	47.9	18	30.6	-	29	-	76.9	56.9	36.9	8	45.6	22.5	52.9	2
VUVS-LT20-M52-...MZD-G18-...							94.3		19.5								

Technical data

Dimensions

Download CAD data → [www.festo.com](http://www.festo.com)

2x 3/2-way valves and 5/2-way double solenoid valves, with solenoid coil

2x 3/2-way valves and 5/2-way double solenoid valves, without solenoid coil

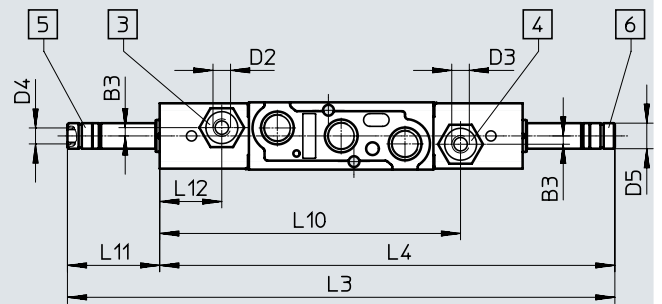
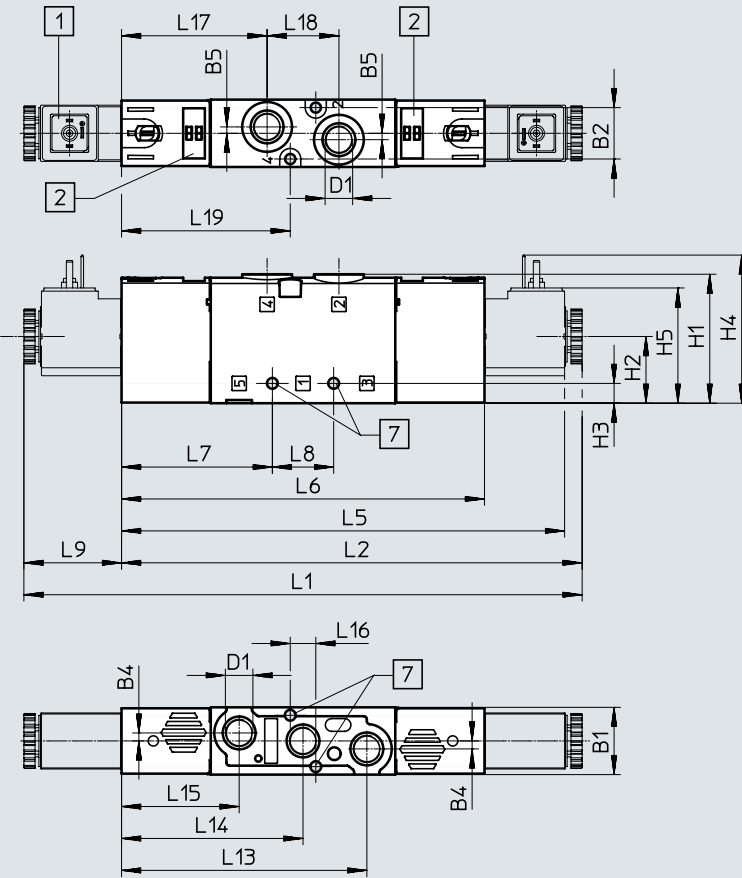

- [1] Solenoid coil interface type C
- [2] Space for inscription label
- [3] Port 14 for pilot air supply
- [4] Port 12 for pilot air supply

- [5] Port 84 for pilot exhaust air
- [6] Port 82 for pilot exhaust air
- [7] For screw M3
- [8] For screw M4

Type	B1	B2	B3	B4	B5	D1	D2	D3	D4	D5 ∅	H1
VUVS-LT20-B52-D-G18-...	21.1	16.1	-	2.5	2	G1/8	-	-	M5	8	40.4
VUVS-LT20-B52-ZD-G18-...			2.6				M5	M5			
VUVS-LT20-T32...-MD-G18-...			-				-	-			
VUVS-LT20-T32...-MZD-G18-...			2.6				M5	M5			

Type	H2	H3	H4	H5	L1	L2	L3	L4	L5	L6	L7	L8
VUVS-LT20-B52-D-G18-...	20.9	5.8	46.7	36.4	174.9	144.3	171.7	142.7	139.1	113.7	47.9	18
VUVS-LT20-B52-ZD-G18-...												
VUVS-LT20-T32...-MD-G18-...												
VUVS-LT20-T32...-MZD-G18-...												

Type	L9	L10	L11	L12	L13	L14	L15	L16	L17	L18	L19	L20
VUVS-LT20-B52-D-G18-...	30.6	-	29	-	76.9	56.9	36.9	8	45.6	22.5	52.9	2
VUVS-LT20-B52-ZD-G18-...		94.3		19.5								
VUVS-LT20-T32...-MD-G18-...		-		-								
VUVS-LT20-T32...-MZD-G18-...		94.3		19.5								

## Accessories

## Dimensions

Download CAD data → [www.festo.com](http://www.festo.com)

Foot mounting

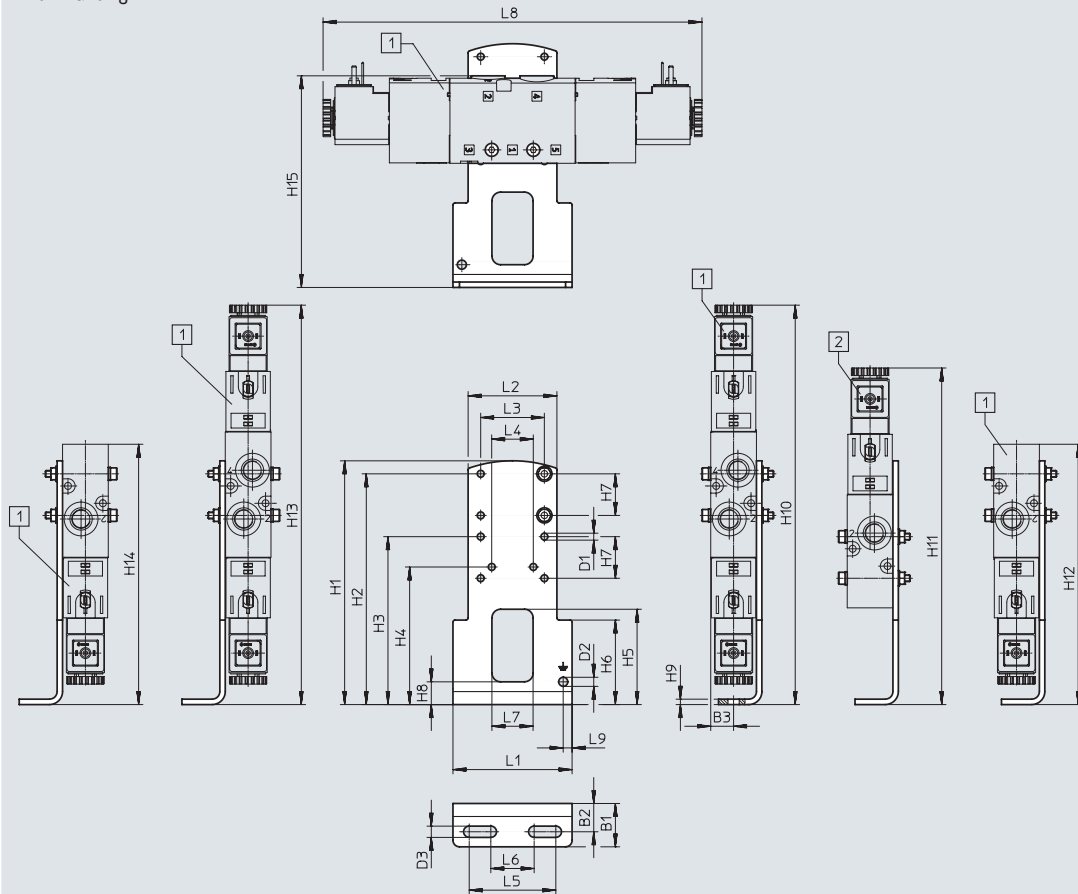

[1] VUVS-LT20-B52/T32  
 VUVS-LT20-M52  
 VUVS-LT20-M32

[2] VUVS-LT20-M52  
 VUVS-LT20-M32

Type		B1	B2	B3	D1 ∅	D2 ∅	D3	H1	H2	H3	H4
VAME-B10-20-A	VUVS-LT20-B52/T32	20	13.1	10.6	3.2	4.2	5.2	112.5	106.5	77.5	63.5
	VUVS-LT20-M52										
	VUVS-LT20-M32										

Type		H5	H6	H7	H8	H9	H10	H11	H12	H13	H14
VAME-B10-20-A	VUVS-LT20-B52/T32	44	39	19.2	10.5	2.5	184.4	–	184.4	184.4	184.4
	VUVS-LT20-M52							155.4	150.6	150.6	
	VUVS-LT20-M32								109.8	109.8	

Type		H15	L1	L2	L3	L4	L5	L6	L7	L8	L9
VAME-B10-20-A	VUVS-LT20-B52/T32	97.7	55	41	29.4	19.2	40	20	19	174.9	4.1
	VUVS-LT20-M52									141.2	
	VUVS-LT20-M32									100.4	

Accessories

Dimensions

Download CAD data → [www.festo.com](http://www.festo.com)

Wall mounting

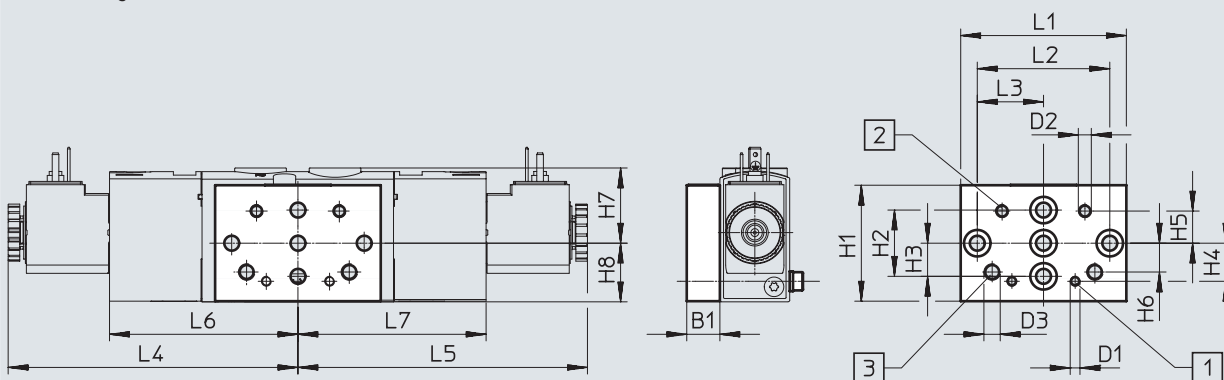

[1] Mounting hole for size 20

[2] Mounting hole for size 25

[3] Mounting hole for size 30

Type		B1	D1	D2	D3	H1	H2	H3	H4	H5	H6
VAME-B10-20-W	VUVS-LT20-B52/T32	10	M3	M4	M5	35	20	10	11.5	9.7	8.7
	VUVS-LT20-M52										
	VUVS-LT20-M32										

Type		H7	H8	L1	L2	L3	L4	L5	L6	L7
VAME-B10-20-W	VUVS-LT20-B52/T32	22.7	17.7	50	40	20	87.5	87.5	56.9	56.9
	VUVS-LT20-M52							53.7		-
	VUVS-LT20-M32							12.9		-

## Accessories

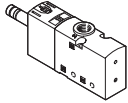
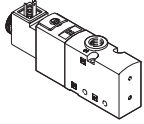
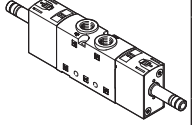

Ordering data		Code	Valve function	Part no.	Type
<b>3/2-way valve without solenoid coil (24 V DC)</b>					
	<b>Single solenoid, normally closed</b>				
	M32C-M	Reset via mechanical spring, internal pilot air supply, flow direction not reversible	577490	VUVS-LT20-M32C-MD-G18-F7	
		Reset via mechanical spring, external pilot air supply, flow direction not reversible	577491	VUVS-LT20-M32C-MZD-G18-F7	
	<b>Single solenoid, normally open</b>				
	M32U-M	Reset via mechanical spring, internal pilot air supply, flow direction not reversible	577492	VUVS-LT20-M32U-MD-G18-F7	
		Reset via mechanical spring, external pilot air supply, flow direction not reversible	577493	VUVS-LT20-M32U-MZD-G18-F7	
<b>3/2-way valve with solenoid coil (24 V DC)</b>					
	<b>Single solenoid, normally closed, type C</b>				
	M32C-M	Reset via mechanical spring, internal pilot air supply, flow direction not reversible	577511	VUVS-LT20-M32C-MD-G18-F7-1C1	
		Reset via mechanical spring, external pilot air supply, flow direction not reversible	577512	VUVS-LT20-M32C-MZD-G18-F7-1C1	
	<b>Single solenoid, normally open, type C</b>				
	M32U-M	Reset via mechanical spring, internal pilot air supply, flow direction not reversible	577513	VUVS-LT20-M32U-MD-G18-F7-1C1	
		Reset via mechanical spring, external pilot air supply, flow direction not reversible	577514	VUVS-LT20-M32U-MZD-G18-F7-1C1	
<b>2x 3/2-way valve without solenoid coil (24 V DC)</b>					
	<b>Single solenoid, normally closed</b>				
	T32C	Reset via mechanical spring, internal pilot air supply, flow direction not reversible	577498	VUVS-LT20-T32C-MD-G18-F7	
		Reset via mechanical spring, external pilot air supply, flow direction not reversible	577499	VUVS-LT20-T32C-MZD-G18-F7	
	<b>Single solenoid, normally open</b>				
	T32U	Reset via mechanical spring, internal pilot air supply, flow direction not reversible	577500	VUVS-LT20-T32U-MD-G18-F7	
		Reset via mechanical spring, external pilot air supply, flow direction not reversible	577501	VUVS-LT20-T32U-MZD-G18-F7	
	<b>Single solenoid, 1x normally open, 1x normally closed</b>				
	T32H	Reset via mechanical spring, internal pilot air supply, flow direction not reversible	577502	VUVS-LT20-T32H-MD-G18-F7	
	Reset via mechanical spring, external pilot air supply, flow direction not reversible	577503	VUVS-LT20-T32H-MZD-G18-F7		





## Accessories

Ordering data		Code	Valve function	Part no.	Type
<b>2x 3/2-way valve with solenoid coil (24 V DC)</b>					
	<b>Single solenoid, normally closed, type C</b>				
	T32C	Reset via mechanical spring, internal pilot air supply, flow direction not reversible	577519	VUVS-LT20-T32C-MD-G18-F7-1C1	
		Reset via mechanical spring, external pilot air supply, flow direction not reversible	577520	VUVS-LT20-T32C-MZD-G18-F7-1C1	
	<b>Single solenoid, normally open, type C</b>				
	T32U	Reset via mechanical spring, internal pilot air supply, flow direction not reversible	577521	VUVS-LT20-T32U-MD-G18-F7-1C1	
		Reset via mechanical spring, external pilot air supply, flow direction not reversible	577522	VUVS-LT20-T32U-MZD-G18-F7-1C1	
	<b>Single solenoid, 1x normally open, 1x normally closed, type C</b>				
	T32H	Reset via mechanical spring, internal pilot air supply, flow direction not reversible	577523	VUVS-LT20-T32H-MD-G18-F7-1C1	
	Reset via mechanical spring, external pilot air supply, flow direction not reversible	577524	VUVS-LT20-T32H-MZD-G18-F7-1C1		
<b>5/2-way valve without solenoid coil (24 V DC)</b>					
	<b>Single solenoid</b>				
	M52-M	Reset via mechanical spring, internal pilot air supply, flow direction not reversible	577494	VUVS-LT20-M52-MD-G18-F7	
		Reset via mechanical spring, external pilot air supply, flow direction not reversible	577495	VUVS-LT20-M52-MZD-G18-F7	
	<b>Double solenoid</b>				
	B52	Internal pilot air supply, flow direction not reversible	577496	VUVS-LT20-B52-D-G18-F7	
		External pilot air supply, flow direction not reversible	577497	VUVS-LT20-B52-ZD-G18-F7	
<b>5/2-way valve with solenoid coil (24 V DC)</b>					
	<b>Single solenoid, type C</b>				
	M52-M	Reset via mechanical spring, internal pilot air supply, flow direction not reversible	577515	VUVS-LT20-M52-MD-G18-F7-1C1	
		Reset via mechanical spring, external pilot air supply, flow direction not reversible	577516	VUVS-LT20-M52-MZD-G18-F7-1C1	
	<b>Double solenoid</b>				
	B52	Internal pilot air supply, flow direction not reversible	577517	VUVS-LT20-B52-D-G18-F7-1C1	
		External pilot air supply, flow direction not reversible	577518	VUVS-LT20-B52-ZD-G18-F7-1C1	





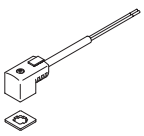



## Accessories

Ordering data		Description	Part no.	Type
<b>Solenoid coils for valves</b>				
	Plug pattern type C, to DIN EN 175301-803	12 V DC	8025331	VACS-C-C1-5
		24 V DC	8025330	VACS-C-C1-1
		48 V DC	8025336	VACS-C-C1-7
		24 V AC/50-60 Hz	8025335	VACS-C-C1-1A
		48 V AC/50-60 Hz	8025337	VACS-C-C1-7A
		110/120 V AC/50-60 Hz	8025334	VACS-C-C1-16B
		230/240 V AC/50-60 Hz	8025338	VACS-C-C1-3W
<b>Seal set</b>				
	For solenoid coil in order to guarantee protection class IP67		2643771	VAMC-B10-C-B-S8
<b>Cover cap</b>				
	For manual override, non-detenting or covered		8028240	VAMC-B10-20-CH2

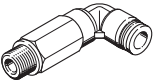

Ordering data		Description	Part no.	Type		
<b>Plug socket</b>						
	<b>Plug pattern type C, to DIN EN 175301-803</b>					
	3-pin, screw terminal	Cable connector M12	0 ... 250 V AC/DC	IP65	539712	MSSD-EB-M12
		Cable connector Pg7			★ 151687	MSSD-EB
	4-pin, insulation displacement connector	Cable connector M14	0 ... 250 V AC/DC	IP67	192745	MSSD-EB-S-M14
3-pin, angled socket	Cable connector M12	0 ... 24 V DC	IP65	570367	MSSD-EB-M12-24VDC-SD-EX	
<b>Adapter</b>						
	Socket type C, to EN 175301-803	Plug connector M12x1, 2-pin, A-coded	12 ... 24 V AC/DC	IP65	188024	MSSD-EB-M12-MONO
<b>Plug socket with cable</b>						
	<b>Plug pattern type C, to DIN EN 175301-803</b>					
	Angled socket, 3-pin Cable, open end, 3-wire	24 V DC	LED	2.5 m	★ 151688	KMEB-1-24-2,5-LED
				5 m	151689	KMEB-1-24-5-LED
				10 m	193457	KMEB-1-24-10-LED
	230 V AC	-	2.5 m	151690	KMEB-1-230AC-2,5	
5 m			151691	KMEB-1-230AC-5		
<b>Illuminating seal</b>						
	Plug pattern type C, to DIN EN 175301-803		24 V DC	151717	MEB-LD-12-24DC	
			230 V AC	151718	MEB-LD-230AC	

## Accessories

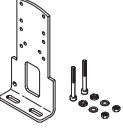
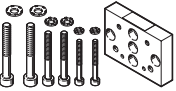

Ordering data	Description	Part no.	Type	PJ <sup>1)</sup>	
<b>Push-in fitting with internal hex</b>					
	Connecting thread M5 for tubing O.D.	4 mm	★ 153315	QSM-M5-4-I	10
	Connecting thread G1/8 for tubing O.D.	4 mm	★ 186106	QS-G1/8-4-I	10
			133008	QS-G1/8-4-I-100	100
		6 mm	★ 186107	QS-G1/8-6-I	10
			133009	QS-G1/8-6-I-100	100
		8 mm	★ 186109	QS-G1/8-8-I	10
			133010	QS-G1/8-8-I-100	100
<b>Angled push-in fitting with external hex</b>					
	Connecting thread G1/8 for tubing O.D.	4 mm	★ 186116	QSL-G1/8-4	10
			132048	QSL-G1/8-4-100	100
		6 mm	★ 186117	QSL-G1/8-6	10
			132049	QSL-G1/8-6-100	100
		8 mm	★ 186119	QSL-G1/8-8	10
			132050	QSL-G1/8-8-50	50
<b>Angled push-in fitting, long, with external hex</b>					
	Connecting thread G1/8 for tubing O.D.	4 mm	186127	QSL-G1/8-4	10
			133015	QSL-G1/8-4-100	100
		6 mm	186128	QSL-G1/8-6	10
			133016	QSL-G1/8-6-100	100
		8 mm	186130	QSL-G1/8-8	10
			133017	QSL-G1/8-8-100	100
<b>Silencer</b>					
	With connecting thread G, Polymer design	G1/8	★ 2307	U-1/8	1
			534222	U-1/8-50	50
	With connecting thread G, Metal version	G1/8	6841	U-1/8-B	1
	With connecting thread G, Sintered design, long	G1/8	★ 1205860	AMTE-M-LH-G18	20

1) Packaging unit

## Accessories

Ordering data	Description	Weight [g]	Part no.	Type
<b>Foot mounting</b>				
	With screw set for attaching the valve to the foot mounting	97	576412	VAME-B10-20-A
<b>Wall mounting</b>				
	With screw set for attaching the valve to the wall mounting	53	576413	VAME-B10-20-W
<b>Assortment of spare parts</b>				
	Set comprising seals and screws	10	8026203	VAME-B10-20-MK
<b>Inscription label</b>				
	40 pieces in frame	-	565306	ASLR-C-E4

## Technical data

-  - Flow rate  
up to 1000 l/min
-  - Valve width  
26.5 mm
-  - Voltage  
24 V DC

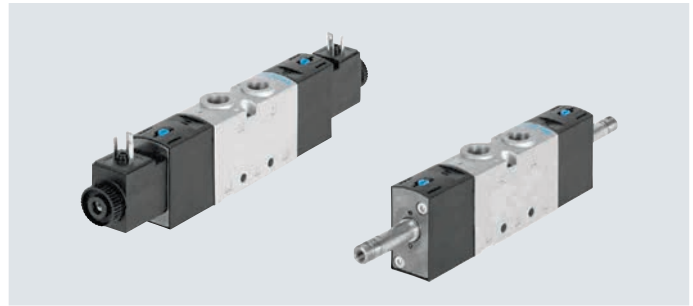

General technical data		3/2-way valve					5/2-way valve	
Valve function								
Order code for valves		M32C	M32U	T32C	T32U	T32H	M52	B52
Valve width	[mm]	26.5						
Nominal width	Diameter [mm]	6.9	6.6	6.9	6.6	6.9	6.6	6.6
Design		Poppet seat						
Flow direction		Non-reversible						
Pilot air supply		Internal or external						
Type of control		Piloted						
Manual override		Non-detenting, detenting						
Overlap		Negative overlap						
Sealing principle		Soft						
Type of mounting		Optionally via through-hole or on manifold rail						
Standard nominal flow rate q <sub>nN</sub>	[l/min]	1000						
Actuation type		Electric						
Mounting position		Any						
Exhaust air function		Can be throttled						
Connection for venting hole		Not ducted						
b value		0.4	0.3	0.4	0.3	0.4	0.3	0.2
c value	[l/sbar]	4.4	4.2	4.5	4.4	4.4	4.5	4.6
Pneumatic connection	1, 2, 3 4, 5	G1/4 -	G1/4 -	G1/4 G1/4	G1/4 G1/4	G1/4 G1/4	G1/4 G1/4	G1/4 G1/4
Pilot air port 12, 14		M5	M5	M5	M5	M5	M5	M5
Pilot exhaust air connection 82, 84		M5	M5	M5	M5	M5	M5	M5

ATEX	
Type	VUVS-LT-...-EX2
ATEX category for gas	II 3G
Type of ignition protection for gas	Ex ec IIC T4 Gc X
ATEX category for dust	II 3D
Type of ignition protection for dust	Ex tc IIIC T115°C Dc X
Explosion-proof ambient temperature [°C]	-10°C ≤ Ta ≤ +60°C
CE marking (see declaration of conformity) <sup>1)</sup>	To EU Explosion Protection Directive (ATEX)
UKCA marking (see declaration of conformity) <sup>1)</sup>	To UK EX instructions
Explosion protection certification outside the EU	EPL Dc (GB)
	EPL Gc (GB)

<sup>1)</sup> For information about the area of use, see the EC declaration of conformity at: [www.festo.com/catalogue/...](http://www.festo.com/catalogue/...) → Support/Downloads.  
If the devices are subject to usage restrictions in residential, commercial or light-industrial environments, further measures for the reduction of the emitted interference may be necessary.

## Technical data

Technical data		M32C	M32U	T32C	T32U	T32H	M52	B52
Order code for valves		M32C	M32U	T32C	T32U	T32H	M52	B52
Normal position		Closed	Open	2x closed	2x open	1x open/ 1x closed	–	–
Stable position		Monostable	Monostable	Monostable	Monostable	Monostable	Monostable	Bistable
Reset method		Mechanical spring		Mechanical spring			Mechanical spring	–
Switching times in [ms]	On	10	10	10	10	10	13	–
	Off	23	27	25	25	25	22	–
	Change over	–	–	–	–	–	–	10
Product weight without solenoid coil	[g]	208	208	312	312	312	299	310
Product weight with solenoid coil	[g]	260	260	415	415	415	351	415

Safety data		
Max. positive test pulse with logic 0	[s]	2000 (valves with VACF-B-...-1)
Max. negative test pulse with logic 1	[s]	3600 (valves with VACF-B-...-1)
Shock resistance		Shock test with severity level 2 to FN 942017-5 and EN 60068-2-27
Vibration resistance		Transport application test with severity level 2 to FN 942017-4 and EN 60068-2-6

Operating and environmental conditions		M32C	M32U	T32C	T32U	T32H	M52	B52
Order code for valves		M32C	M32U	T32C	T32U	T32H	M52	B52
Operating medium		Compressed air to ISO 8573-1:2010 [7:4:4]						
Pilot medium		Compressed air to ISO 8573-1:2010 [7:4:4]						
Note on operating/pilot medium		Lubricated operation possible (in which case lubricated operation will always be required)						
Operating pressure with internal pilot air supply	[MPa]	0.25 ... 1					0.25 ... 1	0.15 ... 1
	[bar]	2.5 ... 10					2.5 ... 10	1.5 ... 10
Operating pressure with external pilot air supply	[MPa]	–0.09 ... 1					0.25 ... 1	0.15 ... 1
	[bar]	–0.9 ... 10					2.5 ... 10	1.5 ... 10
Pilot pressure	[MPa]	0.25 ... 1					0.25 ... 1	0.15 ... 1
	[bar]	2.5 ... 10					2.5 ... 10	1.5 ... 10
Ambient temperature	[°C]	–5 ... +60					–10 ... +60	
Temperature of medium	[°C]	–5 ... +60					–10 ... +60	
Certification		c UL us - Recognized (OL)						
Corrosion resistance class CRC <sup>1)</sup>		2						

1) Corrosion resistance class CRC 2 to Festo standard FN 940070

Moderate corrosion stress. Indoor applications in which condensation can occur. External visible parts with primarily decorative surface requirements which are in direct contact with a normal industrial environment.

## Technical data

Electrical data		With solenoid coil	Without solenoid coil
Electrical connection		Plug type C to EN 175301-803, plug type B to industry standard (11 mm)	Via solenoid coil → Internet: vacf
Operating voltage	[V DC]	24	
Permissible voltage fluctuations	[%]	10	
Power	[W]	3.3	
Duty cycle	[%]	100	
Degree of protection to EN 60529		IP65 with plug socket	
Materials			
Housing		Die-cast aluminium (painted)	
Seals		HNBR, NBR, TPE-U(PU)	
Screws		Galvanised steel	
Note on materials		RoHS-compliant	

Technical data

Dimensions

Download CAD data → [www.festo.com](http://www.festo.com)

3/2-way valves, with solenoid coil

3/2-way valves, without solenoid coil

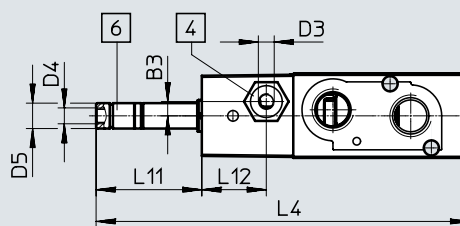
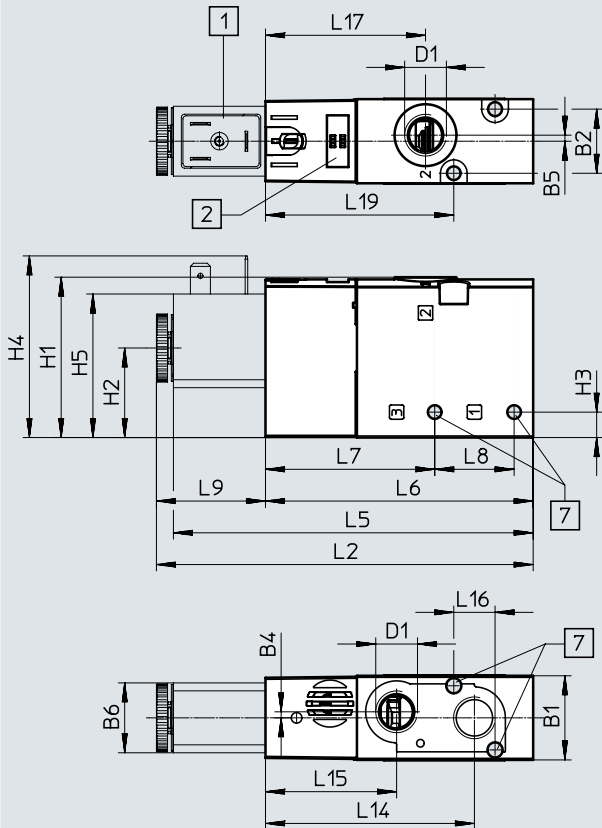

- [1] Solenoid coil interface type B/  
type C
- [2] Space for inscription label
- [4] Port 10/12 for pilot air supply
- [6] Port 82 for pilot exhaust air
- [7] For screw M4

Type	B1	B2	B3	B4	B5	B6	D1	D3	D4	D5 ∅	H1	H2	H3	H4	H5
VUVS-LT25-M32-...D-G14-...	26.5	20.2	-	1.9	1.9	22	G1/4	-	M5	8	50.5	28.2	8	57.2	45.2
VUVS-LT25-M32-...ZD-G14-...			4.5					M5							

Type	L2	L4	L5	L6	L7	L8	L9	L11	L12	L14	L15	L16	L17	L19
VUVS-LT25-M32-...D-G14-...	118.7	117.6	113.3	84.3	53.3	25	34.4	33.3	-	65.8	41.3	13	50.4	59.3
VUVS-LT25-M32-...ZD-G14-...									20.3					

Technical data

Dimensions

Download CAD data → [www.festo.com](http://www.festo.com)

5/2-way single solenoid valves, with solenoid coil

5/2-way single solenoid valves, without solenoid coil

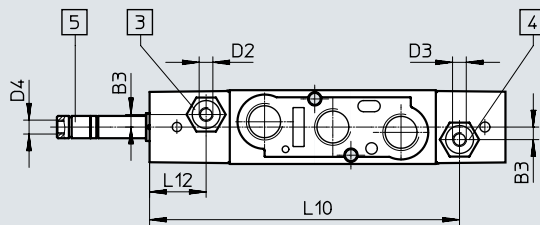
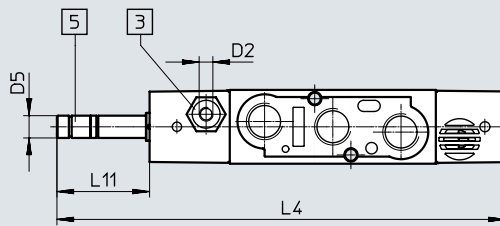
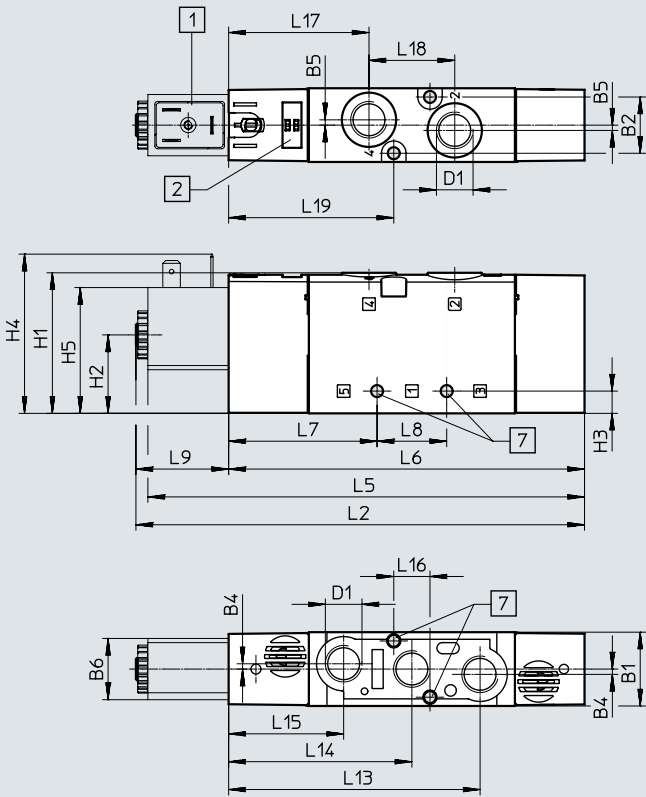

- [1] Solenoid coil
- [2] Space for inscription label

- [3] Port 14 for pilot air supply
- [4] Port 12 for pilot air supply

- [5] Port 84 for pilot exhaust air

- [7] For screw M4

Type	B1	B2	B3	B4	B5	B6	D1	D2	D3	D4	D5 ∅	H1	H2	H3	H4	H5
VUVS-LT25-M52-...D-G14-...	26.5	20.2	-	1.9	1.9	22	G1/4	-	-	M5	8	50.5	28.2	8	57.2	45.2
VUVS-LT25-M52-...ZD-G14-...			4.5					M5	M5							

Type	L2	L4	L5	L6	L7	L8	L9	L10	L11	L12	L13	L14	L15	L16	L17	L18	L19
VUVS-LT25-M52-...D-G14-...	162.2	161.1	156.8	127.8	53.3	25	34.4	-	33.3	-	90.3	65.8	41.3	13	50.4	30.8	59.3
VUVS-LT25-M52-...ZD-G14-...								111.3		20.3							



Technical data

Dimensions

Download CAD data → [www.festo.com](http://www.festo.com)

2x 3/2-way valves and 5/2-way double solenoid valves, with solenoid coil

2x 3/2-way valves and 5/2-way double solenoid valves, without solenoid coil

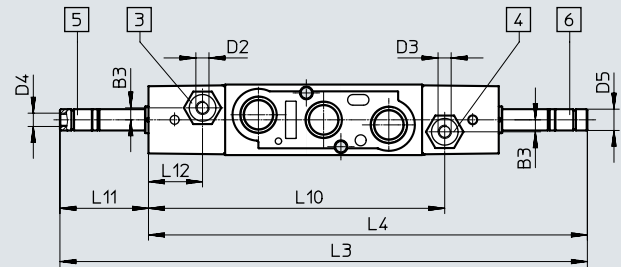
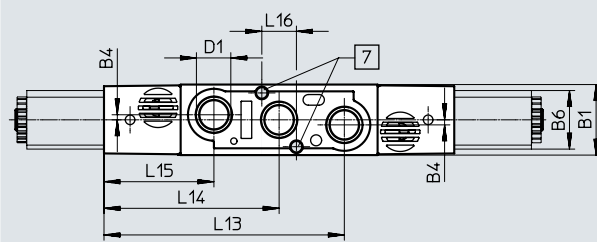
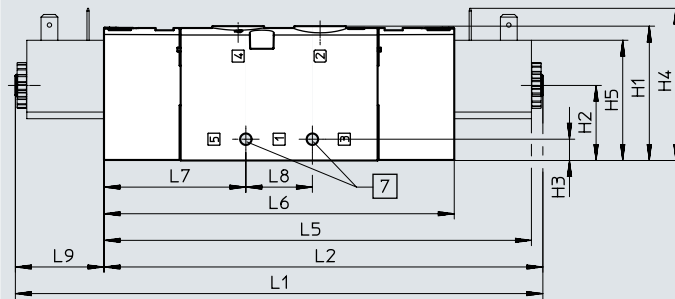
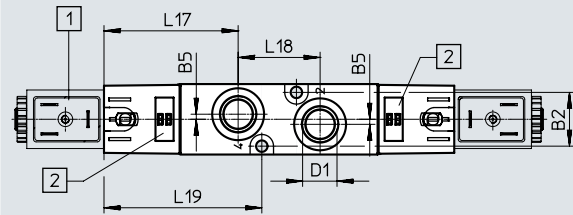

- [1] Solenoid coil
- [2] Space for inscription label
- [3] Port 14 for pilot air supply
- [4] Port 12 for pilot air supply

- [5] Port 84 for pilot exhaust air
- [6] Port 82 for pilot exhaust air
- [7] For screw M4

Type	B1	B2	B3	B4	B5	B6	D1	D2	D3	D4	D5 ∅	H1
VUVS-LT25-B52-D-G14-...	26.5	20.2	-	1.9	1.9	22	G1/4	-	-	M5	8	50.5
VUVS-LT25-B52-ZD-G14-...			4.5					M5	M5			
VUVS-LT25-T32-MD-G14-...			-					-	-			
VUVS-LT25-T32-MZD-G14-...			4.5					M5	M5			

Type	H2	H3	H4	H5	L1	L2	L3	L4	L5	L6	L7	L8
VUVS-LT25-B52-D-G14-...	28.2	8	57.2	45.2	200.3	166	198.2	164.9	160.6	131.6	53.3	25
VUVS-LT25-B52-ZD-G14-...												
VUVS-LT25-T32-MD-G14-...												
VUVS-LT25-T32-MZD-G14-...												

Type	L9	L10	L11	L12	L13	L14	L15	L16	L17	L18	L19
VUVS-LT25-B52-D-G14-...	33.3	-	33.3	-	90.3	65.8	41.3	13	50.4	30.8	59.3
VUVS-LT25-B52-ZD-G14-...		111.3		20.3							
VUVS-LT25-T32-MD-G14-...		-		-							
VUVS-LT25-T32-MZD-G14-...		111.3		20.3							

Accessories

Dimensions

Download CAD data → [www.festo.com](http://www.festo.com)

Foot mounting

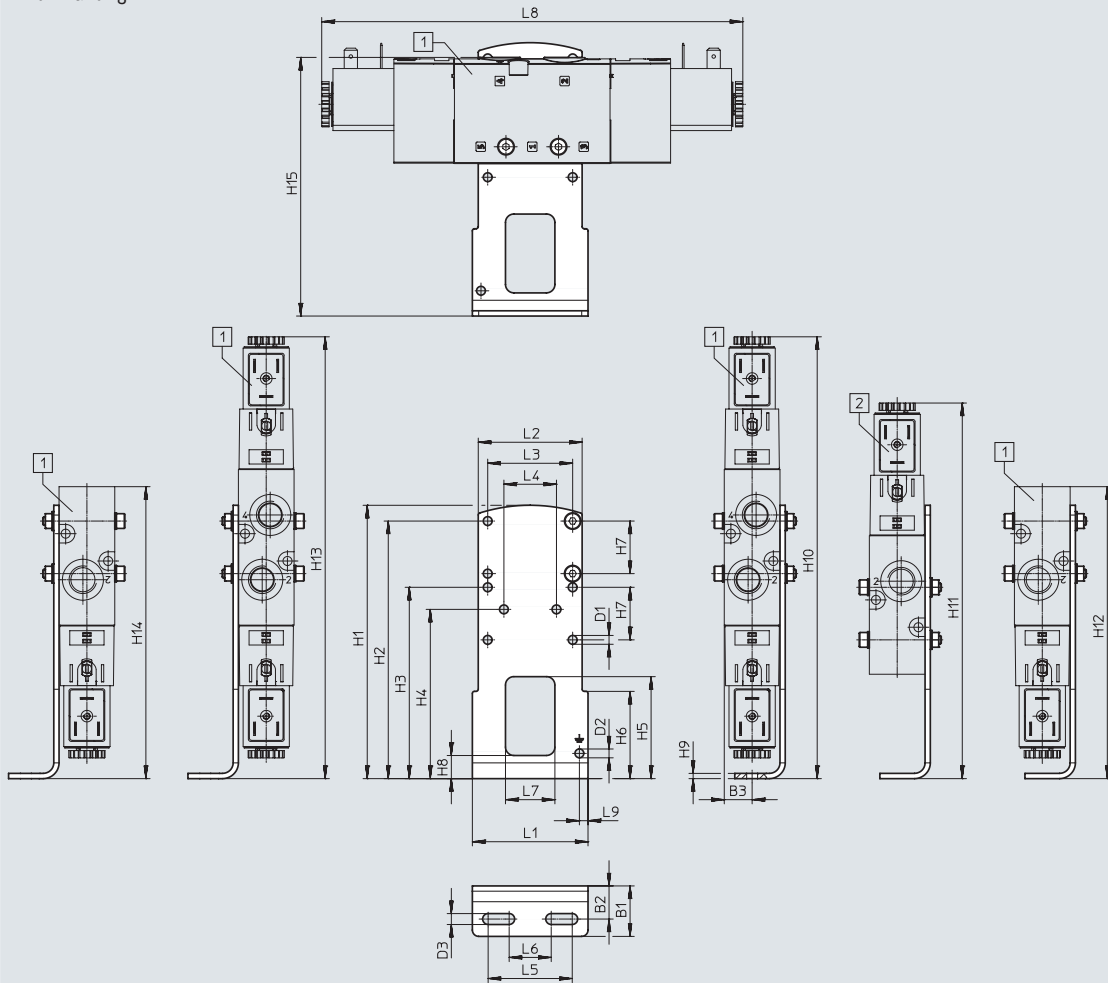

[1] VUVS-LT25-B52  
 VUVS-LT25-T32  
 VUVS-LT25-M52  
 VUVS-LT25-M32

[2] VUVS-LT25-M52,  
 VUVS-LT25-M32

Type		B1	B2	B3	D1 ∅	D2 ∅	D3	H1	H2	H3	H4
VAME-B10-25-A	VUVS-LT25-B52/T32	24	15.8	13.3	4.2	4.2	5.2	130	122.5	91	80.5
	VUVS-LT25-M52										
	VUVS-LT25-M32										

Type		H5	H6	H7	H8	H9	H10	H11	H12	H13	H14	
VAME-B10-25-A	VUVS-LT25-B52/T32	48.5	41.5	25	11	2.5	210.2	-	210.2	210.2	210.2	
	VUVS-LT25-M52							178.7				172
	VUVS-LT25-M32											138.9

Type		H15	L1	L2	L3	L4	L5	L6	L7	L8	L9
VAME-B10-25-A	VUVS-LT25-B52/T32	123	55	49.4	40.4	25	40	20	23.5	200.3	4.1
	VUVS-LT25-M52									162.2	
	VUVS-LT25-M32									118.7	

## Accessories

### Dimensions

Download CAD data → [www.festo.com](http://www.festo.com)

Wall mounting

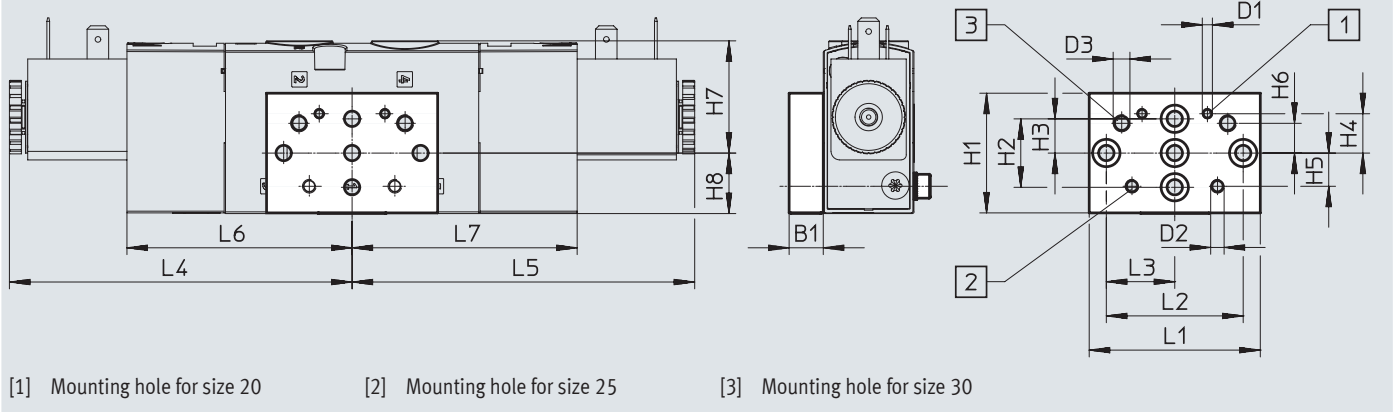

Type		B1	D1	D2	D3	H1	H2	H3	H4	H5	H6
VAME-B10-20-W	VUVS-LT25-B52/T32	10	M3	M4	M5	35	20	10	11.5	9.7	8.7
	VUVS-LT25-M52										
	VUVS-LT25-M32										

  

Type		H7	H8	L1	L2	L3	L4	L5	L6	L7
VAME-B10-20-W	VUVS-LT25-B52/T32	32.8	17.7	50	40	20	100.2	100.2	65.8	65.8
	VUVS-LT25-M52							62		-
	VUVS-LT25-M32							18.5		-

## Accessories

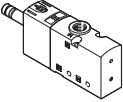
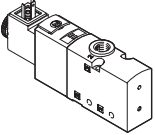
Ordering data			
	Code	Valve function	Part no. Type
<b>3/2-way valve without solenoid coil</b>			
	<b>Single solenoid, normally closed</b>		
	M32C-M	Reset via mechanical spring, internal pilot air supply, flow direction not reversible	8035167 VUVS-LT25-M32C-MD-G14-F8
		Reset via mechanical spring, external pilot air supply, flow direction not reversible	8035168 VUVS-LT25-M32C-MZD-G14-F8
	<b>Single solenoid, normally open</b>		
	M32U-M	Reset via mechanical spring, internal pilot air supply, flow direction not reversible	8035174 VUVS-LT25-M32U-MD-G14-F8
		Reset via mechanical spring, external pilot air supply, flow direction not reversible	8035175 VUVS-LT25-M32U-MZD-G14-F8
<b>3/2-way valve with solenoid coil (24 V DC)</b>			
	<b>Single solenoid, normally closed, type C</b>		
	M32C-M	Reset via mechanical spring, internal pilot air supply, flow direction not reversible	8035169 VUVS-LT25-M32C-MD-G14-F8-1C1
		Reset via mechanical spring, external pilot air supply, flow direction not reversible	8035170 VUVS-LT25-M32C-MZD-G14-F8-1C1
	<b>Single solenoid, normally closed, type B</b>		
	M32C-M	Reset via mechanical spring, internal pilot air supply, flow direction not reversible	8035171 VUVS-LT25-M32C-MD-G14-F8-1B2
		Reset via mechanical spring, external pilot air supply, flow direction not reversible	8035172 VUVS-LT25-M32C-MZD-G14-F8-1B2
	<b>Single solenoid, normally open, type C</b>		
	M32U-M	Reset via mechanical spring, internal pilot air supply, flow direction not reversible	8035176 VUVS-LT25-M32U-MD-G14-F8-1C1
		Reset via mechanical spring, external pilot air supply, flow direction not reversible	8035177 VUVS-LT25-M32U-MZD-G14-F8-1C1
	<b>Single solenoid, normally open, type B</b>		
	M32U-M	Reset via mechanical spring, internal pilot air supply, flow direction not reversible	8035178 VUVS-LT25-M32U-MD-G14-F8-1B2
		Reset via mechanical spring, external pilot air supply, flow direction not reversible	8035179 VUVS-LT25-M32U-MZD-G14-F8-1B2

## Accessories

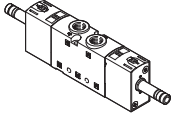
Ordering data			
	Code	Valve function	Part no.   Type
<b>2x 3/2-way valve without solenoid coil</b>			
	<b>Single solenoid, normally closed</b>		
	T32C	Reset via mechanical spring, internal pilot air supply, flow direction not reversible	8035195   VUVS-LT25-T32C-MD-G14-F8
		Reset via mechanical spring, external pilot air supply, flow direction not reversible	8035196   VUVS-LT25-T32C-MZD-G14-F8
	<b>Single solenoid, normally open</b>		
	T32U	Reset via mechanical spring, internal pilot air supply, flow direction not reversible	8035202   VUVS-LT25-T32U-MD-G14-F8
		Reset via mechanical spring, external pilot air supply, flow direction not reversible	8035203   VUVS-LT25-T32U-MZD-G14-F8
	<b>Single solenoid, 1x normally open, 1x normally closed</b>		
	T32H	Reset via mechanical spring, internal pilot air supply, flow direction not reversible	8035209   VUVS-LT25-T32H-MD-G14-F8
		Reset via mechanical spring, external pilot air supply, flow direction not reversible	8035210   VUVS-LT25-T32H-MZD-G14-F8

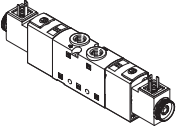

## Accessories

Ordering data			
	Code	Valve function	Part no. Type
<b>2x 3/2-way valve with solenoid coil (24 V DC)</b>			
	<b>Single solenoid, normally closed, type C</b>		
	T32C	Reset via mechanical spring, internal pilot air supply, flow direction not reversible	8035197 VUVS-LT25-T32C-MD-G14-F8-1C1
		Reset via mechanical spring, external pilot air supply, flow direction not reversible	8035198 VUVS-LT25-T32C-MZD-G14-F8-1C1
	<b>Single solenoid, normally closed, type B</b>		
	T32C	Reset via mechanical spring, internal pilot air supply, flow direction not reversible	8035199 VUVS-LT25-T32C-MD-G14-F8-1B2
		Reset via mechanical spring, external pilot air supply, flow direction not reversible	8035200 VUVS-LT25-T32C-MZD-G14-F8-1B2
	<b>Single solenoid, normally open, type C</b>		
	T32U	Reset via mechanical spring, internal pilot air supply, flow direction not reversible	8035204 VUVS-LT25-T32U-MD-G14-F8-1C1
		Reset via mechanical spring, external pilot air supply, flow direction not reversible	8035205 VUVS-LT25-T32U-MZD-G14-F8-1C1
	<b>Single solenoid, normally open, type B</b>		
	T32U	Reset via mechanical spring, internal pilot air supply, flow direction not reversible	8035206 VUVS-LT25-T32U-MD-G14-F8-1B2
		Reset via mechanical spring, external pilot air supply, flow direction not reversible	8035207 VUVS-LT25-T32U-MZD-G14-F8-1B2
	<b>Single solenoid, 1x normally open, 1x normally closed, type C</b>		
	T32H	Reset via mechanical spring, internal pilot air supply, flow direction not reversible	8035211 VUVS-LT25-T32H-MD-G14-F8-1C1
		Reset via mechanical spring, external pilot air supply, flow direction not reversible	8035212 VUVS-LT25-T32H-MZD-G14-F8-1C1
	<b>Single solenoid, 1x normally open, 1x normally closed, type B</b>		
	T32H	Reset via mechanical spring, internal pilot air supply, flow direction not reversible	8035213 VUVS-LT25-T32H-MD-G14-F8-1B2
		Reset via mechanical spring, external pilot air supply, flow direction not reversible	8035214 VUVS-LT25-T32H-MZD-G14-F8-1B2

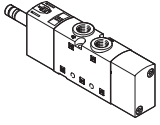
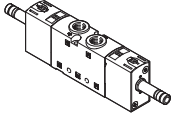
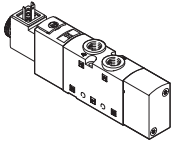
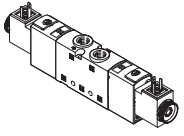
## Accessories





Ordering data		Code	Valve function	Part no.	Type	
<b>5/2-way valve without solenoid coil</b>						
	<b>Single solenoid</b>					
	M52	Reset via mechanical spring, internal pilot air supply, flow direction not reversible	8035181	VUVS-LT25-M52-MD-G14-F8		
		Reset via mechanical spring, external pilot air supply, flow direction not reversible	8035182	VUVS-LT25-M52-MZD-G14-F8		
	<b>Double solenoid</b>					
	B52	Internal pilot air supply, flow direction not reversible	8035188	VUVS-LT25-B52-D-G14-F8		
		External pilot air supply, flow direction not reversible	8035189	VUVS-LT25-B52-ZD-G14-F8		
	<b>5/2-way valve with solenoid coil (24 V DC)</b>					
		<b>Single solenoid, type C</b>				
M52-M		Reset via mechanical spring, internal pilot air supply, flow direction not reversible	8035183	VUVS-LT25-M52-MD-G14-F8-1C1		
		Reset via mechanical spring, external pilot air supply, flow direction not reversible	8035184	VUVS-LT25-M52-MZD-G14-F8-1C1		
<b>Single solenoid, type B</b>						
M52-M		Reset via mechanical spring, internal pilot air supply, flow direction not reversible	8035185	VUVS-LT25-M52-MD-G14-F8-1B2		
		Reset via mechanical spring, external pilot air supply, flow direction not reversible	8035186	VUVS-LT25-M52-MZD-G14-F8-1B2		
		<b>Double solenoid, type C</b>				
		B52	Internal pilot air supply, flow direction not reversible	8035190	VUVS-LT25-B52-D-G14-F8-1C1	
		External pilot air supply, flow direction not reversible	8035191	VUVS-LT25-B52-ZD-G14-F8-1C1		
	<b>Double solenoid, type B</b>					
	B52	Internal pilot air supply, flow direction not reversible	8035192	VUVS-LT25-B52-D-G14-F8-1B2		
		External pilot air supply, flow direction not reversible	8035193	VUVS-LT25-B52-ZD-G14-F8-1B2		

## Accessories



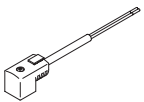

Ordering data		Description	Part no.	Type
<b>Solenoid coils for valves</b>				
	Plug pattern type C, to DIN EN 175301-803	12 V DC	8030810	VACF-B-C1-5
		24 V DC	8030811	VACF-B-C1-1
		48 V DC	8030812	VACF-B-C1-7
		24 V AC/50-60 Hz	8030813	VACF-B-C1-1A
		48 V AC/50-60 Hz	8030814	VACF-B-C1-7A
		110/120 V AC/50-60 Hz	8030815	VACF-B-C1-16B
		230/240 V AC/50-60 Hz	8030817	VACF-B-C1-3W
	Plug pattern type B, industry standard	12 V DC	8030801	VACF-B-B2-5
		24 V DC	8030802	VACF-B-B2-1
		48 V DC	8030803	VACF-B-B2-7
		24 V AC/50-60 Hz	8030804	VACF-B-B2-1A
		48 V AC/50-60 Hz	8030805	VACF-B-B2-7A
		110/120 V AC/50-60 Hz	8030806	VACF-B-B2-16B
		230/240 V AC/50-60 Hz	8030808	VACF-B-B2-3W
<b>Seal set for solenoid coil</b>				
	Plug pattern type C to guarantee protection class IP67	2643771	VAMC-B10-C-B-S8	
	Plug pattern type B to guarantee protection class IP67	8034609	VAMC-B10-B-B-S8	
<b>Cover cap</b>				
	For manual override, non-detenting or covered	8028240	VAMC-B10-20-CH2	



## Accessories

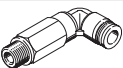
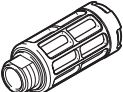
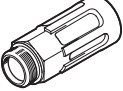

Ordering data		Description	Part no.	Type		
<b>Plug socket</b>						
	<b>Plug pattern type C, to DIN EN 175301-803</b>					
	3-pin, screw terminal	Cable connector M12	0 ... 250 V AC/DC	IP65	539712	MSSD-EB-M12
		Cable connector Pg7			★ 151687	MSSD-EB
	4-pin, insulation displacement connector	Cable connector M14	0 ... 250 V AC/DC	IP67	192745	MSSD-EB-S-M14
	3-pin, angled socket	Cable connector M12	0 ... 24 V DC	IP65	570367	MSSD-EB-M12-24VDC-SD-EX
	<b>Plug pattern type B, industry standard</b>					
3-pin, screw terminal	Cable connector M16	0 ... 250 V AC/DC	IP65	539710	MSSD-F-M16	
	Cable connector Pg9			★ 34431	MSSD-F	
3-pin, insulation displacement connector	–	0 ... 250 V AC/DC	IP67	192746	MSSD-F-S-M16	
<b>Adapter</b>						
	Socket type C, to EN 175301-803	Plug connector M12x1, 2-pin, A-coded	12 ... 24 V AC/DC	IP65	188024	MSSD-EB-M12-MONO
<b>Plug socket with cable</b>						
	<b>Plug pattern type C, to DIN EN 175301-803</b>					
	Angled socket, 3-pin Cable, open end, 3-wire	24 V DC	LED	2.5 m	★ 151688	KMEB-1-24-2,5-LED
				5 m	151689	KMEB-1-24-5-LED
				10 m	193457	KMEB-1-24-10-LED
	230 V AC	–	2.5 m	151690	KMEB-1-230AC-2,5	
			5 m	151691	KMEB-1-230AC-5	
	<b>Plug pattern type B, industry standard</b>					
	Angled socket, 3-pin Cable, open end, 3-wire	24 V DC	LED	2.5 m	★ 30935	KMF-1-24DC-2,5-LED
5 m				30937	KMF-1-24DC-5-LED	
10 m				193458	KMF-1-24-10-LED	
230 V AC	–	2.5 m	30936	KMF-1-230AC-2,5		
		5 m	30938	KMF-1-230AC-5		
<b>Illuminating seal</b>						
	Plug pattern type C, to DIN EN 175301-803	24 V DC	151717	MEB-LD-12-24DC		
		230 V AC	151718	MEB-LD-230AC		
	Plug pattern type B, industry standard	24 V DC	19143	MF-LD-12-24DC		
		230 V AC	19144	MF-LD-230AC		

## Accessories

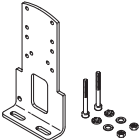
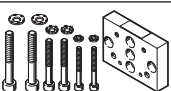

Ordering data		Description	Part no.	Type	PU <sup>1)</sup>
<b>Push-in fitting with internal hex</b>					
	Connecting thread M5 for tubing O.D.	4 mm	★ 153315	QSM-M5-4-I	10
	Connecting thread G1/4 for tubing O.D.	6 mm	★ 186108	QS-G1/4-6-I	10
		8 mm	★ 186110	QS-G1/4-8-I	10
		10 mm	★ 186112	QS-G1/4-10-I	10
<b>Angled push-in fitting with external hex</b>					
	Connecting thread G1/4 for tubing O.D.	6 mm	★ 186118	QSL-G1/4-6	10
			132051	QSL-G1/4-6-100	100
		8 mm	★ 186120	QSL-G1/4-8	10
			132052	QSL-G1/4-8-50	50
		10 mm	★ 186122	QSL-G1/4-10	10
			132053	QSL-G1/4-10-50	50
<b>Angled push-in fitting, long, with external hex</b>					
	Connecting thread G1/4 for tubing O.D.	6 mm	186129	QSL-G1/4-6	10
		8 mm	186131	QSL-G1/4-8	10
		10 mm	186133	QSL-G1/4-10	10
<b>Silencer</b>					
	With connecting thread G, polymer design	G1/4	★ 2316	U-1/4	1
			534223	U-1/4-20	20
	With connecting thread G, metal design	G1/4	6842	U-1/4-B	1
	With connecting thread G, sintered design, long	G1/4	★ 1205861	AMTE-M-LH-G14	20

1) Packaging unit

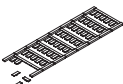
## Accessories

Ordering data	Description	Weight [g]	Part no.	Type
<b>Foot mounting</b>				
	With screw set for attaching the valve to the foot mounting	130	2293485	VAME-B10-25-A
<b>Wall mounting</b>				
	With screw set for attaching the valve to the wall mounting	53	576413	VAME-B10-20-W
<b>Assortment of spare parts</b>				
	Set comprising seals and screws	12	8035636	VAME-B10-25-MK
<b>Inscription label</b>				
	40 pieces in frame	-	565306	ASLR-C-E4

## Technical data

-  - Flow rate  
up to 1800 l/min
-  - Valve width  
31 mm
-  - Voltage  
24 V DC

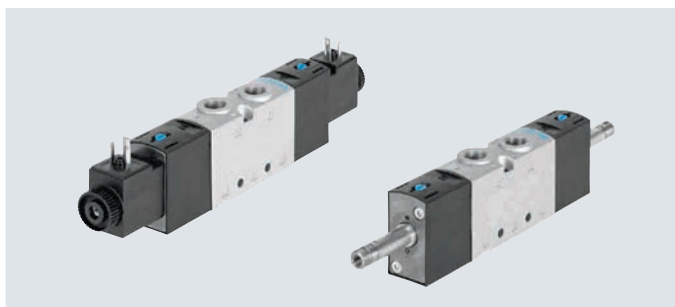

### General technical data

Valve function		3/2-way valve					5/2-way valve	
		M32C	M32U	T32C	T32U	T32H	M52	B52
Order code for valves		M32C	M32U	T32C	T32U	T32H	M52	B52
Valve width	[mm]	31						
Nominal width	Diameter [mm]	7.9	7.9	7.9	7.8	7.8	8.1	8.7
Design		Poppet seat						
Flow direction		Non-reversible						
Pilot air supply		Internal or external						
Type of control		Piloted						
Manual override		Non-detenting, detenting						
Overlap		Negative overlap						
Sealing principle		Soft						
Type of mounting		Optionally via through-hole or on manifold rail						
Standard nominal flow rate q <sub>nN</sub>	[l/min]	1600					1800	
Actuation type		Electric						
Mounting position		Any						
Exhaust air function		Can be throttled						
Connection for venting hole		Not ducted						
b value		0.4	0.2	0.4	0.3	0.3	0.3	0.3
c value	[l/sbar]	6.0	7.0	6.0	6.7	6.7	9.9	9.9
Pneumatic connection	1, 2, 3	G3/8	G3/8	G3/8	G3/8	G3/8	G3/8	G3/8
	4, 5	-	-	G3/8	G3/8	G3/8	G3/8	G3/8
Pilot air port 12, 14		G1/8	G1/8	G1/8	G1/8	G1/8	G1/8	G1/8
Pilot exhaust air connection 82, 84		M5	M5	M5	M5	M5	M5	M5

### ATEX

Type	VUVS-LT-...-EX2
ATEX category for gas	II 3G
Type of ignition protection for gas	Ex ec IICT4 Gc X
ATEX category for dust	II 3D
Type of ignition protection for dust	Ex tc IIICT115°C Dc X
Explosion-proof ambient temperature [°C]	-10°C ≤ Ta ≤ +60°C
CE marking (see declaration of conformity) <sup>1)</sup>	To EU Explosion Protection Directive (ATEX)
UKCA marking (see declaration of conformity) <sup>1)</sup>	To UK EX instructions
Explosion protection certification outside the EU	EPL Dc (GB)
	EPL Gc (GB)

<sup>1)</sup> For information about the area of use, see the EC declaration of conformity at: [www.festo.com/catalogue/...](http://www.festo.com/catalogue/...) → Support/Downloads.

If the devices are subject to usage restrictions in residential, commercial or light-industrial environments, further measures for the reduction of the emitted interference may be necessary.

## Technical data

Technical data		M32C	M32U	T32C	T32U	T32H	M52	B52
Order code for valves		M32C	M32U	T32C	T32U	T32H	M52	B52
Normal position		Closed	Open	2x closed	2x open	1x open/ 1x closed	–	–
Stable position		Monostable	Monostable	Monostable	Monostable	Monostable	Monostable	Bistable
Reset method		Mechanical spring		Mechanical spring			Mechanical spring	–
Switching times in [ms]	On	13	14	13	14	13	17	–
	Off	32	36	33	35	37	26	–
	Change over	–	–	–	–	–	–	13
Product weight without solenoid coil	[g]	305	305	442	442	442	432	438
Product weight with solenoid coil	[g]	359	359	543	543	543	486	542

## Safety data

Max. positive test pulse with logic 0	[s]	2000 (valves with VACF-B-...-1)
Max. negative test pulse with logic 1	[s]	3600 (valves with VACF-B-...-1)
Shock resistance		Shock test with severity level 2 to FN 942017-5 and EN 60068-2-27
Vibration resistance		Transport application test with severity level 2 to FN 942017-4 and EN 60068-2-6

## Operating and environmental conditions

Operating and environmental conditions		M32C	M32U	T32C	T32U	T32H	M52	B52
Order code for valves		M32C	M32U	T32C	T32U	T32H	M52	B52
Operating medium		Compressed air to ISO 8573-1:2010 [7:4:4]						
Pilot medium		Compressed air to ISO 8573-1:2010 [7:4:4]						
Note on operating/pilot medium		Lubricated operation possible (in which case lubricated operation will always be required)						
Operating pressure with internal pilot air supply	[MPa]	0.25 ... 1					0.25 ... 1	0.15 ... 1
	[bar]	2.5 ... 10					2.5 ... 10	1.5 ... 10
Operating pressure with external pilot air supply	[MPa]	0.1 ... 1					0.25 ... 1	0.15 ... 1
	[bar]	1.0 ... 10					2.5 ... 10	1.5 ... 10
Pilot pressure	[MPa]	0.25 ... 1					0.25 ... 1	0.15 ... 1
	[bar]	2.5 ... 10					2.5 ... 10	1.5 ... 10
Ambient temperature	[°C]	–10 ... +60						
Temperature of medium	[°C]	–10 ... +60						
Certification		c UL us - Recognized (OL)						
Corrosion resistance class CRC <sup>1)</sup>		2						

1) Corrosion resistance class CRC 2 to Festo standard FN 940070

Moderate corrosion stress. Indoor applications in which condensation can occur. External visible parts with primarily decorative surface requirements which are in direct contact with a normal industrial environment.

## Technical data

Electrical data		With solenoid coil	Without solenoid coil
Electrical connection		Plug type C to EN 175301-803, plug type B to industry standard (11 mm)	Via solenoid coil → Internet: vacf
Operating voltage	[V DC]	24	
Permissible voltage fluctuations	[%]	10	
Power	[W]	3.3	
Duty cycle	[%]	100	
Degree of protection to EN 60529		IP65 with plug socket	

Materials							
Order code for valves	M32C	M32U	T32C	T32U	T32H	M52	B52
Housing	Die-cast aluminium (painted)						
Seals	HNBR, NBR, TPE-U(PU)						
Piston spool	Wrought aluminium alloy					POM	POM
Screws	Galvanised steel						
Note on materials	RoHS-compliant						

## Technical data

### Dimensions

Download CAD data → [www.festo.com](http://www.festo.com)

3/2-way valves, with solenoid coil

3/2-way valves, without solenoid coil

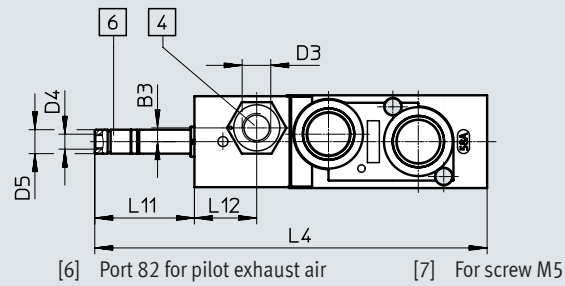
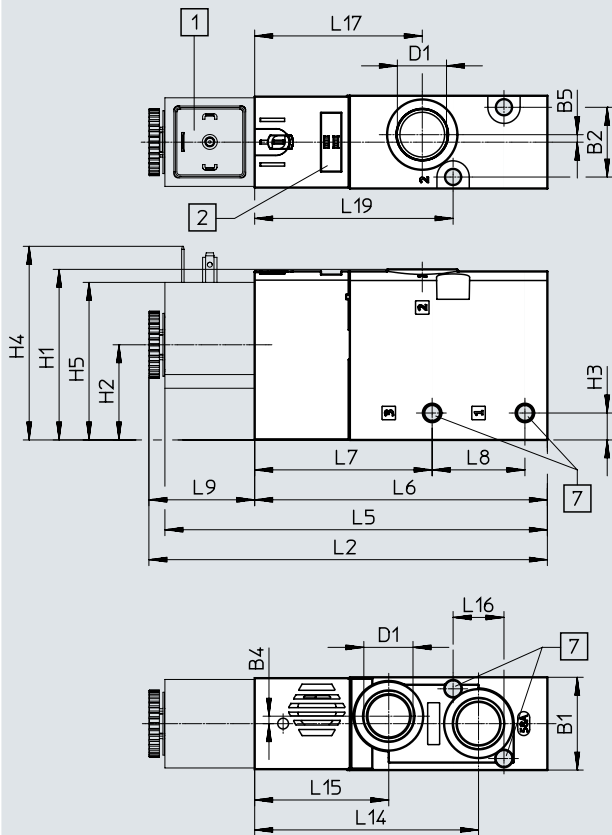

[1] Solenoid coil

[4] Port 10/12 for pilot air supply

[6] Port 82 for pilot exhaust air

[7] For screw M5

[2] Space for inscription label

Type	B1	B2	B3	B4	B5	D1	D3	D4	D5	H1	H2	H3	H4	H5
VUVS-LT30-M32...-D-G38-...	31	23.3	-	2.5	2.5	G3/8	-	M5	8	57	31.8	9	64.7	52.6
VUVS-LT30-M32...-ZD-G38-...			4.6				G1/8							

Type	L2	L4	L5	L6	L7	L8	L9	L11	L12	L14	L15	L16	L17	L19
VUVS-LT30-M32...-D-G38-...	133.2	131.1	127.8	97.8	59.3	31	35.4	33.3	-	74.8	44.8	17	56	66.3
VUVS-LT30-M32...-ZD-G38-...									20.8					

## Technical data

### Dimensions

Download CAD data → [www.festo.com](http://www.festo.com)

5/2-way single solenoid valves, with solenoid coil

5/2-way single solenoid valves, without solenoid coil

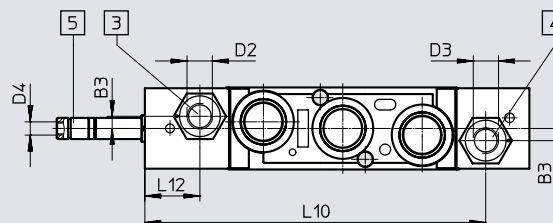
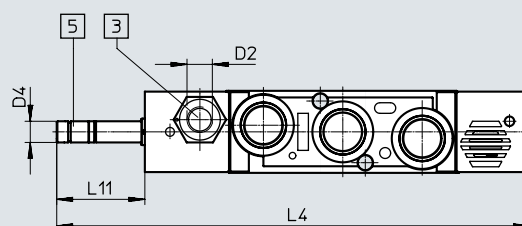
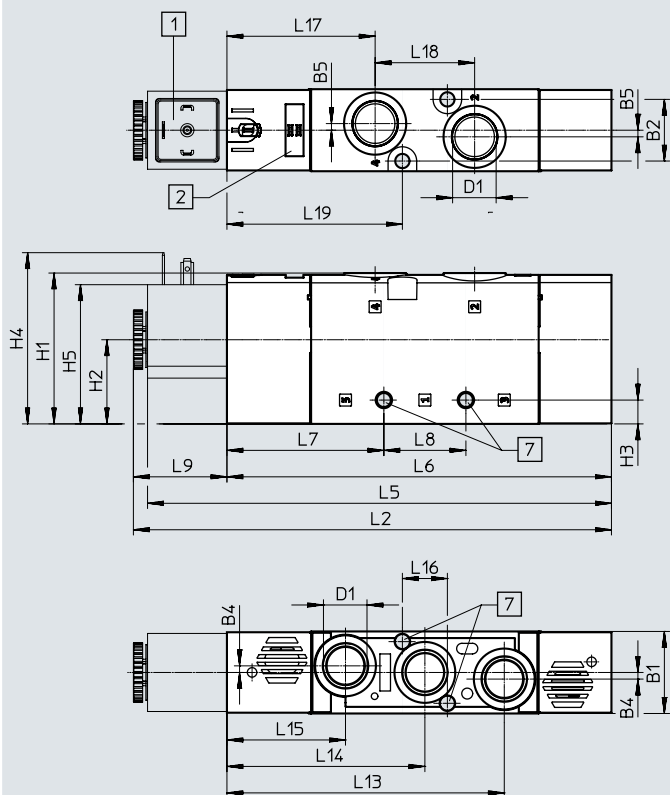

[1] Solenoid coil interface type B/  
type C  
[2] Space for inscription label

[3] Port 14 for pilot air supply  
[4] Port 12 for pilot air supply

[5] Port 84 for pilot exhaust air

[7] For screw M5

Type	B1	B2	B3	B4	B5	D1	D2	D3	D4	D5 ∅	H1	H2	H3	H4	H5
VUVS-LT30-M52-...D-G38-...	31	23.3	–	2.5	2.5	G3/8	–	–	M5	8	57	31.8	9	64.7	52.6
VUVS-LT30-M52-...ZD-G38-...			4.6				G1/8	G1/8							

Type	L2	L4	L5	L6	L7	L8	L9	L10	L11	L12	L13	L14	L15	L16	L17	L18	L19
VUVS-LT30-M52-...D-G38-...	180.7	178.6	179.6	145.3	59.3	31	35.4	–	33.3	–	104.8	74.8	44.8	17	56	37.6	66.3
VUVS-LT30-M52-...ZD-G38-...								128.8		20.8							



Technical data

Dimensions

Download CAD data → [www.festo.com](http://www.festo.com)

2x 3/2-way valves and 5/2-way double solenoid valves, with solenoid coil

2x 3/2-way valves and 5/2-way double solenoid valves, without solenoid coil

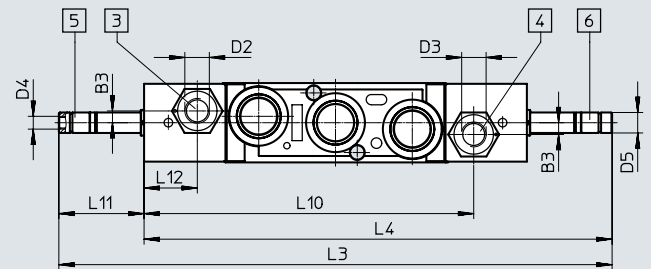
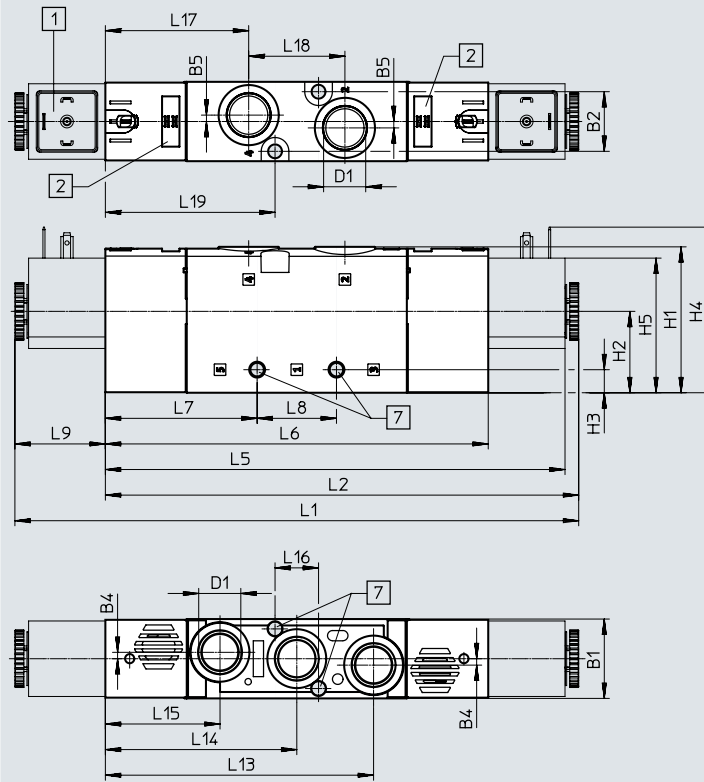

- [1] Solenoid coil interface type B/ type C
- [2] Space for inscription label
- [3] Port 14 for pilot air supply
- [4] Port 12 for pilot air supply
- [5] Port 84 for pilot exhaust air
- [6] Port 82 for pilot exhaust air
- [7] For screw M5

Type	B1	B2	B3	B4	B5	D1	D2	D3	D4	D5 ∅	H1	H2	H3	H4	H5
VUVS-LT30-T32...-MD-G38-...	31	23.3	-	2.5	2.5	G3/8	-	-	M5	8	57	31.8	9	64.7	52.6
VUVS-LT30-T32...-MZD-G38-...			4.6				G1/8	G1/8							
VUVS-LT30-B52-D-G38-...			-				-	-							
VUVS-LT30-B52-ZD-G38-...			4.6				G1/8	G1/8							

Type	L1	L2	L3	L4	L5	L6	L7	L8	L9	L10
VUVS-LT30-T32...-MD-G38-...	220.3	185	216.2	182.9	179.6	149.6	59.3	31	35.4	-
VUVS-LT30-T32...-MZD-G38-...										128.8
VUVS-LT30-B52-D-G38-...										-
VUVS-LT30-B52-ZD-G38-...										128.8

Type	L11	L12	L13	L14	L15	L16	L17	L18	L19
VUVS-LT30-T32...-MD-G38-...	33.3	-	104.8	74.8	44.8	17	56	37.6	66.3
VUVS-LT30-T32...-MZD-G38-...		20.8							
VUVS-LT30-B52-D-G38-...		-							
VUVS-LT30-B52-ZD-G38-...		20.8							

Accessories

Dimensions

Download CAD data → [www.festo.com](http://www.festo.com)

Foot mounting

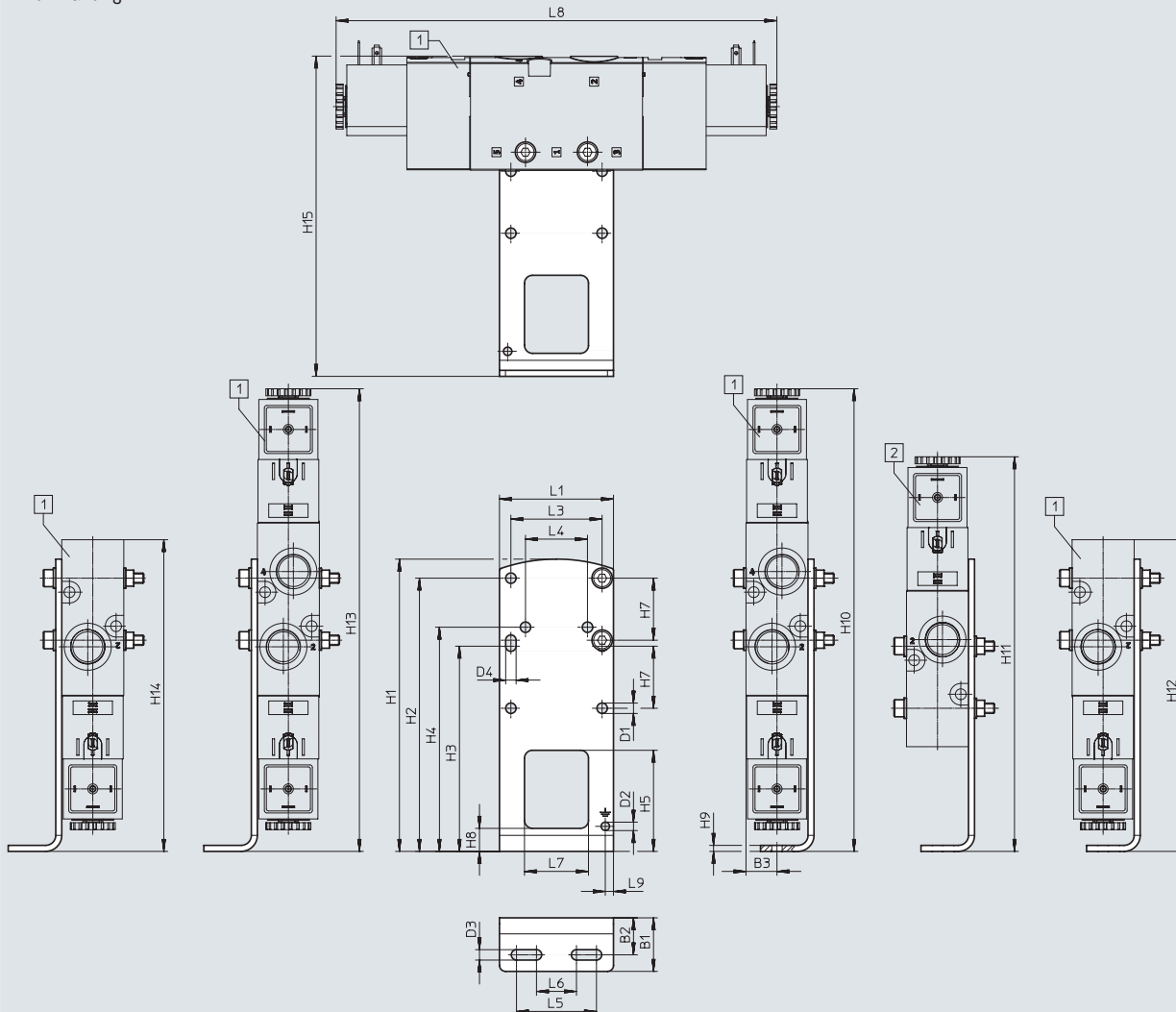

[1] VUVS-LT30-B52  
 VUVS-LT30-T32  
 VUVS-LT30-M52  
 VUVS-LT30-M32

[2] VUVS-LT30-M52,  
 VUVS-LT30-M32

Type		B1	B2	B3	D1 ∅	D2 ∅	D3	D4	H1	H2	H3
VAME-B10-30-A	VUVS-LT30-B52/T32	26.8	18.5	15.5	5.2	4.2	5.2	5.2	146	136.5	102.5
	VUVS-LT30-M52										
	VUVS-LT30-M32										

Type		H4	H5	H7	H8	H9	H10	H11	H12	H13	H14
VAME-B10-30-A	VUVS-LT30-B52/T32	112	50.5	31	11.5	3	231.2	-	231.2	231.2	231.2
	VUVS-LT30-M52							197.2	191.5		191.5
	VUVS-LT30-M32							144	144		144

Type		H15	L1	L3	L4	L5	L6	L7	L8	L9
VAME-B10-30-A	VUVS-LT30-B52/T32	160	57	45.6	31	40	20	32	220.3	4.1
	VUVS-LT30-M52								180.7	
	VUVS-LT30-M32								133.2	

## Accessories

### Dimensions

Download CAD data → [www.festo.com](http://www.festo.com)

Wall mounting

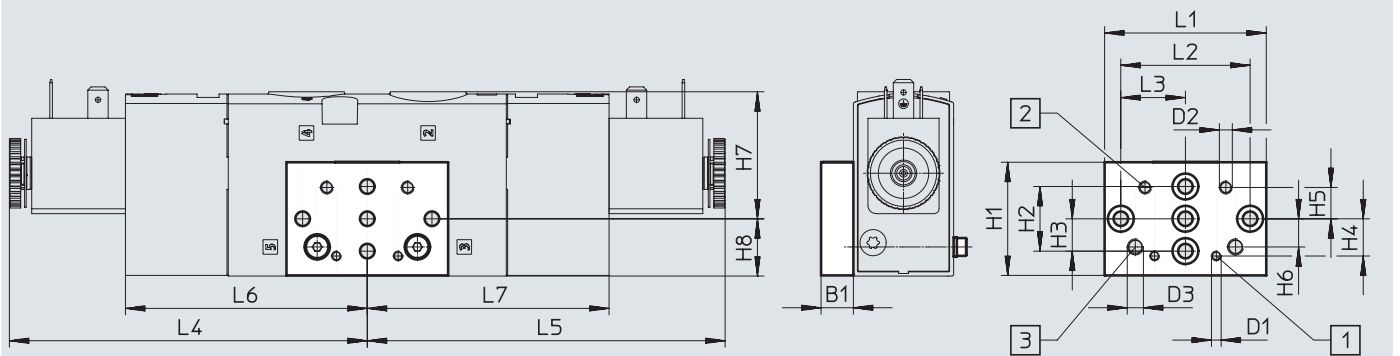

[1] Mounting hole for size 20

[2] Mounting hole for size 25

[3] Mounting hole for size 30

Type		B1	D1	D2	D3	H1	H2	H3	H4	H5	H6
VAME-B10-20-W	VUVS-LT30-B52/T32	10	M3	M4	M5	35	20	10	11.5	9.7	8.7
	VUVS-LT30-M52										
	VUVS-LT30-M32										

Type		H7	H8	L1	L2	L3	L4	L5	L6	L7
VAME-B10-20-W	VUVS-LT30-B52/T32	39.3	17.7	50	40	20	110.2	110.2	74.8	74.8
	VUVS-LT30-M52									
	VUVS-LT30-M32									

## Accessories

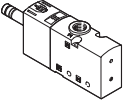
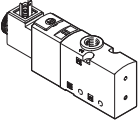
Ordering data			
	Code	Valve function	Part no. Type
<b>3/2-way valve without solenoid coil</b>			
	<b>Single solenoid, normally closed</b>		
	M32C-M	Reset via mechanical spring, internal pilot air supply, flow direction not reversible	8036672 VUVS-LT30-M32C-MD-G38-F8
		Reset via mechanical spring, external pilot air supply, flow direction not reversible	8036673 VUVS-LT30-M32C-MZD-G38-F8
	<b>Single solenoid, normally open</b>		
	M32U-M	Reset via mechanical spring, internal pilot air supply, flow direction not reversible	8036679 VUVS-LT30-M32U-MD-G38-F8
		Reset via mechanical spring, external pilot air supply, flow direction not reversible	8036680 VUVS-LT30-M32U-MZD-G38-F8
<b>3/2-way valve with solenoid coil (24 V DC)</b>			
	<b>Single solenoid, normally closed, type C</b>		
	M32C-M	Reset via mechanical spring, internal pilot air supply, flow direction not reversible	8036674 VUVS-LT30-M32C-MD-G38-F8-1C1
		Reset via mechanical spring, external pilot air supply, flow direction not reversible	8036675 VUVS-LT30-M32C-MZD-G38-F8-1C1
	<b>Single solenoid, normally closed, type B</b>		
	M32C-M	Reset via mechanical spring, internal pilot air supply, flow direction not reversible	8036676 VUVS-LT30-M32C-MD-G38-F8-1B2
		Reset via mechanical spring, external pilot air supply, flow direction not reversible	8036677 VUVS-LT30-M32C-MZD-G38-F8-1B2
	<b>Single solenoid, normally open, type C</b>		
	M32U-M	Reset via mechanical spring, internal pilot air supply, flow direction not reversible	8036681 VUVS-LT30-M32U-MD-G38-F8-1C1
		Reset via mechanical spring, external pilot air supply, flow direction not reversible	8036682 VUVS-LT30-M32U-MZD-G38-F8-1C1
	<b>Single solenoid, normally open, type B</b>		
	M32U-M	Reset via mechanical spring, internal pilot air supply, flow direction not reversible	8036683 VUVS-LT30-M32U-MD-G38-F8-1B2
		Reset via mechanical spring, external pilot air supply, flow direction not reversible	8036684 VUVS-LT30-M32U-MZD-G38-F8-1B2

## Accessories

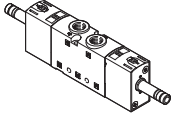
Ordering data				
	Code	Valve function	Part no.   Type	
<b>2x 3/2-way valve without solenoid coil</b>				
	<b>Single solenoid, normally closed</b>			
	T32C	Reset via mechanical spring, internal pilot air supply, flow direction not reversible	8036700	VUVS-LT30-T32C-MD-G38-F8
		Reset via mechanical spring, external pilot air supply, flow direction not reversible	8036701	VUVS-LT30-T32C-MZD-G38-F8
	<b>Single solenoid, normally open</b>			
	T32U	Reset via mechanical spring, internal pilot air supply, flow direction not reversible	8036707	VUVS-LT30-T32U-MD-G38-F8
		Reset via mechanical spring, external pilot air supply, flow direction not reversible	8036708	VUVS-LT30-T32U-MZD-G38-F8
	<b>Single solenoid, 1x normally open, 1x normally closed</b>			
	T32H	Reset via mechanical spring, internal pilot air supply, flow direction not reversible	8036714	VUVS-LT30-T32H-MD-G38-F8
	Reset via mechanical spring, external pilot air supply, flow direction not reversible	8036715	VUVS-LT30-T32H-MZD-G38-F8	



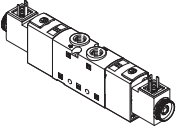

## Accessories

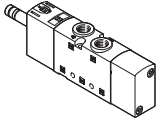
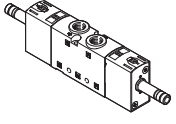
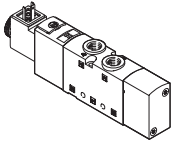
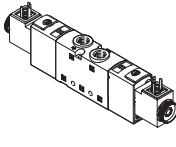
Ordering data			
	Code	Valve function	Part no. Type
<b>2x 3/2-way valve with solenoid coil (24 V DC)</b>			
	<b>Single solenoid, normally closed, type C</b>		
	T32C	Reset via mechanical spring, internal pilot air supply, flow direction not reversible	8036702 VUVS-LT30-T32C-MD-G38-F8-1C1
		Reset via mechanical spring, external pilot air supply, flow direction not reversible	8036703 VUVS-LT30-T32C-MZD-G38-F8-1C1
	<b>Single solenoid, normally closed, type B</b>		
	T32C	Reset via mechanical spring, internal pilot air supply, flow direction not reversible	8036704 VUVS-LT30-T32C-MD-G38-F8-1B2
		Reset via mechanical spring, external pilot air supply, flow direction not reversible	8036705 VUVS-LT30-T32C-MZD-G38-F8-1B2
	<b>Single solenoid, normally open, type C</b>		
	T32U	Reset via mechanical spring, internal pilot air supply, flow direction not reversible	8036709 VUVS-LT30-T32U-MD-G38-F8-1C1
		Reset via mechanical spring, external pilot air supply, flow direction not reversible	8036710 VUVS-LT30-T32U-MZD-G38-F8-1C1
	<b>Single solenoid, normally open, type B</b>		
	T32U	Reset via mechanical spring, internal pilot air supply, flow direction not reversible	8036711 VUVS-LT30-T32U-MD-G38-F8-1B2
		Reset via mechanical spring, external pilot air supply, flow direction not reversible	8036712 VUVS-LT30-T32U-MZD-G38-F8-1B2
	<b>Single solenoid, 1x normally open, 1x normally closed, type C</b>		
	T32H	Reset via mechanical spring, internal pilot air supply, flow direction not reversible	8036716 VUVS-LT30-T32H-MD-G38-F8-1C1
		Reset via mechanical spring, external pilot air supply, flow direction not reversible	8036717 VUVS-LT30-T32H-MZD-G38-F8-1C1
	<b>Single solenoid, 1x normally open, 1x normally closed, type B</b>		
	T32H	Reset via mechanical spring, internal pilot air supply, flow direction not reversible	8036718 VUVS-LT30-T32H-MD-G38-F8-1B2
		Reset via mechanical spring, external pilot air supply, flow direction not reversible	8036719 VUVS-LT30-T32H-MZD-G38-F8-1B2

## Accessories





Ordering data		Code	Valve function	Part no.	Type
<b>5/2-way valve without solenoid coil</b>					
	<b>Single solenoid</b>				
	M52	Reset via mechanical spring, internal pilot air supply, flow direction not reversible	8036686	VUVS-LT30-M52-MD-G38-F8	
		Reset via mechanical spring, external pilot air supply, flow direction not reversible	8036687	VUVS-LT30-M52-MZD-G38-F8	
	<b>Double solenoid</b>				
	B52	Internal pilot air supply, flow direction not reversible	8036693	VUVS-LT30-B52-D-G38-F8	
		External pilot air supply, flow direction not reversible	8036694	VUVS-LT30-B52-ZD-G38-F8	
	<b>5/2-way valve with solenoid coil (24 V DC)</b>				
		<b>Single solenoid, type C</b>			
M52-M		Reset via mechanical spring, internal pilot air supply, flow direction not reversible	8036688	VUVS-LT30-M52-MD-G38-F8-1C1	
		Reset via mechanical spring, external pilot air supply, flow direction not reversible	8036689	VUVS-LT30-M52-MZD-G38-F8-1C1	
<b>Single solenoid, type B</b>					
M52-M		Reset via mechanical spring, internal pilot air supply, flow direction not reversible	8036690	VUVS-LT30-M52-MD-G38-F8-1B2	
		Reset via mechanical spring, external pilot air supply, flow direction not reversible	8036691	VUVS-LT30-M52-MZD-G38-F8-1B2	
	<b>Double solenoid, type C</b>				
	B52	Internal pilot air supply, flow direction not reversible	8036695	VUVS-LT30-B52-D-G38-F8-1C1	
		External pilot air supply, flow direction not reversible	8036696	VUVS-LT30-B52-ZD-G38-F8-1C1	
	<b>Double solenoid, type B</b>				
	B52	Internal pilot air supply, flow direction not reversible	8036697	VUVS-LT30-B52-D-G38-F8-1B2	
		External pilot air supply, flow direction not reversible	8036698	VUVS-LT30-B52-ZD-G38-F8-1B2	

## Accessories



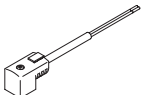

Ordering data		Description	Part no.	Type		
<b>Solenoid coils for valves</b>						
	Plug pattern type C, to DIN EN 175301-803	12 V DC	8030810	VACF-B-C1-5		
		24 V DC	8030811	VACF-B-C1-1		
		48 V DC	8030812	VACF-B-C1-7		
		24 V AC/50-60 Hz	8030813	VACF-B-C1-1A		
		48 V AC/50-60 Hz	8030814	VACF-B-C1-7A		
		110/120 V AC/50-60 Hz	8030815	VACF-B-C1-16B		
		230/240 V AC/50-60 Hz	8030817	VACF-B-C1-3W		
	Plug pattern type B, industry standard	12 V DC	8030801	VACF-B-B2-5		
		24 V DC	8030802	VACF-B-B2-1		
		48 V DC	8030803	VACF-B-B2-7		
		24 V AC/50-60 Hz	8030804	VACF-B-B2-1A		
		48 V AC/50-60 Hz	8030805	VACF-B-B2-7A		
		110/120 V AC/50-60 Hz	8030806	VACF-B-B2-16B		
		230/240 V AC/50-60 Hz	8030808	VACF-B-B2-3W		
	Plug pattern type A, to EN 175301-803	12 V DC	8030821	VACF-A-A1-5		
		24 V DC	8030822	VACF-A-A1-1		
		48 V DC	8030823	VACF-A-A1-7		
		24 V AC/50-60 Hz	8030824	VACF-A-A1-1A		
		48 V AC/50-60 Hz	8030825	VACF-A-A1-7A		
		110/120 V AC/50-60 Hz	8030826	VACF-A-A1-16B		
		230/240 V AC/50-60 Hz	8030828	VACF-A-A1-3W		
<b>Seal set for solenoid coil</b>						
	Plug pattern type C to guarantee protection class IP67	2643771	VAMC-B10-C-B-S8			
	Plug pattern type B to guarantee protection class IP67	8034609	VAMC-B10-B-B-S8			
	Plug pattern type A to guarantee protection class IP67	8034611	VAMC-B10-A-B-S8			
<b>Cover cap</b>						
	For manual override, non-detenting or covered	8028240	VAMC-B10-20-CH2			
<b>Plug socket</b>						
	<b>Plug pattern type C, to DIN EN 175301-803</b>					
	3-pin, screw terminal	Cable connector M12	0 ... 250 V AC/DC	IP65	539712	MSSD-EB-M12
		Cable connector Pg7			★ 151687	MSSD-EB
	4-pin, insulation displacement connector	Cable connector M14	0 ... 250 V AC/DC	IP67	192745	MSSD-EB-S-M14
	3-pin, angled socket	Cable connector M12	0 ... 24 V DC	IP65	570367	MSSD-EB-M12-24VDC-SD-EX
	<b>Plug pattern type B, industry standard</b>					
	3-pin, screw terminal	Cable connector M16	0 ... 250 V AC/DC	IP65	539710	MSSD-F-M16
		Cable connector Pg9			★ 34431	MSSD-F
	3-pin, insulation displacement connector	–	0 ... 250 V AC/DC	IP67	192746	MSSD-F-S-M16



## Accessories

Ordering data		Description	Part no.	Type		
<b>Plug socket</b>						
	<b>Plug pattern type A, to EN 175301-803</b>					
	3-pin, angled socket	Cable connector Pg9	0 ... 250 V AC/DC	IP65	34583	MSSD-C
	3-pin, angled socket	Cable connector M16	0 ... 250 V AC/DC	IP65	539709	MSSD-C-M16
	4-pin, angled socket	Cable connection, insulation displacement	0 ... 250 V AC/DC	IP67	192748	MSSD-C-S-M16
<b>Adapter</b>						
	Socket type C, to EN 175301-803	Plug connector M12x1, 2-pin, A-coded	12 ... 24 V AC/DC	IP65	188024	MSSD-EB-M12-MONO
<b>Plug socket with cable</b>						
	<b>Plug pattern type C, to DIN EN 175301-803</b>					
	Angled socket, 3-pin Cable, open end, 3-wire	24 V DC	LED	2.5 m	★ 151688	KMEB-1-24-2,5-LED
				5 m	151689	KMEB-1-24-5-LED
				10 m	193457	KMEB-1-24-10-LED
		230 V AC	-	2.5 m	151690	KMEB-1-230AC-2,5
				5 m	151691	KMEB-1-230AC-5
	<b>Plug pattern type B, industry standard</b>					
	Angled socket, 3-pin Cable, open end, 3-wire	24 V DC	LED	2.5 m	★ 30935	KMF-1-24DC-2,5-LED
				5 m	30937	KMF-1-24DC-5-LED
				10 m	193458	KMF-1-24-10-LED
		230 V AC	-	2.5 m	30936	KMF-1-230AC-2,5
				5 m	30938	KMF-1-230AC-5
	<b>Plug pattern type A, to EN 175301-803</b>					
	Angled socket, 3-pin Cable, open end, 3-wire	24 V DC	LED	2.5 m	30931	KMC-1-24DC-2,5-LED
				5 m	30933	KMC-1-24DC-5-LED
				10 m	193459	KMC-1-24-10-LED
230 V AC		-	2.5 m	30932	KMC-1-230AC-2,5	
			5 m	30934	KMC-1-230AC-5	
<b>Illuminating seal</b>						
	Plug pattern type C, to DIN EN 175301-803	24 V DC		151717	MEB-LD-12-24DC	
		230 V AC		151718	MEB-LD-230AC	
	Plug pattern type B, industry standard	24 V DC		19143	MF-LD-12-24DC	
		230 V AC		19144	MF-LD-230AC	

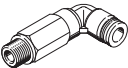
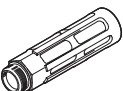
## Accessories



Ordering data	Description		Part no.	Type	PU <sup>1)</sup>
<b>Push-in fitting with internal hex</b>					
	Connecting thread G1/8 for tubing O.D.	4 mm	★ 186106	QS-G1/8-4-I	10
			133008	QS-G1/8-4-I-100	100
	Connecting thread G3/8 for tubing O.D.	8 mm	★ 186111	QS-G3/8-8-I	10
			10 mm	★ 186113	QS-G3/8-10-I
	12 mm	★ 186114	QS-G3/8-12-I	10	
<b>Angled push-in fitting with external hex</b>					
	Connecting thread G3/8 for tubing O.D.	8 mm	★ 186121	QSL-G3/8-8	10
			132055	QSL-G3/8-8-50	50
		10 mm	★ 186123	QSL-G3/8-10	10
			132056	QSL-G3/8-10-20	20
		12 mm	★ 186124	QSL-G3/8-12	10
	132057	QSL-G3/8-12-20	20		
<b>Angled push-in fitting, long, with external hex</b>					
	Connecting thread G3/8 for tubing O.D.	8 mm	186132	QSL-G3/8-8	10
		10 mm	186134	QSL-G3/8-10	10
		12 mm	186135	QSL-G3/8-12	10
<b>Silencer</b>					
	With connecting thread G, metal design	G3/8	6843	U-3/8-B	1
	With connecting thread G, sintered design, long	G3/8	★ 1205862	AMTE-M-LH-G38	10

1) Packaging unit

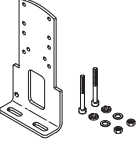
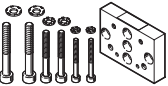
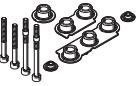
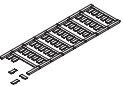
## Accessories

Ordering data	Description	Weight [g]	Part no.	Type
<b>Foot mounting</b>				
	With screw set for attaching the valve to the foot mounting	239	8026337	VAME-B10-30-A
<b>Wall mounting</b>				
	With screw set for attaching the valve to the wall mounting	53	576413	VAME-B10-20-W
<b>Assortment of spare parts</b>				
	Set comprising seals and screws	22	8035637	VAME-B10-30-MK
<b>Inscription label</b>				
	40 pieces in frame	-	565306	ASLR-C-E4

## Technical data

-  - Flow rate  
up to 700 l/min
-  - Valve width  
21 mm
-  - Voltage  
12, 24 V DC  
24, 110, 120, 230, 240 V AC

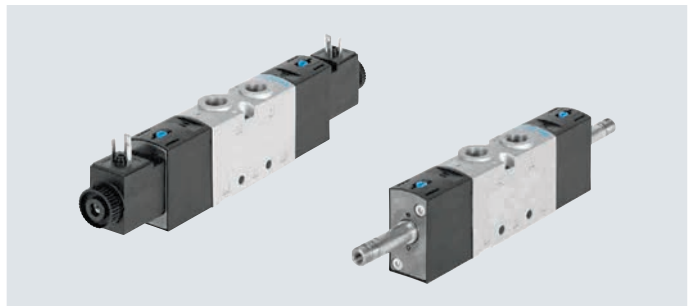

General technical data		3/2-way valve		5/2-way valve		5/3-way valve		
Valve function		3/2-way valve		5/2-way valve		5/3-way valve		
Order code for valves		M32C	M32U	M52	B52	P53C	P53U	P53E
Valve width	[mm]	21						
Nominal width	Diameter [mm]	5.7				5	4.8	4.5
Design		Piston spool						
Flow direction		Reversible with external pilot air supply						
Pilot air supply		Internal or external						
Type of control		Piloted						
Manual override		Non-detenting, detenting						
Overlap		Positive overlap						
Sealing principle		Soft						
Type of mounting		Optionally via through-hole or on manifold rail						
Standard nominal flow rate qnN	[l/min]	700		700	700	700	600	
Actuation type		Electric						
Mounting position		Any						
Exhaust air function		Can be throttled						
Pneumatic connection	1, 2, 3 4, 5	G1/8	G1/8	G1/8	G1/8	G1/8	G1/8	G1/8
Pilot air port 12/14		M5						
Pilot exhaust air port 82/84		M5						

ATEX	
Type	VUVS-L-...-EX2
ATEX category for gas	II 3G
Type of ignition protection for gas	Ex ec IICT4 Gc X
ATEX category for dust	II 3D
Type of ignition protection for dust	Ex tc IIIC T115°C Dc X
Explosion-proof ambient temperature [°C]	-10°C ≤ Ta ≤ +60°C
CE marking (see declaration of conformity) <sup>1)</sup>	To EU Explosion Protection Directive (ATEX)
UKCA marking (see declaration of conformity) <sup>1)</sup>	To UK EX instructions
Explosion protection certification outside the EU	EPL Dc (GB)
	EPL Gc (GB)

<sup>1)</sup> For information about the area of use, see the EC declaration of conformity at: [www.festo.com/catalogue/...](http://www.festo.com/catalogue/...) → Support/Downloads.  
If the devices are subject to usage restrictions in residential, commercial or light-industrial environments, further measures for the reduction of the emitted interference may be necessary.

## Technical data

Technical data – 3/2-way valves					
Order code for valves		M32C		M32U	
Normal position		Closed		Open	
Stable position		Monostable		Monostable	
Reset method		Pneumatic spring	Mechanical spring	Pneumatic spring	Mechanical spring
Switching times in [ms]	On	14	14	14	15
	Off	21	32	21	28
	Change over	–	–	–	–
Product weight without solenoid coil	[g]	138	136	138	136
Product weight with solenoid coil	[g]	172	170	172	170
Product weight with solenoid coil and plug socket	[g]	182	180	182	180

Technical data – 5/2-way valves					
Order code for valves		M52		B52	
Normal position		–		–	
Stable position		Monostable		Bistable	
Reset method		Pneumatic spring	Mechanical spring	–	
Switching times in [ms]	On	20	12	–	
	Off	29	44	–	
	Change over	–	–	10	
Product weight without solenoid coil	[g]	188	183	225	
Product weight with solenoid coil	[g]	222	217	259	
Product weight with solenoid coil and plug socket	[g]	232	227	279	

Technical data – 5/3-way valves					
Order code for valves		P53C		P53U	P53E
Normal position/mid-position		Closed		Pressurised	Exhausted
Stable position		Monostable			
Reset method		Mechanical spring			
Switching times in [ms]	On	13	13	13	
	Off	42	42	44	
	Change over	24	21	24	
Product weight without solenoid coil	[g]	229	229	229	
Product weight with solenoid coil	[g]	263	263	263	
Product weight with solenoid coil and plug socket	[g]	283	283	283	

Safety data		
Max. positive test pulse with logic 0	[is]	1900 (valves with VACS-C-C1-1)
Max. negative test pulse with logic 1	[is]	2700 (valves with VACS-C-C1-1)
Shock resistance		Shock test with severity level 2 to FN 942017-5 and EN 60068-2-27
Vibration resistance		Transport application test with severity level 2 to FN 942017-4 and EN 60068-2-6

## Technical data

Operating and environmental conditions		M32	M52	B52	P53
Order code for valves					
Operating medium		Compressed air to ISO 8573-1:2010 [7:4:4]			
Pilot medium		Compressed air to ISO 8573-1:2010 [7:4:4]			
Note on operating/pilot medium		Lubricated operation possible (in which case lubricated operation will always be required)			
Operating pressure with internal pilot air supply	[MPa]	0.25 ... 1		0.15 ... 1	0.25 ... 1
	[bar]	2.5 ... 10		1.5 ... 10	2.5 ... 10
Operating pressure with external pilot air supply	[MPa]	-0.09 ... +1			
	[bar]	-0.9 ... +10			
Pilot pressure	[MPa]	0.25 ... 1		0.15 ... 1	0.25 ... 1
	[bar]	2.5 ... 10		1.5 ... 10	2.5 ... 10
Ambient temperature	[°C]	-10 ... +60			
Temperature of medium	[°C]	-10 ... +60			
Certification		c UL us - Recognized (OL)			
Corrosion resistance class CRC <sup>1)</sup>		2			

1) Corrosion resistance class CRC 2 to Festo standard FN 940070

Moderate corrosion stress. Indoor applications in which condensation can occur. External visible parts with primarily decorative surface requirements which are in direct contact with a normal industrial environment.

Electrical data		With solenoid coil	Without solenoid coil
Electrical connection		Plug type C to EN 175301-803	Via solenoid coil
Operating voltage	[V DC]	12, and 24 ±10%	→ Internet: vacs
	[V AC]	24, 110, 120, 230, 240 ±10%	
Permissible voltage fluctuations	[%]	±10	
Power	[W]	2.6	
Duty cycle	[%]	100	
Degree of protection to EN 60529		IP65 with plug socket	

Materials	
Housing	Die-cast aluminium
Seals	HNBR, NBR
Piston spool	Wrought aluminium alloy (P53 types: High-alloy stainless steel)
Screws	Galvanised steel
Note on materials	RoHS-compliant

Technical data

Dimensions

Download CAD data → [www.festo.com](http://www.festo.com)

3/2-way valves, with solenoid coil

3/2-way valves, without solenoid coil

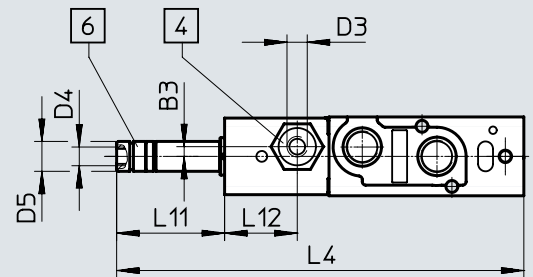
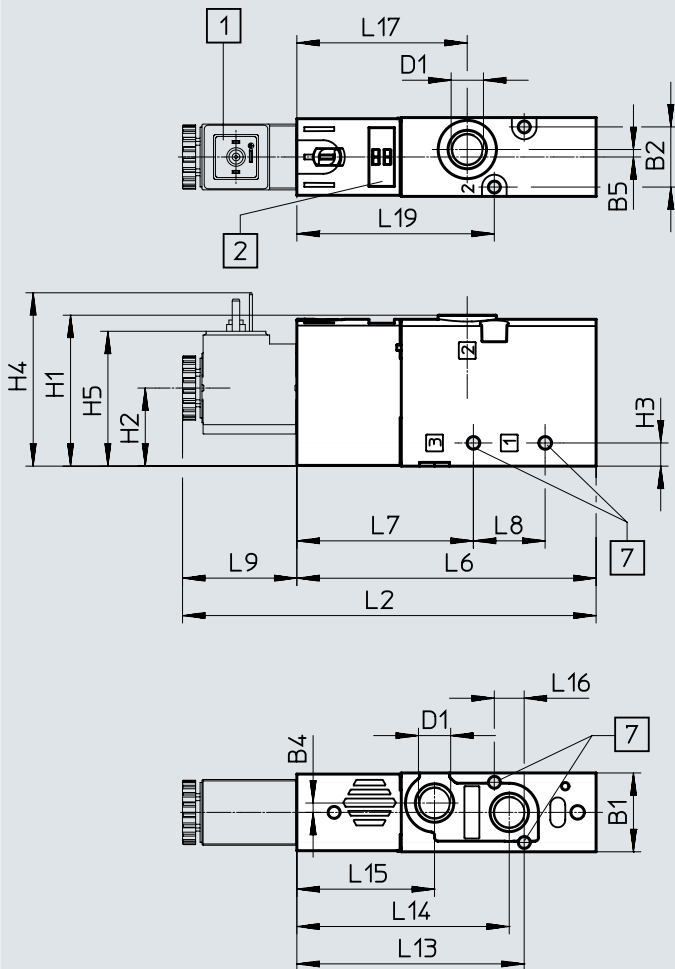

[1] Solenoid coil interface type C  
[2] Space for inscription label

[3] Port 10/12 for pilot air supply  
[4] Port 82 for pilot exhaust air

[5] For screw M3

[6] For screw M4

Type	B1	B2	B3	B4	B5	D1	D3	D4	D5 ∅	H1	H2	H3	H4	H5
VUVS-L20-M32...-D-G18-...	21.1	16.1	-	2.5	2	G1/8	-	M5	8	40.4	20.9	5.8	46.7	36.4
VUVS-L20-M32...-ZD-G18-...			2.6				M5							

Type	L2	L4	L6	L7	L8	L9	L11	L12	L13	L14	L15	L16	L17	L19	L20
VUVS-L20-M32...-D-G18-...	110.7	109.1	80.1	47.9	18	30.6	29	-	60.9	56.9	36.9	8	45.6	52.9	2
VUVS-L20-M32...-ZD-G18-...								19.5							

Technical data

Dimensions

Download CAD data → [www.festo.com](http://www.festo.com)

5/2-way single solenoid valves, with solenoid coil

5/2-way single solenoid valves, without solenoid coil

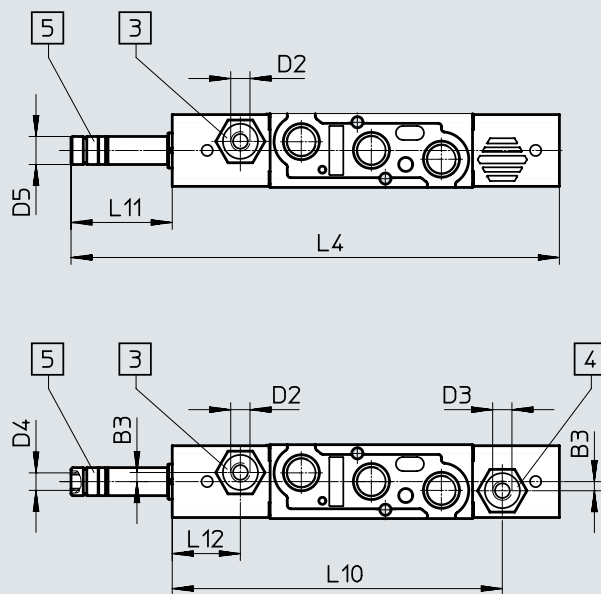
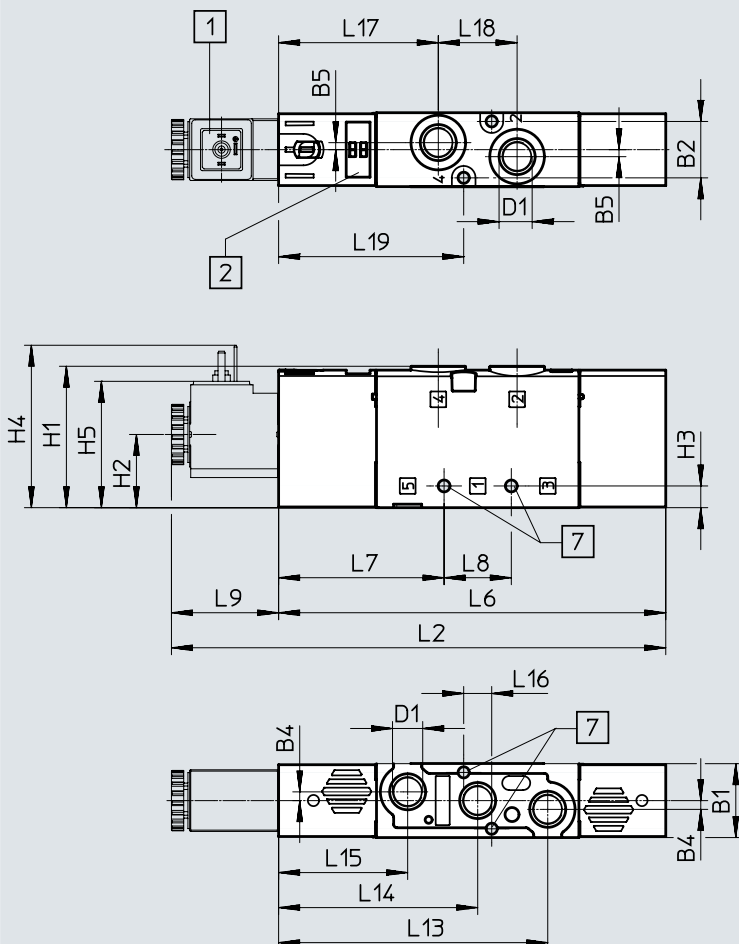

- [1] Solenoid coil interface type C
- [2] Space for inscription label
- [3] Port 14 for pilot air supply
- [4] Port 12 for pilot air supply
- [5] Port 84 for pilot exhaust air
- [6] For screw M3
- [7] For screw M4

Type	B1	B2	B3	B4	B5	D1	D2	D3	D4	D5 ø	H1	H2	H3	H4	H5
VUVS-L20-M52-...D-G18-...	21.1	16.1	-	2.5	2	G1/8	-	-	M5	8	40.4	20.9	5.8	46.7	36.4
VUVS-L20-M52-...ZD-G18-...			2.6				M5	M5							

Type	L2	L4	L6	L7	L8	L9	L10	L11	L12	L13	L14	L15	L16	L17	L18	L19	L20
VUVS-L20-M52-...D-G18-...	141.2	139.6	110.6	47.9	18	30.6	-	29	-	76.9	56.9	36.9	8	45.6	22.5	52.9	2
VUVS-L20-M52-...ZD-G18-...							94.3		19.5								



Technical data

Dimensions

5/3-way valves and 5/2-way double solenoid valves, with solenoid coil

5/3-way valves and 5/2-way double solenoid valves, without solenoid coil

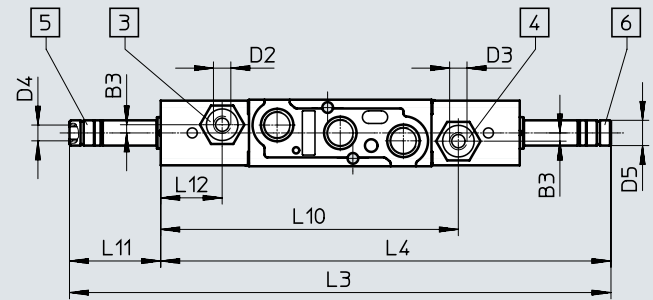
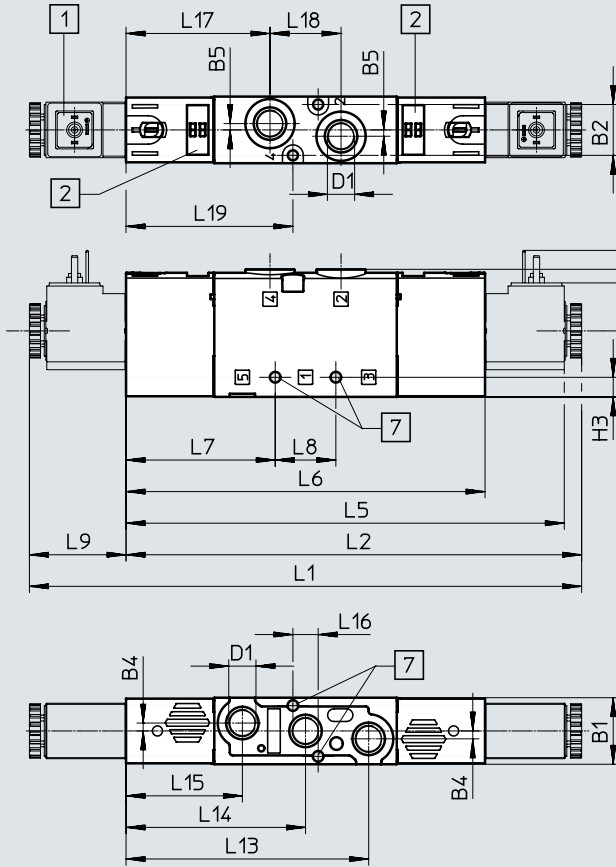

- [1] Solenoid coil interface type C
- [2] Space for inscription label
- [3] Port 14 for pilot air supply
- [4] Port 12 for pilot air supply

- [5] Port 84 for pilot exhaust air
- [6] Port 82 for pilot exhaust air
- [7] For screw M3
- [8] For screw M4

Type	B1	B2	B3	B4	B5	D1	D2	D3	D4	D5	H1	H2	H3	H4	H5
VUVS-L20-P53...-MD-G18-...	21.1	16.1	-	2.5	2	G1/8	-	-	M5	8	40.4	20.9	5.8	46.7	36.4
VUVS-L20-P53...-MZD-G18-...			2.6				M5	M5							
VUVS-L20-B52-D-G18-...			-				-	-							
VUVS-L20-B52-ZD-G18-...			2.6				M5	M5							

Type	L1	L2	L3	L4	L5	L6	L7	L8	L9	L10	L11
VUVS-L20-P53...-MD-G18-...	174.9	144.3	171.7	142.7	139.1	113.7	47.9	18	30.6	-	29
VUVS-L20-P53...-MZD-G18-...										94.3	
VUVS-L20-B52-D-G18-...										-	
VUVS-L20-B52-ZD-G18-...										94.3	

Type	L12	L13	L14	L15	L16	L17	L18	L19	L20
VUVS-L20-P53...-MD-G18-...	-	76.9	56.9	36.9	8	45.6	22.5	52.9	2
VUVS-L20-P53...-MZD-G18-...	19.5								
VUVS-L20-B52-D-G18-...	-								
VUVS-L20-B52-ZD-G18-...	19.5								

Accessories

Dimensions

Download CAD data → [www.festo.com](http://www.festo.com)

Foot mounting

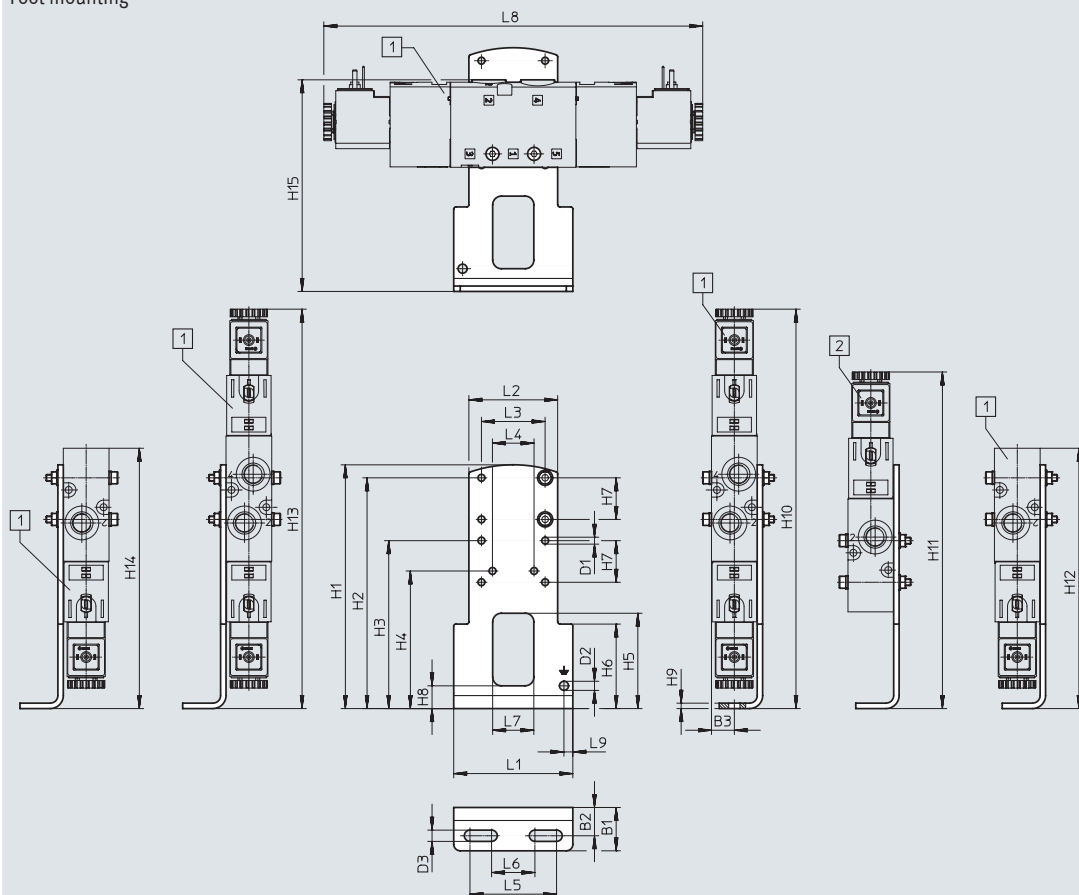

[1] VUVS-L20-B52,  
VUVS-L20-P53,  
VUVS-L20-M52,  
VUVS-L20-M32

[2] VUVS-L20-M52,  
VUVS-L20-M32

Type		B1	B2	B3	D1 ∅	D2 ∅	D3	H1	H2	H3	H4
VAME-B10-20-A	VUVS-L20-B52/P53	20	13.1	10.6	3.2	4.2	5.2	112.5	106.5	77.5	63.5
	VUVS-L20-M52										
	VUVS-L20-M32										

Type		H5	H6	H7	H8	H9	H10	H11	H12	H13	H14
VAME-B10-20-A	VUVS-L20-B52/P53	44	39	19.2	10.5	2.5	184.4	–	184.4	184.4	184.4
	VUVS-L20-M52							155.4	150.6	150.6	
	VUVS-L20-M32							120.2	120.2	120.2	

Type		H15	L1	L2	L3	L4	L5	L6	L7	L8	L9
VAME-B10-20-A	VUVS-L20-B52/P53	97.7	55	41	29.4	19.2	40	20	19	174.9	4.1
	VUVS-L20-M52									141.2	
	VUVS-L20-M32									110.7	

Technical data

Dimensions

Download CAD data → [www.festo.com](http://www.festo.com)

Wall mounting

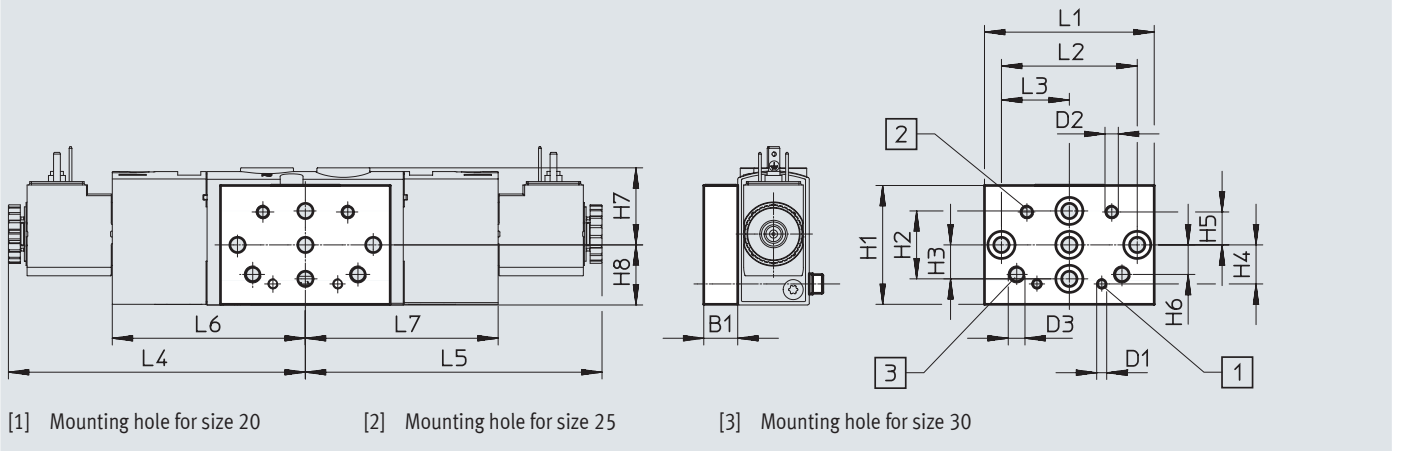

Type		B1	D1	D2	D3	H1	H2	H3	H4	H5	H6
VAME-B10-20-W	VUVS-L20-B52/P53	10	M3	M4	M5	35	20	10	11.5	9.7	8.7
	VUVS-L20-M52										
	VUVS-L20-M32										

Type		H7	H8	L1	L2	L3	L4	L5	L6	L7
VAME-B10-20-W	VUVS-L20-B52/P53	22.7	17.7	50	40	20	87.5	87.5	56.9	56.9
	VUVS-L20-M52							53.7		-
	VUVS-L20-M32							23.3		-

## Accessories

## ★ Core product range

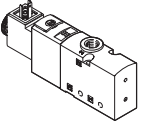
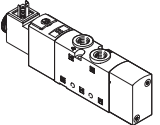
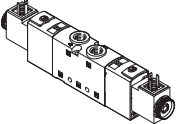
Ordering data			
	Code	Valve function	Part no.   Type
<b>3/2-way valve with solenoid coil (24 V DC)</b>			
	<b>Single solenoid, normally closed, type C</b>		
	M32C-M	Reset via mechanical spring, internal pilot air supply, flow direction not reversible	★ 575274   VUVS-L20-M32C-MD-G18-F7-1C1
<b>5/2-way valve with solenoid coil (24 V DC)</b>			
	<b>Single solenoid, type C</b>		
	M52-A	Reset via pneumatic spring, internal pilot air supply, flow direction not reversible	★ 575263   VUVS-L20-M52-AD-G18-F7-1C1
	M52-M	Reset via mechanical spring, internal pilot air supply, flow direction not reversible	★ 575264   VUVS-L20-M52-MD-G18-F7-1C1
<b>5/3-way valve with solenoid coil (24 V DC)</b>			
	<b>Mid-position closed, type C</b>		
	P53C	Reset via mechanical spring, internal pilot air supply, flow direction not reversible	★ 575268   VUVS-L20-P53C-MD-G18-F7-1C1

## Accessories

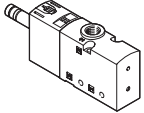
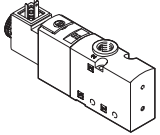
Ordering data				
	Code	Valve function	Part no.	Type
<b>3/2-way valve without solenoid coil</b>				
	<b>Single solenoid, normally closed</b>			
	M32C-A	Reset via pneumatic spring, internal pilot air supply, flow direction not reversible	575255	VUVS-L20-M32C-AD-G18-F7
		Reset via pneumatic spring, external pilot air supply, flow direction reversible	575257	VUVS-L20-M32C-AZD-G18-F7
	M32C-M	Reset via mechanical spring, internal pilot air supply, flow direction not reversible	575260	VUVS-L20-M32C-MD-G18-F7
		Reset via mechanical spring, external pilot air supply, flow direction reversible	575259	VUVS-L20-M32C-MZD-G18-F7
	<b>Single solenoid, normally open</b>			
	M32U-A	Reset via pneumatic spring, internal pilot air supply, flow direction not reversible	575256	VUVS-L20-M32U-AD-G18-F7
		Reset via pneumatic spring, external pilot air supply, flow direction reversible	575258	VUVS-L20-M32U-AZD-G18-F7
	M32U-M	Reset via mechanical spring, internal pilot air supply, flow direction not reversible	575262	VUVS-L20-M32U-MD-G18-F7
		Reset via mechanical spring, external pilot air supply, flow direction reversible	575261	VUVS-L20-M32U-MZD-G18-F7
<b>3/2-way valve with solenoid coil (24 V DC)</b>				
	<b>Single solenoid, normally closed, type C</b>			
	M32C-A	Reset via pneumatic spring, internal pilot air supply, flow direction not reversible	575269	VUVS-L20-M32C-AD-G18-F7-1C1
		Reset via pneumatic spring, external pilot air supply, flow direction reversible	575271	VUVS-L20-M32C-AZD-G18-F7-1C1
	M32C-M	Reset via mechanical spring, external pilot air supply, flow direction reversible	575273	VUVS-L20-M32C-MZD-G18-F7-1C1
	<b>Single solenoid, normally open, type C</b>			
	M32U-A	Reset via pneumatic spring, internal pilot air supply, flow direction not reversible	575270	VUVS-L20-M32U-AD-G18-F7-1C1
		Reset via pneumatic spring, external pilot air supply, flow direction reversible	575272	VUVS-L20-M32U-AZD-G18-F7-1C1
	M32U-M	Reset via mechanical spring, internal pilot air supply, flow direction not reversible	575276	VUVS-L20-M32U-MD-G18-F7-1C1
		Reset via mechanical spring, external pilot air supply, flow direction reversible	575275	VUVS-L20-M32U-MZD-G18-F7-1C1



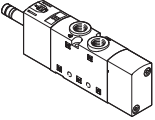
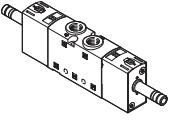
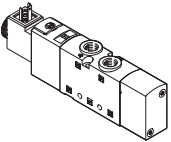
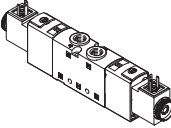

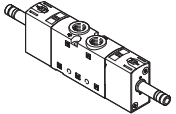
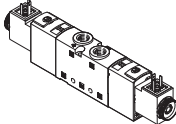

Accessories

Ordering data			
	Code	Valve function	Part no.   Type
<b>5/2-way valve without solenoid coil</b>			
	<b>Single solenoid</b>		
	M52-A	Reset via pneumatic spring, internal pilot air supply, flow direction not reversible	575249   VUVS-L20-M52-AD-G18-F7
		Reset via pneumatic spring, external pilot air supply, flow direction reversible	575675   VUVS-L20-M52-AZD-G18-F7
	M52-M	Reset via mechanical spring, internal pilot air supply, flow direction not reversible	575250   VUVS-L20-M52-MD-G18-F7
		Reset via mechanical spring, external pilot air supply, flow direction reversible	575679   VUVS-L20-M52-MZD-G18-F7
	<b>Double solenoid</b>		
	B52	Internal pilot air supply, flow direction not reversible	575251   VUVS-L20-B52-D-G18-F7
		External pilot air supply, flow direction reversible	575682   VUVS-L20-B52-ZD-G18-F7
<b>5/2-way valve with solenoid coil (24 V DC)</b>			
	<b>Single solenoid, type C</b>		
	M52-A	Reset via pneumatic spring, external pilot air supply, flow direction reversible	575676   VUVS-L20-M52-AZD-G18-F7-1C1
	M52-M	Reset via mechanical spring, external pilot air supply, flow direction reversible	575680   VUVS-L20-M52-MZD-G18-F7-1C1
	<b>Double solenoid, type C</b>		
	B52	Internal pilot air supply, flow direction not reversible	575265   VUVS-L20-B52-D-G18-F7-1C1
		External pilot air supply, flow direction reversible	575683   VUVS-L20-B52-ZD-G18-F7-1C1

## Accessories



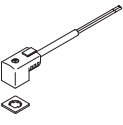



Ordering data				
	Code	Valve function	Part no.	Type
<b>5/3-way valve without solenoid coil</b>				
	<b>Mid-position closed</b>			
	P53C	Reset via mechanical spring, internal pilot air supply, flow direction not reversible	575254	VUVS-L20-P53C-MD-G18-F7
		Reset via mechanical spring, external pilot air supply, flow direction reversible	575685	VUVS-L20-P53C-MZD-G18-F7
	<b>Mid-position exhausted</b>			
	P53E	Reset via mechanical spring, internal pilot air supply, flow direction not reversible	575252	VUVS-L20-P53E-MD-G18-F7
		Reset via mechanical spring, external pilot air supply, flow direction reversible	575691	VUVS-L20-P53E-MZD-G18-F7
	<b>Mid-position pressurised</b>			
	P53U	Reset via mechanical spring, internal pilot air supply, flow direction not reversible	575253	VUVS-L20-P53U-MD-G18-F7
		Reset via mechanical spring, external pilot air supply, flow direction reversible	575688	VUVS-L20-P53U-MZD-G18-F7
<b>5/3-way valve with solenoid coil (24 V DC)</b>				
	<b>Mid-position closed, type C</b>			
	P53C	Reset via mechanical spring, external pilot air supply, flow direction reversible	575686	VUVS-L20-P53C-MZD-G18-F7-1C1
	<b>Mid-position exhausted, type C</b>			
	P53E	Reset via mechanical spring, internal pilot air supply, flow direction not reversible	575266	VUVS-L20-P53E-MD-G18-F7-1C1
		Reset via mechanical spring, external pilot air supply, flow direction reversible	575692	VUVS-L20-P53E-MZD-G18-F7-1C1
	<b>Mid-position pressurised, type C</b>			
	P53U	Reset via mechanical spring, internal pilot air supply, flow direction not reversible	575267	VUVS-L20-P53U-MD-G18-F7-1C1
	Reset via mechanical spring, external pilot air supply, flow direction reversible	575689	VUVS-L20-P53U-MZD-G18-F7-1C1	

## Accessories

Ordering data		Description	Part no.		Type	
<b>Solenoid coils for valves</b>						
	Plug pattern type C, to DIN EN 175301-803	12 V DC		<b>8025331</b>	VACS-C-C1-5	
		24 V DC		<b>8025330</b>	VACS-C-C1-1	
		48 V DC		<b>8025336</b>	VACS-C-C1-7	
		24 V AC/50-60 Hz		<b>8025335</b>	VACS-C-C1-1A	
		48 V AC/50-60 Hz		<b>8025337</b>	VACS-C-C1-7A	
		110/120 V AC/50-60 Hz		<b>8025334</b>	VACS-C-C1-16B	
		230/240 V AC/50-60 Hz		<b>8025338</b>	VACS-C-C1-3W	
<b>Seal set</b>						
	For valves in order to guarantee protection class IP67			<b>2643771</b>	VAMC-B10-C-B-S8	
<b>Cover cap</b>						
	For manual override, non-detenting or covered			<b>8028240</b>	VAMC-B10-20-CH2	
<b>Plug socket</b>						
	<b>Plug pattern type C, to DIN EN 175301-803</b>					
	3-pin, screw terminal	Cable connector M12	0 ... 250 V AC/DC	IP65	<b>539712</b>	MSSD-EB-M12
		Cable connector Pg7			★ <b>151687</b>	MSSD-EB
	4-pin, insulation displacement connector	Cable connector M14	0 ... 250 V AC/DC	IP67	<b>192745</b>	MSSD-EB-S-M14
3-pin, angled socket		Cable connector M12			0 ... 24 V DC	IP65
<b>Adapter</b>						
	Socket type C, to EN 175301-803	Plug connector M12x1, 2-pin, A-coded	12 ... 24 V AC/DC	IP65	<b>188024</b>	MSSD-EB-M12-MONO
<b>Plug socket with cable</b>						
	<b>Plug pattern type C, to DIN EN 175301-803</b>					
	Angled socket, 3-pin Cable, open end, 3-wire	24 V DC	LED	2.5 m	★ <b>151688</b>	KMEB-1-24-2,5-LED
				5 m	<b>151689</b>	KMEB-1-24-5-LED
				10 m	<b>193457</b>	KMEB-1-24-10-LED
	230 V AC	-	2.5 m	<b>151690</b>	KMEB-1-230AC-2,5	
			5 m	<b>151691</b>	KMEB-1-230AC-5	
<b>Illuminating seal</b>						
	Plug pattern type C, to DIN EN 175301-803	24 V DC		<b>151717</b>	MEB-LD-12-24DC	
		230 V AC		<b>151718</b>	MEB-LD-230AC	

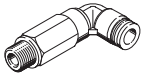





## Accessories

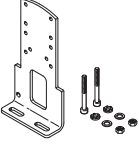
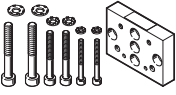

Ordering data					
	Description		Part no.	Type	PU <sup>1)</sup>
<b>Push-in fitting with internal hex</b>					
	Connecting thread M5 for tubing O.D.	4 mm	★ 153315	QSM-M5-4-I	10
	Connecting thread G1/8 for tubing O.D.	4 mm	★ 186106	QS-G1/8-4-I	10
			133008	QS-G1/8-4-I-100	100
		6 mm	★ 186107	QS-G1/8-6-I	10
			133009	QS-G1/8-6-I-100	100
		8 mm	★ 186109	QS-G1/8-8-I	10
133010			QS-G1/8-8-I-100	100	
<b>Angled push-in fitting with external hex</b>					
	Connecting thread G1/8 for tubing O.D.	4 mm	★ 186116	QSL-G1/8-4	10
			132048	QSL-G1/8-4-100	100
		6 mm	★ 186117	QSL-G1/8-6	10
			132049	QSL-G1/8-6-100	100
		8 mm	★ 186119	QSL-G1/8-8	10
			132050	QSL-G1/8-8-50	50
<b>Angled push-in fitting, long, with external hex</b>					
	Connecting thread G1/8 for tubing O.D.	4 mm	186127	QSL-G1/8-4	10
			133015	QSL-G1/8-4-100	100
		6 mm	186128	QSL-G1/8-6	10
			133016	QSL-G1/8-6-100	100
		8 mm	186130	QSL-G1/8-8	10
			133017	QSL-G1/8-8-100	100
<b>Silencer</b>					
	With connecting thread G, polymer design	G1/8	★ 2307	U-1/8	1
			534222	U-1/8-50	50
	With connecting thread G, metal design	G1/8	6841	U-1/8-B	1
	With connecting thread G, sintered design, long	G1/8	★ 1205860	AMTE-M-LH-G18	20

1) Packaging unit

## Accessories

Ordering data		Description	Weight [g]	Part no.	Type
<b>Foot mounting</b>					
	With screw set for attaching the valve to the foot mounting	97	576412	VAME-B10-20-A	
<b>Wall mounting</b>					
	With screw set for attaching the valve to the wall mounting	53	576413	VAME-B10-20-W	
<b>Assortment of spare parts</b>					
	Set comprising seals and screws	10	8026203	VAME-B10-20-MK	
<b>Inscription label</b>					
	40 pieces in frame	-	565306	ASLR-C-E4	
<b>Mounting kit</b>					
	With mounting bracket for lateral valve mounting	For standards-based cylinder DSBC-32...40	76	2568514	DAVM-MW-V1-32-V

## Technical data

-  - Flow rate  
up to 1300 l/min
-  - Valve width  
26.5 mm
-  - Voltage  
12, 24 V DC  
24, 110, 120, 230, 240 V AC

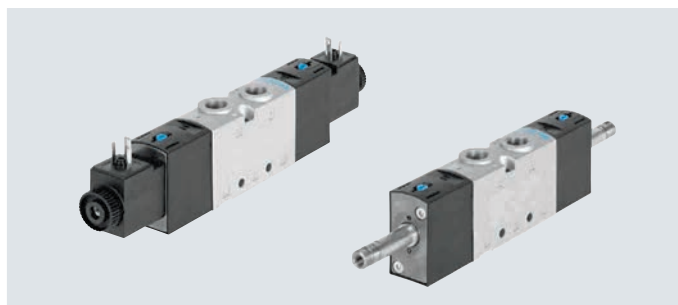

General technical data		3/2-way valve		5/2-way valve		5/3-way valve		
Valve function								
Order code for valves		M32C	M32U	M52	B52	P53C	P53U	P53E
Valve width	[mm]	26.5						
Nominal width	Diameter [mm]	6.3		6.9		6.5		6.3
Design		Piston spool						
Flow direction		Reversible with external pilot air supply						
Pilot air supply		Internal or external						
Type of control		Piloted						
Manual override		Non-detenting, detenting						
Overlap		Positive overlap						
Sealing principle		Soft						
Type of mounting		Optionally via through-hole or on manifold rail						
Standard nominal flow rate q <sub>N</sub>	[l/min]	1000		1300		1300		1200
Actuation type		Electric						
Mounting position		Any						
Exhaust air function		Can be throttled						
Pneumatic connection	1, 2, 3 4, 5	G1/4	G1/4	G1/4	G1/4	G1/4	G1/4	G1/4
Pilot air port 12/14		M5						
Pilot exhaust air port 82/84		M5						

ATEX	
Type	VUVS-L-...-EX2
ATEX category for gas	II 3G
Type of ignition protection for gas	Ex ec IICT4 Gc X
ATEX category for dust	II 3D
Type of ignition protection for dust	Ex tc IIIC T115°C Dc X
Explosion-proof ambient temperature [°C]	-10°C ≤ Ta ≤ +60°C
CE marking (see declaration of conformity) <sup>1)</sup>	To EU Explosion Protection Directive (ATEX)
UKCA marking (see declaration of conformity) <sup>1)</sup>	To UK EX instructions
Explosion protection certification outside the EU	EPL Dc (GB) EPL Gc (GB)

<sup>1)</sup> For information about the area of use, see the EC declaration of conformity at: [www.festo.com/catalogue/...](http://www.festo.com/catalogue/...) → Support/Downloads.

If the devices are subject to usage restrictions in residential, commercial or light-industrial environments, further measures for the reduction of the emitted interference may be necessary.

## Technical data

Technical data – 3/2-way valves					
Order code for valves		M32C		M32U	
Normal position		Closed		Open	
Stable position		Monostable		Monostable	
Reset method		Pneumatic spring	Mechanical spring	Pneumatic spring	Mechanical spring
Switching times in [ms]	On	13	11	12	11
	Off	26	40	26	39
	Change over	–	–	–	–
Product weight without solenoid coil	[g]	244	244	244	244
Product weight with solenoid coil	[g]	297	297	297	297

Technical data – 5/2-way valves					
Order code for valves		M52		B52	
Normal position		–		–	
Stable position		Monostable		Bistable	
Reset method		Pneumatic spring	Mechanical spring	–	
Switching times in [ms]	On	19	12	–	
	Off	35	47	–	
	Change over	–	–	11	
Product weight without solenoid coil	[g]	311	311	322	
Product weight with solenoid coil	[g]	363	363	428	

Technical data – 5/3-way valves					
Order code for valves		P53C		P53U	P53E
Normal position/mid-position		Closed		Pressurised	Exhausted
Stable position		Monostable			
Reset method		Mechanical spring			
Switching times in [ms]	On	13	14	14	
	Off	42	48	48	
	Change over	26	25	25	
Product weight without solenoid coil	[g]	324	324	324	
Product weight with solenoid coil	[g]	430	430	430	

Safety data		
Max. positive test pulse with logic 0	[s]	2000 (valves with VACF-B-...-1)
Max. negative test pulse with logic 1	[s]	3600 (valves with VACF-B-...-1)
Shock resistance		Shock test with severity level 2 to FN 942017-5 and EN 60068-2-27
Vibration resistance		Transport application test with severity level 2 to FN 942017-4 and EN 60068-2-6

## Technical data

Operating and environmental conditions		M32	M52	B52	P53
Order code for valves					
Operating medium		Compressed air to ISO 8573-1:2010 [7:4:4]			
Pilot medium		Compressed air to ISO 8573-1:2010 [7:4:4]			
Note on operating/pilot medium		Lubricated operation possible (in which case lubricated operation will always be required)			
Operating pressure with internal pilot air supply	[MPa]	0.25 ... 1		0.15 ... 1	0.25 ... 1
	[bar]	2.5 ... 10		1.5 ... 10	2.5 ... 10
Operating pressure with external pilot air supply	[MPa]	-0.09 ... +1			
	[bar]	-0.9 ... +10			
Pilot pressure	[MPa]	0.25 ... 1		0.15 ... 1	0.25 ... 1
	[bar]	2.5 ... 10		1.5 ... 10	2.5 ... 10
Ambient temperature	[°C]	-10 ... +60			
Temperature of medium	[°C]	-10 ... +60			
Certification		c UL us - Recognized (OL)			
Maritime classification <sup>1)</sup>		See certificate (for VUVS-...-F8 and VUVS-...-F8-...-B2 only)			
Corrosion resistance class CRC <sup>2)</sup>		2			

1) Additional information is available at [www.festo.com/catalogue/...](http://www.festo.com/catalogue/...) → Support/Downloads.

2) Corrosion resistance class CRC 2 to Festo standard FN 940070

Moderate corrosion stress. Indoor applications in which condensation can occur. External visible parts with primarily decorative surface requirements which are in direct contact with a normal industrial environment.

Electrical data		With solenoid coil	Without solenoid coil
Electrical connection		Plug type C to EN 175301-803, plug type B to industry standard (11 mm)	Via solenoid coil → Internet: vacf
Operating voltage	[V DC]	12, and 24 ±10%	
	[V AC]	24, 110, 120, 230, 240 ±10%	
Permissible voltage fluctuations	[%]	10	
Power (24 V DC)	[W]	3.3	
Duty cycle	[%]	100	
Degree of protection to EN 60529		IP65 with plug socket	

Materials	
Housing	Die-cast aluminium
Seals	HNBR, NBR
Piston spool	Wrought aluminium alloy
Screws	Galvanised steel
Note on materials	RoHS-compliant

Technical data

Dimensions

Download CAD data → [www.festo.com](http://www.festo.com)

3/2-way valves, with solenoid coil

3/2-way valves, without solenoid coil

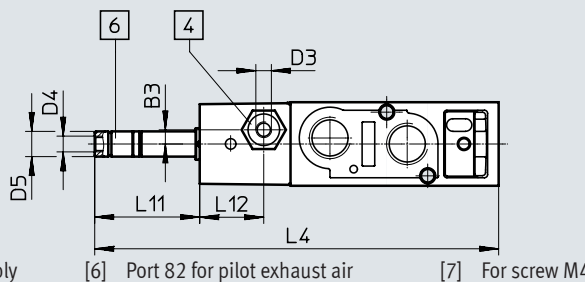
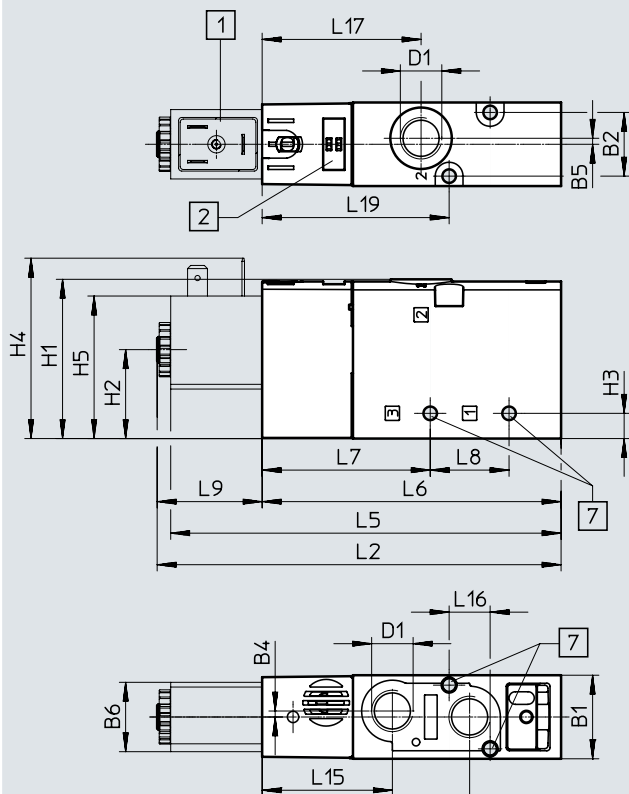

- [1] Solenoid coil interface type B/  
type C
- [2] Space for inscription label
- [4] Port 10/12 for pilot air supply
- [6] Port 82 for pilot exhaust air
- [7] For screw M4

Type	B1	B2	B3	B4	B5	B6	D1	D3	D4	D5 ∅	H1	H2	H3	H4	H5
VUVS-L25-M32.....D-G14-...	26.5	20.2	-	1.9	1.9	22	G1/4	-	M5	8	50.5	28.2	8	57.2	45.2
VUVS-L25-M32.....ZD-G14-...			4.5					M5							

Type	L2	L4	L5	L6	L7	L8	L9	L11	L12	L14	L15	L16	L17	L19
VUVS-L25-M32.....D-G14-...	129.2	128.1	123.8	94.8	53.3	25	34.4	33.3	-	65.8	41.3	13	50.4	59.3
VUVS-L25-M32.....ZD-G14-...									20.3					

Technical data

Dimensions

Download CAD data → [www.festo.com](http://www.festo.com)

5/2-way single solenoid valves, with solenoid coil

5/2-way single solenoid valves, without solenoid coil

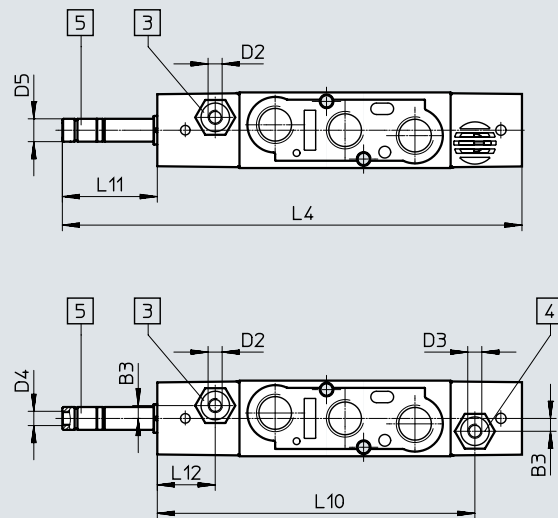
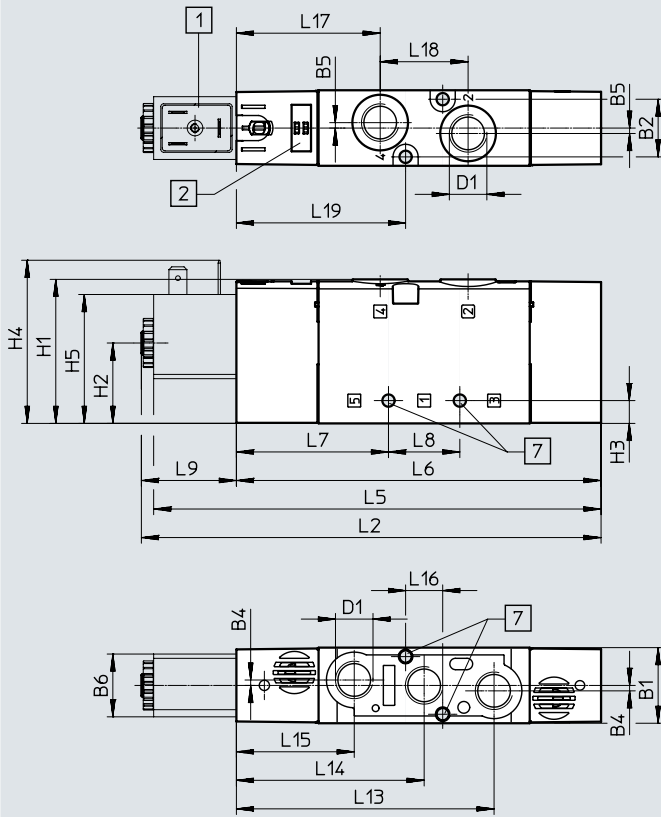

- [1] Solenoid coil interface type B/  
type C
- [2] Space for inscription label
- [3] Port 14 for pilot air supply
- [4] Port 12 for pilot air supply
- [5] Port 84 for pilot exhaust air
- [7] For screw M4

Type	B1	B2	B3	B4	B5	B6	D1	D2	D3	D4	D5 ∅	H1	H2	H3	H4	H5
VUVS-L25-M52-...D-G14-...	26.5	20.2	-	1.9	1.9	22	G1/4	-	-	M5	8	50.5	28.2	8	57.2	45.2
VUVS-L25-M52-...ZD-G14-...			4.5					M5	M5							

Type	L2	L4	L5	L6	L7	L8	L9	L10	L11	L12	L13	L14	L15	L16	L17	L18	L19
VUVS-L25-M52-...D-G14-...	162.2	161.1	156.8	127.8	53.3	25	34.4	-	33.3	-	90.3	65.8	41.3	13	50.4	30.8	59.3
VUVS-L25-M52-...ZD-G14-...								111.3		20.3							

Technical data

Dimensions

Download CAD data → [www.festo.com](http://www.festo.com)

5/3-way valves and 5/2-way double solenoid valves, with solenoid coil

5/3-way valves and 5/2-way double solenoid valves, without solenoid coil

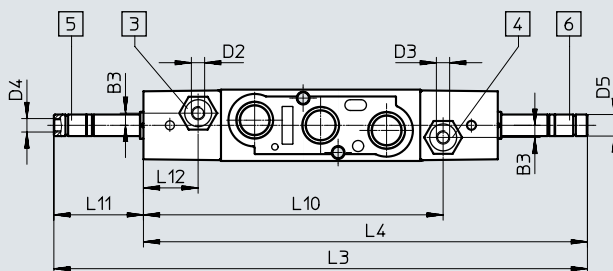
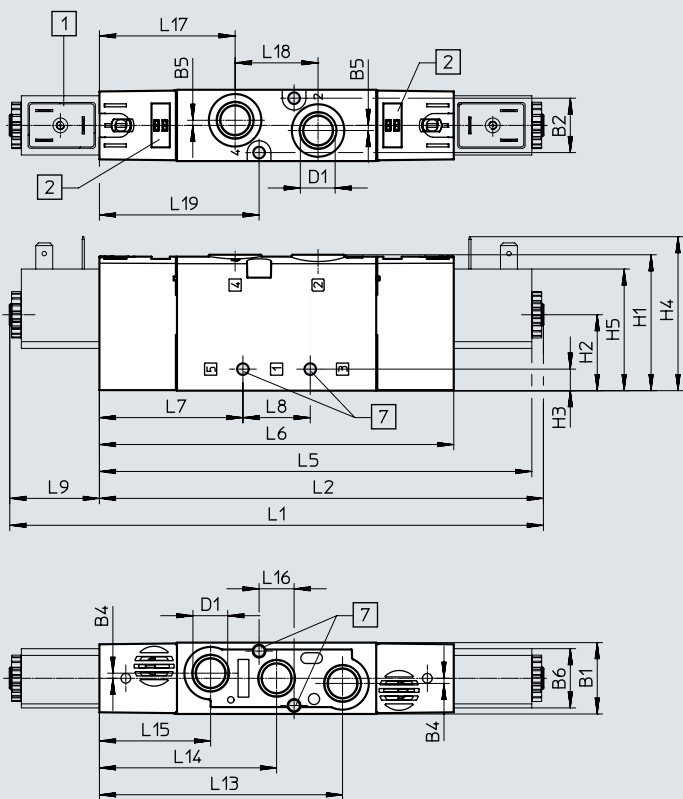

- [1] Solenoid coil interface type B/ type C
- [2] Space for inscription label
- [3] Port 14 for pilot air supply
- [4] Port 12 for pilot air supply
- [5] Port 84 for pilot exhaust air
- [6] Port 82 for pilot exhaust air
- [7] For screw M4

Type	B1	B2	B3	B4	B5	B6	D1	D2	D3	D4	D5 ∅	H1
VUVS-L25-P53...-MD-G14-...	26.5	20.2	-	1.9	1.9	22	G1/4	-	-	M5	8	50.5
VUVS-L25-P53...-MZD-G14-...			4.5					M5	M5			
VUVS-L25-B52-D-G14-...			-					-	-			
VUVS-L25-B52-ZD-G14-...			4.5					M5	M5			

Type	H2	H3	H4	H5	L1	L2	L3	L4	L5	L6	L7	L8
VUVS-L25-P53...-MD-G14-...	28.2	8	57.2	45.2	200.3	166	198.2	164.9	160.6	131.6	53.3	25
VUVS-L25-P53...-MZD-G14-...												
VUVS-L25-B52-D-G14-...												
VUVS-L25-B52-ZD-G14-...												

Type	L9	L10	L11	L12	L13	L14	L15	L16	L17	L18	L19
VUVS-L25-P53...-MD-G14-...	33.3	-	33.3	-	90.3	65.8	41.3	13	50.4	30.8	59.3
VUVS-L25-P53...-MZD-G14-...		111.3		20.3							
VUVS-L25-B52-D-G14-...		-		-							
VUVS-L25-B52-ZD-G14-...		111.3		20.3							



Accessories

Dimensions

Download CAD data → [www.festo.com](http://www.festo.com)

Foot mounting

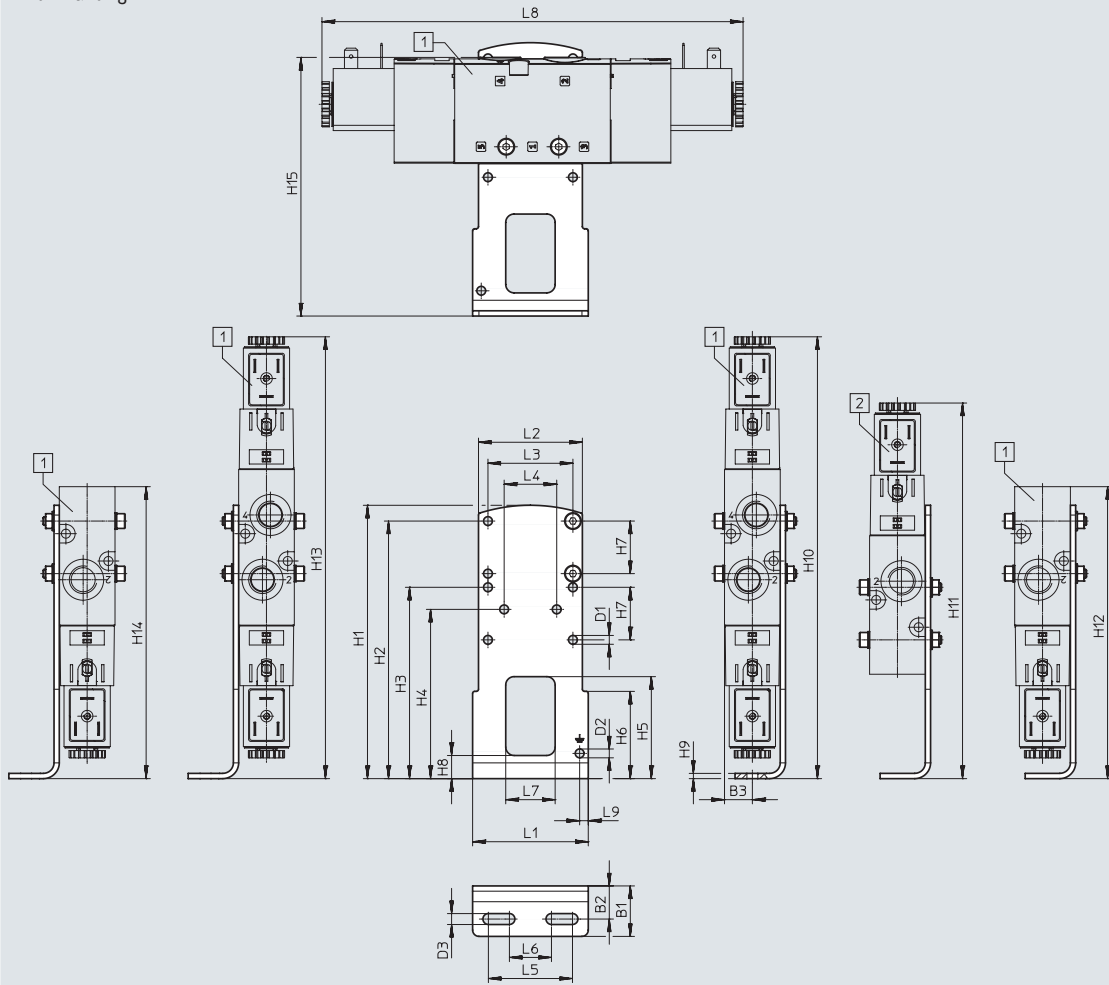

[1] VUVS-L25-B52,  
VUVS-L25-P53,  
VUVS-L25-M52,  
VUVS-L25-M32

[2] VUVS-L25-M52,  
VUVS-L25-M32

Type		B1	B2	B3	D1 ∅	D2 ∅	D3	H1	H2	H3	H4
VAME-B10-25-A	VUVS-L25-B52/P53	24	15.8	13.3	4.2	4.2	5.2	130	122.5	91	80.5
	VUVS-L25-M52										
	VUVS-L25-M32										

Type		H5	H6	H7	H8	H9	H10	H11	H12	H13	H14	
VAME-B10-25-A	VUVS-L25-B52/P53	48.5	41.5	25	11	2.5	210.2	-	210.2	210.2	210.2	
	VUVS-L25-M52							178.7			172	172
	VUVS-L25-M32										138.9	138.9

Type		H15	L1	L2	L3	L4	L5	L6	L7	L8	L9
VAME-B10-25-A	VUVS-L25-B52/P53	123	55	49.4	40.4	25	40	20	23.5	200.3	4.1
	VUVS-L25-M52									162.2	
	VUVS-L25-M32									129	

Accessories

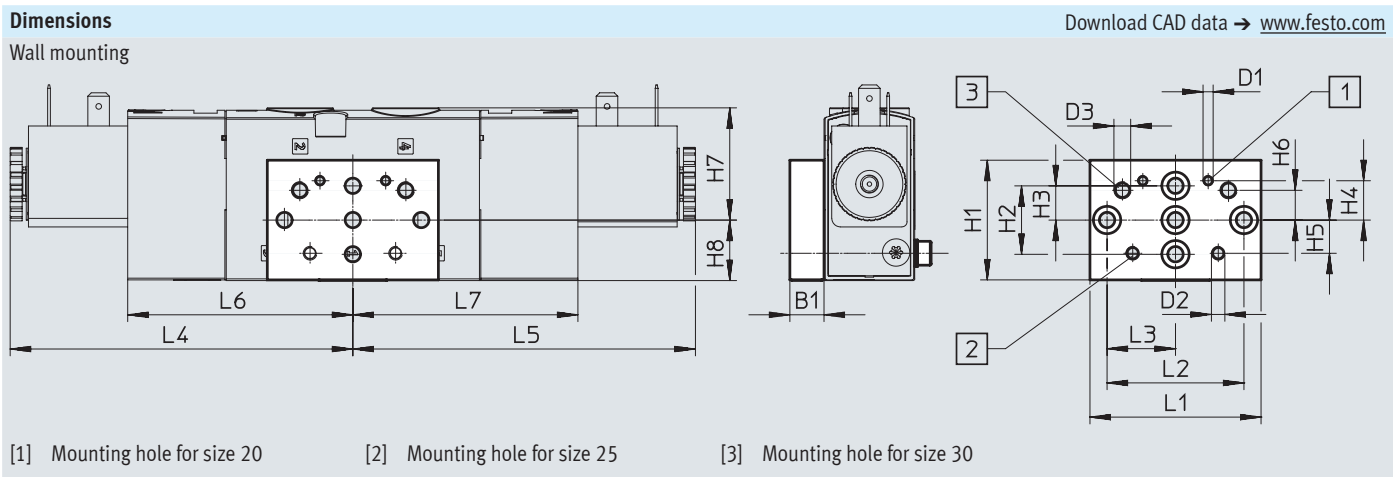

Type		B1	D1	D2	D3	H1	H2	H3	H4	H5	H6
VAME-B10-20-W	VUVS-L25-B52/P53	10	M3	M4	M5	35	20	10	11.5	9.7	8.7
	VUVS-L25-M52										
	VUVS-L25-M32										

Type		H7	H8	L1	L2	L3	L4	L5	L6	L7
VAME-B10-20-W	VUVS-L25-B52/P53	32.8	17.7	50	40	20	100.2	100.2	65.8	65.8
	VUVS-L25-M52							62		-
	VUVS-L25-M32							28.9		-

## Accessories

## ★ Core product range

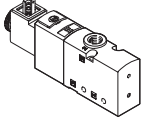
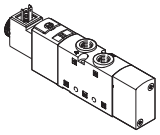
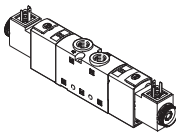
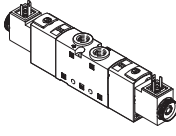
Ordering data			
	Code	Valve function	Part no.   Type
<b>3/2-way valve with solenoid coil (24 V DC)</b>			
	<b>Single solenoid, normally closed, type C</b>		
	M32C-A	Reset via pneumatic spring, internal pilot air supply, flow direction not reversible	★ 575475   VUVS-L25-M32C-AD-G14-F8-1C1
	M32C-M	Reset via mechanical spring, internal pilot air supply, flow direction not reversible	★ 575477   VUVS-L25-M32C-MD-G14-F8-1C1
<b>5/2-way valve with solenoid coil (24 V DC)</b>			
	<b>Single solenoid, type C</b>		
	M52-A	Reset via pneumatic spring, internal pilot air supply, flow direction not reversible	★ 575503   VUVS-L25-M52-AD-G14-F8-1C1
	M52-M	Reset via mechanical spring, internal pilot air supply, flow direction not reversible	★ 575511   VUVS-L25-M52-MD-G14-F8-1C1
	<b>Double solenoid, type C</b>		
	B52	Internal pilot air supply, flow direction not reversible	★ 575518   VUVS-L25-B52-D-G14-F8-1C1
<b>5/3-way valve with solenoid coil (24 V DC)</b>			
	<b>Mid-position closed, type C</b>		
	P53C	Reset via mechanical spring, internal pilot air supply, flow direction not reversible	★ 575525   VUVS-L25-P53C-MD-G14-F8-1C1

## Accessories

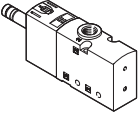
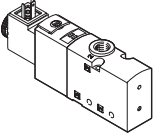
Ordering data		Code	Valve function	Part no.	Type
<b>3/2-way valve without solenoid coil</b>					
	<b>Single solenoid, normally closed</b>				
	M32C-A	Reset via pneumatic spring, internal pilot air supply, flow direction not reversible	575471	VUVS-L25-M32C-AD-G14-F8	
		Reset via pneumatic spring, external pilot air supply, flow direction reversible	575472	VUVS-L25-M32C-AZD-G14-F8	
	M32C-M	Reset via mechanical spring, internal pilot air supply, flow direction not reversible	575473	VUVS-L25-M32C-MD-G14-F8	
		Reset via mechanical spring, external pilot air supply, flow direction reversible	575474	VUVS-L25-M32C-MZD-G14-F8	
	<b>Single solenoid, normally open</b>				
	M32U-A	Reset via pneumatic spring, internal pilot air supply, flow direction not reversible	575486	VUVS-L25-M32U-AD-G14-F8	
		Reset via pneumatic spring, external pilot air supply, flow direction reversible	575487	VUVS-L25-M32U-AZD-G14-F8	
M32U-M	Reset via mechanical spring, internal pilot air supply, flow direction not reversible	575488	VUVS-L25-M32U-MD-G14-F8		
	Reset via mechanical spring, external pilot air supply, flow direction reversible	575489	VUVS-L25-M32U-MZD-G14-F8		
<b>3/2-way valve with solenoid coil (24 V DC)</b>					
	<b>Single solenoid, normally closed, type C</b>				
	M32C-A	Reset via pneumatic spring, external pilot air supply, flow direction reversible	575476	VUVS-L25-M32C-AZD-G14-F8-1C1	
	M32C-M	Reset via mechanical spring, external pilot air supply, flow direction reversible	575478	VUVS-L25-M32C-MZD-G14-F8-1C1	
	<b>Single solenoid, normally closed, type B</b>				
	M32C-A	Reset via pneumatic spring, internal pilot air supply, flow direction not reversible	575479	VUVS-L25-M32C-AD-G14-F8-1B2	
		Reset via pneumatic spring, external pilot air supply, flow direction reversible	575480	VUVS-L25-M32C-AZD-G14-F8-1B2	
	M32C-M	Reset via mechanical spring, internal pilot air supply, flow direction not reversible	575481	VUVS-L25-M32C-MD-G14-F8-1B2	
		Reset via mechanical spring, external pilot air supply, flow direction reversible	575482	VUVS-L25-M32C-MZD-G14-F8-1B2	

## Accessories

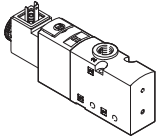
Ordering data				
	Code	Valve function	Part no. Type	
<b>3/2-way valve with solenoid coil (24 V DC)</b>				
	<b>Single solenoid, normally open, type C</b>			
	M32U-A	Reset via pneumatic spring, internal pilot air supply, flow direction not reversible	575490	VUVS-L25-M32U-AD-G14-F8-1C1
	M32U-A	Reset via pneumatic spring, external pilot air supply, flow direction reversible	575491	VUVS-L25-M32U-AZD-G14-F8-1C1
	M32U-M	Reset via mechanical spring, internal pilot air supply, flow direction not reversible	575492	VUVS-L25-M32U-MD-G14-F8-1C1
	M32U-M	Reset via mechanical spring, external pilot air supply, flow direction reversible	575493	VUVS-L25-M32U-MZD-G14-F8-1C1
	<b>Single solenoid, normally open, type B</b>			
	M32U-A	Reset via pneumatic spring, internal pilot air supply, flow direction not reversible	575494	VUVS-L25-M32U-AD-G14-F8-1B2
		Reset via pneumatic spring, external pilot air supply, flow direction reversible	575495	VUVS-L25-M32U-AZD-G14-F8-1B2
	M32U-M	Reset via mechanical spring, internal pilot air supply, flow direction not reversible	575496	VUVS-L25-M32U-MD-G14-F8-1B2
		Reset via mechanical spring, external pilot air supply, flow direction reversible	575497	VUVS-L25-M32U-MZD-G14-F8-1B2

## Accessories

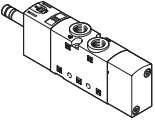
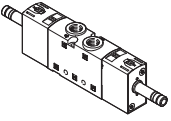
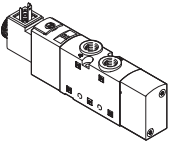
Ordering data		Code	Valve function	Part no.	Type
<b>5/2-way valve without solenoid coil</b>					
	<b>Single solenoid</b>				
	M52-A	Reset via pneumatic spring, internal pilot air supply, flow direction not reversible	575501	VUVS-L25-M52-AD-G14-F8	
		Reset via pneumatic spring, external pilot air supply, flow direction reversible	575502	VUVS-L25-M52-AZD-G14-F8	
	M52-M	Reset via mechanical spring, internal pilot air supply, flow direction not reversible	575509	VUVS-L25-M52-MD-G14-F8	
Reset via mechanical spring, external pilot air supply, flow direction reversible		575510	VUVS-L25-M52-MZD-G14-F8		
	<b>Double solenoid</b>				
	B52	Internal pilot air supply, flow direction not reversible	575516	VUVS-L25-B52-D-G14-F8	
External pilot air supply, flow direction reversible		575517	VUVS-L25-B52-ZD-G14-F8		
<b>5/2-way valve with solenoid coil (24 V DC)</b>					
	<b>Single solenoid, type C</b>				
	M52-A	Reset via pneumatic spring, external pilot air supply, flow direction reversible	575504	VUVS-L25-M52-AZD-G14-F8-1C1	
	M52-M	Reset via mechanical spring, external pilot air supply, flow direction reversible	575512	VUVS-L25-M52-MZD-G14-F8-1C1	
	<b>Single solenoid, type B</b>				
	M52-A	Reset via pneumatic spring, internal pilot air supply, flow direction not reversible	575505	VUVS-L25-M52-AD-G14-F8-1B2	
		Reset via pneumatic spring, external pilot air supply, flow direction reversible	575506	VUVS-L25-M52-AZD-G14-F8-1B2	
	M52-M	Reset via mechanical spring, internal pilot air supply, flow direction not reversible	575513	VUVS-L25-M52-MD-G14-F8-1B2	
		Reset via mechanical spring, external pilot air supply, flow direction reversible	575514	VUVS-L25-M52-MZD-G14-F8-1B2	

## Accessories

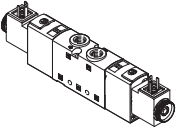

Ordering data				
	Code	Valve function	Part no.	Type
<b>5/2-way valve with solenoid coil (24 V DC)</b>				
	<b>Double solenoid, type C</b>			
	B52	External pilot air supply, flow direction reversible	575519	VUVS-L25-B52-ZD-G14-F8-1C1
	<b>Double solenoid, type B</b>			
	B52	Internal pilot air supply, flow direction not reversible	575520	VUVS-L25-B52-D-G14-F8-1B2
		External pilot air supply, flow direction reversible	575521	VUVS-L25-B52-ZD-G14-F8-1B2
<b>5/3-way valve without solenoid coil</b>				
	<b>Mid-position closed</b>			
	P53C	Reset via mechanical spring, internal pilot air supply, flow direction not reversible	575523	VUVS-L25-P53C-MD-G14-F8
		Reset via mechanical spring, external pilot air supply, flow direction reversible	575524	VUVS-L25-P53C-MZD-G14-F8
	<b>Mid-position exhausted</b>			
	P53E	Reset via mechanical spring, internal pilot air supply, flow direction not reversible	575537	VUVS-L25-P53E-MD-G14-F8
		Reset via mechanical spring, external pilot air supply, flow direction reversible	575538	VUVS-L25-P53E-MZD-G14-F8
	<b>Mid-position pressurised</b>			
	P53U	Reset via mechanical spring, internal pilot air supply, flow direction not reversible	575530	VUVS-L25-P53U-MD-G14-F8
	Reset via mechanical spring, external pilot air supply, flow direction reversible	575531	VUVS-L25-P53U-MZD-G14-F8	

## Accessories





Ordering data		Code	Valve function	Part no.	Type
<b>5/3-way valve with solenoid coil (24 V DC)</b>					
	<b>Mid-position closed, type C</b>				
	P53C	Reset via mechanical spring, external pilot air supply, flow direction reversible	575526	VUVS-L25-P53C-MZD-G14-F8-1C1	
	<b>Mid-position exhausted, type C</b>				
	P53E	Reset via mechanical spring, internal pilot air supply, flow direction not reversible	575539	VUVS-L25-P53E-MD-G14-F8-1C1	
		Reset via mechanical spring, external pilot air supply, flow direction reversible	575540	VUVS-L25-P53E-MZD-G14-F8-1C1	
	<b>Mid-position pressurised, type C</b>				
	P53U	Reset via mechanical spring, internal pilot air supply, flow direction not reversible	575532	VUVS-L25-P53U-MD-G14-F8-1C1	
		Reset via mechanical spring, external pilot air supply, flow direction reversible	575533	VUVS-L25-P53U-MZD-G14-F8-1C1	
	<b>Mid-position closed, type B</b>				
	P53C	Reset via mechanical spring, internal pilot air supply, flow direction not reversible	575527	VUVS-L25-P53C-MD-G14-F8-1B2	
		Reset via mechanical spring, external pilot air supply, flow direction reversible	575528	VUVS-L25-P53C-MZD-G14-F8-1B2	
	<b>Mid-position exhausted, type B</b>				
	P53E	Reset via mechanical spring, internal pilot air supply, flow direction not reversible	575541	VUVS-L25-P53E-MD-G14-F8-1B2	
		Reset via mechanical spring, external pilot air supply, flow direction reversible	575542	VUVS-L25-P53E-MZD-G14-F8-1B2	
	<b>Mid-position pressurised, type B</b>				
	P53U	Reset via mechanical spring, internal pilot air supply, flow direction not reversible	575534	VUVS-L25-P53U-MD-G14-F8-1B2	
		Reset via mechanical spring, external pilot air supply, flow direction reversible	575535	VUVS-L25-P53U-MZD-G14-F8-1B2	





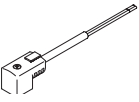

## Accessories

Ordering data		Description	Part no.	Type
<b>Solenoid coils for valves</b>				
	Plug pattern type C, to DIN EN 175301-803	12 V DC	8030810	VACF-B-C1-5
		24 V DC	8030811	VACF-B-C1-1
		48 V DC	8030812	VACF-B-C1-7
		24 V AC/50-60 Hz	8030813	VACF-B-C1-1A
		48 V AC/50-60 Hz	8030814	VACF-B-C1-7A
		110/120 V AC/50-60 Hz	8030815	VACF-B-C1-16B
		230/240 V AC/50-60 Hz	8030817	VACF-B-C1-3W
	Plug pattern type B, industry standard	12 V DC	8030801	VACF-B-B2-5
		24 V DC	8030802	VACF-B-B2-1
		48 V DC	8030803	VACF-B-B2-7
		24 V AC/50-60 Hz	8030804	VACF-B-B2-1A
		48 V AC/50-60 Hz	8030805	VACF-B-B2-7A
		110/120 V AC/50-60 Hz	8030806	VACF-B-B2-16B
		230/240 V AC/50-60 Hz	8030808	VACF-B-B2-3W
<b>Seal set for solenoid coil</b>				
	Plug pattern type C to guarantee protection class IP67	2643771	VAMC-B10-C-B-S8	
	Plug pattern type B to guarantee protection class IP67	8034609	VAMC-B10-B-B-S8	
<b>Cover cap</b>				
	For manual override, non-detenting or covered	8028240	VAMC-B10-20-CH2	

## Accessories



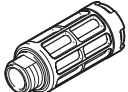
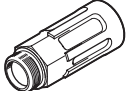

Ordering data		Description	Part no.	Type		
<b>Plug socket</b>						
	<b>Plug pattern type C, to DIN EN 175301-803</b>					
	3-pin, screw terminal	Cable connector M12	0 ... 250 V AC/DC	IP65	539712	MSSD-EB-M12
		Cable connector Pg7			★ 151687	MSSD-EB
	4-pin, insulation displacement connector	Cable connector M14	0 ... 250 V AC/DC	IP67	192745	MSSD-EB-S-M14
		Cable connector M12			0 ... 24 V DC	IP65
	<b>Plug pattern type B, industry standard</b>					
	3-pin, screw terminal	Cable connector M16	0 ... 250 V AC/DC	IP65	539710	MSSD-F-M16
Cable connector Pg9		★ 34431			MSSD-F	
3-pin, insulation displacement connector	–	0 ... 250 V AC/DC	IP67	192746	MSSD-F-S-M16	
<b>Adapter</b>						
	Socket type C, to EN 175301-803	Plug connector M12x1, 2-pin, A-coded	12 ... 24 V AC/DC	IP65	188024	MSSD-EB-M12-MONO
<b>Plug socket with cable</b>						
	<b>Plug pattern type C, to DIN EN 175301-803</b>					
	Angled socket, 3-pin Cable, open end, 3-wire	24 V DC	LED	2.5 m	★ 151688	KMEB-1-24-2,5-LED
				5 m	151689	KMEB-1-24-5-LED
				10 m	193457	KMEB-1-24-10-LED
	230 V AC	–	–	2.5 m	151690	KMEB-1-230AC-2,5
				5 m	151691	KMEB-1-230AC-5
	<b>Plug pattern type B, industry standard</b>					
	Angled socket, 3-pin Cable, open end, 3-wire	24 V DC	LED	2.5 m	★ 30935	KMF-1-24DC-2,5-LED
				5 m	30937	KMF-1-24DC-5-LED
				10 m	193458	KMF-1-24-10-LED
230 V AC	–	–	2.5 m	30936	KMF-1-230AC-2,5	
			5 m	30938	KMF-1-230AC-5	
<b>Illuminating seal</b>						
	Plug pattern type C, to DIN EN 175301-803	24 V DC	151717	MEB-LD-12-24DC		
		230 V AC	151718	MEB-LD-230AC		
	Plug pattern type B, industry standard	24 V DC	19143	MF-LD-12-24DC		
		230 V AC	19144	MF-LD-230AC		

## Accessories

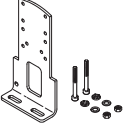
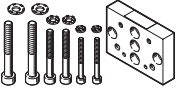

Ordering data	Description		Part no.	Type	PU <sup>1)</sup>
<b>Push-in fitting with internal hex</b>					
	Connecting thread M5 for tubing O.D.	4 mm	★ 153315	QSM-M5-4-I	10
	Connecting thread G1/4 for tubing O.D.	6 mm	★ 186108	QS-G1/4-6-I	10
		8 mm	★ 186110	QS-G1/4-8-I	10
		10 mm	★ 186112	QS-G1/4-10-I	10
<b>Angled push-in fitting with external hex</b>					
	Connecting thread G1/4 for tubing O.D.	6 mm	★ 186118	QSL-G1/4-6	10
			132051	QSL-G1/4-6-100	100
		8 mm	★ 186120	QSL-G1/4-8	10
			132052	QSL-G1/4-8-50	50
		10 mm	★ 186122	QSL-G1/4-10	10
			132053	QSL-G1/4-10-50	50
<b>Angled push-in fitting, long, with external hex</b>					
	Connecting thread G1/4 for tubing O.D.	6 mm	186129	QSL-G1/4-6	10
		8 mm	186131	QSL-G1/4-8	10
		10 mm	186133	QSL-G1/4-10	10
<b>Silencer</b>					
	With connecting thread G, polymer design	G1/4	★ 2316	U-1/4	1
			534223	U-1/4-20	20
	With connecting thread G, metal design	G1/4	6842	U-1/4-B	1
	With connecting thread G, sintered design, long	G1/4	★ 1205861	AMTE-M-LH-G14	20

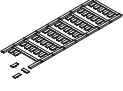
1) Packaging unit

## Accessories

Ordering data	Description	Weight [g]	Part no.	Type	
<b>Foot mounting</b>					
	With screw set for attaching the valve to the foot mounting	130	2293485	VAME-B10-25-A	
<b>Wall mounting</b>					
	With screw set for attaching the valve to the wall mounting	53	576413	VAME-B10-20-W	
<b>Assortment of spare parts</b>					
	Set comprising seals and screws	12	8035636	VAME-B10-25-MK	
<b>Inscription label</b>					
	40 pieces in frame	-	565306	ASLR-C-E4	
<b>Mounting kit</b>					
	With mounting bracket for lateral valve mounting	For standards-based cylinder DSBC-50...125	160	2612128	DAVM-MW-V1-50-V

## Technical data

-  - Flow rate  
up to 2300 l/min
-  - Valve width  
31 mm
-  - Voltage  
12, 24 V DC  
24, 110, 120, 230, 240 V AC

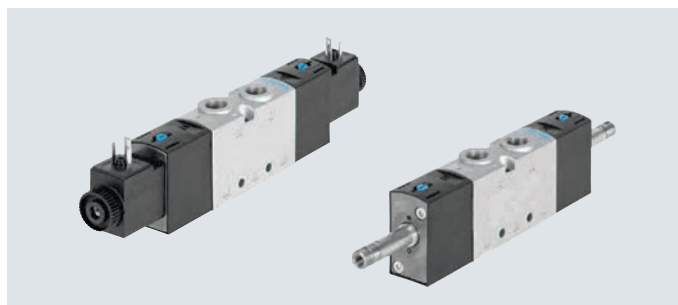

General technical data		3/2-way valve		5/2-way valve		5/3-way valve		
Valve function								
Order code for valves		M32C	M32U	M52	B52	P53C	P53U	P53E
Valve width	[mm]	31						
Nominal width	Diameter [mm]	9.4				8.9	8.1	
Design		Piston spool						
Flow direction		Reversible with external pilot air supply						
Pilot air supply		Internal or external						
Type of control		Piloted						
Manual override		Non-detenting, detenting						
Overlap		Positive overlap						
Sealing principle		Soft						
Type of mounting		Optionally via through-hole or on manifold rail						
Standard nominal flow rate qnN	[l/min]	2300	2300	2300		2000	1600	1600
Actuation type		Electric						
Mounting position		Any						
Exhaust air function		Can be throttled						
Pneumatic connection	1, 2, 3 4, 5	G3/8	G3/8	G3/8	G3/8	G3/8	G3/8	G3/8
Pilot air port 12/14		G1/8						
Pilot exhaust air port 82/84		M5						

ATEX	
Type	VUVS-L-...-EX2
ATEX category for gas	II 3G
Type of ignition protection for gas	Ex ec IICT4 Gc X
ATEX category for dust	II 3D
Type of ignition protection for dust	Ex tc IIIC T115°C Dc X
Explosion-proof ambient temperature [°C]	-10°C ≤ Ta ≤ +60°C
CE marking (see declaration of conformity) <sup>1)</sup>	To EU Explosion Protection Directive (ATEX)
UKCA marking (see declaration of conformity) <sup>1)</sup>	To UK EX instructions
Explosion protection certification outside the EU	EPL Dc (GB) EPL Gc (GB)

<sup>1)</sup> For information about the area of use, see the EC declaration of conformity at: [www.festo.com/catalogue/...](http://www.festo.com/catalogue/...) → Support/Downloads.

If the devices are subject to usage restrictions in residential, commercial or light-industrial environments, further measures for the reduction of the emitted interference may be necessary.

## Technical data

Technical data – 3/2-way valves					
Order code for valves		M32C		M32U	
Normal position		Closed		Open	
Stable position		Monostable		Monostable	
Reset method		Pneumatic spring	Mechanical spring	Pneumatic spring	Mechanical spring
Switching times in [ms]	On	19	16	19	15
	Off	36	58	37	57
	Change over	–	–	–	–
Product weight without solenoid coil	[g]	354	354	354	354
Product weight with solenoid coil	[g]	405	405	405	405

Technical data – 5/2-way valves					
Order code for valves		M52		B52	
Normal position		–		–	
Stable position		Monostable		Bistable	
Reset method		Pneumatic spring	Mechanical spring	–	
Switching times in [ms]	On	24	17	–	
	Off	49	62	–	
	Change over	–	–	13	
Product weight without solenoid coil	[g]	450	450	464	
Product weight with solenoid coil	[g]	500	500	565	

Technical data – 5/3-way valves					
Order code for valves		P53C		P53U	P53E
Normal position/mid-position		Closed		Pressurised	Exhausted
Stable position		Monostable			
Reset method		Mechanical spring			
Switching times in [ms]	On	17	18	20	
	Off	76	75	74	
	Change over	39	31	36	
Product weight without solenoid coil	[g]	461	461	461	
Product weight with solenoid coil	[g]	562	562	562	

Safety data		
Max. positive test pulse with logic 0	[s]	2000 (valves with VACF-B-...-1)
Max. negative test pulse with logic 1	[s]	3600 (valves with VACF-B-...-1)
Shock resistance		Shock test with severity level 2 to FN 942017-5 and EN 60068-2-27
Vibration resistance		Transport application test with severity level 2 to FN 942017-4 and EN 60068-2-6

## Technical data

Operating and environmental conditions		M32	M52	B52	P53
Order code for valves		M32	M52	B52	P53
Operating medium		Compressed air to ISO 8573-1:2010 [7:4:4]			
Pilot medium		Compressed air to ISO 8573-1:2010 [7:4:4]			
Note on operating/pilot medium		Lubricated operation possible (in which case lubricated operation will always be required)			
Operating pressure with internal pilot air supply	[MPa]	0.25 ... 1		0.15 ... 1	0.25 ... 1
	[bar]	2.5 ... 10		1.5 ... 10	2.5 ... 10
Operating pressure with external pilot air supply	[MPa]	-0.09 ... +1			
	[bar]	-0.9 ... +10			
Pilot pressure	[MPa]	0.25 ... 1		0.15 ... 1	0.25 ... 1
	[bar]	2.5 ... 10		1.5 ... 10	2.5 ... 10
Ambient temperature	[°C]	-10 ... +60			
Temperature of medium	[°C]	-10 ... +60			
Certification		c UL us - Recognized (OL)			
Maritime classification <sup>1)</sup>		See certificate (for VUVS-...-F8, VUVS-...-F8-...-A1 and VUVS-...-F8-...-B2 only)			
Corrosion resistance class CRC <sup>2)</sup>		2			

1) Additional information is available at [www.festo.com/catalogue/...](http://www.festo.com/catalogue/...) → Support/Downloads.

2) Corrosion resistance class CRC 2 to Festo standard FN 940070

Moderate corrosion stress. Indoor applications in which condensation can occur. External visible parts with primarily decorative surface requirements which are in direct contact with a normal industrial environment.

Electrical data		With solenoid coil	Without solenoid coil
Electrical connection		Plug type C to EN 175301-803, plug type B to industry standard (11 mm)	Via solenoid coil → Internet: vacf
Operating voltage	[V DC]	12, and 24 ±10%	
	[V AC]	24, 110, 120, 230, 240 ±10%	
Permissible voltage fluctuations	[%]	10	
Power (24 V DC)	[W]	3.3	
Duty cycle	[%]	100	
Degree of protection to EN 60529		IP65 with plug socket	

Materials	
Housing	Die-cast aluminium
Seals	HNBR, NBR
Piston spool	Wrought aluminium alloy
Screws	Nickel-plated steel
Note on materials	RoHS-compliant

Technical data

Dimensions

Download CAD data → [www.festo.com](http://www.festo.com)

3/2-way valves, with solenoid coil

3/2-way valves, without solenoid coil

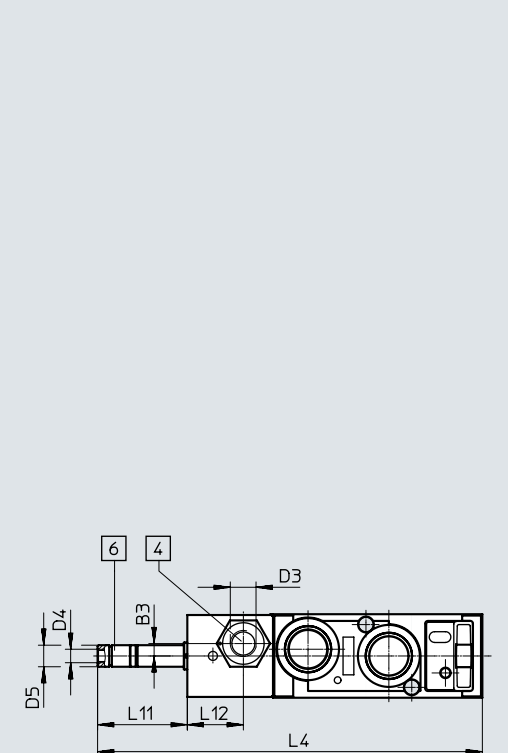
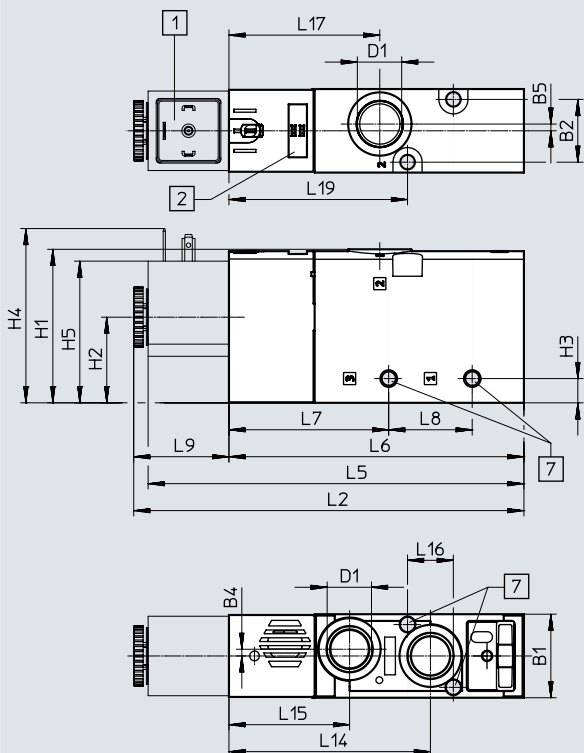

- [1] Solenoid coil interface type B/ type C
- [2] Space for inscription label
- [4] Port 10/12 for pilot air supply
- [6] Port 82 for pilot exhaust air
- [7] For screw M5

Type	B1	B2	B3	B4	B5	D1	D3	D4	D5 ∅	H1	H2	H3	H4	H5
VUVS-L30-M32...D-G38-...	31	23.3	-	2.5	2.5	G3/8	-	M5	8	57	31.8	9	63.7	51.6
VUVS-L30-M32...ZD-G38-...			4.6				G1/8							

Type	L2	L4	L5	L6	L7	L8	L9	L11	L12	L14	L15	L16	L17	L19
VUVS-L30-M32...D-G38-...	144.9	142.8	139.5	109.5	59.3	31	35.4	33.3	-	74.8	44.8	17	56	66.3
VUVS-L30-M32...ZD-G38-...									20.8					



Technical data

Dimensions

Download CAD data → [www.festo.com](http://www.festo.com)

5/2-way single solenoid valves, with solenoid coil

5/2-way single solenoid valves, without solenoid coil

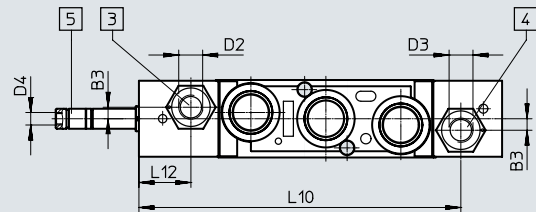
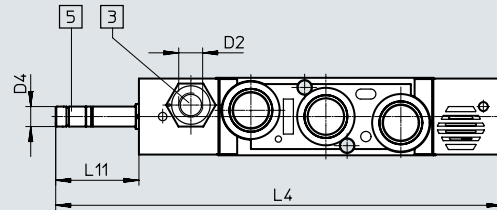
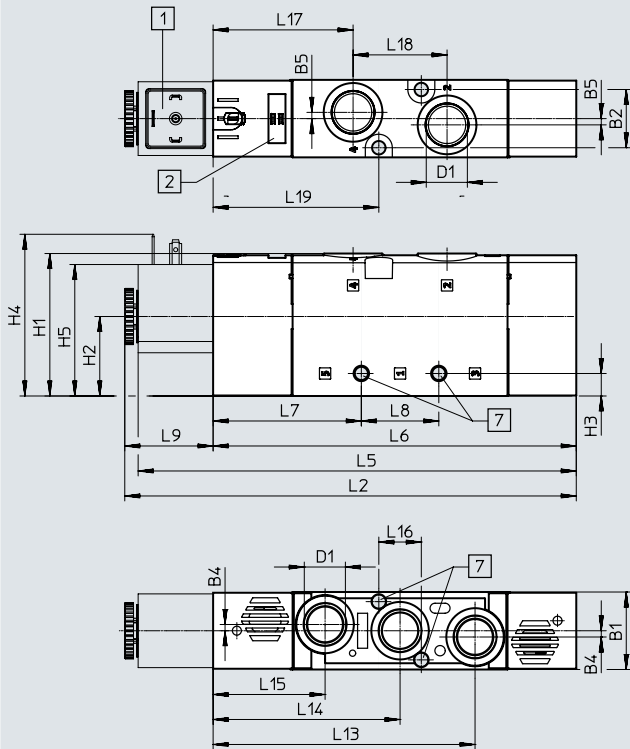

- [1] Solenoid coil interface type B/  
type C
- [2] Space for inscription label

- [3] Port 14 for pilot air supply
- [4] Port 12 for pilot air supply

- [5] Port 84 for pilot exhaust air

- [7] For screw M5

Type	B1	B2	B3	B4	B5	D1	D2	D3	D4	D5 ∅	H1	H2	H3	H4	H5
VUVS-L30-M52-...D-G38-...	31	23.3	-	2.5	2.5	G3/8	-	-	M5	8	57	31.8	9	63.7	51.6
VUVS-L30-M52-...ZD-G38-...			4.6				G1/8	G1/8							

Type	L2	L4	L5	L6	L7	L8	L9	L10	L11	L12	L13	L14	L15	L16	L17	L18	L19
VUVS-L30-M52-...D-G38-...	180.7	178.6	179.6	145.3	59.3	31	35.4	-	33.3	-	104.8	74.8	44.8	17	56	37.6	66.3
VUVS-L30-M52-...ZD-G38-...								128.8		20.8							

Technical data

Dimensions

Download CAD data → [www.festo.com](http://www.festo.com)

5/3-way valves and 5/2-way double solenoid valves, with solenoid coil

5/3-way valves and 5/2-way double solenoid valves, without solenoid coil

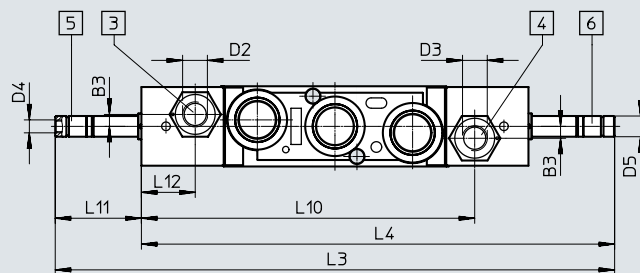
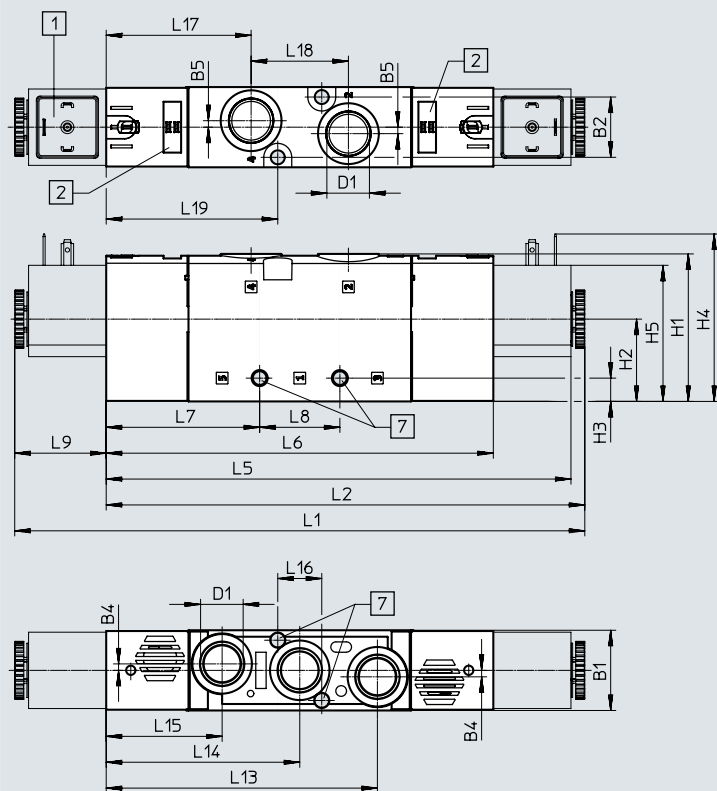

- [1] Solenoid coil interface type B/  
type C
- [2] Space for inscription label
- [3] Port 14 for pilot air supply
- [4] Port 12 for pilot air supply

- [5] Port 84 for pilot exhaust air
- [6] Port 82 for pilot exhaust air
- [7] For screw M5

Type	B1	B2	B3	B4	B5	D1	D2	D3	D4	D5 ∅	H1	H2	H3	H4	H5
VUVS-L30-P53...-MD-G38-...	31	23.3	-	2.5	2.5	G3/8	-	-	M5	8	57	31.8	9	63.7	51.6
VUVS-L30-P53...-MZD-G38-...			4.6				G1/8	G1/8							
VUVS-L30-B52-D-G38-...			-				-	-							
VUVS-L30-B52-ZD-G38-...			4.6				G1/8	G1/8							

Type	L1	L2	L3	L4	L5	L6	L7	L8	L9	L10
VUVS-L30-P53...-MD-G38-...	220.3	185	216.2	182.9	179.6	149.6	59.3	31	35.4	-
VUVS-L30-P53...-MZD-G38-...										128.8
VUVS-L30-B52-D-G38-...										-
VUVS-L30-B52-ZD-G38-...										128.8

Type	L11	L12	L13	L14	L15	L16	L17	L18	L19
VUVS-L30-P53...-MD-G38-...	33.3	-	104.8	74.8	44.8	17	56	37.6	66.3
VUVS-L30-P53...-MZD-G38-...		20.8							
VUVS-L30-B52-D-G38-...		-							
VUVS-L30-B52-ZD-G38-...		20.8							

Accessories

Dimensions

Download CAD data → [www.festo.com](http://www.festo.com)

Foot mounting

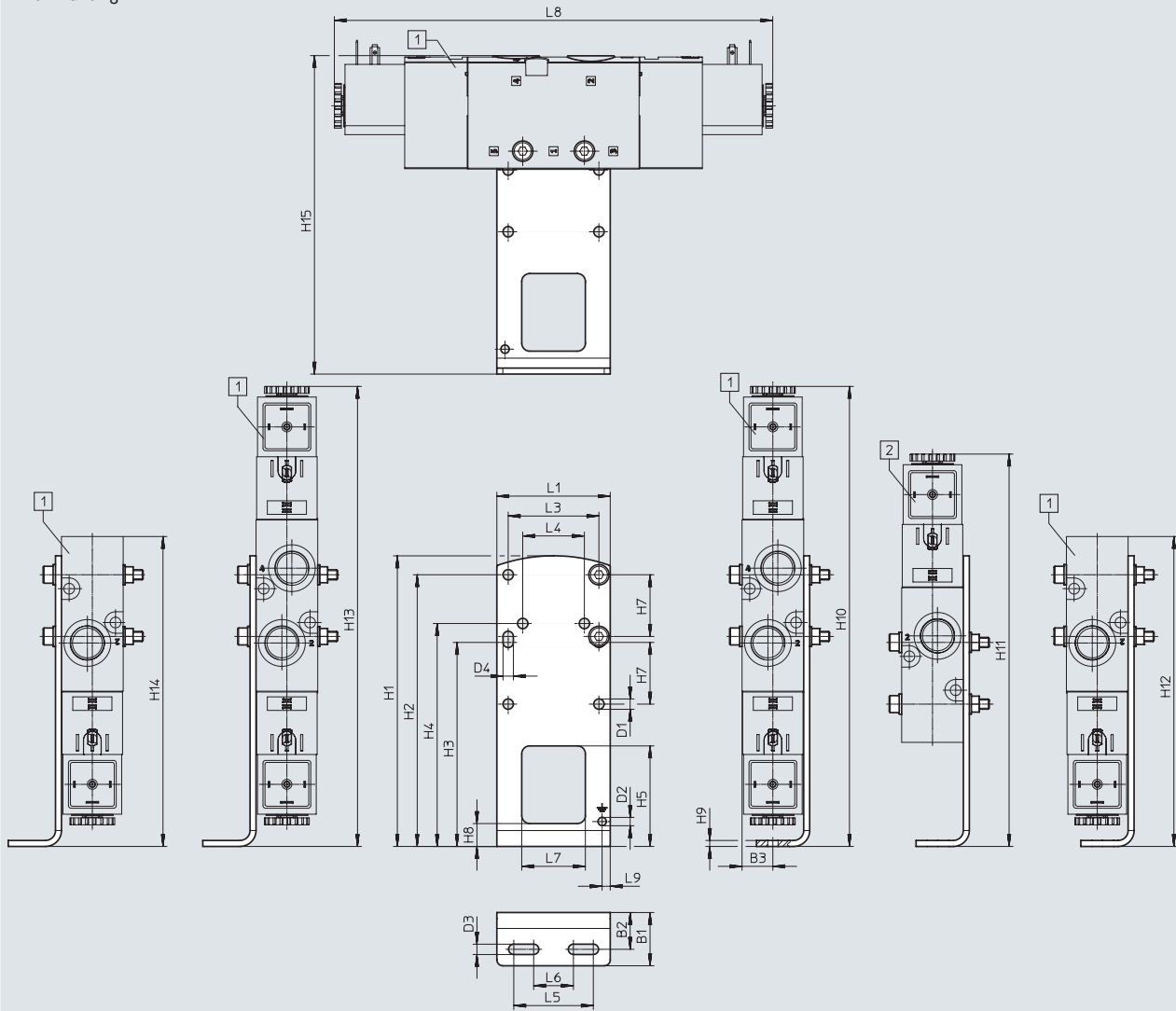

[1] VUVS-L30-B52,  
VUVS-L30-P53,  
VUVS-L30-M52,  
VUVS-L30-M32

[2] VUVS-L30-M52,  
VUVS-L30-M32

Type		B1	B2	B3	D1 ∅	D2 ∅	D3	D4	H1	H2	H3
VAME-B10-30-A	VUVS-L30-B52/P53	26.8	18.5	15.5	5.2	4.2	5.2	5.2	146	136.5	102.5
	VUVS-L30-M52										
	VUVS-L30-M32										

Type		H4	H5	H7	H8	H9	H10	H11	H12	H13	H14
VAME-B10-30-A	VUVS-L30-B52/P53	112	50.5	31	11.5	3	231.2	-	231.2	231.2	231.2
	VUVS-L30-M52							197.2	191.5		191.5
	VUVS-L30-M32							155.7	155.7		155.7

Type		H15	L1	L3	L4	L5	L6	L7	L8	L9
VAME-B10-30-A	VUVS-L30-B52/P53	160	57	45.6	31	40	20	32	220.3	4.1
	VUVS-L30-M52								180.7	
	VUVS-L30-M32								144.9	

Accessories

Dimensions

Download CAD data → [www.festo.com](http://www.festo.com)

Wall mounting

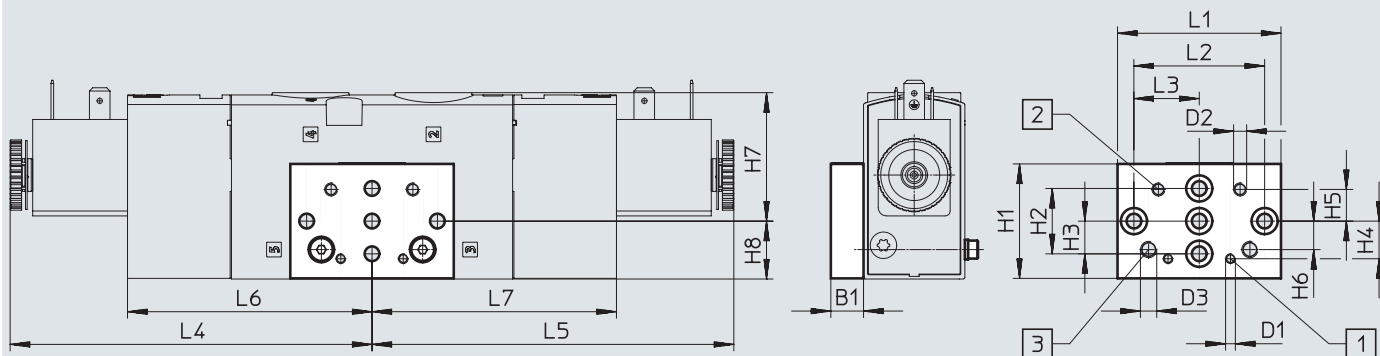

[1] Mounting hole for size 20      [2] Mounting hole for size 25      [3] Mounting hole for size 30

Type		B1	D1	D2	D3	H1	H2	H3	H4	H5	H6
VAME-B10-20-W	VUVS-L30-B52/P53	10	M3	M4	M5	35	20	10	11.5	9.7	8.7
	VUVS-L30-M52										
	VUVS-L30-M32										

Type		H7	H8	L1	L2	L3	L4	L5	L6	L7
VAME-B10-20-W	VUVS-L30-B52/P53	39.3	17.7	50	40	20	110.2	110.2	74.8	74.8
	VUVS-L30-M52							70.5		
	VUVS-L30-M32							34.7		

## Accessories

## ★ Core product range

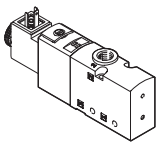
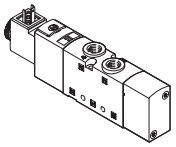
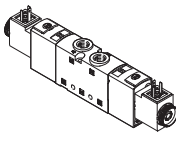
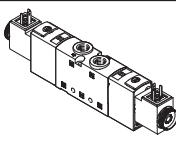
Ordering data				
	Code	Valve function	Part no.	Type
<b>3/2-way valve with solenoid coil (24 V DC)</b>				
	<b>Single solenoid, normally closed, type C</b>			
	M32C-A	Reset via pneumatic spring, internal pilot air supply, flow direction not reversible	★ 575568	VUVS-L30-M32C-AD-G38-F8-1C1
	M32C-M	Reset via mechanical spring, internal pilot air supply, flow direction not reversible	★ 575570	VUVS-L30-M32C-MD-G38-F8-1C1
<b>5/2-way valve with solenoid coil (24 V DC)</b>				
	<b>Single solenoid, type C</b>			
	M52-A	Reset via pneumatic spring, internal pilot air supply, flow direction not reversible	★ 575596	VUVS-L30-M52-AD-G38-F8-1C1
	M52-M	Reset via mechanical spring, internal pilot air supply, flow direction not reversible	★ 575604	VUVS-L30-M52-MD-G38-F8-1C1
	<b>Double solenoid, type C</b>			
	B52	Internal pilot air supply, flow direction not reversible	★ 575611	VUVS-L30-B52-D-G38-F8-1C1
<b>5/3-way valve with solenoid coil (24 V DC)</b>				
	<b>Mid-position closed, type C</b>			
	P53C	Reset via mechanical spring, internal pilot air supply, flow direction not reversible	★ 575618	VUVS-L30-P53C-MD-G38-F8-1C1

## Accessories

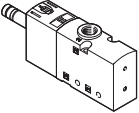
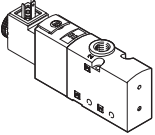
Ordering data		Code	Valve function	Part no.	Type
<b>3/2-way valve without solenoid coil</b>					
	<b>Single solenoid, normally closed</b>				
	M32C-A	Reset via pneumatic spring, internal pilot air supply, flow direction not reversible	575564	VUVS-L30-M32C-AD-G38-F8	
		Reset via pneumatic spring, external pilot air supply, flow direction reversible	575565	VUVS-L30-M32C-AZD-G38-F8	
	M32C-M	Reset via mechanical spring, internal pilot air supply, flow direction not reversible	575566	VUVS-L30-M32C-MD-G38-F8	
		Reset via mechanical spring, external pilot air supply, flow direction reversible	575567	VUVS-L30-M32C-MZD-G38-F8	
	<b>Single solenoid, normally open</b>				
	M32U-A	Reset via pneumatic spring, internal pilot air supply, flow direction not reversible	575579	VUVS-L30-M32U-AD-G38-F8	
		Reset via pneumatic spring, external pilot air supply, flow direction reversible	575580	VUVS-L30-M32U-AZD-G38-F8	
M32U-M	Reset via mechanical spring, internal pilot air supply, flow direction not reversible	575581	VUVS-L30-M32U-MD-G38-F8		
	Reset via mechanical spring, external pilot air supply, flow direction reversible	575582	VUVS-L30-M32U-MZD-G38-F8		
<b>3/2-way valve with solenoid coil (24 V DC)</b>					
	<b>Single solenoid, normally closed, type C</b>				
	M32C-A	Reset via pneumatic spring, external pilot air supply, flow direction reversible	575569	VUVS-L30-M32C-AZD-G38-F8-1C1	
	M32C-M	Reset via mechanical spring, external pilot air supply, flow direction reversible	575571	VUVS-L30-M32C-MZD-G38-F8-1C1	
	<b>Single solenoid, normally closed, type B</b>				
	M32C-A	Reset via pneumatic spring, internal pilot air supply, flow direction not reversible	575572	VUVS-L30-M32C-AD-G38-F8-1B2	
		Reset via pneumatic spring, external pilot air supply, flow direction reversible	575573	VUVS-L30-M32C-AZD-G38-F8-1B2	
	M32C-M	Reset via mechanical spring, internal pilot air supply, flow direction not reversible	575574	VUVS-L30-M32C-MD-G38-F8-1B2	
		Reset via mechanical spring, external pilot air supply, flow direction reversible	575575	VUVS-L30-M32C-MZD-G38-F8-1B2	

## Accessories

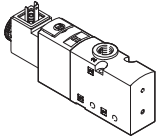
Ordering data				
	Code	Valve function	Part no.	Type
<b>3/2-way valve with solenoid coil (24 V DC)</b>				
	<b>Single solenoid, normally open, type C</b>			
	M32U-A	Reset via pneumatic spring, internal pilot air supply, flow direction not reversible	575583	VUVS-L30-M32U-AD-G38-F8-1C1
	M32U-A	Reset via pneumatic spring, external pilot air supply, flow direction reversible	575584	VUVS-L30-M32U-AZD-G38-F8-1C1
	M32U-M	Reset via mechanical spring, internal pilot air supply, flow direction not reversible	575585	VUVS-L30-M32U-MD-G38-F8-1C1
	M32U-M	Reset via mechanical spring, external pilot air supply, flow direction reversible	575586	VUVS-L30-M32U-MZD-G38-F8-1C1
	<b>Single solenoid, normally open, type B</b>			
	M32U-A	Reset via pneumatic spring, internal pilot air supply, flow direction not reversible	575587	VUVS-L30-M32U-AD-G38-F8-1B2
		Reset via pneumatic spring, external pilot air supply, flow direction reversible	575588	VUVS-L30-M32U-AZD-G38-F8-1B2
	M32U-M	Reset via mechanical spring, internal pilot air supply, flow direction not reversible	575589	VUVS-L30-M32U-MD-G38-F8-1B2
		Reset via mechanical spring, external pilot air supply, flow direction reversible	575590	VUVS-L30-M32U-MZD-G38-F8-1B2

Accessories

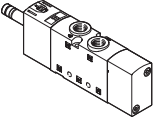
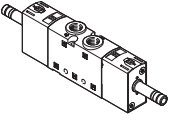
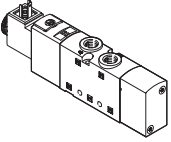
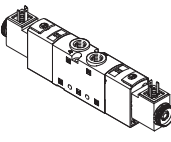
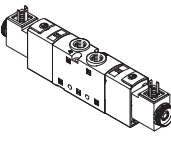
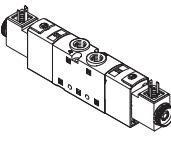
Ordering data				
	Code	Valve function	Part no.	Type
<b>5/2-way valve without solenoid coil</b>				
	<b>Single solenoid</b>			
	M52-A	Reset via pneumatic spring, internal pilot air supply, flow direction not reversible	575594	VUVS-L30-M52-AD-G38-F8
		Reset via pneumatic spring, external pilot air supply, flow direction reversible	575595	VUVS-L30-M52-AZD-G38-F8
	M52-M	Reset via mechanical spring, internal pilot air supply, flow direction not reversible	575602	VUVS-L30-M52-MD-G38-F8
Reset via mechanical spring, external pilot air supply, flow direction reversible		575603	VUVS-L30-M52-MZD-G38-F8	
	<b>Double solenoid</b>			
	B52	Internal pilot air supply, flow direction not reversible	575609	VUVS-L30-B52-D-G38-F8
External pilot air supply, flow direction reversible		575610	VUVS-L30-B52-ZD-G38-F8	
<b>5/2-way valve with solenoid coil (24 VDC)</b>				
	<b>Single solenoid, type C</b>			
	M52-A	Reset via pneumatic spring, external pilot air supply, flow direction reversible	575597	VUVS-L30-M52-AZD-G38-F8-1C1
	M52-M	Reset via mechanical spring, external pilot air supply, flow direction reversible	575605	VUVS-L30-M52-MZD-G38-F8-1C1
	<b>Single solenoid, type B</b>			
	M52-A	Reset via pneumatic spring, internal pilot air supply, flow direction not reversible	575598	VUVS-L30-M52-AD-G38-F8-1B2
		Reset via pneumatic spring, external pilot air supply, flow direction reversible	575599	VUVS-L30-M52-AZD-G38-F8-1B2
	M52-M	Reset via mechanical spring, internal pilot air supply, flow direction not reversible	575606	VUVS-L30-M52-MD-G38-F8-1B2
		Reset via mechanical spring, external pilot air supply, flow direction reversible	575607	VUVS-L30-M52-MZD-G38-F8-1B2
	<b>Double solenoid, type C</b>			
	B52	External pilot air supply, flow direction reversible	575612	VUVS-L30-B52-ZD-G38-F8-1C1
	<b>Double solenoid, type B</b>			
	B52	Internal pilot air supply, flow direction not reversible	575613	VUVS-L30-B52-D-G38-F8-1B2
		External pilot air supply, flow direction reversible	575614	VUVS-L30-B52-ZD-G38-F8-1B2





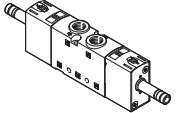

## Accessories

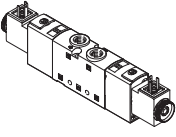
Ordering data		Code	Valve function	Part no.	Type
<b>5/3-way valve without solenoid coil</b>					
	<b>Mid-position closed</b>				
	P53C	Reset via mechanical spring, internal pilot air supply, flow direction not reversible	575616	VUVS-L30-P53C-MD-G38-F8	
		Reset via mechanical spring, external pilot air supply, flow direction reversible	575617	VUVS-L30-P53C-MZD-G38-F8	
	<b>Mid-position exhausted</b>				
	P53E	Reset via mechanical spring, internal pilot air supply, flow direction not reversible	575630	VUVS-L30-P53E-MD-G38-F8	
		Reset via mechanical spring, external pilot air supply, flow direction reversible	575631	VUVS-L30-P53E-MZD-G38-F8	
	<b>Mid-position pressurised</b>				
	P53U	Reset via mechanical spring, internal pilot air supply, flow direction not reversible	575623	VUVS-L30-P53U-MD-G38-F8	
		Reset via mechanical spring, external pilot air supply, flow direction reversible	575624	VUVS-L30-P53U-MZD-G38-F8	





## Accessories

Ordering data		Code	Valve function	Part no.	Type
<b>5/3-way valve with solenoid coil (24 V DC)</b>					
	<b>Mid-position closed, type C</b>				
	P53C	Reset via mechanical spring, external pilot air supply, flow direction reversible	575619	VUVS-L30-P53C-MZD-G38-F8-1C1	
	<b>Mid-position exhausted, type C</b>				
	P53E	Reset via mechanical spring, internal pilot air supply, flow direction not reversible	575632	VUVS-L30-P53E-MD-G38-F8-1C1	
		Reset via mechanical spring, external pilot air supply, flow direction reversible	575633	VUVS-L30-P53E-MZD-G38-F8-1C1	
	<b>Mid-position pressurised, type C</b>				
	P53U	Reset via mechanical spring, internal pilot air supply, flow direction not reversible	575625	VUVS-L30-P53U-MD-G38-F8-1C1	
		Reset via mechanical spring, external pilot air supply, flow direction reversible	575626	VUVS-L30-P53U-MZD-G38-F8-1C1	
	<b>Mid-position closed, type B</b>				
	P53C	Reset via mechanical spring, internal pilot air supply, flow direction not reversible	575620	VUVS-L30-P53C-MD-G38-F8-1B2	
		Reset via mechanical spring, external pilot air supply, flow direction reversible	575621	VUVS-L30-P53C-MZD-G38-F8-1B2	
	<b>Mid-position exhausted, type B</b>				
	P53E	Reset via mechanical spring, internal pilot air supply, flow direction not reversible	575634	VUVS-L30-P53E-MD-G38-F8-1B2	
		Reset via mechanical spring, external pilot air supply, flow direction reversible	575635	VUVS-L30-P53E-MZD-G38-F8-1B2	
	<b>Mid-position pressurised, type B</b>				
	P53U	Reset via mechanical spring, internal pilot air supply, flow direction not reversible	575627	VUVS-L30-P53U-MD-G38-F8-1B2	
		Reset via mechanical spring, external pilot air supply, flow direction reversible	575628	VUVS-L30-P53U-MZD-G38-F8-1B2	



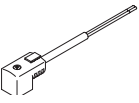

## Accessories

Ordering data		Description	Part no.	Type		
<b>Solenoid coils for valves</b>						
	Plug pattern type C, to DIN EN 175301-803	12 V DC	8030810	VACF-B-C1-5		
		24 V DC	8030811	VACF-B-C1-1		
		48 V DC	8030812	VACF-B-C1-7		
		24 V AC/50-60 Hz	8030813	VACF-B-C1-1A		
		48 V AC/50-60 Hz	8030814	VACF-B-C1-7A		
		110/120 V AC/50-60 Hz	8030815	VACF-B-C1-16B		
		230/240 V AC/50-60 Hz	8030817	VACF-B-C1-3W		
	Plug pattern type B, industry standard	12 V DC	8030801	VACF-B-B2-5		
		24 V DC	8030802	VACF-B-B2-1		
		48 V DC	8030803	VACF-B-B2-7		
		24 V AC/50-60 Hz	8030804	VACF-B-B2-1A		
		48 V AC/50-60 Hz	8030805	VACF-B-B2-7A		
		110/120 V AC/50-60 Hz	8030806	VACF-B-B2-16B		
		230/240 V AC/50-60 Hz	8030808	VACF-B-B2-3W		
	Plug pattern type A, to EN 175301-803	12 V DC	8030821	VACF-A-A1-5		
		24 V DC	8030822	VACF-A-A1-1		
		48 V DC	8030823	VACF-A-A1-7		
		24 V AC/50-60 Hz	8030824	VACF-A-A1-1A		
		48 V AC/50-60 Hz	8030825	VACF-A-A1-7A		
		110/120 V AC/50-60 Hz	8030826	VACF-A-A1-16B		
		230/240 V AC/50-60 Hz	8030828	VACF-A-A1-3W		
<b>Seal set for solenoid coil</b>						
	Plug pattern type C to guarantee protection class IP67		2643771	VAMC-B10-C-B-S8		
	Plug pattern type B to guarantee protection class IP67		8034609	VAMC-B10-B-B-S8		
	Plug pattern type A to guarantee protection class IP67		8034611	VAMC-B10-A-B-S8		
<b>Cover cap</b>						
	For manual override, non-detenting or covered		8028240	VAMC-B10-20-CH2		
<b>Plug socket</b>						
	<b>Plug pattern type C, to DIN EN 175301-803</b>					
	3-pin, screw terminal	Cable connector M12	0 ... 250 V AC/DC	IP65	539712	MSSD-EB-M12
		Cable connector Pg7			★ 151687	MSSD-EB
	4-pin, insulation displacement connector	Cable connector M14	0 ... 250 V AC/DC	IP67	192745	MSSD-EB-S-M14
		Cable connector M12			0 ... 24 V DC	IP65
	<b>Plug pattern type B, industry standard</b>					
	3-pin, screw terminal	Cable connector M16	0 ... 250 V AC/DC	IP65	539710	MSSD-F-M16
		Cable connector Pg9			★ 34431	MSSD-F
	3-pin, insulation displacement connector	–	0 ... 250 V AC/DC	IP67	192746	MSSD-FS-M16

## Accessories



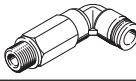
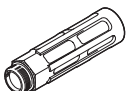

Ordering data		Description	Part no.	Type		
<b>Plug socket</b>						
	<b>Plug pattern type A, to EN 175301-803</b>					
	3-pin, angled socket	Cable connector Pg9	0 ... 250 V AC/DC	IP65	<b>34583</b>	<b>MSSD-C</b>
	3-pin, angled socket	Cable connector M16	0 ... 250 V AC/DC	IP65	<b>539709</b>	<b>MSSD-C-M16</b>
	4-pin, angled socket	Cable connection, insulation displacement	0 ... 250 V AC/DC	IP67	<b>192748</b>	<b>MSSD-C-S-M16</b>
<b>Adapter</b>						
	Socket type C, to EN 175301-803	Plug connector M12x1, 2-pin, A-coded	12 ... 24 V AC/DC	IP65	<b>188024</b>	<b>MSSD-EB-M12-MONO</b>
<b>Plug socket with cable</b>						
	<b>Plug pattern type C, to DIN EN 175301-803</b>					
	Angled socket, 3-pin Cable, open end, 3-wire	24 V DC	LED	2.5 m	★ <b>151688</b>	<b>KMEB-1-24-2,5-LED</b>
				5 m	<b>151689</b>	<b>KMEB-1-24-5-LED</b>
				10 m	<b>193457</b>	<b>KMEB-1-24-10-LED</b>
		230 V AC	–	2.5 m	<b>151690</b>	<b>KMEB-1-230AC-2,5</b>
				5 m	<b>151691</b>	<b>KMEB-1-230AC-5</b>
	<b>Plug pattern type B, industry standard</b>					
	Angled socket, 3-pin Cable, open end, 3-wire	24 V DC	LED	2.5 m	★ <b>30935</b>	<b>KMF-1-24DC-2,5-LED</b>
				5 m	<b>30937</b>	<b>KMF-1-24DC-5-LED</b>
				10 m	<b>193458</b>	<b>KMF-1-24-10-LED</b>
		230 V AC	–	2.5 m	<b>30936</b>	<b>KMF-1-230AC-2,5</b>
				5 m	<b>30938</b>	<b>KMF-1-230AC-5</b>
	<b>Plug pattern type A, to EN 175301-803</b>					
	Angled socket, 3-pin Cable, open end, 3-wire	24 V DC	LED	2.5 m	<b>30931</b>	<b>KMC-1-24DC-2.5-LED</b>
5 m				<b>30933</b>	<b>KMC-1-24DC-5-LED</b>	
10 m				<b>193459</b>	<b>KMC-1-24-10-LED</b>	
230 V AC		–	2.5 m	<b>30932</b>	<b>KMC-1-230AC-2,5</b>	
		5 m	<b>30934</b>	<b>KMC-1-230AC-5</b>		
<b>Illuminating seal</b>						
	Plug pattern type C, to DIN EN 175301-803	24 V DC		<b>151717</b>	<b>MEB-LD-12-24DC</b>	
		230 V AC		<b>151718</b>	<b>MEB-LD-230AC</b>	
	Plug pattern type B, industry standard	24 V DC		<b>19143</b>	<b>MF-LD-12-24DC</b>	
		230 V AC		<b>19144</b>	<b>MF-LD-230AC</b>	

## Accessories

Ordering data	Description		Part no.	Type	PU <sup>1)</sup>
<b>Push-in fitting with internal hex</b>					
	Connecting thread G1/8 for tubing O.D.	4 mm	★ 186106	QS-G1/8-4-I	10
			133008	QS-G1/8-4-I-100	100
	Connecting thread G3/8 for tubing O.D.	8 mm	★ 186111	QS-G3/8-8-I	10
			10 mm	★ 186113	QS-G3/8-10-I
	12 mm	★ 186114	QS-G3/8-12-I	10	
<b>Angled push-in fitting with external hex</b>					
	Connecting thread G3/8 for tubing O.D.	8 mm	★ 186121	QSL-G3/8-8	10
			132055	QSL-G3/8-8-50	50
		10 mm	★ 186123	QSL-G3/8-10	10
			132056	QSL-G3/8-10-20	20
		12 mm	★ 186124	QSL-G3/8-12	10
	132057	QSL-G3/8-12-20	20		
<b>Angled push-in fitting, long, with external hex</b>					
	Connecting thread G3/8 for tubing O.D.	8 mm	186132	QSL-G3/8-8	10
		10 mm	186134	QSL-G3/8-10	10
		12 mm	186135	QSL-G3/8-12	10
<b>Silencer</b>					
	With connecting thread G, metal design	G3/8	6843	U-3/8-B	1
	With connecting thread G, sintered design, long	G3/8	★ 1205862	AMTE-M-LH-G38	10

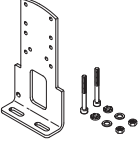
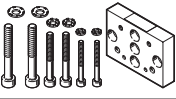
1) Packaging unit

## Accessories

Ordering data	Description	Weight [g]	Part no.	Type
<b>Foot mounting</b>				
	With screw set for attaching the valve to the foot mounting	239	<b>8026337</b>	<b>VAME-B10-30-A</b>
<b>Wall mounting</b>				
	With screw set for attaching the valve to the wall mounting	53	<b>576413</b>	<b>VAME-B10-20-W</b>
<b>Assortment of spare parts</b>				
	Set comprising seals and screws	22	<b>8035637</b>	<b>VAME-B10-30-MK</b>
<b>Inscription label</b>				
	40 pieces in frame	-	<b>565306</b>	<b>ASLR-C-E4</b>
<b>Mounting kit</b>				
	With mounting bracket for lateral valve mounting	For standards-based cylinder DSBC-50...125	160	<b>2612128</b> <b>DAVM-MW-V1-50-V</b>

## Technical data – Manifold block, size 20

-  - Flow rate  
up to 700 l/min

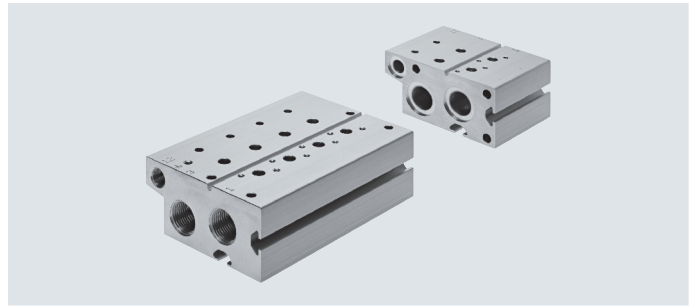

General technical data	Standard manifold block		Extension module for standard manifold block		Compact manifold block		Common supply manifold on both sides   on one side	
	3/2	5/2, 5/3	3/2	5/2, 5/3	3/2	5/2, 5/3	3/2, 5/2, 5/3	
For valve function								
Grid dimension [mm]	22							
Type of mounting	With through-hole						Via mounting bracket	
Max. number of valve positions	10	10	2	2	10		10	4
Port 1	G3/8	G3/8	G3/8	G3/8	G1/4	G1/4	G3/8	G3/8
Port 3	G3/8	G3/8	G3/8	G3/8	G1/4	G1/4	-	-
Port 5	-	G3/8	-	G3/8	-	G1/4	-	-
Port 12	G1/8	G1/8	G1/8	G1/8	-	-	-	-
Port 14	-	G1/8	-	G1/8	-	-	-	-
Corrosion resistance <sup>1)</sup>	2							

1) Corrosion resistance class CRC 2 to Festo standard FN 940070

Moderate corrosion stress. Indoor applications in which condensation can occur. External visible parts with primarily decorative surface requirements which are in direct contact with a normal industrial environment.

Weight [g]									
Valve positions	2	3	4	5	6	7	8	9	10
<b>Manifold block for 3/2-way valves, standard</b>									
VABM-B10-20E-G38-...-P3	449	574	699	825	950	1075	1200	1326	1451
<b>Manifold block, extension module for 3/2-way valves, standard</b>									
VABM-B10-20EEE-G38-2-P3	324	-	-	-	-	-	-	-	-
<b>Manifold block for 5/2- and 5/3-way valves, standard</b>									
VABM-B10-20E-G38-...	680	866	1053	1239	1425	1612	1798	1985	2171
<b>Manifold block, extension module for 5/2- and 5/3-way valves, standard</b>									
VABM-B10-20EEE-G38-2	492	-	-	-	-	-	-	-	-
<b>Manifold block for 3/2-way valves, compact</b>									
VABM-B10-20S-G14-...-P3	280	360	441	521	601	681	762	842	922
<b>Manifold block for 5/2- and 5/3-way valves, compact</b>									
VABM-B10-20S-G14-...	344	439	535	630	726	821	917	1012	1108
<b>Common supply manifold for mounting on both sides</b>									
VABM-B10-20-G38-...-P53	226	268	310	352	395	437	479	521	563
<b>Common supply manifold for mounting on one side</b>									
VABM-B10-20-G38-2-P53-E	240	282	324	-	-	-	-	-	-

## Technical data – Manifold block, size 20

Materials	
Manifold rail	Wrought aluminium alloy
Note on materials	RoHS-compliant

### Dimensions

Download CAD data → [www.festo.com](http://www.festo.com)

Manifold block for 3/2-way valves, standard

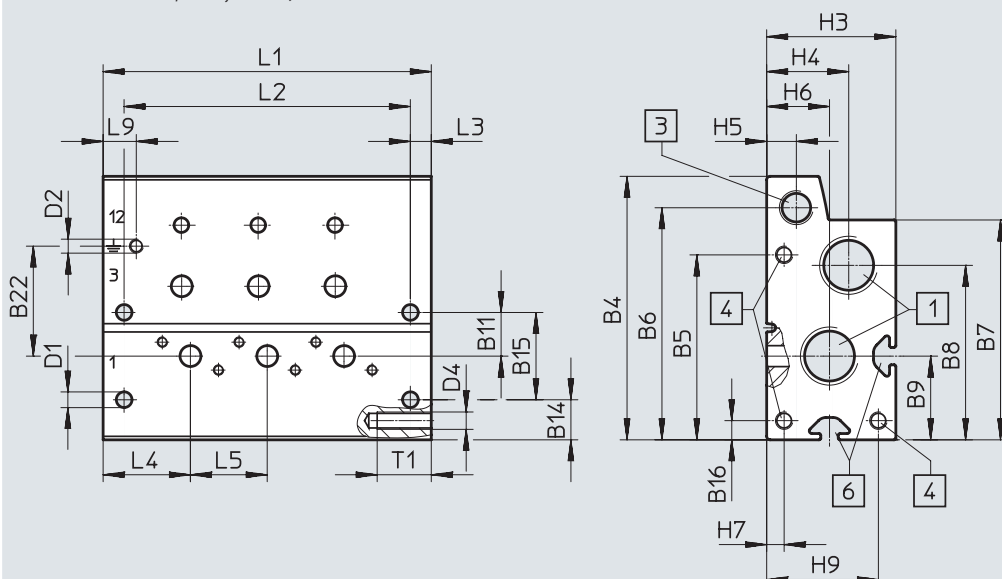

[1] Ports 1 and 3: G3/8

[3] Port 12: G1/8

[4] Thread M5x15.5 for extension module

[6] Profile slot IPM-05 system 5

Type	B4	B5	B6	B7	B8	B9	B11	B14	B15	B16	B22
VABM-B10-20E-G38-...-P3	75.5	53	66.5	63	50	24	12.5	11.5	25	5.5	31.5

Type	D1 ø	D2	D4	H3	H4	H5	H6	H7	H9	L3	L4	L5	L9	T1
VABM-B10-20E-G38-...-P3	4.5	M4x6.5	M5	37	23.5	8.5	18	5	32	6	25	22	9.5	15.5

Valve positions	2	3	4	5	6	7	8	9	10
L1	72	94	116	138	160	182	204	226	248
L2	60	82	104	126	148	170	192	214	236



## Technical data – Manifold block, size 20

## Dimensions

Download CAD data → [www.festo.com](http://www.festo.com)

Manifold block, extension module for 3/2-way valves, standard

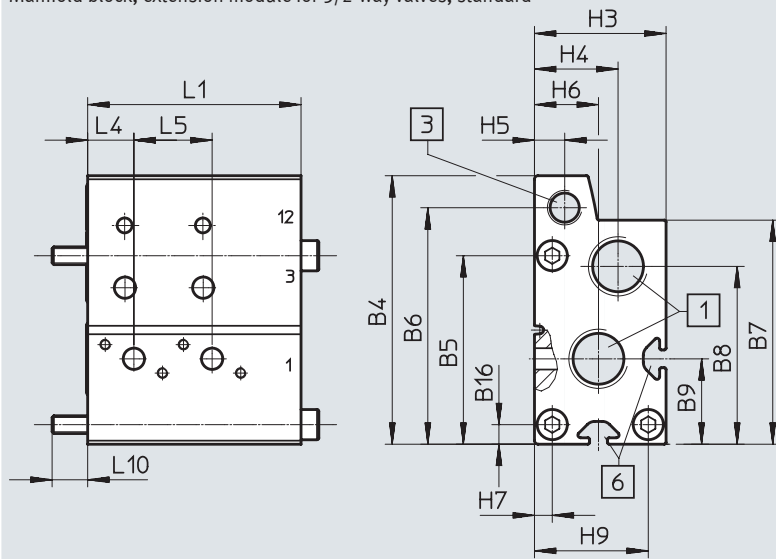

[1] Ports 1 and 3: G3/8

[3] Port 12: G1/8

[6] Profile slot IPM-05 system 5

Type	B4	B7	B6	B7	B8	B9	B16	H3
VABM-B10-20EEE-G38-2-P3	75.5	53	66.5	63	50	24	5.5	37

Type	H4	H5	H6	H7	H9	L1	L4	L5	L10
VABM-B10-20EEE-G38-2-P3	23.5	8.5	18	5	32	60	25	22	10

## Technical data – Manifold block, size 20

### Dimensions

Download CAD data → [www.festo.com](http://www.festo.com)

Manifold block for 5/2- and 5/3-way valves, standard

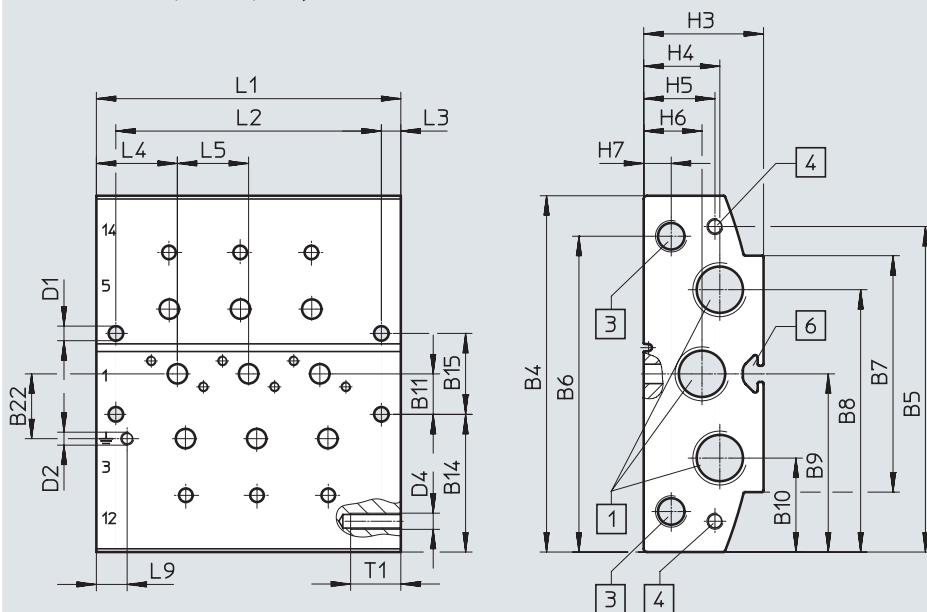

[1] Ports 1, 3 and 5: G3/8

[3] Ports 12 and 14: G1/8

[4] Thread M5x15.5 for extension module

[6] Profile slot IPM-05 system 5

Type	B4	B5	B6	B7	B8	B9	B10	B11	B14	B15	B22
VABM-B10-20E-G38-...	110	100.5	97.5	73	81	55	29	12.5	42.5	25	20

Type	D1 ø	D2	D4	H3	H4	H5	H6	H7	L3	L4	L5	L9	T1
VABM-B10-20E-G38-...	4.5	M4x6.5	M5	37	23.5	22	18	8.5	6	25	22	9.5	15.5

Valve positions	2	3	4	5	6	7	8	9	10
L1	72	94	116	138	160	182	204	226	248
L2	60	82	104	126	148	170	192	214	236

## Technical data – Manifold block, size 20

## Dimensions

Download CAD data → [www.festo.com](http://www.festo.com)

Manifold block, extension module for 5/2- and 5/3-way valves, standard

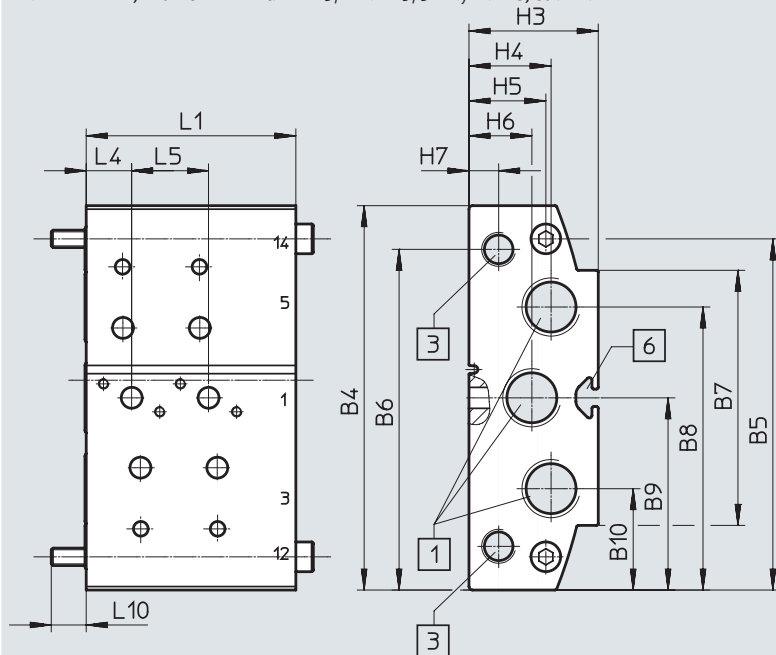

[1] Ports 1, 3 and 5: G3/8

[3] Ports 12 and 14: G1/8

[6] Profile slot IPM-05 system 5

Type	B4	B5	B6	B7	B8	B9	B10	H3
VABM-B10-20EEE-G38-2	110	100.5	97.5	73	81	55	29	37

Type	H4	H5	H6	H7	L1	L4	L5	L10
VABM-B10-20EEE-G38-2	23.5	22	18	8.5	60	13	22	10

### Technical data – Manifold block, size 20

**Dimensions**

Download CAD data → [www.festo.com](http://www.festo.com)

Manifold block for 3/2-way valves, compact

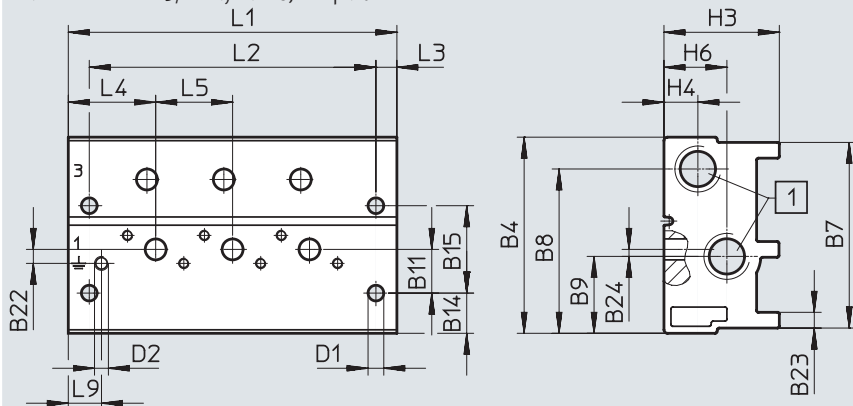

[1] Ports 1 and 3: G1/4

Type	B4	B7	B8	B9	B11	B14	B15	B22	B23	B24
VABM-B10-20S-G14-...-P3	56.1	53.1	47	22	12.5	11.5	25	4	4.5	2

Type	D1 ø	D2	H3	H4	H6	L3	L4	L5	L9
VABM-B10-20S-G14-...-P3	4.5	M4x6.5	33	9.7	18	6	25	22	9.5

Valve positions	2	3	4	5	6	7	8	9	10
L1	72	94	116	138	160	182	204	226	248
L2	60	82	104	126	148	170	192	214	236

**Dimensions**

Download CAD data → [www.festo.com](http://www.festo.com)

Manifold block for 5/2- and 5/3-way valves, compact

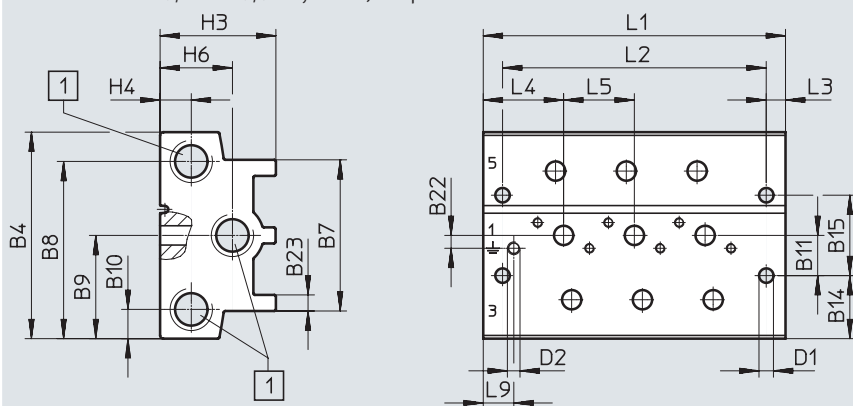

[1] Ports 1, 3 and 5: G1/4

Type	B4	B7	B8	B9	B10	B11	B14	B15	B22	B23
VABM-B10-20S-G14-...	64.2	47	55.1	32.1	9.1	12.5	19.6	25	4	5

Type	D1 ø	D2	H3	H4	H6	L3	L4	L5	L9
VABM-B10-20S-G14-...	4.5	M4x6.5	36	9.7	22.5	6	25	22	9.5

Valve positions	2	3	4	5	6	7	8	9	10
L1	72	94	116	138	160	182	204	226	248
L2	60	82	104	126	148	170	192	214	236

## Technical data – Manifold block, size 20

### Dimensions

Download CAD data → [www.festo.com](http://www.festo.com)

Common supply manifold, mounting on both sides

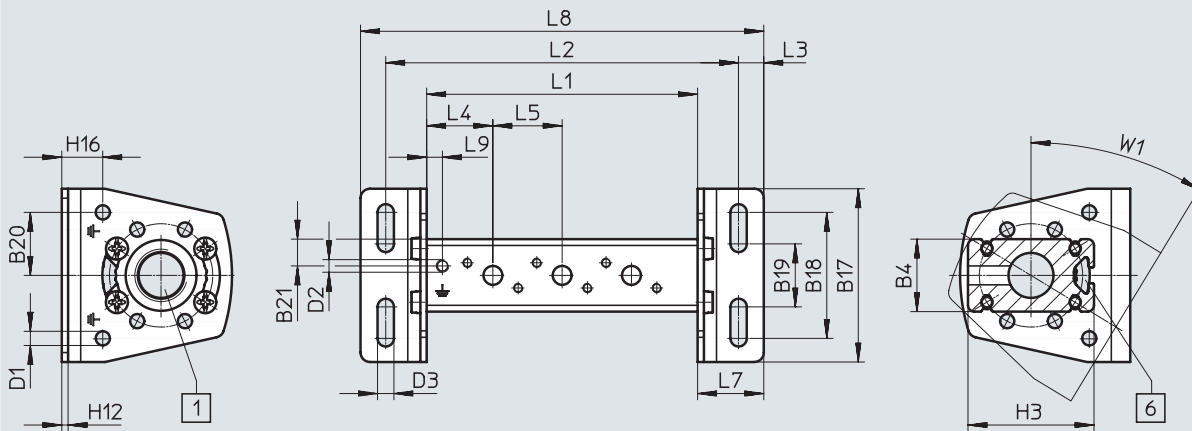

[1] Port 1: G3/8

[6] Profile slot IPM-05 system 5

 **Note**  
Mounting bracket can be adjusted through  $\pm 30^\circ$ .

Type	B4	B17	B18	B19	B20	B21	D1 $\varnothing$	D2	D3 $\varnothing$
VABM-B10-20-G38-...-P53	23	55	40	20	20	8.5	4.5	M4x6.5	5.2

Type	H3	H12	H16	L3	L4	L5	L7	L9	W1
VABM-B10-20-G38-...-P53	40	2	13	8	21	22	21	5	30°

Valve positions	2	3	4	5	6	7	8	9	10
L1	64	86	108	130	152	174	196	218	240
L2	90	112	134	156	178	200	222	244	266
L8	106	128	150	172	194	216	238	260	282

Technical data – Manifold block, size 20

Dimensions

Download CAD data → [www.festo.com](http://www.festo.com)

Common supply manifold, mounting on one side

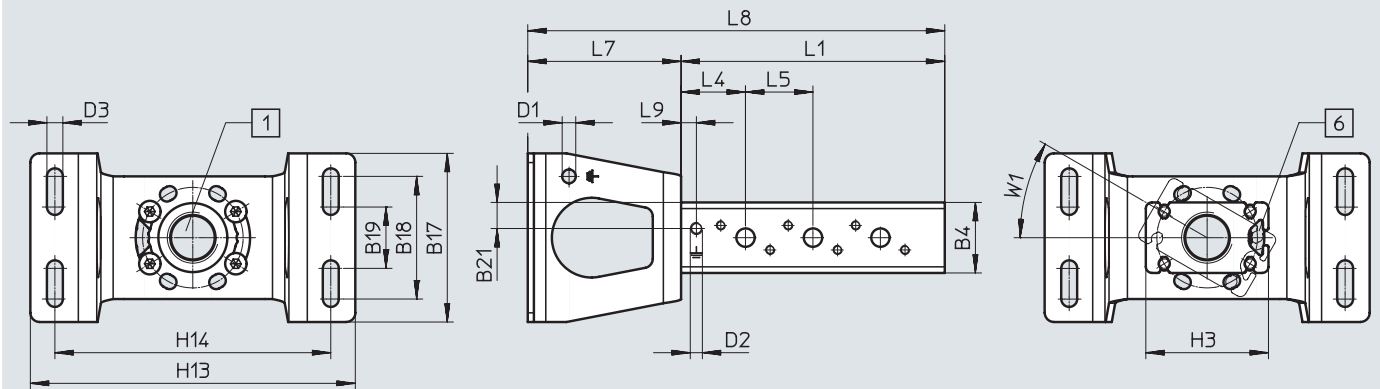

[1] Port 1: G3/8

[6] Profile slot IPM-05 system 5

 **Note**  
Mounting bracket can be adjusted through ±30°.

Type	B4	B17	B18	B19	B21	D1 ø	D2	D3 ø
VABM-B10-20-G38-2-P53-E	23	55	40	20	8.5	4.5	M4x6.5	5.2









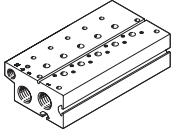

Type	H3	H13	H14	L4	L5	L7	L9	W1
VABM-B10-20-G38-2-P53-E	40	106	90	21	22	50	5	30°

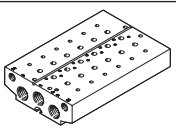

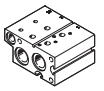
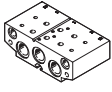
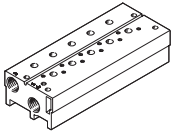
Valve positions	2	3	4
L1	64	86	108
L8	114	136	158

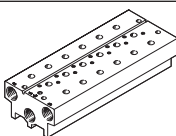
## Ordering data – Manifold block, size 20

Ordering data – Manifold block				
	Description	Valve positions	Part no.	Type
<b>Standard manifold block</b>				
	For 3/2-way valves, including seals and screws for mounting valves   <b>Note</b> • Blanking plugs for sealing the supply ports (1, 3 and 14) on one side are included in the scope of delivery. • Screw set (part number 8026203) to be ordered together with solenoid valves VUVS-LK.	2	576441	VABM-B10-20E-G38-2-P3
		3	576442	VABM-B10-20E-G38-3-P3
		4	576443	VABM-B10-20E-G38-4-P3
		5	576444	VABM-B10-20E-G38-5-P3
		6	576445	VABM-B10-20E-G38-6-P3
		7	576446	VABM-B10-20E-G38-7-P3
		8	576447	VABM-B10-20E-G38-8-P3
		9	576448	VABM-B10-20E-G38-9-P3
		10	576449	VABM-B10-20E-G38-10-P3
			For 5/2-way and 5/3-way valves, including seals and screws for mounting valves   <b>Note</b> • Blanking plugs for sealing the supply ports (1, 3, 5, 12 and 14) on one side are included in the scope of delivery. • Screw set (part number 8026203) to be ordered together with solenoid valves VUVS-LK.	2
3	576340			VABM-B10-20E-G38-3
4	576341			VABM-B10-20E-G38-4
5	576342			VABM-B10-20E-G38-5
6	576343			VABM-B10-20E-G38-6
7	576344			VABM-B10-20E-G38-7
8	576345			VABM-B10-20E-G38-8
9	576346			VABM-B10-20E-G38-9
10	576347			VABM-B10-20E-G38-10
<b>Manifold block, extension module for standard manifold block</b>				
	For 3/2-way valves, including seals and screws for mounting valves	2	576490	VABM-B10-20EEE-G38-2-P3
	For 5/2-way and 5/3-way valves, including seals and screws for mounting valves	2	576489	VABM-B10-20EEE-G38-2
<b>Compact manifold block</b>				
	For 3/2-way valves, including seals and screws for mounting valves   <b>Note</b> Blanking plugs for sealing the supply ports (1, 3 and 14) on one side are included in the scope of delivery.	2	★ 576465	VABM-B10-20S-G14-2-P3
		3	576466	VABM-B10-20S-G14-3-P3
		4	★ 576467	VABM-B10-20S-G14-4-P3
		5	576468	VABM-B10-20S-G14-5-P3
		6	★ 576469	VABM-B10-20S-G14-6-P3
		7	576470	VABM-B10-20S-G14-7-P3
		8	★ 576471	VABM-B10-20S-G14-8-P3
		9	576472	VABM-B10-20S-G14-9-P3
		10	★ 576473	VABM-B10-20S-G14-10-P3
			For 5/2-way and 5/3-way valves, including seals and screws for mounting valves   <b>Note</b> Blanking plugs for sealing the supply ports (1, 3, 5, 12 and 14) on one side are included in the scope of delivery.	2
3	576418			VABM-B10-20S-G14-3
4	★ 576419			VABM-B10-20S-G14-4
5	576420			VABM-B10-20S-G14-5
6	★ 576421			VABM-B10-20S-G14-6
7	576422			VABM-B10-20S-G14-7
8	★ 576423			VABM-B10-20S-G14-8
9	576424			VABM-B10-20S-G14-9
10	★ 576425			VABM-B10-20S-G14-10

Ordering data – Manifold block, size 20

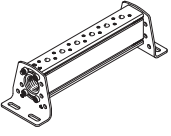
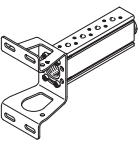



Ordering data	Description	Valve positions	Part no.	Type
<b>Common supply manifold</b>				
	For mounting on both sides, including seals and screws for mounting valves	2	★ 576363	VABM-B10-20-G38-2-P53
		3	576364	VABM-B10-20-G38-3-P53
		4	★ 576365	VABM-B10-20-G38-4-P53
		5	576366	VABM-B10-20-G38-5-P53
		6	★ 576367	VABM-B10-20-G38-6-P53
		7	576368	VABM-B10-20-G38-7-P53
		8	★ 576369	VABM-B10-20-G38-8-P53
		9	576370	VABM-B10-20-G38-9-P53
		10	★ 576371	VABM-B10-20-G38-10-P53
			For mounting on one side, including seals and screws for mounting valves	2
3	576415			VABM-B10-20-G38-3-P53-E
4	576416			VABM-B10-20-G38-4-P53-E

 - **Note**



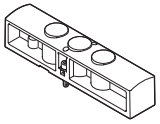
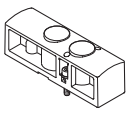

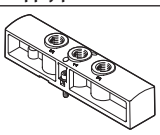
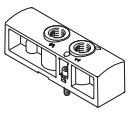
Blanking plug for sealing the supply port (1) on one side included in the scope of delivery.



## Ordering data – Manifold block, size 20





Ordering data	Description	Weight [g]	Part no.	Type
<b>Cover plate</b>				
	For valve position on manifold block for 5/2-, 5/3-way valves	78	★ 576410	VABB-B10-20-E
	For valve position on manifold block for 3/2-way valves	56	★ 576411	VABB-B10-20-E-P3
	For valve position on common supply manifold	13	★ 576409	VABB-B10-20-A
<b>Supply plate</b>				
	For valve position on manifold block for 5/2-, 5/3-way valves	78	576492	VABF-B10-20-P1A4-G18
	For valve position on manifold block for 3/2-way valves	56	576493	VABF-B10-20-P1A4-G18-P3
<b>Supply plate</b>				
	For valve position on common supply manifold	13	576491	VABF-B10-20-P1-G18

## Ordering data – Manifold block, size 20

Ordering data	Description		Part no.	Type	PU <sup>1)</sup>
<b>Push-in fitting with external hex</b>					
	Connecting thread M5 for tubing O.D.	12 mm	★ 186350	QS-G1/4-12	10
	Connecting thread G3/8 for tubing O.D.	16 mm	186347	QS-G3/8-16	1
<b>Push-in fitting with internal hex</b>					
	Connecting thread M5 for tubing O.D.	4 mm	★ 153315	QSM-M5-4-I	10
	Connecting thread G1/8 for tubing O.D.	4 mm	★ 186106	QS-G1/8-4-I	10
			133008	QS-G1/8-4-I-100	100
		6 mm	★ 186107	QS-G1/8-6-I	10
			133009	QS-G1/8-6-I-100	100
		8 mm	★ 186109	QS-G1/8-8-I	10
			133010	QS-G1/8-8-I-100	100
	Connecting thread G1/4 for tubing O.D.	8 mm	★ 186110	QS-G1/4-8-I	10
	Connecting thread G3/8 for tubing O.D.	10 mm	★ 186112	QS-G1/4-10-I	10
		8 mm	★ 186111	QS-G3/8-8-I	10
		10 mm	★ 186113	QS-G3/8-10-I	10
		12 mm	★ 186114	QS-G3/8-12-I	10
<b>Angled push-in fitting with external hex</b>					
	Connecting thread G1/8 for tubing O.D.	4 mm	★ 186116	QSL-G1/8-4	10
			132048	QSL-G1/8-4-100	100
		6 mm	★ 186117	QSL-G1/8-6	10
			132049	QSL-G1/8-6-100	100
		8 mm	★ 186119	QSL-G1/8-8	10
			132050	QSL-G1/8-8-50	50
	Connecting thread G1/4 for tubing O.D.	8 mm	★ 186120	QSL-G1/4-8	10
			132052	QSL-G1/4-8-50	50
		10 mm	★ 186122	QSL-G1/4-10	10
			132053	QSL-G1/4-10-50	50
		12 mm	★ 186351	QSL-G1/4-12	10
			132054	QSL-G1/4-12-20	20
	Connecting thread G3/8 for tubing O.D.	8 mm	★ 186121	QSL-G3/8-8	10
			132055	QSL-G3/8-8-50	50
		10 mm	★ 186123	QSL-G3/8-10	10
			132056	QSL-G3/8-10-20	20
		12 mm	★ 186124	QSL-G3/8-12	10
			132057	QSL-G3/8-12-20	20
16 mm	186348	QSL-G3/8-16	1		
<b>Angled push-in fitting, long, with external hex</b>					
	Connecting thread G1/8 for tubing O.D.	4 mm	186127	QSL-G1/8-4	10
			133015	QSL-G1/8-4-100	100
		6 mm	186128	QSL-G1/8-6	10
			133016	QSL-G1/8-6-100	100
		8 mm	186130	QSL-G1/8-8	10
			133017	QSL-G1/8-8-100	100

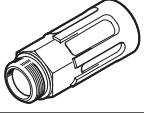
1) Packaging unit

## Ordering data – Manifold block, size 20

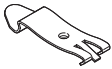
Ordering data	Description	Part no.	Type	PJ <sup>1)</sup>	
<b>Silencer</b>					
	With connecting thread G, polymer design	G1/8	★ 2307	U-1/8	1
			534222	U-1/8-50	50
		G1/4	★ 2316	U-1/4	1
			534223	U-1/4-20	20
	With connecting thread G, metal design	G3/8	6843	U-3/8-B	1
	With connecting thread G, sintered design, long	G1/4	★ 1205861	AMTE-M-LH-G14	20
		G3/8	★ 1205862	AMTE-M-LH-G38	10
<b>Blanking plug</b>					
	With connecting thread	G1/8	★ 3568	B-1/8	10
			534213	B-1/8-100	100
		G1/4	★ 3569	B-1/4	10
			534214	B-1/4-50	50
		G3/8	★ 3570	B-3/8	10
			534215	B-3/8-20	20
<b>Separator</b>					
	For creating pressure zones	G1/8	569995	VABD-8-B	1
		G1/4	569996	VABD-10-B	1
		G3/8	574483	VABD-14-B	1
<b>H-rail mounting</b>					
	For mounting the valve manifold assembly on standard H-rail TH 35-7.5 or TH 35-15, to EN 60715	★ 569998	VAME-T-M4	2	

1) Packaging unit

## Technical data – Manifold block, size 25

 Flow rate  
 up to 1300 l/min

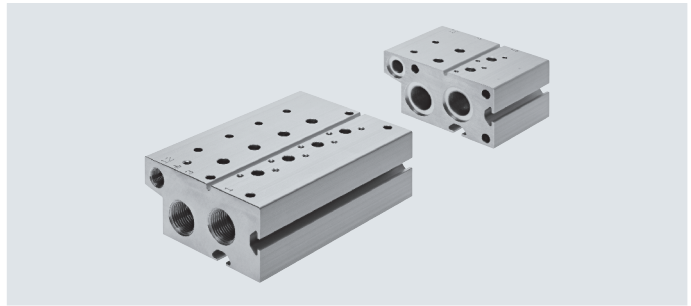

General technical data	Standard manifold block		Extension module for standard manifold block		Compact manifold block		Common supply manifold		
	3/2	5/2, 5/3	3/2	5/2, 5/3	3/2	5/2, 5/3	on both sides	on one side	
Valve function	3/2	5/2, 5/3	3/2	5/2, 5/3	3/2	5/2, 5/3	3/2, 5/2, 5/3		
Grid dimension [mm]	27.5								
Type of mounting	With through-hole						Via mounting bracket		
Max. number of valve positions	10		2	2	10		10	4	
Port 1	G1/2	G1/2	G1/2	G1/2	G3/8	G3/8	G1/2	G1/2	
Port 3	G1/2	G1/2	G1/2	G1/2	G3/8	G3/8	–	–	
Port 5	–	G1/2	–	G1/2	–	G3/8	–	–	
Port 12	G1/8	G1/8	G1/8	G1/8	–	–	–	–	
Port 14	–	G1/8	–	G1/8	–	–	–	–	
Corrosion resistance <sup>1)</sup>	2								

1) Corrosion resistance class CRC 2 to Festo standard FN 940070

Moderate corrosion stress. Indoor applications in which condensation can occur. External visible parts with primarily decorative surface requirements which are in direct contact with a normal industrial environment.

Weight [g]	2	3	4	5	6	7	8	9	10
<b>Manifold block for 3/2-way valves, standard</b>									
VABM-B10-25E-G12-...-P3	726	960	1194	1428	1662	1896	2130	2364	2598
<b>Manifold block, extension module for 3/2-way valves, standard</b>									
VABM-B10-25EEE-G12-2-P3	340	–	–	–	–	–	–	–	–
<b>Manifold block for 5/2- and 5/3-way valves, standard</b>									
VABM-B10-25E-G12-...	927	1224	1521	1818	2115	2412	2709	3006	3303
<b>Manifold block, extension module for 5/2- and 5/3-way valves, standard</b>									
VABM-B10-25EEE-G12-2	258	–	–	–	–	–	–	–	–
<b>Manifold block for 3/2-way valves, compact</b>									
VABM-B10-25S-G38-...-P3	369	488	607	726	845	964	1083	1202	1321
<b>Manifold block for 5/2- and 5/3-way valves, compact</b>									
VABM-B10-25S-G38-...	438	579	720	861	1002	1143	1284	1425	1566
<b>Common supply manifold for mounting on both sides</b>									
VABM-B10-25-G38-...-P53	258	340	422	504	586	668	750	832	914
<b>Common supply manifold for mounting on one side</b>									
VABM-B10-25-G38-2-P53-E	258	340	422	–	–	–	–	–	–

## Technical data – Manifold block, size 25

Materials	
Manifold rail	Wrought aluminium alloy
Note on materials	RoHS-compliant

### Dimensions

Download CAD data → [www.festo.com](http://www.festo.com)

Manifold block for 3/2-way valves, standard

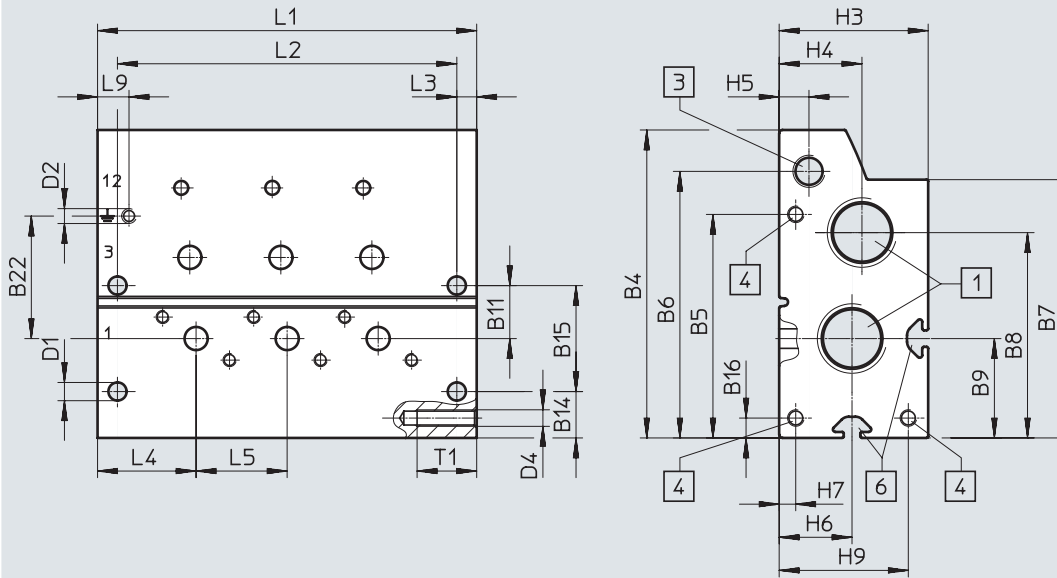

[1] Ports 1 and 3: G1/2

[3] Port 12: G1/8

[4] Thread M5x18 for extension module

[6] Profile slot IPM-05 system 5

Type	B4	B5	B6	B7	B8	B9	B11	B14	B15	B16	B22
VABM-B10-25E-G12-....P3	93	67.5	80.5	78	62	30	16	14	32	6	37

Type	D1 ø	D2	D4	H3	H4	H5	H6	H7	H9	L3	L4	L5	L9	T1
VABM-B10-25E-G12-....P3	5.5	M4x9	M5	45	25	9	22	5	39	6	29.8	27.5	9.5	18

Valve positions	2	3	4	5	6	7	8	9	10
L1	87	114.5	142	169.5	197	224.5	252	279.5	307
L2	75	102.5	130	157.5	185	212.5	240	267.5	295

## Technical data – Manifold block, size 25

### Dimensions

Download CAD data → [www.festo.com](http://www.festo.com)

Manifold block, extension module for 3/2-way valves, standard

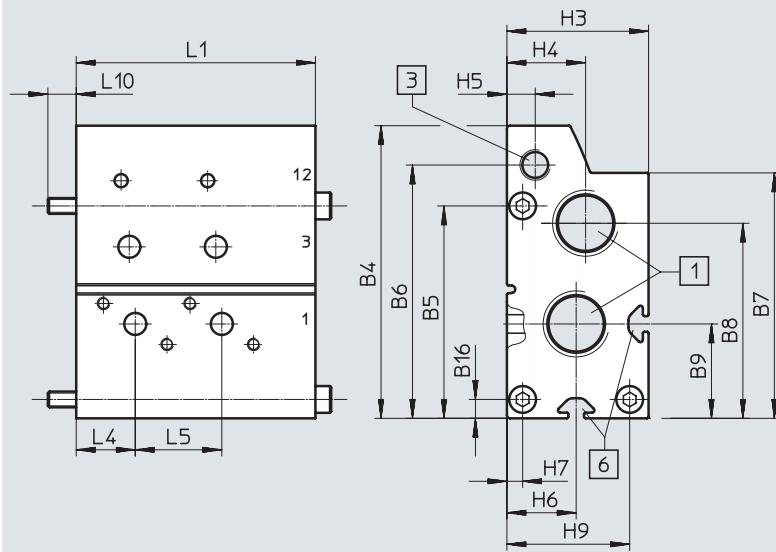

[1] Ports 1 and 3: G1/2

[3] Port 12: G1/8

[6] Profile slot IPM-05 system 5

Type	B4	B5	B6	B7	B8	B9	B16	H3
VABM-B10-25EEE-G12-2-P3	93	67.5	80.5	78	62	30	6	45

Type	H4	H5	H6	H7	H9	L4	L5	L10	L1
VABM-B10-25EEE-G12-2-P3	25	9	22	5	39	18.8	27.5	9	76

### Technical data – Manifold block, size 25

**Dimensions**

Download CAD data → [www.festo.com](http://www.festo.com)

Manifold block for 5/2- and 5/3-way valves, standard

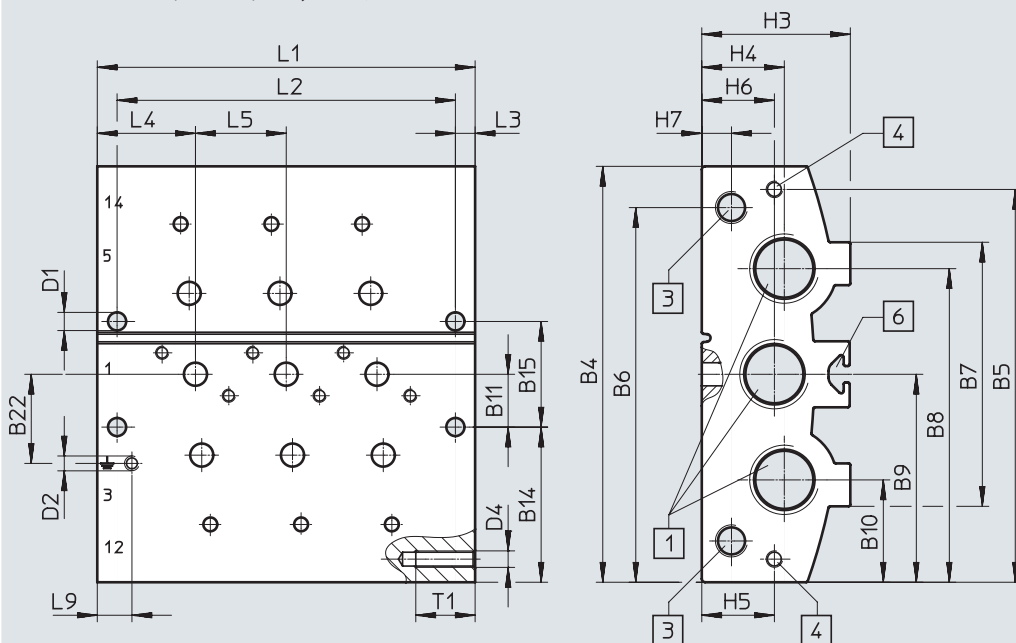

- [1] Ports 1, 3 and 5: G1/2
- [3] Ports 12 and 14: G1/8
- [4] Thread M5x18 for extension module
- [6] Profile slot IPM-05 system 5

Type	B4	B5	B6	B7	B8	B9	B10	B11	B14	B15	B22
VABM-B10-25E-G12-...	126	119	113.5	80	95	63	31	16	47	32	27

Type	D1 ø	D2	D4	H3	H4	H5	H6	H7	L3	L4	L5	L9	T1
VABM-B10-25E-G12-...	5.5	M4x9	M5	45	25	22	22	9	6	29.8	27.5	10.5	18

Valve positions	2	3	4	5	6	7	8	9	10
L1	87	114.5	142	169.5	197	224.5	252	279.5	307
L2	75	102.5	130	157.5	185	212.5	240	267.5	295

## Technical data – Manifold block, size 25

### Dimensions

Download CAD data → [www.festo.com](http://www.festo.com)

Manifold block, extension module for 5/2- and 5/3-way valves, standard

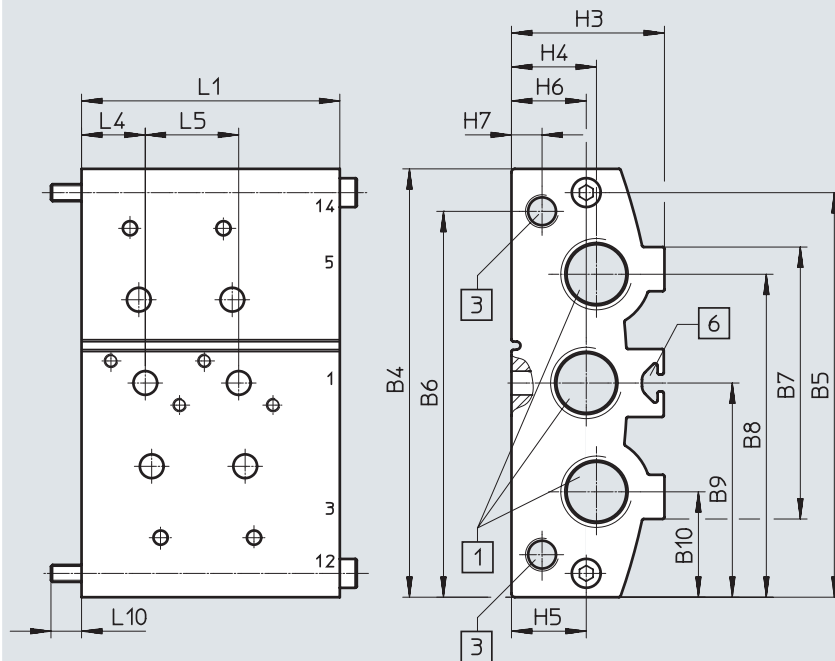

[1] Ports 1, 3 and 5: G1/2

[3] Ports 12 and 14: G1/8

[6] Profile slot IPM-05 system 5

Type	B4	B5	B6	B7	B8	B9	B10	H3
VABM-B10-25EEE-G12-2	110	100.5	97.5	73	81	55	29	37

Type	H4	H5	H6	H7	L1	L4	L5	L10
VABM-B10-25EEE-G12-2	23.5	22	18	8.5	60	13	22	10



## Technical data – Manifold block, size 25

## Dimensions

Download CAD data → [www.festo.com](http://www.festo.com)

Manifold block for 3/2-way valves, compact

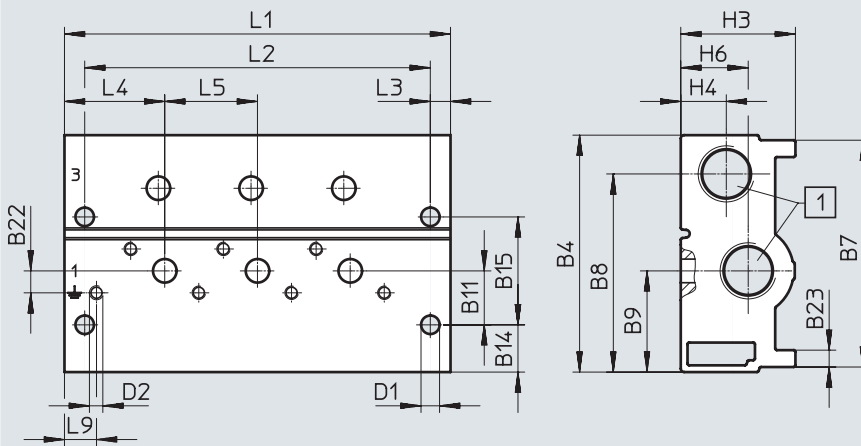

[1] Ports 1 and 3: G3/8

Type	B4	B7	B8	B9	B11	B14	B15	B22	B23
VABM-B10-25S-G38-...-P3	70.3	67.3	58.8	30	16	14	32	6.5	5

Type	D1 ø	D2	H3	H4	H6	L3	L4	L5	L9
VABM-B10-25S-G38-...-P3	5.5	M4x9	34	13.5	20	6	29.8	27.5	9.5

Valve positions	2	3	4	5	6	7	8	9	10
L1	87	114.5	142	169.5	197	224.5	252	279.5	307
L2	75	102.5	130	157.5	185	212.5	240	267.5	295

## Dimensions

Download CAD data → [www.festo.com](http://www.festo.com)

Manifold block for 5/2- and 5/3-way valves, compact

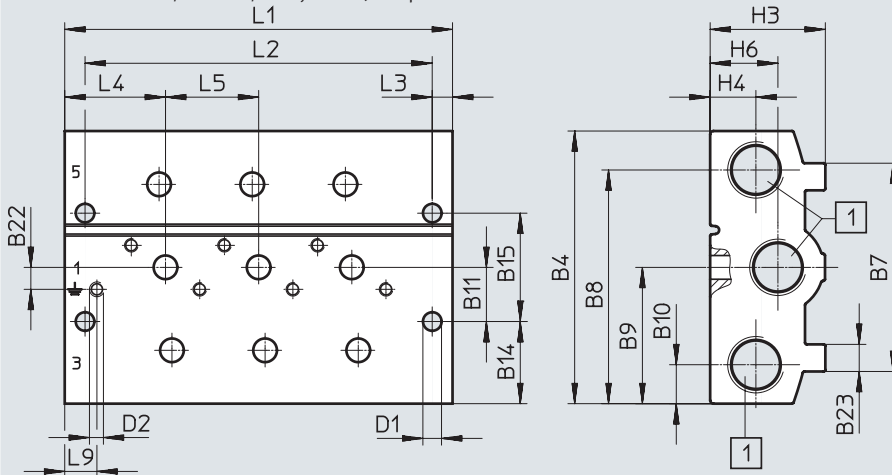

[1] Ports 1, 3 and 5: G3/8

Type	B4	B7	B8	B9	B10	B11	B14	B15	B22	B23
VABM-B10-25S-G38-...	80.5	61.5	69	40.3	11.5	16	24.3	32	6.5	8

Type	D1 ø	D2	H3	H4	H6	L3	L4	L5	L9
VABM-B10-25S-G38-...	5.5	M4x9	34	13.5	20	6	29.8	27.5	9.5

Valve positions	2	3	4	5	6	7	8	9	10
L1	87	114.5	142	169.5	197	224.5	252	279.5	307
L2	75	102.5	130	157.5	185	212.5	240	267.5	295

## Technical data – Manifold block, size 25

### Dimensions

Download CAD data → [www.festo.com](http://www.festo.com)

Common supply manifold, mounting on both sides

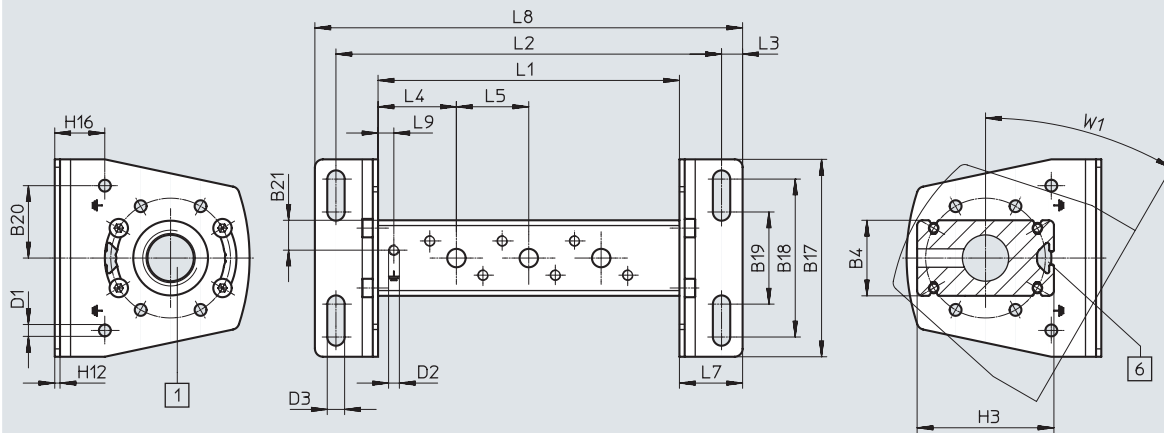

[1] Port 1: G1/2

[6] Profile slot IPM-05 system 5

-  - **Note**

Mounting bracket can be adjusted through  $\pm 30^\circ$ .

Type	B4	B17	B18	B19	B20	B21	D1 $\varnothing$	D2	D3 $\varnothing$
VABM-B10-25-G12-...-P53	28.7	75	60	35	27.5	11.4	4.5	M4x9	6.6

Type	H3	H12	H16	L3	L4	L5	L7	L9	W1
VABM-B10-25-G12-...-P53	52	2	19	8	29.8	27.5	24	6	30°

Valve positions	2	3	4	5	6	7	8	9	10
L1	87	114.5	142	169.5	197	224.5	252	279.5	307
L2	119	146.5	174	201.5	229	256.5	284	311.5	339
L8	135	162.5	190	217.5	245	272.5	300	327.5	355

## Technical data – Manifold block, size 25

## Dimensions

Download CAD data → [www.festo.com](http://www.festo.com)

Common supply manifold, mounting on one side

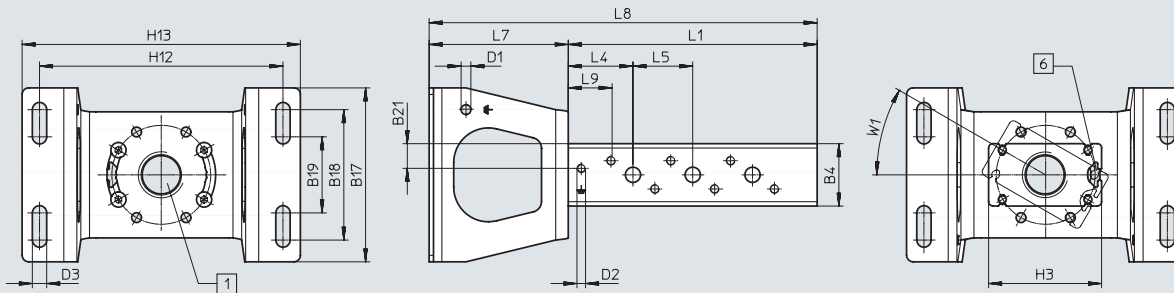

[1] Port 1: G1/2

[6] Profile slot IPM-05 system 5

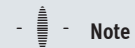





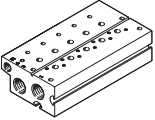

**Note**Mounting bracket can be adjusted through  $\pm 30^\circ$ .

Type	B4	B17	B18	B19	B21	D1 $\varnothing$	D2	D3 $\varnothing$
VABM-B10-25-G12-...-P53-E	28.7	80	60	35	11.4	4.5	M4x9	6.6

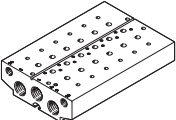
Type	H3	H13	H14	L4	L5	L7	L9	W1
VABM-B10-25-G12-...-P53-E	52	128	112	29.8	27.5	64	6	30°

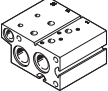
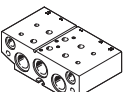
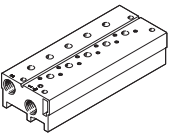
Valve positions	2	3	4
L1	87	114.5	142
L8	151	178.5	206

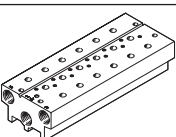
## Ordering data – Manifold block, size 25

Ordering data – Manifold block				
	Description	Valve positions	Part no.	Type
<b>Standard manifold block</b>				
	For 3/2-way valves, including seals and screws for mounting valves  -  - <b>Note</b> • Blanking plugs for sealing the supply ports (1, 3 and 14) on one side are included in the scope of delivery. • Screw set (part number 8026203) to be ordered together with solenoid valves VUVS-LK.	2	8026279	VABM-B10-25E-G12-2-P3
		3	8026280	VABM-B10-25E-G12-3-P3
		4	8026281	VABM-B10-25E-G12-4-P3
		5	8026282	VABM-B10-25E-G12-5-P3
		6	8026283	VABM-B10-25E-G12-6-P3
		7	8026284	VABM-B10-25E-G12-7-P3
		8	8026285	VABM-B10-25E-G12-8-P3
		9	8026286	VABM-B10-25E-G12-9-P3
		10	8026287	VABM-B10-25E-G12-10-P3
			For 5/2-way and 5/3-way valves, including seals and screws for mounting valves  -  - <b>Note</b> • Blanking plugs for sealing the supply ports (1, 3, 5, 12 and 14) on one side are included in the scope of delivery. • Screw set (part number 8026203) to be ordered together with solenoid valves VUVS-LK.	2
3	8026244			VABM-B10-25E-G12-3
4	8026245			VABM-B10-25E-G12-4
5	8026246			VABM-B10-25E-G12-5
6	8026247			VABM-B10-25E-G12-6
7	8026248			VABM-B10-25E-G12-7
8	8026249			VABM-B10-25E-G12-8
9	802625			VABM-B10-25E-G12-9
10	8026251			VABM-B10-25E-G12-10
<b>Manifold block, extension module for standard manifold block</b>				
	For 3/2-way valves, including seals and screws for mounting valves	2	8026316	VABM-B10-25EEE-G12-2-P3
	For 5/2-way and 5/3-way valves, including seals and screws for mounting valves	2	8026315	VABM-B10-25EEE-G12-2
<b>Compact manifold block</b>				
	For 3/2-way valves, including seals and screws for mounting valves  -  - <b>Note</b> Blanking plugs for sealing the supply ports (1, 3 and 14) on one side are included in the scope of delivery.	2	★ 8026297	VABM-B10-25S-G38-2-P3
		3	8026298	VABM-B10-25S-G38-3-P3
		4	★ 8026299	VABM-B10-25S-G38-4-P3
		5	8026300	VABM-B10-25S-G38-5-P3
		6	★ 8026301	VABM-B10-25S-G38-6-P3
		7	8026302	VABM-B10-25S-G38-7-P3
		8	★ 8026303	VABM-B10-25S-G38-8-P3
		9	8026304	VABM-B10-25S-G38-9-P3
		10	★ 8026305	VABM-B10-25S-G38-10-P3
			For 5/2-way and 5/3-way valves, including seals and screws for mounting valves  -  - <b>Note</b> Blanking plugs for sealing the supply ports (1, 3, 5, 12 and 14) on one side are included in the scope of delivery.	2
3	8026262			VABM-B10-25S-G38-3
4	★ 8026263			VABM-B10-25S-G38-4
5	8026264			VABM-B10-25S-G38-5
6	★ 8026265			VABM-B10-25S-G38-6
7	8026266			VABM-B10-25S-G38-7
8	★ 8026267			VABM-B10-25S-G38-8
9	8026268			VABM-B10-25S-G38-9
10	★ 8026269			VABM-B10-25S-G38-10



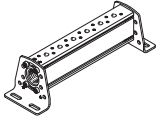
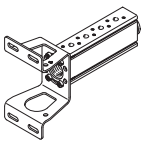

## Ordering data – Manifold block, size 25

Ordering data	Description	Valve positions	Part no.	Type
<b>Common supply manifold</b>				
	For mounting on both sides, including seals and screws for mounting valves	2	★ 8026219	VABM-B10-25-G12-2-P53
		3	8026220	VABM-B10-25-G12-3-P53
		4	★ 8026221	VABM-B10-25-G12-4-P53
		5	8026222	VABM-B10-25-G12-5-P53
		6	★ 8026223	VABM-B10-25-G12-6-P53
		7	8026224	VABM-B10-25-G12-7-P53
		8	★ 8026225	VABM-B10-25-G12-8-P53
		9	8026226	VABM-B10-25-G12-9-P53
		10	★ 8026227	VABM-B10-25-G12-10-P53
			For mounting on one side, including seals and screws for mounting valves	2
3	8026238			VABM-B10-25-G12-3-P53-E
4	8026239			VABM-B10-25-G12-4-P53-E

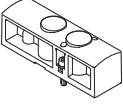
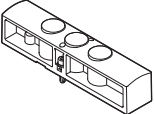

 **Note**

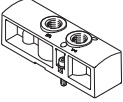
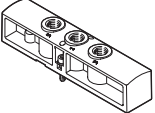
Blanking plug for sealing the supply port (1) on one side included in the scope of delivery.

## Ordering data – Manifold block, size 25



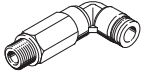

Ordering data	Description	Weight [g]	Part no.	Type
<b>Cover plate</b>				
	For valve position on manifold block for 3/2-way valves	84	★ 8026210	VABB-B10-25-E-P3
	For valve position on manifold block for 5/2-, 5/3-way valves	117	★ 8026209	VABB-B10-25-E
	For valve position on common supply manifold	28	★ 8026208	VABB-B10-25-A
<b>Supply plate</b>				
	For valve position on manifold block for 3/2-way valves	80	8026319	VABF-B10-25-P1A4-G14-P3
	For valve position on manifold block for 5/2-, 5/3-way valves	110	8026318	VABF-B10-25-P1A4-G14
<b>Supply plate</b>				
	For valve position on common supply manifold	26	8026317	VABF-B10-25-P1-G14

## Ordering data – Manifold block, size 25

Ordering data					
	Description		Part no.	Type	PU <sup>1)</sup>
<b>Push-in fitting with external hex</b>					
	Connecting thread G3/8 for tubing O.D.	16 mm	186347	QS-G3/8-16	1
	Connecting thread G1/2 for tubing O.D.	16 mm	186105	QS-G1/2-16	1
			132047	QS-G1/2-16-20	20
<b>Push-in fitting with internal hex</b>					
	Connecting thread M5 for tubing O.D.	4 mm	★ 153315	QSM-M5-4-I	10
	Connecting thread G1/8 for tubing O.D.	6 mm	★ 186107	QS-G1/8-6-I	10
			133009	QS-G1/8-6-I-100	100
			★ 186108	QS-G1/4-6-I	10
	Connecting thread G1/4 for tubing O.D.	6 mm	★ 186110	QS-G1/4-8-I	10
		8 mm	★ 186112	QS-G1/4-10-I	10
		10 mm	★ 186111	QS-G3/8-8-I	10
	Connecting thread G3/8 for tubing O.D.	8 mm	★ 186113	QS-G3/8-10-I	10
		10 mm	★ 186114	QS-G3/8-12-I	10
12 mm		★ 186115	QS-G1/2-12-I	1	
Connecting thread G1/2 for tubing O.D.	12 mm				
<b>Angled push-in fitting with external hex</b>					
	Connecting thread G1/4 for tubing O.D.	6 mm	★ 186118	QSL-G1/4-6	10
			132051	QSL-G1/4-6-100	100
		8 mm	★ 186120	QSL-G1/4-8	10
			132052	QSL-G1/4-8-50	50
			★ 186122	QSL-G1/4-10	10
	Connecting thread G3/8 for tubing O.D.	10 mm	132053	QSL-G1/4-10-50	50
		8 mm	★ 186121	QSL-G3/8-8	10
			132055	QSL-G3/8-8-50	50
			★ 186123	QSL-G3/8-10	10
		12 mm	132056	QSL-G3/8-10-20	20
			★ 186124	QSL-G3/8-12	10
			132057	QSL-G3/8-12-20	20
	16 mm	186348	QSL-G3/8-16	1	
	Connecting thread G1/2 for tubing O.D.	12 mm	★ 186125	QSL-G1/2-12	1
			132058	QSL-G1/2-12-20	20
16 mm		186126	QSL-G1/2-16	1	
		132059	QSL-G1/2-16-20	20	
<b>Angled push-in fitting, long, with external hex</b>					
	Connecting thread G1/4 for tubing O.D.	6 mm	186129	QSL-G1/4-6	10
		8 mm	186131	QSL-G1/4-8	10
		10 mm	186133	QSL-G1/4-10	10

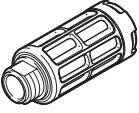
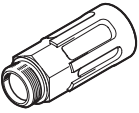
1) Packaging unit

## Ordering data – Manifold block, size 25

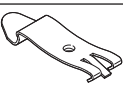
Ordering data	Description	Part no.	Type	PU <sup>1)</sup>	
<b>Silencer</b>					
	With connecting thread G, polymer design	G1/4	★ 2316	U-1/4	1
			534223	U-1/4-20	20
		G3/8	534224	U-3/8-20	20
	With connecting thread G, metal design	G3/8	6843	U-3/8-B	1
		G1/2	6844	U-1/2-B	1
	With connecting thread G, sintered design, long	G3/8	★ 1205862	AMTE-M-LH-G38	10
		G1/2	★ 1205863	AMTE-M-LH-G12	10
<b>Blanking plug</b>					
	With connecting thread	G1/8	★ 3568	B-1/8	10
			534213	B-1/8-100	100
		G3/8	★ 3570	B-3/8	10
			534215	B-3/8-20	20
		G1/2	★ 3571	B-1/2	10
			534216	B-1/2-20	20
<b>Separator</b>					
	For creating pressure zones	G1/8	569995	VABD-8-B	1
		G3/8	574483	VABD-14-B	1
		G1/2	8022483	VABD-17.5-B	1
<b>H-rail mounting</b>					
	For mounting the valve manifold assembly on standard H-rail TH 35-7.5 or TH 35-15, to EN 60715	2636436	VAME-T-M5	2	

1) Packaging unit



## Technical data – Manifold block, size 30

-  - Flow rate  
up to 2300 l/min

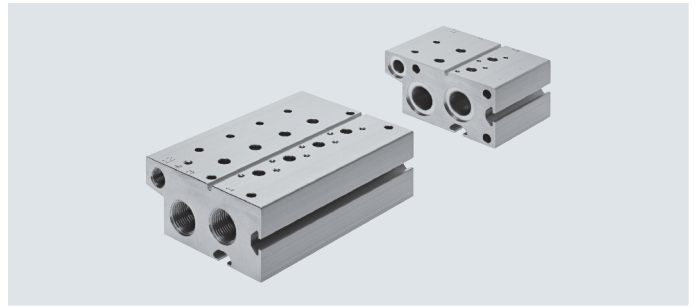

General technical data	Standard manifold block		Extension module for standard manifold block		Compact manifold block		Common supply manifold	
	3/2	5/2, 5/3	3/2	5/2, 5/3	3/2	5/2, 5/3	on both sides	on one side
For valve function	3/2	5/2, 5/3	3/2	5/2, 5/3	3/2	5/2, 5/3	3/2, 5/2, 5/3	
Grid dimension [mm]	32							
Type of mounting	With through-hole						Via mounting bracket	
Max. number of valve positions	10	10	2	2	10		10	4
Port 1	G3/4	G3/4	G3/4	G3/4	G1/2	G1/2	G3/4	G3/4
Port 3	G3/4	G3/4	G3/4	G3/4	G1/2	G1/2	-	-
Port 5	-	G3/4	-	G3/4	-	G1/2	-	-
Port 12	G1/8	G1/8	G1/8	G1/8	-	-	-	-
Port 14	-	G1/8	-	G1/8	-	-	-	-
Corrosion resistance class CRC <sup>1)</sup>	2							

1) Corrosion resistance class CRC 2 to Festo standard FN 940070

Moderate corrosion stress. Indoor applications in which condensation can occur. External visible parts with primarily decorative surface requirements which are in direct contact with a normal industrial environment.

Weight [g]									
Valve positions	2	3	4	5	6	7	8	9	10
<b>Manifold block for 3/2-way valves, standard</b>									
VABM-B10-30E-G34-...-P3	1411	1828	2245	2662	3079	3496	3913	4330	4747
<b>Manifold block, extension module for 3/2-way valves, standard</b>									
VABM-B10-30EEE-G34-2-P3	1111	-	-	-	-	-	-	-	-
<b>Manifold block for 5/2- and 5/3-way valves, standard</b>									
VABM-B10-30E-G34-...	1722	2213	2703	3194	3684	4175	4665	5156	5646
<b>Manifold block, extension module for 5/2- and 5/3-way valves, standard</b>									
VABM-B10-30EEE-G34-2	1318	-	-	-	-	-	-	-	-
<b>Manifold block for 3/2-way valves, compact</b>									
VABM-B10-30S-G12-...-P3	652	872	1093	1313	1533	1753	1973	2193	2413
<b>Manifold block for 5/2- and 5/3-way valves, compact</b>									
VABM-B10-30S-G12-...	759	1013	1267	1522	1776	2030	2285	2539	2793
<b>Common supply manifold for mounting on both sides</b>									
VABM-B10-30-G34-...-P53	818	977	1135	1293	1452	1610	1768	1927	2085
<b>Common supply manifold for mounting on one side</b>									
VABM-B10-30-G34-2-P53-E	852	1011	1169	-	-	-	-	-	-

## Technical data – Manifold block, size 30

Materials	
Manifold rail	Wrought aluminium alloy
Note on materials	RoHS-compliant

### Dimensions

Download CAD data → [www.festo.com](http://www.festo.com)

Manifold block for 3/2-way valves, standard

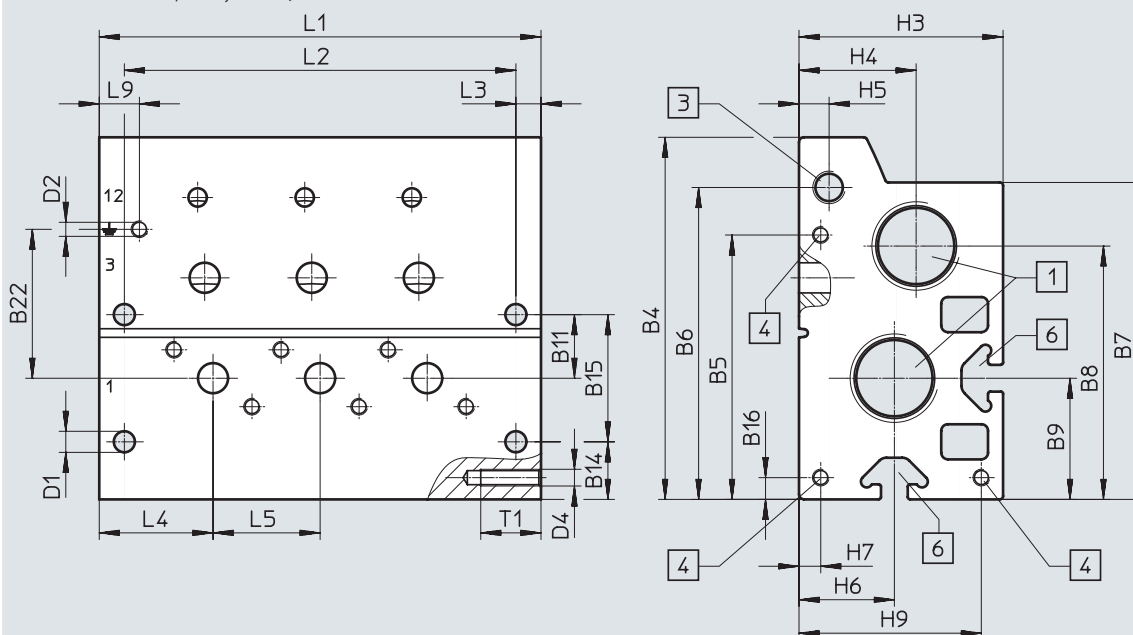

[1] Ports 1 and 3: G3/4

[3] Port 12: G1/8

[4] Thread M5x18 for extension module

[6] Profile slot IPM-08 system 8

Type	B4	B5	B6	B7	B8	B9	B11	B14	B15	B16	B22
VABM-B10-30E-G34-...-P3	108.2	79	93.2	94.7	75.7	36.2	19	17.2	38	6.5	44.5

Type	D1 ø	D2	D4	H3	H4	H5	H6	H7	H9	L3	L4	L5	L9	T1
VABM-B10-30E-G34-...-P3	6.3	M5x11	M5	61	35	9	28.5	6.5	54.5	7.5	34	32	12	18

Valve positions	2	3	4	5	6	7	8	9	10
L1	100	132	164	196	228	260	292	324	356
L2	85	117	149	181	213	245	277	309	341

## Technical data – Manifold block, size 30

## Dimensions

Download CAD data → [www.festo.com](http://www.festo.com)

Manifold block, extension module for 3/2-way valves, standard

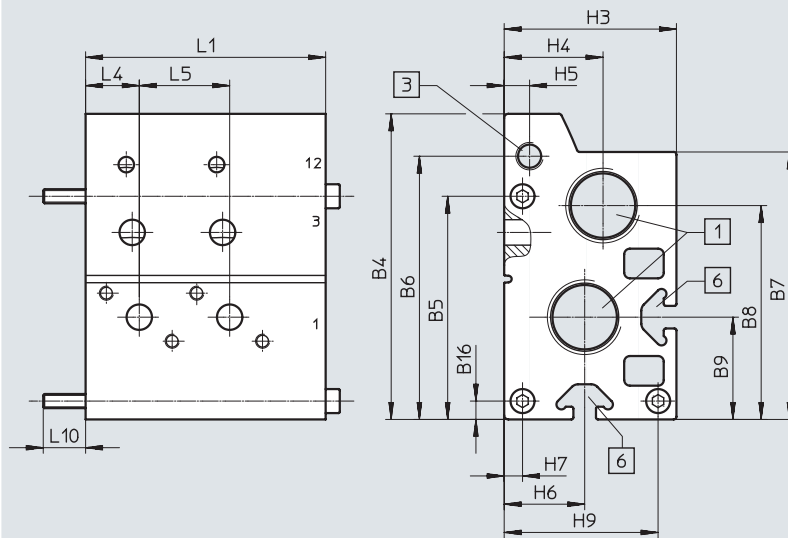

[1] Ports 1 and 3: G3/4

[3] Port 12: G1/8

[6] Profile slot IPM-08 system 8

Type	B4	B5	B6	B7	B8	B9	B16	H3
VABM-B10-30EEE-G34-2-P3	108.2	79	93.2	94.7	75.7	36.2	6.5	61

Type	H4	H5	H6	H7	H9	L4	L5	L10	L1
VABM-B10-30EEE-G34-2-P3	35	9	28.5	6.5	54.5	19	32	15	85

### Technical data – Manifold block, size 30

**Dimensions**

Download CAD data → [www.festo.com](http://www.festo.com)

Manifold block for 5/2- and 5/3-way valves, standard

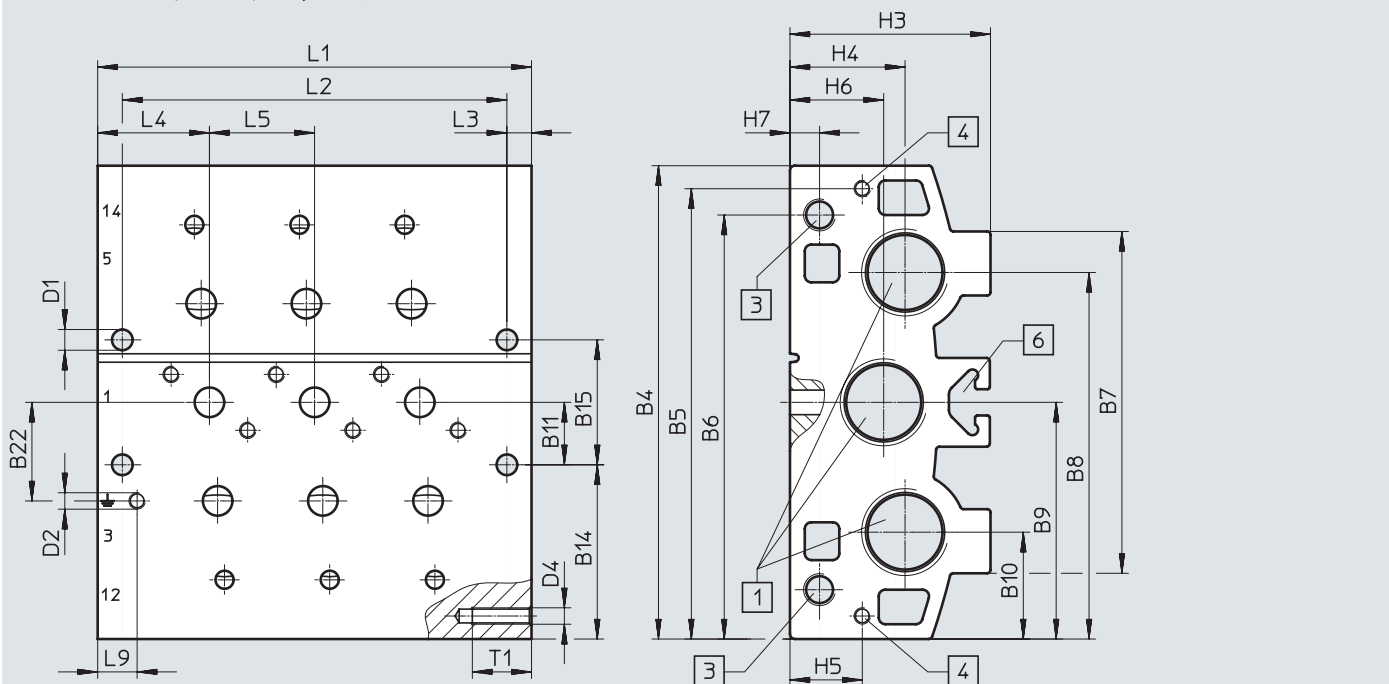

- [1] Ports 1, 3 and 5: G3/4
- [3] Ports 12 and 14: G1/8
- [4] Thread M5x18 for extension module
- [6] Profile slot IPM-08 system 8

Type	B4	B5	B6	B7	B8	B9	B10	B11	B14	B15	B22
VABM-B10-30E-G34-...	144	137	129	104	111.5	72	32.5	19	53	38	30

Type	D1 ø	D2	D4	H3	H4	H5	H6	H7	L3	L4	L5	L9	T1
VABM-B10-30E-G34-...	6.3	M5x11	M5	61	35	22	28.5	9	7.5	34	32	12	18

Valve positions	2	3	4	5	6	7	8	9	10
L1	100	132	164	196	228	260	292	324	356
L2	85	117	149	181	213	245	277	309	341

## Technical data – Manifold block, size 30

## Dimensions

Download CAD data → [www.festo.com](http://www.festo.com)

Manifold block, extension module for 5/2- and 5/3-way valves, standard

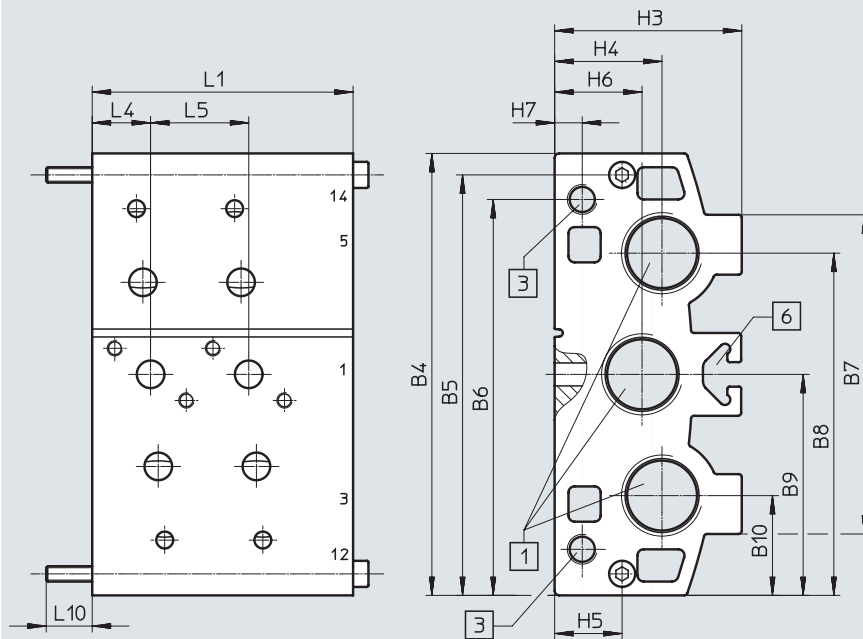

[1] Ports 1, 3 and 5: G3/4

[3] Ports 12 and 14: G1/8

[6] Profile slot IPM-08 system 8

Type	B4	B5	B6	B7	B8	B9	B10	H3
VABM-B10-30EEE-G34-2	144	137	129	104	111.5	72	32.5	61

Type	H4	H5	H6	H7	L1	L4	L5	L10
VABM-B10-30EEE-G34-2	35	22	28.5	9	85	19	32	15

## Technical data – Manifold block, size 30

### Dimensions

Download CAD data → [www.festo.com](http://www.festo.com)

Manifold block for 3/2-way valves, compact

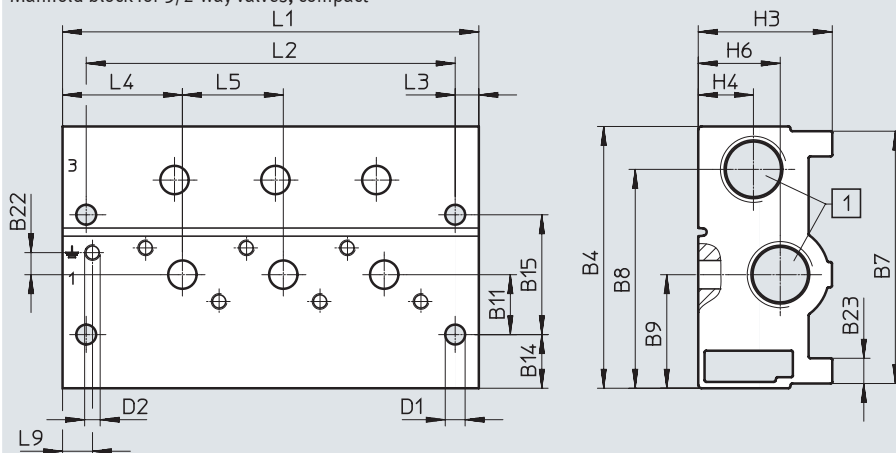

[1] Ports 1 and 3: G1/2

Type	B4	B7	B8	B9	B11	B14	B15	B22	B23
VABM-B10-30S-G12-...-P3	83	80	69.4	36	19	17	38	7	8

Type	D1 ø	D2	H3	H4	H6	L3	L4	L5	L9
VABM-B10-30S-G12-...-P3	6.3	M5x11	42.5	17.5	26	7.5	38	32	12

Valve positions	2	3	4	5	6	7	8	9	10
L1	100	132	164	196	228	260	292	324	356
L2	85	117	149	181	213	245	277	309	341

### Dimensions

Download CAD data → [www.festo.com](http://www.festo.com)

Manifold block for 5/2- and 5/3-way valves, compact

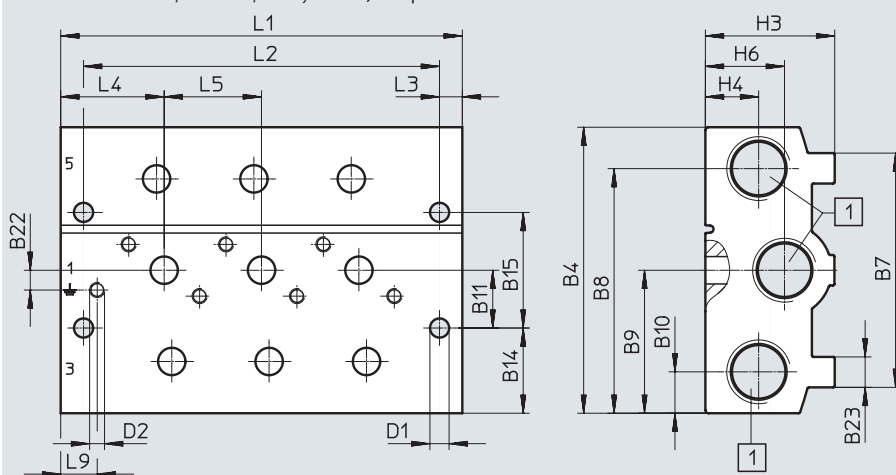

[1] Ports 1, 3 and 5: G1/2

Type	B4	B7	B8	B9	B10	B11	B14	B15	B22	B23
VABM-B10-30S-G12-...	94	77	80.4	47	13.6	19	28	38	6.5	10

Type	D1 ø	D2	H3	H4	H6	L3	L4	L5	L9
VABM-B10-30S-G12-...	6.3	M5x11	42.5	17.5	26	7.5	34	32	12

Valve positions	2	3	4	5	6	7	8	9	10
L1	100	132	164	196	228	260	292	324	356
L2	85	117	149	181	213	245	277	309	341

## Technical data – Manifold block, size 30

## Dimensions

Download CAD data → [www.festo.com](http://www.festo.com)

Common supply manifold, mounting on both sides

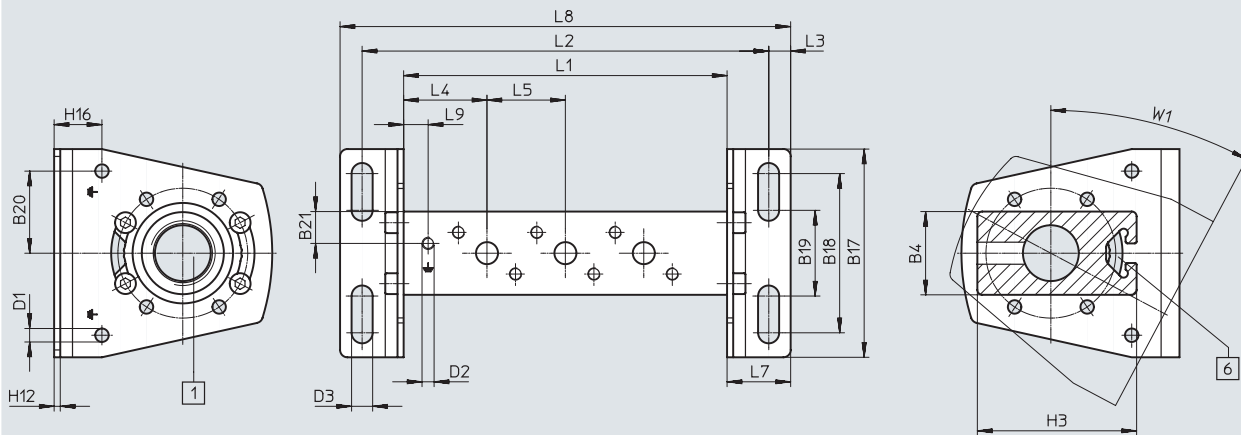

[1] Port 1: G3/4

[6] Profile slot IPM-08 system 8

**Note**

Mounting bracket can be adjusted through  $\pm 30^\circ$ .

Type	B4	B17	B18	B19	B20	B21	D1 $\varnothing$	D2	D3 $\varnothing$
VABM-B10-30-G34-...-P53	34	85	65	35	33.5	13	5.5	M5x11	8.6

Type	H3	H12	H16	L3	L4	L5	L7	L9	W1
VABM-B10-30-G34-...-P53	65	2.5	19.5	9	34	32	26	10	30°

Valve positions	2	3	4	5	6	7	8	9	10
L1	100	132	164	196	228	260	292	324	356
L2	134	166	198	230	262	294	326	358	390
L8	152	184	216	248	280	312	344	376	408

### Technical data – Manifold block, size 30

**Dimensions**

Download CAD data → [www.festo.com](http://www.festo.com)

Common supply manifold, mounting on one side

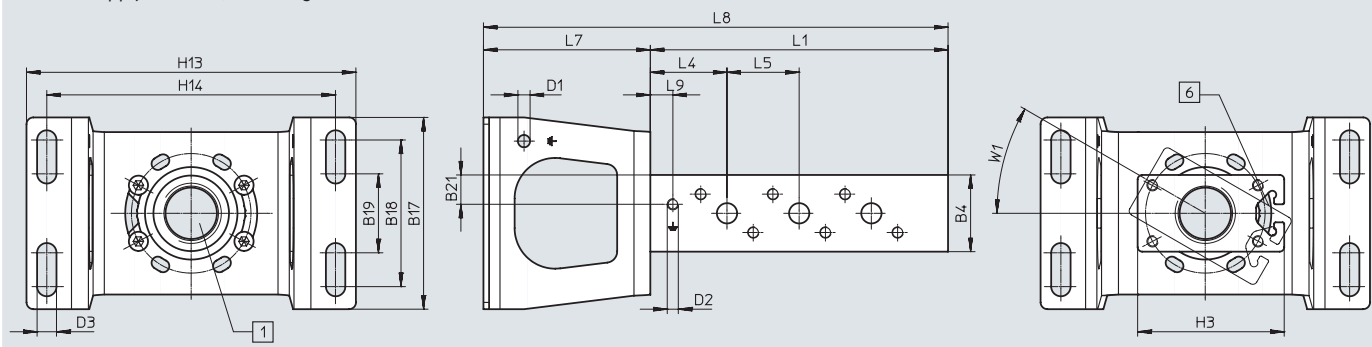

[1] Port 1: G3/4

[6] Profile slot IPM-08 system 8

**Note**  
Mounting bracket can be adjusted through ±30°.







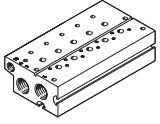

Type	B4	B17	B18	B19	B21	D1 ø	D2	D3ø
VABM-B10-30-G34-...-P53-E	34	85	65	35	13	5.5	M5x11	8.6

Type	H3	H13	H14	L4	L5	L7	L9	W1
VABM-B10-30-G34-...-P53-E	65	146	128	34	32	74	10	30°

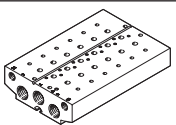
Valve positions	2	3	4
L1	100	132	164
L8	168	200	232

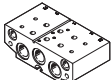
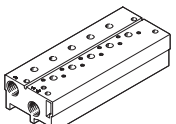

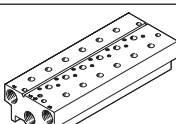
## Ordering data – Manifold block, size 30

Ordering data – Manifold block				
	Description	Valve positions	Part no.	Type
<b>Standard manifold block</b>				
	For 3/2-way valves, including seals and screws for mounting valves  <b>Note</b> • Blanking plugs for sealing the supply ports (1, 3 and 14) on one side are included in the scope of delivery. • Screw set (part number 8026203) to be ordered together with solenoid valves VUVS-LK.	2	8026395	VABM-B10-30E-G34-2-P3
		3	8026396	VABM-B10-30E-G34-3-P3
		4	8026397	VABM-B10-30E-G34-4-P3
		5	8026398	VABM-B10-30E-G34-5-P3
		6	8026399	VABM-B10-30E-G34-6-P3
		7	8026400	VABM-B10-30E-G34-7-P3
		8	8026401	VABM-B10-30E-G34-8-P3
		9	8026402	VABM-B10-30E-G34-9-P3
		10	8026403	VABM-B10-30E-G34-10-P3
			For 5/2-way and 5/3-way valves, including seals and screws for mounting valves  <b>Note</b> • Blanking plugs for sealing the supply ports (1, 3, 5, 12 and 14) on one side are included in the scope of delivery. • Screw set (part number 8026203) to be ordered together with solenoid valves VUVS-LK.	2
3	8026360			VABM-B10-30E-G34-3
4	8026361			VABM-B10-30E-G34-4
5	8026362			VABM-B10-30E-G34-5
6	8026363			VABM-B10-30E-G34-6
7	8026364			VABM-B10-30E-G34-7
8	8026365			VABM-B10-30E-G34-8
9	8026366			VABM-B10-30E-G34-9
10	8026367			VABM-B10-30E-G34-10
<b>Manifold block, extension module for standard manifold block</b>				
	For 3/2-way valves, including seals and screws for mounting valves	2	8026432	VABM-B10-30EEE-G34-2-P3
	For 5/2-way and 5/3-way valves, including seals and screws for mounting valves	2	8026431	VABM-B10-30EEE-G34-2
<b>Compact manifold block</b>				
	For 3/2-way valves, including seals and screws for mounting valves  <b>Note</b> Blanking plugs for sealing the supply ports (1, 3 and 14) on one side are included in the scope of delivery.	2	★ 8026413	VABM-B10-30S-G12-2-P3
		3	8026414	VABM-B10-30S-G12-3-P3
		4	★ 8026415	VABM-B10-30S-G12-4-P3
		5	8026416	VABM-B10-30S-G12-5-P3
		6	★ 8026417	VABM-B10-30S-G12-6-P3
		7	8026418	VABM-B10-30S-G12-7-P3
		8	★ 8026419	VABM-B10-30S-G12-8-P3
		9	8026420	VABM-B10-30S-G12-9-P3
		10	★ 8026421	VABM-B10-30S-G12-10-P3
			For 5/2-way and 5/3-way valves, including seals and screws for mounting valves  <b>Note</b> Blanking plugs for sealing the supply ports (1, 3, 5, 12 and 14) on one side are included in the scope of delivery.	2
3	8026378			VABM-B10-30S-G12-3
4	★ 8026379			VABM-B10-30S-G12-4
5	8026380			VABM-B10-30S-G12-5
6	★ 8026381			VABM-B10-30S-G12-6
7	8026382			VABM-B10-30S-G12-7
8	★ 8026383			VABM-B10-30S-G12-8
9	8026384			VABM-B10-30S-G12-9
10	★ 8026385			VABM-B10-30S-G12-10



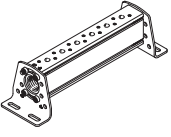
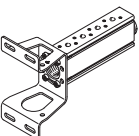

## Ordering data – Manifold block, size 30

Ordering data	Description	Valve positions	Part no.	Type
<b>Common supply manifold</b>				
	For mounting on both sides, including seals and screws for mounting valves	2	★ 8026338	VABM-B10-30-G34-2-P53
		3	8026339	VABM-B10-30-G34-3-P53
		4	★ 8026340	VABM-B10-30-G34-4-P53
		5	8026341	VABM-B10-30-G34-5-P5
		6	★ 8026342	VABM-B10-30-G34-6-P53
		7	8026343	VABM-B10-30-G34-7-P53
		8	★ 8026344	VABM-B10-30-G34-8-P53
		9	8026345	VABM-B10-30-G34-9-P53
		10	★ 8026346	VABM-B10-30-G34-10-P53
			For mounting on one side, including seals and screws for mounting valves	2
3	8026357			VABM-B10-30-G34-3-P53-E
4	8026358			VABM-B10-30-G34-4-P53-E



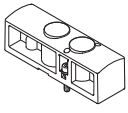
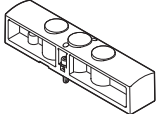

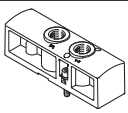
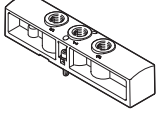
 **Note**

Blanking plug for sealing the supply port (1) on one side included in the scope of delivery.

## Ordering data – Manifold block, size 30





Ordering data	Description	Weight [g]	Part no.	Type
<b>Cover plate</b>				
	For valve position on manifold block for 3/2-way valves	128	★ 8026336	VABB-B10-30-E-P3
	For valve position on manifold block for 5/2-, 5/3-way valves	179	★ 8026335	VABB-B10-30-E
	For valve position on common supply manifold	43	★ 8026334	VABB-B10-30-A
<b>Supply plate</b>				
	For valve position on manifold block for 3/2-way valves	121	8026435	VABF-B10-30-P1A4-G38-P3
	For valve position on manifold block for 5/2-, 5/3-way valves	167	8026434	VABF-B10-30-P1A4-G38
<b>Supply plate</b>				
	For valve position on common supply manifold	40	8026433	VABF-B10-30-P1-G38

## Ordering data – Manifold block, size 30

Ordering data	Description		Part no.	Type	PU <sup>1)</sup>
<b>Push-in fitting with internal hex</b>					
	Connecting thread G1/8 for tubing O.D.	4 mm	★ 186106	QS-G1/8-4-I	10
			133008	QS-G1/8-4-I-100	100
		6 mm	★ 186107	QS-G1/8-6-I	10
			133009	QS-G1/8-6-I-100	100
	Connecting thread G3/8 for tubing O.D.	8 mm	★ 186111	QS-G3/8-8-I	10
		10 mm	★ 186113	QS-G3/8-10-I	10
12 mm		★ 186114	QS-G3/8-12-I	10	
Connecting thread G1/2 for tubing O.D.	12 mm	★ 186115	QS-G1/2-12-I	1	
<b>Push-in fitting with external hex</b>					
	Connecting thread G1/2 for tubing O.D.	16 mm	186105	QS-G1/2-16	1
			132047	QS-G1/2-16-20	20
<b>Angled push-in fitting with external hex</b>					
	Connecting thread G3/8 for tubing O.D.	8 mm	★ 186121	QSL-G3/8-8	10
			132055	QSL-G3/8-8-50	50
		10 mm	★ 186123	QSL-G3/8-10	10
			132056	QSL-G3/8-10-20	20
	Connecting thread G1/2 for tubing O.D.	12 mm	★ 186124	QSL-G3/8-12	10
			132057	QSL-G3/8-12-20	20
		12 mm	★ 186125	QSL-G1/2-12	1
			132058	QSL-G1/2-12-20	20
16 mm	★ 186126	QSL-G1/2-16	1		
	132059	QSL-G1/2-16-20	20		
<b>Angled push-in fitting, long, with external hex</b>					
	Connecting thread G1/2 for tubing O.D.	8 mm	186132	QSL-G3/8-8	10
		10 mm	186134	QSL-G3/8-10	10
		12 mm	186135	QSL-G3/8-12	10
<b>Barbed fitting with external hex</b>					
	Connecting thread G3/4 for tubing I.D. Aluminium design	13 mm	3612	N-3/4-P-13	1
		19 mm	3613	N-3/4-P-19	1
	Connecting thread G3/4 for tubing I.D. Brass design	13 mm	15637	N-3/4-P-13-MS	1
		19 mm	15638	N-3/4-P-19-MS	1

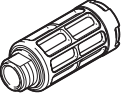
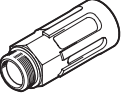
1) Packaging unit

## Ordering data – Manifold block, size 30

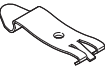
Ordering data	Description	Part no.	Type	PU <sup>1)</sup>
<b>Silencer</b>				
	With connecting thread G, polymer design	G3/8	534224 U-3/8-20	20
	With connecting thread G, metal design	G1/2	6844 U-1/2-B	1
		G3/4	6845 U-3/4-B	1
		G3/8	6843 U-3/8-B	1
	With connecting thread G, sintered design, long	G1/2	★ 1205863 AMTE-M-LH-G12	10
		G3/4	1205864 AMTE-M-LH-G34	10
<b>Blanking plug</b>				
	With connecting thread	G1/8	★ 3568 B-1/8	10
			534213 B-1/8-100	100
		G1/2	★ 3571 B-1/2	10
			534216 B-1/2-20	20
		G3/4	★ 3572 B-3/4	10
<b>Separator</b>				
	For creating pressure zones	G1/8	569995 VABD-8-B	1
		G1/2	8022483 VABD-17.5-B	1
		G3/4	8022484 VABD-22.7-B	1
<b>H-rail mounting</b>				
	For size 30, for mounting on standard H-rails TH 35-7.5 or TH 35-15 to EN 60715	3488412	VAME-T-M6	2

1) Packaging unit

# Festo - Your Partner in Automation



**1 Festo Inc.**  
5300 Explorer Drive  
Mississauga, ON L4W 5G4  
Canada

**Festo Customer Interaction Center**  
Tel: 1 877 463 3786  
Fax: 1 877 393 3786  
Email: [customer.service.ca@festo.com](mailto:customer.service.ca@festo.com)

**2 Festo Pneumatic**  
Av. Ceylán 3,  
Col. Tequesquináhuac  
54020 Tlalneantla,  
Estado de México

**Multinational Contact Center**  
01 800 337 8669  
[ventas.mexico@festo.com](mailto:ventas.mexico@festo.com)

**3 Festo Corporation**  
1377 Motor Parkway  
Suite 310  
Islandia, NY 11749

**Festo Customer Interaction Center**  
1 800 993 3786  
1 800 963 3786  
[customer.service.us@festo.com](mailto:customer.service.us@festo.com)

**4 Regional Service Center**  
7777 Columbia Road  
Mason, OH 45040

Connect with us



[www.festo.com/socialmedia](http://www.festo.com/socialmedia)



[www.festo.com](http://www.festo.com)

Subject to change